



9

ESSENTIAL MATHEMATICS

FOR THE AUSTRALIAN CURRICULUM
FOURTH EDITION

DAVID GREENWOOD
SARA WOOLLEY
JENNY GOODMAN
JENNIFER VAUGHAN
STUART PALMER



CAMBRIDGE
UNIVERSITY PRESS



CAMBRIDGE
UNIVERSITY PRESS

Shaftesbury Road, Cambridge CB2 8EA, United Kingdom

One Liberty Plaza, 20th Floor, New York, NY 10006, USA

477 Williamstown Road, Port Melbourne, VIC 3207, Australia

314–321, 3rd Floor, Plot 3, Splendor Forum, Jasola District Centre, New Delhi – 110025, India

103 Penang Road, #05–06/07, Visioncrest Commercial, Singapore 238467

Cambridge University Press is part of Cambridge University Press & Assessment, a department of the University of Cambridge.

We share the University's mission to contribute to society through the pursuit of education, learning and research at the highest international levels of excellence.

www.cambridge.org

First Edition © David Greenwood, Sara Woolley, Jenny Goodman, Jennifer Vaughan, GT Installations, Georgia Sotiriou and Voula Sotiriou 2011

Second, Third and Forth Edition © David Greenwood, Sara Woolley, Jenny Goodman and Jennifer Vaughan 2015, 2020, 2024

This publication is in copyright. Subject to statutory exception and to the provisions of relevant collective licensing agreements, no reproduction of any part may take place without the written permission of Cambridge University Press & Assessment.

First published 2011

Second Edition 2015

Third Edition 2020

Fourth Edition 2024

20 19 18 17 16 15 14 13 12 11 10 9 8 7 6 5 4 3 2 1

Cover designed by Sardine Design

Typeset by diacriTech

Printed in China by C & C Offset Printing Co. Ltd.

A catalogue record for this book is available from the National Library of Australia at www.nla.gov.au

ISBN 978-1-009-37303-6 Paperback

Additional resources for this publication at www.cambridge.edu.au/GO

Reproduction and Communication for educational purposes

The Australian *Copyright Act 1968* (the Act) allows a maximum of one chapter or 10% of the pages of this publication, whichever is the greater, to be reproduced and/or communicated by any educational institution for its educational purposes provided that the educational institution (or the body that administers it) has given a remuneration notice to Copyright Agency Limited (CAL) under the Act.

For details of the CAL licence for educational institutions contact:

Copyright Agency Limited

Level 12, 66 Goulburn Street

Sydney NSW 2000

Telephone: (02) 9394 7600

Facsimile: (02) 9394 7601

Email: memberservices@copyright.com.au

Reproduction and Communication for other purposes

Except as permitted under the Act (for example a fair dealing for the purposes of study, research, criticism or review) no part of this publication may be reproduced, stored in a retrieval system, communicated or transmitted in any form or by any means without prior written permission. All inquiries should be made to the publisher at the address above.

Cambridge University Press & Assessment has no responsibility for the persistence or accuracy of URLs for external or third-party internet websites referred to in this publication and does not guarantee that any content on such websites is, or will remain, accurate or appropriate. Information regarding prices, travel timetables and other factual information given in this work is correct at the time of first printing but Cambridge University Press & Assessment does not guarantee the accuracy of such information thereafter.

Cambridge University Press & Assessment acknowledges the Aboriginal and Torres Strait Islander peoples of this nation. We acknowledge the traditional custodians of the lands on which our company is located and where we conduct our business. We pay our respects to ancestors and Elders, past and present. Cambridge University Press & Assessment is committed to honouring Aboriginal and Torres Strait Islander peoples' unique cultural and spiritual relationships to the land, waters and seas and their rich contribution to society.

Contents

<i>About the authors</i>	x
<i>Introduction</i>	xi
<i>Guide to the working programs in exercises</i>	xii
<i>Guide to this resource</i>	xiii
<i>Acknowledgements</i>	xvii
<i>Working with unfamiliar problems: Part 1</i>	xviii
<i>Working with unfamiliar problems: Part 2</i>	xx

1 Reviewing number and financial mathematics 2

Strand: Algebra

1A Integer operations CONSOLIDATING	4
1B Decimal places and significant figures	9
1C Rational numbers CONSOLIDATING	14
1D Operations with fractions CONSOLIDATING	20
1E Ratios, rates and best buys CONSOLIDATING	26
1F Percentages and money CONSOLIDATING	32
1G Percentage increase and decrease CONSOLIDATING	37
Progress quiz	42
1H Profits and discounts	43
1I Income	48
1J The PAYG income tax system	56
Applications and problem-solving	63
1K Simple interest	65
1L Compound interest and depreciation EXTENDING	70
1M Using a formula for compound interest and depreciation EXTENDING	75
Modelling	81
Technology and computational thinking	82
Investigation	84
Problems and challenges	85
Chapter checklist with success criteria	87
Chapter review	90

2 Expressions and linear equations 94

Strand: Algebra

2A Algebraic expressions CONSOLIDATING	96
2B Simplifying algebraic expressions CONSOLIDATING	102
2C Expanding algebraic expressions	107
2D Solving linear equations with pronumerals on one side	112
2E Solving equations with brackets and pronumerals on both sides	117
2F Solving word problems	121

	Progress quiz	126
2G	Solving linear inequalities	127
2H	Using formulas	132
2I	Simultaneous equations using substitution EXTENDING	138
	Applications and problem-solving	143
2J	Simultaneous equations using elimination EXTENDING	145
2K	Applications of simultaneous equations EXTENDING	151
	Modelling	156
	Technology and computational thinking	157
	Investigation	159
	Problems and challenges	160
	Chapter checklist with success criteria	162
	Chapter review	164

3 Pythagoras' theorem and trigonometry 168

3A	Pythagoras' theorem	170
3B	Finding the length of the shorter sides	177
3C	Using Pythagoras' theorem to solve two-dimensional problems	182
3D	Using Pythagoras' theorem to solve three-dimensional problems EXTENDING	187
3E	Trigonometric ratios	192
3F	Finding unknown side lengths	199
	Progress quiz	205
3G	Solving for the denominator	206
3H	Finding unknown angles	211
	Applications and problem-solving	216
3I	Applying trigonometry EXTENDING	218
3J	Bearings EXTENDING	225
	Modelling	232
	Technology and computational thinking	233
	Investigation	235
	Problems and challenges	236
	Chapter checklist with success criteria	238
	Chapter review	240

4 Linear relationships 244

4A	Introduction to linear relationships CONSOLIDATING	246
4B	Graphing straight lines using intercepts	253
4C	Lines with one intercept	257
4D	Gradient	264
4E	Gradient and direct proportion	272
4F	Gradient–intercept form	277

Strand: Measurement Algebra

Strand: Algebra

	Progress quiz	283
4G	Finding the equation of a line	285
4H	Midpoint and length of a line segment	290
4I	Parallel and perpendicular lines EXTENDING	295
	Applications and problem-solving	299
4J	Linear modelling	301
4K	Graphical solutions to simultaneous equations	306
	Modelling	312
	Technology and computational thinking	313
	Investigation	315
	Problems and challenges	317
	Chapter checklist with success criteria	319
	Chapter review	321

5 Measurement 326

5A	Errors and accuracy in measurement	328
5B	Length and perimeter CONSOLIDATING	334
5C	Circle circumference and perimeter of a sector	341
5D	Area	347
5E	Perimeter and area of composite shapes	356
	Progress quiz	363
5F	Surface area of prisms and pyramids	364
5G	Surface area of cylinders	370
	Applications and problem-solving	375
5H	Volume of prisms	377
5I	Volume of cylinders	384
	Modelling	389
	Technology and computational thinking	390
	Investigation	392
	Problems and challenges	393
	Chapter checklist with success criteria	395
	Chapter review	398

Semester review 1 402

6 Indices and surds 410

6A	Index notation CONSOLIDATING	412
6B	Index laws for multiplication and division	418
6C	Index laws for power of a power and the zero index	424
6D	Index laws for brackets and fractions	429
6E	Negative indices	434

Strand: Measurement Number

Strand: Algebra

	Progress quiz	439
6F	Scientific notation	440
6G	Scientific notation using significant figures	445
	Applications and problem-solving	450
6H	Fractional indices and surds EXTENDING	452
6I	Simple operations with surds EXTENDING	458
	Modelling	462
	Technology and computational thinking	463
	Investigation	465
	Problems and challenges	466
	Chapter checklist with success criteria	468
	Chapter review	470

7 Geometry 474

Strand: Space

7A	Angles and triangles CONSOLIDATING	476
7B	Parallel lines CONSOLIDATING	484
7C	Quadrilaterals and other polygons	492
7D	Congruent triangles	499
7E	Using congruence in proof EXTENDING	507
	Progress quiz	512
7F	Enlargement and similar figures	514
	Applications and problem-solving	522
7G	Similar triangles	524
7H	Proving and applying similar triangles	532
	Modelling	538
	Technology and computational thinking	539
	Investigation	541
	Problems and challenges	542
	Chapter checklist with success criteria	544
	Chapter review	547

8 Algebraic techniques 552

Strand: Algebra

8A	Expanding binomial products	554
8B	Perfect squares and difference of two squares	558
8C	Factorising algebraic expressions	564
8D	Factorising the difference of two squares	569
8E	Factorising by grouping in pairs	573
8F	Factorising monic quadratic trinomials	577
	Progress quiz	581
8G	Factorising trinomials of the form $ax^2 + bx + c$ EXTENDING	582
8H	Simplifying algebraic fractions: Multiplication and division	587

8I	Simplifying algebraic fractions: Addition and subtraction	592
	Applications and problem-solving	597
8J	Further simplification of algebraic fractions EXTENDING	599
8K	Equations with algebraic fractions EXTENDING	604
	Modelling	610
	Technology and computational thinking	611
	Investigation	613
	Problems and challenges	614
	Chapter checklist with success criteria	616
	Chapter review	617

9 Probability and statistics **620**

Strand: Statistics

9A	Review of probability CONSOLIDATING	622
9B	Venn diagrams and two-way tables	629
9C	Using set notation	636
9D	Using arrays for two-step experiments	642
9E	Using tree diagrams	648
9F	Using relative frequencies to estimate probabilities	654
	Progress quiz	659
9G	Data and sampling	660
9H	Mean, median and mode	666
9I	Stem-and-leaf plots	672
	Applications and problem-solving	679
9J	Grouping data into classes	682
9K	Measures of spread: range and interquartile range	689
9L	Box plots EXTENDING	695
	Modelling	702
	Technology and computational thinking	703
	Investigation	705
	Problems and challenges	706
	Chapter checklist with success criteria	708
	Chapter review	711

10 Introduction to quadratic equations and graphs **716**

Strand: Algebra

10A	Quadratic equations	718
10B	Solving $ax^2 + bx = 0$ and $x^2 = d$	723
10C	Solving $x^2 + bx + c = 0$	727
10D	Using quadratic equations to solve problems	731
	Progress quiz	735

10E	The parabola	736
10F	Sketching $y = ax^2$ with dilations and reflections	746
	Applications and problem-solving	754
10G	Sketching translations of $y = x^2$	757
10H	Sketching parabolas using intercept form	766
	Modelling	774
	Technology and computational thinking	775
	Investigation	777
	Problems and challenges	778
	Chapter checklist with success criteria	780
	Chapter review	782

11 Algorithmic thinking (online only) **892**

	Introduction	894
	Activity 1: Algorithms for number patterns and financial maths	895
	Activity 2: Minimising and maximising	899
	Activity 3: Sorting, simulations and sampling	901

Semester review 2 **786**

	<i>Index</i>	794
	<i>Answers</i>	797

About the authors



David Greenwood is the Head of Mathematics at Trinity Grammar School in Melbourne and has 30+ years' teaching mathematics from Years 7 to 12. He is the lead author for the Cambridge Essential series and has authored more than 80+ titles for the Australian Curriculum and for the syllabuses of other states. He specialises in analysing curriculum and the sequencing of course content for school mathematics courses. He also has an interest in the use of technology for the teaching of mathematics.



Sara Woolley was born and educated in Tasmania. She completed an Honours degree in Mathematics at the University of Tasmania before completing her education training at the University of Melbourne. She has taught mathematics from Years 7 to 12 since 2006 and is currently a Head of Mathematics. She specialises in lesson design and creating resources that develop and build understanding of mathematics for all students.



Jenny Goodman has taught in schools for over 28 years and is currently teaching at a selective high school in Sydney. Jenny has an interest in the importance of literacy in mathematics education, and in teaching students of differing ability levels. She was awarded the Jones Medal for education at Sydney University and the Bourke Prize for Mathematics. She has written for *CambridgeMATHS NSW* and was involved in the *Spectrum* and *Spectrum Gold* series.



Jennifer Vaughan has taught secondary mathematics for over 30 years in New South Wales, Western Australia, Queensland and New Zealand, and has tutored and lectured in mathematics at Queensland University of Technology. She is passionate about providing students of all ability levels with opportunities to understand and to have success in using mathematics. She has had extensive experience in developing resources that make mathematical concepts more accessible; hence, facilitating student confidence, achievement and an enjoyment of maths.



Stuart Palmer was born and educated in NSW. He is a fully qualified high school mathematics teacher with more than 25 years' experience teaching students from all walks of life in a variety of schools. He has been Head of Mathematics in two schools. He is very well known by teachers throughout the state for the professional learning workshops he delivers. Stuart also assists thousands of Year 12 students every year as they prepare for their HSC Examinations. At the University of Sydney, Stuart spent more than a decade running tutorials for pre-service mathematics teachers.

Introduction

The fourth edition of *Essential Mathematics for the Australian Curriculum* has been significantly revised and updated to suit the teaching and learning of Version 9.0 of the Australian Curriculum. Many of the established features of the series have been retained, but there have been some substantial revisions, improvements and new elements introduced for this edition across the print, digital and teacher resources.

New content and some restructuring

New topics have come in at all year levels. In **Year 7** there are new lessons on ratios, volume of triangular prisms, and measurement of circles, and all geometry topics are now contained in a single chapter (Chapter 4). In **Year 8**, there are new lessons on 3D-coordinates and techniques for collecting data. For **Year 9**, error in measurement is new in Chapter 5, and sampling and proportion is introduced in Chapter 9.

There are many changes in **Year 10**, including the inclusion of clearly marked ‘Optional’ content rather than 10A content, as it was previously. Among other changes, four lessons each on networks and combinatorics have been added, and there are new lessons on logarithmic scales, rates of change, two-way tables and cumulative frequency curves and percentiles. Although topics on polynomials, transformations of graphs, and graphs of circles and hyperbolas do not appear in Version 9.0, these are covered in an online-only Chapter 10, given the expected utility for students wanting to study a calculus-based course in Year 11 and 12. Some other 10A material from the previous curriculum that is not listed as part of Version 9.0 is also retained and labelled as Extension. For example: Measurement for cones, pyramids and spheres, and aspects of advanced Trigonometry.

Version 9.0 places increased emphasis on **investigations** and **modelling**, and this is covered with revised Investigations and Modelling activities at the end of chapters. There are also many new elaborations covering **First Nations Peoples’ perspectives** on mathematics, ranging across all six content strands of the curriculum. These are covered in a suite of specialised investigations provided in the Online Teaching Suite.

Other new features

- **Technology and computational thinking** activities have been added to the end of every chapter to address the curriculum’s increased focus on the use of technology and the understanding and application of algorithms.
- **Targeted Skillsheets** – downloadable and printable – have been written for every lesson in the series, with the intention of providing additional practice for students who need support at the basic skills covered in the lesson, with questions linked to worked examples in the book.
- **Editable PowerPoint lesson summaries** are also provided for each lesson in the series, with the intention of saving the time of teachers who were previously creating these themselves.

Diagnostic Assessment tool

Also new for this edition is a flexible, comprehensive Diagnostic Assessment tool, available through the Online Teaching Suite. This tool, featuring around 10,000 new questions, allows teachers to set diagnostic tests that are closely aligned with the textbook content, view student performance and growth via a range of reports, set follow-up work with a view to helping students improve, and export data as needed.

Guide to the working programs in exercises

The suggested working programs in the exercises in this book provide three pathways to allow differentiation for Foundation, Standard and Advanced students (schools will likely have their own names for these levels).

Each exercise is structured in subsections that match the mathematical proficiencies of Fluency, Problem-solving and Reasoning, as well as Enrichment (Challenge). (Note that Understanding is covered by ‘Building understanding’ in each lesson.) In the exercises, the questions suggested for each pathway are listed in three columns at the top of each subsection:

- The left column (lightest shaded colour) is the Foundation pathway
- The middle column (medium shaded colour) is the Standard pathway
- The right column (darkest shaded colour) is the Advanced pathway.

Gradients within exercises and proficiency strands

The working programs make use of the two difficulty gradients contained within exercises. A gradient runs through the overall structure of each exercise – where there is an increasing level of mathematical sophistication required from Fluency to Problem-solving to Reasoning and Enrichment – but also within each proficiency; the first few questions in Fluency, for example, are easier than the last Fluency question.

The right mix of questions

Questions in the working programs are selected to give the most appropriate mix of *types* of questions for each learning pathway. Students going through the Foundation pathway should use the left tab, which includes all but the hardest Fluency questions as well as the easiest Problem-solving and Reasoning questions. An Advanced student can use the right tab, proceed through the Fluency questions (often half of each question), and have their main focus be on the Problem-solving and Reasoning questions, as well as the Enrichment questions. A Standard student would do a mix of everything using the middle tab.

Choosing a pathway

There are a variety of ways to determine the appropriate pathway for students through the course. Schools and individual teachers should follow the method that works for them. If required, the prior-knowledge pre-tests (now found online) can be used as a tool for helping students select a pathway. The following are recommended guidelines:

- A student who gets 40% or lower should complete the Foundation questions
- A student who gets between 40% and below 85% should complete the Standard questions
- A student who gets 85% or higher should complete the Advanced questions.

Foundation	Standard	Advanced
FLUENCY		
1, 2–4(½)	2–5(½)	2–5(½)
PROBLEM-SOLVING		
6, 7	6–8	7–9
REASONING		
10	10–12	12–14
ENRICHMENT		
–	–	15

The working program for Exercise 3A in Year 7. The questions recommended for a Foundation student are: 1, 2, 3(½), 4, 6 and 9.

* The nomenclature used to list questions is as follows:

- 3, 4: complete all parts of questions 3 and 4
- 1–4: complete all parts of questions 1, 2, 3 and 4
- 10(½): complete half of the parts from question 10 (a, c, e, ... or b, d, f, ...)
- 2–4(½): complete half of the parts of questions 2, 3 and 4
- 4(½), 5: complete half of the parts of question 4 and all parts of question 5
- —: do not complete any of the questions in this section.

Guide to this resource

PRINT TEXTBOOK FEATURES

- 1 **NEW New lessons:** authoritative coverage of new topics in the Australian Curriculum 9.0 in the form of new, road-tested lessons throughout each book.
- 2 **Australian Curriculum 9.0:** content strands and content descriptions are listed at the beginning of the chapter (see the teaching program for more detailed curriculum documents)
- 3 **In this chapter:** an overview of the chapter contents
- 4 **Working with unfamiliar problems:** a set of problem-solving questions not tied to a specific topic
- 5 **Chapter introduction:** sets context for students about how the topic connects with the real world and the history of mathematics
- 6 **Learning intentions:** sets out what a student will be expected to learn in the lesson
- 7 **Lesson starter:** an activity, which can often be done in groups, to start the lesson
- 8 **Key ideas:** summarises the knowledge and skills for the lesson
- 9 **Building understanding:** a small set of discussion questions to consolidate understanding of the Key ideas (replaces Understanding questions formerly inside the exercises)
- 10 **Worked examples:** solutions and explanations of each line of working, along with a description that clearly describes the mathematics covered by the example

170 Chapter 2 Geometry and networks
2K Introduction to networks 171

2K Introduction to networks

LEARNING INTENTIONS

- To know what is meant by a network graph
- To know the key features of a network graph
- To be able to find the degree of a vertex and the sum of degrees for a graph
- To be able to describe simple walks through a network using the vertex labels

A network is a collection of points (vertices or nodes) which can be connected by lines (edges). Networks are used to help solve a range of real-world problems including travel and distance problems, intelligence and crime problems, computer network problems and even metabolic network problems associated with the human body. In Mathematics, a network diagram can be referred to as a graph, not to be confused with the graph of a function like $y = x^2 + 3$.

Lesson starter: The Königsberg bridge problem

The seven bridges of Königsberg is a well-known historical problem solved by Leonhard Euler who laid the foundations of graph theory. It involves two islands at the centre of an old German city connected by seven bridges over a river as shown in these diagrams.



The problem states: Is it possible to start at one point and pass over every bridge exactly once and return to your starting point?

- Make a copy of this simplified map of the seven bridges of Königsberg and try tracing out a walk that crosses all bridges exactly once. Try starting at different places.

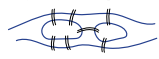

- Investigate if there might be a solution to this problem if one of the bridges is removed.
- Investigate if there might be a solution to this problem if one bridge is added.

KEY IDEAS

- A **network** or **graph** is a diagram connecting points using lines.
 - The points are called **vertices** (or **nodes**). Vertices singular, vertices is plural.
 - The lines are called **edges**.
- The **degree** of a vertex is the number of edges connected to it.
 - A vertex is odd if the number of edges connected to it is odd.
 - A vertex is even if the number of edges connected to it is even.
- The sum of degrees is calculated by adding up the degrees of all the vertices in a graph.
 - It is also equal to twice the number of edges.
- A **walk** is any type of route through a network.
 - A walk can be defined using the vertex labels.
 - Example: $A-B-C-A-D$.

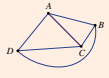

BUILDING UNDERSTANDING

1 Here is a graph representing roads connecting three towns A , B and C .

- a How many different roads (edges) does this graph have?
- b How many different vertices (nodes) does this graph have?
- c If no road (edge) is used more than once and no town (vertex/node) is visited more than once, how many different walks are there if travelling from:
 - i A to C ?
 - ii A to B ?
 - iii B to C ?
- d How many roads connect to:
 - i town A ?
 - ii town B ?
 - iii town C ?

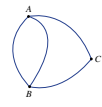

2 This graph uses four edges to connect four vertices.

- a How many edges connect to vertex A ?
- b What is the degree of vertex A ?
- c State the total number of edges on the graph.
- d By finding the number of edges connected to each vertex, find the sum of degrees for the graph.
- e What do you notice about the total number of edges and the sum of degrees for this graph?



- 11 **Now you try:** try-it-yourself questions provided after every worked example in exactly the same style as the worked example to give immediate practice
- 12 **Gentle start to exercises:** the exercise begins at Fluency, with the first question always linked to the first worked example in the lesson
- 13 **Working programs:** differentiated question sets for three ability levels in exercises
- 14 **Example references:** show where a question links to a relevant worked example – the first question is always linked to the first worked example in a lesson
- 15 **Problems and challenges:** in each chapter provides practice with solving problems connected with the topic
- 16 **Chapter checklist with success criteria:** a checklist of the learning intentions for the chapter, with example questions
- 17 **Applications and problem-solving:** a set of three extended-response questions across two pages that give practice at applying the mathematics of the chapter to real-life contexts
- 18 **NEW Technology and computational thinking activity** in each chapter addresses the curriculum's increased focus on the use of different forms of technology, and the understanding and implementation of algorithms
- 19 **Modelling activities:** an activity in each chapter gives students the opportunity to learn and apply the mathematical modelling process to solve realistic problems

10

11

12

14

13

16

18

19

- 20 Chapter reviews:** with short-answer, multiple-choice and extended-response questions; questions that are extension are clearly signposted
- 21 Solving unfamiliar problems poster:** at the back of the book, outlines a strategy for solving any unfamiliar problem

INTERACTIVE TEXTBOOK FEATURES

- 22 NEW Targeted Skillsheets,** one for each lesson, focus on a small set of related Fluency-style skills for students who need extra support, with questions linked to worked examples
- 23 Workspaces:** almost every textbook question – including all working-out – can be completed inside the Interactive Textbook by using either a stylus, a keyboard and symbol palette, or uploading an image of the work
- 24 Self-assessment:** students can then self-assess their own work and send alerts to the teacher. See the Introduction on page x for more information.
- 25 Interactive working programs** can be clicked on so that only questions included in that working program are shown on the screen
- 26 HOTmaths resources:** a huge catered library of widgets, HOTSheets and walkthroughs seamlessly blended with the digital textbook
- 27** A revised set of **differentiated auto-marked practice quizzes** per lesson with saved scores
- 28 Scorcher:** the popular competitive game
- 29 Worked example videos:** every worked example is linked to a high-quality video demonstration, supporting both in-class learning and the flipped classroom
- 30 Desmos graphing calculator,** scientific calculator and geometry tool are always available to open within every lesson

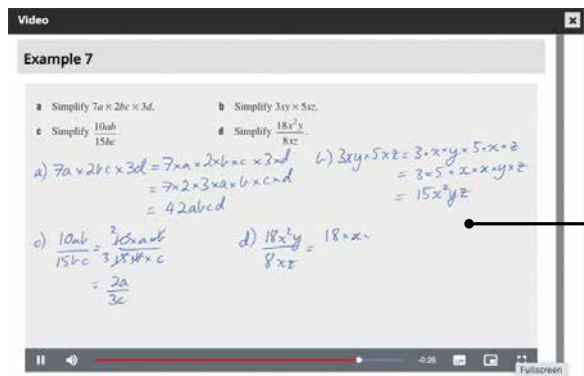
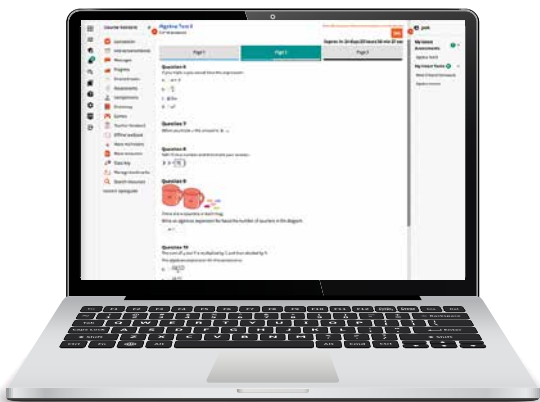
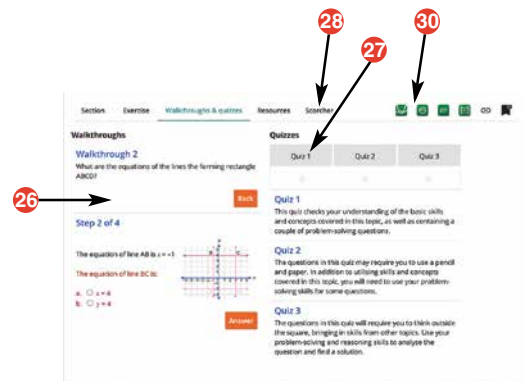

- 31 Desmos interactives:** a set of Desmos activities written by the authors allow students to explore a key mathematical concept by using the Desmos graphing calculator or geometry tool
- 32 Auto-marked prior knowledge pre-test** for testing the knowledge that students will need before starting the chapter
- 33 Auto-marked progress quizzes and chapter review multiple-choice questions** in the chapter reviews can now be completed online

DOWNLOADABLE PDF TEXTBOOK

- 34** In addition to the Interactive Textbook, a **PDF version of the textbook** has been retained for times when users cannot go online. PDF search and commenting tools are enabled.

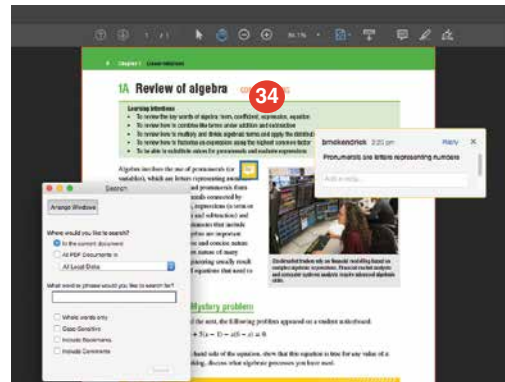

ONLINE TEACHING SUITE

- 35 NEW Diagnostic Assessment Tool** included with the Online Teaching Suite allows for flexible diagnostic testing, reporting and recommendations for follow-up work to assist you to help your students to improve
- 36 NEW PowerPoint lesson** summaries contain the main elements of each lesson in a form that can be annotated and projected in front of class
- 37 Learning Management System** with class and student analytics, including reports and communication tools
- 38 Teacher view of student's work and self-assessment** allows the teacher to see their class's workout, how students in the class assessed their own work, and any 'red flags' that the class has submitted to the teacher
- 39 Powerful test generator** with a huge bank of levelled questions as well as ready-made tests
- 40 Revamped task manager** allows teachers to incorporate many of the activities and tools listed above into teacher-controlled learning pathways that can be built for individual students, groups of students and whole classes
- 41 Worksheets and four differentiated chapter tests in every chapter,** provided in editable Word documents
- 42 More printable resources:** all Pre-tests, Progress quizzes and Applications and problem-solving tasks are provided in printable worksheet versions

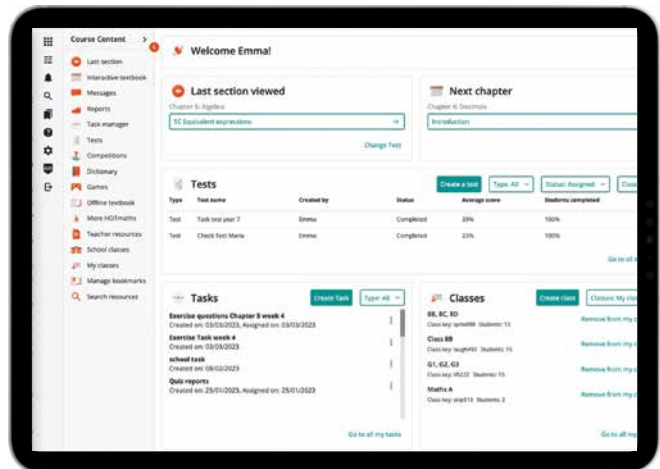

Acknowledgements

The author and publisher wish to thank the following sources for permission to reproduce material:

Cover: © Getty Images / Mykola Lishchyslyn

Images: © Getty Images / badahos, Chapter 1 Opener / James Marshall, p. 4 / Clerkenwell, p.12 / Maartje van Caspel, p.14 / Pablo Perdomo, p.18 / mixetto, p.20 / GarysFRP, p.26 / Rodica Cojocar / 500px, p.30 / LauriPatterson, p.31 / unique pic, p.32 / matejmo, p.37 / David Malan, p.41 / Carlos Hernandez, p.43 / vgajic, p.48 / Klaus Vedfelt, p.50 / Cavan Images, p.54(1) / The Good Brigade, p.54(2) / d3sign, p.56 / coldsnowstorm, p.60 / Laura Reid, p.61 / Photo_Concepts, p.65 / Tetra Images, p.68 / sbostock, p.70 / Scott E Barbour, p.73 / Maskot, p.75 / Prapass Pulsub, p.82 / Cris Cantón, p.91 / Nick David, p.93 / studio-fi, Chapter 2 Opener / Peter Cade, p.96 / Andy Sacks, p.102 / Paolo Santini / EyeEm, p.106 / AlexStepanov, p.107 / Peter Dazeley, p.108 / pamspix, p.111 / Maskot, p.112 / Sally Ancombe, p.116 / Dimitri Otis, p.117 / dalton00, p.120 / Nicola Forenza, p.121 / SolStock, p.123 / John W Banagan, p.124 / Creative Crop, p.125(1) / KEHAN CHEN, p.125(2) / George Pachantouris, p.127 / EmirMemedovski, p.131 / vgajic, p.132 / Caia Image, p.137 / Danita Delimont, p.138 / fotog, p.141 / ONOKY - Fabrice LEROUGE, p.143 / Westend61, p.144 / uschools, p.145 / John Kirk, p.151 / Peter Dazeley, p.154 / Klaus Vedfelt, p.155 / Enrique Díaz / 7cero, p.158 / SheLah / 500px, p.164 / Jenny Dettrick, p.166 / RyanLane, p.167 / sarawuth702, Chapter 3 Opener / Peter M. Fisher, p.170 / Fred-D, p.177 / Robin Smith, p.182 / Keven Osborne/Fox Fotos, p.187 / xavierarnau, p.192 / Image Source, p.197 / Franz Marc Frei, p.199 / Stocktrek Images, p.211 / Tomas Rodriguez, p.215 / Opla, p.218 / Martin Deja, p.231 / Peter Cade, p.242 / Eugene Gologursky / Stringer, Chapter 4 Opener / jhorrocks, p.246 / Stígur Már Karlsson/Heimsmýndir, p.253 / CactuSoup, p.257 / vernonwiley, p.268 / Issarawat Tattong, p.270 / sezer66, p.272 / Sally Ancombe, p.273 / Viaframe, p.275 / Suneet Bhardwaj, p.276(1) / Catalin Daniel Ciolca, p.282 / ez_thug, p.285 / gerenme, p.290 / Phynart Studio, p.303 / Tom Merton, p.304(1) / Image Source, p.304(2) / Monty Rakusen, p.305 / Guerilla, p.306 / Katrina Wittkamp, p.317 / Alistair Berg, p.325 / Alfio Manciangli, Chapter 5 Opener / Irina Marwan, p.331 / Group4 Studio, p.332 / dageldog, p.332 / Reimphoto, p.334 / A_Lein, p.339 / Alexander Spatari, p.346 / Westend61, p.354 / Monty Rakusen, p.361 / John B. Mueller Photography, p.368 / kickstand, p.372 / LUVLIMAGE, p.382 / Jodie Griggs, p.383 / Glowimages, p.384 / LisaInGlasses, p.387 / d3sign, p.391 / Faba-Photography, p.393 / Contributor, p.401 / geckophotos, Chapter 6 Opener / FatCamera, p.412 / Rodolfo Parulan Jr., p.417 / Ariel Skelley, p.418 / Fiona McAllister Photography, p.428 / PhotoAlto/Eric Audras, p.433 / Slavica, p.434 / KTSDESIGN/SCIENCE PHOTO LIBRARY, p.440 / Layne Kennedy, p.445 / Kontrec, p.453 / Kerrick, p.463 / ANDRZEJ WOJCICKI, p.465 / vichie81, Chapter 7 Opener / View Pictures / Contributor, p.476 / Tsuji, p.482 / ClarkandCompany, p.484(1) / malerapaso, p.484(2) / Nopasorn Kowathanakul, p.499 / Jorg Greuel, p.506 / Clerkenwell, p.507 / Jaroslav Frank, p.514 / kevin yulianto, p.523 / Kittu Boonitrod, p.524 / Fraser Hall, p.532 / De Agostini Picture Library, p.537 / ShutterWorx, p.539 / Robbie Goodall, p.551 / Konstik, Chapter 8 Opener / EThamPhoto, p.554 / Nordroden, p.558 / ake1150sb, p.563 / Cultura RM Exclusive/Matelly, p.564 / Monty Rakusen, p.569 / serts, p.573 / Andrey Suslov, p.577 / baranozdemir, p.582(1) / fStop Images - Caspar Benson, p.586 / Stefan Mokrzecki, p.592 / John Davis/Stocktrek Images, p.596 / Eric Audras, p.599 / Glowimages, p.604 / Alan Tunnicliffe Photography, p.610 / Gary John Norman, p.619 / Koji Aoki, Chapter 9 Opener / Maurizio Borsari / Aflo, p.622 / fotog, p.627 / RgStudio, p.631 / Flashpop, p.640 / Ascent/PKS Media Inc., p.654 / Ragnar Schmuck, p.657 / Jenny Dettrick, p.658 / Yuichiro Chino, p.660 / Patryk_Kosmider, p.672 / Michael Dodge / Stringer, p.676 / Voiculescu Alin / 500px, p.694 / Yuichiro Chino, p.695 / Jose A. Bernat Bacete, p.699 / Hill Street Studios, p.703 / All copyrights belong to Jingying Zhao, p.715 / Ben Welsh, Chapter 10 Opener / Pete Saloutos, p.718 / C. Fredrickson Photography, p.723 / sturti, p.727 / birhanuguz / 500px, p.730 / Peter M. Fisher, p.731 / Anjelika Gretskaia, p.735 / MarcelC, p.736 / Pgam, p.739 / Vito Palmisano, p.746 / Mint Images, p.756 / mikulas1, p.766 / kevinjeon00, p.771 / Monica Bertolazzi, p.776 / Anton Petrus, p.785; Russell Hart / Alamy Stock Photo, p.295; CC BY_SA 4.0 / Bjoertvedt, p.356.

Every effort has been made to trace and acknowledge copyright. The publisher apologises for any accidental infringement and welcomes information that would redress this situation.

© Australian Curriculum, Assessment and Reporting Authority (ACARA) 2009 to present, unless otherwise indicated. This material was accessed from the ACARA website (www.acara.edu.au). The material is licensed under CC BY 4.0 (<https://creativecommons.org/licenses/by/4.0/>). ACARA does not endorse any product that uses ACARA material or make any representations as to the quality of such products. Any product that uses material published on this website should not be taken to be affiliated with ACARA or have the sponsorship or approval of ACARA. It is up to each person to make their own assessment of the product.

Working with unfamiliar problems: Part 1

The questions on the next four pages are designed to provide practice in solving unfamiliar problems. Use the ‘Working with unfamiliar problems’ poster at the back of this book to help you if you get stuck.

In Part 1, apply the suggested strategy to solve these problems, which are in no particular order. Clearly communicate your solution and final answer.

For Questions 1 and 2, start by working with smaller numbers and look for a pattern.



For Questions 3 and 4, try making a list or table.



For Question 7, use rounding to estimate the answer.



For Questions 5 and 6, try drawing diagrams to help you visualise the problem.



- Determine the exact answer for the following calculations:
 - $999\,999\,999^2$
 - $10^{2x} - 10^x + 1$ when $x = 10$
- In a school of 999 students all the lockers are closed but unlocked. The first student opens all the lockers, then each next student changes the ‘state’ (i.e. open to shut or shut to open) of some lockers: student 2 changes every second locker; student 3 changes every third locker, etc. Imagine that this continues until all the 999 students have had a turn with the 999 lockers. At the end, how many lockers are open and which locker numbers are they?
- What is the smallest number that, when divided by 11, has a remainder of 6 and when divided by 6 has a remainder of 1?
- When 9 is added to certain two-digit numbers the digits are reversed; that is, $AB + 9 = BA$. Find all the two-digit numbers for which this is true.
- A new east–west highway is 12 km north of Adina and 39 km north of Birubi. Town residents want the shortest possible road that will connect both towns to the same highway entry point. The east–west distance between the towns is 68 km. Determine the total length of the new road and the length and true bearing from each town along the new road to the highway. Round all answers to two decimal places.
- A rectangle has coordinates $(0, 0)$, $(0, 4)$, $(6, 4)$ and $(6, 0)$. If a point (x, y) is randomly chosen in this rectangle, determine the probability that $y \geq x$.
- Future travel to Mars could be with rockets powered by nuclear fusion. Estimate how many days a one way Earth–Mars trip would take if a fusion-powered rocket travels at 321 800 km/h and the journey distance is 563 800 000 km.

- 8 Estimate the average time that a Year 9 student takes to walk between classes at your school.
- 9 A plane flight between two cities takes t hours. If the plane increases its speed by 25%, by what percentage will the flight time decrease?
- 10 Find the value of x in this diagram. The diagram is not necessarily to scale.

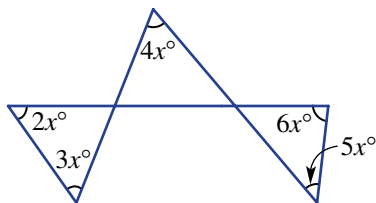

For Questions 9–13, try using algebra as a tool to work out the unknowns.



For Question 8, try estimating by taking a sample.

- 11 Three numbers have a median of 14 and a mean that is 9 more than the smallest number and 11 less than the largest number. Find the sum of the three numbers.
- 12 An even integer is tripled and added to double the next consecutive even integer. If the result is 364, determine the value of the first even integer.
- 13 A school has two rooms that are square. The larger room has sides 5 m longer than the sides of the smaller room. If the total floor area of these rooms is 157 m^2 , find the side length of each room.
- 14 a A diagonal line is ruled on a rectangular sheet of paper. In your own words, describe the three-dimensional object that this line forms when the sheet of paper is rolled up to make a cylinder.
 b Calculate the length of handrail required for a spiral staircase with steps of length 80 cm attached to a central pole of radius 10 cm and height 2.5 m. Round to two decimal places.
 c An amusement park has a spiral track for a section of the rollercoaster ride. The track has 2 revolutions and is designed around a virtual cylinder with diameter 12 m and height 8 m. Find the length of this spiral track correct to two decimal places.
- 15 If 27 dots are used to form a cube, with 9 dots on each of its faces and one dot in the middle of the cube, how many lines containing exactly three dots can be drawn?
- 16 Given that $a^{2q} = 5$, find the value of $2a^{6q} + 4$.



For Questions 14 and 15, try using concrete, everyday materials to help you understand the problem.

- 17 What is the value of $\frac{x - \frac{1}{y}}{y - \frac{1}{x}}$?



For Questions 16 and 17, try using a mathematical procedure to find a shortcut to the answer.

Working with unfamiliar problems: Part 2

For the questions in Part 2, again use the ‘Working with unfamiliar problems’ poster at the back of this book, but this time choose your own strategy (or strategies) to solve each problem. Clearly communicate your solution and final answer.

- The number $\frac{79}{21}$ can be written in the form $3 + \frac{1}{x + \frac{1}{y + \frac{1}{5}}}$. Find the values of x and y .
- How many solids can you name that have eight vertices?
- Increasing a number by 25% then decreasing the result by $x\%$ gives the original number again. What is the value of x in this case?
- Prove that the sum of two odd numbers is an even number.
- $x + y + xy = 34$ and x and y are both positive integers. What is the value of xy ?
- Find the value of the angle marked x in this diagram.

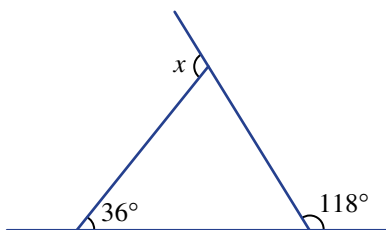

- Given that n is a perfect square, write an expression, in terms of n , for the next largest perfect square.
- A square of side length 8 cm has the midpoints of its sides joined to form a smaller square inside it. The midpoints of that square are joined to form an even smaller square. This method is repeated to create more squares.
 - Find the area of the first five squares. Write these area values as a sequence of powers of a prime number.
 - Continue your sequence from part **a** to find the areas of the 7th square and the 10th square.
 - Write a rule for the area of the n th square. Use this rule to find the area of the 15th square.

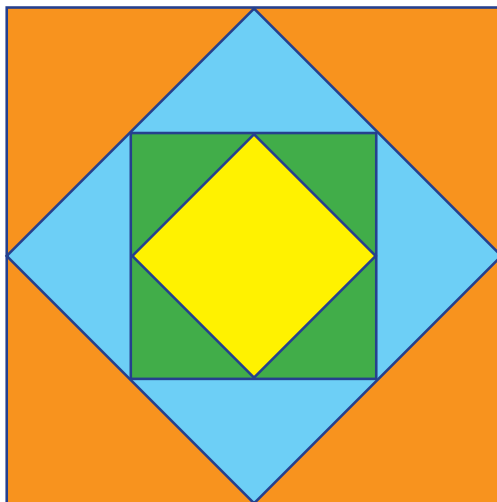

- 9 If the exterior angles of a triangle are in the ratio 4:5:6, then what is the ratio of the interior angles of the same triangle?
- 10 An operation exists where $A\#B = A^B + B^A$. If $A\#6 = 100$, then A has what value?
- 11 Six years ago Sam was five times Noah's age. In ten years' time Sam will be two more than twice Noah's age. How old are they now?
- 12 Find the area of this triangle.

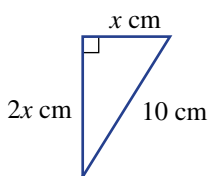

- 13 Simplify these expressions.
- a $3^{x-2} + 3^{x-2} + 3^{x-2}$
- b $(-1)^1 + (-1)^2 + (-1)^3 + \dots + (-1)^{345} + (-1)^{346}$
- 14 a What is the volume of the rectangular prism shown?

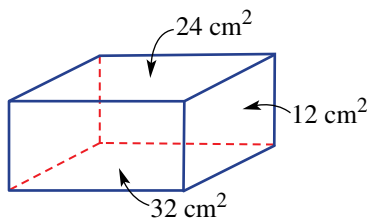

- b Find the exact area of the shaded triangle, given each grid square is 1 unit^2 .

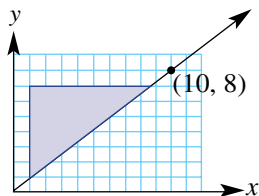

- 15 When a certain number is added to 18 and the same number is subtracted from 21 the product is 350. Find two possible values of this number.
- 16 On a training ride Holly cycled at an average speed of 20 km/h, stopped for a 15 minute break and then completed her trip at an average speed of 24 km/h. If the total distance was 68 km and the total time 3.5 hours (including the stop), determine the time taken for each stage of the ride.
- 17 A triangle has vertices $A(-7, -3)$, $B(8, 7)$ and $C(6, -3)$. A point D is on line AB so that CD is perpendicular to AB . Determine the exact ratio of the area of triangle ABC to the area of triangle DBC .

1

Reviewing number and financial mathematics

Maths in context: Number skills are used everywhere

Number skills are essential for success in algebra, and algebra skills are essential in many university and college courses. Number skills are important in the professions, trades, and for home renovators.

Jewellers use ratios to mix gold with other metals, to strengthen it. Such as mixing gold : silver : copper in the ratio of 15 : 17 : 8.

Medical scientists in hospital pathology laboratories use ratio skills daily when preparing reagents and solutions for analysing blood samples.

Nurses are responsible for accurately calculating each patient's daily dose of prescribed medication, taken orally or intravenously. Nurses constantly use percentages, fractions, and rates.

Chefs make daily calculations with decimals, fractions, ratios, and percentages, such as doubling, tripling, or halving menu recipes written with fractions of a cup and converting temperature units between Fahrenheit and Celsius.

Farmers use rate calculations to efficiently manage water usage, such as pump flow rates, L/s; drip irrigation rates, L/h; and travelling irrigator rates, acres/h.

Using your number skills, you can calculate your weekly pay increase, after tax, if given a percentage wage increase, and calculate your car's increase in price after including the interest payments on a loan.

Chapter contents

- 1A Integer operations (CONSOLIDATING)
- 1B Decimal places and significant figures
- 1C Rational numbers (CONSOLIDATING)
- 1D Operations with fractions (CONSOLIDATING)
- 1E Ratios, rates and best buys (CONSOLIDATING)
- 1F Percentages and money (CONSOLIDATING)
- 1G Percentage increase and decrease (CONSOLIDATING)
- 1H Profits and discounts
- 1I Income
- 1J The PAYG income tax system
- 1K Simple interest
- 1L Compound interest and depreciation (EXTENDING)
- 1M Using a formula for compound interest and depreciation (EXTENDING)

Australian Curriculum 9.0

NUMBER

Recognise that the real number system includes the rational numbers and the irrational numbers, and solve problems involving real numbers using digital tools (AC9M9N01)

ALGEBRA

Use mathematical modelling to solve applied problems involving change including financial contexts; formulate problems, choosing to use either linear or quadratic functions; interpret solutions in terms of the situation; evaluate the model and report methods and findings (AC9M9A05)

MEASUREMENT

Use mathematical modelling to solve practical problems involving direct proportion, rates, ratio and scale, including financial contexts; formulate the problems and interpret solutions in terms of the situation; evaluate the model and report methods and findings (AC9M9M05)

© ACARA

Online resources

A host of additional online resources are included as part of your Interactive Textbook, including HOTmaths content, video demonstrations of all worked examples, auto-marked quizzes and much more.

1A Integer operations CONSOLIDATING

LEARNING INTENTIONS

- To know the numbers in the set of integers
- To know the rules for the mathematical operations applied to negative numbers
- To understand the notation for powers and roots
- To be able to evaluate operations on integers including negative numbers, powers and roots and apply order of operations

Throughout history, mathematicians have developed number systems to investigate and explain the world in which they live. The Egyptians used hieroglyphics to record whole numbers as well as fractions, the Babylonians used a place-value system based on the number 60, and the ancient Chinese and Indians developed systems using negative numbers. Our current base 10 decimal system (the Hindu–Arabic system) has expanded to include positive and negative numbers, fractions (rational numbers), as well as numbers that cannot be written as a fraction (irrational numbers), for example, π and $\sqrt{2}$. All the numbers in our number system, not including imaginary numbers, are called real numbers.



The abacus is an efficient calculating tool and was widely used for thousands of years across China and Europe.

Lesson starter: Special sets of numbers

Here are some special groups of numbers. Can you describe what special property each group has? Try to use the correct vocabulary, for example, factors of 12.

- 7, 14, 21, 28, ...
- 1, 4, 9, 16, 25, ...
- 1, 2, 3, 4, 6, 9, 12, 18, 36.
- 1, 8, 27, 64, 125, ...
- 0, 1, 1, 2, 3, 5, 8, 13, ...
- 2, 3, 5, 7, 11, 13, 17, 19, ...

KEY IDEAS

■ The **integers** include ... , -3, -2, -1, 0, 1, 2, 3, ...

■ **The rules of negative numbers**

- $a + (-b) = a - b$ For example: $5 + (-2) = 5 - 2 = 3$
- $a - (-b) = a + b$ For example: $5 - (-2) = 5 + 2 = 7$
- $a \times (-b) = -ab$ For example: $3 \times (-2) = -6$
- $-a \times (-b) = ab$ For example: $-4 \times (-3) = 12$
- $a \div (-b) = -\frac{a}{b}$ For example: $8 \div (-4) = -2$
- $-a \div (-b) = \frac{a}{b}$ For example: $-8 \div (-4) = 2$

■ **Squares and cubes**

- $a^2 = a \times a$ and $\sqrt{a^2} = a$ (if $a \geq 0$) For example: $6^2 = 36$ and $\sqrt{36} = 6$
- $a^3 = a \times a \times a$ and $\sqrt[3]{a^3} = a$ For example: $4^3 = 64$ and $\sqrt[3]{64} = 4$

■ **LCM, HCF and primes**

- The **lowest common multiple** (LCM) of two numbers is the smallest multiple shared by both numbers. For example: the LCM of 6 and 9 is 18.
- The **highest common factor** (HCF) of two numbers is the largest factor shared by both numbers. For example: the HCF of 24 and 30 is 6.
- **Prime numbers** have only two factors: 1 and the number itself. The number 1 is not considered a prime number.
- **Composite numbers** have more than two factors.

■ **Order of operations**

- Deal with brackets first.
- Deal with indices next.
- Do multiplication and division next from left to right.
- Do addition and subtraction last from left to right.

$$\begin{aligned} & 5 \times (3 - (-2)^2) + 3^3 \div (-9) \\ & = 5 \times (3 - 4) + 27 \div (-9) \\ & = 5 \times (-1) + (-3) \\ & = -5 + (-3) \\ & = -8 \end{aligned}$$

BUILDING UNDERSTANDING

1 State these sets of numbers.

- a The factors of 56
- b The HCF (highest common factor) of 16 and 56
- c The first 7 multiples of 3
- d The LCM (lowest common multiple) of 3 and 5
- e The first ten prime numbers starting from 2

2 Evaluate the following.

- a 11^2
- b $\sqrt{144}$
- c 3^3
- d $\sqrt[3]{8}$

3 Evaluate the following.

- a $-3 + 2$
- b $2 + (-3)$
- c $11 - (-4)$
- d $2 \times (-3)$
- e $-11 \times (-2)$
- f $18 \div (-2)$

**Example 1** Operating with integers

Evaluate the following.

a $-2 - (-3 \times 13) + (-10)$

b $(-20 \div (-4) + (-3)) \times 2$

c $\sqrt[3]{8} - (-1)^2 + 3^3$

SOLUTION

$$\begin{aligned} \mathbf{a} \quad -2 - (-3 \times 13) + (-10) &= -2 - (-39) + (-10) \\ &= -2 + 39 + (-10) \\ &= 37 - 10 \\ &= 27 \end{aligned}$$

$$\begin{aligned} \mathbf{b} \quad (-20 \div (-4) + (-3)) \times 2 &= (5 + (-3)) \times 2 \\ &= 2 \times 2 \\ &= 4 \end{aligned}$$

$$\begin{aligned} \mathbf{c} \quad \sqrt[3]{8} - (-1)^2 + 3^3 &= 2 - 1 + 27 \\ &= 28 \end{aligned}$$

EXPLANATION

Deal with the operations in brackets first.

$-a - (-b) = -a + b$

$a + (-b) = a - b$

$-a \div (-b) = \frac{a}{b}$

Deal with the operations inside brackets before doing the multiplication.

$5 + (-3) = 5 - 3$

Evaluate powers first.

$\sqrt[3]{8} = 2$ since $2^3 = 8$

$(-1)^2 = -1 \times (-1) = 1$

$3^3 = 3 \times 3 \times 3 = 27$

Now you try

Evaluate the following.

a $-4 - (-1 \times 12) + (-3)$

b $(-24 \div (-6) + (-2)) \times 2$

c $\sqrt[3]{27} - (-2)^2 - 4^3$

Exercise 1A**FLUENCY**

$1-4(\frac{1}{2})$

$1-5(\frac{1}{2})$

$1(\frac{1}{4}), 2-5(\frac{1}{2})$

Example 1a,b

1 Evaluate the following showing your steps.

a $-4 - 3 \times (-2)$

c $-2 \times (3 - 8)$

e $2 - 3 \times 2 + (-5)$

g $(-24 \div (-8) + (-5)) \times 2$

i $-3 - 12 \div (-6) \times (-4)$

k $(-6 - 9 \times (-2)) \div (-4)$

m $6 \times (-5) - 14 \div (-2)$

o $-2 + (-4) \div (-3 + 1)$

q $-2 \times 6 \div (-4) \times (-3)$

s $2 - (1 - 2 \times (-1))$

b $-3 \times (-2) + (-4)$

d $2 - 7 \times (-2)$

f $4 + 8 \div (-2) - 3$

h $-7 - (-4 \times 8) - 15$

j $4 \times (-3) \div (-2 \times 3)$

l $10 \times (-2) \div (-7 - (-2))$

n $(-3 + 7) - 2 \times (-3)$

p $-18 \div ((-2 - (-4)) \times (-3))$

r $(7 - 14 \div (-2)) \div 2$

t $20 \div (6 \times (-4 \times 2) \div (-12) - (-1))$

2 Find the LCM (lowest common multiple) of these pairs of numbers.

a 4, 7

b 8, 12

c 11, 17

d 15, 10

3 Find the HCF (highest common factor) of these pairs of numbers.

a 20, 8

b 100, 65

c 37, 17

d 23, 46

Example 1c

4 Evaluate the following.

a $2^3 - \sqrt{16}$

b $5^2 - \sqrt[3]{8}$

c $(-1)^2 \times (-3)$

d $(-2)^3 \div (-4)$

e $\sqrt{9} - \sqrt[3]{125}$

f $1^3 + 2^3 - 3^3$

g $\sqrt[3]{27} - \sqrt{81}$

h $\sqrt[3]{27} - \sqrt{9} - \sqrt[3]{1}$

i $(-1)^{101} \times (-1)^{1000} \times \sqrt[3]{-1}$

5 Evaluate these expressions by substituting $a = -2$, $b = 6$ and $c = -3$.

a $a^2 - b$

b $a - b^2$

c $2c + a$

d $b^2 - c^2$

e $a^3 + c^2$

f $3b + ac$

g $c - 2ab$

h $abc - (ac)^2$

i $\sqrt{abc} - ac^2$

PROBLEM-SOLVING

6, 7

6-8

7-10

6 Insert brackets into these statements to make them true.

a $-2 \times 11 + (-2) = -18$

b $-6 + (-4) \div 2 = -5$

c $2 - 5 \times (-2) = 6$

d $-10 \div 3 + (-5) = 5$

e $3 - (-2) + 4 \times 3 = -3$

f $(-2)^2 + 4 \div (-2) = -2^2$

7 Margaret and Mildred meet on a Eurostar train travelling from London to Paris. Margaret visits her daughter in Paris every 28 days. Mildred visits her son in Paris every 36 days. When will Margaret and Mildred have a chance to meet again on the train?



8 How many different answers are possible if any number of pairs of brackets is allowed to be inserted into this expression?

$$-6 \times 4 - (-7) + (-1)$$

- 9 a The sum of two numbers is 5 and their difference is 9. What are the two numbers?
 b The sum of two numbers is -3 and their product is -10 . What are the two numbers?
- 10 Two opposing football teams have squad sizes of 24 and 32. For a training exercise, each squad is to divide into smaller groups of equal size. What is the largest number of players in a group if the group size for both squads is the same?

REASONING

11

11

11, 12

- 11 a Evaluate:
 i 4^2 ii $(-4)^2$
 b If $a^2 = 16$, write down the possible values of a .
 c If $a^3 = 27$, write down the value of a .
 d Explain why there are two values of a for which $a^2 = 16$ but only one value of a for which $a^3 = 27$.
 e Find $\sqrt[3]{-27}$.
 f Explain why $\sqrt{-16}$ cannot exist (using real numbers).
 g -2^2 is the same as -1×2^2 . Now evaluate:
 i -2^2 ii -5^3 iii $-(-3)^2$ iv $-(-4)^2$
 h Decide if $(-2)^2$ and -2^2 are equal.
 i Decide if $(-2)^3$ and -2^3 are equal.
 j Explain why the HCF of two distinct prime numbers is 1.
 k Explain why the LCM of two distinct prime numbers a and b is $a \times b$.
- 12 If a and b are both positive numbers and $a > b$, decide if the following are true or false.
 a $a - b < 0$ b $-a \times b > 0$ c $-a \div (-b) > 0$
 d $(-a)^2 - a^2 = 0$ e $-b + a < 0$ f $2a - 2b > 0$

ENRICHMENT: Special numbers

-

-

13

- 13 a Perfect numbers are positive integers that are equal to the sum of all their factors, excluding the number itself.
 i Show that 6 is a perfect number.
 ii There is one perfect number between 20 and 30. Find the number.
 iii The next perfect number is 496. Show that 496 is a perfect number.
- b Triangular numbers are the number of dots required to form triangles as shown in this table.
 i Complete this table.

Number of rows	1	2	3	4	5	6
Diagram			
Number of dots (triangular number)	1	3				

- ii Find the 7th and 8th triangular numbers.
- c Fibonacci numbers are a sequence of numbers in which each number is the sum of the two preceding numbers. The first two numbers in the sequence are 0 and 1.
 i Write down the first ten Fibonacci numbers.
 ii If the Fibonacci numbers were to be extended in the negative direction, what would the first four negative Fibonacci numbers be?

1B Decimal places and significant figures

LEARNING INTENTIONS

- To know the rules for rounding to a required number of decimal places
- To understand what is meant by significant figures and how to count them
- To be able to round to a required number of significant figures
- To be able to estimate calculations using rounding

Numbers with and without decimal places can be rounded depending on the level of accuracy required. When using numbers with decimal places, it is common to round off the number to leave only a certain number of decimal places. The time for a 100 m sprint race, for example, might be 9.94 seconds.

Due to the experimental nature of science and engineering, not all the digits in all numbers are considered important or ‘significant’. In such cases we are able to round numbers to within a certain number of significant figures (sometimes abbreviated to sig. fig. or simply s.f.). The number of cubic metres of gravel required for a road, for example, might be calculated as 3485 but rounded to 3500. This number is written using two significant figures.



When civil engineers design a new road cutting through a hill, the volume of earth to be removed only needs to be calculated to two or three significant figures.

Lesson starter: Plausible but incorrect

Johny says that the number 2.748 when rounded to one decimal place is 2.8 because:

- the 8 rounds the 4 to a 5
- then the new 5 rounds the 7 to an 8.

What is wrong with Johny’s theory?

KEY IDEAS

■ To round a number to a required number of **decimal places**:

- Locate the digit in the required decimal place.
- Round down (leave as is) if the next digit (**critical digit**) is 4 or less.
- Round up (increase by 1) if the next digit is 5 or more.

For example:

- To two decimal places, 1.543 rounds to 1.54 and 32.9283 rounds to 32.93.
- To one decimal place, 0.248 rounds to 0.2 and 0.253 rounds to 0.3.

- To round a number to a required number of **significant figures**:
 - Locate the first non-zero digit counting from left to right.
 - From this first significant digit, count the number of significant digits including zeros.
 - Stop at the required number of significant digits and round this last digit.
 - Replace any non-significant digit to the left of a decimal point with a zero.

For example, these numbers are all rounded to three significant figures:

$2.5391 \approx 2.54$, $0.002713 \approx 0.00271$, $568\,810 \approx 569\,000$.

BUILDING UNDERSTANDING

- 1 Choose the number to answer each question.

<p>a Is 44 closer to 40 or 50?</p> <p>c Is 7.89 closer to 7.8 or 7.9?</p>	<p>b Is 266 closer to 260 or 270?</p> <p>d Is 0.043 closer to 0.04 or 0.05?</p>
---	---
- 2 Choose the correct answer if the first given number is rounded to three significant figures.

<p>a 32 124 is rounded to 321, 3210 or 32 100</p> <p>b 431.92 is rounded to 431, 432 or 430</p> <p>c 5.8871 is rounded to 5.887, 5.88 or 5.89</p> <p>d 0.44322 is rounded to 0.44, 0.443 or 0.44302</p>	
---	--
- 3 Using one significant figure rounding, 324 rounds to 300, 1.7 rounds to 2 and 9.6 rounds to 10.

<p>a Calculate $300 \times 2 \div 10$.</p> <p>b Use a calculator to calculate $324 \times 1.7 \div 9.6$.</p> <p>c What is the difference between the answer in part a and the exact answer in part b?</p>	
--	--



Example 2 Rounding to a number of decimal places

Round each of these numbers to two decimal places.

- | | | |
|-------------------|------------------|-----------------|
| a 256.1793 | b 0.04459 | c 4.8972 |
|-------------------|------------------|-----------------|

SOLUTION

- a** $256.1793 \approx 256.18$
- b** $0.04459 \approx 0.04$
- c** $4.8972 \approx 4.90$

EXPLANATION

The number after the second decimal place is 9, so round up (increase the 7 by 1).

The number after the second decimal place is 4, so round down. 4459 is closer to 4000 than 5000.

The number after the second decimal place is 7, so round up. Increasing by 1 means 0.89 becomes 0.90.

Now you try

Round each of these numbers to two decimal places.

- | | | |
|-------------------|------------------|-----------------|
| a 138.4681 | b 0.03268 | c 2.7961 |
|-------------------|------------------|-----------------|

**Example 3 Rounding to a number of significant figures**

Round each of these numbers to two significant figures.

a 2567

b 23 067.453

c 0.04059

SOLUTION

a $2567 \approx 2600$

b $23\,067.453 \approx 23\,000$

c $0.04059 \approx 0.041$

EXPLANATION

The first two digits are the first two significant figures. The third digit is 6, so round up. Replace the last two non-significant digits with zeros.

The first two digits are the first two significant figures. The third digit is 0, so round down.

Locate the first non-zero digit, i.e. 4. So 4 and 0 are the first two significant figures. The next digit is 5, so round up.

Now you try

Round each of these numbers to two significant figures.

a 3582

b 49 018.47

c 0.02864

**Example 4 Estimating using significant figures**

Estimate the answer to the following by rounding each number in the problem to one significant figure. Use your calculator to check how reasonable your answer is.

$$27 + 1329.5 \times 0.0064$$

SOLUTION

$$\begin{aligned} 27 + 1329.5 \times 0.0064 \\ \approx 30 + 1000 \times 0.006 \\ = 30 + 6 \\ = 36 \end{aligned}$$

The estimated answer is reasonable.

EXPLANATION

Round each number to one significant figure and evaluate. Recall that multiplication occurs before the addition.

By calculator (to one decimal place):
 $27 + 1329.5 \times 0.0064 = 35.5$

Now you try

Estimate the answer to the following by rounding each number in the problem to one significant figure. Use your calculator to check how reasonable your answer is.

$$19 + 2143.1 \times 0.0032$$

Exercise 1B

FLUENCY

1, 2–7($\frac{1}{2}$)1, 2($\frac{1}{2}$), 4–7($\frac{1}{2}$)2($\frac{1}{4}$), 4–6($\frac{1}{2}$), 7($\frac{1}{3}$)

1 Round each of these to two decimal places.

Example 2a

a i 124.2694

ii 830.4428

Example 2b

b i 0.02163

ii 0.06714

Example 2c

c i 7.6941

ii 13.4953

2 Round each of the following numbers to two decimal places.

a 17.962

b 11.082

c 72.986

d 47.859

e 63.925

f 23.807

g 804.5272

h 500.5749

i 821.2749

j 5810.2539

k 1004.9981

l 2649.9974

3 Round these numbers to the nearest integer.

a 6.814

b 73.148

c 129.94

d 36 200.49



4 Use division to write these fractions as decimals rounded to three decimal places.

a $\frac{1}{3}$

b $\frac{2}{7}$

c $\frac{13}{11}$

d $\frac{400}{29}$

Example 3

5 Round each of these numbers to two significant figures.

a 2436

b 35 057.4

c 0.06049

d 34.024

e 107 892

f 0.00245

g 2.0745

h 0.7070

6 Round these numbers to one significant figure.

a 32 000

b 194.2

c 0.0492

d 0.0006413

Example 4

7 Estimate the answers to the following by rounding each number in the problem to one significant figure. Check how reasonable your answer is with a calculator.



a $567 + 3126$

b $795 - 35.6$

c 97.8×42.2

d $965.98 + 5321 - 2763.2$

e $4.23 - 1.92 \times 1.827$

f $17.43 - 2.047 \times 8.165$

g $0.0704 + 0.0482$

h 0.023×0.98

i $0.027 \div 0.0032$

j 41.034^2

k 0.078×0.9803^2

l $1.8494^2 + 0.972 \times 7.032$

PROBLEM-SOLVING

8, 9

8–10

9–11

8 An electronic timer records the time for a running relay. Team A's time is 54.283 seconds and team B's time is 53.791 seconds. What would be the difference in the times for teams A and B if the times were written down using:

- 1 decimal place
- 4 significant figures
- 2 significant figures
- 1 significant figure



- 9** $28.4 \times 2.94 \times 11.31$ is calculated by first rounding each of the three numbers. Describe the type of rounding that has taken place if the answer is:
- a** 900 **b** 893.2 **c** 924
- 10** Eighteen posts and 150 m of fencing are used to create an area in the shape of an equilateral triangle. Posts are used in the corners and are evenly spaced along the sides. Find the distance between each post. Write your answer in metres rounded to the nearest centimetre.
- 11** A tonne (1000 kg) of soil is to be equally divided between 7 garden beds. How much soil is placed in each garden bed? Write your answer in tonnes rounded to the nearest kilogram.

REASONING

12

12, 13

13, 14

- 12** Should 2.14999 be rounded down or up if it is to be rounded to one decimal place? Give reasons.

- 13** A scientific experiment uses very small amounts of magnesium (0.0025 g) and potassium (0.0062 g). Why does it make sense to use two significant figures instead of two decimal places when recording numbers in a situation like this?



- 14** Consider the two numbers 24 and 26.

a Calculate:

- i** $24 + 26$
ii 24×26

b Find the sum (+) of the numbers after rounding each number to one significant figure.

c Find the product (\times) of the numbers after rounding each number to one significant figure.

d What do you notice about the answers for parts **b** and **c** as compared to part **a**? Give an explanation.

ENRICHMENT: *n*th decimal place

-

-

15

- 15 a** Use division to express $\frac{2}{11}$ as a decimal correct to 8 decimal places.
- b** Using the decimal pattern from part **a**, find the digit in the:
- i** 20th decimal place
ii 45th decimal place
iii 1000th decimal place.
- c** Express $\frac{1}{7}$ as a decimal correct to 13 decimal places.
- d** Using the decimal pattern from part **c** find the digit in the:
- i** 20th decimal place
ii 45th decimal place
iii 1000th decimal place.
- e** Can you find any fraction whose decimal representation is non-terminating and has no pattern? Use a calculator to help.

1C Rational numbers CONSOLIDATING

LEARNING INTENTIONS

- To understand that the real number system is made up of different types of numbers
- To be able to determine if a number is rational or irrational
- To review how to simplify fractions and convert between fractions and decimals
- To know how to compare fractions using a common denominator

Under the guidance of Pythagoras in about 500 BCE, it was discovered that some numbers could not be expressed as a fraction. These special numbers, called irrational numbers, when written as a decimal continue forever and do not show any pattern. So to write these numbers exactly, you need to use special symbols such as $\sqrt{\quad}$ and π . If, however, the decimal places in a number terminate or if a pattern exists, the number can be expressed as a fraction. These numbers are called rational numbers.

This is $\sqrt{2}$ to 100 decimal places:

1.41421356237309504880168872420969807856967187537694
80731766797379907324784621070388503875343276415727



Numerous people, including scientists, engineers and trade workers, regularly use formulas that contain rational and irrational numbers. This steel sphere is used for chemical analysis and has volume: $V = \frac{4}{3}\pi r^3$.

Lesson starter: Approximating π

To simplify calculations, the ancient and modern civilisations have used fractions to approximate π . To ten decimal places, $\pi = 3.1415926536$.

- Using single-digit numbers, what fraction best approximates π ? (For example: $\frac{5}{2}$).
- Using single and/or double-digit numbers, find a fraction that is a good approximation of π . Compare with other students to see who has the best approximation. (For example: $\frac{35}{11}$).

KEY IDEAS

- An **infinite** decimal is one in which the decimal places continue indefinitely.

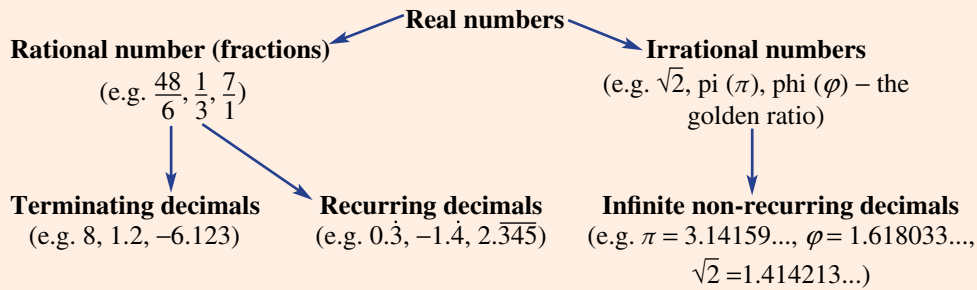

- Equivalent fractions** have the same value.

For example: $\frac{2}{3} = \frac{6}{9}$

- Recall that $\frac{a}{b}$ means $a \div b$.

- A fraction can be simplified by dividing the **numerator** and the **denominator** by their highest common factor.

For example: $\frac{8^2}{20^5} = \frac{2}{5}$

- If $\frac{a}{b}$ is a **proper fraction** then $a < b$.

For example: $\frac{2}{7}$

- If $\frac{a}{b}$ is an **improper fraction** then $a \geq b$.

For example: $\frac{10}{3}$ and $\frac{3}{3}$

- A **mixed numeral** is written as a whole number plus a proper fraction.

For example: $2\frac{3}{5}$

- Fractions can be compared using a **common denominator**. This should be the lowest common multiple of both denominators.

For example: $\frac{2}{3} < \frac{4}{5}$ because $\frac{10}{15} < \frac{12}{15}$

- A dot or bar is used to show a pattern in a recurring decimal number.

For example: $\frac{1}{6} = 0.16666\dots = 0.1\dot{6}$ or $\frac{3}{11} = 0.272727\dots = 0.\overline{27}$

BUILDING UNDERSTANDING

1 Give these numbers as mixed numerals.

a $\frac{7}{5}$

b $\frac{13}{3}$

c $\frac{48}{11}$

2 Give these numbers as improper fractions.

a $1\frac{4}{7}$

b $5\frac{1}{3}$

c $9\frac{1}{2}$

3 Simplify these fractions by cancelling.

a $\frac{4}{10}$

b $\frac{8}{58}$

c $4\frac{20}{120}$

4 Give the missing number.

a $\frac{3}{5} = \frac{\square}{15}$

b $\frac{5}{6} = \frac{20}{\square}$

c $\frac{\square}{4} = \frac{21}{28}$

d $\frac{3}{\square} = \frac{15}{50}$



Example 5 Writing fractions as decimals

Write these fractions as decimals.

a $3\frac{3}{8}$

b $\frac{5}{13}$

SOLUTION

a
$$\begin{array}{r} 0.375 \\ 8 \overline{)3.300} \\ \underline{24} \\ 90 \\ \underline{80} \\ 100 \\ \underline{80} \\ 200 \\ \underline{160} \\ 400 \\ \underline{400} \\ 0 \end{array}$$

$$3\frac{3}{8} = 3.375$$

b
$$\begin{array}{r} 0.3846153 \\ 13 \overline{)5.0000000} \\ \underline{39} \\ 110 \\ \underline{91} \\ 190 \\ \underline{156} \\ 340 \\ \underline{275} \\ 650 \\ \underline{650} \\ 0 \end{array}$$

$$\frac{5}{13} = 0.\overline{384615}$$

EXPLANATION

Find a decimal for $\frac{3}{8}$ by dividing 8 into 3 using the short-division algorithm.

Divide 13 into 5 and continue until the pattern repeats.

Add a bar over the repeating pattern.

Writing $0.\overline{384615}$ is an alternative.

Now you try

Write these fractions as decimals.

a $4\frac{5}{8}$

b $\frac{2}{11}$



Example 6 Writing decimals as fractions

Write these decimals as fractions.

a 0.24

b 2.385

SOLUTION

$$\begin{aligned} \text{a } 0.24 &= \frac{24}{100} \\ &= \frac{6}{25} \end{aligned}$$

$$\begin{aligned} \text{b } 2.385 &= 2\frac{385}{1000} \quad \text{OR} \quad \frac{2385}{1000} \\ &= 2\frac{77}{200} \quad = \frac{477}{200} \\ &= 2\frac{77}{200} \end{aligned}$$

EXPLANATION

Write as a fraction using the smallest place value (hundredths) then simplify using the HCF of 4.

The smallest place value is thousandths. Simplify to an improper fraction or a mixed numeral. 5 is a common factor.

Now you try

Write these decimals as fractions.

a 0.45

b 1.425



Example 7 Comparing fractions

Decide which is the larger fraction.

$$\frac{7}{12} \text{ or } \frac{8}{15}$$

SOLUTION

LCM of 12 and 15 is 60.

$$\frac{7}{12} = \frac{35}{60} \text{ and } \frac{8}{15} = \frac{32}{60}$$

$$\therefore \frac{7}{12} > \frac{8}{15}$$

EXPLANATION

Find the lowest common multiple of the two denominators (lowest common denominator). Write each fraction as an equivalent fraction using the common denominator. Then compare numerators (i.e. $35 > 32$) to determine the larger fraction.

Now you try

Decide which is the larger fraction.

$$\frac{3}{5} \text{ or } \frac{7}{11}$$

Exercise 1C

FLUENCY

1–4($\frac{1}{2}$), 61–4($\frac{1}{3}$), 5, 61–4($\frac{1}{4}$), 5, 6($\frac{1}{2}$)

Example 5a

1 Write these fractions as decimals.

a $\frac{11}{4}$

b $\frac{7}{20}$

c $\frac{37}{16}$

d $\frac{15}{8}$

e $2\frac{5}{8}$

f $3\frac{4}{5}$

g $3\frac{2}{5}$

h $1\frac{7}{32}$

Example 5b

2 Write these fractions as recurring decimals.

a $\frac{3}{11}$

b $\frac{7}{9}$

c $\frac{9}{7}$

d $\frac{5}{12}$

e $\frac{10}{9}$

f $3\frac{5}{6}$

g $7\frac{4}{15}$

h $\frac{29}{11}$

Example 6

3 Write these decimals as fractions.

a 0.35

b 0.06

c 3.7

d 0.56

e 1.07

f 0.075

g 3.32

h 7.375

i 2.005

j 10.044

k 6.45

l 2.101

Example 7

4 Decide which is the larger fraction in the following pairs.

a $\frac{3}{4}$ or $\frac{5}{6}$

b $\frac{13}{20}$ or $\frac{3}{5}$

c $\frac{7}{10}$ or $\frac{8}{15}$

d $\frac{5}{12}$ or $\frac{7}{18}$

e $\frac{7}{16}$ or $\frac{5}{12}$

f $\frac{26}{35}$ or $\frac{11}{14}$

g $\frac{7}{12}$ or $\frac{19}{30}$

h $\frac{7}{18}$ or $\frac{11}{27}$

5 Place these fractions in descending order.

a $\frac{3}{8}, \frac{5}{12}, \frac{7}{18}$

b $\frac{1}{6}, \frac{5}{24}, \frac{3}{16}$

c $\frac{8}{15}, \frac{23}{40}, \frac{7}{12}$

6 Express the following quantities as simplified fractions.

a \$45 out of \$100

b 12 kg out of 80 kg

c 64 baskets out of 90 shots in basketball

d 115 mL out of 375 mL

PROBLEM-SOLVING

7, 8

7($\frac{1}{2}$), 8, 9

8–10

7 These sets of fractions form a pattern. Find the next two fractions in the pattern.

a $\frac{1}{3}, \frac{5}{6}, \frac{4}{3}, \frac{\square}{\square}, \frac{\square}{\square}$

b $\frac{6}{5}, \frac{14}{15}, \frac{2}{3}, \frac{\square}{\square}, \frac{\square}{\square}$

c $\frac{2}{3}, \frac{3}{4}, \frac{5}{6}, \frac{\square}{\square}, \frac{\square}{\square}$

d $\frac{1}{2}, \frac{4}{7}, \frac{9}{14}, \frac{\square}{\square}, \frac{\square}{\square}$

8 The 'Weather forecast' website says there is a 0.45 chance that it will rain tomorrow. The 'Climate control' website says that the chance of rain is $\frac{14}{30}$. Which website gives the smaller chance that it will rain?



- 9 A jug has 400 mL of half-strength orange juice. The following amounts of full-strength juice are added to the mix. Find a fraction to describe the strength of the orange drink after the full-strength juice is added.
- a 100 mL b 50 mL c 120 mL d 375 mL
- 10 If x is an integer, determine the values that x can take in the following.
- a The fraction $\frac{x}{3}$ is a number between (and not including) 10 and 11.
- b The fraction $\frac{x}{7}$ is a number between (and not including) 5 and 8.
- c The fraction $\frac{34}{x}$ is a number between 6 and 10.
- d The fraction $\frac{23}{x}$ is a number between 7 and 12.
- e The fraction $\frac{x}{14}$ is a number between (and not including) 3 and 4.
- f The fraction $\frac{58}{x}$ is a number between 9 and 15.

REASONING

11

11, 12

11, 12

- 11 $a\frac{b}{c}$ is a mixed numeral with unknown digits a , b and c . Write it as an improper fraction.
- 12 Given that $\frac{a}{b}$ is a fraction, answer the following questions with reasons.
- a Is it possible to find a fraction that can be simplified by cancelling if one of a or b is prime?
- b Is it possible to find a fraction that can be simplified by cancelling if both a and b are prime?
Assume $a \neq b$.
- c If $\frac{a}{b}$ is a fraction in simplest form, can a and b both be even?
- d If $\frac{a}{b}$ is a fraction in simplest form, can a and b both be odd?

ENRICHMENT: Converting recurring decimals to fractions

-

-

13

- 13 Here are two examples of how to convert recurring decimals to fractions.

$$\begin{aligned} 0.\dot{6} &= 0.6666 \dots \\ \text{Let } x &= 0.6666 \dots \text{ [1]} \\ 10x &= 6.6666 \dots \text{ [2]} \\ [2] - [1] \quad 9x &= 6 \\ x &= \frac{6}{9} = \frac{2}{3} \\ \therefore 0.\dot{6} &= \frac{2}{3} \end{aligned}$$

$$\begin{aligned} 1.\overline{27} &= 1.272727 \dots \\ \text{Let } x &= 1.272727 \dots \text{ [1]} \\ 100x &= 127.2727 \dots \text{ [2]} \\ [2] - [1] \quad 99x &= 126 \\ x &= \frac{126}{99} \\ \therefore 1.\overline{27} &= \frac{126}{99} = 1\frac{27}{99} = 1\frac{3}{11} \end{aligned}$$

Convert these recurring decimals to fractions using the method above.

- a $0.\dot{8}$ b $0.\dot{2}$ c $0.\overline{81}$ d $3.\overline{43}$
- e $9.\overline{75}$ f $0.\overline{132}$ g $2.\overline{917}$ h $13.\overline{8125}$

1D Operations with fractions CONSOLIDATING

LEARNING INTENTIONS

- To understand that to add or subtract fractions a common denominator is required
- To be able to add and subtract fractions, including those in mixed numeral form, using the lowest common denominator
- To understand that to multiply fractions it is simpler to first cancel any common factors between numerators and denominators
- To know that to divide a number by a fraction we multiply by the reciprocal of the fraction
- To know to express mixed numerals as improper fractions before multiplying or dividing
- To be able to multiply and divide fractions

Operations with integers can be extended to include rational numbers, which are numbers that can be expressed as fractions. The operations include addition, subtraction, multiplication and division. Addition and subtraction of fractions is generally more complex than multiplication and division because there is the added step of finding common denominators.



Can you name some everyday applications of fractions illustrated by this photo?

Lesson starter: The common errors

Here are incorrect solutions to four problems involving fractions.

$$\bullet \frac{2}{3} \times \frac{5}{3} = \frac{2 \times 5}{3} = \frac{10}{3}$$

$$\bullet \frac{2}{3} + \frac{1}{2} = \frac{2+1}{3+2} = \frac{3}{5}$$

$$\bullet \frac{7}{6} \div \frac{7}{3} = \frac{7}{6} \div \frac{14}{6} = \frac{\frac{1}{2}}{6} = \frac{1}{12}$$

$$\bullet 1\frac{1}{2} - \frac{2}{3} = 1\frac{3}{6} - \frac{4}{6} = -1\frac{1}{6}$$

In each case describe what is wrong and give the correct solution.

KEY IDEAS

- To add or subtract fractions, first convert each fraction to **equivalent fractions** that have the same **denominator**.
 - Choose the lowest common denominator (LCD).
 - Add or subtract the numerators and retain the denominator.
- To multiply fractions, multiply the numerators and multiply the denominators after the following steps.
 - Convert mixed numerals to improper fractions before multiplying.
 - Cancel the highest common factor between any numerator and any denominator before multiplying.
 - Note: The word ‘of’ usually means ‘multiply’.
For example: $\frac{1}{3}$ of 24 = $\frac{1}{3} \times 24$
- The **reciprocal** of a number multiplied by the number itself is equal to 1.
 - For example: the reciprocal of 2 is $\frac{1}{2}$ since $2 \times \frac{1}{2} = 1$
the reciprocal of $\frac{3}{5}$ is $\frac{5}{3}$ since $\frac{3}{5} \times \frac{5}{3} = 1$
- To divide a number by a fraction, multiply by its reciprocal.
 - Whole numbers can be written using a denominator of 1.
For example: $3 = \frac{3}{1}$

BUILDING UNDERSTANDING

- 1 State the lowest common denominator for these pairs of fractions.

a $\frac{1}{2}, \frac{1}{3}$	b $\frac{3}{7}, \frac{5}{9}$	c $\frac{1}{2}, \frac{1}{4}$	d $\frac{5}{12}, \frac{7}{30}$
------------------------------	------------------------------	------------------------------	--------------------------------
- 2 Convert these mixed numerals to improper fractions.

a $2\frac{1}{3}$	b $7\frac{4}{5}$	c $10\frac{1}{4}$
------------------	------------------	-------------------
- 3 State the missing numbers to complete the given working.

a $\frac{3}{2} + \frac{4}{3} = \frac{\square}{6} + \frac{\square}{6}$ $= \frac{\square}{6}$	b $1\frac{1}{3} - \frac{2}{5} = \frac{\square}{3} - \frac{2}{5}$ $= \frac{\square}{15} - \frac{\square}{15}$ $= \frac{14}{\square}$	c $\frac{5}{3} \div \frac{2}{7} = \frac{5}{3} \times \frac{\square}{2}$ $= \frac{\square}{6}$
--	---	--
- 4 State the reciprocal of the following fractions.

a 5	b $\frac{1}{4}$	c $\frac{2}{3}$	d $\frac{5}{4}$
-----	-----------------	-----------------	-----------------



Example 8 Adding and subtracting fractions

Evaluate the following.

a $\frac{1}{2} + \frac{3}{5}$

b $1\frac{2}{3} + 4\frac{5}{6}$

c $3\frac{2}{5} - 2\frac{3}{4}$

SOLUTION

$$\begin{aligned} \text{a } \frac{1}{2} + \frac{3}{5} &= \frac{5}{10} + \frac{6}{10} \\ &= \frac{11}{10} \text{ or } 1\frac{1}{10} \end{aligned}$$

$$\begin{aligned} \text{b } 1\frac{2}{3} + 4\frac{5}{6} &= \frac{5}{3} + \frac{29}{6} \\ &= \frac{10}{6} + \frac{29}{6} \\ &= \frac{39}{6} \\ &= \frac{13}{2} \text{ or } 6\frac{1}{2} \end{aligned}$$

Alternative method:

$$\begin{aligned} 1\frac{2}{3} + 4\frac{5}{6} &= 1\frac{4}{6} + 4\frac{5}{6} \\ &= 5\frac{9}{6} \\ &= 6\frac{3}{6} \\ &= 6\frac{1}{2} \end{aligned}$$

$$\begin{aligned} \text{c } 3\frac{2}{5} - 2\frac{3}{4} &= \frac{17}{5} - \frac{11}{4} \\ &= \frac{68}{20} - \frac{55}{20} \\ &= \frac{13}{20} \end{aligned}$$

EXPLANATION

The lowest common denominator of 2 and 5 is 10. Rewrite as equivalent fractions using a denominator of 10 and add the numerators.

Change each mixed numeral to an improper fraction.

Remember the lowest common denominator of 3 and 6 is 6. Change $\frac{5}{3}$ to an equivalent fraction with denominator 6, then add the numerators and simplify by cancelling HCF of 3.

Alternatively, add whole numbers and fractions separately, after finding a common denominator for the fractions $\left(\frac{2}{3} = \frac{4}{6}\right)$.

$$\frac{9}{6} = 1\frac{3}{6}$$

Convert to improper fractions then rewrite as equivalent fractions with the same denominator. Subtract the numerators.

Now you try

Evaluate the following.

a $\frac{1}{3} + \frac{2}{5}$

b $1\frac{1}{2} + 3\frac{5}{8}$

c $4\frac{3}{5} - 2\frac{3}{4}$



Example 9 Multiplying fractions

Evaluate the following.

a $\frac{2}{3} \times \frac{5}{7}$

b $1\frac{2}{3} \times 2\frac{1}{10}$

SOLUTION

$$\begin{aligned} \text{a } \frac{2}{3} \times \frac{5}{7} &= \frac{2 \times 5}{3 \times 7} \\ &= \frac{10}{21} \end{aligned}$$

$$\begin{aligned} \text{b } 1\frac{2}{3} \times 2\frac{1}{10} &= \frac{15}{3} \times \frac{21}{10} \\ &= \frac{7}{2} \text{ or } 3\frac{1}{2} \end{aligned}$$

EXPLANATION

No cancelling is possible as there are no common factors between numerators and denominators.

Multiply the numerators and the denominators.

Rewrite as improper fractions.

Cancel common factors between numerators and denominators and then multiply remaining numerators and denominators.

Now you try

Evaluate the following.

a $\frac{4}{5} \times \frac{3}{7}$

b $2\frac{1}{3} \times 3\frac{2}{7}$



Example 10 Dividing fractions

Evaluate the following.

a $\frac{4}{15} \div \frac{12}{25}$

b $1\frac{17}{18} \div 1\frac{1}{27}$

SOLUTION

$$\begin{aligned} \text{a } \frac{4}{15} \div \frac{12}{25} &= \frac{4}{15} \times \frac{25}{12} \\ &= \frac{14}{315} \times \frac{25^5}{12_3} \\ &= \frac{5}{9} \end{aligned}$$

$$\begin{aligned} \text{b } 1\frac{17}{18} \div 1\frac{1}{27} &= \frac{35}{18} \div \frac{28}{27} \\ &= \frac{5^3 35}{2^{18}} \times \frac{27^3}{28^4} \\ &= \frac{15}{8} \text{ or } 1\frac{7}{8} \end{aligned}$$

EXPLANATION

To divide by $\frac{12}{25}$ we multiply by its reciprocal $\frac{25}{12}$.

Cancel common factors between numerators and denominators then multiply fractions.

Rewrite mixed numerals as improper fractions.

Multiply by the reciprocal of the second fraction.

Now you try

Evaluate the following.

a $\frac{2}{9} \div \frac{4}{15}$

b $1\frac{11}{12} \div 1\frac{3}{8}$

Exercise 1D

FLUENCY

1–6($\frac{1}{2}$)1–4($\frac{1}{2}$), 5–6($\frac{1}{3}$)3–4($\frac{1}{2}$), 5–6($\frac{1}{4}$)

Example 8a

1 Evaluate the following.

a $\frac{2}{5} + \frac{1}{5}$

b $\frac{3}{9} + \frac{1}{9}$

c $\frac{5}{7} + \frac{4}{7}$

d $\frac{3}{4} + \frac{1}{5}$

e $\frac{1}{3} + \frac{4}{7}$

f $\frac{3}{8} + \frac{4}{5}$

g $\frac{2}{5} + \frac{3}{10}$

h $\frac{4}{9} + \frac{5}{27}$

2 Evaluate the following.

a $\frac{4}{5} - \frac{2}{5}$

b $\frac{4}{5} - \frac{7}{9}$

c $\frac{3}{4} - \frac{1}{5}$

d $\frac{2}{5} - \frac{3}{10}$

e $\frac{8}{9} - \frac{5}{6}$

f $\frac{3}{8} - \frac{1}{4}$

g $\frac{5}{9} - \frac{3}{8}$

h $\frac{5}{12} - \frac{5}{16}$

Example 8b

3 Evaluate the following.

a $3\frac{1}{4} + 1\frac{3}{4}$

b $2\frac{3}{5} + \frac{4}{5}$

c $1\frac{3}{7} + 3\frac{5}{7}$

d $2\frac{1}{3} + 4\frac{2}{5}$

e $2\frac{5}{7} + 4\frac{5}{9}$

f $10\frac{5}{8} + 7\frac{3}{16}$

Example 8c

4 Evaluate the following.

a $2\frac{3}{4} - 1\frac{1}{4}$

b $3\frac{5}{8} - 2\frac{7}{8}$

c $3\frac{1}{4} - 2\frac{3}{5}$

d $3\frac{5}{8} - 2\frac{9}{10}$

e $2\frac{2}{3} - 1\frac{5}{6}$

f $3\frac{7}{11} - 2\frac{3}{7}$

Example 9

5 Evaluate the following (recall that $6 = \frac{6}{1}$).

a $\frac{2}{5} \times \frac{3}{7}$

b $\frac{3}{5} \times \frac{5}{6}$

c $\frac{2}{15} \times \frac{5}{8}$

d $\frac{6}{21} \times 1\frac{5}{9}$

e $6 \times \frac{3}{4}$

f $8 \times \frac{2}{3}$

g $\frac{5}{6} \times 9$

h $1\frac{1}{4} \times 4$

i $2\frac{1}{2} \times 6$

j $1\frac{5}{8} \times 16$

k $\frac{10}{21} \times 1\frac{2}{5}$

l $\frac{25}{44} \times 1\frac{7}{15}$

m $1\frac{1}{2} \times 1\frac{1}{2}$

n $1\frac{1}{2} \times 2\frac{1}{3}$

o $2\frac{2}{3} \times 2\frac{1}{4}$

p $1\frac{1}{5} \times 1\frac{1}{9}$

Example 10

6 Evaluate the following (recall that the reciprocal of 8 is $\frac{1}{8}$ and for $\frac{3}{4}$ it is $\frac{4}{3}$).

a $\frac{4}{7} \div \frac{3}{5}$

b $\frac{3}{4} \div \frac{2}{3}$

c $\frac{5}{8} \div \frac{7}{9}$

d $\frac{3}{7} \div \frac{4}{9}$

e $\frac{3}{4} \div \frac{9}{16}$

f $\frac{4}{5} \div \frac{8}{15}$

g $\frac{8}{9} \div \frac{4}{27}$

h $\frac{15}{42} \div \frac{20}{49}$

i $15 \div \frac{5}{6}$

j $6 \div \frac{2}{3}$

k $12 \div \frac{3}{4}$

l $24 \div \frac{3}{8}$

m $\frac{4}{5} \div 8$

n $\frac{3}{4} \div 9$

o $\frac{8}{9} \div 6$

p $14 \div 4\frac{1}{5}$

q $6 \div 1\frac{1}{2}$

r $1\frac{1}{3} \div 8$

s $2\frac{1}{4} \div 1\frac{1}{2}$

t $4\frac{2}{3} \div 5\frac{1}{3}$

PROBLEM-SOLVING

7–9

8, 9, 10($\frac{1}{2}$), 119, 10($\frac{1}{2}$), 11, 12

- 7 To remove impurities, a mining company filters $3\frac{1}{2}$ tonnes of raw material. If $2\frac{5}{8}$ tonnes of impurities are removed, what quantity of material remains?
- 8 When a certain raw material is processed it produces $3\frac{1}{7}$ tonnes of mineral and $2\frac{3}{8}$ tonnes of waste. How many tonnes of raw material were processed?

- 9 In a $2\frac{1}{2}$ hour maths exam, $\frac{1}{6}$ of that time is allocated as reading time. How long is the reading time?
- 10 Evaluate these mixed-operation problems.
- a $\frac{2}{3} \times \frac{1}{3} \div \frac{7}{9}$ b $\frac{4}{5} \times \frac{3}{5} \div \frac{9}{10}$ c $\frac{4}{9} \times \frac{6}{25} \div \frac{1}{150}$
- d $2\frac{1}{5} \times \frac{3}{7} \div 1\frac{3}{14}$ e $5\frac{1}{3} \times \frac{13}{24} \div 1\frac{1}{6}$ f $2\frac{4}{13} \times \frac{3}{8} \div 3\frac{3}{4}$
- 11 A road is to be constructed with $15\frac{1}{2}$ m³ of crushed rock. If a small truck can carry $2\frac{1}{3}$ m³ of crushed rock, how many truckloads will be needed?
- 12 Regan worked for $7\frac{1}{2}$ hours in a sandwich shop. Three-fifths of her time was spent cleaning up and the rest serving customers. How much time did she spend serving customers?



REASONING

13

13, 14

14, 15

- 13 Here is an example involving the subtraction of fractions in which improper fractions are not used.

$$\begin{aligned} 2\frac{1}{2} - 1\frac{1}{3} &= 2\frac{3}{6} - 1\frac{2}{6} \\ &= 1\frac{1}{6} \end{aligned}$$

Try this technique on the following problem and explain the difficulty that you encounter.

$$2\frac{1}{3} - 1\frac{1}{2}$$

- 14 a A fraction is given by $\frac{a}{b}$. Write down its reciprocal.
b A mixed numeral is given by $a\frac{b}{c}$. Write an expression for its reciprocal.

- 15 If a , b and c are integers, simplify the following.

a $\frac{b}{a} \times \frac{a}{b}$

b $\frac{a}{b} \div \frac{b}{a}$

c $\frac{a}{b} \div \frac{a}{b}$

d $\frac{a}{b} \times \frac{c}{a} \div \frac{a}{b}$

e $\frac{abc}{a} \div \frac{bc}{a}$

f $\frac{a}{b} \div \frac{b}{c} \times \frac{b}{a}$

ENRICHMENT: Fraction operation challenge

-

-

16($\frac{1}{2}$)

- 16 Evaluate the following. Express your answers using improper fractions where necessary.

a $2\frac{1}{3} - 1\frac{2}{5} \times 2\frac{1}{7}$

b $1\frac{1}{4} \times 1\frac{1}{5} - 2\frac{1}{2} \div 10$

c $1\frac{4}{5} \times 4\frac{1}{6} + \frac{2}{3} \times 1\frac{1}{5}$

d $(1\frac{2}{3} + 1\frac{3}{4}) \div 3\frac{5}{12}$

e $4\frac{1}{6} \div (1\frac{1}{3} + 1\frac{1}{4})$

f $(1\frac{1}{5} - \frac{3}{4}) \times (1\frac{1}{5} - \frac{3}{4})$

g $(2\frac{1}{4} - 1\frac{2}{3}) \times (2\frac{1}{4} + 1\frac{2}{3})$

h $(3\frac{1}{2} + 1\frac{3}{5}) \times (3\frac{1}{2} - 1\frac{3}{5})$

i $(2\frac{2}{3} - 1\frac{3}{4}) \times (2\frac{2}{3} + 1\frac{3}{4})$

j $(4\frac{1}{2} - 3\frac{2}{3}) \div (1\frac{1}{3} + \frac{1}{2})$

1E Ratios, rates and best buys CONSOLIDATING

LEARNING INTENTIONS

- To understand how ratios and rates are used to compare quantities
- To be able to write ratios and rates in simplest form using correct notation
- To know how to apply the unitary method to divide a quantity in a ratio
- To be able to use ratios and rates to determine best buys when purchasing products

Fractions, ratios and rates are used to compare quantities. A leaf blower, for example, might require $\frac{1}{6}$ of a litre of oil to make a petrol mix of 2 parts oil to 25 parts petrol, which is an oil to petrol ratio of 2 to 25 or 2 : 25. The leaf blower's fan might then spin at a rate of 1000 revolutions per minute (1000 revs/min).



A vehicle's fuel efficiency is a rate, usually given in litres per 100 km. Fuel consumption rates can vary from 5 L/100 km for a small car, up to 25 L/100 km for a large car towing a caravan.

Lesson starter: The lottery win

\$100 000 is to be divided among three lucky people in a ratio of 2 to 3 to 5 (2 : 3 : 5). How should the money be divided?

- Clearly write down your method and answer. There may be many different ways to solve this problem.
- Write down and discuss the alternative methods suggested by other students in the class.

KEY IDEAS

- **Ratios** are used to compare quantities with the same units.
 - The ratio of a to b is written $a : b$.
 - Ratios in simplest form use whole numbers that have no common factor.
- The **unitary method** involves finding the value of one part of a total.
 - Once the value of one part is found then the value of several parts can easily be determined.
- A **rate** compares related quantities with different units.
 - The rate is usually written with one quantity compared to a single unit of the other quantity. For example: 50 km per 1 hour or 50 km/h.
- Ratios and rates can be used to determine **best buys** when purchasing products.

BUILDING UNDERSTANDING

1 State the missing number.

a $2 : 5 = \square : 10$

b $3 : 7 = \square : 28$

c $8 : \square = 640 : 880$

d $\square : 4 = 7.5 : 10$

2 Consider the ratio of sheep to chickens of 4 : 5 on a farm.

a What is the total number of parts?

b What fraction of the total are sheep?

c What fraction of the total are chickens?

d If there were 18 in total, how many of them are sheep?

e If there were 18 in total, how many of them are chickens?

3 A car is travelling at a rate (speed) of 80 km/h.

a How far would it travel in:

i 3 hour?

ii $\frac{1}{2}$ hour?

iii $6\frac{1}{2}$ hours?

b How long would it take to travel:

i 400 km?

ii 360 km?

iii 20 km?

4 How much would 1 kg cost if:

a 2 kg costs \$8?

b 5 kg costs \$15?

c 4 kg costs \$10?



Example 11 Simplifying ratios

Simplify these ratios.

a $38 : 24$

b $2\frac{1}{2} : 1\frac{1}{3}$

c $0.2 : 0.14$

SOLUTION

a $38 : 24 = 19 : 12$

b $2\frac{1}{2} : 1\frac{1}{3} = \frac{5}{2} : \frac{4}{3}$
 $= \frac{15}{6} : \frac{8}{6}$
 $= 15 : 8$

c $0.2 : 0.14 = 20 : 14$
 $= 10 : 7$

EXPLANATION

The HCF of 38 and 24 is 2, so divide both sides by 2.

Write as improper fractions using the same denominator.

Then multiply both sides by 6 to write as whole numbers.

Multiply by 100 to remove all the decimal places and simplify.

Now you try

Simplify these ratios.

a $12 : 8$

b $2\frac{2}{3} : 1\frac{1}{2}$

c $0.4 : 0.24$

**Example 12** Dividing into a given ratio

\$300 is to be divided in the ratio 2 : 3.

Find the value of the larger portion using the unitary method.

SOLUTION

Total number of parts is $2 + 3 = 5$.

5 parts = \$300

$$1 \text{ part} = \frac{1}{5} \text{ of } \$300$$

$$= \$60$$

Larger portion = $3 \times \$60$

$$= \$180$$

EXPLANATION

Use the ratio 2 : 3 to find the total number of parts.

Calculate the value of each part, $300 \div 5$.

Calculate the value of 3 parts.

Now you try

\$250 is to be divided in the ratio 1 : 4.

Find the value of the larger portion using the unitary method.

**Example 13** Simplifying rates

Write these rates in simplest form.

a 120 km every 3 hours

b 5000 revolutions in $2\frac{1}{2}$ minutes

SOLUTION

$$\begin{aligned} \text{a } 120 \text{ km per 3 hours} &= \frac{120}{3} \text{ km/h} \\ &= 40 \text{ km/h} \end{aligned}$$

$$\begin{aligned} \text{b } 5000 \text{ revolutions per } 2\frac{1}{2} \text{ minutes} &= 10000 \text{ revolutions per 5 minutes} \\ &= \frac{10000}{5} \text{ revs/min} \\ &= 2000 \text{ revs/min} \end{aligned}$$

EXPLANATION

Divide by 3 to write the rate compared to 1 hour.

First multiply by 2 to remove the fraction.

Then divide by 5 to write the rate using 1 minute.

Now you try

Write these rates in simplest form.

a 70 km every 2 hours

b 600 revolutions in $1\frac{1}{2}$ minutes.



Example 14 Finding best buys

Which is better value:

- a** 5 kg of potatoes for \$3.80 or 3 kg for \$2.20?
b 400 mL of shampoo A at \$3.20 or 320 mL of shampoo B at \$2.85? Compare the cost of 100 mL of each product then decide which is the better buy. Assume the products are of similar quality.

SOLUTION

- a Method A.** Price per kg

5 kg bag:

$$1 \text{ kg costs } \$3.80 \div 5 = \$0.76$$

3 kg bag:

$$1 \text{ kg costs } \$2.20 \div 3 = \$0.73$$

\therefore the 3 kg bag is better value.

- Method B.** Amount per \$1

5 kg bag:

$$\$1 \text{ buys } 5 \div 3.8 = 1.32 \text{ kg}$$

3 kg bag:

$$\$1 \text{ buys } 3 \div 2.2 = 1.36 \text{ kg}$$

\therefore the 3 kg bag is better value.

- b Shampoo A:**

$$100 \text{ mL costs } \$3.20 \div 4 = \$0.80$$

Shampoo B:

$$100 \text{ mL costs } \$2.85 \div 3.2 = \$0.89$$

\therefore shampoo A is the better buy.

EXPLANATION

Divide each price by the number of kilograms to find the price per kilogram.

Then compare.

Divide each amount in kilograms by the cost to find the weight per \$1 spent.

Then compare.

Alternatively, divide by 400 to find the cost of 1 mL then multiply by 100.

Alternatively, divide by 320 to find the cost of 1 mL then multiply by 100.

Now you try

Which is better value:

- a** 7 kg of onions for \$5.60 or 5 kg of onions for \$4.25?
b 300 mL of juice A at \$2.40 or 450 mL of juice B at \$3.15?

Exercise 1E

FLUENCY

$1-3(\frac{1}{2}), 5(\frac{1}{2}), 7(\frac{1}{2})$

$1-5(\frac{1}{2}), 6, 7(\frac{1}{2}), 8$

$1-8(\frac{1}{3})$

Example 11

- 1** Simplify these ratios.

a 6 : 30

b 8 : 20

c 42 : 28

d 52 : 39

e $1\frac{1}{2} : 3\frac{1}{3}$

f $2\frac{1}{4} : 1\frac{2}{5}$

g $\frac{3}{8} : 1\frac{3}{4}$

h $1\frac{5}{6} : 3\frac{1}{4}$

i 0.3 : 0.9

j 0.7 : 3.5

k 1.6 : 0.56

l 0.4 : 0.12

- 2 Write each of the following as a ratio in simplest form. (*Hint*: Convert to the same unit first.)
- | | | |
|------------------------|------------------------|----------------------------|
| a 80c : \$8 | b 90c : \$4.50 | c 80 cm : 1.2 m |
| d 0.7 kg : 800 g | e 2.5 kg : 400 g | f 30 min : 2 hours |
| g 45 min : 3 hours | h 4 hours : 50 min | i 40 cm : 2 m : 50 cm |
| j 80 cm : 600 mm : 2 m | k 2.5 hours : 1.5 days | l 0.09 km : 300 m : 1.2 km |

Example 12

- 3 Divide \$500 in these ratios using the unitary method.
- | | | | |
|---------|---------|---------|----------|
| a 2 : 3 | b 3 : 7 | c 1 : 1 | d 7 : 13 |
|---------|---------|---------|----------|
- 4 Divide \$70 in these ratios.
- | | | |
|-------------|-------------|-------------|
| a 1 : 2 : 4 | b 2 : 7 : 1 | c 8 : 5 : 1 |
|-------------|-------------|-------------|

Example 13

- 5 Write these rates in simplest form.
- | | |
|--|--|
| a 150 km in 10 hours | b 3000 revolutions in $1\frac{1}{2}$ minutes |
| c 15 swimming strokes in $\frac{1}{3}$ of a minute | d 56 metres in 4 seconds |
| e 180 mL in 22.5 hours | f 207 heart beats in $2\frac{1}{4}$ minutes |
- 6 Hamish rides his bike at an average speed of 22 km/h. How far does he ride in:
- | | | |
|-------------------------|------------------------|---------------|
| a $2\frac{1}{2}$ hours? | b $\frac{3}{4}$ hours? | c 15 minutes? |
|-------------------------|------------------------|---------------|

Example 14a



- 7 Determine the best buy (cheaper deal) in each of the following.
- | |
|--|
| a 2 kg of washing powder for \$11.70 or 3 kg for \$16.20 |
| b 1.5 kg of Red Delicious apples for \$4.80 or 2.2 kg of Royal Gala apples for \$7.92 |
| c 2.4 litres of orange juice for \$4.20 or 3 litres of orange juice for \$5.40 |
| d 0.7 GB of internet usage for \$14 or 1.5 GB for \$30.90 with different service providers |

Example 14b



- 8 Find the cost of 100 g of each product below then decide which is the best buy (cheaper deal).
- | |
|---|
| a 300 g of coffee A at \$10.80 or 220 g of coffee B at \$8.58 |
| b 600 g of pasta A for \$7.50 or 250 g of pasta B for \$2.35 |
| c 1.2 kg of cereal A for \$4.44 or 825 g of cereal B for \$3.30 |

PROBLEM-SOLVING

9, 10

10–12

12–15

- 9 Kirsty manages a restaurant. Each day she buys watermelons and mangoes in the ratio of 3 : 2. How many watermelons did she buy if, on one day, the total number of watermelons and mangoes was 200?
- 10 If a prize of \$6000 was divided among Georgia, Lianne and Maya in the ratio of 5 : 2 : 3, how much did each girl get?
- 11 When a crate of twenty 375 mL soft drink cans is purchased it works out to be \$1.68 per litre. If a crate of 30 of the same cans is advertised as being a saving of 10 cents per can compared with the 20-can crate, calculate how much the 30-can crate costs.



12 The dilution ratio for a particular chemical with water is 2 : 3 (chemical to water). If you have 72 litres of chemical, how much water is needed to dilute the chemical?



13 Julie is looking through the supermarket catalogue for her favourite cookies-and-cream ice-cream. The catalogue is advertising 2L of triple-chocolate ice-cream for \$6.30. The cookies-and-cream ice-cream is usually \$5.40 for 1.2L. What saving does there need to be on the price of the 1.2L container of cookies-and-cream ice-cream for it to be of equal value to the 2L triple-chocolate container?

14 The ratio of the side lengths of one square to another is 1 : 2. Find the ratio of the areas of the two squares.

15 A quadrilateral (with angle sum 360°) has interior angles in the ratio 1 : 2 : 3 : 4. Find the size of each angle.

REASONING

16

16, 17

17, 18

16 2.5 kg of cereal A costs \$4.80 and 1.5 kg of cereal B costs \$2.95. Write down at least two different methods for finding which cereal is the better buy (cheaper deal).

17 If $a : b$ is in simplest form, state whether the following are true or false.

a a and b must both be odd.

b a and b must both be prime.

c At least one of a or b is odd.

d The HCF of a and b is 1.

18 A ratio is $a : b$ with $a < b$ and a and b are positive integers. Write an expression for:

a the total number of parts

b the fraction of the smaller quantity out of the total

c the fraction of the larger quantity out of the total.

ENRICHMENT: Mixing drinks

–

–

19

19 Four jugs of cordial have a cordial to water ratio as shown in the table. The total volume is also shown.

Jug	Cordial to water ratio	Total volume
1	1 : 5	600 mL
2	2 : 7	900 mL
3	3 : 5	400 mL
4	2 : 9	330 mL

a How much cordial is in:

i jug 1?

ii jug 2?

b How much water is in:

i jug 3?

ii jug 4?

c Jugs 1 and 2 were mixed together to give 1500 mL of drink.

i How much cordial is in the drink?

ii Find the ratio of cordial to water in the drink.

d Find the ratio of cordial to water when the following jugs are mixed.

i jugs 1 and 3

ii jugs 2 and 3

iii jugs 2 and 4

iv jugs 3 and 4

e Which combination of two jugs gives the strongest cordial to water ratio?

1F Percentages and money CONSOLIDATING

LEARNING INTENTIONS

- To know how to convert between fractions or decimals and percentages
- To be able to express one quantity as a percentage of another quantity
- To be able to find a percentage of a quantity
- To be able to use division or the unitary method to find an original amount from a percentage of the amount

We use percentages for many different things in our daily lives. Some examples are loan rates, the interest rate on a term deposit and the percentage discount on purchases.

We know from our previous studies that a percentage is a number expressed out of 100. 'Per cent' comes from the Latin term *per centum* and means 'out of 100'.



Businesses convert fractions to percentages to make comparison easier, such as, for comparing the fractions of total profit made by each department or branch of a business.

Lesson starter: Which is the largest piece?

Four people receive the following portions of a cake:

- Milly 25.5%
- Tom $\frac{1}{4}$
- Adam 0.26
- Mai what's left

- Which person gets the most cake and why?
- How much cake does Mai get? What is her portion written as a percentage, a decimal and a fraction?

KEY IDEAS

- To express a number as a **percentage**, *multiply* by 100.
- To express a percentage as a **fraction** or **decimal**, *divide* by 100.
- A percentage of a number can be found using multiplication.
For example: 25% of \$26 = $0.25 \times \$26$ or $\frac{25}{100} \times \$26$
= \$6.50
- One quantity can be expressed as a percentage of another quantity by writing as a fraction using the same units and converting to a percentage.

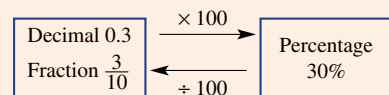

- To find an original amount, use the **unitary method** or use division.

For example: 3% of an amount is \$36.

- Using the unitary method: 1% of the amount is $\$36 \div 3 = \12
 \therefore 100% of the amount is $\$12 \times 100 = \1200
- Using division: 3% of the amount is \$36
 $0.03 \times \text{amount} = \36
 $\text{amount} = \$36 \div 0.03$
 $= \$1200$

BUILDING UNDERSTANDING

- 1 Divide these percentages by 100 to express them as fractions. For example, $9\% = \frac{9}{100}$.
Simplify where possible.
 a 3% b 11% c 35% d 8%
- 2 Divide these percentages by 100 to express them as decimals. For example, $9\% = 0.09$.
 a 4% b 23% c 86% d 46.3%
- 3 Express these simple decimals and fractions as percentages.
 a 0.5 b 0.25 c $\frac{3}{4}$ d $\frac{1}{5}$



Example 15 Converting between percentages, decimals and fractions

- a Express 0.45 as a percentage.
- b Express 25% as a decimal.
- c Express $3\frac{1}{4}\%$ as a fraction.

SOLUTION

- a $0.45 \times 100 = 45$
 $\therefore 0.45 = 45\%$
- b $25\% = 25 \div 100 = 0.25$
- c $3\frac{1}{4}\% = 3\frac{1}{4} \div 100$
 $= \frac{13}{4} \times \frac{1}{100}$
 $= \frac{13}{400}$

EXPLANATION

Multiply by 100. This moves the decimal point two places to the right.

Divide by 100. This moves the decimal point two places to the left.

Divide by 100.

Write the mixed numeral as an improper fraction and multiply by the reciprocal of 100 (i.e. $\frac{1}{100}$).

Now you try

- a Express 0.75 as a percentage.
- b Express 60% as a decimal.
- c Express $2\frac{3}{4}\%$ as a fraction.

**Example 16** Expressing one quantity as a percentage of another quantity

Express 50c as a percentage of \$2.50.

SOLUTION

$$\begin{aligned} 50\text{c out of } \$2.50 &= \frac{50}{250} \times 100\% \\ &= 20\% \end{aligned}$$

EXPLANATION

Convert to the same units (\$2.50 = 250c) and write as a fraction. Multiply by 100, cancelling first.

Now you try

Express 20c as a percentage of \$1.60.

**Example 17** Finding a percentage of a quantity

Find 15% of \$35.

SOLUTION

$$\begin{aligned} 15\% \text{ of } \$35 &= \frac{15}{100} \times \$35 \\ &= \$5.25 \end{aligned}$$

EXPLANATION

Write the percentage as a fraction out of 100 and multiply by \$35. This is the same as $0.15 \times \$35$. (Note: 'of' means to 'multiply'.)

Now you try

Find 35% of \$24.

**Example 18** Finding the original amount

Determine the original amount if 5% of the amount is \$45.

SOLUTION**Method 1: Unitary method**

5% of the amount = \$45
 1% of the amount = \$9
 100% of the amount = \$900
 So the original amount is \$900.

EXPLANATION

To use the unitary method, find the value of 1 part or 1% then multiply by 100 to find 100%.

Method 2: Division

$$\begin{aligned}
 5\% \text{ of the amount} &= \$45 \\
 0.05 \times \text{amount} &= \$45 \\
 \text{amount} &= \$45 \div 0.05 \\
 &= \$900
 \end{aligned}$$

So the original amount is \$900.

Write 5% as a decimal and set up an equation using multiplication for 'of'. Then divide both sides by 0.05 to find the original amount.

Now you try

Determine the original amount if 4% of the amount is \$12.

Exercise 1F**FLUENCY**

$1-3(\frac{1}{2}), 4, 5-7(\frac{1}{2})$

$1-3(\frac{1}{2}), 4, 5-7(\frac{1}{2})$

$1-3(\frac{1}{4}), 5-8(\frac{1}{3})$

Example 15a

1 Express each decimal as a percentage.

a 0.34

b 0.4

c 0.06

d 0.7

e 1

f 1.32

g 1.09

h 3.1

Example 15b

2 Express each percentage as a decimal.

a 67%

b 30%

c 250%

d 8%

e $4\frac{3}{4}\%$

f $10\frac{5}{8}\%$

g $30\frac{2}{5}\%$

h $44\frac{1}{4}\%$

Example 15c

3 Express each part of Question 2 as a simplified fraction.

4 Copy and complete these tables. Use the simplest form for fractions.

Percentage	Fraction	Decimal
10%		
	$\frac{1}{2}$	
5%		
		0.25
		0.2
	$\frac{1}{8}$	
1%		
	$\frac{1}{9}$	
		0.2

Percentage	Fraction	Decimal
	$\frac{3}{4}$	
15%		
		0.9
37.5%		
$33\frac{1}{3}\%$	$\frac{1}{3}$	
$66\frac{2}{3}\%$		
		0.625
	$\frac{1}{6}$	

Example 16

5 Convert each of the following to a percentage.

a \$3 out of \$12

b \$6 out of \$18

c \$0.40 out of \$2.50

d \$44 out of \$22

e \$140 out of \$5

f 45c out of \$1.80

Example 17 6 Find:



- a 10% of \$360
- b 50% of \$420
- c 75% of 64 kg
- d 12.5% of 240 km
- e 37.5% of 40 apples
- f 87.5% of 400 m
- g $33\frac{1}{3}\%$ of 750 people
- h $66\frac{2}{3}\%$ of 300 cars
- i $8\frac{3}{4}\%$ of \$560

Example 18 7 Determine the original amount when:

- a 10% of the amount is \$12
- b 6% of the amount is \$42
- c 3% of the amount is \$9
- d 40% of the amount is \$2.80
- e 90% of the amount is \$0.18
- f 35% of the amount is \$140



8 Determine the value of x in the following.

- a 10% of x is \$54
- b 15% of x is \$90
- c 25% of x is \$127
- d 18% of x is \$225
- e 105% of x is \$126
- f 110% of x is \$44

PROBLEM-SOLVING	9,10	10–12	12–14
-----------------	------	-------	-------

- 9 Bad weather stopped a cricket game for 35 minutes of a scheduled $3\frac{1}{2}$ hour match. What percentage of the scheduled time was lost?
- 10 Joe lost 4 kg and now weighs 60 kg. What percentage of his original weight did he lose?
- 11 About 80% of the mass of the human body is water. If Clare weighs 60 kg, how many kilograms of water make up her body weight?
- 12 In a class of 25 students, 40% have been to England. How many students have not been to England?
- 13 20% of the cross country runners in a school team weigh between 60 kg and 70 kg. If 4% of the school's 1125 students are in the cross country team, how many students in the team weigh between 60 and 70 kg?
- 14 One week Grace spent 16% of her weekly wage on a new bookshelf that cost \$184. What is her weekly wage?

REASONING	15	15	15, 16
-----------	----	----	--------

- 15 Consider the equation $P\%$ of $a = b$ (like 20% of $40 = 8$ or 150% of $22 = 33$).
 - a For what value of P is $P\%$ of $a = a$?
 - b For what values of P is $P\%$ of $a < a$?
 - c For what values of P is $P\%$ of $a > a$?

- 16 What can be said about the numbers x and y if:
 - a 10% of $x = 20\%$ of y ?
 - b 10% of $x = 50\%$ of y ?
 - c 5% of $x = 3\%$ of y ?
 - d 14% of $x = 5\%$ of y ?

ENRICHMENT: More than 100%	–	–	17
----------------------------	---	---	----



- 17 a Find 120% of 60.
- b Determine the value of x if 165% of x is 1.5.
- c Write 2.80 as a percentage.
- d Write 325% as a fraction.
- e An investment of \$2000 in a bank account increases to \$5000 over a period of time. By how much has the amount increased as a percentage?

1G Percentage increase and decrease CONSOLIDATING

LEARNING INTENTIONS

- To know how to increase or decrease an amount by a percentage using multiplication
- To understand that increasing and then decreasing by the same percentage does not return the original amount
- To be able to find the percentage change when a value increases or decreases
- To be able to find the percentage error in measurements
- To be able to find the original amount from the new amount after a percentage increase or decrease

Percentages are often used to describe by how much a quantity has increased or decreased. The price of a car in the new year might be increased by 5%. On a \$70 000 car, this equates to a \$3500 increase. The price of a shirt might be marked down by 30% and if the shirt originally cost \$60, this provides an \$18 discount. It is important to note that the increase or decrease is calculated on the original amount.

Lesson starter: The quicker method

Nicky and Mila consider this question: When \$250 is increased by 15%, what is the final amount?

Nicky puts his solution on the board with two steps.

$$\begin{aligned} \text{Step 1.} \quad 15\% \text{ of } \$250 &= 0.15 \times \$250 \\ &= \$37.50 \\ \text{Step 2.} \quad \text{Final amount} &= \$250 + \$37.50 \\ &= \$287.50 \end{aligned}$$

Mila says that the same problem can be solved with only one step using the number 1.15.

- Can you explain Mila's method? Write it down.
- What if the question was altered so that \$250 is decreased by 15%. How would Nicky and Mila's methods work in this case?
- Which of the two methods do you prefer and why?



Tourists often change money into another currency. A foreign exchange trader buys and sells money on the International Money Market. Up-to-date currency exchange rates and percentage increases and decreases are available online.

KEY IDEAS

- To increase an amount by a given percentage, multiply by 100% plus the given percentage.
For example: to increase by 30%, multiply by $100\% + 30\% = 130\% = 1.3$
- To decrease an amount by a given percentage, multiply by 100% minus the given percentage.
For example: to decrease by 25%, multiply by $100\% - 25\% = 75\% = 0.75$
- To find a **percentage change** or **absolute percentage difference** use

$$\text{Percentage change} = \frac{\text{change}}{\text{original amount}} \times 100\%$$

- **Percentage error** is calculated in the same way.

$$\% \text{Error} = \frac{\text{difference between measured value and theoretical value}}{\text{theoretical value}} \times 100\%$$

BUILDING UNDERSTANDING

- 1 State the missing number.
 - a To increase a number by 40% multiply by ____.
 - b Multiplying by 1.21 increases a number by ____.
 - c To decrease a number by 73% multiply by ____.
 - d Multiplying by 0.94 decreases a number by ____.
- 2 The price of a watch increases from \$120 to \$150.
 - a What is the price increase?
 - b Express this increase as a percentage of the original price.
- 3 A person's weight decreases from 108 kg to 96 kg.
 - a What is the weight decrease?
 - b Express this decrease as a percentage of the original weight. Round to one decimal place.

**Example 19 Increasing by a percentage**

Increase \$70 by 15%.

SOLUTION

$$\begin{aligned} 100\% + 15\% &= 115\% \\ &= 1.15 \\ \$70 \times 1.15 &= \$80.50 \end{aligned}$$

EXPLANATION

First add 15% to 100%.

Multiply by 1.15 to give \$70 plus the increase in one step.

Now you try

Increase \$40 by 25%.

**Example 20 Decreasing by a percentage**

Decrease \$5.20 by 40%.

SOLUTION

$$\begin{aligned} 100\% - 40\% &= 60\% \\ &= 0.6 \\ \$5.20 \times 0.6 &= \$3.12 \end{aligned}$$

EXPLANATION

First subtract the 40% from 100% to find the percentage remaining.

Multiply by 60% = 0.6 to get the result.

Now you try

Decrease \$6.80 by 30%.

**Example 21 Finding a percentage change**

- a** The price of a mobile phone increased from \$250 to \$280. Find the percentage increase.
b The population of a town decreases from 3220 to 2985. Find the percentage decrease and round to one decimal place.

SOLUTION

$$\begin{aligned} \mathbf{a} \text{ Increase} &= \$280 - \$250 \\ &= \$30 \end{aligned}$$

$$\begin{aligned} \text{Percentage increase} &= \frac{30}{250} \times \frac{100}{1}\% \\ &= 12\% \end{aligned}$$

$$\begin{aligned} \mathbf{b} \text{ Decrease} &= 3220 - 2985 \\ &= 235 \end{aligned}$$

$$\begin{aligned} \text{Percentage decrease} &= \frac{235}{3220} \times \frac{100}{1}\% \\ &= 7.3\% \text{ (to 1 d.p.)} \end{aligned}$$

EXPLANATION

First find the actual increase.

Divide the increase by the original amount and multiply by 100%.

First find the actual decrease.

Divide the decrease by the original population.
Round as indicated.

Now you try

- a** The price of a TV increased from \$300 to \$375. Find the percentage increase.
b The population of a town decreases from 6250 to 5500. Find the percentage decrease.

**Example 22 Finding the original amount**

After rain, the volume of water in a tank increased by 24% to 2200L. How much water was in the tank before it rained? Round to the nearest litre.

SOLUTION

$$\begin{aligned} 100\% + 24\% &= 124\% \\ &= 1.24 \end{aligned}$$

$$\begin{aligned} \text{Original volume} \times 1.24 &= 2200 \\ \therefore \text{Original volume} &= 2200 \div 1.24 \\ &= 1774 \text{ litres} \end{aligned}$$

EXPLANATION

Write the total percentage as a decimal.

The original volume is increased by 24% to give 2200 litres. Divide to find the original volume. Round as indicated.

Now you try

The area of a rectangular deck is increased by 32% to 300 m². What was the area of the original deck? Round to the nearest square metre.

Exercise 1G

FLUENCY

1–2(1/2), 3–5

1–2(1/2), 3, 5, 6

1–2(1/4), 4, 6, 7

- Example 19**
- 1 Increase the given amounts by the percentage given in the brackets.
- | | | | |
|------------------------|-------------------------|--------------------------|-------------------------|
| a \$50 (5%) | b 35 min (8%) | c 250 mL (50%) | d 1.6 m (15%) |
| e 24.5 kg (12%) | f 25 watts (44%) | g \$13 000 (4.5%) | h \$1200 (10.2%) |

- Example 20**
- 2 Decrease the given amounts by the percentage given in the brackets.
- | | | | |
|-----------------------|----------------------|---------------------|-----------------------|
| a 24 cm (20%) | b 35 cm (30%) | c 42 kg (7%) | d 55 min (12%) |
| e \$90 (12.8%) | f 220 mL (8%) | g 25°C (28%) | h \$420 (4.2%) |

- Example 21a**
- 3 The length of a bicycle sprint race is increased from 800 m to 1200 m. Find the percentage increase.

- 4 From the age of 10 to 17, Nick's height increased from 125 cm to 180 cm. Find the percentage increase.

- Example 21b**
- 5 The temperature at night decreased from 25°C to 18°C. Find the percentage decrease.

- 6 Brett, a rising sprint star, lowered his 100 m time from 13 seconds flat to 12.48 seconds. Find the percentage decrease.

- 7 Find the percentage change in these situations, rounding to one decimal place in each case.

- | | |
|------------------------------------|---------------------------------------|
| a 22 g increases to 27 g | b 86°C increases to 109°C |
| c 136 km decreases to 94 km | d \$85.90 decreases to \$52.90 |

PROBLEM-SOLVING

8–10

8–11

9–13

- Example 22**
- 8 After a price increase of 20% the cost of entry to a museum rose to \$25.80. Find the original entry fee.

- 9 The average attendance at a sporting match rose by 8% in the past year to 32 473. Find the average attendance in the previous year to the nearest integer.

- 10 A car when resold had decreased in value by 38% to \$9235. What was the original price of the car to the nearest dollar?

- 11 Calculate the % error of these experimental measures compared to the theoretical measures.

	Experimental	Theoretical
a	22 cm	20 cm
b	4.5 L	4 L
c	1.05 sec	1.25 sec
d	58 m ²	64 m ²



- 12 The total price of an item including GST (at 10%) is \$120. How much GST is paid to the nearest cent?

- 13 A consultant charges a school a fee of \$300 per hour including GST (at 10%). The school hires the consultant for 2 hours but can claim back the GST from the tax office. Find the net cost of the consultant for the school to the nearest cent.

REASONING

14

14, 15

15–17

- 14 An investor starts with \$1000.
- After a bad day the initial investment is reduced by 10%. Find the balance at the end of the day.
 - The next day is better and the balance is increased by 10%. Find the balance at the end of the second day.
 - The initial amount decreased by 10% on the first day and increased by 10% on the second day. Explain why the balance on the second day didn't return to \$1000.
- 15 During a sale, all travel guides in a bookstore are reduced from \$30 by 20%. What percentage increase is required to take the price back to \$30?
- 16 The cost of an item is reduced by 50%. What percentage increase is required to return to its original price?
- 17 The cost of an item is increased by 75%. What percentage decrease is required to return to its original price? Round to two decimal places.

ENRICHMENT: Repeated increase and decrease

–

–

18, 19

- 18 If the cost of a pair of shoes was increased three times by 10%, 15% and 8% from an original price of \$80, then the final price would be

$$\$80 \times 1.10 \times 1.15 \times 1.08 = \$109.30$$

Use a similar technique to find the final price of these items. Round the answer to the nearest cent.

- Skis starting at \$450 and increasing by 20%, 10% and 7%
- A computer starting at \$2750 and increasing by 6%, 11% and 4%
- A smart watch starting at \$280 and decreasing by 10%, 25% and 20%
- A circular saw starting at \$119 and increasing by 18%, 37% and 11%







- 19 If an amount is increased by the same percentage each time, powers can be used.

For example, 50 kg increased by 12% three times would increase to

$$\begin{aligned} 50 \text{ kg} \times 1.12 \times 1.12 \times 1.12 \\ = 50 \text{ kg} \times (1.12)^3 \\ = 70.25 \text{ kg (to 2 d.p.)} \end{aligned}$$

Use a similar technique to find the final value in these situations. Round the answer to two decimal places.

- A rat with an initial mass of 60 grams grows at a rate of 10% every month for 3 months.
- The cost of a new lawnmower with an initial cost of \$80 000 increases by 5% every year for 4 years.
- The value of a house initially at \$380 000 decreases by 4% per year for 3 years.
- As a result of being sharpened, the length of a pencil initially 16 cm long decreases by 15% each week for 5 weeks.

- 1A** 1 Evaluate the following.
a $-45 + (-3 \times 6 + 9)$ **b** $-4 \times 8 \div (-2) - 2^3$
- 1B** 2 Round each of these numbers as indicated in the brackets.
a 3.45678 (2 decimal places) **b** 45.89985 (1 decimal place)
c 0.007856473 (2 significant figures) **d** 46 789 000 (3 significant figures)
- 1C** 3 Write these fractions as decimals.
a $\frac{3}{4}$ **b** $\frac{4}{5}$ **c** $\frac{7}{20}$ **d** $\frac{1}{3}$
- 1C** 4 Write these decimals as fractions.
a 0.9 **b** 0.85 **c** 0.125
- 1D** 5 Evaluate the following.
a $\frac{1}{2} + \frac{5}{6}$ **b** $\frac{6}{7} - \frac{2}{3}$ **c** $1\frac{1}{2} \times \frac{4}{5}$ **d** $\frac{5}{8} \div \frac{3}{10}$
- 1E** 6 Simplify these ratios.
a 45 : 81 **b** \$24 to 80 cents **c** 2.4 : 0.36 **d** $\frac{3}{4} : 8$
- 1E** 7 Divide:
a \$400 in the ratio of 5 : 3
b 6 kg in the ratio of 3 : 7
c 1000 cm in the ratio of 4 : 5 : 6
- 1E** 8 Write these rates in simplest form.
a \$350 in 5 hours
b 200 km in 2.5 hours
- 1E** 9 Which is the best buy (cheaper deal)?
 Product A, which costs \$3.45 for 500 grams, or product B, which costs \$4.38 for 680 grams.
-  **1F** 10 Write the following as percentages.
a $\frac{4}{5}$ **b** 0.96 **c** $3\frac{3}{4}$ **d** 40 cents of \$5
- 1F** 11 Find 34% of 6000 cm.
- 1F** 12 Determine the original amount if 8% of the amount is \$32.
- 1G** 13 **a** Increase \$450 by 12%.
b Decrease 500 kg by 5%.
-  **1G** 14 Find the percentage change if 40 g is reduced to 24 g.
-  **1G** 15 The volume of a tank is increased by 12% to 952 L. Find the original volume.
- 

1H Profits and discounts

LEARNING INTENTIONS

- To know the meaning of the key terms profit, discount, mark-up and selling price
- To be able to apply percentages to calculate the selling price based on discounts and mark-ups
- To be able to determine the percentage profit or loss made on a sale

Percentages are widely used in the world of finance. Profits, losses, commissions, discounts and taxation are often expressed and calculated using percentages.

Lesson starter: The best discount

Two adjacent shops are selling the same jacket at a discounted price. The recommended retail price for the jacket is the same for both shops. Each shop has a sign near the jacket with the given details:

- Shop A: Discounted by 25%
- Shop B: Reduced by 20% then take a further 10% off that discounted price.

Which shop offers the bigger discount?

Is the difference between the discounts equal to 5% of the retail price?

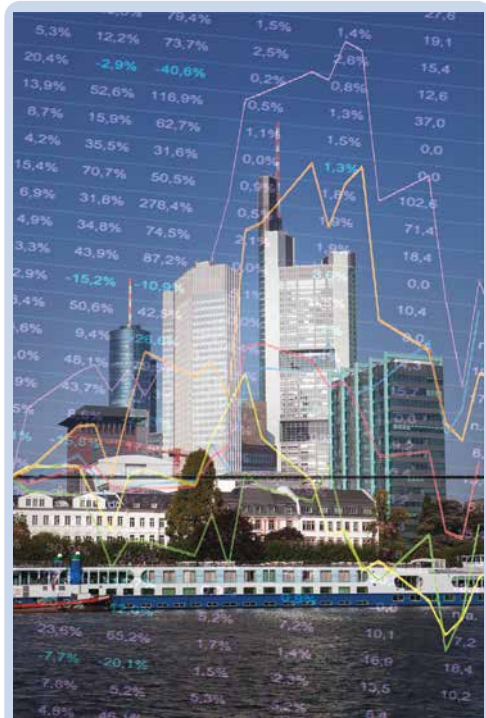

Percentages are used by businesses to describe profits and losses.

KEY IDEAS

- **Profit** is the amount of money made on a sale. If the profit is negative we say that a loss has been made.
 - Profit = selling price – cost price
- **Mark-up** is the amount added to the cost price to produce the selling price.
 - Selling price = cost price + mark-up
- The **percentage profit** or loss can be found by dividing the profit or loss by the cost price and multiplying by 100.
 - % Profit or loss = $\frac{\text{profit or loss}}{\text{cost price}} \times 100\%$
- **Discount** is the amount by which an item is marked down.
 - New price = original price – discount
 - Discount = % discount \times original price

BUILDING UNDERSTANDING

- 1 State the missing numbers in the table.

Cost price (\$)	7	18		3250
Selling price (\$)	10	15.50	11.80	
Profit/Loss (\$)			4.50 profit	1180 loss

- 2 The following percentage discounts are given on the price of various products. State the sale price as a percentage of the original price.

a 10%

b 15%



Example 23 Determining profit

A manufacturer produces an item for \$400 and sells it for \$540.

- a Determine the profit made.
b Express this profit as a percentage of the cost price.

SOLUTION

$$\begin{aligned} \text{a Profit} &= \$540 - \$400 \\ &= \$140 \end{aligned}$$

$$\begin{aligned} \text{b \% profit} &= \frac{140}{400} \times 100\% \\ &= 35\% \end{aligned}$$

EXPLANATION

Profit = selling price – cost price

$$\% \text{ profit} = \frac{\text{profit}}{\text{cost price}} \times 100\%$$

Now you try

A manufacturer produces an item for \$320 and sells it for \$464.

- a Determine the profit made.
b Express this profit as a percentage of the cost price.





Example 24 Calculating selling price from mark-up

An electrical store marks up all entertainment systems by 30%.
If the cost price of an entertainment system is \$8000, what will be its selling price?

SOLUTION

$$\begin{aligned}\text{Selling price} &= 130\% \text{ of cost price} \\ &= 1.3 \times \$8000 \\ &= \$10\,400\end{aligned}$$

Alternative method:

$$\begin{aligned}\text{Mark-up} &= 30\% \text{ of } \$8000 \\ &= 0.3 \times \$8000 \\ &= \$2400\end{aligned}$$

$$\begin{aligned}\therefore \text{selling price} &= \$8000 + \$2400 \\ &= \$10\,400\end{aligned}$$

EXPLANATION

As there is a 30% mark-up added to the cost price (100%), it follows that the selling price is 130% of the cost price.

Change percentage to a decimal and evaluate.

Selling price = cost price + mark-up.

Now you try

A nursery marks up all plants by 40%.
If the cost price of a plant is \$12, what will be its selling price?



Example 25 Finding the discount amount

An electronics shop advertises a 15% discount on all audio-visual equipment as a Christmas special. Find the sale price on a projection system that has a marked price of \$18000.

SOLUTION

$$\begin{aligned}\text{New price} &= 85\% \text{ of } \$18\,000 \\ &= 0.85 \times \$18\,000 \\ &= \$15\,300\end{aligned}$$

Alternative method:

$$\begin{aligned}\text{Discount} &= 15\% \text{ of } \$18\,000 \\ &= 0.15 \times \$18\,000 \\ &= \$2700\end{aligned}$$

$$\begin{aligned}\therefore \text{new price} &= \$18\,000 - \$2700 \\ &= \$15\,300\end{aligned}$$

EXPLANATION

Discounting by 15% means the new price is 85%, i.e. (100 – 15)%, of the original price.

Change the percentage to a decimal and evaluate.

New price is original price minus discount.

Now you try

A shop has items discounted by 16% for its Easter sale. Find the sale price if an item was marked at \$204.

**Example 26 Calculating the original price after discount**

A toy shop discounts a toy by 10% in a sale. If the sale price was \$10.80, what was the original price?

SOLUTION

Let x be the original price.

$$0.9 \times x = 10.8$$

$$x = 10.8 \div 0.9$$

$$x = 12$$

The original price was \$12.

EXPLANATION

The percentage discount = $100\% - 10\% = 90\% = 0.9$.

Thus \$10.80 is 90% of the original price. Write an equation representing this and solve.

Write the answer in words.

Now you try

A car is discounted by 20%. If the sale price was \$32 000 what was the original price?

Exercise 1H**FLUENCY**

1–5, 8, 10

1, 2($\frac{1}{2}$), 3–6, 8–11

3–5, 7, 9, 11

Example 23



1 A shop buys an item for \$500 and sells it for \$575.

- a Determine the profit made.
b Express this profit as a percentage of the cost price.



2 A manufacturer produces and sells items for the prices shown.

- i Determine the profit made.
ii Express this profit as a percentage of the cost price.
- a Cost price \$10, selling price \$12 b Cost price \$20, selling price \$25
c Cost price \$120, selling price \$136.80 d Cost price \$1400, selling price \$3850



3 Dom runs a pizza business. Last year he took in \$88 000 and it cost him \$33 000 to run the business. What is his percentage profit for the year? Round to two decimal places.



4 It used to take 20 hours to fly to Los Angeles. It now takes 12 hours. What is the percentage decrease in travel time?

Example 24



5 Helen owns a handicrafts store that has a policy of marking up all of its items by 25%. If the cost price of one article is \$30, what will be its selling price?



6 Lenny marks up all computers in his store by 12.5%. If a computer cost him \$890, what will be the selling price of the computer, to the nearest cent?



7 A used-car dealer purchases a vehicle for \$13 000 and sells it for \$18 500. Determine the percentage mark-up on the vehicle to one decimal place.

Example 25



8 A store is offering a 15% discount for customers who pay with cash. Rada wants a microwave oven marked at \$175. How much will she pay if she is paying with cash?

-  9 A camera store displays a camera marked at \$595 and a lens marked at \$380. Sam is offered a discount of 22% if he buys both items. How much will he pay for the camera and lens?

Example 26



- 10 A refrigerator is discounted by 25%. If Paula pays \$460 for it, what was the original price? Round to the nearest cent.
- 11 A membership for a football team is discounted by 15% during a season. If the new price was \$187, what was the original cost?

PROBLEM-SOLVING

12

12, 13

13, 14



-  12 A store marks up a \$550 widescreen television by 30%. During a sale it is discounted by 20%. What is the percentage change in the original price of the television?
-  13 An armchair was purchased for a cost price of \$380 and marked up to a retail price. It was then discounted by 10% to a sale price of \$427.50. What is the percentage mark-up from the cost price to the sale price?
-  14 Pairs of shoes are manufactured for \$24. They are sold to a warehouse with a mark-up of 15%. The warehouse sells the shoes to a distributor after charging a holding fee of \$10 per pair. The distributor sells them to 'Fine Shoes' for a percentage profit of 12%. The store then marks them up by 30%.
- Determine the price of a pair of shoes if you buy it from one of the 'Fine Shoes' stores (round to the nearest 5 cents).
 - What is the overall percentage mark-up of a pair of shoes to the nearest whole per cent?

REASONING

15

15, 16

16, 17

-  15 The price of an item to be sold includes a percentage mark-up as well as a sale discount. Does it make a difference in which order the mark-up and discount occur? Explain your answer.
-  16 Depreciation relates to a reduction in value. A computer depreciates in value by 30% in its first year. If its original value is \$3000, find its value after one year.
-  17 John buys a car for \$75 000. The value of the car depreciates at 15% per year. After 1 year the car is worth 85% of its original value, i.e. 85% of $\$75\,000 = 0.85 \times 75\,000 = \$63\,750$.
- What is the value of the car, to the nearest cent, after:
 - 2 years?
 - 5 years?
 - After how many years will the car first be worth less than \$15 000?

ENRICHMENT: Deposits and discounts

–

–

18

- 18 A car company offers a special discount deal. After the cash deposit is paid, the amount that remains to be paid is discounted by a percentage that is one tenth of the deposit percentage. For example, a deposit of \$8000 on a \$40 000 car represents 20% of the cost. The remaining \$32 000 will be discounted by 2%.

Find the amount paid for each car given the following car price and deposit. Round to two decimal places where necessary.

- | | |
|--------------------------------------|--|
| a Price = \$35 000, deposit = \$7000 | b Price = \$45 000, deposit = \$15 000 |
| c Price = \$28 000, deposit = \$3500 | d Price = \$33 400, deposit = \$5344 |
| e Price = \$62 500, deposit = \$5000 | f Price = \$72 500, deposit = \$10 150 |

11 Income

LEARNING INTENTIONS

- To understand the different ways in which income can be earned
- To be able to calculate income based on wages, overtime, salaries and commission
- To know the difference between gross and net income
- To understand that employees pay tax and to be able to calculate tax based on a person's income

Most people's income is made up largely of the money they receive from their paid work – their job. Depending on the job, this payment can be made using a number of different methods. Many professional workers will receive an annual fixed *salary* which may be paid monthly or fortnightly. Casual workers, including those working in the retail area or restaurants, may receive a *wage* where they are paid a rate per hour worked. This rate may be higher out of regular working hours such as weekends or public holidays. Many sales people, including some real estate agents, may receive a weekly fee (a *retainer*) but may also receive a set percentage of the amount of sales they make (a *commission*). From their income, people have to pay living costs such as electricity, rent, groceries and other items. In addition, they have to pay tax to the government, which funds many of the nation's infrastructure projects and welfare. The method in which this tax is paid from their income may also vary.



A laboratory technician might receive a 1% pay rise giving her a \$600 p.a. increase in gross pay. This amount is then decreased by 32.5% tax, giving the technician a net pay increase of \$405 p.a.

Lesson starter: Which job pays better?

Ben and Nick are both looking for part-time work and they spot the following advertisements.

Kitchen hand

\$9.40 per hour, \$14.10 per hour on weekends.

Office assistant

Receive \$516 per month for 12 hours work per week.

- Nick gets the job as the kitchen hand. In his first week he works 4 hours during the week and 8 hours at the weekend. How much did he earn?
- Ben gets the job as the office assistant. How much does he earn per week if he works 4 weeks in a month? What does his hourly rate turn out to be?
- If Nick continues to work 12 hours in a week, does he earn more than Ben if he only works on week days? How many weekday hours must Nick work to match Ben's pay?
- Out of the 12 hours, what is the minimum number of hours Nick must work at the weekend to earn at least as much as Ben?

KEY IDEAS

- Workers who earn a **wage** (for example, a casual waiter) are paid a fixed rate per hour. Hours outside the normal working hours (public holidays etc.) are paid at a higher rate called **overtime**. This can occur in a couple of common ways:
 - **Time and a half:** pay is 1.5 times the usual hourly rate
 - **Double time:** pay is twice the usual hourly rate
- Workers who earn a **salary** (for example, an engineer) are paid a fixed amount per year, say \$95 000. This is often paid monthly or fortnightly.
 - 12 months in a year and approximately 52 weeks in a year = 26 fortnights
- Some wage and salary earners are paid **leave loading**. When they are on holidays, they earn their normal pay plus a bonus called leave loading. This is usually 17.5% of their normal pay.

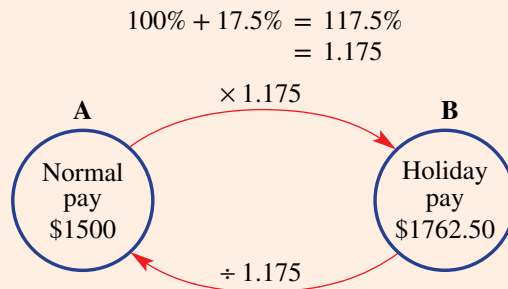

$$\text{Leave loading} = 17.5\% \text{ of A} = \$262.50$$

- Some people are paid according to the number of items they produce. This is called **piecework**.
- **Commission** is a proportion of the overall sales amount. Salespeople may receive a commission of their sales as well as a set weekly or monthly fee called a **retainer**.
 - $\text{commission} = \% \text{commission} \times \text{total sales}$
- **Royalties:** Some people who write books or music are paid **royalties**, which could be 10% of the sale price of every book or song which is sold.

BUILDING UNDERSTANDING

- 1 A young employee has an annual salary of \$47 424 and works 38-hour weeks. Find the average earnings:
 - a per month
 - b per week
 - c per hour.
- 2 A shop assistant is paid \$11.40 per hour. Calculate their earnings for the following hours worked.
 - a 7 hours
 - b 5.5 hours
 - c 4 hours at twice the hourly rate (double time)
 - d 6 hours at 1.5 times the hourly rate (time and a half)
- 3 Find the commission earned on the given sales if the percentage commission is 20%.
 - a \$1000
 - b \$4500



Example 27 Comparing wages and salaries

Ken earns an annual salary of \$88 450 and works a 38-hour week. His wife Brooke works part time in retail and earns \$53.20 per hour.

- Calculate how much Ken earns per week.
- Determine who has the higher hourly rate of pay.
- If Brooke works on average 18 hours per week, what is her yearly income?

SOLUTION

$$\begin{aligned} \text{a Weekly rate} &= \$88\,450 \div 52 \\ &= \$1700.96 \\ \therefore \text{Ken earns } &\$1700.96 \text{ per week} \end{aligned}$$

$$\begin{aligned} \text{b Brooke: } &\$53.20 \text{ per hour} \\ \text{Ken: } &\$1700.96 \div 38 \\ &= \$44.76 \text{ per hour} \\ \therefore \text{Brooke is paid more per hour.} \end{aligned}$$

$$\begin{aligned} \text{c Weekly income} &= \$53.20 \times 18 \\ &= \$957.60 \\ \text{Yearly income} &= \$957.60 \times 52 \\ &= \$49\,795.20 \end{aligned}$$

EXPLANATION

\$88 450 pay in a year.
There are approximately 52 weeks in a year.

Ken works 38 hours in week.
Hourly rate = weekly rate \div number of hours.
Round to the nearest cent.
Compare hourly rates.

Weekly income = hourly rate \times number of hours.

Multiply by 52 weeks to get yearly income.

Now you try

Maria earns an annual salary of \$124 500 and works a 40-hour week. Her husband Gary works part time in catering and earns \$64.50 per hour.

- Calculate how much Maria earns per week.
- Determine who has the higher hourly rate of pay.
- If Gary works an average of 20 hours per week, what is his yearly income?





Example 28 Calculating overtime

Georgie works some weekends and late nights in addition to normal working hours and has overtime pay arrangements with her employer.

- Calculate how much Georgie earns in one week if she works 16 hours during the week at the normal hourly rate of \$18.50 and 6 hours on the weekend at time and a half.
- Georgie's normal hourly rate is changed. In a week she works 9 hours at the normal rate, 4 hours at time and a half and 5 hours at double time. If she earns \$507.50, what is her new normal hourly rate?

SOLUTION

$$\begin{aligned}
 \text{a Earnings at normal rate} &= 16 \times \$18.50 \\
 &= \$296 \\
 \text{Earnings at time and a half} &= 6 \times 1.5 \times \$18.50 \\
 &= \$166.50 \\
 \text{Total earnings} &= \$296 + \$166.50 \\
 &= \$462.50
 \end{aligned}$$

$$\begin{aligned}
 \text{b Equivalent hours worked in the week} &= 9 + (4 \times 1.5) + (5 \times 2) \\
 &= 9 + 6 + 10 \\
 &= 25 \text{ hours}
 \end{aligned}$$

$$\begin{aligned}
 \text{Normal hourly rate} &= \$507.50 \div 25 \\
 &= \$20.30
 \end{aligned}$$

EXPLANATION

16 hours at standard rate

Time and half is 1.5 times the normal rate.

Combine earnings.

Calculate the number of equivalent hours worked. 4 hours at time and a half is the same pay as for working 6 hours (4×1.5). 5 hours at double time is the same as working 10 hours (5×2).

Divide weekly earnings by the 25 equivalent hours worked.

Now you try

Matt works some weekends and nights in addition to normal working hours and has overtime pay arrangements with his employee.

- Calculate how much Matt earns in one week if he works 20 hours at the normal hourly rate of \$15.20, and 5 hours at time and a half.
- Matt's normal hourly rate is changed. In a week he works 10 hours at the normal rate, 4 hours at time and a half and 2 hours at double time. If he earns \$330 in a week, what is his new normal hourly rate?

**Example 29** Calculating commission and piecework

- a** A saleswoman is paid a retainer of \$1500 per month. She also receives a commission of 1.25% on the value of goods she sells. If she sells goods worth \$5600 during the month, calculate her earnings for that month.
- b** David is paid for picking fruit. He is paid \$35 for every bin he fills. Last week he worked 8 hours per day for 6 days and filled 20 bins. Calculate his hourly rate of pay.

SOLUTION

$$\begin{aligned}\text{a Commission} &= 1.25\% \text{ of } \$5600 \\ &= 0.0125 \times \$5600 \\ &= \$70\end{aligned}$$

$$\begin{aligned}\text{Earnings} &= \$1500 + \$70 \\ &= \$1570\end{aligned}$$

$$\begin{aligned}\text{b } \$35 \times 20 &= \$700 \\ 8 \times 6 &= 48 \text{ hours} \\ \$700 \div 48 &= \$14.58 \text{ (to 2 d.p.)}\end{aligned}$$

EXPLANATION

Calculate the commission on sales. Change the percentage to a decimal and evaluate.

Earnings = retainer + commission

This is David's pay for the week: 20 bins at \$35 each.

This is David's hourly rate.

Now you try

- a** A salesman is paid a retainer of \$1250 per month. He also receives a commission of 1.1% on the value of the goods he sells. If he sells goods worth \$4500 during the month, calculate his earnings for that month.
- b** Toby gets paid for walking dogs. He is paid \$10 per dog walk. Last week he worked 2 hours walking dogs per day for 5 days and walked 20 dogs. Calculate his hourly rate of pay.

Exercise 11**FLUENCY**

1–5, 7, 9

1, 2, 3–4(1/2), 5, 7, 9

4(1/2), 6, 8, 9, 10

Example 27



- 1** Georgia earns an annual salary of \$95 000 and works a 40-hour week. Her husband Mike works part time and earns \$45.20 per hour.
- a** Calculate how much Georgia earns per week.
- b** Determine who has the higher hourly rate of pay.
- c** If Mike works on average 16 hours per week, what is his yearly income?



- 2 a** Calculate the hourly rate of pay for a 38-hour working week with an annual salary of:
- i** \$38 532 **ii** \$53 352 **iii** \$83 980
- b** Calculate the yearly income for someone who earns \$24.20 per hour and in a week works, on average:
- i** 24 hours **ii** 35 hours **iii** 16 hours

Example 28a 3 A job has a normal working hours pay rate of \$18.40 per hour. Calculate the pay, including overtime, for the following hours worked.



- a 3 hours and 4 hours at time and a half
- b 4 hours and 6 hours at time and a half
- c 14 hours and 3 hours at double time
- d 20 hours and 5 hours at double time
- e 10 hours and 8 hours at time and a half and 3 hours at double time
- f 34 hours and 4 hours at time and a half and 2 hours at double time



4 Calculate how many hours at the standard hourly rate the following working hours are equivalent to:

- a 3 hours and 2 hours at double time
- b 6 hours and 8 hours at time and a half
- c 15 hours and 12 hours at time and a half
- d 10 hours time and a half and 5 hours at double time
- e 20 hours and 6 hours at time and a half and 4 hours at double time
- f 32 hours and 4 hours at time and a half and 1 hour at double time

Example 28b 5 Jim, a part-time gardener, earned \$261 in a week in which he worked 12 hours during normal working hours and 4 hours overtime at time and a half. What was his hourly rate of pay?



6 Sally earned \$329.40 in a week in which she worked 10 hours during the week and 6 hours on Saturday at time and a half and 4 hours on Sunday at double time. What was her hourly rate of pay?

Example 29a 7 Amy works at Best Bookshop. During one week she sells books valued at \$800. If she earns \$450 per week plus 5% commission, how much does she earn in this week?



8 Jason works for an alarm system company and earns \$650 per month plus 4% commission on sales. How much does he earn in a month in which he sells \$84000 worth of alarm systems?



Example 29b

- 9 Mike delivers the local newspaper. He is paid \$30 to deliver 500 newspapers. How much is he paid for each one?
- 10 Lily is paid for raking leaves. She is paid \$10 for every bag she fills. Last week she worked for 6 hours and filled 15 bags. Calculate her hourly rate of pay.



PROBLEM-SOLVING

11, 12

12–14

13–16

- 11 Arrange the following workers in order of most to least earned in a week of work.
- Adam has an annual salary of \$33 384.
 - Bill works for 26 hours at a rate of \$22.70 per hour.
 - Cate earns \$2964 per month. (Assume 52 weeks in a year.)
 - Diana does shift work 4 days of the week between 10 p.m. and 4 a.m. She earns \$19.90 per hour before midnight and \$27.50 per hour after midnight.
 - Ed works 18 hours at the normal rate of \$18.20 per hour, 6 hours at time and a half and 4 hours at double time in a week.
- 12 Stephen earns an hourly rate of \$17.30 for the first 38 hours he works, time and a half for the next 3 hours and double time for each extra hour above that. Calculate his earnings if he works 44 hours in a week.
- 13 Jessica works for Woods Real Estate and earns \$800 per week plus 0.05% commission. If this week she sold three houses valued at \$334 000, \$210 000 and \$335 500 respectively, how much will she have earned?
- 14 A door-to-door salesman sells 10 security systems in one week at \$1200 each. For the week, he earns a total of \$850 including a retainer of \$300 and a commission. Find his percentage commission correct to two decimal places.
- 15 Mel is taking her holidays. She receives \$2937.50. This includes her normal pay and 17.5% leave loading. How much is the leave loading?



REASONING

17

17, 18

18, 19

- 16 Karl is saving and wants to earn \$90 from a casual job paying \$7.50 per hour.
- How many hours must he work to earn the \$90?
 - Karl can also work some hours where he is paid time and a half. He decides to work x hours at the normal rate and y hours at time and a half to earn the \$90. If x and y are both positive integers, find the possible combinations for x and y .
- 17 A car salesman earns 2% commission on sales up to \$60 000 and 2.5% on sales above that.
- Determine the amount earned on sales worth:

i \$46 000	ii \$72 000
------------	-------------
 - Write a rule for the amount, A dollars, earned on sales of \$ x if:

i $x \leq 60\,000$	ii $x > 60\,000$
--------------------	------------------



18 Kim has a job selling jewellery. She has to choose one of two new payment plans below.

Plan A: \$220 per week plus 5% of sales

Plan B: 9% of sales and no set weekly retainer

- What value of sales gives the same return from each plan?
- Explain how you would choose between Plan A and Plan B.

ENRICHMENT: Payslips and superannuation

–

–

20

19 The following payslip is given at the end of every fortnight to a part-time teacher who is employed for 3 days per week (6 days per fortnight).

PAYSリップ			
EMPLOYER: ABC School			
EMPLOYEE: J. Bloggs			
Fortnight ending: 17/06/2012		AWARD:	Teachers
EARNINGS	QUANTITY	RATE	AMOUNT
Ordinary pay	6.00	339.542307	\$2037.25
DEDUCTIONS	AMOUNT	DETAILS	
Tax	\$562.00		
PROVISIONS	EARNED	TAKEN	BALANCE
Superannuation	\$183.35	0.00	\$2756.02
SUMMARY			
PAY DATE	17/06/2012	Year to date	
GROSS	\$2037.25	\$30766.42	
TAX	\$562.00	\$8312.00	
DEDUCTIONS	\$0.00	\$0.00	
NET	\$1475.25	\$22454.42	

- Use the internet to research and answer parts i–iv.
 - Find the meaning of the word ‘superannuation’.
 - Why is superannuation compulsory for all workers in Australia?
 - What percentage of gross income is compulsory superannuation?
 - What happens to the superannuation that is paid to employees?
- This employee earned \$2037.25 (before tax) plus \$183.35 superannuation. Was this the correct amount of superannuation?
- According to the ‘year to date’ figures, how much tax has been paid?
- Using the ‘year to date’ figures, express the tax paid as a percentage of the gross income.
- Complete this sentence: For this worker, approximately _____ cents in every dollar goes to the Australian Taxation Office.

1J The PAYG income tax system

LEARNING INTENTIONS

- To understand how the PAYG taxation system works
- To be able to interpret a tax table
- To be able to determine a person's tax amount given their total annual income

The Australian Taxation Office (ATO) collects taxes on behalf of the government to pay for education, hospitals, roads, railways, airports and services such as the police and fire brigades.

In Australia, the financial year runs from 1 July to 30 June the following year. People engaged in paid employment are normally paid weekly or fortnightly. Most of them pay some income tax every time they are paid for their work. This is known as the Pay-As-You-Go (PAYG) system.



At the end of the financial year (30 June), workers complete an income tax return to determine if they have paid the correct amount of income tax during the year. If they have paid too much, they will receive a tax refund. If they have not paid enough, they will be required to pay more tax.

The rates of tax that are paid depend on your income and these are subject to change depending on government policy.

Lesson starter: The ATO website

The ATO (Australian taxation office) website has some income tax calculators. Use one to find out how much income tax you would need to pay if your taxable income is:

- \$5200 per annum (\$100 per week)
- \$26 000 per annum (\$500 per week)
- \$78 000 per annum (\$1500 per week).

Does a person earning \$1000 per week pay twice as much tax as a person earning \$500 per week?

Does a person earning \$2000 per week pay twice as much tax as a person earning \$1000 per week?

KEY IDEAS

- At the end of a financial year (July 1 – June 30) individuals complete a **tax return** form which includes the following:
 - *all* forms of income, including interest from investments.
 - legitimate **tax deductions** shown on receipts and invoices, such as work-related expenses and donations.
- **Taxable income** is calculated using the formula:
Taxable income = gross income – tax deductions
- The ATO website includes tables and calculators, such as the following table. Each row in the table is called a tax bracket. These are the personal income tax rates from July 2024 and are subject to change.

Taxable income	Tax on income
\$0 – \$18 200	Nil
\$18 201 – \$45 000	19c for each \$1 over \$18 200
\$45 001 – \$200 000	\$5092 plus 30c for each \$1 over \$45 000
\$200 001 and over	\$51 592 plus 45c for each \$1 over \$200 000

- Individuals may also need to pay the **Medicare levy**. This is a scheme in which all Australian taxpayers share in the cost of running the medical system. In the 2023–2024 financial year, it was 2% of taxable income.
- It is possible that you may have paid too much tax during the year and will receive a **tax refund**.
- It is also possible that you may have paid too little tax and will receive a letter from the ATO asking for the **tax liability** to be paid.

BUILDING UNDERSTANDING

- 1 Complete this statement:
Taxable income = _____ income minus _____.
- 2 Is the following statement true or false?
The highest income earners in Australia pay 45 cents tax for every dollar they earn.
- 3 In the financial year, Greg paid no income tax. What could his taxable income have been?
- 4 Ann's taxable income was \$87 000, and Ben's taxable income was \$87 001. Ignoring the Medicare levy, how much more tax does Ben pay than Ann?



Example 30 Calculating tax

Richard earned \$1050 per week (\$54 600 per annum) from his employer and other sources such as interest on investments. He has receipts for \$375 for work-related expenses and donations.

- Calculate Richard's taxable income.
- Use this tax table to calculate Richard's tax payable.

Taxable income	Tax on income
\$0 – \$18 200	Nil
\$18 201 – \$45 000	19c for each \$1 over \$18 200
\$45 001 – \$200 000	\$5092 plus 30c for each \$1 over \$45 000
\$200 001 and over	\$51 592 plus 45c for each \$1 over \$200 000

- Richard also needs to pay the Medicare levy of 2% of his taxable income. How much is the Medicare levy?
- Add the tax payable and the Medicare levy.
- Express the total tax in part **d** as a percentage of Richard's taxable income.
- During the financial year, Richard's employer sent a total of \$7797 in tax to the ATO. Has Richard paid too much tax, or not enough? Calculate her refund or liability.

SOLUTION

- Gross income = \$54 600
Deductions = \$375
Taxable income = \$54 225
- Tax Payable:
 $\$5092 + 0.3 \times (\$54\,225 - \$45\,000)$
= \$7859.50
- $\frac{2}{100} \times \$54\,225 = \1084.50
- $\$7859.50 + \$1084.50 = \$8944$
- $\frac{8944}{54\,225} \times 100\% = 16.5\%$ (to 1 d.p.)
- Richard paid \$7797 in tax during the year.
He should have paid \$8944.
Richard has not paid enough tax.
He needs to pay another \$1147 in tax.

EXPLANATION

Taxable income = gross income – deductions
Richard is in the middle tax bracket in the table, in which it says:

\$5092 plus 30c for each \$1 over \$45 000.
Note 30c is \$0.30.

Medicare levy is 2% of the taxable income

This is the total amount of tax that Richard should have paid.

This implies that Richard paid approximately 16.5% tax on every dollar. This is sometimes read as '16.5 cents in the dollar'.

This is known as a shortfall or a liability. He will receive a letter from the ATO requesting payment.

Now you try

Bella earned \$2500 per week (\$130 000 per annum) from her employer and other sources such as interest on investments. She has receipts for \$1800 for work-related expenses and donations.

- a Calculate Bella's taxable income.
- b Use this tax table to calculate Bella's tax payable.

Taxable income	Tax on income
\$0 – \$18 200	Nil
\$18 201 – \$45 000	19c for each \$1 over \$18 200
\$45 001 – \$200 000	\$5092 plus 30c for each \$1 over \$45 000
\$200 001 and over	\$51 592 plus 45c for each \$1 over \$200 000

- c Bella also needs to pay the Medicare levy of 2% of her taxable income. How much is the Medicare levy?
- d Add the tax payable and the Medicare levy.
- e Express the total tax in part d as a percentage of Bella's taxable income.
- f During the financial year, Bella's employer sent a total of \$35 000 in tax to the ATO. Has Bella paid too much tax, or not enough? Calculate her refund or liability.

Exercise 1J

FLUENCY

1–4

1, 2(1/2), 3, 5

2(1/2), 4, 5

- Example 30** 1 James earned \$1800 per week (\$93 600 per annum) from his employer and other sources such as interest on investments. He has receipts for \$2000 for work-related expenses and donations.



- a Calculate James's taxable income.
- b Use this tax table to calculate James's tax payable.

Taxable income	Tax on income
\$0 – \$18 200	Nil
\$18 201 – \$45 000	19c for each \$1 over \$18 200
\$45 001 – \$200 000	\$5092 plus 30c for each \$1 over \$45 000
\$200 001 and over	\$51 592 plus 45c for each \$1 over \$200 000

- c James also needs to pay the Medicare levy of 2% of his taxable income. How much is the Medicare levy?
- d Add the tax payable and the Medicare levy.
- e Express the total tax in part d as a percentage of James's taxable income.
- f During the financial year, James's employer sent a total of \$20 000 in tax to the ATO. Has James paid too much tax, or not enough? Calculate his refund or liability.

- 2 Use the tax table given in Question 1 to calculate the income tax payable on these taxable incomes. Ignore the Medicare levy.
- a \$30 000
 - b \$60 000
 - c \$150 000
 - d \$200 000

- 3 a Use the tax table to complete this table (ignoring the Medicare levy).

Taxable income	\$0	\$18 200	\$45 000	\$200 000	\$250 000
Tax payable					

- b Copy this set of axes, plot the points, from part a, then join the dots with straight line segments.

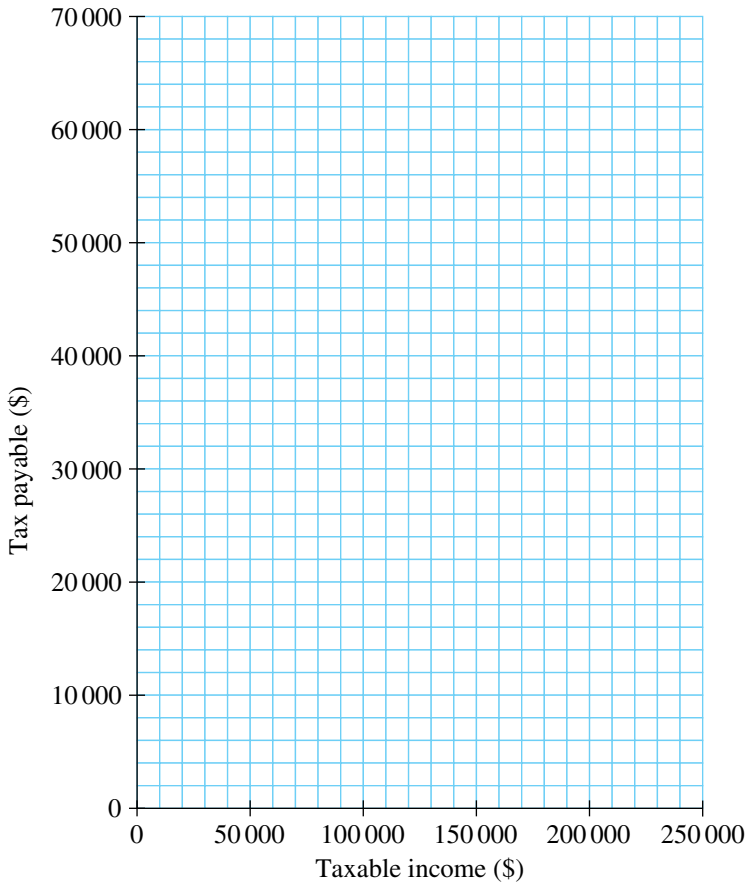

- 4 Jim worked for three different employers. They each paid him \$15 000. How much income tax should he have paid?



- 5 Lee has come to the end of her first financial year as a teacher. On 30 June she made the notes in the table below about the financial year.

Gross income from employer	\$58 725
Gross income from casual job	\$7500
Interest on investments	\$75
Donations	\$250
Work-related expenses	\$425
Tax paid during the financial year	\$13070

- Calculate Lee's taxable income.
- Use the tax table to calculate Lee's tax payable.
- Lee also needs to pay the Medicare levy of 2% of her taxable income. How much is the Medicare levy?
- Add the tax payable and the Medicare levy.
- Express the total tax in part **d** as a percentage of Lee's taxable income.
- Has Lee paid too much tax, or not enough? Calculate her refund or liability.

PROBLEM-SOLVING

6, 7

6–8

7–9

- Brad's Medicare levy was \$1750. This was 2% of his taxable income. What was his taxable income?
- Tara is saving for an overseas trip. Her taxable income is usually about \$20 000. She estimates that she will need \$5000 for the trip, so she is going to do some extra work to raise the money. How much extra will she need to earn in order to have an extra \$5000 after tax?



- When Sue used the tax table to calculate her income tax payable, it turned out to be \$22 722. What was her taxable income?



9 An example of a progressive taxation system is given in the table.

Income	Tax rate	Tax payable
\$0–\$10 000	0%	\$0
\$10 001–\$30 000	20%	\$0 + 20% of each dollar over \$10 000
\$30 001–\$100 000	30%	\$4000 + 30% of (income – \$30 000)
\$100 001–	40%	\$25 000 + 40% of (income – \$100 000)

- a Using the table above, find the tax payable on the following incomes.
 i \$20 000 ii \$55 000 iii \$125 000
- b Copy and complete the details in the following progressive tax system.

Income	Tax rate	Tax payable
\$0–\$15 000	0%	\$0
\$15 001–\$40 000	15%	\$0 + 15% of each dollar over \$15 000
\$40 001–\$90 000	25%	-----
\$90 001–	33%	-----

- c A different system on ‘Taxation Island’ looks like this.

Income	Tax rate	Tax payable
\$0–\$20 000	10%	10% of total income
\$20 001–\$80 000	30%	30% of total income
\$80 001–	50%	50% of total income

Find the tax payable on an income of:

- i \$20 000 ii \$21 000
 iii \$80 000 iv \$80 001
- d By referring to your answers in part c, describe the problems associated with the taxation system on Taxation Island.

REASONING

10, 11

10, 11

11, 12

- 10 Explain the difference between gross income and taxable income.
- 11 Explain the difference between a tax refund and a tax liability.
- 12 Josh looked at the last row of the tax table and said ‘It is unfair that people in that tax bracket pay 45 cents in every dollar in tax’. Explain why Josh is incorrect.

ENRICHMENT: What are legitimate tax deductions?

–

–

13

- 13 a Choose an occupation or career in which you are interested. Imagine that you are working in that job. During the year you will need to keep receipts for items you have bought that are legitimate work-related expenses. Do some research on the internet and write down some of the things that you will be able to claim as work-related expenses in your chosen occupation.
- b i Imagine your taxable income is \$80 000. What is your tax payable?
 ii You just found a receipt for a \$100 donation to a registered charity. This decreases your taxable income by \$100. By how much does it decrease your tax payable?



The following problems will investigate practical situations drawing upon knowledge and skills developed throughout the chapter. In attempting to solve these problems, aim to identify the key information, use diagrams, formulate ideas, apply strategies, make calculations and check and communicate your solutions.

Bedroom makeover

- 1 Phil and Deb are mixing their own paint to form a special colour for their bedroom makeover. They have tested the following ratios and feel that these two options, A and B, suit their tastes.

Colour	White	Yellow	Red	Blue
Ratio A	20	3	1	3
Ratio B	24	4	2	3

The white paint costs \$8 per litre and the colours all cost \$25 per litre. The bedroom is 6 m long, 5 m wide and 2.5 m high, and the paint covers 10 m^2 per litre.

Phil and Deb are interested in the amount and cost of paint required to cover the walls and ceiling of the bedroom using one of these colour combinations.

- a What fraction of:
- red paint is in ratio A?
 - blue paint in ratio B?
 - white paint in ratio B?
- b If 45 L of paint is required in total, find the amount of the following correct to the nearest litre.
- white paint required using ratio A
 - yellow paint required using ratio B
- c If the walls and ceiling require two coats of paint find:
- the total area of the walls and ceiling
 - the amount of paint required in total
 - the amount of red paint needed using ratio A, correct to one decimal place
 - the amount of blue paint needed using ratio B, correct to one decimal place.
- d All paint can only be purchased in a whole number of litres. Find the minimum cost of painting the room with two coats using:
- ratio A
 - ratio B.

Deals on wheels

- 2 During the summer, Casey makes two types of gift hampers and delivers them to customers' homes.
- 5 kg hamper, retail price: \$24.90
 - 8 kg hamper, retail price: \$34.90

The cost to Casey to put the hampers together is:

- 5 kg hamper: \$15
- 8 kg hamper: \$23

Casey also charges a \$5 delivery fee, but her cost on average per km of travel is \$0.50.

Casey is interested in the possible profits that can be made in her business and ways in which she can boost sales by offering special combination deals.

Where necessary round any decimal answers to the nearest cent, e.g. \$3.57.

- a For the given hamper weights and retail prices:
- which hamper is better value for money?
 - if the 5 kg hamper was re-priced based on the cost per kg of the 8 kg hamper, what would be its new retail price?



- b** Casey looks at two sales scenarios.
- Scenario A: 60 deliveries covering 500 km
 - Scenario B: 100 deliveries covering 1000 km
- Find the total profit from:

Scenario A		Scenario B	
Hamper	Sales	Hamper	Sales
5 kg	45	5 kg	80
8 kg	25	8 kg	50

- i Scenario A ii Scenario B.
- c** To encourage sales, Casey offers a combination deal of one 5 kg hamper and one 8 kg hamper for \$50.
- i What is the overall profit for a combination deal, assuming a single delivery charge of \$5 and a 10 km journey?
 - ii Compared to selling one of each of the 5 kg and 8 kg hampers, how much of a discount does the combination deal represent? Express as a percentage correct to one decimal place. Assume that the delivery charges are the same.
- d** In scenario B in part **b** above, 30 people buy two hampers, including one of each type of hamper, and all the other sales are single hamper purchases. Casey predicts that 50% of the customers who buy just one single hamper can be convinced to buy the combination deal. Will this mean that Casey is better off and by how much? (Note: The 30 people who bought both types of hampers now only pay \$50.)

Taxing commission

- 3** Dihan works in sales for a large surfboard company and receives a \$600 per week retainer, plus \$50 for each surfboard he sells. Tax is taken out of his yearly income by the company according to the table opposite.

Income bracket	Tax rate	Tax payable
\$0–\$10 000	0%	\$0
\$10 001–\$20 000	10%	\$0 + 10% of each dollar over \$10 000
\$20 001–\$50 000	20%	$\$a$ + 20% of each dollar over \$20 000
\$50 001–	30%	$\$b$ + 30% of each dollar over \$50 000

Dihan is interested in the number of sales required for a particular income goal and the amount of tax payable on that income.

- a** Assume that Dihan works and is paid for 48 weeks in a year.
 - i Calculate the total income for the year if Dihan sells on average 6 surfboards each week.
 - ii Write a rule for Dihan’s income per year, $\$A$, if he averages n sales per week.
 - iii Find the minimum average number of sales per week if Dihan wants to earn \$50 000 for the year.
- b** The values of a and b in the tax table can be calculated as the maximum amount of tax payable from the previous bracket. Find the values of a and b .
- c** Find Dihan’s tax payable if he earns the following amounts in a year.
 - i \$36 000 ii \$85 000
- d** Find Dihan’s yearly income if he is required to pay the following amounts of tax.
 - i \$6000 ii \$12 000
- e** Dihan’s total living expenses are $\$E$ per year and he wants to save close to \$20 000 in a year after living expenses and taxes are paid. If $E = 25\ 000$, find the average number of sales required each week to achieve his goal. Assume he works for 48 weeks and give a whole number answer.

1K Simple interest

LEARNING INTENTIONS

- To understand how simple interest is calculated
- To know the simple interest formula and the meaning of the variables
- To be able to apply the simple interest formula to calculate interest or an investment time period or rate
- To be able to calculate a final balance from a simple interest account

When paying back the amount borrowed from a bank or other financial institution, the borrower pays interest to the lender. It is like rent paid on the money borrowed. A financial institution might be the lender, giving you a loan, or the borrower, when you invest your savings with them (effectively when you lend them your money). In either case, interest is calculated as a percentage of the amount borrowed. For simple interest, the percentage is calculated on the amount originally borrowed or invested and is paid at agreed times, such as once a year.



Buying an item with a loan greatly increases its price. A car bought with a \$750 deposit and a \$10 000 loan at 8% p.a. simple interest repaid over 5 years, plus fees, has had its price increased to around \$15 000.

Lesson starter: Developing the rule

\$5000 is invested in a bank and 5% simple interest is paid every year. In the table at right, the amount of interest paid is shown for Year 1, the amount of accumulated total interest is shown for Years 1 and 2.

Year	Interest paid that year	Accumulated total interest
1	$\frac{5}{100} \times \$5000 = \250	$1 \times \$250 = \250
2		$2 \times \$250 = \500
3		
4		
t		

- Complete the table, writing an expression in the last cell for the accumulated total interest after t years.
- Now write a rule using $\$P$ for the initial amount, t for the number of years and r for the interest rate to find the total interest earned, $\$I$.

KEY IDEAS

- To calculate **simple interest**, we apply the formula:

$$I = P \times \frac{r}{100} \times t \text{ or } I = \frac{Prt}{100}$$

where

- I is the amount of **simple interest** (in \$)
- P is the **principal** amount; the money invested, borrowed or loaned (in \$)
- $r\%$ is the rate per unit time; usually **per annum** (p.a.), which means per year
- t is the period of **time**, expressed in the stated units, usually years.

- When using simple interest, the principal amount is constant and remains unchanged from one period to the next.
- The total amount (\$A) equals the principal plus interest:
 $A = P + I$

BUILDING UNDERSTANDING

- 1 a** How many years is the following number of months?
- i 36 ii 18 iii 66
- b** How many months is the following number of years?
- i 4 ii 2.5 iii 7.25
- 2** Find the following percentages.
- a 5% of \$1000 b 4% of \$1500 c 8% of \$3000
- 3** \$12000 is invested at 6% p.a. for 42 months.
- a What is the principal amount?
- b What is the interest rate?
- c What is the time period in years?
- d How much interest is earned each year?
- e How much interest is earned after 2 years?
- f How much interest is earned after 42 months?

**Example 31 Using the simple interest formula**

Calculate the simple interest earned if the principal is \$1000, the rate is 5% p.a. and the time is 3 years.

SOLUTION

$$P = 1000, r = 5, t = 3$$

$$\begin{aligned} I &= \frac{Prt}{100} \\ &= \frac{1000 \times 5 \times 3}{100} \\ &= 150 \end{aligned}$$

$$\text{Interest} = \$150$$

EXPLANATION

List the information given.

Write the formula and substitute the given values.

This is the same as using $I = P \times \frac{r}{100} \times t$.

Answer the question.

Now you try

Calculate the simple interest earned if the principal is \$1500, the rate is 7% p.a. and the time is 4 years.

**Example 32** Calculating the final balance

Allan and Rachel plan to invest some money for their child Kaylan. They invest \$4000 for 30 months in an account that pays 4.5% p.a. Calculate the simple interest and the amount available at the end of the 30 months.

SOLUTION

$$P = 4000, r = 4.5, t = \frac{30}{12} = 2.5$$

$$\begin{aligned} I &= \frac{Prt}{100} \\ &= \frac{4000 \times 4.5 \times 2.5}{100} \\ &= 450 \end{aligned}$$

$$\text{Interest} = \$450$$

$$\begin{aligned} \text{Total amount} &= \$4000 + \$450 \\ &= \$4450 \end{aligned}$$

EXPLANATION

t is written in years since interest rate is per annum.

Write the formula, substitute the known information and evaluate.

$$\text{Alternatively, use } I = P \times \frac{r}{100} \times t$$

$$\text{Total amount} = \text{principal} + \text{interest}$$

Now you try

Rohan plans to invest some money to save for a new tractor. He invests \$20 000 for 42 months at the rate of 6.5%. Calculate the simple interest and the amount available at the end of the 42 months.

**Example 33** Determining the investment period

Remy invests \$2500 at 8% p.a. simple interest for a period of time and receives \$50 interest. For how long (in months) did she invest the money?

SOLUTION

$$I = 50, P = 2500, r = 8$$

$$\begin{aligned} I &= \frac{Prt}{100} \\ 50 &= \frac{2500 \times 8 \times t}{100} \end{aligned}$$

$$50 = 200t$$

$$\begin{aligned} t &= \frac{50}{200} \\ &= 0.25 \end{aligned}$$

$$\begin{aligned} \text{Time} &= 0.25 \text{ years} \\ &= 0.25 \times 12 \text{ months} \\ &= 3 \text{ months} \end{aligned}$$

EXPLANATION

List the information given.

Write the formula, substitute the known information and simplify.

Solve the remaining equation for t .

Convert decimal time to months where appropriate.

Now you try

Mia invests \$4200 at 6% p.a. simple interest for a period of time and receives \$189 interest. For how long (in months) did she invest the money?

Exercise 1K

FLUENCY

1–6

1, 3, 5–7

2, 3, 5, 6, 8

Example 31



1 Use the rule $I = \frac{Prt}{100}$ to find the simple interest earned in these financial situations.

- a** Principal \$6000, rate 12% p.a., time 5 years
b Principal \$5200, rate 4% p.a., time 24 months



2 Calculate the simple interest earned if the principal is \$2000, the value is 6% p.a. and the time is 5 years.

Example 32



3 Wally invests \$15 000 at a rate of 6% p.a. for 3 years. Calculate the simple interest and the amount available at the end of 3 years.

4 Annie invests \$22 000 at a rate of 4% p.a. for 27 months. Calculate the simple interest and the amount available at the end of 27 months.



5 A finance company charges 14% p.a. simple interest. If Lyn borrows \$2000 to be repaid over 2 years, calculate her total repayment.

Example 33



6 Zac invests \$3500 at 8% p.a. simple interest, for a period of time, to produce \$210 interest. For how long did he invest the money?



7 If \$4500 earns \$120 simple interest at a flat rate of 2% p.a., calculate the duration of the investment.



8 Calculate the principal amount that earns \$500 simple interest over 3 years at a rate of 8% p.a. Round to the nearest cent.

PROBLEM-SOLVING

9–11

10–12

11, 12



9 Wendy wins \$5000 during a chess tournament. She wishes to invest her winnings, and has the two choices given below. Which one gives her the greater total at the end of the time?

Choice 1: 8.5% p.a. simple interest for 4 years

Choice 2: 8% p.a. simple interest for 54 months



10 Charlotte borrows \$9000 to buy a secondhand car. The loan must be repaid over 5 years at 12% p.a. simple interest. Calculate:

- a** the total amount to be repaid
b the monthly repayment amount if the repayments are spread equally over the 5 years.

11 An investment of \$5000 earns \$6000 simple interest in 12 years. Calculate the interest rate.

- 12 Chris invests $\$P$ and wants to double this amount of money.
- How much interest must be earned to double this initial amount?
 - What simple interest rate is required to double the initial amount in 8 years?
 - The simple interest rate is 5% p.a.
 - How many years will it take to double the investment?
 - How many years will it take to triple the investment amount?
 - How do the investment periods in parts **i** and **ii** compare?

REASONING

13

13, 14

13, 14

- 13 To find the total amount $\$T$ including simple interest, the rule is $T = P\left(1 + \frac{rt}{100}\right)$.
- Use this rule to find the total amount after 10 years when $\$30\,000$ is invested at 7% p.a.
 - Use the rule to find the time that it takes for an investment to grow from $\$18\,000$ to $\$22\,320$ when invested at 6% p.a. simple interest.
- 14 Rearrange the rule $I = \frac{Prt}{100}$ to find a rule for:
- P in terms of I , r and t
 - t in terms of I , P and r
 - r in terms of I , P and t .

ENRICHMENT: Property investing

–

–

15

- 15 Many investors use interest-only loans to buy shares or property. For such loans the principal stays constant and only the interest is paid back each month.
- Sasha buys an investment property for $\$300\,000$ and borrows the full amount at 7% p.a. simple interest. She rents out the property at $\$1500$ per month and pays $\$3000$ per year in rates and other costs to keep the property.



- Find the amount of interest Sasha needs to pay back every month.
- Find Sasha's yearly income from rent.
- By considering the other costs in keeping the property, calculate Sasha's overall loss in a year.
- Sasha hopes that the property's value will increase enough to cover any loss she is making. By what percentage of the original price will the property need to increase in value per year?

Using a CAS calculator 1K: Number and interest problems

The activity is in the Interactive Textbook in the form of a printable PDF.

1L Compound interest and depreciation EXTENDING

LEARNING INTENTIONS

- To understand how compound interest works
- To be able to calculate an account balance using compound interest
- To be able to calculate interest or an initial amount using the compound interest formula

When interest is added to an investment total before the next amount of interest is calculated, we say that the interest is compounded. Interest on a \$1000 investment at 8% p.a. gives \$80 in the first year. If the interest is compounded, the interest calculated in the second year is 8% of \$1080. This is repeated until the end of the investment period. Other forms of growth and decay work in a similar manner.



Assets, such as investment accounts, land and buildings, that grow by a percentage each year increase in total value at a faster rate over time. Their possible future value can be predicted using the compound interest formula.

Lesson starter: Power play

\$10000 is invested at 5% interest compounded annually. Complete this table showing the interest paid and the balance (original investment plus interest) at the end of each year.

Year	Opening balance	Interest paid that year	Closing balance
1	\$10 000	$0.05 \times \$10\,000$ = \$ _____	$\$10\,000 \times 1.05 = \$$ _____
2	\$ _____	$0.05 \times \$$ _____ = \$ _____	$\$10\,000 \times 1.05 \times 1.05$ = $\$10\,000 \times 1.05^2$ = \$ _____
3	\$ _____	$0.05 \times \$$ _____ = \$ _____	$\$10\,000 \times$ _____ = $\$10\,000 \times 1.05^3$ = \$ _____

- What patterns can you see developing in the table?
- How can you use the *power* button on your calculator to help find the balance at the end of each year?
- How would you find the balance at the end of 10 years without creating a large table of values?
- Do you know how to build this table in a computerised spreadsheet?

KEY IDEAS

- A repeated product can be written and calculated using a power.
 - For example: $1.06 \times 1.06 \times 1.06 \times 1.06 = (1.06)^4$
 $0.85 \times 0.85 \times 0.85 = (0.85)^3$
- **Compound interest** is interest which is added to the investment amount before the next amount of interest is calculated.
 - For example: \$5000 invested at 6% compounded annually for 3 years gives $\$5000 \times 1.06 \times 1.06 \times 1.06 = 5000 \times (1.06)^3$.
 - 6% compounded annually can be written as 6% p.a.
 - p.a. means 'per annum' or 'per year'.

- The initial investment or loan is called the **principal**.
 - The total interest earned = final amount – principal.
- Depreciation is the reverse situation in which the value of an object decreases by a percentage year after year.

BUILDING UNDERSTANDING



1 \$2000 is invested at 10% compounded annually for 3 years.

- Find the interest earned in the first year.
- Find the total balance at the end of the first year.
- Find the interest earned in the second year.
- Find the total balance at the end of the second year.
- Find the interest earned in the third year.
- Find the total balance at the end of the third year.



2 Find the value of the following correct to two decimal places. What do you notice?

- $2500 \times 1.03 \times 1.03 \times 1.03$
- $420 \times 1.22 \times 1.22 \times 1.22 \times 1.22$
- $2500 \times (1.03)^3$
- $420 \times (1.22)^4$



3 State the missing numbers to help describe each situation.

- \$4000 is invested at 20% compounded annually for 3 years.
 $\$4000 \times (\underline{\quad})^3$
- \$15 000 is invested at 7% compounded annually for 6 years.
 $\$ \underline{\quad} \times (1.07)^{\square}$
- \$825 is invested at 11% compounded annually for 4 years.
 $\$825 \times (\underline{\quad})^{\square}$



Example 34 Calculating a balance using compound interest

Find the total value of the investment if \$8000 is invested at 5% compounded annually for 4 years.

SOLUTION

$$\begin{aligned} 100\% + 5\% &= 105\% \\ &= 1.05 \end{aligned}$$

$$\begin{aligned} \text{Investment total} &= \$8000 \times (1.05)^4 \\ &= \$9724.05 \end{aligned}$$

EXPLANATION

Add 5% to 100% to find the multiplying factor.

Multiplying by $(1.05)^4$ is the same as multiplying by $1.05 \times 1.05 \times 1.05 \times 1.05$.

Now you try

Find the total value of the investment when \$6000 is invested at 4% compounded annually for 3 years.



Example 35 Finding the initial amount

After 6 years a loan grows to \$62 150. If the interest was compounded annually at a rate of 9%, what is the amount of the initial loan to the nearest dollar?

SOLUTION

$$\begin{aligned} 100\% + 9\% &= 109\% \\ &= 1.09 \end{aligned}$$

$$\begin{aligned} \text{Initial amount} \times (1.09)^6 &= \$62\,150 \\ \text{Initial amount} &= \$62\,150 \div (1.09)^6 \\ &= \$37\,058 \end{aligned}$$

EXPLANATION

Add 9% to 100% to find the multiplying factor.

Write the equation including the final total.
Divide by $(1.09)^6$ to find the initial amount and round as required.

Now you try

After 7 years a loan grows to \$43 200. If the interest was compounded annually at a rate of 8%, what is the amount of the initial loan to the nearest dollar?



Example 36 Calculating a depreciated value

A car worth \$30 000 will depreciate by 15% p.a. What will the car be worth at the end of the fifth year to the nearest cent?

SOLUTION

$$\begin{aligned} 100\% - 15\% &= 85\% \\ &= 0.85 \end{aligned}$$

$$\begin{aligned} \text{Depreciated value} &= \$30\,000 \times (0.85)^5 \\ &= \$13\,311.16 \text{ (to 2 d.p.)} \end{aligned}$$

EXPLANATION

Subtract 15% from 100%.

Multiply by $(0.85)^5$ for 5 years.

Now you try

A computer worth \$3000 will depreciate by 18% p.a. What will the computer be worth at the end of the third year to the nearest cent?



Exercise 1L

FLUENCY

1–3, 5

1, 2(1/2), 3, 4(1/2), 5, 6(1/2), 7

2(1/2), 3, 4(1/2), 6(1/2), 7

Example 34 1 Find the total value of the investment when \$3200 is invested at 6% compounded annually for 5 years.



2 Find the total balance of these investments given the interest rates and time period. Assume interest is compounded annually in each case. Round to the nearest cent.

a \$4000, 5%, 10 years

b \$6500, 8%, 6 years

c \$25 000, 11%, 36 months

d \$4000, 7%, 60 months

3 Barry borrows \$200 000 from a bank for 5 years and does not pay any money back until the end of the period. The compound interest rate is 8% p.a. How much does he need to pay back at the end of the 5 years? Round to the nearest cent.

4 Find the total percentage increase in the value of these amounts, compounded annually at the given rates. Round to one decimal place.

a \$1000, 4% p.a., 5 years

b \$20 000, 6% p.a., 3 years

c \$125 000, 9% p.a., 10 years

d \$500 000, 7.5% p.a., 4 years

Example 35 5 After 5 years a loan grows to \$45 200. If the interest was compounded annually at a rate of 6% p.a., find the size of the initial loan to the nearest dollar.



6 Find the initial investment amount to the nearest dollar given these final balances, annual interest rates and time periods. Assume interest is compounded annually in each case.

a \$26 500, 4%, 3 years

b \$42 000, 6%, 4 years

c \$35 500, 3.5%, 6 years

d \$28 200, 4.7%, 2 years

Example 36 7 Find the depreciated value of these assets to the nearest dollar.



a \$2000 phone at 30% p.a. for 4 years

b \$50 000 car at 15% p.a. for 5 years

c \$50 000 car at 15% p.a. for 10 years

PROBLEM-SOLVING

8, 9

9–11

10–12



8 Average house prices in Hobart are expected to grow by 8% per year for the next 5 years. What is the expected average value of a house in Hobart in 5 years' time, to the nearest dollar, if it is currently valued at \$370 000.





9 The population of a country town is expected to fall by 15% per year for the next 8 years due to the downsizing of the iron ore mine. If the population is currently 22 540 people, what is the expected population in 8 years' time? Round to the nearest whole number.



10 It is proposed that the mass of a piece of limestone lying out in the weather has decreased by 4.5% per year for the last 15 years. Its current mass is 3.28 kg. Find its approximate mass 15 years ago. Round to two decimal places.



-  **11** Charlene wants to invest \$10 000 long enough for it to grow to at least \$20 000. The compound interest rate is 6% p.a. How many whole number of years does she need to invest the money for so that it grows to her \$20 000 target?
-  **12** A forgetful person lets a personal loan balance grow from \$800 to \$1440 at a compound interest rate of 12.5% p.a. For approximately how many years did the person forget about the loan?

REASONING

13

13

13, 14



-  **13** \$400 is invested for 5 years under the following conditions.
- i** Simple interest at 7% p.a.
 - ii** Compound interest at 7% p.a.
- a** Find the percentage increase in the total value of the investment using condition part **i**.
- b** Find the percentage increase in the total value of the investment using condition part **ii**. Round to two decimal places.
- c** Explain why the total for condition part **i** is less than the total for condition part **ii**.
- 14** Find the total percentage increase in these compound interest situations to two decimal places.
- a** 5% p.a. for 3 years
 - b** 12% p.a. for 2 years
 - c** 4.4% p.a. for 5 years
 - d** 7.2% p.a. for 9 years
 - e** $r\%$ for t years

ENRICHMENT: Comparing simple and compound interest

–

–

15–17

-  **15** \$16 000 is invested for 5 years at 8% compounded annually.
- a** Find the total interest earned over the 5 years to the nearest cent.
 - b** Find the simple interest rate that would deliver the same overall interest at the end of the 5 years. Round to two decimal places.
-  **16** \$100 000 is invested for 10 years at 5.5% compounded annually.
- a** Find the total percentage increase in the investment to two decimal places.
 - b** Find the simple interest rate that would deliver the same overall interest at the end of the 10 years. Round to two decimal places.
- 17** Find the simple interest rate that is equivalent to these annual compound interest rates for the given periods. Round to two decimal places.
- a** 5% p.a. for 4 years
 - b** 10.5% p.a. for 12 years

1M Using a formula for compound interest and depreciation

EXTENDING

LEARNING INTENTIONS

- To know the formula for compound interest and for depreciation
- To be able to use the compound interest formula to find a total amount if interest is calculated annually or monthly
- To be able to use a formula to find a total amount if depreciation occurs

We saw earlier that interest can be calculated, not just on the principal investment, but on the actual amount present in the account. Interest can be calculated using updated applications of the simple interest formula, or by developing a new formula known as the compound interest formula.

If the original amount loses value over time, it is said to have depreciated. The compound interest formula can be adapted to cover this scenario as well. Cars, computers, boats and mobile phones are examples of consumer goods that depreciate in value over time.



Lesson starter: Repeated increases and decreases

If \$4000 increased by 5% in the first year, and then this amount was increased by 5% in the second year:

- what was the final amount at the end of the second year?
- what was the overall increase in value?
- what could you do to calculate the value at the end of 100 years, if the interest was added to the amount each year before the new interest was calculated?

If \$4000 decreased in value by 5% each year, how would you find the value at the end of:

- 1 year?
- 2 years?
- 100 years?

KEY IDEAS

- The **compound interest** formula is:

$$A = P \left(1 + \frac{r}{100} \right)^n, \text{ where}$$

A is the total amount (i.e. the principal and interest)

P is the principal investment (i.e. the original amount invested)

r is the percentage interest rate per compounding period.

n is the number of compounding periods

The formula is sometimes written as:

$$FV = PV \left(1 + \frac{r}{100} \right)^n, \text{ where}$$

FV is the future value

PV is the present value

- Compound interest = amount (A) – principal (P)

- **Depreciation** occurs when the principal decreases in value over time. The formula is:

$$A = P \left(1 - \frac{r}{100} \right)^n$$

- Common rounding used in monetary problems is two decimal places as this rounds to the nearest cent. This rounding is used throughout this section.

BUILDING UNDERSTANDING

- 1 Which of the following can be used to calculate the final value of a \$1000 investment at 10% p.a. for 3 years compounded annually?

A $1000 \times 0.1 \times 0.1 \times 0.1$

B $1000 \times 1.1 \times 3$

C $1000 \left(1 + \frac{10}{100} \right)^3$

D $1000 \left(1 - \frac{10}{100} \right)^3$

- 2 Complete the table of values showing how a car worth \$20 000 depreciates at a rate of 10% p.a. over 4 years.

Year	Value at start of year	10% depreciation	Value at end of year
1	\$20 000	\$2000	\$18 000
2	\$18 000	\$1800	
3			
4			

- 3 Which of the following gives the value of a \$40 000 car once it has depreciated for 4 years at a rate of 30% p.a.?

A $40\,000 \times \left(1 + \frac{30}{100} \right)^4$

B $40\,000 \times \frac{70}{100} \times 4$

C $40\,000 \times \left(1 - \frac{30}{100} \right)^4$

D $40\,000 - \left(\frac{70}{100} \right)^4$





Example 37 Using the compound interest formula

Callum invested \$10000 with a bank. The bank pays interest at the rate of 7% p.a., compounded annually.

- What is the value of Callum's investment at the end of 5 years?
- How much interest was earned over this time?

SOLUTION

$$\begin{aligned}
 \text{a } A &= P \left(1 + \frac{r}{100}\right)^n \\
 P &= 10000 \\
 r &= 7 \\
 n &= 5 \\
 A &= 10000(1 + 0.07)^5 \\
 &= 14\,025.517\dots \\
 \text{Final value is } &\$14\,025.52.
 \end{aligned}$$

$$\text{b Interest} = \$4025.52$$

EXPLANATION

Write down the compound interest formula.
Write down the values of the terms you know.

$n = 5$ (once a year for 5 years)
Substitute and evaluate.

The interest is found by subtracting the principal from the final amount.

Now you try

Moshie invests \$4000 in a fund which pays 6.5% p.a. compounded annually.

- What is the value of Moshie's investment at the end of 7 years?
- How much interest is earned over this time?



Example 38 Finding compounding amounts using months

Victoria's investment of \$6000 is invested at 8.4% p.a. for 4 years. Calculate the final value of her investment if interest is compounded monthly.

SOLUTION

$$\begin{aligned}
 A &= P \left(1 + \frac{r}{100}\right)^n \\
 P &= 6000 \\
 r &= 8.4 \div 12 = 0.7 \\
 n &= 4 \times 12 = 48 \\
 A &= 6000(1 + 0.007)^{48} \\
 &= 8386.2119\dots \\
 \text{Final amount is } &\$8386.21.
 \end{aligned}$$

EXPLANATION

Write down the compound interest formula.
Write down the values of the terms you know.
The interest rate of 8.4% is *divided* by 12 to find the *monthly* rate.

The number of compounding periods (n) is 12 times a year for 4 years or $n = 48$.

Substitute and evaluate.

$$\frac{0.7}{100} = 0.007.$$

Now you try

Millie's investment of \$24 000 is invested at 6.2% p.a. for 3 years. Calculate the final value of her investment if interest is compounded monthly.

**Example 39** Calculating the depreciated value

Naomi bought a computer three years ago for \$5680. She assumed the value of the computer would depreciate at a rate of 25% p.a.

What is the value of the computer at the end of the three years (assuming her assumption was correct)?

SOLUTION

$$A = P \left(1 - \frac{r}{100} \right)^n$$

$$A = 5680(1 - 0.25)^3$$

$$= 2396.25$$

The value at the end of the three years is \$2396.25.

EXPLANATION

Use $A = P \left(1 - \frac{r}{100} \right)^n$ since the computer is depreciating in value.

Substitute $P = 5680$, $r = 25$ and $n = 3$.

Now you try

Roger purchased a car five years ago for \$50 000. He assumed the value of the car would depreciate at a rate of 10% p.a.

What is the value of the car at the end of the five years (assuming his assumption was correct)?

Exercise 1M**FLUENCY**1, 2–4($\frac{1}{2}$)1, 2–4($\frac{1}{2}$)2–4($\frac{1}{3}$)**Example 37**

- 1 Brodie invests \$7000 in a bank at 5% p.a. compounded annually.

- a** What is the value of Brodie's investment at the end of 4 years?
b How much interest is earned over this time?



- 2 Calculate the final investment amount if the interest is compounded monthly.

- | | |
|---|---|
| a \$4000 at 5% p.a. for 8 years | b \$2000 at 5.4% p.a. for 3 years |
| c \$20 000 at 8% p.a. for 6 years | d \$10 000 at 16% p.a. for 6 months |
| e \$500 at 3.8% p.a. for 25 years | f \$350 at 6.78% p.a. for 2 year |
| g \$68 000 at 2.5% p.a. for 10 years | h 1 000 000 at 1% p.a. for 100 years |

Example 38

- 3 Calculate the final investment amount if the interest is compounded monthly.

- | | |
|---|---|
| a \$4000 at 12% p.a. for 4 years | b \$5000 at 6% p.a. for 2 years |
| c \$15 000 at 9% p.a. for 3 years | d \$950 at 6.6% p.a. for 30 months |
| e \$90 000 at 7.2% p.a. for $1\frac{1}{2}$ years | f \$34 500 at 4% p.a. for 1 year |

Example 39

- 4 It can be assumed that most cars depreciate at a rate of about 15% p.a. Calculate the projected value of each of the following cars at the end of 3 years, by using the rate of 15% p.a. Answer correct to the nearest dollar.







- | | |
|---|----------------------------|
| a Bentley Continental GT \$189 900 | b Audi A3 \$30 850 |
| c Hyundai Accent \$16 095 | d Lexus RX \$44 000 |
| e Toyota Camry \$29 500 | f Mazda 6 \$29 800 |

PROBLEM-SOLVING

5–7

5–8

6–10

-  5 How much interest is earned on an investment of \$400 if it is invested at:
- 6% p.a. simple interest for 2 years?
 - 6% p.a. compounded annually over 2 years?
 - 6% p.a. compounded monthly over 2 years?
-  6 a Tom invests \$1500 in an account earning $6\frac{1}{2}\%$ p.a. compounded annually. He plans to keep this invested for 5 years. How much interest will he earn on this investment?
- Susan plans to invest \$1500 in an account earning a simple interest rate of $6\frac{1}{2}\%$ p.a. How long does Susan need to invest her money to ensure that her return is equal to Tom's?
 - If Susan wishes to invest her \$1500 for 5 years as Tom did, yet still insists on a simple interest rate, what annual rate should she aim to receive so that her interest remains the same as Tom's?
-  7 Inflation is another application of the compound interest formula, as the cost of goods and services increases by a percentage over time. Find the cost of these household items, in 3 years, if the annual rate of inflation is 3.5%.
- Milk \$3.45 for 2L
 - Loaf of bread \$3.70
 - Can of cola \$1.80
 - Monthly electricity bill of \$120
 - Dishwashing powder \$7.99
-  8 Talia wishes to invest a lump sum today so that she can save \$25 000 in 5 years for a European holiday. She chooses an account earning 3.6% p.a. compounded monthly. How much does Talia need to invest to ensure that she reaches her goal?
-  9 a Find the compound interest when \$10 000 is invested at 6% p.a. over 2 years compounding:
- annually
 - every 6 months (twice a year)
 - quarterly
 - monthly
 - daily
- b What conclusions can be made about the interest earned versus the number of compounding periods?
-  10 What annual simple interest rate corresponds to an investment of \$100 at 8% p.a. compounded monthly for 3 years?

REASONING

11

11, 12

12, 13

-  11 Write down a scenario that could explain each of the following lines of working for compound interest and depreciation.
- $300(1.07)^{12}$
 - $300(1.02)^{36}$
 - $1000(1.005)^{48}$
 - $1000(0.95)^5$
 - $9000(0.8)^3$

- 12 a** Calculate the interest earned on an investment of \$10 000 at 5% p.a. compounded annually for 4 years.
- b** Calculate the interest earned on an investment of \$20 000 at 5% p.a. compounded annually for 4 years. Is it double the interest in part **a**?
- c** Calculate the interest earned on an investment of \$10 000 at 10% p.a. compounded annually for 2 years. Is this the same amount of interest as in part **a**?
- d** Comment on the effects of doubling the principal invested.
- e** Comment on the effect of doubling the interest rate and halving the time period.

- 13 a** Calculate the interest earned when \$1000 is invested at 6% p.a. over 1 year compounded:
 - i annually
 - ii six-monthly
 - iii quarterly
 - iv monthly
 - v fortnightly
 - vi daily
- b** Explain why increasing the number of compounding periods increases the interest earned on the investment.

ENRICHMENT: Doubling your money - - 14

- 14** How long does it take to double your money?
Tony wishes to find out how long he needs to invest his money at 9% p.a., compounding annually, for it to double in value.

He sets up the following situation, letting P be his initial investment and $2P$ his desired final amount. He obtains the formula $2P = P(1.09)^n$, which becomes $2 = (1.09)^n$ when he divides both sides by P .

- a** Complete the table below to find out the number of years needed for Tony to double his money.

n	1	2	3	4	5	6	7	8	9
$(1.09)^n$									

- b** How long does it take if the interest rate is:
 - i 8% p.a.?
 - ii 12% p.a.?
 - iii 18% p.a.?

- c** What interest rate is needed to double Tony's money in only 3 years?
- d** Use your findings above to complete the following.
Years to double \times interest rate = _____
- e** Use your rule to find out the interest rate needed to double your money in:

- i 2 years
- ii $4\frac{1}{2}$ years
- iii 10 years

- f** Investigate the rule needed to triple your money.
- g** Investigate a rule for depreciation. Is there a rule for the time and rate of depreciation if your investment is halved over time?



Investing in art

Matilda is a keen art investor and has the opportunity to purchase a new work from an auction house. The auctioneer is saying that the estimated value of the painting is \$10 000.

Matilda's main investment goal is for each of her investments to at least double in value every 10 years.

Present a report for the following tasks and ensure that you show clear mathematical workings and explanations where appropriate. Round all monetary values to the nearest cent.

Preliminary task

- a If Matilda purchases the painting for \$10 000 and assumes a growth rate of 5% p.a., calculate the value of the investment after:
 - i 1 year
 - ii 2 years
 - iii 3 years.
- b The rule connecting the value of the \$10 000 investment (\$A) growing at 5% p.a. after t years is given by $A = 10\,000 \left(1 + \frac{5}{100}\right)^t$.
 - i Check your answers to part a by substituting $t = 1$, $t = 2$ and $t = 3$ into the given rule and evaluating the value of A using technology.
 - ii Construct a similar rule for an investment value of \$12 000 and a growth rate of 3%.
 - iii Construct a similar rule for an investment value of \$8000 and a growth rate of 8%.
- c Using $A = 10\,000 \left(1 + \frac{5}{100}\right)^t$ find the value of a \$10 000 investment at 5% after 10 years. (i.e. Calculate the value of A if $t = 10$.)

Modelling task

- | | |
|----------------------------|--|
| Formulate | <ol style="list-style-type: none"> a The problem is to determine an investment growth rate that delivers at least a doubling of Matilda's initial investment amount after 10 years. Write down all the relevant information that will help solve this problem. b Explain what the numbers 10 000 and 5 mean in the rule $A = 10\,000 \left(1 + \frac{5}{100}\right)^t$ in relation to Matilda's investment. |
| Solve | <ol style="list-style-type: none"> c Use the rule $A = 10\,000 \left(1 + \frac{r}{100}\right)^t$ to determine the value of Matilda's \$10 000 investment after 10 years for the following growth rates ($r\%$). <ol style="list-style-type: none"> i $r = 4$ ii $r = 7$ iii $r = 10$ d Choose your own values of r using one decimal place accuracy, and determine the growth rate for which the investment doubles in value after 10 years. |
| Evaluate and verify | <ol style="list-style-type: none"> e By considering values of r either side of your chosen value found in part d, demonstrate that your answer is correct to one decimal place. f Refine your answer so that it is correct to two decimal places. |
| Communicate | <ol style="list-style-type: none"> g Summarise your results and describe any key findings. |

Extension questions

- a Decide if changing the initial investment value changes the total percentage increase in value after the same number of years. Justify your answer.
- b If Matilda only paid \$8000 for the artwork but still wanted it to be valued at \$20 000 after 10 years, determine the required growth rate of the artwork. Round to two decimal places.

Coding tax

Key technology: Spreadsheets

People will often use an online tax calculator to get an idea of how much income tax they will have to pay each year. Such calculators will use an in-built algorithm to help determine the tax rates depending on the given income. An added factor is the Medicare levy which is added on to most tax liabilities.



We will use the following income tax rates for this investigation.

Taxable income	Tax on this income
0–\$18 200	Nil
\$18 201–\$45 000	19 cents for each \$1 over \$18 200
\$45 001–\$120 000	\$5092 plus 32.5 cents for each \$1 over \$45 000
\$120 001–\$180 000	\$29 467 plus 37 cents for each \$1 over \$120 000
\$180 001 and over	\$51 667 plus 45 cents for each \$1 over \$180 000

The Medicare levy is 2% of taxable income.

1 Getting started

- Find the amount of tax paid, not including the Medicare levy, for the following taxable incomes.
 - \$15 000
 - \$32 000
 - \$95 000
 - \$150 000
 - \$225 000
- Calculate the total tax payable on the following taxable incomes, including the Medicare levy, which is 2% of your taxable income.
 - \$60 000
 - \$140 000

2 Applying an algorithm

Consider the flowchart on the following page which aims to calculate the amount of tax a person should pay.

- Complete the flowchart by filling in the empty components.
- Explain what the formula $T = T + 0.02I$ does in the flowchart.
- Test the algorithm in the flowchart on some of the taxable income amounts from part 1 b above.

3 Using technology

The following spreadsheet is a tax calculator which applies the algorithm outlined in the flowchart using nested IF statements.

	A	B
1	Tax calculator	
2		
3	Taxable income	125000
4		
5	Income tax	=IF(B3<=18200,0,IF(B3<=45000,0.19*(B3-18200),IF(B3<=120000,5092+0.325*(B3-45000),IF(B3<=180000,29467+0.37*(B3-120000),51667+0.45*(B3-180000))))
6		
7	Medicare levy	=0.02*B3
8		
9	Total tax	=B5+B7

- Try entering the formulas into a spreadsheet. Be careful to put all the brackets and commas in the correct positions.
- Test your spreadsheet calculator by entering different taxable incomes studied earlier in this investigation.
- Use your tax calculator to find the total tax payable for the following taxable incomes.
 - \$67 000
 - \$149 000
 - \$310 000

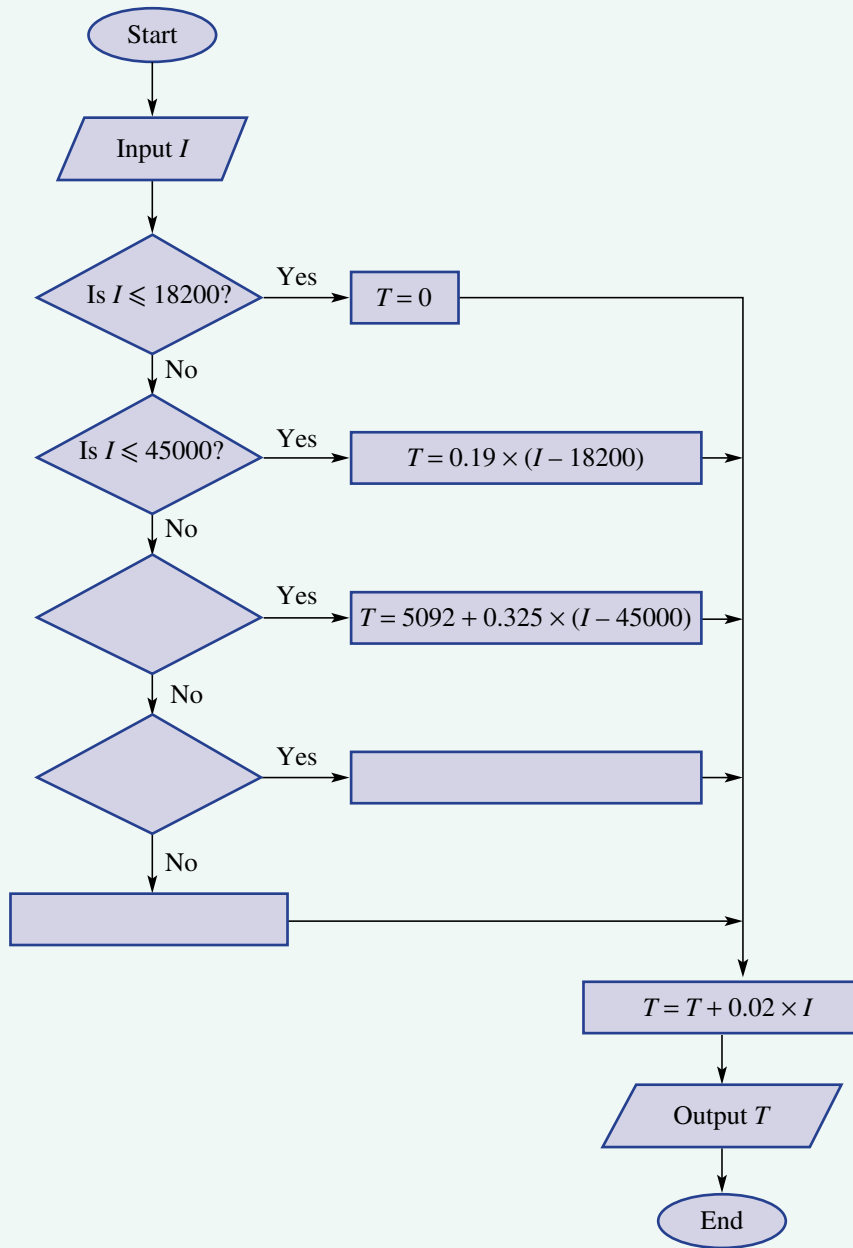

4 Extension

a A different tax system might use the following table. Find the values of a , b and c .

Taxable income	Tax on this income
0–\$25 000	Nil
\$25 001–\$60 000	20 cents for each \$1 over \$25 000
\$60 001–\$150 000	\$ a plus 30 cents for each \$1 over \$60 000
\$150 001–\$250 000	\$ b plus 40 cents for each \$1 over \$150 000
\$250 001 and over	\$ c plus 50 cents for each \$1 over \$250 000

The Medicare levy is 2% of taxable income.

b Try adjusting your tax calculator for this tax system and test a range of taxable incomes to ensure it is working correctly.

Compounding investments

Banks offer many types of investments that pay compound interest. Recall that for compound interest you gain interest on the money you have invested over a given time period. This increases your investment amount and therefore the amount of interest you gain in the next period.

Calculating yearly interest

Mary invests \$1000 at 6% per annum. This means Mary earns 6% of the principal every year in interest.

That is, after 1 year the interest earned is 6% of \$1000 = $\frac{6}{100} \times \$1000 = \60 .

- a The interest earned is added to the principal at the end of the year, and the total becomes the principal for the second year.
 - i How much interest will she earn at the end of the second and third year?
 - ii What total amount will Mary have at the end of the third year?
- b Write down a rule that calculates the total value of Mary's investment after t years. Use an initial investment amount of \$1000 and an annual interest rate of 6% p.a.
- c Use your rule from part b to calculate:
 - i the value of Mary's investment after 5 years
 - ii the time it takes for Mary's investment to grow to \$2000.

Using a spreadsheet

This spreadsheet will calculate the compound interest for you if you place the principal in cell B3 and the rate in cell D3.

In Mary's case put 1000 in B3 and $\frac{6}{100}$ in D3.

- a Copy the spreadsheet shown using 'fill down' at cells B7, C6 and D6.
- b What will be Mary's balance after 10 years? Extend your spreadsheet to find out.
- c Draw a graph of investment value versus time. Plot points using the results from your spreadsheet and join them with a smooth curve. Discuss the shape of the curve.
- d Now try altering the interest rate. What would Mary's investment grow to in 10 years if the interest rate was 10%?
- e What interest rate makes Mary's investment grow to \$2000 in 8 years? Use trial and error to get an answer correct to two decimal places. Record your investigation results using a table.
- f Investigate how changing the principal changes the overall investment amount. Record your investigations in a table, showing the principal amounts and investment balance for a given interest rate and period.

	A	B	C	D
1	COMPOUND	INTEREST	SIMULATOR	
2				
3	PRINCIPAL	...	RATE OF PERIOD	...
4				
5	PERIOD	OPENING BALANCE	INTEREST EARNED	NEW BALANCE
6	1	=B3	=B6*\$D\$3	=B6 + C6
7	2	=D6	=B7*\$D\$3	=B7 + C7
8	3	=D7	=B8*\$D\$3	=B8 + C8
9	4	=D8	=B9*\$D\$3	=B9 + C9

- 1 By only using the four operations $+$, $-$, \times and \div as well as brackets and square root ($\sqrt{\quad}$), the number 4 can be used exactly 4 times to give the answer 9 in the following way: $4 \times \sqrt{4} + 4 \div 4$. Use the number 4 exactly 4 times (and no other numbers) and any of the operations (as many times as you like) to give the answer 0 or 1 or 2 or 3 or ... or 10.

Up for a challenge? If you get stuck on a question, check out the 'Working with unfamiliar problems' poster at the end of the book to help you.



- 2 What is the value of n if n is the largest of 5 consecutive numbers that multiply to give 95 040?
- 3 Evaluate.

a
$$\frac{1}{1 + \frac{1}{1 + \frac{1}{3}}}$$

b
$$\frac{2}{1 + \frac{2}{1 + \frac{2}{5}}}$$

- 4 A jug has 1 litre of 10% strength cordial. How much pure cordial needs to be added to make the strength 20%? (The answer is not 100 mL.)
- 5 An old table in a furniture store is marked down by 10% from its previous price on five separate occasions. What is the total percentage reduction in price correct to two decimal places?



- 6 What simple interest rate is equivalent to a compound interest rate of 6% p.a. over 10 years correct to two decimal places?
- 7 Brendon has a rectangular paved area in his yard.
- a If he increases both the length and width by 20%, what is the percentage increase in area?
- b If the length and width were increased by the same percentage and the area increases by 21%, what is the percentage increase of the length and width?
- 8 A rectangular sandpit is shown on a map that has a scale of 1 : 100. On the map the sandpit has an area of 20 cm^2 . What is its actual area?
- 9 Arrange the numbers 1 to 15 in a row so that each adjacent pair of numbers sums to a square number.

Review of numbers

$2 + (-3) = -1$ For 8 and 12
 $-4 - (-2) = -2$ HCF is 4
 $15 \div (-5) = -3$ LCM is 24
 $-7 \times (-3) = 21$
 $(-2)^2 = 4$ $\sqrt{36} = 6$
 $4^3 = 64$ $\sqrt[3]{27} = 3$

Operations with fractions

+/- : need same denominator

e.g. $1\frac{5}{6} - \frac{7}{12} = \frac{11}{6} - \frac{7}{12}$

$$= \frac{22}{12} - \frac{7}{12}$$

$$= \frac{15}{12}$$

$$= 1\frac{1}{4}$$

× : Cancel then multiply
 ÷ : × by reciprocal

e.g. $1\frac{1}{2} \div \frac{7}{2} = \frac{3}{2} \times \frac{2}{7}$

$$= \frac{3}{7}$$

Rounding

1.284 to 1 d.p. is 1.3
 to 2 sig. fig. is 1.3

472.543 to 1 d.p. is 472.5
 to 1 sig. fig. is 500

0.0624 to 2 d.p. is 0.06
 to 2 sig. fig. is 0.062

Rates, ratios and best buy

Rate: 180 km per 3 h = 60 km/h

Ratio: $\frac{3}{7} : \frac{1}{2} = \frac{6}{14} : \frac{7}{14} = 6 : 7$

\$200 divided into 7 : 3
 10 parts is \$200
 ∴ 1 part is \$20
 3 parts is \$60
 7 parts is \$140

Best buy: 3 kg of carrots for \$6.45
 5 kg for \$10.20

3 kg bag: $6.45 \div 3 = \$2.15/\text{kg}$
 5 kg bag: $10.20 \div 5 = \$2.04/\text{kg}$
 ∴ 5 kg is best buy

Rational numbers (fractions)

$1\frac{3}{8} = \frac{11}{8} = 1.375$
 mixed numeral fraction terminating decimal

$\frac{1}{6} = 0.166... = 0.1\bar{6}$
 proper fraction recurring decimal

$\frac{2}{3}$ and $\frac{4}{6}$ are equivalent fractions

Irrational numbers cannot be expressed as a fraction

Reviewing number and financial mathematics

Compound interest (Ext)

\$3000 at 5% for 3 years
 Amount = $\$3000 \times (1.05)^3$
 = \$3472.88

Percentages

Fraction or decimal $\xrightarrow{\times 100\%}$ Percent

Percent $\xrightarrow{\div 100\%}$ Fraction or decimal

$\frac{3}{4} = \frac{3}{4} \times 100\% = 75\%$

$25\frac{1}{2}\% = 25.5 \div 100\% = 0.255$

20% of 60 = $0.2 \times 60 = 12$

5% of amount = 32
 ∴ amount = $32 \div 0.05 = 640$

Depreciation (Ext)

\$50 000 at 10% for 4 years
 Amount = $\$50\,000 \times (1 - 0.1)^4$
 = \$32 805

Simple interest

\$2000 at 5% for 4 years

$$I = \frac{Prt}{100} = \frac{\$2000 \times 5 \times 4}{100}$$

$$= \$400$$

Amount = $P + I$

Percentage increase and decrease

Increase
 20 by 6%:
 $20 \times 1.06 = 21.2$

Decrease
 20 by 5%:
 $20 \times 0.95 = 19$

Percentage change = $\frac{\text{change}}{\text{original}} \times 100\%$

Income and tax

Employees can be paid:
 wage: hourly rate with overtime at time and a half = 1.5 or double time
 salary: annual amount
 commission: % of sales
 net income
 = gross income – tax
 Calculate PAYG tax using a tax table.

Applications of percentages

Percentage profit or loss
 = $\frac{\text{profit or loss}}{\text{cost price}} \times 100\%$

Mark-up and discount
 Commission/tax

Chapter checklist with success criteria

A printable version of this checklist is available in the Interactive Textbook



1A	1. I can apply order of operations with positive and negative integers. e.g. Evaluate $3 \times (-5) + -10 - (-2)$.	<input type="checkbox"/>
1A	2. I can work with roots and powers. e.g. Evaluate $(-2)^2 - 3^2 \div \sqrt{9}$.	<input type="checkbox"/>
1B	3. I can round to a required number of decimal places. e.g. Round 3.4572 to two decimal places.	<input type="checkbox"/>
1B	4. I can round to a required number of significant figures. e.g. Round 24 532 and 0.0423 to two significant figures.	<input type="checkbox"/>
1B	5. I can estimate using significant figures. e.g. Estimate the answer to $1986.2 + 37 \div 0.0234$ by rounding each number in the problem to one significant figure.	<input type="checkbox"/>
1C	6. I can express a fraction as a decimal. e.g. Express $\frac{7}{12}$ as a decimal.	<input type="checkbox"/>
1C	7. I can express a decimal as a fraction. e.g. Express 2.35 as a fraction.	<input type="checkbox"/>
1C	8. I can compare fractions. e.g. Decide which is smaller: $\frac{11}{15}$ or $\frac{18}{25}$.	<input type="checkbox"/>
1D	9. I can add and subtract proper fractions. e.g. Evaluate $\frac{5}{8} + \frac{1}{6}$.	<input type="checkbox"/>
1D	10. I can add and subtract mixed numerals. e.g. Evaluate $2\frac{2}{5} - 1\frac{3}{4}$.	<input type="checkbox"/>
1D	11. I can multiply fractions. e.g. Evaluate $3\frac{1}{3} \times 1\frac{3}{5}$.	<input type="checkbox"/>
1D	12. I can divide fractions. e.g. Evaluate $1\frac{4}{5} \div 1\frac{5}{7}$.	<input type="checkbox"/>
1E	13. I can simplify ratios. e.g. Simplify $32 : 20$ and $0.3 : 0.12$.	<input type="checkbox"/>
1E	14. I can divide into a given ratio. e.g. 350 cm is to be divided in the ratio 2 : 5. Find the length of the larger portion.	<input type="checkbox"/>
1E	15. I can simplify rates. e.g. Write \$140 every 4 hours in simplest form.	<input type="checkbox"/>
1E	16. I can determine a best buy. e.g. What is better value: 2 kg of rice for \$3.60 or 5 kg of rice for \$17?	<input type="checkbox"/>

Chapter checklist with success criteria

		✓
1F	17. I can convert between percentages, decimals and fractions. e.g. Express 24.5% as a decimal and 8% as a fraction.	<input type="checkbox"/>
1F	18. I can express a quantity as a percentage. e.g. Express 34 out of 40 as a percentage.	<input type="checkbox"/>
1F	19. I can find a percentage of a quantity. e.g. Find 36% of \$60.	<input type="checkbox"/>
1F	20. I can find the original amount from a percentage. e.g. Determine the original amount if 12% of the amount is \$72.	<input type="checkbox"/>
1G	21. I can increase and decrease by a percentage. e.g. Increase \$30 by 8% and decrease \$40 by 15%.	<input type="checkbox"/>
1G	22. I can find a percentage change. e.g. Find the percentage change when a plant grows from 120 cm to 210 cm.	<input type="checkbox"/>
1G	23. I can find the original amount from a word problem. e.g. The cost of petrol rises by 12% over a week to \$1.54 per litre. What was the price at the start of the week? Round to the nearest cent.	<input type="checkbox"/>
1H	24. I can calculate the percentage profit. e.g. Mark restores an antique chair he bought for \$120. If he sells it for \$210, what is his percentage profit?	<input type="checkbox"/>
1H	25. I can determine the selling price from a mark-up or discount. e.g. Before school holidays an airline marks up all flights by 30%. If a flight costs \$840, what will be its selling price for the holidays?	<input type="checkbox"/>
1H	26. I can calculate a sale saving. e.g. A pair of jeans is discounted by 15%. If the sale price was \$68, what was the original price?	<input type="checkbox"/>
1I	27. I can calculate wages and salaries. e.g. Ryan earns an annual salary of \$74 500. He works 48 weeks of the year and works 38-hour weeks. Determine his hourly rate of pay to the nearest cent.	<input type="checkbox"/>
1I	28. I can calculate overtime. e.g. Ben's normal hourly rate of pay is \$24.30. Calculate his earnings in a week if he works 12 hours at the normal rate, 6 hours at time and a half and 8 hours at double time.	<input type="checkbox"/>
1I	29. I can calculate commission. e.g. A jeweller is paid a retainer of \$250 per week and she also receives a commission of 6% on the value of goods she sells. If she sells \$10 000 worth of jewellery during the week, how much will she earn?	<input type="checkbox"/>
1J	30. I can calculate tax using the PAYG system. e.g. Dara has an annual income of \$115 000 and \$5000 worth of receipts of work-related expenses and donations. Use the tax table to find Dara's tax payable.	<input type="checkbox"/>
1K	31. I can calculate simple interest using the formula. e.g. \$2000 is invested at 4% p.a. simple interest for 3 years. Calculate the interest earned.	<input type="checkbox"/>

Chapter checklist with success criteria

			✓
1K	32. I can find other unknowns using the simple interest formula. e.g. An investment of \$3000 at 4% p.a. simple interest earns \$280 interest over a certain period of time. Calculate how long the money was invested for.		<input type="checkbox"/>
1L	33. I can calculate the final balance using compound interest. e.g. Find the total value of an investment if \$12 000 is invested at 4% compounded annually for 5 years. Round to the nearest cent.	Ext	<input type="checkbox"/>
1L	34. I can find the initial amount using compound interest. e.g. After 4 years a loan increases to \$120 300. If the interest was compounded annually at a rate of 7%, find the size of the initial loan to the nearest dollar.	Ext	<input type="checkbox"/>
1L	35. I can find the final amount after depreciation. e.g. A car worth \$60 000 will depreciate by 12% p.a. What will the car be worth at the end of the fifth year to the nearest cent?	Ext	<input type="checkbox"/>
1M	36. I can use the compound interest formula to calculate a final balance compounded annually. e.g. Riley invests \$20 000 in a 5% p.a. interest account for 8 years compounded annually. How much interest is earned over this time correct to the nearest cent?	Ext	<input type="checkbox"/>
1M	37. I can use the compound interest formula to calculate a final balance compounded monthly. e.g. Sophie invests \$6000 in a 8% p.a. interest account for 5 years compounded monthly. What is the value of the investment, correct to the nearest cent, after the 5 years?	Ext	<input type="checkbox"/>
1M	38. I can calculate the future value of an item after depreciation has occurred. e.g. A TV is purchased for \$6000 and it depreciates at a rate of 16% p.a. Find the value of the TV after 5 years correct to the nearest cent.	Ext	<input type="checkbox"/>

Short-answer questions

1A

1 Evaluate the following.

a $-4 \times (2 - (-3)) + 4$

b $-3 - 4 \times (-2) + (-3)$

c $(-8 \div 8 - (-1)) \times (-2)$

d $\sqrt{25} \times \sqrt[3]{8}$

e $(-2)^2 - 3^3$

f $\sqrt[3]{1000} - (-3)^2$

1B

2 Round these numbers to three significant figures.

a 21.483

b 29 130

c 0.15271

d 0.002414

1B

3 Estimate the answer by first rounding each number to one significant figure.

a $294 - 112$

b 21.48×2.94

c $1.032 \div 0.493$

1C

4 Write these fractions as decimals.

a $2\frac{1}{8}$

b $\frac{5}{6}$

c $\frac{13}{7}$

1C

5 Write these decimals as fractions.

a 0.75

b 1.6

c 2.55

1D

6 Simplify the following.

a $\frac{5}{6} - \frac{1}{3}$

b $1\frac{1}{2} + \frac{2}{3}$

c $\frac{13}{8} - \frac{4}{3}$

d $3\frac{1}{2} \times \frac{4}{7}$

e $5 \div \frac{4}{3}$

f $3\frac{3}{4} \div 1\frac{2}{5}$

1E

7 Simplify these ratios.

a 30 : 12

b 1.6 : 0.9

c $7\frac{1}{2} : 1\frac{2}{5}$

1E

8 Divide 80 into the given ratio.

a 5 : 3

b 5 : 11

c 1 : 2 : 5

1E

9 Dry dog food can be bought from store A for \$18 for 8 kg or from store B for \$14.19 for 5.5 kg.

a Determine the cost per kilogram at each store and state which is the best buy (cheaper deal).

b Determine to the nearest integer how many grams of each brand you get per dollar.

1F

10 Copy and complete the table below.

Decimal	Fraction	Percentage
0.6		
	$\frac{1}{3}$	
		$3\frac{1}{4}\%$
	$\frac{3}{4}$	
1.2		
		200%

1F

11 Find:

a 25% of \$310

b 110% of 1.5

1G

12 Determine the original amount if:

a 20% of the amount is 30

b 72% of the amount is 18



1G

13 a Increase 45 by 60%.

b Decrease 1.8 by 35%.

c Find the percentage change if \$150 is reduced by \$30.



1G

14 The mass of a cat increased by 12% to 14 kg over a 12 month period. What was its starting mass?



1H

15 Determine the discount given on a \$15 000 car if it is discounted by 12%.



1H

16 The cost price of an article is \$150 and its selling price is \$175.

a Determine the profit made.

b Express the profit as a percentage of the cost price.



1I

17 Determine the hourly rate of pay for each case.

a A person with an annual salary of \$36 062 working a 38-hour week

b A person who earns \$429 working 18 hours at the hourly rate and 8 hours at time and a half



1J

18 Jo earns a salary of \$124 000 and has work related expenses and donations of \$4000. Use the tax table to calculate Jo's tax payable. Ignore the Medicare levy.



1K

19 Find the simple interest earned on \$1500 at 7% p.a. for 5 years.



1K

20 Rob invests \$10 000 at 8% p.a. simple interest to produce \$3600. For how long was the money invested?



1L/M

21 Find the total value of an investment if \$50 000 is invested at 4% compounded annually for 6 years. Round to the nearest cent.



Ext

1L/M

22 After 8 years a loan grows to \$75 210. If the interest was compounded annually at a rate of 8.5%, find the size of the initial loan to the nearest dollar.



Ext

1L/M

23 A \$4000 computer depreciates at a rate of 12% p.a. over 6 years. Find the value of the computer after the 6 years correct to the nearest cent.



Ext

1M

24 Mik's \$24 000 investment pays interest of 9% p.a. compounded monthly. What is the value of the investment after 3 years correct to the nearest cent?



Ext

Multiple-choice questions

1B

1 $\frac{2}{7}$ written as a decimal is:

- A 0.29 B 0.286 C 0.285 D $0.\overline{285714}$ E 0.285714

1B

2 3.0456 written to three significant figures is:

- A 3.04 B 3.05 C 3.045 D 3.046 E 3.45

1C

3 2.25 written as a fraction in simplest form is:

- A $2\frac{1}{2}$ B $\frac{5}{4}$ C $\frac{9}{4}$ D $9\frac{1}{4}$ E $\frac{225}{100}$

1D

4 $1\frac{1}{2} - \frac{5}{6}$ is equal to:

- A $\frac{2}{3}$ B $\frac{5}{6}$ C $-\frac{1}{2}$ D $\frac{2}{6}$ E $\frac{1}{2}$

1D

5 $\frac{2}{7} \times \frac{3}{4}$ is equivalent to:

- A $\frac{8}{11}$ B $\frac{3}{7}$ C $\frac{5}{11}$ D $\frac{8}{12}$ E $\frac{3}{14}$

1D

6 $\frac{3}{4} \div \frac{5}{6}$ is equivalent to:

- A $\frac{5}{8}$ B 1 C 21 D $\frac{4}{5}$ E $\frac{9}{10}$

1E

7 Simplifying the ratio 50 cm : 4 m gives:

- A 50 : 4 B 8 : 1 C 25 : 2 D 1 : 8 E 5 : 40

1F

8 28% as a fraction in its simplest form is:

- A 0.28 B $\frac{28}{100}$ C $\frac{0.28}{100}$ D $\frac{2.8}{100}$ E $\frac{7}{25}$

1F

9 15% of \$1600 is equal to:

- A 24 B 150 C \$240 D \$24 E 240



1I

10 Jane is paid a wage of \$7.80 per hour. If she works 12 hours at this rate during a week plus 4 hours on a public holiday for which she gets paid at time and a half, her earnings for the week are:

- A \$140.40 B \$124.80 C \$109.20 D \$156 E \$62.40



1I

11 Simon earns a weekly retainer of \$370 and 12% commission of any sales he makes. If he makes \$2700 worth of sales in a particular week, he will earn:

- A \$595 B \$652 C \$694 D \$738.40 E \$649.60



1L/M

12 \$1200 is increased by 10% for two years with compound interest. The total balance at the end of the two years is:

- A \$252 B \$1452 C \$1450 D \$240 E \$1440

Ext



Extended-response questions



1 Pauline buys a formal dress at cost price from her friend Tila. Pauline paid \$420 for the dress, which is normally marked up by 55%.

- How much did she save?
- What is the normal selling price of the dress?
- If Tila gets a commission of 15%:
 - how much commission did she get in dollars?
 - how much commission did Tila lose by selling the dress at cost price rather than the normal selling price?



2 Matilda has two bank accounts with the given details.

- Investment: Principal \$25 000, interest rate 6.5% compounded annually
 - Loan: 11.5% compounded annually
- Find Matilda's investment account balance after:
 - 1 year
 - 10 years (to the nearest cent)
 - Find the total percentage increase in Matilda's investment account after 10 years correct to two decimal places.
 - After 3 years Matilda's loan account has increased to \$114 250. Find the initial loan amount to the nearest dollar.
 - Matilda reduces her \$114 250 loan by \$30 000. What is this reduction as a percentage to two decimal places?
 - For Matilda's investment loan, what simple interest rate is equivalent to 5 years of the compounded interest rate of 6.5%? Round the answer to one decimal place.

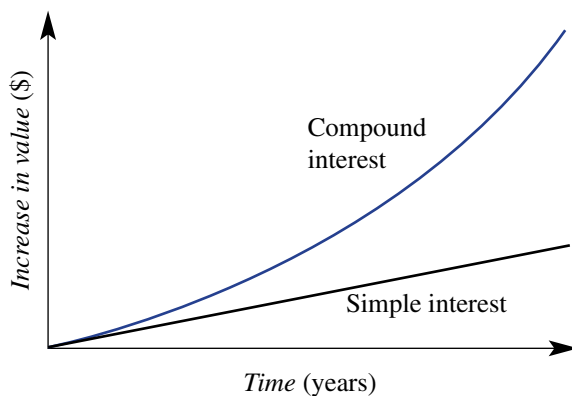

This graph shows the effect of the same rate of compound and simple interest on the increase in value of an investment or loan, compared over time. Simple interest is calculated only on the principal, so yields a balance that increases by the same amount every year, forming a straight-line graph. After the first year, compound interest is calculated on the principal and what has been added by the previous years' interest, so the balance increases by a greater amount each year. This forms an exponential graph.

2

Expressions and linear equations

Maths in context: Finding the price for highest profit

Mathematicians called Operations Research Analysts develop pricing strategies in areas such as the airline industry, computer services, financial engineering, healthcare, manufacturing, mining, transportation, and the military.

Large corporations that trade globally want to price their products for high profits and quick sales. For example, consider an electric car's price as set by the manufacturer. If this price is too low, no profit is made. A high price increases profit enabling more cars to be manufactured. But this assumes all higher priced cars are quickly sold, which doesn't happen in reality. How do we find a selling price suitable for both the manufacturer and its customers?

To determine the best price for a car, analysts solve simultaneous equations for Supply (i.e., production) and Demand (i.e., sales). If p = price of one car, and n = the number sold, then:

- the linear equation for Supply shows that as p increases, n increases.
- the linear equation for Demand shows that as p increases, n decreases.

Simultaneously solving the Supply and Demand equations finds the solution (n, p) that makes both equations true. The best car price for the highest profit is when the number of manufactured cars equals the number of definite sales.

Chapter contents

- 2A Algebraic expressions (CONSOLIDATING)
- 2B Simplifying algebraic expressions (CONSOLIDATING)
- 2C Expanding algebraic expressions
- 2D Solving linear equations with pronumerals on one side
- 2E Solving linear equations with brackets and pronumerals on both sides
- 2F Solving word problems
- 2G Solving linear inequalities
- 2H Using formulas
- 2I Simultaneous equations using substitution (EXTENDING)
- 2J Simultaneous equations using elimination (EXTENDING)
- 2K Applications of simultaneous equations (EXTENDING)

Australian Curriculum 9.0

NUMBER

Recognise that the real number system includes the rational numbers and the irrational numbers, and solve problems involving real numbers using digital tools (AC9M9N01)

ALGEBRA

Simplify algebraic expressions, expand binomial products and factorise monic quadratic expressions (AC9M9A02)

Use mathematical modelling to solve applied problems involving change including financial contexts; formulate problems, choosing to use either linear or quadratic functions; interpret solutions in terms of the situation; evaluate the model and report methods and findings (AC9M9A05)

© ACARA

Online resources

A host of additional online resources are included as part of your Interactive Textbook, including HOTmaths content, video demonstrations of all worked examples, auto-marked quizzes and much more.

2A Algebraic expressions CONSOLIDATING

LEARNING INTENTIONS

- To review the definitions and conventions of algebra
- To know how to combine numbers and variables to write algebraic terms and expressions
- To be able to express a word problem as a mathematical expression using pronumerals and mathematical operations
- To be able to substitute values for pronumerals in expressions and evaluate

Algebra is central to the study of mathematics and is commonly used to solve problems in a vast array of theoretical and practical problems. Algebra involves the representation and manipulation of unknown or varying quantities in a mathematical context. Pronumerals (or variables) are used to represent these unknown quantities.



Dentists use an algebraic formula to calculate the quantity of local anaesthetic required for a procedure. The pronumerals in the formula represent the concentration of the anaesthetic being used and the patient's weight.

Lesson starter: Remembering the vocabulary

State the parts of the expression $5x - 2xy + (4a)^2 - 2$ that match these words.

- pronumeral (or variable)
- term
- coefficient
- constant term
- squared term

KEY IDEAS

- In algebra, letters are used to represent numbers. These letters are called **pronumerals** or **variables**.
- An **expression** is a combination of numbers and pronumerals connected by any of the four operations $+$, $-$, \times and \div . Brackets can also be used.
For example: $5x^2 + 4y - 1$ and $3(x + 2) - \frac{y}{5}$
- A **term** is a combination of numbers and variables connected with only multiplication and division. Terms are separated with the operations $+$ and $-$.
For example: $5x + 7y$ is a two-term expression.
- **Coefficients** are the numbers being multiplied by pronumerals.
For example: the 3 in $3x$, the -2 in $5 - 2x$ and the $\frac{1}{2}$ in $\frac{x^2}{2}$ are coefficients.
- **Constant terms** consist of a number only.
For example: -2 in $x^2 + 4x - 2$ (The sign must be included.)
- Expressions can be **evaluated** by substituting a number for a pronumeral.
For example: if $a = -2$ then $a + 6 = -2 + 6 = 4$.
- **Order of operations** should be followed when evaluating expressions:
 - 1 Brackets
 - 2 Powers
 - 3 Multiplication and division
 - 4 Addition and subtraction

BUILDING UNDERSTANDING

- 1 State the number of terms in these expressions.

a $5x + 2y$	b $1 + 2a^2$	c $b^2 + ca - 1$	d $\frac{x^2}{2}$
-------------	--------------	------------------	-------------------
- 2 Match each item in the left column with an item in the right column.

a Product	A Division
b Sum	B Subtraction
c Difference	C Multiplication
d Quotient	D Addition
e x^2	E the reciprocal of a
f $\frac{1}{a}$	F the square of x
- 3 State the coefficient in these terms.

a $5xy$	b $-2a^2$	c $\frac{x}{3}$	d $-\frac{2a}{5}$
---------	-----------	-----------------	-------------------

**Example 1 Writing algebraic expressions from words**

Write an algebraic expression for:

- a** the number of tickets needed for 3 boys and r girls
- b** the cost of P pies at \$3 each
- c** the number of grams of peanuts for one child when 300 g of peanuts is shared equally among C children.

SOLUTION

a $3 + r$

b $3P$

c $\frac{300}{C}$

EXPLANATION

3 tickets plus the number of girls

3 multiplied by the number of pies

300 g divided into C parts**Now you try**

Write an algebraic expression for:

- a** the number of seats needed for a adults and 7 children
- b** the cost of n apples at \$1.20 each
- c** the number of pieces of chocolate for one person when 60 pieces is equally shared among p people.

**Example 2 Converting words to expressions**

Write an algebraic expression for:

- a** five less than x
- b** three more than twice x
- c** the sum of a and b is divided by 4
- d** the square of the sum of x and y .

SOLUTION

a $x - 5$

b $2x + 3$

c $\frac{a + b}{4}$

d $(x + y)^2$

EXPLANATION5 subtracted from x Twice x plus 3The sum of a and b is done first ($a + b$) and the result divided by 4.The sum of x and y is done first and then the result is squared.

Now you try

Write an algebraic expression for:

a six more than x

b one less than three times x

c two less than a is divided by 3

d the square root of the sum of a and b .



Example 3 Substituting values into expressions

Evaluate these expressions when $a = 5$, $b = -2$ and $c = 3$.

a $7a - 2(a - c)$

b $b^2 - ac$

SOLUTION

$$\begin{aligned}
 \text{a } 7a - 2(a - c) &= 7 \times 5 - 2(5 - 3) \\
 &= 35 - 2 \times 2 \\
 &= 35 - 4 \\
 &= 31
 \end{aligned}$$

$$\begin{aligned}
 \text{b } b^2 - ac &= (-2)^2 - 5 \times 3 \\
 &= 4 - 15 \\
 &= -11
 \end{aligned}$$

EXPLANATION

Substitute the values for a and c . When using order of operations, evaluate brackets before moving to multiplication and division then addition and subtraction.

Evaluate powers before the other operations:
 $(-2)^2 = -2 \times (-2) = 4$

Now you try

Evaluate these expressions when $a = 3$, $b = -1$ and $c = -2$.

a $3(a - b) + 2c$

b $c^2 - 3ab$

Exercise 2A

FLUENCY

1, 2-3($1/2$)

1, 2-4($1/2$)

2-3($1/2$), 4

Example 1

1 Write an algebraic expression for the following.

a The number of tickets required for:

i 4 boys and r girls

ii t boys and 2 girls

iii b boys and g girls

iv x boys, y girls and z adults.

b The cost, in dollars, of:

i P pies at \$6 each

ii 10 pies at \$ n each

iii D drinks at \$2 each

iv P pies at \$5 each and D drinks at \$2 each.

c The number of grams of lollies for one child when 500 g of lollies is shared equally among C children.

Example 2

- 2 Write an algebraic expression for each of the following.
- a The sum of 2 and x
 - b The sum of ab and y
 - c 5 less than x
 - d The product of x and 3
 - e The difference between $3x$ and $2y$
 - f Three times the value of p
 - g Four more than twice x
 - h The sum of x and y is divided by 5
 - i 10 less than the product of 4 and x
 - j The square of the sum of m and n
 - k The sum of the squares of m and n
 - l The square root of the sum of x and y
 - m The sum of a and its reciprocal
 - n The cube of the square root of x

Example 3

- 3 Evaluate these expressions when $a = 4$, $b = -3$ and $c = 7$.
- a $b - ac$
 - b $bc - a$
 - c $a^2 - c^2$
 - d $b^2 - ac$
 - e $\frac{a+b}{2}$
 - f $\frac{b^2+c}{a}$
 - g $\frac{1}{c} \times (a - b)$
 - h $a^3 - bc$
- 4 Evaluate these expressions when $x = -2$, $y = -\frac{1}{2}$ and $z = \frac{1}{6}$.
- a $xy + z$
 - b $y^2 + x^2$
 - c xyz
 - d $\frac{xz + 1}{y}$

PROBLEM-SOLVING

5, 6

5, 6

6, 7

- 5 A rectangular garden bed is 12 m long and 5 m wide.
- a Find the area of the garden bed.
 - b The length is increased by x m and the width is decreased by y m. Find the new length and width of the garden.
 - c Write an expression for the area of the new garden bed.



- 6 The expression for the area of a trapezium is $\frac{1}{2}(a + b)h$ where a and b are the lengths of the two parallel sides and h is the distance between the two parallel sides.
- a Find the area of the trapezium with $a = 5$, $b = 7$ and $h = 3$.
 - b A trapezium has $h = 4$ and area 12. If a and b are positive integers, what possible values can the variable a have?
- 7 The cost of 10 identical puzzles is $\$P$.
- a Write an expression for the cost of one puzzle.
 - b Write an expression for the cost of n puzzles.

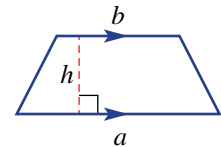

REASONING

8

8, 9

9, 10

- 8 For each of these shapes, write an expression for:

i the perimeter

ii the area

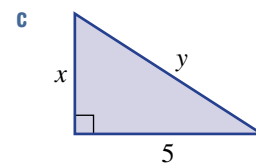
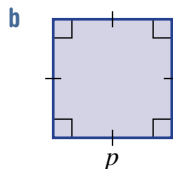
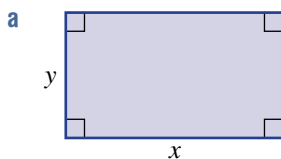

- 9 Decide if the following statements refer to the same or different expressions. If they are different, write an expression for each statement.
- a **A** Twice the sum of x and y
 - B** The sum of $2x$ and y
 - b **A** The difference between half of x and half of y
 - B** Half of the difference between x and y
- 10 For a right-angled triangle with hypotenuse c and shorter sides a and b , Pythagoras' theorem states that $c^2 = a^2 + b^2$.

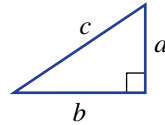

- a Which of these two descriptions also describes Pythagoras' theorem?
 - A** The square of the hypotenuse is equal to the square of the sum of the two shorter sides.
 - B** The square of the hypotenuse is equal to the sum of the squares of the two shorter sides.
- b For the incorrect description, write an equation to match.

ENRICHMENT: The sum of the first n positive integers 11

- 11 The rule for the sum of the first n positive integers is given by:
- The product of n and one more than n all divided by 2.**
- a Write an expression for the above description.
 - b Test the expression to find these sums
 - i $1 + 2 + 3 + 4$ $(n = 4)$
 - ii $1 + 2 + 3 + \dots + 10$ $(n = 10)$
 - c Another way to describe the same expression is:
 - The sum of half of the square of n and half of n .**

Write the expression for this description.
 - d Check that your expressions in parts **a** and **c** are equivalent (the same) by testing $n = 4$ and $n = 10$.
 - e $\frac{1}{2}(n^2 + n)$ is also equivalent to the above two expressions. Write this expression in words.

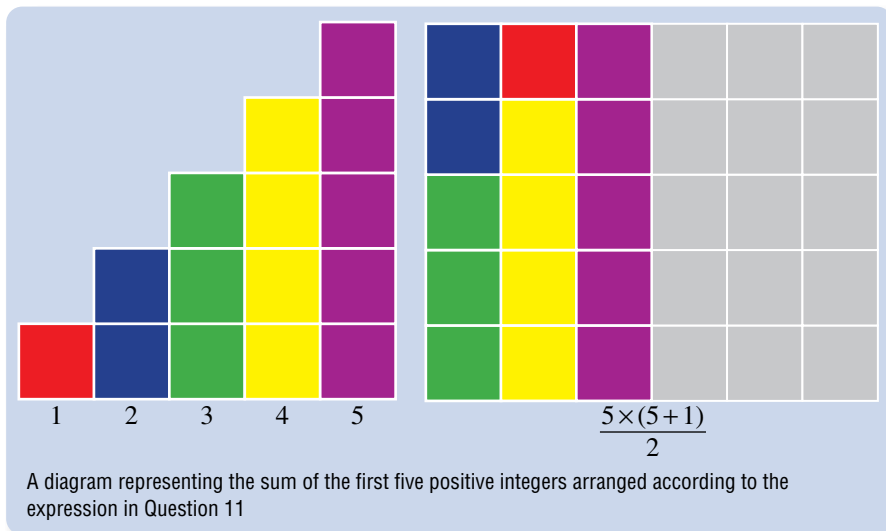

2B Simplifying algebraic expressions CONSOLIDATING

LEARNING INTENTIONS

- To review the conventions and processes for multiplication and division of algebraic terms
- To understand what is meant by 'like terms' and that only like terms can be collected under addition and subtraction
- To be able to simplify algebraic expressions using addition and subtraction

Just as $2 + 2 + 2 + 2 = 4 \times 2$, so $x + x + x + x = 4 \times x$ or $4x$. We say that the expression $x + x + x + x$ is simplified to $4x$. Similarly, $3x + 5x = 8x$ and $8x - 3x = 5x$.

All these expressions have like terms and can be simplified to an expression with a smaller number of terms.

A single term such as $2 \times 5 \times x \div 10$ can also be simplified using multiplication and division, so

$$2 \times 5 \times x \div 10 = \frac{10x}{10} = x.$$



Manufacturing companies, such as globe makers, find that an item's selling price, $\$x$, affects the number of sales and the revenue. Algebraic expressions often need to be simplified when developing formulas for a company's expenses, revenue and profit.

Lesson starter: Are they equivalent?

All these expressions can be separated into two groups. Group them so that the expressions in each group are equivalent.

$2x$

$2x - y$

$4x - x - x$

$10x - y - 8x$

$\frac{24x}{12}$

$y + x - y + x$

$2 \times x - 1 \times y$

$-y + 2x$

$0 + \frac{1}{2} \times 4x$

$\frac{x}{\left(\frac{1}{2}\right)} + 0y$

$\frac{6x^2}{3x}$

$-1 \times y + \frac{x^2}{\frac{1}{2}x}$

KEY IDEAS

- The symbols for multiplication (\times) and division (\div) are usually not shown in simplified algebraic terms.

For example: $5 \times a \times b = 5ab$ and $-7 \times x \div y^2 = -\frac{7x}{y^2}$

- When dividing algebraic expressions, common factors can be cancelled.

For example: $\frac{7x}{14} = \frac{x}{2}$, $\frac{a^2b}{a} = \frac{a^1 \times a \times b}{a^1} = ab$

$$\frac{7xy}{14y} = \frac{x}{2} \quad \text{and} \quad \frac{15a^2b}{10a} = \frac{3 \times 5^1 \times a \times a^1 \times b}{2 \times 5^1 \times a^1} = \frac{3ab}{2}$$

- **Like terms** have the same pronumeral factors.
 - For example: $5x$ and $7x$ are like terms and $3a^2b$ and $-2a^2b$ are like terms.
 - Since $a \times b = b \times a$ then ab and ba are also like terms.
- The pronumeral part of a term is often written in alphabetical order.
- **Like terms** can be collected (added and subtracted) to form a single term.
For example: $5ab + 8ab = 13ab$
 $4x^2y - 2yx^2 = 2x^2y$
- **Unlike terms** do not have the same pronumeral factors.
For example: $5x$, x^2 , xy and $\frac{4xyz}{5}$ are all unlike terms.

BUILDING UNDERSTANDING

- 1 State the missing word or expression.
 - a Like terms have the same _____ factors.
 - b $3x + 2x$ simplifies to _____.
 - c $3a^2b$ and $2a$ are _____ terms.
- 2 Simplify these fractions.

a $\frac{20}{8}$	b $\frac{30}{10}$	c $\frac{8}{40}$	d $-\frac{5}{100}$
------------------	-------------------	------------------	--------------------
- 3 Decide if the following pairs of terms are like terms.

a $4ab$ and $3ab$	b $2x$ and $7xy$	c 5 and $4m$
d $3t$ and $-6tw$	e $2mn$ and $9nm$	f $3x^2y$ and $7xy^2$



Example 4 Multiplying algebraic terms

Simplify the following.

a $3 \times 2b$

b $-2a \times 3ab$

SOLUTION

a $3 \times 2b = 3 \times 2 \times b$
 $= 6b$

b $-2a \times 3ab = -2 \times 3 \times a \times a \times b$
 $= -6a^2b$

EXPLANATION

Multiply the coefficients.

Multiply the coefficients and simplify.

Now you try

Simplify the following.

a $5 \times 7n$

b $-3x \times 6xy$



Example 5 Dividing algebraic terms

Simplify the following.

a $\frac{6ab}{18b}$

b $12a^2b \div (3ab)$

SOLUTION

a $\frac{1\cancel{6}ab^1}{3\cancel{18}b^1} = \frac{a}{3}$

b $12a^2b \div (3ab) = \frac{4\cancel{12}a^2b^1}{1\cancel{3}a^1b^1}$
 $= 4a$

EXPLANATION

Deal with numerals and pronumerals separately, cancelling where possible.

Write as a fraction first. Cancel where possible, recall $a^2 = a \times a$.

Now you try

Simplify the following.

a $\frac{4xy}{8x}$

b $-20ab^2 \div (10ab)$



Example 6 Collecting like terms

Simplify the following by collecting like terms.

a $3x + 4 - 2x$

b $3x + 2y + 4x + 7y$

c $8ab^2 - 9ab - ab^2 + 3ba$

SOLUTION

a $3x + 4 - 2x = 3x - 2x + 4$
 $= x + 4$

b $3x + 2y + 4x + 7y = 3x + 4x + 2y + 7y$
 $= 7x + 9y$

c $8ab^2 - 9ab - ab^2 + 3ba$
 $= 8ab^2 - ab^2 - 9ab + 3ab$
 $= 7ab^2 - 6ab$

EXPLANATION

Collect like terms ($3x$ and $-2x$). The sign belongs to the term that follows. Combine their coefficients: $3 - 2 = 1$.

Collect like terms and combine their coefficients.

Collect like terms. Remember $ab = ba$ and $ab^2 = 1ab^2$.
 $8 - 1 = 7$ and $-9 + 3 = -6$

Now you try

Simplify the following by collecting like terms.

a $6a + 2 - a$

b $4m + n + 2m + 6n$

c $7a^2b + ab - 4a^2b - 3ba$

Exercise 2B

FLUENCY

 $1-4(\frac{1}{2}), 6-8(\frac{1}{2})$
 $1-8(\frac{1}{2})$
 $2-8(\frac{1}{3})$

- Example 4a** 1 Simplify the following.
- | | | |
|-----------------------------------|-------------------------------------|----------------------------|
| a $3 \times 6r$ | b $2 \times 8b$ | c $-2x \times 7$ |
| d $3 \times (-5p)$ | e $-4c \times 3d$ | f $5m \times (-3n)$ |
| g $-4r \times 3 \times 2s$ | h $5j \times (-4) \times 2k$ | |
- Example 4b** 2 Simplify the following.
- | | | |
|---------------------------|-------------------------------|------------------------------|
| a $7a \times 3ab$ | b $5mn \times (-3n)$ | c $-3gh \times (-6h)$ |
| d $3xy \times 4xy$ | e $-4ab \times (-2ab)$ | f $-2mn \times 3mn$ |
- Example 5a** 3 Simplify the following by cancelling.
- | | | |
|---------------------------|--------------------------------|-----------------------------|
| a $\frac{8b}{2}$ | b $-\frac{2a}{6}$ | c $\frac{4ab}{6}$ |
| d $\frac{3mn}{6n}$ | e $-\frac{5xy}{20y}$ | f $\frac{10st}{6t}$ |
| g $\frac{u^2y}{u}$ | h $\frac{5r^2s^2}{8rs}$ | i $\frac{5ab^2}{9b}$ |
- Example 5b** 4 Simplify the following by first writing in fraction form.
- | | | |
|------------------------------|-------------------------------|------------------------------|
| a $2x \div 5$ | b $-4 \div (-3a)$ | c $11mn \div 3$ |
| d $12ab \div 2$ | e $-10 \div (2gh)$ | f $8x \div x$ |
| g $-3xy \div (yx)$ | h $7mn \div (3m)$ | i $-27pq \div (6p)$ |
| j $24ab^2 \div (8ab)$ | k $25x^2y \div (-5xy)$ | l $9m^2n \div (18mn)$ |
- 5 Simplify the following.
- | | | |
|------------------------------------|--------------------------------------|--|
| a $x \times 4 \div y$ | b $5 \times p \div 2$ | c $6 \times (-a) \times b$ |
| d $a \times (-3) \div (2b)$ | e $-7 \div (5m) \times n$ | f $5s \div (2t) \times 4$ |
| g $6 \times 4mn \div (3m)$ | h $8x \times 3y \div (8x)$ | i $3ab \times 12bc \div (9abc)$ |
| j $4x \times 3xy \div (2x)$ | k $10m \times 4mn \div (8mn)$ | l $3pq \times pq \div p$ |
- Example 6a** 6 Simplify the following by collecting like terms.
- | | | |
|--------------------------|---------------------------|----------------------------|
| a $3a + 7a$ | b $4n + 3n$ | c $12y - 4y$ |
| d $5x + 2x + 4x$ | e $6ab - 2ab - ba$ | f $7mn + 2mn - 2mn$ |
| g $4y - 3y + 8$ | h $7x + 5 - 4x$ | i $6xy + xy + 4y$ |
| j $5ab + 3 + 7ba$ | k $2 - 5m - m$ | l $4 - 2x + x$ |
- Example 6b** 7 Simplify the following by collecting like terms.
- | | | |
|-------------------------------|----------------------------------|------------------------------|
| a $2a + 4b + 3a + 5b$ | b $4x + 3y + 2x + 2y$ | c $6t + 5 - 2t + 1$ |
| d $5x + 1 + 6x + 3$ | e $xy + 8x + 4xy - 4x$ | f $3mn - 4 + 4nm - 5$ |
| g $4ab + 2a + ab - 3a$ | h $3st - 8ts + 2st + 3ts$ | |
- Example 6c** 8 Simplify the following by collecting like terms.
- | | |
|---------------------------------------|--|
| a $5xy^2 - 4xy^2$ | b $3a^2b + 4ba^2$ |
| c $8m^2n - 6nm^2 + m^2n$ | d $7p^2q^2 - 2p^2q^2 - 4p^2q^2$ |
| e $2x^2y - 4xy^2 + 5yx^2$ | f $10rs^2 + 3rs^2 - 6r^2s$ |
| g $x^2 - 7x - 3x^2$ | h $a^2b - 4ab^2 + 3a^2b + b^2a$ |
| i $10pq^2 - 2qp - 3pq^2 - 6pq$ | j $12m^2n^2 - 2mn^2 - 4m^2n^2 + mn^2$ |

PROBLEM-SOLVING

9, 10

9–11

10–12

- 9 A farmer has x pigs and y chickens.
- Write an expression for the total number of heads.
 - Write an expression for the total number of legs.
- 10 The length of a rectangle is three times its width x metres. Write an expression for:
- the rectangle's perimeter
 - the rectangle's area.



- 11 A right-angled triangle has side lengths $5x$ cm, $12x$ cm and $13x$ cm. Write an expression for:
- the triangle's perimeter
 - the triangle's area.
- 12 The average (mean) mark on a test for 20 students is x . Another student who scores 75 in the test is added to the list. Write an expression for the new average (mean).

REASONING

13

13

13, 14

- 13 Decide whether the following are always true for all real numbers.
- $a \times b = b \times a$
 - $a \div b = b \div a$
 - $a + b = b + a$
 - $a - b = b - a$
 - $a^2b = b^2a$
 - $1 \div \frac{1}{a} = a$ ($a \neq 0$)
- 14 The diagram shows the route taken by a salesperson who travels from A to D via B and C . All distances are in kilometres.
- If the salesperson then returns directly to A , write an expression (in simplest form) for the total distance travelled.
 - If $y = x + 1$, write an expression for the total distance the salesperson travels in terms of x only. Simplify your expression.
 - When $y = x + 1$, by how much would the distance have been reduced (in terms of x) if the salesperson had travelled directly from A to D and straight back to A ?

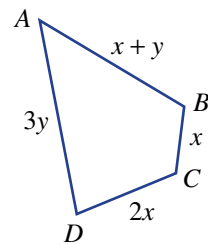

ENRICHMENT: Higher powers

-

-

15(1/2)

- 15 For this question, note this example: $\frac{2a^3}{4a} = \frac{2_1 \times a \times a \times a_1}{2_4 \times a_1} = \frac{a^2}{2}$

Simplify these expressions with higher powers.

a $\frac{a^4}{a}$

b $\frac{3b^3}{9b}$

c $\frac{4ab^3}{12ab}$

d $\frac{6a^4b^2}{16a^3b}$

e $-\frac{2a^5}{3a^2}$

f $-\frac{8a^5}{20a^7}$

g $\frac{4a^3}{10a^8}$

h $\frac{3a^3b}{12ab^4}$

i $\frac{15a^4b^2}{5ab}$

j $\frac{28a^3b^5}{7a^4b^2}$

k $\frac{2a^5b^2}{6a^2b^3}$

l $-\frac{5a^3b^7}{10a^2b^{10}}$

2C Expanding algebraic expressions

LEARNING INTENTIONS

- To understand how the distributive law is used to expand brackets
- To be able to expand brackets by multiplying through by the term outside the bracket
- To know to expand brackets first before collecting like terms when simplifying algebraic expressions

A mental technique to find the product of 5 and 23 might be to find 5×20 and add 5×3 to give 115. This technique uses the distributive law over addition.

$$\begin{aligned}\text{So } 5 \times 23 &= 5 \times (20 + 3) \\ &= 5 \times 20 + 5 \times 3\end{aligned}$$

Since pronumerals (or variables) represent numbers, the same law applies for algebraic expressions.



Portable dance floors for hire come in 1 m by 1 m squares of two types, edge squares and inner squares. For a floor x m by y m, the number of edge squares = $2x + 2(y - 2)$ and the number of inner squares = $(x - 2)(y - 2)$.

Lesson starter: Rectangular distributions

This diagram shows two joined rectangles with the given dimensions.

- Find two different ways to write expressions for the combined area of the two rectangles.
- Compare your two expressions. Are they equivalent?

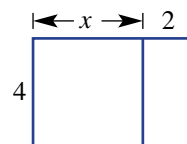

This diagram shows a rectangle of length x reduced by a length of 3.

- Find two different ways to write expressions for the remaining area (shaded).
- Compare your two expressions. Are they equivalent?

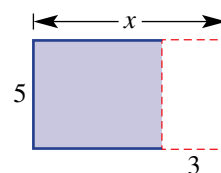

KEY IDEAS

- The **distributive law** is used to expand and remove brackets.
 - A term on the outside of the brackets is multiplied by each term inside the brackets.

$$\begin{aligned}a(b + c) &= ab + ac & \text{or} & & a(b - c) &= ab - ac \\ -a(b + c) &= -ab - ac & \text{or} & & -a(b - c) &= -ab + ac\end{aligned}$$

- If the number in front of the bracket is negative, the sign of each of the terms inside the brackets will change when expanded.

For example: $-2(x - 3) = -2x + 6$ since $-2 \times x = -2x$ and $-2 \times (-3) = 6$.

BUILDING UNDERSTANDING

1 This diagram shows two joined rectangles with the given dimensions.

a State an expression for the area of:

i the larger rectangle (x by 5)

ii the smaller rectangle (2 by 5)

b Use your answers from part a to find the combined area of both rectangles.

c State an expression for the total side length of the side involving x .

d Use your answer from part c to find the combined area of both rectangles.

e State the missing terms in this statement: $5(x + 2) = \underline{\hspace{2cm}} + \underline{\hspace{2cm}}$

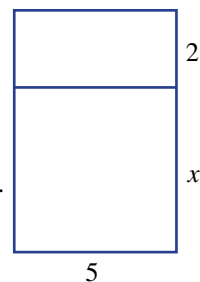

2 Complete the working for the following.

a $3(x + 5) = 3 \times \underline{\hspace{1cm}} + \underline{\hspace{1cm}} \times 5$
 $= 3x + \underline{\hspace{1cm}}$

b $4(y - 3) = 4 \times \underline{\hspace{1cm}} + 4 \times \underline{\hspace{1cm}}$
 $= 4y - \underline{\hspace{1cm}}$

c $-2(x + 3) = -2 \times x + \underline{\hspace{1cm}} \times 3$
 $= -2x - \underline{\hspace{1cm}}$

d $-3(x - 1) = -3 \times x + (-3) \times \underline{\hspace{1cm}}$
 $= -3x + \underline{\hspace{1cm}}$



Example 7 Expanding simple expressions with brackets

Expand the following.

a $3(x + 4)$

b $5(x - 11)$

c $-2(x - 5)$

SOLUTION

a $3(x + 4) = 3x + 12$

EXPLANATION

$3 \times x = 3x$ and $3 \times 4 = 12$

b $5(x - 11) = 5x - 55$

$5 \times x = 5x$ and $5 \times (-11) = -55$

c $-2(x - 5) = -2x + 10$

$-2 \times x = -2x$ and $-2 \times (-5) = +10$

Now you try

Expand the following.

a $5(x + 2)$

b $3(x - 7)$

c $-3(x - 2)$



**Example 8 Expanding brackets and simplifying**

Expand the following.

a $4(x + 3y)$

b $-2x(4x - 3)$

SOLUTION

a $4(x + 3y) = 4 \times x + 4 \times 3y$
 $= 4x + 12y$

b $-2x(4x - 3) = -2x \times 4x + (-2x) \times (-3)$
 $= -8x^2 + 6x$

EXPLANATIONMultiply each term inside the brackets by 4.
 $4 \times x = 4x$ and $4 \times 3 \times y = 12y$.Each term inside the brackets is multiplied by $-2x$.
 $-2 \times 4 = -8$, $x \times x = x^2$ and $-2 \times (-3) = 6$ **Now you try**

Expand the following.

a $3(x + 7y)$

b $-3a(2a - 4)$

**Example 9 Simplifying by removing brackets**

Expand the following and collect like terms.

a $2 + 3(x - 4)$

b $3(x + 2y) - (3x + y)$

SOLUTION

a $2 + 3(x - 4) = 2 + 3x - 12$
 $= 3x - 10$

b $3(x + 2y) - (3x + y)$
 $= 3x + 6y - 3x - y$
 $= 3x - 3x + 6y - y$
 $= 5y$

EXPLANATION

Multiply first by expanding brackets:

$$3(x - 4) = 3x - 12$$

Then combine any like terms: $2 - 12 = -10$

Expand each set of brackets where

$$-(3x + y) = -1(3x + y) = -3x - y.$$

Collect like terms and simplify.

Now you try

Expand the following and collect like terms.

a $4 + 2(y - 1)$

b $3(x - 2y) - (2x + 3y)$

Exercise 2C

FLUENCY

1–4($\frac{1}{2}$)1–5($\frac{1}{2}$)2–5($\frac{1}{4}$)

Example 7a,b

1 Expand the following.

a $2(x + 3)$

b $5(x + 12)$

c $2(x + 7)$

d $7(x - 9)$

e $3(x - 2)$

f $2(x - 6)$

g $4(7 - x)$

h $7(3 - x)$

Example 7c

2 Expand the following.

a $-3(x + 2)$

b $-2(x + 11)$

c $-5(x - 3)$

d $-6(x - 6)$

e $-4(2 - x)$

f $-13(5 + x)$

g $-20(9 + x)$

h $-300(1 - x)$

Example 8

3 Expand the following.

a $2(a + 2b)$

b $5(3a - 2)$

c $3(4m - 5)$

d $-8(2x + 5)$

e $-3(4x + 5)$

f $-4x(x - 2y)$

g $-9t(2y - 3)$

h $a(3a + 4)$

i $d(2d - 5)$

j $-2b(3b - 5)$

k $2x(4x + 1)$

l $5y(1 - 3y)$

Example 9a

4 Expand the following and collect like terms.

a $3 + 2(x + 4)$

b $4 + 6(x - 3)$

c $2 + 5(3x - 1)$

d $5 + (3x - 4)$

e $3 + 4(x - 2)$

f $7 + 2(x - 3)$

g $2 - 3(x + 2)$

h $1 - 5(x + 4)$

i $5 - (x - 6)$

j $9 - (x - 3)$

k $5 - (3 + 2x)$

l $4 - (3x - 2)$

Example 9b

5 Expand the following and collect like terms.

a $2(x + 3) + 3(x + 2)$

b $2(x - 3) + 2(x - 1)$

c $3(2x + 1) + 5(x - 1)$

d $4(3x + 2) + 5(x - 3)$

e $-3(2x + 1) + (2x - 3)$

f $-2(x + 2) + 3(x - 1)$

g $2(4x - 3) - 2(3x - 1)$

h $-3(4x + 3) - 5(3x - 1)$

i $-(x + 3) - 3(x + 5)$

j $-2(2x - 4) - 3(3x + 5)$

k $3(3x - 1) - 2(2 - x)$

l $-4(5 - x) - (2x - 5)$

PROBLEM-SOLVING

6, 7

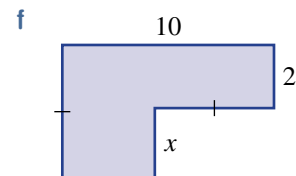
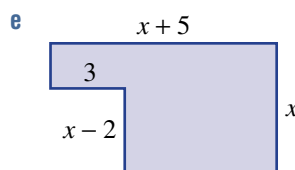
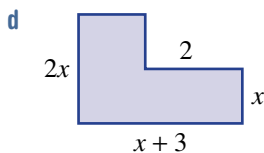
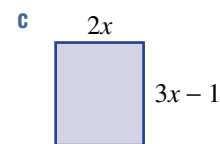
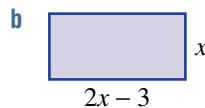
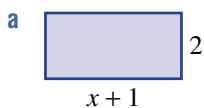
6, 7($\frac{1}{2}$), 87($\frac{1}{2}$), 8, 96 The length of a rectangle is 4 more than its width, x . Find an expanded expression for its area.7 Find the area of these basic shapes in expanded form. All angles at vertices are 90° .8 Gary gets a \$20 bonus for every computer he sells over and above his quota of 10 per week. If he sells n computers in a week and $n > 10$, write an expression for Gary's bonus in that week. (Give the answer in expanded form.)9 Jill pays tax at 20c in the dollar for every dollar earned over \$10 000. If Jill earns $\$x$ and $x > 10\,000$, write an expression in expanded form for Jill's tax.

REASONING

10

10, 11($\frac{1}{2}$)10, 11($\frac{1}{2}$)

10 Identify the errors in these expressions then write the correct expansion.

a $2(x + 6) = 2x + 6$

b $x(x - 4) = 2x - 4x$

c $-3(x + 4) = -3x + 12$

d $-7(x - 7) = -7x - 49$

e $5 - 2(x - 7) = 5 - 2x - 14$
 $= -9 - 2x$

f $4(x - 2) - 3(x + 2) = 4x - 8 - 3x + 6$
 $= x - 2$

11 In Years 7 and 8 we explored how to use the distributive law to find products mentally.

For example: $7 \times 104 = 7 \times (100 + 4)$ and $4 \times 298 = 4 \times (300 - 2)$
 $= 7 \times 100 + 7 \times 4$ $= 4 \times 300 - 4 \times 2$
 $= 728$ $= 1192$

Use the distributive law to evaluate these products mentally.

a 6×52

b 9×102

c 5×91

d 4×326

e 3×99

f 7×395

g 9×990

h 6×879

ENRICHMENT: Pronumerals and taxes

-

-

12

12 A progressive income tax system increases the tax rate for higher incomes. Here is an example.

Income	Tax
0–\$20 000	\$0
\$20 001–\$50 000	\$0 + 20% of income above \$20 000
\$50 001–\$100 000	a + 30% of income above \$50 000
\$100 000–	b + 50% of income above \$100 000



- a Find the values of a and b in the above table.
- b Find the tax payable for the following incomes.
- \$35 000
 - \$72 000
 - \$160 000
- c Find an expression for the tax payable for an income of \$ x if:
- $0 \leq x \leq 20\,000$
 - $20\,000 < x \leq 50\,000$
 - $50\,000 < x \leq 100\,000$
 - $x > 100\,000$
- d Check that you have fully expanded and simplified your expressions for part c. Add steps if required.
- e Use your expressions from parts c and d to check your answers to part b by choosing a particular income amount and checking against the table above.

2D Solving linear equations with pronumerals on one side

LEARNING INTENTIONS

- To know the definition of an equation
- To understand that linear equations are solved by creating a series of equivalent equations
- To understand that equivalent equations are created by applying the same operation to both sides of the equation
- To be able to solve a linear equation by using inverse operations
- To know that an answer can be checked by substituting into the original equation

A mathematical statement containing an equals sign, a left-hand side and a right-hand side is called an equation. $5 = 10 \div 2$, $3x = 9$, $x^2 + 1 = 10$ and $\frac{1}{x} = \frac{x}{5}$ are examples of equations. Linear equations can be written in the form $ax + b = c$ where the power of x is 1. $4x - 1 = 6$, $3 = 2(x + 1)$ and $\frac{5x}{3} = \frac{2x + 1}{4}$ are all linear equations. Equations are solved by finding the value of the variable (or pronumeral) that makes the equation true. This can be done by inspection for very simple linear equations (for example, if $3x = 15$ then $x = 5$ since $3 \times 5 = 15$). More complex linear equations can be solved through a series of steps where each step produces an equivalent equation.



Computer programmers solve linear equations when writing software code for various applications, developing websites, troubleshooting network problems, calculating data upload times and adjusting security settings.

Lesson starter: Why are they equivalent?

The following list of equations can be categorised into two groups. The equations in each group should be equivalent.

$$5x = 20$$

$$2x - 1 = -3$$

$$x = 4$$

$$1 - x = -3$$

$$7x = -7$$

$$3 - 5x = -17$$

$$\frac{8x}{5} - \frac{3x}{5} = -1$$

$$x = -1$$

- Discuss how you divided the equations into the two groups.
- How can you check to see if the equations in each group are equivalent?

KEY IDEAS

- **Equivalent equations** are created by:
 - adding or subtracting the same number on both sides of the equation
 - multiplying or dividing both sides of the equation by the same number (not including 0).
- Solve a linear equation by creating equivalent equations using **inverse operations** (sometimes referred to as **backtracking**).
- The solution to an equation can be checked by substituting the solution into the original equation and checking that both sides are equal.

BUILDING UNDERSTANDING

- 1 State the value of x that is the solution to these equations. No written working is required.

a $3x = 9$	b $\frac{x}{4} = 10$	c $x + 7 = 12$	d $x - 7 = -1$
------------	----------------------	----------------	----------------
- 2 Use a 'guess and check' (trial and error) method to solve these equations. No written working is required.

a $2x + 1 = 7$	b $4 - x = 2$	c $2 + \frac{x}{3} = 6$	d $\frac{x+1}{7} = 1$
----------------	---------------	-------------------------	-----------------------
- 3 Which of the following equations are equivalent to $3x = 12$?

A $3x - 1 = 12$	B $-3x = -12$	C $\frac{3x}{4} = 3$	D $\frac{3x}{5} = 10$
-----------------	---------------	----------------------	-----------------------



Example 10 Solving simple linear equations

Solve each of the following equations.

a $2x + 3 = 4$

b $5 - 2x = 12$

SOLUTION

a $2x + 3 = 4$

$2x = 1$

$x = \frac{1}{2}$

Check: $2 \times \left(\frac{1}{2}\right) + 3 = 4$

b $5 - 2x = 12$

$-2x = 7$

$x = -\frac{7}{2}$

Check: $5 - 2 \times \left(-\frac{7}{2}\right) = 5 + 7 = 12$

EXPLANATION

Subtract 3 from both sides.

Divide both sides by 2.

Check the answer by substituting $x = \frac{1}{2}$ into the original equation.

Subtract 5 from both sides.

Divide both sides by -2 .

Check the answer.

Now you try

Solve each of the following equations.

a $3x + 1 = 10$

b $4 - 3x = 7$



Example 11 Solving linear equations involving fractions

Solve each of the following equations

a $\frac{x}{4} - 3 = 7$

b $\frac{2x}{3} + 5 = 7$

c $\frac{x+4}{9} = 2$

SOLUTION

EXPLANATION

a $\frac{x}{4} - 3 = 7$

$$\frac{x}{4} = 10$$

$$x = 40$$

Check: $\frac{(40)}{4} - 3 = 10 - 3 = 7$

Add 3 to both sides.

Multiply both sides by 4.

Check the answer by substituting $x = 40$ into $\frac{x}{4} - 3$. Since this equals 7, $x = 40$ is the solution.

b $\frac{2x}{3} + 5 = 7$

$$\frac{2x}{3} = 2$$

$$2x = 6$$

$$x = 3$$

Check: $\frac{2 \times (3)}{3} + 5 = 2 + 5 = 7$

Subtract 5 from both sides first then multiply both sides by 3.

Divide both sides by 2.

Check the answer.

c $\frac{x+4}{9} = 2$

$$x + 4 = 18$$

$$x = 14$$

Check: $\frac{(14) + 4}{9} = \frac{18}{9} = 2$

Multiply both sides by 9 first to eliminate the fraction. Solve the remaining equation by subtracting 4 from both sides.

Check the answer.

Now you try

Solve each of the following equations

a $\frac{x}{2} - 5 = 6$

b $\frac{5x}{2} + 1 = 4$

c $\frac{x+3}{5} = 4$

Exercise 2D

FLUENCY

$1-5(\frac{1}{2})$

$1-5(\frac{1}{2})$

$1-5(\frac{1}{3})$

Example 10a

1 Solve each of the following equations. Check your answers using substitution.

a $2x + 5 = 9$

b $5a + 6 = 11$

c $3m - 4 = 8$

d $2b + 15 = 7$

e $3y - 2 = -13$

f $3a + 2 = 7$

g $4b + 7 = 25$

h $24x - 2 = 10$

i $6x - 5 = 3$

j $7y - 3 = -8$

k $2a + \frac{1}{2} = \frac{1}{4}$

l $5n - \frac{1}{4} = -1$

Example 10b 2 Solve each of the following equations.

a $12 - 2x = 18$

c $15 - 5x = 5$

e $2 - 5x = 9$

g $5 - 8x = 2$

b $2 - 7x = 9$

d $3 - 2x = -13$

f $4 - 7x = 23$

h $-3 - 4x = -10$

Example 11a 3 Solve each of the following equations.

a $\frac{t}{2} + 5 = 2$

c $\frac{y}{5} - 4 = 2$

e $\frac{s}{2} - 3 = -7$

g $\frac{m}{4} - 2 = 3$

b $\frac{a}{3} + 4 = 2$

d $\frac{x}{3} - 7 = -12$

f $\frac{x}{4} - 5 = -2$

h $1 - \frac{y}{5} = 2$

Example 11b 4 Solve these equations.

a $\frac{2b}{3} = 6$

d $\frac{2x}{5} = -3$

g $\frac{2x}{3} - 1 = 7$

j $5 + \frac{3d}{2} = -7$

b $\frac{3x}{2} = 9$

e $\frac{3x}{4} = \frac{1}{2}$

h $\frac{3x}{4} - 2 = 7$

k $11 - \frac{3f}{2} = 2$

c $\frac{4x}{3} = -9$

f $\frac{5n}{4} = -\frac{1}{5}$

i $3 + \frac{2x}{3} = -3$

l $3 - \frac{4z}{3} = 5$

Example 11c 5 Solve each of the following equations. Check your answers.

a $\frac{x+1}{3} = 4$

d $\frac{6+b}{2} = -3$

g $\frac{3m-1}{5} = 4$

j $\frac{3b-6}{2} = 5$

b $\frac{x+4}{2} = 5$

e $\frac{1-a}{2} = 3$

h $\frac{2x+2}{3} = 4$

k $\frac{4-2y}{6} = 3$

c $\frac{4+y}{3} = -2$

f $\frac{5-x}{3} = 2$

i $\frac{7x-3}{3} = 9$

l $\frac{9-5t}{3} = -2$

PROBLEM-SOLVING

6, 7

6, 7

6($\frac{1}{2}$), 7, 8

6 For each of the following, write an equation and solve it to find the unknown value. Use x as the unknown value.

a If 8 is added to a certain number, the result is 34.

b Seven less than a certain number is 21.

c I think of a number, double it and add 4. The result is 10.

d I think of a number, halve it and subtract 4. The result is 10.

e Four less than three times a number is 20.

f A number is multiplied by 7 and the product is divided by 3. The final result is 8.

7 Five Easter eggs are added to my initial collection of Easter eggs. I share them between myself and two friends and each person gets exactly four. Find how many eggs there were initially by solving an appropriate equation.



- 8 My weekly pay is increased by \$200 per week. Half of my pay now goes to pay the rent and \$100 to buy groceries. If this leaves me with \$450, what was my original weekly pay?



REASONING

9

9

9, 10

- 9 Describe the error made in each of these incorrect solutions.

a $2x - 1 = 4$
 $x - 1 = 2$
 $x = 3$

b $\frac{5x+2}{3} = 7$
 $\frac{5x}{3} = 5$
 $5x = 15$
 $x = 3$

c $5 - x = 12$
 $x = 7$

d $\frac{x}{3} - 4 = 2$
 $x - 4 = 6$
 $x = 10$

- 10 An equation like $2(x + 3) = 8$ can be solved without expanding the brackets. The first step is to divide both sides by 2.

- a Use this approach to solve these equations.

i $3(x - 1) = 12$

ii $4(x + 2) = -4$

iii $7(5x + 1) = 14$

iv $5(1 - x) = -10$

v $-2(3x + 1) = 3$

vi $-5(1 - 4x) = 1$

- b By considering your solutions to the equations in part a, when do you think this method is most appropriate?

ENRICHMENT: Changing the subject

-

-

11(1/2)

- 11 Make a the subject of each of the following equations; that is, a should be on the left-hand side on its own.

a $a - b = c$

b $2a + b = c$

c $c - ab = 2d$

d $b = \frac{a}{c} - d$

e $\frac{ab}{c} = -d$

f $\frac{2a}{b} = \frac{1}{c}$

g $\frac{2ab}{c} - 3 = -d$

h $b - \frac{ac}{2d} = 3$

i $\frac{a+b}{c} = d$

j $\frac{b-a}{c} = -d$

k $\frac{ad-6c}{2b} = e$

l $\frac{d-4ac}{e} = 3f$

2E Solving equations with brackets and pronumerals on both sides

LEARNING INTENTIONS

- To know that equations involving brackets can be solved by first expanding the brackets
- To know to solve equations with variables on both sides by collecting variables on one side of the equation
- To be able to add or subtract terms to both sides of the equation to solve the equation

More complex linear equations may have pronumerals on both sides of the equation and/or brackets. Examples are $3x = 5x - 1$ or $4(x + 2) = 5x$. Brackets can be removed by expanding and equations with pronumerals on both sides can be solved by collecting like terms using addition and subtraction.



More complex equations require several steps completed in the correct order to maintain the balance and undo all the operations that have been applied around the pronumeral.

Lesson starter: Steps in the wrong order

The steps to solve $3(2 - x) = -2(2x - 1)$ are listed here in the incorrect order.

$$\begin{aligned} 3(2 - x) &= -2(2x - 1) \\ x &= -4 \\ 6 + x &= 2 \\ 6 - 3x &= -4x + 2 \end{aligned}$$

- Arrange them in the correct order working from top to bottom.
- By considering all the steps in the correct order, explain what has happened in each step.

KEY IDEAS

- Equations with brackets can be solved by first expanding the brackets.
For example: $3(x + 1) = 2$ becomes $3x + 3 = 2$.
- If an equation has pronumerals on both sides, collect to one side by adding or subtracting one of the terms.
For example: $3x + 4 = 2x - 3$ becomes $x + 4 = -3$ by subtracting $2x$ from both sides.

BUILDING UNDERSTANDING

- State the result from expanding and simplifying these expressions.

a $3(x - 4) + x$	b $2(1 - x) + 2x$	c $3(x - 1) + 2(x - 3)$
------------------	-------------------	-------------------------
- State the next line of working for the given equations and instructions.

a $2(x + 3) = 5$	(expand the brackets)	
b $5 + 2(x - 1) = 7$	(expand the brackets)	
c $3x + 1 = x - 6$	(subtract x from both sides)	
d $4x - 3 = 2x + 1$	(subtract $2x$ from both sides)	

**Example 12 Solving equations with brackets**

Solve each of the following equations.

a $2(3x - 4) = 11$

b $2(x + 3) - 4x = 8$

SOLUTION

a $2(3x - 4) = 11$

$6x - 8 = 11$

$6x = 19$

$x = \frac{19}{6} \text{ or } 3\frac{1}{6}$

b $2(x + 3) - 4x = 8$

$2x + 6 - 4x = 8$

$-2x + 6 = 8$

$-2x = 2$

$x = -1$

EXPLANATIONExpand the brackets: $2(3x - 4) = 2 \times 3x + 2 \times (-4)$.

Add 8 to both sides then divide both sides by 6, leaving your answer in fraction form.

Expand the brackets and collect any like terms,

i.e. $2x - 4x = -2x$.

Subtract 6 from both sides.

Divide by -2 .**Now you try**

Solve each of the following equations.

a $3(2x - 1) = 4$

b $5(x + 2) - 2x = 19$

**Example 13 Solving equations with pronumerals on both sides**

Solve each of the following equations.

a $5x - 2 = 3x - 4$

b $3(2x + 4) = 8(x + 1)$

SOLUTION

a $5x - 2 = 3x - 4$

$2x - 2 = -4$

$2x = -2$

$x = -1$

b $3(2x + 4) = 8(x + 1)$

$6x + 12 = 8x + 8$

$12 = 2x + 8$

$4 = 2x$

$2 = x$

$\therefore x = 2$

EXPLANATIONCollect x terms on one side by subtracting $3x$ from both sides.

Add 2 to both sides and then divide both sides by 2.

Expand the brackets on each side.

Subtract $6x$ from both sides, alternatively subtract $8x$ to end up with $-2x + 12 = 8$. (Subtracting $6x$ keeps the x -coefficient positive.)Solve the equation and make x the subject.**Now you try**

Solve each of the following equations.

a $7x - 1 = 5x - 7$

b $4(2x - 3) = 5(x + 6)$

Exercise 2E

FLUENCY

1–3($\frac{1}{2}$)1–4($\frac{1}{2}$)1–4($\frac{1}{3}$)

Example 12a

1 Solve each of the following equations by first expanding the brackets.

a $3(m + 4) = 31$

b $5(y - 7) = 12$

c $4(p + 5) = 35$

d $2(k - 5) = 9$

e $4(5 - b) = 18$

f $2(1 - m) = 13$

g $5(3 - x) = 19$

h $7(2a + 1) = 8$

i $4(3x - 2) = 30$

j $3(3n - 2) = 0$

k $5(3 - 2x) = 6$

l $6(1 - 2y) = -8$

Example 12b

2 Expand and simplify then solve each of the following equations.

a $2(x + 4) + x = 14$

b $2(x - 3) - 3x = 4$

c $6(x + 3) + 2x = 26$

d $3(x + 2) + 5x = 46$

e $3(2x - 3) + x = 12$

f $(3x + 1) + 3x = 19$

g $4(x - 1) + x - 1 = 0$

h $3(2x + 3) - 1 - 4x = 4$

Example 13a

3 Solve each of the following equations.

a $5b = 4b + 1$

b $8a = 7a - 4$

c $4t = 10 - t$

d $3m - 8 = 2m$

e $5x - 3 = 4x + 5$

f $9a + 3 = 8a + 6$

g $12x - 3 = 10x + 5$

h $3y + 6 = 2 - y$

i $5m - 4 = 1 - 6m$

Example 13b

4 Solve each of the following equations.

a $5(x - 2) = 2x - 13$

b $3(a + 1) = a + 10$

c $3(y + 4) = y - 6$

d $2(x + 5) = x - 4$

e $5b - 4 = 6(b + 2)$

f $2(4m - 5) = 4m + 2$

g $3(2a - 3) = 5(a + 2)$

h $4(x - 3) = 3(3x + 1)$

i $3(x - 2) = 5(x + 4)$

j $3(n - 2) = 4(n + 5)$

k $2(a + 5) = -2(2a + 3)$

l $-4(x + 2) = 3(2x + 1)$

PROBLEM-SOLVING

5, 6

5($\frac{1}{2}$), 6

6, 7

5 Using x for the unknown number, write down an equation then solve it to find the number.

a The product of 2 and 3 more than a number is 7.

b The product of 3 and 4 less than a number is -4 .

c When 2 less than 3 lots of a number is doubled the result is 5.

d When 5 more than 2 lots of a number is tripled the result is 10.

e 2 more than 3 lots of a number is equivalent to 8 lots of the number.

f 2 more than 3 times the number is equivalent to 1 less than 5 times the number.

g 1 less than a doubled number is equivalent to 5 more than 3 lots of the number.

6 Since Tara started work her original hourly wage has been tripled, then decreased by \$6. It is now to be doubled so that she gets \$18 an hour. Write an equation and solve it to find Tara's original hourly wage.



- 7 At the start of lunch, Jimmy and Jake each brought out a new bag of x marbles to play with their friends. By the end of lunch, they were surprised to see they had an equal number of marbles, even though overall Jimmy had gained 5 marbles and Jake had ended up with double the result of 3 less than his original amount. How many marbles were originally in each bag?



REASONING

8, 9

8, 9

9, 10

- 8 Consider the equation $3(x - 2) = 9$.
- Solve the equation by first dividing both sides by 3.
 - Solve the equation by first expanding the brackets.
 - Which of the above two methods is preferable and why?
- 9 Consider the equation $3(x - 2) = 7$.
- Solve the equation by first dividing both sides by 3.
 - Solve the equation by first expanding the brackets.
 - Which of the above two methods is preferable and why?
- 10 Consider the equation $3x + 1 = 5x - 7$.
- Solve the equation by first subtracting $3x$ from both sides.
 - Solve the equation by first subtracting $5x$ from both sides.
 - Which of the above two methods is preferable and why? Describe the differences.

ENRICHMENT: Literal solutions with factorisation

–

–

11($\frac{1}{2}$)

- 11 Literal equations contain a variable (such as x) and other variables (or pronumerals) such as a , b and c . To solve such an equation for x , factorisation can be used as shown here.

$$ax = bx + c$$

$$ax - bx = c$$

$$x(a - b) = c$$

$$x = \frac{c}{a - b}$$

Subtract bx from both sides.
Factorise by taking out x .
Divide both sides by $(a - b)$.
(Note: $a \neq b$.)

Solve each of the following for x in terms of the other pronumerals by using factorisation.

- | | |
|---|--|
| <p>a $ax = bx + d$</p> <p>c $5ax = bx + c$</p> <p>e $ax - bc = xb - ac$</p> <p>g $ax - bx - c = d + bd$</p> | <p>b $ax + 1 = bx + 3$</p> <p>d $3ax + 1 = 4bx - 5$</p> <p>f $a(x - b) = x - b$</p> <p>h $a(x + b) = b(x - c) - x$</p> |
|---|--|



Using a CAS calculator 2E: Solving equations

This activity is in the Interactive Textbook in the form of a printable PDF.

2F Solving word problems

LEARNING INTENTIONS

- To be able to identify the unknown in a word problem
- To know how to define a variable to represent the unknown
- To be able to interpret a question and write an equation to represent the scenario
- To know how to apply algebraic processes to solve the equation and answer the problem in words

Many types of problems can be solved by writing and solving linear equations. Often problems are expressed only in words. Reading and understanding the problem, defining a variable and writing an equation become important steps in solving the problem.

Lesson starter: Too much television?

Three friends, Rick, Kate and Sue, compare how much television they watch in a week at home. Kate watches three times as much television as Rick and Sue watches 4 hours less television than Kate. In total they watch 45 hours of television. Find the number of hours of television watched by Rick.

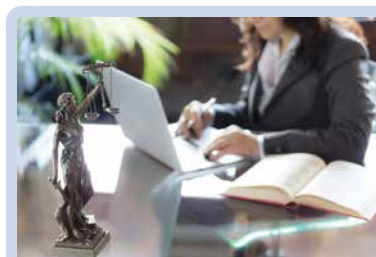

Lawyers can use linear equations when distributing inherited money. For example, if the first recipient receives $\$x$, the second person might receive $\$5000$ less and the third person could receive twice the second person's amount.

- Let x hours be the number of hours of television watched by Rick.
- Write expressions for the number of hours of television watched by Kate and by Sue.
- Write an equation to represent the information above.
- Solve the equation.
- Answer the question in the original problem.

KEY IDEAS

- To solve a **word problem** using algebra:
 - Read the problem and find out what the question is asking for.
 - Define a variable and write a statement such as: 'Let x be the number of ...'. The variable is often what you have been asked to find.
 - Write an equation using your defined variable to show the relationship between the facts in the question.
 - Solve the equation.
 - Answer the question in words.
 - Check that the solution makes sense.

BUILDING UNDERSTANDING

- 1 Give an equation for these situations.
 - a One less than twice a number is 11.
 - b Ben earns $\$x$ per week. $\$100$ plus two weeks' earnings gives $\$2200$.
 - c Maggie and Doris score 60 points between them and Doris scores 12 more points than Maggie.
 - d An engineer charges a total of $\$480$ including a $\$100$ up-front fee plus $\$80$ per hour for n hours work.

**Example 14** Turning a word problem into an equation

Five less than a certain number is 9 less than three times the number. Write an equation and solve it to find the number.

SOLUTION

Let x be the number.

$$x - 5 = 3x - 9$$

$$-5 = 2x - 9$$

$$4 = 2x$$

$$x = 2$$

The number is 2.

EXPLANATION

Define the unknown as a pronumeral.

5 less than x is $x - 5$ and this equals 9 less than three times x , i.e. $3x - 9$.

Subtract x from both sides and solve the equation.

Write the answer in words.

Now you try

Two more than a certain number is 3 less than double the number. Write an equation and solve it to find the number.

**Example 15** Solving word problems

David and Mitch made 254 runs between them in a cricket match. If Mitch made 68 more runs than David, how many runs did each of them make?

SOLUTION

Let the number of runs for David be r .

Number of runs Mitch made is $r + 68$.

$$r + (r + 68) = 254$$

$$2r + 68 = 254$$

$$2r = 186$$

$$r = 93$$

David made 93 runs and Mitch made

$$93 + 68 = 161 \text{ runs.}$$

EXPLANATION

Define the unknown value as a pronumeral.

Write all other unknown values in terms of r .

Write an equation: number of runs for

David + number of runs for Mitch = 254.

Subtract 68 from both sides and then divide both sides by 2.

Express the answer in words.

Now you try

Flora and Jo raised \$426 between them in a fundraising effort. If Jo raised \$52 more than Flora, how much did each of them raise?

Exercise 2F

FLUENCY

1–6

1–7

2, 4, 5, 7, 8

Example 14

- 1 For each of the following examples, make x the unknown number and write an equation.
- A number when doubled results in a number that is 5 more than the original number.
 - Eight less than a certain number is 2 more than three times the number.
 - Three less than a certain number is 9 less than four times the number.
 - Seven is added to a number and the result is then multiplied by 3. The result is 9.

Example 15

- 2 Leonie and Emma scored 28 goals between them in a netball match. Leonie scored 8 more goals than Emma.
- Define a variable for the number of goals scored by Emma.
 - Write the number of goals scored by Leonie in terms of the variable in part **a**.
 - Write an equation in terms of your variable to represent the problem.
 - Solve the equation in part **c** to find the unknown value.
 - How many goals did each of them score?



- 3 A rectangle is four times as long as it is wide and its perimeter is 560 cm.
- Define a variable for the unknown width.
 - Write an expression for the length in terms of your variable in part **a**.
 - Write an equation involving your variable to represent the problem. Draw and label a rectangle to help you.
 - Solve the equation in part **c**.
 - What is the length and width of the rectangle?
- 4 Toni rented a car for a total cost of \$290. If the rental company charged \$40 per day, plus a hiring fee of \$50, for how many days did Toni rent the car?



- 5 Anthony walked a certain distance, and then ran twice as far as he walked. He then caught a bus for the last 2 km. If he travelled a total of 32 km, find how far Anthony walked and ran.
- 6 A prize of \$1000 is divided between Adele and Benita so that Adele receives \$280 more than Benita. How much did they each receive?
- 7 Kate is three times as old as her son. If Kate is 30 years older than her son, what are their ages?
- 8 Andrew, Brenda and Cammi all work part-time at a supermarket. Cammi earns \$20 more than Andrew and Brenda earns \$30 less than twice Andrew's wage. If their total combined wage is \$400, find how much each of these workers earns.

PROBLEM-SOLVING

9–12

9, 11–14

11–15

- 9 A train station is between the towns Antville and Bugville. The station is four times as far from Bugville as it is from Antville. If the distance from Antville to Bugville is 95 km, how far is it from Antville to the station? (*Hint:* Draw a diagram to help you picture the problem.)



- 10 If I multiply my age in six years' time by three, the resulting age is my mother's age now. If my mother is currently 48 years old, how old am I?
- 11 The second leg in a yacht race was half the length of the first leg, the third leg was two-thirds of the length of the second leg, and the last leg was twice the length of the second leg. If the total distance was 153 km, find the length of each leg.



- 12 Twelve years ago Eric's father was seven times as old as Eric was. If Eric's father is now 54 years old, how old is Eric now?
- 13 Macy bought a total of 12 fiction and non-fiction books. The fiction books cost \$12 each and the non-fiction books cost \$25 each. If she paid \$248 altogether, how many of each kind of book did she purchase? Define the number of non-fiction books bought in terms of the number of fiction books bought.
- 14 The Ace Bicycle Shop charges a flat fee of \$4, plus \$1 per hour, for the hire of a bicycle. The Best Bicycle Shop charges a flat fee of \$8, plus 50 cents per hour. Connie and her friends hire three bicycles from Ace, and David and his brother hire two bicycles from Best. After how many hours will their hire costs be the same?
- 15 Car A left Melbourne for Adelaide at 11:00 a.m. and travelled at an average speed of 70 km/h. Car B left Melbourne for Adelaide at 1:00 p.m. on the same day and travelled at an average speed of 90 km/h. At what time will Car B catch Car A?

REASONING

16

16, 17

17, 18

- 16 Two paddocks in the shapes shown below are to be fenced with wire. If the same total amount of wire is used for each paddock, what are the dimensions of each paddock in metres?

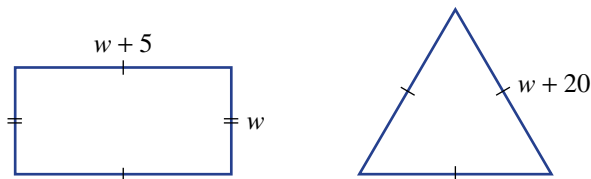

- 17 Consecutive integers can be represented algebraically as x , $x + 1$, $x + 2$ etc.
- Find three consecutive numbers that add to 84.
 - Write three consecutive even numbers starting with x .
 - Find three consecutive even numbers that add to 18.
 - Write three consecutive odd numbers starting with x .
 - Find three consecutive odd numbers that add to 51.
 - Write three consecutive multiples of 3 starting with x .
 - Find three consecutive multiples of 3 that add to 81.
- 18 Tedco produces a teddy bear which sells for \$24. Each teddy bear costs the company \$8 to manufacture and there is an initial start-up cost of \$7200.
- Write a rule for the total cost, $\$T$, of producing x teddy bears.
 - If the cost of a particular production run was \$9600, how many teddy bears were manufactured in that run?
 - Write a rule for the revenue, $\$R$, received by the company when x teddy bears are sold.
 - How many teddy bears were sold if the revenue was \$8400?
 - If they want to make an annual profit of \$54 000, how many teddy bears need to be sold?



ENRICHMENT: Worded challenges

–

–

19–21

- 19 An art curator was investigating the price trends of two art works that had the same initial value. The first painting, 'Green poles', doubled in value in the first year then lost \$8000 in the second year. In the third year its value was three-quarters of that of the previous year. The second painting, 'Orchids', added \$10 000 to its value in the first year. In the second year its value was only a third of that of the previous year. In the third year its value improved to double that of the previous year. If the value of the two paintings was the same in the third year, write an equation and solve it to find the initial value of each painting.
- 20 Julia drove to her holiday destination over a period of five days. On the first day she travels a certain distance, on the second day she travels half that distance, on the third day a third of that distance, on the fourth day one-quarter of the distance and on the fifth day one-fifth of the distance. If her destination was 1000 km away, write an equation and solve it to find how far she travelled on the first day, to the nearest kilometre.
- 21 Anna King is x years old. Her brother Henry is two-thirds of her age and her sister Chloe is three times Henry's age. The twins who live next door are 5 years older than Anna. If the sum of the ages of the King children is equal to the sum of the ages of the twins, find the ages of all the children.



2A

- 1 Write an algebraic expression for each of the following.
- The number of tickets required for 5 boys, x girls and y adults
 - 15 less than the product of 4 and y
 - The sum of the squares of k and p
 - The square of the difference between m and n
 - The square root of 16 more than x

2A

- 2 Evaluate these expressions when $x = 4$ and $y = -2$.

a $x^2 - y^2$ b $5y - 3(x - y)$ c $\frac{x + y}{x}$ d $\frac{3xy}{2}$

2B

- 3 Simplify the following.

a $2a \times 7b$ b $5pq \times (-8p)$ c $\frac{12k}{3km}$ d $30xy^2 \div (-5xy)$

2B

- 4 Simplify the following by collecting like terms.

a $6x + 7 - 4x$
 b $7 - 3mk + 4km + 4$
 c $8xy - 3x - 3yx + 2x$
 d $a^2b + ba + b^2a - ab + b$

2C

- 5 Expand the following.

a $4(a + 7)$ b $-3x(2x - 5)$

2C

- 6 Expand the following and collect like terms.

a $10 + 3(a - 2)$ b $4(2x + y) - 3(x + 2y)$

2D

- 7 Solve the following equations.

a $3x - 7 = 5$ b $\frac{a}{3} - 5 = 2$
 c $9 - 2p = 16$ d $\frac{3t}{5} - 4 = 8$
 e $\frac{3 - x}{4} = -2$ f $\frac{3k - 6}{3} = 5$

2E

- 8 Solve the following equations.

a $3(x - 4) = 7$
 b $4(3a + 1) - 3a = 31$
 c $7m - 4 = 3m - 12$
 d $3(2y + 1) = 8(y - 2)$

2F

- 9 For each of the following examples, make x the unknown number and write an equation.

- Five is added to a number and this is then multiplied by 2. The result is 14.
- Nine less than a certain number is 6 more than four times the number.

2F

- 10 Andy's soccer team scores 14 more goals for the season than Jed's team. The two teams score a total of 30 goals for the season. Solve an appropriate equation to find the number of goals scored by Andy's team.

2F

- 11 If I multiply my age in five years' time by four, the resulting age is my grandfather's age now. If my grandfather is currently 88 years old, set up and solve an equation to determine how old I am now.

2G Solving linear inequalities

LEARNING INTENTIONS

- To be able to work with the symbols $>$, \geq , $<$, \leq
- To understand that an inequality represents an infinite set of values
- To be able to illustrate an inequality on a number line using known conventions
- To understand when an inequality symbol needs to be reversed
- To be able to solve a linear inequality

An inequality (or inequation) is a mathematical statement which uses a $<$, \leq , $>$ or \geq symbol. Here are some examples of inequalities:

$$2 < 6, 5 \geq -1, 3x + 1 \leq 7 \text{ and } 2x + \frac{1}{3} > \frac{x}{4}$$

Inequalities can represent an infinite set of numbers. For example, the inequality $2x < 6$ means that $x < 3$ and this is the infinite set of all real numbers less than 3.

Lesson starter: Infinite solutions

Greg, Kevin and Greta think that they all have a correct solution to this inequality:

$$4x - 1 \geq x + 6$$

Greg says $x = 4$ is a solution.

Kevin says $x = 10$ is a solution.

Greta says $x = 100$ is a solution.

- Use substitution to show that they are all correct.
- Can you find the smallest whole number that is a solution to the inequality?
- Can you find the smallest number (including fractions) that satisfies the inequality? What method leads you to your answer?



The altitude, h , that passenger planes can successfully and economically fly at can be represented by an inequality: $0 < h \leq 40\,000$ feet or $0 < h \leq 12$ km.

KEY IDEAS

■ **Inequalities** can be illustrated using a number line because a line represents an infinite number of points.

- Use an **open circle** when showing $>$ (greater than) or $<$ (less than).

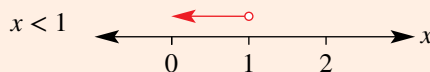
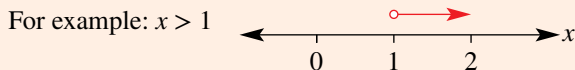

- Use a **closed circle** when showing \geq (greater than or equal to) or \leq (less than or equal to).

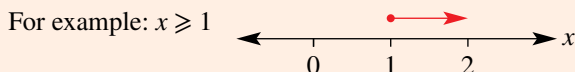

- A **set** of numbers may have both an upper and lower bound.

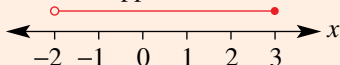
For example: $-2 < x \leq 3$ 

- Linear inequalities can be solved in a similar way to linear equations.

- All the numbers that satisfy an inequality are called a **solution set**.
- If we multiply or divide both sides of an inequality by a negative number, the inequality symbol is reversed.
For example: $5 < 8$ but $-5 > -8$, so if $-x > 1$ then $x < -1$.
- If we swap the sides of an inequality, then the inequality symbol is reversed.
For example: $3 < 7$ but $7 > 3$ so if $2 > x$ then $x < 2$.

BUILDING UNDERSTANDING

- 1 State the missing symbol $<$ or $>$ to make each statement true.

a $3 \square 2$

b $-1 \square 4$

c $-7 \square -3$

d $5 \square -50$

- 2 Match the inequalities **a**, **b** and **c** with the number lines **A**, **B** and **C**.

a $x < 2$

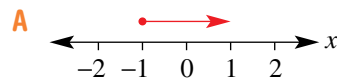

b $x \geq -1$

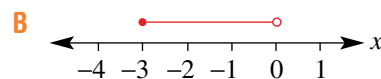

c $-3 \leq x < 0$

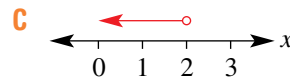

Example 16 Representing inequalities on a number line

Show each of the following examples on a number line.

a x is less than 6, ($x < 6$).

b x is greater than or equal to 2, ($x \geq 2$).

c x is greater than -2 but less than or equal to 3, ($-2 < x \leq 3$).

SOLUTION

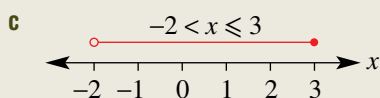
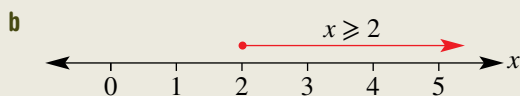
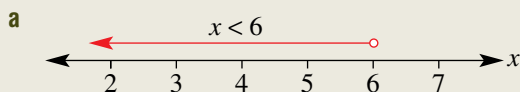

EXPLANATION

An open circle is used to indicate that 6 is not included.

A closed circle is used to indicate that 2 is included.

An open circle is used to indicate that -2 is not included and a closed circle is used to indicate that 3 is included.

Now you try

Show each of the following examples on a number line.

- a x is less than 4, ($x < 4$).
 b x is greater than or equal to -3 , ($x \geq -3$).
 c x is greater than -3 but less than or equal to 1, ($-3 < x \leq 1$).

**Example 17 Solving linear inequalities**

Find the solution set for each of the following inequalities.

- a $x - 3 < 7$
 b $5 - 2x > 3$
 c $\frac{d}{4} - 3 \geq -11$
 d $2a + 7 \leq 6a + 3$

SOLUTION

- a $x - 3 < 7$
 $x < 10$
- b $5 - 2x > 3$
 $-2x > -2$
 $x < 1$
- c $\frac{d}{4} - 3 \geq -11$
 $\frac{d}{4} \geq -8$
 $d \geq -32$
- d $2a + 7 \leq 6a + 3$
 $7 \leq 4a + 3$
 $4 \leq 4a$
 $1 \leq a$
 $a \geq 1$

EXPLANATION

Add 3 to both sides.

Subtract 5 from both sides.
 Divide both sides by -2 , and reverse the inequality symbol.

Add 3 to both sides.

Multiply both sides by 4; the inequality symbol does not change.

Gather pronumerals on one side by subtracting $2a$ from both sides.
 Subtract 3 from both sides and then divide both sides by 4.
 Place the variable a on the left and reverse the inequality symbol.

Now you try

Find the solution set for each of the following inequalities.

- a $x - 2 < 9$
 b $4 - 3x > 7$
 c $\frac{a}{3} + 1 \geq -2$
 d $3a - 1 \leq 5a + 6$

Exercise 2G

FLUENCY

1-4(1/2)

1-6(1/2)

1-6(1/3)

Example 16

1 Show each of the following inequalities on a number line.

a $x > 2$

b $x \leq 4$

c $x \geq -1$

d $-1 < x < 1$

e $0 \leq x \leq 3$

f $-3 < x \leq 4$

Example 17a

2 Find the solution set for each of the following inequalities.

a $x + 5 < 8$

b $b - 2 > 3$

c $y - 8 > -2$

d $5x \geq 15$

e $4t > -20$

f $y + 10 \geq 0$

g $3m - 7 < 11$

h $4a + 6 \geq 12$

i $7x - 5 < 2$

Example 17b

3 Find the solution set for each of the following inequalities.

a $4 - 3x > -8$

b $2 - 4n \geq 6$

c $4 - 5x \leq 1$

d $7 - a \leq 3$

e $5 - x \leq 11$

f $7 - x \leq -3$

g $-2x - 3 > 9$

h $-4t + 2 \geq 10$

i $-6m - 14 < 15$

Example 17c

4 Find the solution set for each of the following inequalities.

a $\frac{x}{2} - 5 \leq 3$

b $3 - \frac{x}{9} \geq 4$

c $\frac{2x}{5} \leq 8$

d $\frac{2x+6}{7} < 4$

e $\frac{3x-4}{2} > -6$

f $\frac{1-7x}{5} \leq 3$

5 Solve these inequalities involving brackets.

a $4(x + 2) < 12$

b $-3(a + 5) > 9$

c $5(3 - x) \geq 25$

d $2(3 - x) > 1$

e $5(y + 2) < -6$

f $-7(1 - x) < -11$

Example 17d

6 Find the solution set for each of the following inequalities.

a $2x + 9 \leq 6x - 1$

b $6t + 2 > t - 1$

c $7y + 4 \leq 7 - y$

d $3a - 2 < 4 - 2a$

e $1 - 3m \geq 7 - 4m$

f $7 - 5b > -4 - 3b$

PROBLEM-SOLVING

7-9

8-10

9-11

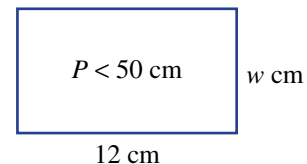
7 Wendy is x years old and Jay is 6 years younger. The sum of their ages is less than 30. Write an inequality involving x and solve it. What can you say about Wendy's age?8 The perimeter of a particular rectangle needs to be less than 50 cm. If the length of the rectangle is 12 cm and the width is w cm, write an inequality involving w and solve it. What width does the rectangle need to be?

9 How many integers satisfy both of the given inequalities?

a $2x + 1 \leq 5$ and $5 - 2x \leq 5$

b $7 - 3x > 10$ and $5x + 13 > -5$

c $\frac{x+1}{3} \geq -2$ and $2 - \frac{x}{3} > 3$

d $\frac{5x+1}{6} < 2$ and $\frac{x}{3} < 2x - 7$

10 The width of a rectangular area is 10 m and its height is $(2x - 4)$ m. If the area is less than 80 m^2 , what are the possible integer values for x ?

- 11 Two car rental companies have the following payment plans:
Carz: \$90 per week and 15c per kilometre
Renta: \$110 per week and 10c per kilometre
 What is the maximum whole number of kilometres that can be travelled in one week with *Carz* if it is to cost less than it would with *Renta*?



REASONING

12

12, 13

13, 14

- 12 a Consider the inequality $2 > x$.
- List five values of x between -1 and 2 which make the inequality true.
 - What must be true about all the values of x if the inequality is true?
- b Consider the inequality $-x < 5$.
- List five values of x which make the inequality true.
 - What must be true about all the values of x if the inequality is true?
- c Complete these statements.
- If $a > x$ then x ____.
 - If $-x < a$ then x ____.
- 13 Consider the equation $9 - 2x > 3$.
- Solve the equation by first adding $2x$ to both sides, then solve for x .
 - Solve the equation by first subtracting 9 from both sides.
 - What did you have to remember to do in part **b** to ensure that the answer is the same as in part **a**?
- 14 Combine all your knowledge from this chapter so far to solve these inequalities.
- $\frac{2(x+1)}{3} > x+5$
 - $2x+3 \geq \frac{x-6}{3}$
 - $\frac{2-3x}{2} < 2x-1$
 - $\frac{4(2x-1)}{3} \leq x+3$
 - $1-x > \frac{7(2-3x)}{4}$
 - $2(3-2x) \leq 4x$

ENRICHMENT: Literal inequalities

-

-

15(1/2)

- 15 Given a, b, c and d are positive numbers and that $1 < a < b$, solve each of the following for x .
- $ax - b > -c$
 - $b - x \leq a$
 - $\frac{x}{a} - b \leq c$
 - $\frac{bx}{c} \leq a$
 - $\frac{ax+b}{c} < d$
 - $\frac{b-2x}{c} \leq d$
 - $a(x+b) < c$
 - $\frac{ax-b}{c} > -d$
 - $a(b-x) > c$
 - $ax+b \leq x-c$
 - $ax+b > bx-1$
 - $b-ax \leq c-bx$

2H Using formulas

LEARNING INTENTIONS

- To understand what a formula represents and to be able to identify the subject of a formula
- To be able to find an unknown in a formula by substituting values and evaluating or by solving an equation
- To understand what it means to transpose a formula
- To be able to apply steps similar to solving equations to transpose a formula

A formula (or rule) is an equation that relates two or more variables. You can find the value of one of the variables if you are given the value of all others. Some common formulas contain squares, square roots, cubes and cube roots. The following are some examples of formulas.

- $A = \pi r^2$ is the formula for finding the area, A , of a circle given its radius, r .
- $F = \frac{9}{5}C + 32$ is the formula for converting degrees Celsius, C , to degrees Fahrenheit, F .
- $d = vt$ is the formula for finding the distance, d , given the velocity, v , and time, t .

A , F and d are said to be the subjects of the formulas given above.



Doctors and nurses calculate the amount of medicine, C , for a child using Young's formula: $C = \frac{a}{a+12} \times D$, where a is the child's age in years, and D is the quantity of the adult dose.

Lesson starter: Common formulas

As a class group, try to list at least 10 formulas that you know.

- Write down the formulas and describe what each variable represents.
- Which variable is the subject of each formula?

KEY IDEAS

- The **subject** of a **formula** is a variable that usually sits on its own on the left-hand side. For example, the C in $C = 2\pi r$ is the subject of the formula.
- A variable in a formula can be evaluated by substituting numbers for all other variables.
- A formula can be **transposed** (rearranged) to make another variable the subject.
 $C = 2\pi r$ can be transposed to give $r = \frac{C}{2\pi}$.
 - To transpose a formula use similar steps as you would for solving an equation, since variables represent numbers.
- Note that $\sqrt{a^2} = a$ if $a \geq 0$ and $\sqrt{a^2 + b^2} \neq a + b$ provided a or b is not zero.

BUILDING UNDERSTANDING

- 1 State the letter that is the subject of these formulas.
- a $A = \frac{1}{2}bh$ b $D = b^2 - 4ac$ c $M = \frac{a+b}{2}$ d $A = \pi r^2$
- 2 Describe the first step when attempting to transpose these formulas to make a the subject.
- a $2a + 3 = b$ b $\frac{a-c}{4} = d$ c $\sqrt{4-a} = b$ d $b = \sqrt{a} + c$
- 3 State the steps to solve for x in these equations.
- a i $3x + 5 = 12$ ii $ax + b = c$
 b i $3x^2 = 75, x > 0$ ii $ax^2 = b, x > 0$



Example 18 Substituting values into formulas

Substitute the given values into the formula to evaluate the subject.

- a $S = \frac{a}{1-r}$, when $a = 3$ and $r = 0.4$
 b $E = \frac{1}{2}mv^2$, when $m = 4$ and $v = 5$

SOLUTION

a
$$S = \frac{a}{1-r}$$

$$S = \frac{3}{1-0.4}$$

$$= \frac{3}{0.6}$$

$$= 5$$

b
$$E = \frac{1}{2}mv^2$$

$$E = \frac{1}{2} \times 4 \times 5^2$$

$$= \frac{1}{2} \times 4 \times 25$$

$$= 50$$

EXPLANATION

Substitute $a = 3$ and $r = 0.4$ and evaluate.
 $\frac{3}{0.6} = \frac{30}{6}$ if calculating by hand i.e. multiply numerator and denominator by 10.

Substitute $m = 4$ and $v = 5$ and evaluate.
 (Note: Square the value of v before multiplying by the value of m .)

Now you try

Substitute the given values into the formula to evaluate the subject.

- a $a = \frac{t}{1-b}$, when $t = 5$ and $b = 0.5$
 b $s = ut + \frac{1}{2}at^2$, when $u = 25$, $a = 10$ and $t = 4$

**Example 19 Finding the unknown value in a formula**

The area of a trapezium is given by $A = \frac{1}{2}(a + b)h$. Substitute $A = 12$, $a = 5$ and $h = 4$ and then find the value of b .

SOLUTION

$$\begin{aligned} A &= \frac{1}{2}(a + b)h \\ 12 &= \frac{1}{2} \times (5 + b) \times 4 \\ 12 &= 2(5 + b) \\ 6 &= 5 + b \\ b &= 1 \end{aligned}$$

EXPLANATION

Write the formula and substitute the given values of A , a and h . Then solve for b .
 $\frac{1}{2} \times 4 = 2$ and divide both sides by 2 since 2 is a factor of 12. Alternatively, you can expand the brackets.

Now you try

The area of a trapezium is given by $A = \frac{1}{2}(a + b)h$. Substitute $A = 24$, $b = 3$ and $h = 2$ and then find the value of a .

**Example 20 Transposing formulas**

Transpose each of the following to make b the subject.

a $c = a(x + b)$

b $c = \sqrt{a^2 + b^2}$ ($b > 0$)

SOLUTION

a

$$\begin{aligned} c &= a(x + b) \\ \frac{c}{a} &= x + b \\ \frac{c}{a} - x &= b \\ b &= \frac{c}{a} - x \quad \left(\text{or } b = \frac{c - ax}{a}\right) \end{aligned}$$

b

$$\begin{aligned} c &= \sqrt{a^2 + b^2} \quad (b > 0) \\ c^2 &= a^2 + b^2 \\ c^2 - a^2 &= b^2 \\ b^2 &= c^2 - a^2 \\ b &= \sqrt{c^2 - a^2} \end{aligned}$$

EXPLANATION

Divide both sides by a .

Subtract x from both sides.

Make b the subject on the left side. An alternative answer has a common denominator, which will also be the answer format if you expand the brackets first.

Square both sides to remove the square root.

Subtract a^2 from both sides.

Make b^2 the subject.

Take the square root of both sides, $b = \sqrt{c^2 - a^2}$ as b is positive.

Now you try

Transpose each of the following to make a the subject.

a $b = 2(a - c)$

b $a^2 - b = c$ ($a > 0$)

Exercise 2H

FLUENCY

1–3($\frac{1}{2}$)1–3($\frac{1}{2}$)1–3($\frac{1}{3}$)

Example 18



- 1 Substitute the given values into the formula to evaluate the subject. Round to two decimal places where appropriate.
- | | |
|---|---|
| <p>a $A = bh$, when $b = 3$ and $h = 7$</p> <p>c $m = \frac{a+b}{4}$, when $a = 14$ and $b = -6$</p> <p>e $A = \pi r^2$, when $r = 12$</p> <p>g $c = \sqrt{a^2 + b^2}$, when $a = 12$ and $b = 22$</p> | <p>b $F = ma$, when $m = 4$ and $a = 6$</p> <p>d $t = \frac{d}{v}$, when $d = 18$ and $v = 3$</p> <p>f $I = \frac{MR^2}{2}$, when $M = 12.2$ and $R = 6.4$</p> <p>h $Q = \sqrt{2gh}$, when $g = 9.8$ and $h = 11.4$</p> |
|---|---|

Example 19



- 2 Substitute the given values into the formula then solve the equations to determine the value of the unknown pronumeral. Round to two decimal places where appropriate.
- a** $m = \frac{F}{a}$, when $m = 12$ and $a = 3$
- b** $A = lw$, when $A = 30$ and $l = 6$
- c** $A = \frac{1}{2}(a+b)h$, when $A = 64$, $b = 12$ and $h = 4$
- d** $C = 2\pi r$, when $C = 26$
- e** $S = 2\pi r^2$, when $S = 72$
- f** $v^2 = u^2 + 2as$, when $v = 22$, $u = 6$ and $a = 12$
- g** $m = \sqrt{\frac{x}{y}}$, when $m = 8$ and $x = 4$

Example 20

- 3 Transpose each of the following formulas to make the pronumeral shown in brackets the subject.
- | | | | |
|--------------------------------------|---------|--|---------|
| a $v = u + at$ | [t] | b $A = \frac{xy}{2}$ | [x] |
| c $p = m(x+n)$ | [n] | d $d = \frac{a+bx}{c}$ | [x] |
| e $A = 2\pi rh$ | [r] | f $I = \frac{Prt}{100}$ | [r] |
| g $V = \pi r^2 h$ ($r > 0$) | [r] | h $P = \frac{v^2}{R}$ ($v > 0$) | [v] |
| i $S = 2\pi rh + 2\pi r^2$ | [h] | j $A = (p+q)^2$ | [p] |
| k $\sqrt{A} + B = 4C$ | [A] | l $T = 2\pi\sqrt{\frac{l}{g}}$ | [g] |

PROBLEM-SOLVING

4, 5

4–6

5–7



- 4 The formula $s = \frac{d}{t}$ gives the speed s km/h of a car which has travelled a distance of d km in t hours.
- a** Find the speed of a car which has travelled 400 km in 4.5 hours. Round to two decimal places.
- b**
- i** Transpose the formula $s = \frac{d}{t}$ to make d the subject.
 - ii** Find the distance covered if a car travels at 75 km/h for 3.8 hours.

- 5 The formula $F = \frac{9}{5}C + 32$ converts degrees Celsius, C , to degrees Fahrenheit, F .
- Find what each of the following temperatures is in degrees Fahrenheit.
 - 100°C
 - 38°C
 - Transpose the formula to make C the subject.
 - Calculate each of the following temperatures in degrees Celsius. Round to one decimal place where necessary.
 - 14°F
 - 98°F
- 6 The velocity, v m/s, of an object is described by the rule $v = u + at$, where u is the initial velocity in m/s, a is the acceleration in m/s^2 and t is the time in seconds.
- Find the velocity after 3 seconds if the initial velocity is 5 m/s and the acceleration is 10 m/s^2 .
 - Find the time taken for a body to reach a velocity of 20 m/s if its acceleration is 4 m/s^2 and its initial velocity is 12 m/s.
- 7 The volume of water (V litres) in a tank is given by $V = 4000 - 0.1t$ where t is the time in seconds after a tap is turned on.
- Over time, does the water volume increase or decrease according to the formula?
 - Find the volume after 2 minutes.
 - Find the time it takes for the volume to reach 1500 litres. Round to the nearest minute.
 - How long, to the nearest minute, does it take to completely empty the tank?

REASONING

8

8, 9

 $8(\frac{1}{2}), 9$

- 8 Write a formula for the following situations. Make the first listed variable the subject.
- $\$D$ given c cents
 - d cm given e metres
 - The discounted price $\$D$ that is 30% off the marked price $\$M$
 - The value of an investment $\$V$ that is 15% more than the initial amount $\$P$
 - The cost $\$C$ of hiring a car at $\$50$ upfront plus $\$18$ per hour for t hours
 - The distance d km remaining in a 42 km marathon after t hours if the running speed is 14 km/h
 - The cost $\$C$ of a bottle of soft drink if b bottles cost $\$c$
- 9 Write a formula for the value of a in these diagrams.

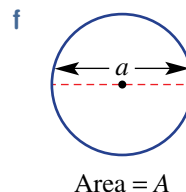
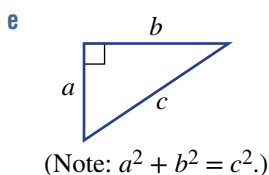
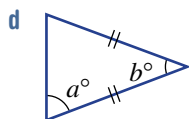
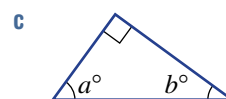
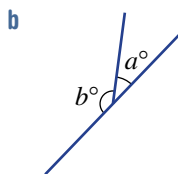
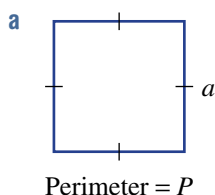

ENRICHMENT: Basketball formulas

10

10 The formula $T = 3x + 2y + f$ can be used to calculate the total number of points made in a basketball game where:

x = number of three-point goals

y = number of two-point goals

f = number of free throws made

T = total number of points

a Find the total number of points for a game in which 12 three-point goals, 15 two-point goals and 7 free throws were made.

b Find the number of three-point goals made if the total number of points was 36 and 5 two-point goals and 5 free throws were made.

c The formula $V = \left(p + \frac{3r}{2} + 2a + \frac{3s}{2} + 2b\right) - \frac{1.5t + 2f + m - o}{g}$ can be used to calculate the value, V , of a basketball player where:

p = points earned

r = number of rebounds

a = number of assists

s = number of steals

b = number of blocks

t = number of turnovers

f = number of personal fouls

m = number of missed shots

o = number of offensive rebounds

g = number of games played

Calculate the value of a player who earns 350 points and makes 2 rebounds, 14 assists, 25 steals, 32 blocks, 28 turnovers, 14 personal fouls, 24 missed shots, 32 offensive rebounds and plays 10 games.



21 Simultaneous equations using substitution

EXTENDING

LEARNING INTENTIONS

- To understand that for two different linear equations with two unknowns there is at most one solution
- To know when the method of substitution can be used to solve simultaneous linear equations
- To be able to use the substitution technique to solve simultaneous linear equations

A linear equation with one unknown has one unique solution. For example, $x = 2$ is the only value of x that makes the equation $2x + 3 = 7$ true.

The linear equation $2x + 3y = 12$ has two unknowns and it has an infinite number of solutions. Each solution is a pair of x - and y -values that makes the equation true, for example $x = 0$ and $y = 4$ or $x = 3$ and $y = 2$ or $x = 4\frac{1}{2}$ and $y = 1$.

However, if we are told that $2x + 3y = 12$ and also that $y = 2x - 1$, we can find a single solution that satisfies both equations. Equations like this are called simultaneous linear equations, because we can find a pair of x - and y -values that satisfy both equations at the same time (simultaneously).



Civil engineers solve simultaneous equations to find the required strength of trusses that support bridges and towers. Linear equations are formed by equating the forces acting in opposite directions, horizontally and vertically, on each joint.

Lesson starter: Multiple solutions

There is more than one pair of numbers x and y that satisfy the equation $x - 2y = 5$.

- Write down at least 5 pairs (x, y) that make the equation true.

A second equation is $y = x - 8$.

- Do any of your pairs that make the first equation true, also make the second equation true? If not, can you find the special pair of numbers that satisfies both equations simultaneously?

KEY IDEAS

- An algebraic method called **substitution** can be used to solve **simultaneous equations**. It is used when at least one of the equations has a single variable as the subject. For example, y is the subject in the equation $y = 3x + 1$.

- To solve simultaneous equations using substitution:
 - Substitute one equation into the other, using brackets.
 - Solve for the remaining variable.
 - Substitute to find the value of the second variable.

$$\begin{aligned}
 & 2x + 3y = 8 \text{ and } y = x + 1 \\
 & 2x + 3(x + 1) = 8 \\
 & 2x + 3x + 3 = 8 \\
 & 5x + 3 = 8 \\
 & 5x = 5 \\
 & x = 1 \\
 & \therefore y = (1) + 1 = 2
 \end{aligned}$$

BUILDING UNDERSTANDING

- Find the value of x or y by substituting the known value.
 - $y = 2x - 3$ ($x = 4$)
 - $x = 5 - 2y$ ($y = 4$)
 - $2x + 4y = 8$ ($y = -3$)
- Choose the correct option.
 - When substituting $y = 2x - 1$ into $3x + 2y = 5$, the second equation becomes:
 - $3x + 2(2x - 1) = 5$
 - $3(2x - 1) + 2y = 5$
 - $3x + 2y = 2x - 1$
 - When substituting $x = 1 - 3y$ into $5x - y = 6$, the second equation becomes:
 - $1 - 3x - y = 6$
 - $5(1 - 3y) = 6$
 - $5(1 - 3y) - y = 6$
- Check whether $x = -2$ and $y = 2$ is a solution to each pair of simultaneous equations.
 - $x - 2y = -6$ and $2x + y = 0$
 - $2x + y = -2$ and $x = 4y - 10$



Example 21 Solving simultaneous equations using substitution

Solve each of the following pairs of simultaneous equations by using substitution.

- $$\begin{aligned}
 x + y &= 10 \\
 y &= 4x
 \end{aligned}$$
- $$\begin{aligned}
 3x + 2y &= 19 \\
 y &= 2x - 8
 \end{aligned}$$
- $$\begin{aligned}
 4x - y &= 6 \\
 y &= 2x - 4
 \end{aligned}$$

SOLUTION

- $$\begin{aligned}
 x + y &= 10 & [1] \\
 y &= 4x & [2]
 \end{aligned}$$

$$x + (4x) = 10$$

$$5x = 10$$

$$x = 2$$

$$\text{From [2]} \quad y = 4x$$

$$= 4 \times (2)$$

$$= 8$$

$$\therefore x = 2, y = 8$$

$$\text{Check: } 2 + 8 = 10 \text{ and } 8 = 4 \times 2$$

EXPLANATION

Number the equations for reference.

Substitute $y = 4x$ into [1].

Combine like terms and solve for x .

Substitute $x = 2$ into [2] to find the value of y .

Check answer by substituting $x = 2$ and $y = 8$ into [1] and [2].

Continued on next page

$$\mathbf{b} \quad 3x + 2y = 19 \quad [1]$$

$$y = 2x - 8 \quad [2]$$

$$3x + 2(2x - 8) = 19$$

$$3x + 4x - 16 = 19$$

$$7x - 16 = 19$$

$$7x = 35$$

$$x = 5$$

$$\text{From [2]} \quad y = 2x - 8$$

$$= 2 \times (5) - 8$$

$$= 2$$

$$\therefore x = 5, y = 2$$

$$\text{Check: } 3 \times 5 + 2 \times 2 = 19 \text{ and}$$

$$2 = 2 \times 5 - 8$$

Substitute $y = 2x - 8$ into [1].

Use the distributive law and solve for x .

Substitute $x = 5$ into [2] to find the value of y .

Check: substitute $x = 5$ and $y = 2$ into [1] and [2].

$$\mathbf{c} \quad 4x - y = 6 \quad [1]$$

$$y = 2x - 4 \quad [2]$$

$$4x - (2x - 4) = 6$$

$$4x - 2x + 4 = 6$$

$$2x + 4 = 6$$

$$2x = 2$$

$$x = 1$$

$$\text{From [2]} \quad y = 2x - 4$$

$$= 2 \times (1) - 4$$

$$= -2$$

$$\therefore x = 1, y = -2$$

$$\text{Check: } 4 \times 1 - (-2) = 6 \text{ and}$$

$$-2 = 2 \times 1 - 4$$

Substitute $y = 2x - 4$ into [1] using brackets.

Use the distributive law and solve for x .

$$-(2x - 4) = -1(2x - 4)$$

$$= -1 \times 2x - 1 \times (-4)$$

$$= -2x + 4$$

Substitute $x = 1$ into [2] to find the value of y .

Check: substitute $x = 1$ and $y = -2$ into [1] and [2].

Now you try

Solve each of the following pairs of simultaneous equations by using substitution.

$$\mathbf{a} \quad x + y = 8$$

$$y = 3x$$

$$\mathbf{b} \quad 5x + 3y = 7$$

$$y = x + 5$$

$$\mathbf{c} \quad 3x - y = 9$$

$$y = 4x - 11$$

Exercise 21

FLUENCY

1, 2(1/2), 3

1, 2-3(1/2)

2-3(1/2)

Example 21a

1 Solve each of the following pairs of simultaneous equations by using substitution.

a $x + y = 3$
 $y = 2x$

b $x + y = 6$
 $x = 5y$

c $x + 5y = 8$
 $y = 3x$

Example 21b

2 Solve each of the following pairs of simultaneous equations by using substitution.

a $x + y = 12$
 $y = x + 6$

b $2x + y = 1$
 $y = x + 4$

c $5x + y = 5$
 $y = 1 - x$

d $3x + 2y = 8$
 $y = 4x - 7$

e $2x + 3y = 11$
 $y = 2x + 1$

f $4x + y = 4$
 $x = 2y - 8$

g $2x + 5y = -4$
 $y = x - 5$

h $2x - 3y = 5$
 $x = 5 - y$

i $3x + 2y = 5$
 $y = 3 - x$

Example 21c

3 Solve each of the following pairs of simultaneous equations by using substitution.

a $3x - y = 7$
 $y = x + 5$

b $3x - y = 9$
 $y = x - 1$

c $x + 2y = 6$
 $x = 9 - y$

d $y - x = 14$
 $x = 4y - 2$

e $3x + y = 4$
 $y = 2 - 4x$

f $4x - y = 12$
 $y = 8 - 6x$

PROBLEM-SOLVING

4, 5

4, 5

5, 6

- 4 The sum of two numbers is 48 and the larger number is 14 more than the smaller number. Write two equations and solve them to find the two numbers.
- 5 The combined mass of two trucks is 29 tonnes. The heavier truck is 1 tonne less than twice the mass of the smaller truck. Write two equations and solve them to find the mass of each truck.



- 6 The perimeter of a rectangle is 11 cm and the length is 3 cm more than half the width. Find the dimensions of the rectangle.

REASONING

7

7, 8

7, 8

- 7 One of the common errors when applying the method of substitution is made in this working. Find the error and describe how to avoid it.

Solve $y = 3x - 1$ and $x - y = 7$.

$$x - 3x - 1 = 7 \text{ (substituting } y = 3x - 1 \text{ into } x - y = 7\text{)}$$

$$-2x - 1 = 7$$

$$-2x = 8$$

$$x = -4$$

- 8 If both equations have the same variable as the subject, substitution is still possible.

For example, solve $y = 3x - 1 \dots [1]$ and $y = 2 - x \dots [2]$

Substitute [1] into [2].

$$3x - 1 = 2 - x$$

$$4x = 3$$

$$x = \frac{3}{4} \text{ and } y = \frac{5}{4}$$

Use this method to solve these simultaneous equations.

a $y = 4x + 1$

$$y = 3 - 2x$$

b $y = 3 - 4x$

$$y = 2x + 8$$

c $y = \frac{1}{2}x + 4$

$$y = \frac{x+1}{3}$$

ENRICHMENT: Literally challenging

-

-

9

- 9 Use substitution to solve each of the following pairs of literal simultaneous equations for x and y in terms of a and b .

a $ax + y = b$

$$y = bx$$

b $ax + by = b$

$$x = by$$

c $x + y = a$

$$x = y - b$$

d $ax - by = a$

$$y = x - a$$

e $ax - y = a$

$$y = bx + a$$

f $ax - by = 2a$

$$x = y - b$$

**Using a CAS calculator 2I: Solving simultaneous equations**

This activity is in the Interactive Textbook in the form of a printable PDF.

The following problems will investigate practical situations drawing upon knowledge and skills developed throughout the chapter. In attempting to solve these problems, aim to identify the key information, use diagrams, formulate ideas, apply strategies, make calculations and check and communicate your solutions.

IT consultants

1 Three IT consultants charge fees in different ways:

- Con: \$120 per hour
- Tracy: \$210 upfront plus \$90 per hour
- Rish: Undecided

Rish is investigating different upfront fees and hourly rates to compete with Con and Tracy in his IT consultancy business.

- a What are the total fees for 5 hours of work for the following consultants?
 - i Con
 - ii Tracy
- b Write rules for the total fees $\$T$ for t hours work for:
 - i Con
 - ii Tracy
- c Find the number of hours and total cost if Con's cost is equal to Tracy's cost.
- d If Rish decides on an upfront fee of \$80 plus a \$100 hourly rate, find the time of hire if Rish's cost is equal to that for:
 - i Con
 - ii Tracy.
- e Rish decides on an upfront fee of \$105 and wants the total cost to be the same as Con and Tracy's for $t = 7$. What should Rish's hourly rate be?
- f If Rish wants to be cheaper than both Con and Tracy for $t = 10$, give a possible upfront fee of more than \$100 and an hourly rate of more than \$80 that makes this possible.

Separating fact from fiction

2 Fiona explores the secondhand book stall at her school fair and notices that all fiction books are \$3 each and non-fiction books are \$4 each. She has a total of \$70 with her to spend.

Fiona is interested in the number of books of each type that she can buy for her \$70.

- a If Fiona buys 10 of each type of book, does she spend all of her \$70?
- b Can Fiona buy the following combinations of books without spending more than \$70?
 - i 9 fiction and 11 non-fiction
 - ii 12 fiction and 8 non-fiction
- c Write an expression for the cost of x fiction and y non-fiction books.
- d Fiona decides to buy exactly 21 books, spending exactly \$70 dollars.
 - i Let x be the number of fiction books and y be the number of non-fiction books. Write a rule for y in terms of x .
 - ii Find the number of each type of book she buys.
- e Can Fiona spend exactly \$70 and buy 24 books? Show your working to justify your answers.
- f In how many different ways can Fiona buy books if she spends exactly \$70? List the numbers of fiction and non-fiction books in each case.
- g Is it possible for Fiona to spend exactly \$50 on books? If so give the combinations.



Kit homes

- 3** A German manufacturer of kit homes offers a basic essential module which is 10 m by 20 m. Additional bedrooms 5 m wide by x m long can be purchased, where x is an integer and $3 \leq x \leq 7$. All bedrooms purchased must have the same dimensions and when assembled, must share at least one entire wall with the essential module or another bedroom.

The manufacturer wishes to investigate the possible total areas of their kit homes and the perimeter of various arrangements.

- a** What are the possible lengths of the bedrooms?
- b** If three bedrooms are purchased:
 - i** find the total area of the kit home if $x = 5$ is chosen
 - ii** write an expression for the total area in terms of x
 - iii** find the value of x if the total area is 290 m^2
 - iv** find the maximum value of x if the total area is to be less than 250 m^2 .
- c** If n bedrooms are purchased:
 - i** write an expression for the total area in terms of x and n
 - ii** find three combinations of x and n that give a total area of 260 m^2 .
- d** If one bedroom is purchased, find:
 - i** the two possible perimeters of the total kit home if $x = 4$ is chosen
 - ii** the two possible perimeters of the total kit home in terms of x
 - iii** the value of x if the perimeter must be 66 m.
- e** If two bedrooms are purchased, find:
 - i** the minimum perimeter possible, stating your chosen value of x
 - ii** the maximum perimeter possible, stating your chosen value of x .



2J Simultaneous equations using elimination EXTENDING

LEARNING INTENTIONS

- To understand that there are multiple methods for solving simultaneous equations
- To know that two equations can at times be added or subtracted to eliminate one of the variables
- To understand that a matching pair is required to eliminate a variable from two equations
- To know how to obtain a matching pair in simultaneous equations
- To know when to use addition and when to use subtraction to eliminate a variable
- To be able to use elimination to solve simultaneous linear equations

Another method used to solve simultaneous linear equations is called elimination. This involves the addition or subtraction of the two equations to eliminate one of the variables. We can then solve for the remaining variable and substitute to find the value of the second variable.



Traffic engineers solve simultaneous equations to model possible traffic flow in a network of roads. Using known and unknown flow rates, linear equations are formed by equating the number of vehicles entering and leaving intersections.

Lesson starter: To add or subtract?

To use the method of elimination you need to decide if using addition or using subtraction will eliminate one of the variables.

Decide if the terms in these pairs should be added or subtracted to give the result of 0.

- $3x$ and $3x$
- $-x$ and x
- $2y$ and $-2y$
- $-7y$ and $-7y$

Describe under what circumstances addition or subtraction should be used to eliminate a pair of terms.

KEY IDEAS

- **Elimination** involves the addition or subtraction of two equations to remove one variable.
- Elimination is often used when both equations are of the form $ax + by = d$ or $ax + by + c = 0$.
- Add equations to eliminate terms of opposite sign:

$$\begin{array}{r} 3x - y = 4 \\ + \quad 5x + y = 4 \\ \hline 8x = 8 \end{array}$$

- Subtract equations to eliminate terms of the same sign:

$$\begin{array}{r} 2x + 3y = 6 \\ - \quad 2x - 5y = 7 \\ \hline 8y = -1 \end{array}$$

- If terms cannot be eliminated just by using addition or subtraction, first multiply one or both equations to form a matching pair.

For example:

matching pair

$$\begin{array}{l} 1 \quad 3x - 2y = 1 \\ \quad 2x + y = 3 \end{array} \quad \begin{array}{l} \xrightarrow{\quad} \\ \xrightarrow{\times 2} \end{array} \quad \begin{array}{l} 3x - 2y = 1 \\ 4x + 2y = 6 \end{array} \quad \text{(Multiply both sides by 2.)}$$

matching pair

$$\begin{array}{l} 2 \quad 7x - 2y = 3 \\ \quad 4x - 5y = -6 \end{array} \quad \begin{array}{l} \xrightarrow{\times 4} \\ \xrightarrow{\times 7} \end{array} \quad \begin{array}{l} 28x - 8y = 12 \\ 28x - 35y = -42 \end{array} \quad \begin{array}{l} \text{(Multiply both sides by 4.)} \\ \text{(Multiply both sides by 7.)} \end{array}$$

BUILDING UNDERSTANDING

- Choose a '+' or '-' sign for each statement to make them true.
 - $3x \square 3x = 0$
 - $-2y \square 2y = 0$
 - $11y \square (-11y) = 0$
 - $-4x \square (-4x) = 0$
- Decide whether addition or subtraction should be chosen to eliminate the variable x in these simultaneous equations.
 - $$\begin{array}{l} i \quad x + 2y = 3 \\ \quad x - 5y = -4 \end{array}$$
 - $$\begin{array}{l} ii \quad -2x - y = -9 \\ \quad 2x + 3y = 11 \end{array}$$
 - $$\begin{array}{l} iii \quad y - x = 0 \\ \quad 3y - x = 8 \end{array}$$
- Decide whether addition or subtraction will eliminate the variable y in these simultaneous equations.
 - $$\begin{array}{l} i \quad 4x - y = 6 \\ \quad x + y = 4 \end{array}$$
 - $$\begin{array}{l} ii \quad 7x - 2y = 5 \\ \quad -3x - 2y = -5 \end{array}$$
 - $$\begin{array}{l} iii \quad 10y + x = 14 \\ \quad -10y - 3x = -24 \end{array}$$



Example 22 Solving simultaneous equations using elimination

Solve the following pairs of simultaneous equations by using elimination.

a $x - 2y = 1$
 $-x + 5y = 2$

b $3x - 2y = 5$
 $5x - 2y = 11$

SOLUTION

a

$$\begin{array}{r} x - 2y = 1 \quad [1] \\ -x + 5y = 2 \quad [2] \\ \hline [1] + [2] \quad 3y = 3 \\ \quad y = 1 \end{array}$$

From [1] $x - 2y = 1$
 $x - 2 \times (1) = 1$
 $x - 2 = 1$
 $x = 3$

$\therefore x = 3, y = 1$

Check: $3 - 2(1) = 1$
 $-3 + 5(1) = 2$

b

$$\begin{array}{r} 3x - 2y = 5 \quad [1] \\ 5x - 2y = 11 \quad [2] \\ \hline [2] - [1] \quad 2x = 6 \\ \quad x = 3 \end{array}$$

From [1] $3x - 2y = 5$
 $3 \times (3) - 2y = 5$
 $9 - 2y = 5$
 $-2y = -4$
 $y = 2$

$\therefore x = 3, y = 2$

Check: $3(3) - 2(2) = 5$
 $5(3) - 2(2) = 11$

EXPLANATION

Add the two equations to eliminate x since $x + (-x) = 0$. Then solve for y .

Substitute $y = 1$ into equation [1] to find x .

Substitute $x = 3$ and $y = 1$ into the original equations to check.

Subtract the two equations to eliminate y since they are the same sign, i.e. $-2y - (-2y) = -2y + 2y = 0$. Alternatively, could do [1] - [2] but [2] - [1] avoids negative coefficients. Solve for x .

Substitute $x = 3$ into equation [1] to find y .

Substitute $x = 3$ and $y = 2$ into the original equations to check.

Now you try

Solve the following pairs of simultaneous equations by using elimination.

a $-x + y = 1$
 $x - 2y = -3$

b $4x - 3y = -16$
 $3x - 3y = -15$



Example 23 Solving simultaneous equations by creating a matching pair

Solve the following pairs of simultaneous equations by using elimination.

a $5x + 2y = -7$
 $x + 7y = 25$

b $4x + 3y = 18$
 $3x - 2y = 5$

SOLUTION

a

$$\begin{array}{rcl} 5x + 2y = -7 & [1] \\ x + 7y = 25 & [2] \\ 5 \times [2] & 5x + 35y = 125 & [3] \\ \underline{5x + 2y = -7} & & [1] \\ [3] - [1] & 33y = 132 & \\ & y = 4 & \end{array}$$

From [2] $x + 7y = 25$
 $x + 7 \times (4) = 25$
 $x + 28 = 25$
 $x = -3$
 $\therefore x = -3, y = 4$

b

$$\begin{array}{rcl} 4x + 3y = 18 & [1] \\ 3x - 2y = 5 & [2] \\ 2 \times [1] & 8x + 6y = 36 & [3] \\ 3 \times [2] & 9x - 6y = 15 & [4] \\ [3] + [4] & 17x = 51 & \\ & x = 3 & \end{array}$$

From [1] $4x + 3y = 18$
 $4 \times (3) + 3y = 18$
 $12 + 3y = 18$
 $3y = 6$
 $y = 2$
 $\therefore x = 3, y = 2$

EXPLANATION

There are different numbers of x and y in each equation so multiply equation [2] by 5 to make the coefficient of x equal to that in equation [1].

Subtract the equations to eliminate x .

Substitute $y = 4$ in equation [2] to find x .

Substitute $x = -3$ and $y = 4$ into the original equations to check.

Multiply equation [1] by 2 and equation [2] by 3 to make the coefficients of y equal in size but opposite in sign. Alternatively we could make the coefficients of x match.

Add the equations to eliminate y .

Substitute $x = 3$ into equation [1] to find y .

Substitute $x = 3$ and $y = 2$ into the original equations to check.

Now you try

Solve the following pairs of simultaneous equations by using elimination.

a $7x + 2y = 12$
 $x - 3y = 5$

b $3x + 2y = 5$
 $5x - 3y = 21$

Exercise 2J

FLUENCY

1, 2-4(1/2)

1, 2-4(1/2)

2-4(1/2)

Example 22a

1 Solve these simultaneous equations by first adding the equations.

a $3x - y = 2$
 $2x + y = 3$

b $2x - 3y = -2$
 $-5x + 3y = -4$

c $4x + 3y = 5$
 $-4x - 5y = -3$

Example 22b

2 Solve these simultaneous equations by first subtracting the equations.

a $3x + y = 10$
 $x + y = 6$

b $2x + 7y = 9$
 $2x + 5y = 11$

c $2x + 3y = 14$
 $2x - y = -10$

d $5x - y = -2$
 $3x - y = 4$

e $-5x + 3y = -1$
 $-5x + 4y = 2$

f $9x - 2y = 3$
 $-3x - 2y = -9$

Example 23a

3 Solve the following pairs of simultaneous linear equations by using elimination.

a $4x + y = -8$
 $3x - 2y = -17$

b $2x - y = 3$
 $5x + 2y = 12$

c $-x + 4y = 2$
 $3x - 8y = -2$

d $3x + 2y = 0$
 $4x + y = -5$

e $4x + 3y = 13$
 $x + 2y = -3$

f $3x - 4y = -1$
 $6x - 5y = 10$

g $-4x - 3y = -5$
 $7x - y = 40$

h $3x - 4y = -1$
 $-5x - 2y = 19$

i $5x - 4y = 7$
 $-3x - 2y = 9$

Example 23b

4 Solve the following pairs of simultaneous linear equations by using elimination.

a $3x + 2y = -1$
 $4x + 3y = -3$

b $7x + 2y = 8$
 $3x - 5y = 21$

c $6x - 5y = -8$
 $-5x + 2y = -2$

d $2x - 3y = 3$
 $3x - 2y = 7$

e $7x + 2y = 1$
 $4x + 3y = 8$

f $5x + 7y = 1$
 $3x + 5y = -1$

g $5x + 3y = 16$
 $4x + 5y = 5$

h $3x - 7y = 8$
 $4x - 3y = -2$

i $2x - 3y = 1$
 $3x + 2y = 8$

j $2x - 7y = 11$
 $5x + 4y = -37$

k $3x + 5y = 36$
 $7x + 2y = -3$

l $2x - 4y = 6$
 $5x + 3y = -11$

PROBLEM-SOLVING

5, 6

5-7

6-8

5 The sum of two numbers is 30 and their difference is 12.

Write two equations and find the numbers.

6 Two supplementary angles differ by 24° . Write two equations and find the two angles.

7 The perimeter of a rectangular city block is 800 metres and the difference between the length and width is 123 metres. What are the dimensions of the city block?



- 8 A teacher collects a total of 17 mobile phones and iPads before a group of students heads off on a bushwalk. From a second group of students, 40 phones and iPads are collected. The second group had twice the number of phones and three times as many iPads as the first group. How many phones and how many iPads did the first group have?



REASONING

9

9, 10

10, 11

- 9 Consider the pair of simultaneous equations:

$$2x + y = 5 \dots [1]$$

$$5x + y = 11 \dots [2]$$

- a Solve the equations by first subtracting equation [2] from equation [1], i.e. [1] – [2].
 b Now solve the equations by first subtracting equation [1] from equation [2], i.e. [2] – [1].
 c Which method a or b is preferable and why?
- 10 To solve any of the pairs of simultaneous equations in this section using the method of substitution, what would need to be done first before the substitution is made?
 Try these using substitution.

a $x + y = 5$

$$2x - y = 7$$

b $3x - y = -2$

$$x - 4y = 3$$

- 11 Find the solution to these pairs of simultaneous equations. What do you notice?

a $2x + 3y = 3$

$$2x + 3y = 1$$

b $7x - 14y = 2$

$$y = \frac{1}{2}x + 1$$

ENRICHMENT: Literal elimination

–

–

12($\frac{1}{2}$)

- 12 Use elimination to solve the following pairs of simultaneous equations to find the value of x and y in terms of the other pronumerals.

a $x + y = a$

$$x - y = b$$

b $ax + y = 0$

$$ax - y = b$$

c $x - by = a$

$$-x - by = 2a$$

d $2ax + y = b$

$$x + y = b$$

e $bx + 5ay = 2b$

$$bx + 2ay = b$$

f $ax + 3y = 14$

$$ax - y = -10$$

g $2ax + y = b$

$$3ax - 2y = b$$

h $2ax - y = b$

$$3ax + 2y = b$$

i $-x + ay = b$

$$3x - ay = -b$$

j $ax + 2y = c$

$$2ax + y = -c$$

k $ax - 4y = 1$

$$x - by = 1$$

l $ax + by = a$

$$x + y = 1$$

m $ax + by = c$

$$-ax + y = d$$

n $ax - by = a$

$$-x + y = 2$$

o $ax + by = b$

$$3x - y = 2$$

p $ax - by = b$

$$cx - y = 2$$

q $ax + by = c$

$$dx - by = f$$

r $ax + by = c$

$$dx + by = f$$

2K Applications of simultaneous equations EXTENDING

LEARNING INTENTIONS

- To know that if there are two variables in a problem, two equations will be required to find the solution
- To be able to form a pair of equations from a word problem
- To be able to identify which technique is best to apply to solve the simultaneous equations
- To understand to check the solution by substituting into the original equations

Many problems can be described mathematically using a pair of simultaneous linear equations from which a solution can be obtained algebraically.



Weather forecasting uses algebraic equations to model changes over time of physical variables, such as air temperature and rainfall. Current observations are entered into supercomputers which simultaneously solve huge systems of equations, rapidly updating predictions.

Lesson starter: The tyre store

In one particular week a total of 83 cars and motorcycles check into a garage to have their tyres changed. All the motorcycles change 2 tyres each and all the cars change 4 tyres each. The total number of tyres sold in the week is 284.

If you had to find the number of motorcycles and the number of cars that have their tyres changed in the week:

- What two variables should you define?
- What two equations can you write?
- Which method (substitution or elimination) would you use to solve the equations?
- What is the solution to the simultaneous equations?
- How would you answer the question in words?

KEY IDEAS

- To solve worded problems with simultaneous equations complete these steps.
 - Define two variables by writing down what they represent.
For example: Let \$C be the cost of ...
Let x be the number of ...
 - Write a pair of simultaneous equations from the given information using your two variables.
 - Solve the equations simultaneously using substitution or elimination.
 - Check the solution by substituting into the original equations.
 - Express the answer in words.

BUILDING UNDERSTANDING

- 1 The sum of two numbers is 42 and their difference is 6. Find the two numbers x and y by completing the following steps.
 - a State a pair of simultaneous equations relating x and y .
 - b Which method, substitution or elimination, would it be best to use to solve the pair of equations?

- 2 A rectangular block of land has a perimeter of 120 m and the length l m of the block is three times the width w m. Find the dimensions of the block of land by completing the following steps.
 - a State a pair of simultaneous equations relating l and w .
 - b Which method, substitution or elimination, would it be best to use to solve the pair of equations?



Example 24 Setting up and solving simultaneous linear equations

The length of a rectangle is 5 cm longer than its width. If the perimeter is 84 cm, find the dimensions of the rectangle.

SOLUTION

Let w cm be the width of the rectangle and let l cm be the length.

$$l = w + 5 \quad [1]$$

$$2l + 2w = 84 \quad [2]$$

Substitute [1] into [2]

$$2(w + 5) + 2w = 84$$

$$2w + 10 + 2w = 84$$

$$4w + 10 = 84$$

$$4w = 74$$

$$w = 18.5$$

$$\text{From [1] } l = (18.5) + 5$$

$$= 23.5$$

\therefore the dimensions of the rectangle are 23.5 cm by 18.5 cm.

EXPLANATION

Define the unknowns. Draw a diagram to help.

$$\begin{array}{c} \boxed{P = 84 \text{ cm}} \\ w \text{ cm} \\ l \text{ cm} \end{array}$$

The length is 5 cm more than the width and the perimeter is 84 cm.

Choose the method of substitution to solve. Expand and collect like terms to solve for w .

Substitute $w = 18.5$ into [1].

Substitute into original equations to check. Answer the question in a sentence.

Now you try

The length of a rectangle is 6 cm longer than its width. If the perimeter is 52 cm, find the dimensions of the rectangle.



Example 25 Solving further word problems with simultaneous equations

Andrea bought two containers of ice-cream and three bottles of maple syrup for a total of \$22. At the same shop, Bettina bought one container of the same ice-cream and two bottles of the same maple syrup for \$13. How much does each container of ice-cream and each bottle of maple syrup cost?

SOLUTION

Let: \$ x be the cost of a container of ice-cream
 \$ y be the cost of a bottle of maple syrup

$$2x + 3y = 22 \quad [1]$$

$$x + 2y = 13 \quad [2]$$

$$2 \times [2] \quad 2x + 4y = 26 \quad [3]$$

$$2x + 3y = 22 \quad [1]$$

$$[3] - [1] \quad \underline{\quad\quad\quad} y = 4$$

$$\text{Form [2]} \quad x + 2y = 13$$

$$x + 2 \times (4) = 13$$

$$x + 8 = 13$$

$$x = 5$$

The cost of one container of ice-cream is \$5 and the cost of one bottle of maple syrup is \$4.

EXPLANATION

Define the unknowns. Ask yourself what you are being asked to find.

2 containers of ice-cream and 3 bottles of maple syrup for a total of \$22.

1 container of ice-cream and 2 bottles of maple syrup for \$13.

Choose the method of elimination to solve.

Multiply [2] by 2 to obtain a matching pair.

Subtract equation [1] from [3].

Substitute $y = 4$ into [2].

Solve for x .

Substitute $y = 4$ and $x = 5$ into original equations to check.

Answer the question in a sentence.

Now you try

Wally bought three identical hats and four identical scarfs for \$70. From the same store on another day he bought five hats and two scarfs for \$64.40. How much does each hat and each scarf cost?

Exercise 2K

FLUENCY

1–5

1–3, 5, 6

2, 5–7

Example 24

- The length of a rectangular pool is 10 m longer than its width. If the perimeter of the pool is 80 m, find the dimensions of the pool by completing the following steps.
 - Define two variables to represent the problem.
 - Write a pair of simultaneous equations relating the two variables.
 - Solve the pair of equations using substitution or elimination.
 - Write your answer in words.
- Mila plants 820 hectares of potatoes and corn. To maximise his profit he plants 140 hectares more of potatoes than of corn. How many hectares of each does he plant?

Example 25

- 3 Mal bought three bottles of milk and four bags of chips for a total of \$17. At the same shop, Barbara bought one bottle of milk and five bags of chips for \$13. Find how much each bottle of milk and each bag of chips cost by completing the following steps.
- Define two variables to represent the problem.
 - Write a pair of simultaneous equations relating the two variables.
 - Solve the pair of equations using substitution or elimination.
 - Write your answer in words.
- 4 Leonie bought seven lip glosses and two eye shadows for a total of \$69 and Chrissie bought four lip glosses and three eye shadows for a total of \$45. Find how much each lip gloss and each eye shadow costs by completing the following steps.
- Define two variables to represent the problem.
 - Write a pair of simultaneous equations relating the two variables.
 - Solve the pair of equations using substitution or elimination.
 - Write your answer in words.
- 5 Steve bought five cricket balls and fourteen tennis balls for \$130. Ben bought eight cricket balls and nine tennis balls for \$141. Find the cost of a cricket ball and the cost of a tennis ball.
- 6 At a birthday party for 20 people each person could order a hot dog or a bucket of chips. If there were four times as many hot dogs ordered as buckets of chips, calculate how many hot dogs and how many buckets of chips were ordered.
- 7 The entry fee for a fun run is \$10 for adults and \$3 for children. A total of \$3360 was collected from the 420 competitors. Find the number of adults and the number of children running.



PROBLEM-SOLVING

8, 9

8–10

9–11

- 8 Carrie has 27 coins in her purse. All the coins are 5 cent or 20 cent coins. If the total value of the coins is \$3.75, how many of each type does she have?
- 9 Michael is 30 years older than his daughter. In five years' time Michael will be 4 times as old as his daughter. How old is Michael now?
- 10 Jenny has twice as much money as Kristy. If I give Kristy \$250, she will have three times as much as Jenny. How much did they each have originally?
- 11 At a particular cinema the cost of an adult movie ticket is \$15 and the cost of a child's ticket is \$10. The seating capacity of the cinema is 240. For one movie session all seats are sold and \$3200 is collected from the sale of tickets. How many adult and how many children's tickets were sold?



REASONING

12

12, 13

13, 14

- 12 Wilfred and Wendy are in a long distance bike race. Wilfred rides at 20 km/h and has a 2 hour head start. Wendy travels at 28 km/h. How long does it take for Wendy to catch up to Wilfred? Use $\text{distance} = \text{speed} \times \text{time}$.



- 13 Andrew travelled a distance of 39 km by jogging for 4 hours and cycling for 3 hours. He could have travelled the same distance by jogging for 7 hours and cycling for 2 hours. Find the speed at which he was jogging and the speed at which he was cycling.
- 14 Malcolm's mother is 27 years older than he is and their ages are both two-digit numbers. If Malcolm swaps the digits in his age he gets his mother's age.
- How old is Malcolm if the sum of the digits in his age is 5?
 - What is the relationship between the digits in Malcolm's age if the sum of the digits is unknown.
 - If the sum of the digits in Malcolm's two-digit age is unknown, how many possible ages could he be? What are these ages?

ENRICHMENT: Digit swap

–

–

15, 16

- 15 The digits of a two-digit number sum to 10. If the digits swap places the number is 36 more than the original number. What is the original number? Can you show an algebraic solution?
- 16 The difference between the two digits of a two-digit number is 2. If the digits swap places the number is 18 less than the original number. What is the original number? Can you show an algebraic solution?

Movie theatre pricing

A small boutique movie theatre is opening soon and will be publishing adult and child ticket prices on its website. After some analysis, the owner decides to make the following assumptions:

- the sum of the cost of a child ticket and an adult ticket will be \$30
- 40 children and 25 adults are expected to attend each evening.

Present a report for the following tasks and ensure that you show clear mathematical workings and explanations where appropriate.

Preliminary task

- If the cost of a child movie ticket is \$6, find the cost of an adult ticket.
- Find the revenue (total amount earned) for the movie theatre on one particular evening using the assumption that 40 children and 25 adults attend and a child ticket is \$6.
- Solve the following simultaneous equations.

$$\begin{aligned} a + c &= 30 \\ 25a + 40c &= 900 \end{aligned}$$

Modelling task

- | | | | | | |
|---------------------|--|---------|----------|---------|----------|
| Formulate | <ol style="list-style-type: none"> The problem is to determine a suitable price for the adult and child tickets to achieve a revenue of at least \$1000. Write down all the relevant information that will help solve this problem. Use the following facts to write two equations using \$$a$ for the cost of an adult ticket and \$$c$ for the cost of a child ticket. <ul style="list-style-type: none"> • The sum of the cost of a child ticket and an adult ticket will be \$30. • 40 children and 25 adults attend on one particular evening. • The total revenue for the evening is \$930. | | | | |
| Solve | <ol style="list-style-type: none"> Solve your simultaneous equations from part b to find the cost of a child ticket and the cost of an adult ticket. Repeat part c for the following total revenues. <table style="width: 100%; border: none;"> <tr> <td style="width: 50%;">i \$825</td> <td style="width: 50%;">ii \$960</td> </tr> </table> Explore the following special cases for the total revenue earned and decide if they represent reasonable pricing structures. <table style="width: 100%; border: none;"> <tr> <td style="width: 50%;">i \$975</td> <td style="width: 50%;">ii \$765</td> </tr> </table> | i \$825 | ii \$960 | i \$975 | ii \$765 |
| i \$825 | ii \$960 | | | | |
| i \$975 | ii \$765 | | | | |
| Evaluate and verify | <ol style="list-style-type: none"> By considering your results from above, explain why it will be difficult for the theatre to earn more than \$1000 on each evening based on the assumptions made. If the sum of the cost of a child ticket and an adult ticket is changed to \$40, do you think it would be reasonable to expect that more than \$1000 revenue can be earned each evening. Show your choices and calculations to justify your answer. | | | | |
| Communicate | <ol style="list-style-type: none"> Summarise your results and describe any key findings. | | | | |

Extension questions

- By keeping the assumption that the cost of a child ticket and an adult ticket will be \$30, determine the maximum and minimum expected revenue for an evening at the cinema.
- Decide if the cinema owner should increase the price for the total cost of purchasing one adult and one child ticket to achieve a revenue of more than \$1000. Choose a suitable total cost and justify your choice showing all calculations.

Protein balls

Key technology: Spreadsheets

Carrie runs a small business making and selling protein balls, which are a combination of muesli and chocolate. To make a batch of protein balls she combines chocolate and muesli so that the total weight of the batch is 10 kg. The cost of chocolate is \$6 per kilogram and the cost of muesli is \$4 per kilogram.



1 Getting started

When Carrie started her business, the total cost of chocolate and muesli for one batch was \$48.

- Let x be the amount of chocolate purchased for one batch in kilograms.
- Let y be the amount of muesli purchased for one batch in kilograms.
 - a Given the total cost for one batch is \$48 write down an equation including the variables x and y . We will call this Equation 1.
 - b Use your equation to find the amount of muesli purchased if the following amounts of chocolate are purchased.
 - i 2 kg
 - ii 3 kg
 - iii 5 kg
 - c Write down a second equation using the information given in the introduction regarding the total weight. We will call this Equation 2.
 - d Solve your equations 1 and 2 simultaneously to find the values of x and y and hence the amounts of chocolate and muesli purchased for each batch of protein balls.

2 Using technology

- a Rearrange your Equation 1 and Equation 2 to make y the subject.
- b We will now set up a spreadsheet to solve this pair of simultaneous equations numerically. Enter the shown details into a spreadsheet.
- c Fill down from cells A8, B7 and C7.
- d In your spreadsheet, search for a value of x for which the y values are equal for both equations. Describe what you have found.
- e Change the total cost value in cell B3 to \$50, then search for the solution to the simultaneous equations to find the amount of chocolate and muesli for one batch.

	A	B	C
1	Making protein balls		
2			
3	Total cost of one batch	48	
4			
5			
6	x value	Equation 1	Equation 2
7	0	$= (B\$3 - 6 * A7) / 4$	$= 10 - A7$
8	$= A7 + 1$		

3 Applying an algorithm

For selected values for the total cost in cell B3, you may have noticed that the values of x and y are integers. This will not be the case for all chosen values.

- a Change the total cost value in cell B3 to \$51 then search for the value of x for which the y values are the same. What do you notice? Between what two integer x values will the y values for both equations be equal?
- b Alter both the starting value of x and the increment in column A so that you can search for solutions between integer x values. Suggestion: Change the starting number in A7 to 4 and the formula in A8 to $= A7 + 0.5$. Fill down once again.
- c Now alter the total cost in cell B3 to \$47.60 and apply this algorithm to find the solution.
 - Step 1: Alter the total cost in cell B3 as chosen.
 - Step 2: Look for the value of x for which the y values are closest.
 - Step 3: Adjust the starting value of x to be nearer to the solution.
 - Step 4: Adjust the increment in column A so that smaller increases in the value of x can be considered.
 - Step 5: Repeat from Step 2 until the solution is found.
- d Try the above algorithm for finding the solution for when the total cost is \$51.50.

4 Extension

Now consider one of Carrie's new recipes where the total weight of one batch is 11 kg instead of 10 kg but the cost per kilogram of the chocolate and muesli are still \$6 and \$4 per kilogram respectively.

- a Make adjustments to your spreadsheet to account for this change.
- b Try using the algorithm to find the values of x and y for the following total costs of each batch.
 - i \$50
 - ii \$47
 - iii \$54.50
- c Explore this problem further by varying the costs per kilogram of chocolate and muesli. Comment on the type of numbers chosen that deliver integer solutions to x and y .



Fire danger

In many countries fire indices have been developed to help predict the likelihood of fire occurring. One of the simplest fire-danger rating systems devised is the Swedish Angstrom Index. This index considers the relationship between relative humidity, temperature and the likelihood of fire danger.

The index, I , is given by: $I = \frac{H}{20} + \frac{27 - T}{10}$

where H is the percentage of relative humidity and T is the temperature in degrees Celsius. The table below shows the likelihood of a fire occurring for different index values.

Index	Likelihood of fire occurring
$I > 4.0$	Unlikely
$2.5 < I < 4.0$	Medium
$2.0 < I < 2.5$	High
$I < 2.0$	Very likely

Constant humidity

- a** If the humidity is 35% ($H = 35$), how hot would it have to be for the occurrence of fire to be:
- very likely?
 - unlikely?
- Discuss your findings with regard to the range of summer temperatures for your capital city or nearest town.
- b** Repeat part **a** for a humidity of 40%.
- c** Describe how the 5% change in humidity affects the temperature at which fires become:
- very likely
 - unlikely.

Constant temperature

- a** If the temperature was 30°C , investigate what humidity would make fire occurrence:
- very likely
 - unlikely.
- b** Repeat part **a** for a temperature of 40°C .
- c** Determine how the ten-degree change in temperature affects the relative humidity at which fire occurrence becomes:
- very likely
 - unlikely.

Reflection

Is this fire index more sensitive to temperature or to humidity? Explain your answer.

Investigate

Use the internet to investigate fire indices used in Australia. You can type in key words, such as Australia, fire danger and fire index.



- 1 Transpose each of the following formulas to make the pronumeral shown in brackets the subject.

a $wx - 4 = ax + k$ [x]

b $\frac{a}{K} - y = \frac{b}{K}$ [K]

c $\sqrt{\frac{a-w}{ak}} = m$ [a]



Up for a challenge? If you get stuck on a question, check out the 'Working with unfamiliar problems' poster at the end of the book to help you.

- 2 Five consecutive integers add to 195. Find the middle integer.
- 3 A group of office workers had some prize money to distribute among themselves. When all but one took \$9 each, the last person only received \$5. When they all took \$8 each, there was \$12 left over. How much had they won?
- 4 The sides of an equilateral triangle have lengths $3y - x$, $5x + 3$ and $2 + 2y$, as shown. Find the length of the sides.

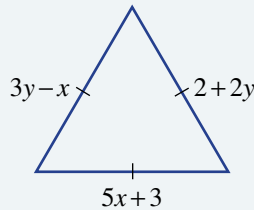

- 5 a If $a > b > 0$ and $c < 0$, insert an inequality symbol to make a true statement.

i $a + c$ ___ $b + c$

ii ac ___ bc

iii $a - b$ ___ 0

iv $\frac{1}{a}$ ___ $\frac{1}{b}$

- b Place a , b , c and d in order from smallest to largest given:

$$a > b$$

$$a + b = c + d$$

$$b - a > c - d$$

- 6 Find the values of x , y and z when:

$$x - 3y + 2z = 17$$

$$x - y + z = 8$$

$$y + z = 3$$

- 7 Solve these equations for x .

a $\frac{1}{x} + \frac{1}{a} = \frac{1}{b}$

b $\frac{1}{2x} + \frac{1}{3x} = \frac{1}{4}$

c $\frac{x-1}{3} - \frac{x+1}{4} = x$

d $\frac{2x-3}{4} - \frac{1-x}{5} = \frac{x+1}{2}$

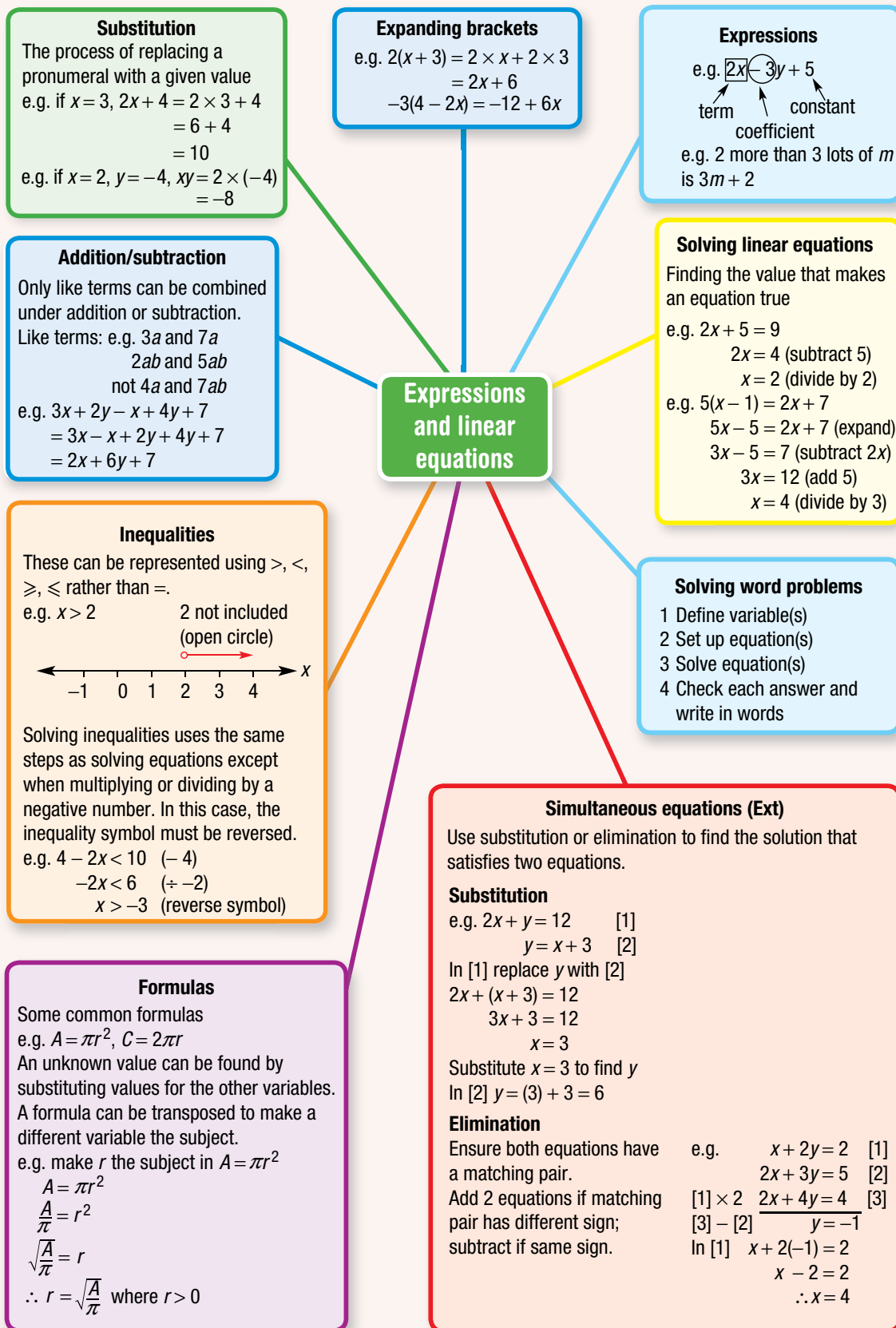

Chapter checklist with success criteria

A printable version of this checklist is available in the Interactive Textbook



2A	1. I can convert between algebraic expressions and words. e.g. Write an algebraic expression for the cost of t tickets at \$20 each.	<input type="checkbox"/>
2A	2. I can substitute values into expressions and evaluate. e.g. Evaluate $a^2 + 3(ab - c)$ if $a = -2$, $b = 3$ and $c = -8$.	<input type="checkbox"/>
2B	3. I can multiply algebraic terms. e.g. Simplify $4x \times 7xy$.	<input type="checkbox"/>
2B	4. I can divide algebraic terms. e.g. Simplify $12xy \div (18x)$.	<input type="checkbox"/>
2B	5. I can collect like terms under addition and subtraction. e.g. Simplify $4xy - 5x^2y - xy + 3x^2y$.	<input type="checkbox"/>
2C	6. I can expand brackets and simplify. e.g. Expand $4x(3x - 5)$.	<input type="checkbox"/>
2C	7. I can simplify by removing brackets. e.g. Expand and simplify $7 - 3(3x - 2)$.	<input type="checkbox"/>
2D	8. I can solve simple linear equations. e.g. Solve $10 - 2x = 16$.	<input type="checkbox"/>
2D	9. I can solve linear equations involving fractions. e.g. Solve $\frac{4x-2}{3} = 6$.	<input type="checkbox"/>
2E	10. I can solve linear equations with brackets. e.g. Solve $2(4x + 3) = 7$.	<input type="checkbox"/>
2E	11. I can solve linear equations with pronumerals on both sides. e.g. Solve $6x + 5 = 3x - 13$.	<input type="checkbox"/>
2F	12. I can turn a word problem into an equation. e.g. Write an equation to represent that four more than a certain number is three less than two times the number.	<input type="checkbox"/>
2F	13. I can solve a word problem using an equation. e.g. Ava and Elise have 27 soft toys between them. Ava has 5 more than Elise. Use an equation to find how many soft toys they each have.	<input type="checkbox"/>
2G	14. I can represent an inequality on a number line. e.g. Show x is less than or equal to 3 ($x \leq 3$) on a number line.	<input type="checkbox"/>
2G	15. I can solve a linear inequality. e.g. Find the solution set for $8 - 3x < 20$.	<input type="checkbox"/>
2H	16. I can substitute values into formulas. e.g. Evaluate the formula $c = \sqrt{a^2 + b^2}$ when $a = 9$ and $b = 12$.	<input type="checkbox"/>
2H	17. I can find the unknown value in a formula. e.g. In the formula $s = ut + \frac{1}{2}at^2$, find a if $s = 80$, $u = 10$ and $t = 4$.	<input type="checkbox"/>

Chapter checklist with success criteria

			✓
2H	18. I can transpose formulas. e.g. Transpose $V = \pi r^2 h$ to make r the subject.		<input type="checkbox"/>
2I	19. I can solve simultaneous linear equations using substitution. e.g. Solve the following pair of simultaneous equations using substitution: $x + 2y = 4$ $y = 2x - 3$.	Ext	<input type="checkbox"/>
2J	20. I can solve simultaneous linear equations using elimination. e.g. Solve the following pair of simultaneous equations using elimination: $3x + 2y = 3$ $2x - y = -5$.	Ext	<input type="checkbox"/>
2K	21. I can solve word problems with simultaneous equations. e.g. At the football, 2 meat pies and 3 bottles of water cost \$21 while 3 meat pies and 5 bottles of water cost \$33. How much does each meat pie and each bottle of water cost?	Ext	<input type="checkbox"/>

Short-answer questions

2A

- 1 Write algebraic expressions to represent the following.
- a The product of m and 7
b Twice the sum of x and y
c The cost of 3 movie tickets at m dollars each
d n divided by 4 less 3

2A

- 2 Evaluate the following when $x = 2$, $y = -1$ and $z = 5$.
- a $yz - x$
b $\frac{2z - 4y}{x}$
c $\frac{2z^2}{x} + y$
d $x(y + z)$

2B

- 3 Simplify.
- a $2m \times 4n$
b $\frac{4x^2y}{12x}$
c $3ab \times 4b \div (2a)$
d $4 - 5b + 2b$
e $3mn + 2m - 1 - nm$
f $4p + 3q - 2p + q$

2C

- 4 Expand and simplify the following.
- a $2(x + 7)$
b $-3(2x + 5)$
c $2x(3x - 4)$
d $-2a(5 - 4a)$
e $5 - 4(x - 2)$
f $4(3x - 1) - 3(2 - 5x)$

2D

- 5 Solve the following linear equations for x .
- a $5x + 6 = 51$
b $\frac{x + 2}{4} = 7$
c $\frac{2x}{5} - 3 = 3$
d $\frac{2x - 5}{3} = -1$
e $7x - 4 = 10$
f $3 - 2x = 21$
g $1 - \frac{4x}{5} = 9$
h $2 - 7x = -3$

2F

- 6 Write an equation to represent each of the following and then solve it for the pronumeral.
- a A number, n , is doubled and increased by 3 to give 21.
b The number of lollies, l , is decreased by 5 and then shared equally among three friends so that they each get 7 lollies.
c 5 less than the result of Toni's age, x , divided by 4 is 0.



2E

- 7 Solve the following linear equations.
- a $2(x + 4) = 18$
b $3(2x - 3) = 2$
c $8x = 2x + 24$
d $5(2x + 4) = 7x + 5$
e $3 - 4x = 7x - 8$
f $1 - 2(2 - x) = 5(x - 3)$

2F

- 8 Nick makes an initial bid of $\$x$ in an auction for a signed cricket bat. By the end of the auction he has paid $\$550$, which is $\$30$ more than twice his initial bid. Set up and solve an equation to determine Nick's initial bid.

2G

- 9 Represent each of the following on a number line.
- a $x > 1$
b $x \leq 7$
c $x \geq -4$
d $x < -2$
e $2 < x \leq 8$
f $-1 < x < 3$

2G

- 10 Solve the following inequalities.
- a $x + 8 < 20$
b $2m - 4 > -6$
c $3 - 2y \leq 15$
d $\frac{7 - 2x}{3} > -9$
e $3a + 9 < 7(a - 1)$
f $-4x + 2 \leq 5x - 16$

- 2G** 11 A car salesman earns \$800 per month plus a 10% commission on the value of sales he makes for the month. If he is aiming to earn a minimum of \$3200 a month, what is the possible value of sales that will enable this?
- 2H** 12 Find the value of the unknown in each of the following formulas.
a $E = \sqrt{PR}$ when $P = 90$ and $R = 40$
b $v = u + at$ when $v = 20$, $u = 10$, $t = 2$
c $V = \frac{1}{3}Ah$ when $V = 20$, $A = 6$
- 2H** 13 Rearrange the following formulas to make the variable in brackets the subject.
a $v^2 = u^2 + 2ax$ [x] **b** $A = \frac{1}{2}r^2\theta$ [θ]
c $P = RI^2$, where $I > 0$ [I] **d** $S = \frac{n}{2}(a + l)$ [a]
- 2I/J** 14 Solve the following simultaneous equations using the substitution method for parts **a–c** and the elimination method for **d–f**.
- Ext**
- a** $x + 2y = 12$ **b** $2x + 3y = -6$ **c** $7x - 2y = 6$
 $x = 4y$ $y = x - 1$ $y = 2x + 3$
- d** $x + y = 15$ **e** $3x + 2y = -19$ **f** $3x - 5y = 7$
 $x - y = 7$ $4x - y = -7$ $5x + 2y = 22$
- 2K** 15 The sum of the ages of Billy and his sister is 32. If Billy is 8 years older than his sister, what are their ages?
- Ext**

Multiple-choice questions

- 2A** 1 The algebraic expression that represents 2 less than 3 lots of n is:
A $3(n - 2)$ **B** $2 - 3n$ **C** $3n - 2$
D $3 + n - 2$ **E** n
- 2B** 2 The simplified form of $6ab + 14a \div 2 - 2ab$ is:
A $8ab$ **B** $8ab + 7a$ **C** $ab + 7a$
D $4ab + 7a$ **E** $4ab + \frac{7a}{2}$
- 2D** 3 The solution to $\frac{x}{3} - 1 = 4$ is:
A $x = 13$ **B** $x = 7$ **C** $x = 9$
D $x = 15$ **E** $x = \frac{5}{3}$
- 2F** 4 The result when a number is tripled and increased by 21 is 96. The original number is:
A 22 **B** 32 **C** 25
D 30 **E** 27
- 2E** 5 The solution to the equation $3(x - 1) = 5x + 7$ is:
A $x = -4$ **B** $x = -5$ **C** $x = 5$
D $x = 3$ **E** $x = 1$

2F

- 6 \$x is raised from a sausage sizzle. Once the \$50 running cost is taken out, the money is shared equally among three charities so that they each get \$120. An equation to represent this is:

A $\frac{x-50}{3} = 120$

B $\frac{x}{3} - 50 = 120$

C $\frac{x}{50} = 360$

D $\frac{x}{3} = 310$

E $3x + 50 = 120$



2H

- 7 If $A = 2\pi rh$ with $A = 310$ and $r = 4$, then the value of h is closest to:

A 12.3

B 121.7

C 24.7



D 38.8

E 10.4

2H

- 8 The formula $d = \sqrt{\frac{a}{b}}$ transposed to make a the subject is:

A $a = \sqrt{bd}$

B $a = d\sqrt{b}$

C $a = \frac{d^2}{b^2}$

D $a = \frac{d}{\sqrt{b}}$

E $a = bd^2$

2G

- 9 The inequality representing the x -values on the number line below is:

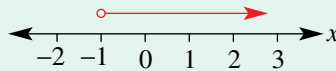

A $x < -1$

B $x > -1$

C $x \leq -1$

D $x \geq -1$

E $-1 < x < 3$

2G

- 10 The solution to the inequality $1 - 2x > 9$ is:

A $x < -4$

B $x < 4$

C $x < -5$

D $x > -4$

E $x > 5$

2I

- 11 The solution to the simultaneous equations $x + 2y = 16$ and $y = x - 4$ is:

A $x = 4, y = 0$

B $x = 8, y = 4$

C $x = 6, y = 2$

Ext

D $x = 12, y = 8$

E $x = 5, y = 1$

2J

- 12 The solution to the simultaneous equations $2x + y = 2$ and $2x + 3y = 10$ is:

A $x = 0, y = 2$

B $x = 2, y = 2$

C $x = 2, y = -2$

Ext

D $x = -1, y = 4$

E $x = -2, y = 6$

Extended-response questions

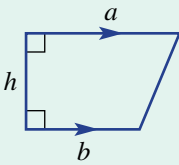
- 1 The area of a trapezium is given by $A = \frac{1}{2}(a + b)h$. A new backyard deck in the shape of the trapezium shown is being designed. Currently the dimensions are set such that $a = 12$ m and $h = 10$ m.
- 
- What range of b values is required for an area of at most 110 m^2 ?
 - Rearrange the area formula to make b the subject.
 - Use your answer to part **b** to find the length b m required to give an area of 100 m^2 .
 - Rearrange the area formula to make h the subject.
 - If b is set as 8 m, what does the width of the deck (h m) need to be reduced to for an area of 80 m^2 ?
- 2 Members of the Hayes and Thompson families attend the local Regatta by the Bay.
- The entry fee for an adult is \$18 and that for a student is \$8. The father and son from the Thompson family notice that after paying the entry fees and for 5 rides for the son and 3 for the adult, they have each spent the same amount. If the cost of a ride is the same for an adult and a student, write an equation and solve it to determine the cost of a ride.
 - For lunch each family purchases some buckets of hot chips and some drinks. The Hayes family buys 2 drinks and 1 bucket of chips for \$11 and the Thompson family buys 3 drinks and 2 buckets of chips for \$19. To determine how much each bucket of chips and each drink costs, complete the following steps.
 - Define two variables to represent the problem.
 - Set up two equations relating the variables.
 - Solve your equations in part **b ii** simultaneously.
 - What is the cost of a bucket of chips and the cost of a drink?

Ext



3

Pythagoras' theorem and trigonometry



Maths in context: Aerial and undersea drones

UAVs (unmanned aerial vehicles), or drones, have an increasing number of applications including for aerial photography, mapping, surveying, agricultural monitoring, crop spraying, bird control, firefighting, product deliveries, and emergency responses.

The UAV's flight dynamics were first represented using mathematics and then coded. Its GPS sensor receives time signals and position data from 4 GPS satellites and the UAV's algorithms instantly calculate its distance from each satellite. Algorithms

apply Pythagoras' theorem and trigonometry in 3D, computing the UAV's latitude, longitude, and altitude.

Using data inputs from its GPS, magnetometer and accelerometer, the UAV's algorithms apply trigonometry in 3D to calculate the direction and distance to fly to a given destination. It can follow detailed instructions such as distances, bearings, or the GPS of where to photograph, turn, hover, orbit, and land.



Underwater drones invented and coded by Australian scientists and engineers are becoming smaller and smarter. They can destroy marine pests like crown-of-thorns starfish and help restore coral reef health by releasing coral larvae. Other applications include surveying, monitoring, and photographing coral reefs and other seafloor structures, such as the foundations of offshore wind turbines. Also, they collect valuable data on ocean temperatures, oxygen, and carbon dioxide levels.

Chapter contents

- 3A Pythagoras' theorem
- 3B Finding the length of the shorter sides
- 3C Using Pythagoras' theorem to solve two-dimensional problems
- 3D Using Pythagoras' theorem to solve three-dimensional problems (EXTENDING)
- 3E Trigonometric ratios
- 3F Finding unknown side lengths
- 3G Solving for the denominator
- 3H Finding unknown angles
- 3I Applying trigonometry (EXTENDING)
- 3J Bearings (EXTENDING)

Australian Curriculum 9.0

NUMBER

Recognise that the real number system includes the rational numbers and the irrational numbers, and solve problems involving real numbers using digital tools (AC9M9N01)

MEASUREMENT

Solve spatial problems, applying angle properties, scale, similarity, Pythagoras' theorem and trigonometry in right-angled triangles (AC9M9M03)

SPACE

Recognise the constancy of the sine, cosine and tangent ratios for a given angle in right-angled triangles using properties of similarity (AC9M9SP01)

Design, test and refine algorithms involving a sequence of steps and decisions based on geometric constructions and theorems; discuss and evaluate refinements (AC9M9SP03)

© ACARA

Online resources

A host of additional online resources are included as part of your Interactive Textbook, including HOTmaths content, video demonstrations of all worked examples, auto-marked quizzes and much more.

3A Pythagoras' theorem

LEARNING INTENTIONS

- To know that the hypotenuse is the name of longest side of a right-angled triangle
- To know Pythagoras' theorem and how it relates the side lengths of right-angled triangles
- To be able to use Pythagoras' theorem to find the length of the hypotenuse
- To be able to express a length as a decimal or an exact value written as a surd

Pythagoras was born on the Greek island of Samos in the 6th century BCE. He received a privileged education and travelled to Egypt and Persia where he developed his ideas in mathematics and philosophy. He settled in Croton, Italy, where he founded a school. His many students and followers were called the Pythagoreans, and under the guidance of Pythagoras they lived a very structured life with strict rules. They aimed to be pure, self-sufficient and wise, where men and women were treated equally and all property was considered communal. They strove to perfect their physical and mental form, and made many advances in their understanding of the world through mathematics.

The Pythagoreans discovered the famous theorem, which is named after Pythagoras, and the existence of irrational numbers such as $\sqrt{2}$, which cannot be written down as a fraction or terminating decimal. Such numbers cannot be measured exactly with a ruler with fractional parts and were thought to be unnatural. The Pythagoreans called these numbers 'unutterable' numbers and it is believed that any member of the brotherhood who mentioned these numbers in public would be put to death.



Land surveyors measure the horizontal and vertical distance between two locations of different altitudes. The straight line distance of the slope, which forms a hypotenuse, is calculated using Pythagoras' theorem.

Lesson starter: Matching the areas of squares

Look at this right-angled triangle and the squares drawn on each side. Each square is divided into smaller sections.

- Can you see how the parts of the two smaller squares would fit into the larger square?
- What is the area of each square if the side lengths of the right-angled triangle are a , b and c as marked?
- What do the answers to the above two questions suggest about the relationship between a , b and c ?

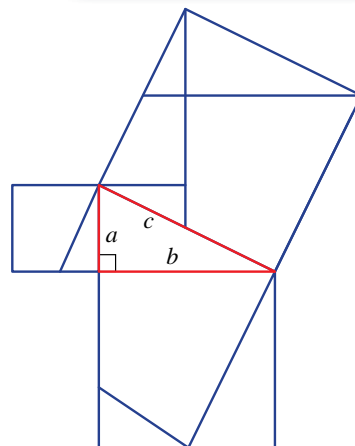

KEY IDEAS

- The longest side of a right-angled triangle is called the **hypotenuse** and is opposite the right angle.
- The **theorem of Pythagoras** says that the square of the length of the hypotenuse is equal to the sum of the squares of the lengths of the other two sides.

For the triangle shown, it is:

$$c^2 = a^2 + b^2$$

↑ ↙ ↘
 square of the squares of the
 hypotenuse two shorter sides

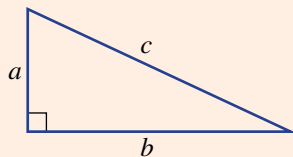

- The theorem can be illustrated in a diagram like the one on the right. The sum of the areas of the two smaller squares ($a^2 + b^2$) is the same as the area of the largest square (c^2).

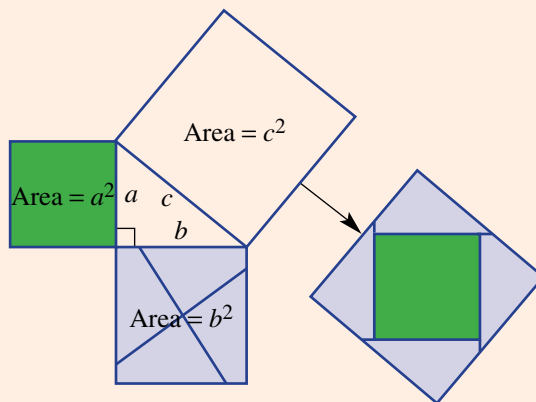

- Lengths can be expressed with **exact values** using **surds**. $\sqrt{2}$, $\sqrt{28}$ and $2\sqrt{3}$ are examples of surds.
- When expressed as a decimal, a surd is an infinite non-recurring decimal with no pattern.
 For example: $\sqrt{2} = 1.4142135623\dots$

- A **Pythagorean** triad is a set of three whole numbers that can be used to form a right-angled triangle. The best known examples are:

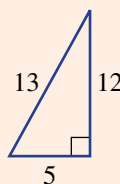
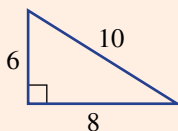
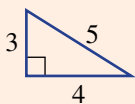

BUILDING UNDERSTANDING

- 1 State the length of the hypotenuse (c units) in these right-angled triangles.

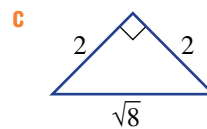
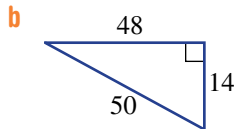
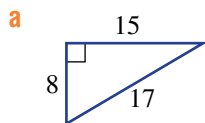

- 2 State Pythagoras' theorem using the given pronumerals for these right-angled triangles. For example: $z^2 = x^2 + y^2$.

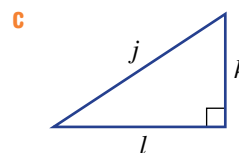
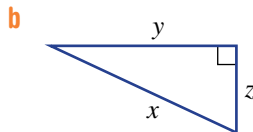
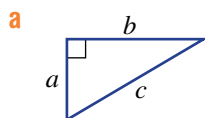

- 3 Evaluate the following, rounding to two decimal places in part d.

a 3.2^2

b $3^2 + 2^2$

c $\sqrt{64 + 36}$

d $\sqrt{24}$



**Example 1** Finding the length of the hypotenuse

Find the length of the hypotenuse in these right-angled triangles. Round to two decimal places in part b.

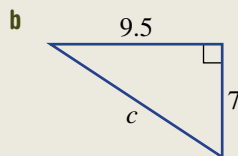
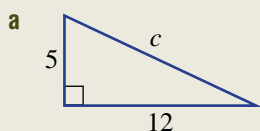
**SOLUTION**

$$\begin{aligned} \mathbf{a} \quad c^2 &= a^2 + b^2 \\ &= 5^2 + 12^2 \\ &= 169 \\ \therefore c &= \sqrt{169} \\ &= 13 \end{aligned}$$

$$\begin{aligned} \mathbf{b} \quad c^2 &= a^2 + b^2 \\ &= 7^2 + 9.5^2 \\ &= 139.25 \\ \therefore c &= \sqrt{139.25} \\ &= 11.80 \text{ (to 2 d.p.)} \end{aligned}$$

EXPLANATION

Write the rule and substitute the lengths of the two shorter sides.

$$\text{If } c^2 = 169 \text{ then } c = \sqrt{169} = 13.$$

The order for a and b does not matter since $7^2 + 9.5^2 = 9.5^2 + 7^2$.

Round as required.

Now you try

Find the length of the hypotenuse in these right-angled triangles. Round to two decimal places in part b.

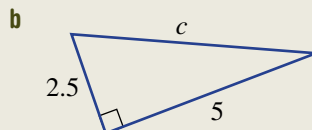
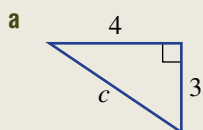
**Example 2** Finding the length of the hypotenuse using exact values

Find the length of the hypotenuse in this right-angled triangle, leaving your answer as an exact value.

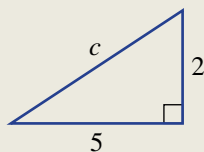

SOLUTION

$$\begin{aligned}c^2 &= a^2 + b^2 \\ &= 5^2 + 2^2 \\ &= 29 \\ \therefore c &= \sqrt{29}\end{aligned}$$

EXPLANATION

Apply Pythagoras' theorem to find the value of c .

Express the answer exactly using a surd.

Now you try

Find the length of the hypotenuse in this right-angled triangle, leaving your answer as an exact value.

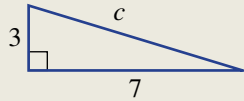
**Exercise 3A****FLUENCY**

1–4(1/2)

1–5(1/2)

1–5(1/3)

Example 1a

- 1 Find the length of the hypotenuse in each of the following right-angled triangles.

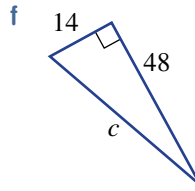
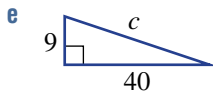
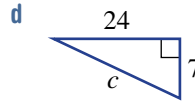
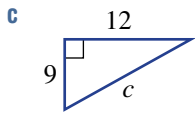
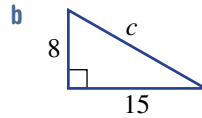
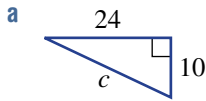

Example 1b

- 2 Find the length of the hypotenuse in each of these right-angled triangles, correct to two decimal places.

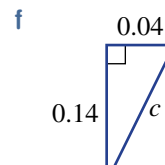
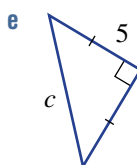
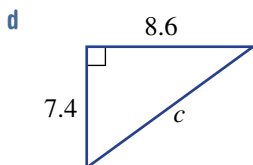
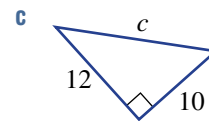
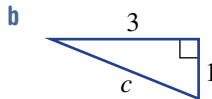
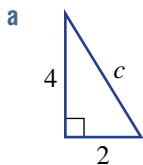

Example 2 3 Find the length of the hypotenuse in these triangles, leaving your answer as an exact value.

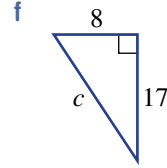
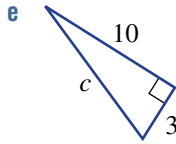
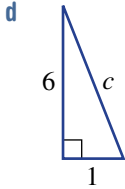
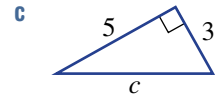
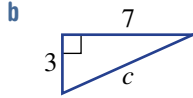
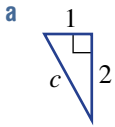

4 Find the length of the hypotenuse in each of these right-angled triangles, rounding to two decimal places where necessary. Convert to the units indicated in red.

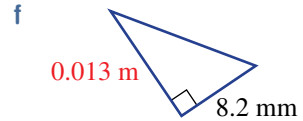
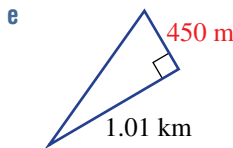
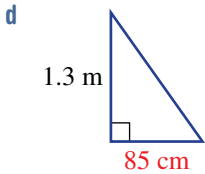
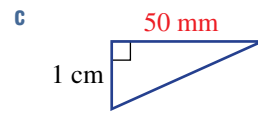
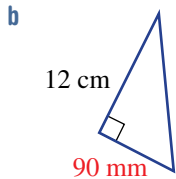
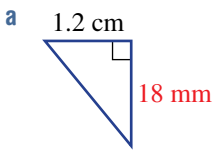

5 For each of these triangles, first calculate the length of the hypotenuse then find the perimeter, correct to two decimal places.

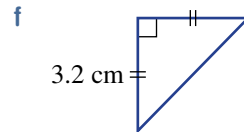
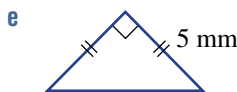
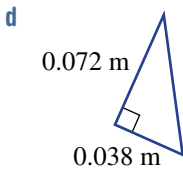
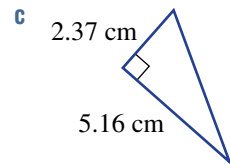
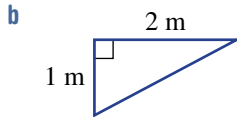
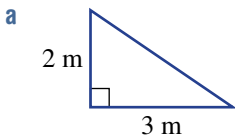

PROBLEM-SOLVING

6–8

6–9

8–11

6 Find the length of the diagonal steel brace required to support a wall of length 3.5 m and height 2.6 m. Give your answer correct to one decimal place.

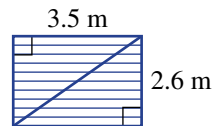

7 Find the perimeter of this triangle. (*Hint*: You will need to find AB and BC first.)

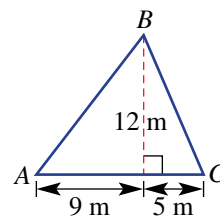

8 A helicopter hovers at a height of 150 m above the ground and is a horizontal distance of 200 m from a beacon on the ground. Find the direct distance of the helicopter from the beacon.

9 Find the length of the longest rod that will fit inside a cylinder of height 2.1 m and circular end surface of diameter 1.2 m. Give your answer correct to one decimal place.

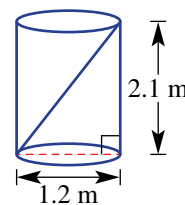

10 A miniature rocket blasts off at an angle of 45° and travels in a straight line. After a few seconds, it reaches a height of 350 m above the ground. At this point it has also covered a horizontal distance of 350 m. How far has the rocket travelled to the nearest metre?

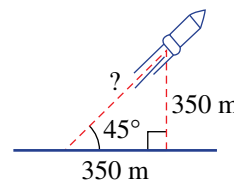

11 For the shape shown, find the value of:

- a x
- b y (as a fraction).

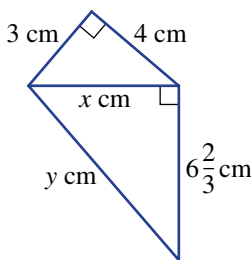

REASONING

12

12, 13(1/2)

13(1/2), 14, 15

12 One way to check whether a four-sided figure is a rectangle is to ensure that both its diagonals are the same length. What should the length of the diagonals be if a rectangle has side lengths 3 m and 5 m? Answer to two decimal places.

13 We know that if the triangle has a right angle, then $c^2 = a^2 + b^2$. The converse of this is that if $c^2 = a^2 + b^2$ then the triangle must have a right angle. Test whether $c^2 = a^2 + b^2$ to see if these triangles have a right angle. They may not be drawn to scale.

a

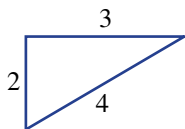

b

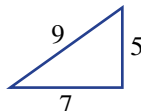

c

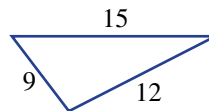

d

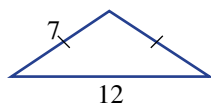

e

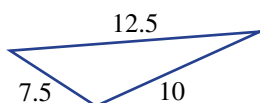

f

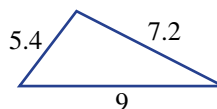

- 14 We saw in Question 13 the test for a right-angled triangle. We can also use the theorem to determine if a triangle is acute-angled or obtuse-angled.
- If the two shorter sides of a triangle are 5 cm and 8 cm, what is the length of the longest side if the triangle is right-angled? Answer to one decimal place.
 - Use your answer to part a to determine if a triangle with lengths 5 cm, 8 cm and the length given is acute-angled or obtuse-angled.
 - 9 cm
 - 11 cm
 - Complete the following.
 - If $a^2 + b^2 < c^2$, the triangle is _____-angled.
 - If $a^2 + b^2 > c^2$, the triangle is _____-angled.

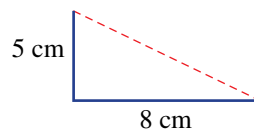

- 15 Triangle ABC is a right-angled isosceles triangle, and BD is perpendicular to AC . $DC = 4$ cm and $BD = 4$ cm.
- Find the length of BC correct to two decimal places.
 - State the length of AB correct to two decimal places.
 - Use Pythagoras' theorem and $\triangle ABC$ to check that the length of AC is twice the length of DC .

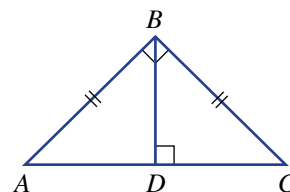

ENRICHMENT: Kennels and kites

16, 17

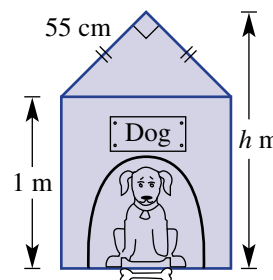
- 16 A dog kennel has the dimensions shown in the diagram on the right. Give your answers to each of the following correct to two decimal places.
- What is the width, in cm, of the kennel?
 - What is the total height, h m, of the kennel?
 - If the sloping height of the roof was to be reduced from 55 cm to 50 cm, what difference would this make to the total height of the kennel in centimetres? (Assume that the width is the same as in part a.)
 - What is the length, in cm, of the sloping height of the roof of a new kennel if it is to have a total height of 1.2 m? (The height of the kennel without the roof is still 1 m and its width is unchanged.)

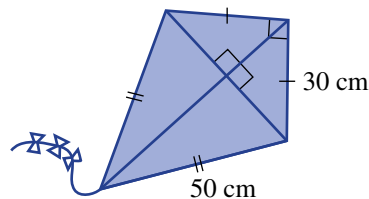

- 17 The frame of a kite is constructed with six pieces of timber dowel. The four pieces around the outer edge are two 30 cm pieces and two 50 cm pieces as shown. The top end of the kite is to form a right angle. Find the length of each of the diagonal pieces required to complete the construction. Answer to two decimal places.



3B Finding the length of the shorter sides

LEARNING INTENTIONS

- To know how to use Pythagoras' theorem when the unknown side is not the hypotenuse
- To be able to use Pythagoras' theorem to find the length of a shorter side

Throughout history, mathematicians have used known theorems to explore new ideas, discover new theorems and solve a wider range of problems. Similarly, Pythagoras knew that his right-angled triangle theorem could be manipulated so that the length of one of the shorter sides of a triangle can be found if the length of the other two sides are known.

We know that the sum $7 = 3 + 4$ can be written as a difference $3 = 7 - 4$. Likewise, if $c^2 = a^2 + b^2$ then $a^2 = c^2 - b^2$ or $b^2 = c^2 - a^2$.

Applying this to a right-angled triangle means that we can now find the length of one of the shorter sides if the other two sides are known.



Knowing the vertical height between floors and an escalator's length, engineers can use Pythagoras' theorem to calculate the minimum horizontal width of floor space needed by an escalator.

Lesson starter: True or false

Some mathematical statements relating to a right-angled triangle with hypotenuse c and the two shorter sides a and b are shown.

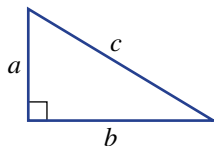

Some of these mathematical statements are true and some are false. Can you sort them into true and false groups?

$$a^2 + b^2 = c^2$$

$$a = \sqrt{c^2 - b^2}$$

$$c^2 - a^2 = b^2$$

$$a^2 - c^2 = b^2$$

$$c = \sqrt{a^2 + b^2}$$

$$b = \sqrt{a^2 - c^2}$$

$$c = \sqrt{a^2 - b^2}$$

$$c^2 - b^2 = a^2$$

KEY IDEAS

- When finding the length of a side:
- substitute known values into Pythagoras' theorem
 - solve this equation to find the unknown value.

For example:

- If $a^2 + 16 = 30$ then subtract 16 from both sides.
- If $a^2 = 14$ then take the square root of both sides.
 - $a = \sqrt{14}$ is an **exact** answer (a surd).
 - $a = 3.74$ is a rounded decimal answer.

$$\begin{aligned}c^2 &= a^2 + b^2 \\25^2 &= a^2 + 15^2 \\625 &= a^2 + 225 \\400 &= a^2 \\a &= \sqrt{400} \\a &= 20\end{aligned}$$

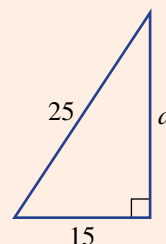

BUILDING UNDERSTANDING

- 1 Find the value of a or b in these equations. (Both a and b are positive numbers.)

a $a = \sqrt{196}$

b $a^2 = 144$

c $b^2 + 9 = 25$

d $36 + b^2 = 100$

- 2 Given that $a^2 + 64 = 100$, decide whether the following are true or false.

a $a^2 = 100 - 64$

b $64 = 100 + a^2$

c $100 = \sqrt{a^2 + 64}$

d $a = \sqrt{100 - 64}$

e $a = 6$

f $a = 10$



Example 3 Finding the length of a shorter side

In each of the following, find the value of the pronumeral. Round your answer in part **b** to two decimal places and give an exact answer to part **c**.

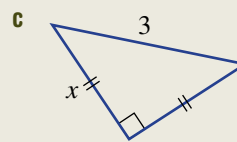
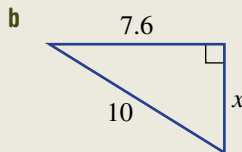
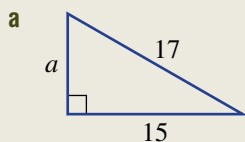

SOLUTION

a $a^2 + 15^2 = 17^2$

$$a^2 + 225 = 289$$

$$a^2 = 64$$

$$a = \sqrt{64}$$

$$a = 8$$

b $x^2 + 7.6^2 = 10^2$

$$x^2 + 57.76 = 100$$

$$x^2 = 42.24$$

$$x = \sqrt{42.24}$$

$$x = 6.50 \text{ (to 2 d.p.)}$$

EXPLANATION

Write the rule and substitute the known sides.

Square 15 and 17.

Subtract 225 from both sides.

Take the square root of both sides.

Write the rule.

Subtract 57.76 from both sides.

Take the square root of both sides.

Round to two decimal places.

$$\begin{aligned} \text{c } x^2 + x^2 &= 3^2 \\ 2x^2 &= 9 \\ x^2 &= \frac{9}{2} \\ x &= \sqrt{\frac{9}{2}} \left(= \frac{3}{\sqrt{2}} = \frac{3\sqrt{2}}{2} \right) \end{aligned}$$

Two sides are of length x .
 Add like terms and then divide both sides by 2.
 Take the square root of both sides. To express as an exact answer, do not round.
 Different forms are possible.

Now you try

In each of the following, find the value of the pronumeral. Round your answer in part **b** to two decimal places and give an exact answer to part **c**.

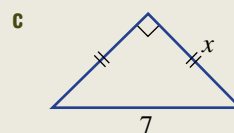
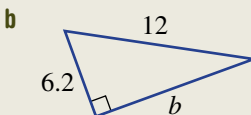
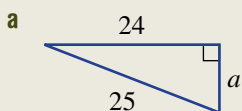

Exercise 3B

FLUENCY

$1-3(\frac{1}{2}), 4$

$1-3(\frac{1}{2}), 4$

$1-3(\frac{1}{3}), 4$

Example 3a

1 In each of the following, find the value of the pronumeral.

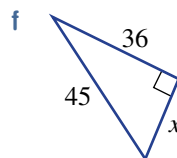
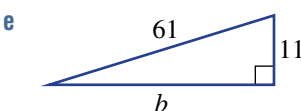
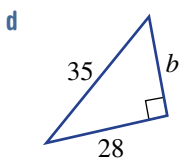
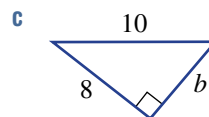
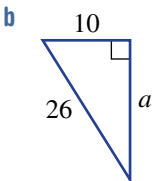
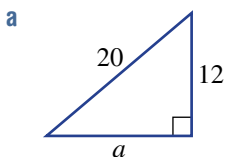

Example 3b

2 In each of the following, find the value of the pronumeral. Express your answers correct to two decimal places.

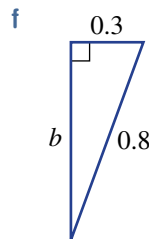
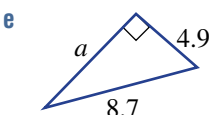
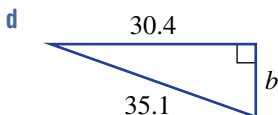
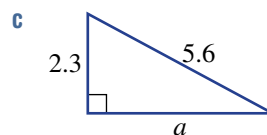
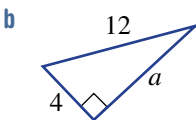
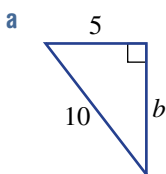

- 3 Find the length of the unknown side of each of these triangles, correct to two decimal places where necessary. Convert to the units shown in red.

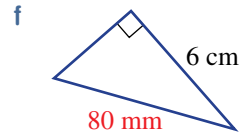
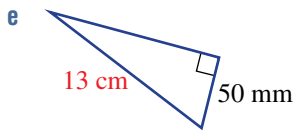
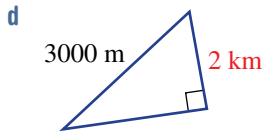
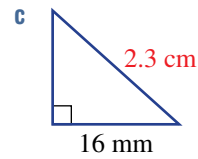
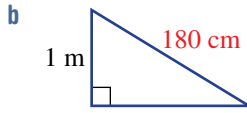
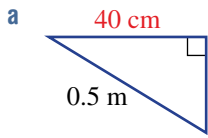

- Example 3c 4 In each of the following, find the value of x as an exact answer.

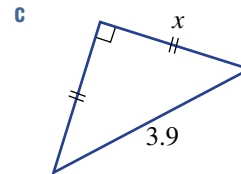
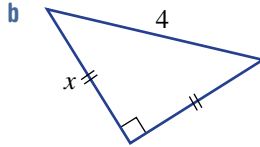
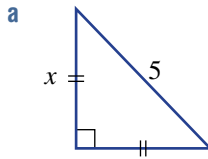

PROBLEM-SOLVING

5–7

6–8

7–9

- 5 The base of a ladder leaning against a vertical wall is 1.5 m from the base of the wall. If the ladder is 5.5 m long, find how high the top of the ladder is above the ground, correct to one decimal place.

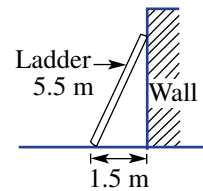

- 6 A 32 m communication tower is supported by 35 m cables stretching from the top of the tower to a position at ground level as shown. Find the distance from the base of the tower to the point where the cable reaches the ground, correct to one decimal place.

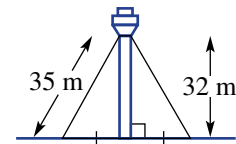

- 7 For each of the following diagrams, find the value of x . Give an exact answer each time.

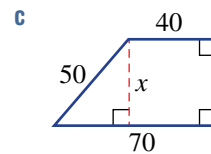
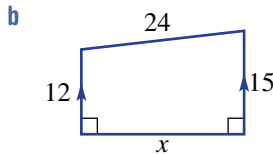
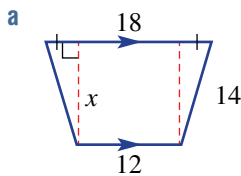

- 8 If a television has a screen size of 63 cm it means that the diagonal length of the screen is 63 cm. If the vertical height of a 63 cm screen is 39 cm, find the width of the screen to the nearest centimetre.

- 9 Two 1.3 m vertical fence posts are supported by a 2.27 m bar, as shown in the diagram on the right. Find the distance (d m) from the base of one post to the base of the second post. Give your answer correct to two decimal places.

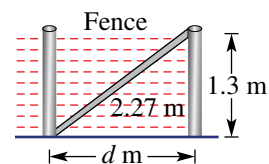

REASONING 10 10 10, 11

10 For these questions note that $(2x)^2 = 4x^2$ and $(3x)^2 = 9x^2$. Find the value of x as an exact answer.

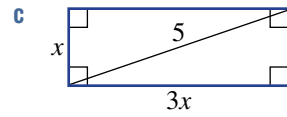
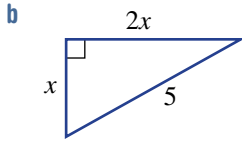
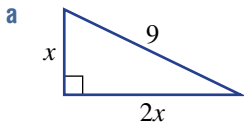

11 A right-angled triangle has a hypotenuse measuring 5 m. Find the lengths of the other sides if their lengths are in the given ratio. Give an exact answer. (Hint: You can draw a triangle like the one shown for part a.)

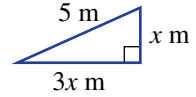

- a 1 to 3 b 2 to 3 c 5 to 7

ENRICHMENT: The power of exact values - - 12, 13

- 12 Consider this diagram and the unknown length x .
- Explain what needs to be found first before x can be calculated.
 - Now try calculating the value x as an exact value.
 - Was it necessary to calculate the value of c or was c^2 enough?
 - What problems might be encountered if the value of c is calculated and rounded before the value of x is found?

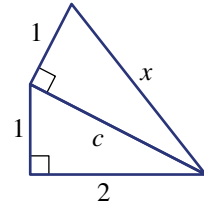

13 In the diagram at right, $OD = 3$ and $AB = BC = CD = 1$.

- Using exact values find the length of:
 - OC
 - OB
 - OA
- Round your answer in part a iii to one decimal place and use that length to recalculate the lengths of OB , OC and OD (correct to two decimal places) starting with $\triangle OAB$.
- Explain the difference between the given length $OD = 3$ and your answer for OD in part b.
- Investigate how changing the side length AB affects your answers to parts a to c above.

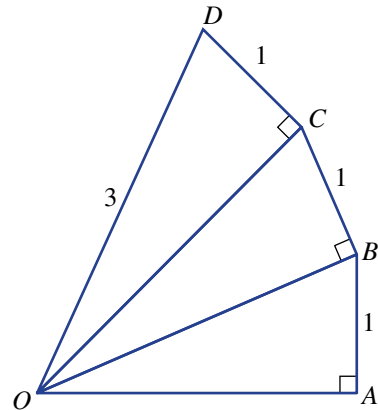

3C Using Pythagoras' theorem to solve two-dimensional problems

LEARNING INTENTIONS

- To be able to identify a right-angled triangle in a diagram and label known values
- To be able to apply Pythagoras' theorem to the triangle to find an unknown value

Initially it may not be obvious that Pythagoras' theorem can be used to help solve a particular problem. With further investigation, however, it may be possible to identify and draw a right-angled triangle that can help solve the problem. As long as two sides of the right-angled triangle are known, the length of the third side can be found.



Engineers and architects regularly use Pythagoras' theorem, for example, to calculate the length of each cable on the Anzac Bridge, Sydney.

Lesson starter: The biggest square

Imagine trying to cut the largest square from a circle of a certain size and calculating the side length of the square. Drawing a simple diagram as shown does not initially reveal a right-angled triangle.

- If the circle has a diameter of 2 cm, can you find a good position to draw the diameter that also helps to form a right-angled triangle?
- Can you determine the side length of the largest square?
- What percentage of the area of a circle does the largest square occupy?

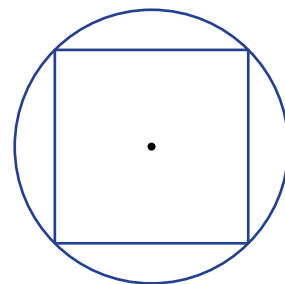

KEY IDEAS

- When applying Pythagoras' theorem, follow these steps.
 - Identify and draw a right-angled triangle that may help to solve the problem.
 - Label the sides with their lengths or with a letter (pronumeral) if the length is unknown.
 - Use Pythagoras' theorem to solve for the unknown.
 - Solve the problem by making any further calculations and answering in words.
 - Check that the answer makes sense.

BUILDING UNDERSTANDING



1 Match each problem (a, b or c) with both a diagram (A, B or C) and its solution (I, II, III).

a Two trees stand 20 m apart and they are 32 m and 47 m tall. What is the distance between the tops of the two trees?

b A man walks due north for 2 km then north-east for 3 km. How far north is he from his starting point?

c A kite is flying with a kite string of length 35 m. Its horizontal distance from its anchor point is 17 m. How high is the kite flying?

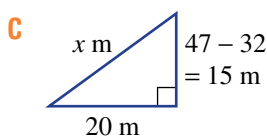
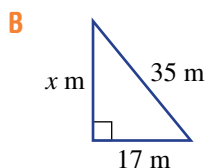
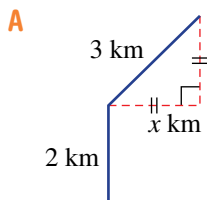

I The kite is flying at a height of 30.59 m.

II The distance between the top of the two trees is 25 m.

III The man has walked a total of $2 + 2.12 = 4.12$ km north from his starting point.



Example 4 Applying Pythagoras' theorem

Two skyscrapers are located 25 m apart and a cable links the tops of the two buildings. Find the length of the cable if the buildings are 50 m and 80 m in height. Give your answer correct to two decimal places.

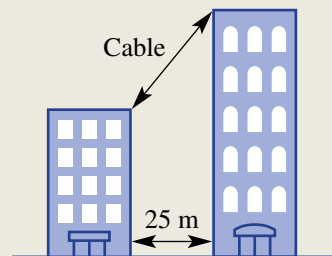

SOLUTION

Let x m be the length of the cable.

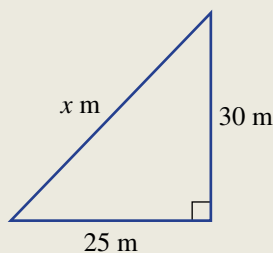

EXPLANATION

Draw a right-angled triangle and label the measurements and pronumerals.

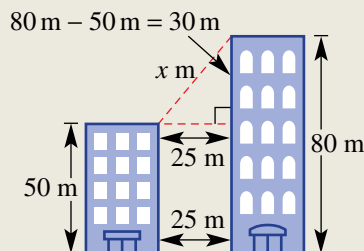

Continued on next page

$$\begin{aligned}
 c^2 &= a^2 + b^2 \\
 x^2 &= 25^2 + 30^2 \\
 x^2 &= 625 + 900 \\
 &= 1525 \\
 x &= \sqrt{1525} \\
 &= 39.05 \text{ (to 2 d.p.)}
 \end{aligned}$$

The cable is 39.05 m long.

Set up an equation using Pythagoras' theorem and solve for x .

Answer the question in words.

Now you try

Two poles are located 40 m apart and a rope links the tops of the two poles. Find the length of the rope if the poles are 15 m and 21 m in height. Give your answer correct to two decimal places.

Exercise 3C

FLUENCY

1–4

1–5

2–5

Example 4



- 1 Two poles are located 2 m apart. A wire links the tops of the two poles. Find the length of the wire if the poles are 2.8 m and 5 m in height. Give your answer correct to one decimal place.

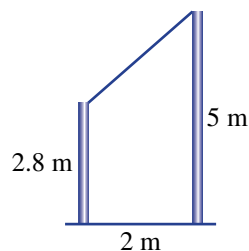

- 2 Two skyscrapers are located 25 m apart and a cable of length 62.3 m links the tops of the two buildings. If the taller building is 200 metres tall, what is the height of the shorter building? Give your answer correct to one decimal place.



- 3 A garage is to be built with a skillion roof (a roof with a single slope). The measurements are given in the diagram. Calculate the pitch line length, to the nearest millimetre. Allow 500 mm for each of the eaves.

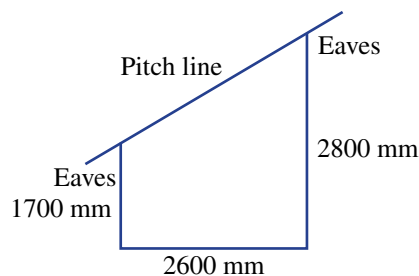

- 4 Two bushwalkers are standing on different mountain sides. According to their maps, one of them is at a height of 2120 m and the other is at a height of 1650 m. If the horizontal distance between them is 950 m, find the direct distance between the two bushwalkers. Give your answer correct to the nearest metre.

- 5 Find the direct distance between the points A and B in each of the following, correct to one decimal place.

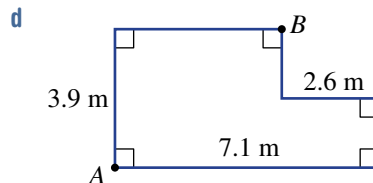
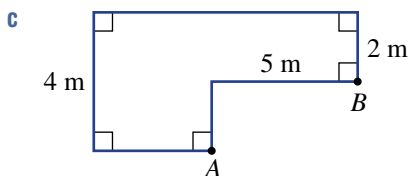
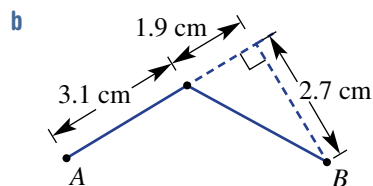
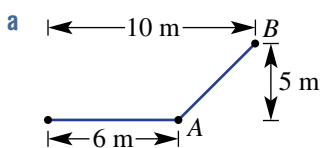

PROBLEM-SOLVING

6, 7

7, 8

7-9

- 6 A 100 m radio mast is supported by six cables in two sets of three cables. All six cables are anchored to the ground at an equal distance from the mast. The top set of three cables is attached at a point 20 m below the top of the mast. Each of the three lower cables is 60 m long and attached at a height of 30 m above the ground. If all the cables have to be replaced, find the total length of cable required. Give your answer correct to two decimal places.

- 7 In a particular circle of radius 2 cm, AB is a diameter and C is a point on the circumference. Angle ACB is a right angle. The chord AC is 1 cm in length.

- a Draw the triangle ABC as described, and mark in all the important information.
b Find the length of BC correct to one decimal place.

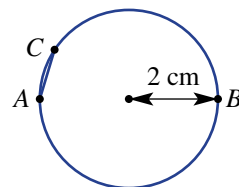

- 8 A suspension bridge is built with two vertical pylons and two straight beams of equal length that are positioned to extend from the top of the pylons to meet at a point C above the centre of the bridge, as shown in the diagram on the right.

- a Calculate the vertical height of the point C above the tops of the pylons.
b Calculate the distance between the pylons, that is, the length of the span of the bridge, correct to one decimal place.

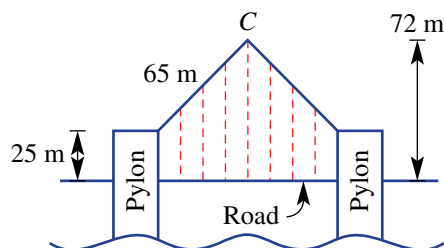

- 9 Two circles of radii 10 cm and 15 cm respectively are placed inside a square. Find the perimeter of the square to the nearest centimetre. (*Hint:* First find the diagonal length of the square using the diagram shown.)

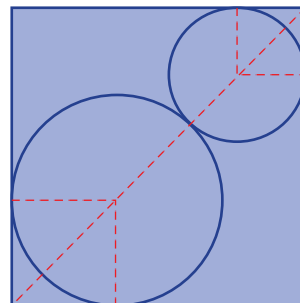

REASONING 10 10 10, 11

10 It is possible to find the length of the shorter sides of a right-angled isosceles triangle if only the hypotenuse length is known.

a Find the exact value of x in this right-angled isosceles triangle.

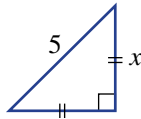

b Now find the exact value of a in this diagram.

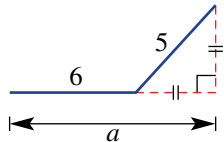

 c Finally, use your results from above to find the length of AB in this diagram correct to one decimal place.

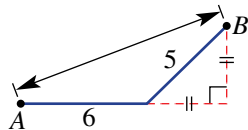

 11 Use the method outlined in Question 10 for this problem.

In an army navigation exercise, a group of soldiers hiked due south from base camp for 2.5 km to a water hole. From there, they turned 45° to the left, to head south-east for 1.6 km to a resting point. When the soldiers were at the resting point, how far (correct to one decimal place):

- a east were they from the water hole?
- b south were they from the water hole?
- c were they in a straight line from base camp?

ENRICHMENT: Folding paper - - 12

 12 A square piece of paper, $ABCD$, of side length 20 cm is folded to form a right-angled triangle ABC . The paper is folded a second time to form a right-angled triangle ABE as shown in the diagram.

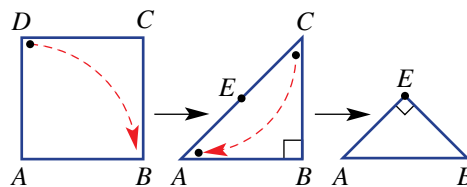

- a Find the length of AC correct to two decimal places.
- b Find the perimeter of each of the following, correct to one decimal place where necessary:
 - i square $ABCD$
 - ii triangle ABC
 - iii triangle ABE
- c Use Pythagoras' theorem and your answer for part a to confirm that $AE = BE$ in triangle ABE .
- d Investigate how changing the initial side length changes the answers to the above.

3D Using Pythagoras' theorem to solve three-dimensional problems EXTENDING

LEARNING INTENTIONS

- To understand how right-angled triangles can arise in 3D solids
- To be able to identify a right-angled triangle in a 3D solid
- To be able to apply Pythagoras' theorem in the identified triangle

If you cut a solid to form a cross-section, a two-dimensional shape is revealed. From that cross-section it may be possible to identify a right-angled triangle that can be used to find unknown lengths. These lengths can then tell us information about the three-dimensional solid.

You can visualise right-angled triangles in all sorts of different solids.

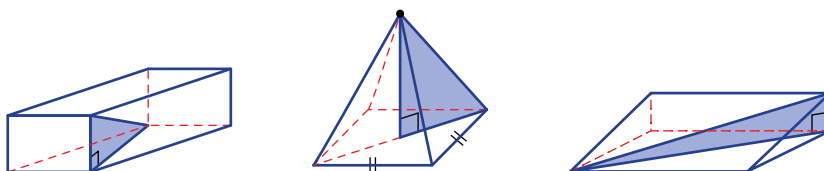

Engineers, architects, builders and carpenters use Pythagoras' theorem to calculate the direct distance between two positions in three dimensions. For example, calculating the length of trusses that support the roof of this Sydney sports stadium.

Lesson starter: How many triangles in a pyramid?

Here is a drawing of a square-based pyramid. By drawing lines from any vertex to the centre of the base and another point, how many different right-angled triangles can you visualise and draw? The triangles could be inside or on the outside surface of the pyramid.

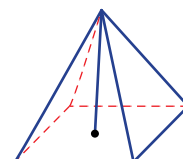

KEY IDEAS

- Right-angled triangles can be identified in many three-dimensional solids.
- It is important to try to draw any identified right-angled triangle using a separate diagram.

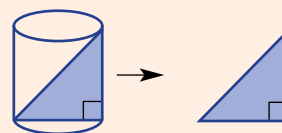

BUILDING UNDERSTANDING

1 Decide if the following shaded regions would form right-angled triangles.

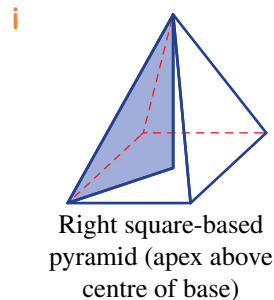
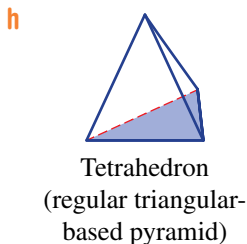
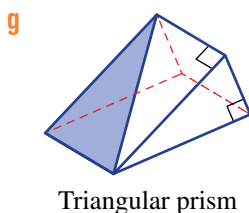
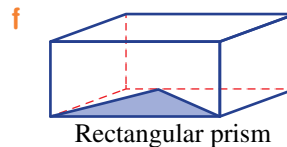
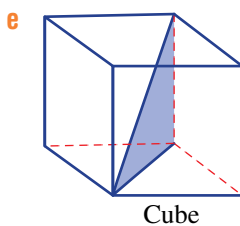
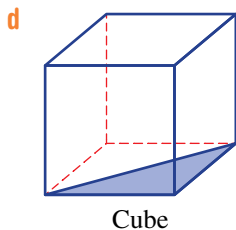
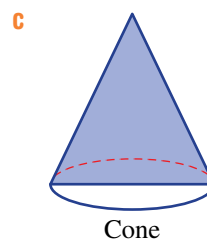
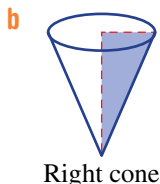
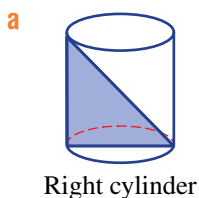

Example 5 Using Pythagoras in 3D

The length of the diagonal on the base of a rectangular prism is 8.3 m and the height of the rectangular prism is 3.9 m. Find the distance from one corner of the rectangular prism to the opposite corner. Give your answer correct to two decimal places.

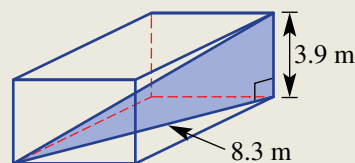

SOLUTION

Let d m be the distance required.

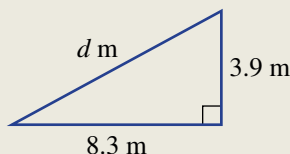

$$\begin{aligned} d^2 &= 3.9^2 + 8.3^2 \\ &= 84.1 \\ \therefore d &= 9.17 \text{ (to 2 d.p.)} \end{aligned}$$

The distance from one corner of the rectangular prism to the opposite corner is approximately 9.17 m.

EXPLANATION

Draw a right-angled triangle and label all the measurements and pronumerals.

Use Pythagoras' theorem.
Round $\sqrt{84.1}$ to two decimal places.

Write your answer in words.

Now you try

A cylinder has diameter 4.4 cm and height 6.2 cm. Find the distance from a point on the circumference of the base to a point on the opposite side at the top. Give your answer correct to two decimal places.

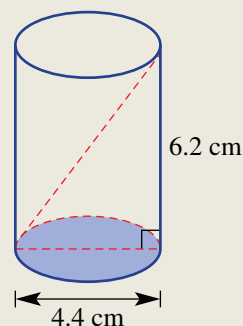
**Exercise 3D****FLUENCY**

1–5

1–6

2, 3, 5, 6

Example 5

- 1 The length of the diagonal on the base of a rectangular prism is 10 mm and the height of the rectangular prism is 5 mm. Find the distance from one corner of the rectangular prism to the opposite corner. Give your answer correct to two decimal places.

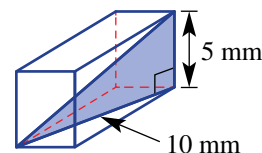

- 2 Find the distance, d units, from one corner to the opposite corner in each of the following rectangular prisms. Give your answers correct to two decimal places.

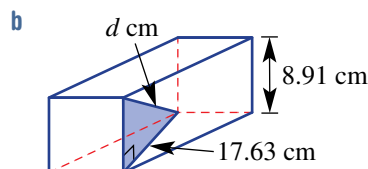
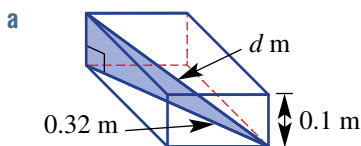

- 3 Find the slant height, s units, of each of the following cones. Give your answers correct to one decimal place.

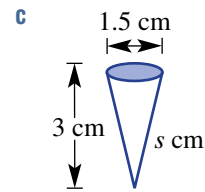
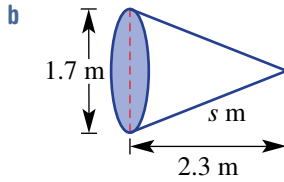
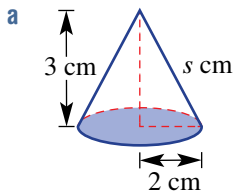

- 4 Find the length to the nearest millimetre of the longest rod that will fit inside a cylinder of the following dimensions.

- a Diameter 10 cm and height 15 cm
 b Radius 2.8 mm and height 4.2 mm
 c Diameter 0.034 m and height 0.015 m

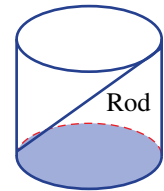

- 5 The cube in the diagram on the right has 1 cm sides.

- a Find the length of AC as an exact value.
 b Hence, find the length of AD correct to one decimal place.

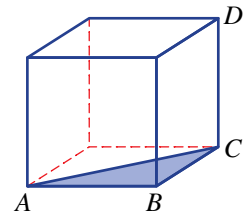

- 6 Consider the shape shown.

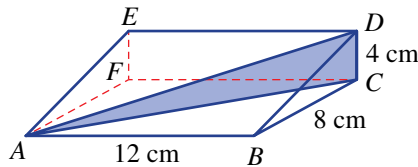

- a Find the length of AC as an exact value.
 b Hence, find the length of AD correct to one decimal place.

PROBLEM-SOLVING

7

7, 8

8, 9

- 7 A miner makes claim to a circular piece of land with a radius of 40 m from a given point, and is entitled to dig to a depth of 25 m. If the miner can dig tunnels at any angle, find the length of the longest straight tunnel that he can dig, to the nearest metre.

- 8 A bowl shown below is in the shape of a hemisphere (half sphere) with radius 10 cm. The surface of the water in the container has a radius of 7 cm. How deep is the water? Give your answer to two decimal places.

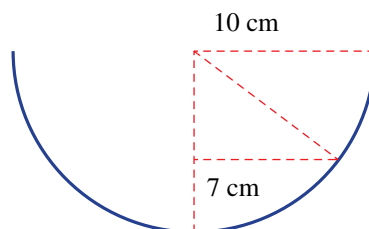

- 9 A cube of side length l sits inside a sphere of radius r so that the vertices of the cube sit on the sphere. Find the ratio $r : l$.

REASONING

10

10

10, 11

- 10 For this rectangular prism answer these questions.

- Find the exact length AB .
- Find AB correct to two decimal places.
- Find the length AC using your result from part **a** and then round to two decimal places.
- Find the length AC using your result from part **b** and then round to two decimal places.
- How can you explain the difference between your results from parts **c** and **d** above?

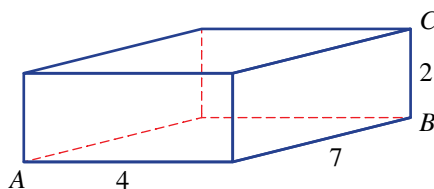

- 11 There are different ways to approach finding the height of a pyramid depending on what information is given. For each of the following square-based pyramids, find:

- the exact length (using a surd) of the diagonal on the base
- the height of the pyramid correct to two decimal places.

a

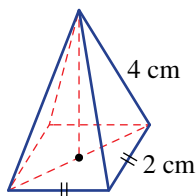

b

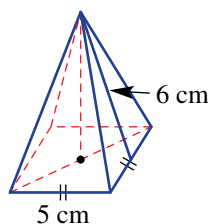

ENRICHMENT: Spider crawl

-

-

12

- 12 A spider crawls from one corner, A , of the ceiling of a room to the opposite corner, G , on the floor. The room is a rectangular prism with dimensions as given in the diagram shown.

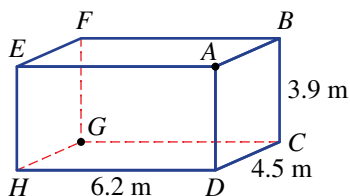

- Assuming the spider crawls in a direct line between points, find how far (correct to two decimal places) the spider crawls if it crawls from A to G via:
 - B
 - C
 - D
 - F
- Investigate other paths to determine the shortest distance that the spider could crawl in order to travel from point A to point G . (*Hint*: Consider drawing a net for the solid.)

3E Trigonometric ratios

LEARNING INTENTIONS

- To know how to label the sides of a right-angled triangle with reference to an angle
- To know the three trigonometric ratios for right-angled triangles
- To understand that for any right-angled triangle with the same angles, the trigonometric ratios are the same
- To be able to write a trigonometric ratio for a right-angled triangle

The branch of mathematics called trigonometry deals with the relationship between the side lengths and angles in triangles. Trigonometry dates back to the ancient Egyptian and Babylonian civilisations in which a basic form of trigonometry was used in the building of pyramids and in the study of astronomy. The first table of values including chord and arc lengths on a circle for a given angle was created by Hipparchus in the 2nd century BCE in Greece. These tables of values helped to calculate the position of the planets. About three centuries later, Claudius Ptolemy advanced the study of trigonometry writing by 13 books called the *Almagest*. Ptolemy also developed tables of values linking the sides and angles of a triangle, and produced many theorems which use the sine, cosine and tangent functions.



Everyday users of trigonometry include surveyors, engineers, architects, designers and builders of houses, carports, awnings and holiday cabins.

Lesson starter: Constancy of sine, cosine and tangent

In geometry we would say that similar triangles have the same shape but are of different size. Here are three similar right-angled triangles. The angle θ (theta) is the same for all three triangles.

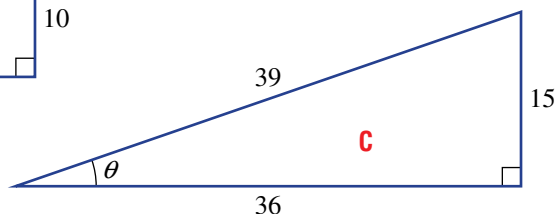
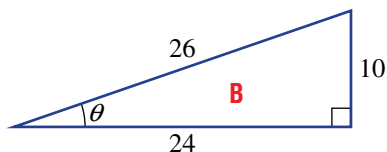
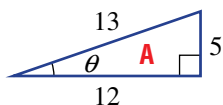

We will now calculate three special ratios – sine, cosine and tangent – for the angle θ in these triangles. We use the sides labelled Hypotenuse (H), Opposite (O) and Adjacent (A) as shown at right.

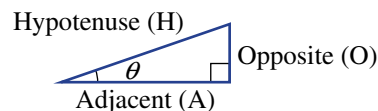

- Complete this table simplifying all fractions.
- What do you notice about the value of:
 - $\sin \theta$ (i.e. $\frac{O}{H}$) for all three triangles?
 - $\cos \theta$ (i.e. $\frac{A}{H}$) for all three triangles?
 - $\tan \theta$ (i.e. $\frac{O}{A}$) for all three triangles?
- Why are the three ratios ($\sin \theta$, $\cos \theta$ and $\tan \theta$) the same for all three triangles? Discuss.

Triangle	$\frac{O}{H}$ ($\sin \theta$)	$\frac{A}{H}$ ($\cos \theta$)	$\frac{O}{A}$ ($\tan \theta$)
A	$\frac{5}{13}$		
B		$\frac{24}{26} = \frac{12}{13}$	
C			$\frac{15}{36} = \frac{5}{12}$

KEY IDEAS

- In this topic, the Greek letter (θ) is often used to label an unknown angle.
- For a right-angled triangle with another angle θ then:
 - the **hypotenuse** is the longest side, opposite the 90° angle
 - the **opposite** side is opposite θ
 - the **adjacent** side is next to θ but is not the hypotenuse.

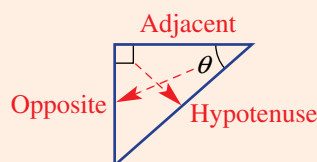
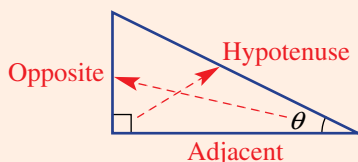

- For a right-angled triangle with a given angle θ , the three ratios **sine (sin)**, **cosine (cos)** and **tangent (tan)** are given by:
 - sine ratio: $\sin \theta = \frac{\text{length of the opposite side}}{\text{length of the hypotenuse}}$
 - cosine ratio: $\cos \theta = \frac{\text{length of the adjacent side}}{\text{length of the hypotenuse}}$
 - tangent ratio: $\tan \theta = \frac{\text{length of the opposite side}}{\text{length of the adjacent side}}$
- For any right-angled triangle with the same angles, these ratios are always the same i.e. the three ratios remain constant when a right-angled triangle is enlarged or reduced using a scale factor.
- The term **SOHCAHTOA** is useful when trying to remember the three ratios.

$$\begin{array}{ccc}
 \text{SOH} & \text{CAH} & \text{TOA} \\
 \swarrow & | & \searrow \\
 \sin \theta = \frac{\text{Opposite}}{\text{Hypotenuse}} & \cos \theta = \frac{\text{Adjacent}}{\text{Hypotenuse}} & \tan \theta = \frac{\text{Opposite}}{\text{Adjacent}}
 \end{array}$$

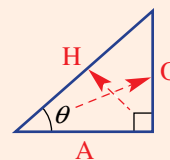

BUILDING UNDERSTANDING

1 State the missing word in these sentences.

- a H stands for the word _____.
- b O stands for the word _____.
- c A stands for the word _____.
- d $\sin \theta = \frac{\text{_____}}{\text{hypotenuse}}$.
- e $\cos \theta = \text{adjacent} \div \text{_____}$.
- f $\tan \theta = \text{opposite} \div \text{_____}$.

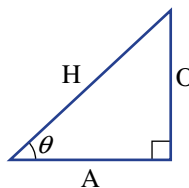

2 Decide which side of each triangle should be labelled as opposite to θ (O), adjacent to θ (A) or hypotenuse (H).

a

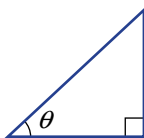

b

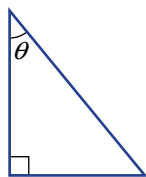

c

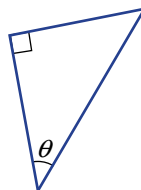

d



3 For the triangle shown, state the length of the side which corresponds to:

- a the hypotenuse
- b the side opposite angle θ
- c the side opposite angle α
- d the side adjacent to angle θ
- e the side adjacent to angle α

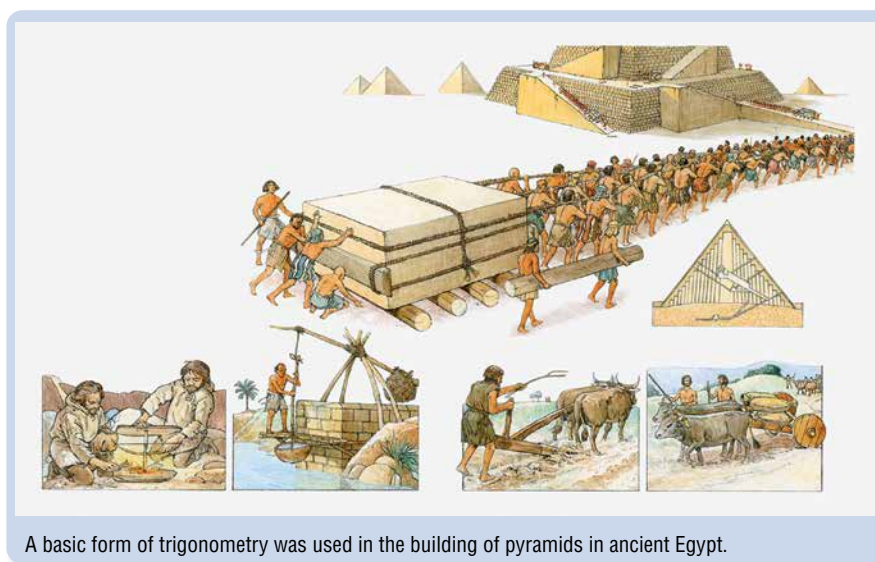
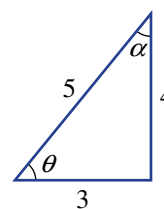

A basic form of trigonometry was used in the building of pyramids in ancient Egypt.



Example 6 Writing trigonometric ratios

Using the given sides, write a trigonometric ratio (in fraction form) for each of the following triangles.

a

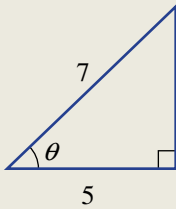

b

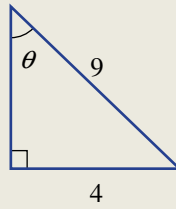

c

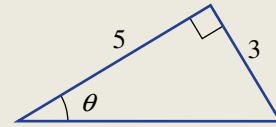

SOLUTION

$$\begin{aligned} \text{a } \cos \theta &= \frac{A}{H} \\ &= \frac{5}{7} \end{aligned}$$

EXPLANATION

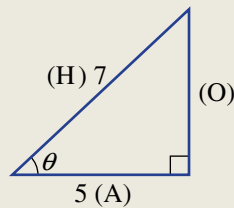

Side length 7 is opposite the right angle so it is the hypotenuse (H). Side length 5 is adjacent to angle θ so it is the adjacent (A).

$$\begin{aligned} \text{b } \sin \theta &= \frac{O}{H} \\ &= \frac{4}{9} \end{aligned}$$

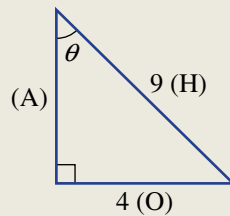

Side length 9 is opposite the right angle so it is the hypotenuse (H). Side length 4 is opposite angle θ so it is the opposite (O).

$$\begin{aligned} \text{c } \tan \theta &= \frac{O}{A} \\ &= \frac{3}{5} \end{aligned}$$

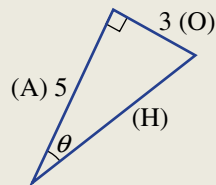

Side length 5 is the adjacent side to angle θ so it is the adjacent (A). Side length 3 is opposite angle θ so it is the opposite (O).

Now you try

Using the given sides, write a trigonometric ratio (in fraction form) for each of the following triangles.

a

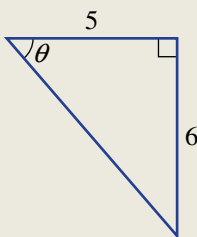

b

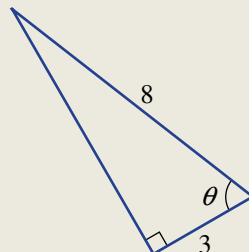

c

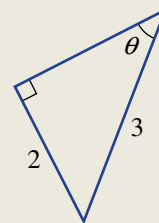

Exercise 3E

FLUENCY

1(1/2), 2, 3

1(1/2), 2-4

1(1/3), 2-4

- Example 6** 1 Using the given sides, write a trigonometric ratio (in fraction form) for each of the following triangles and simplify where possible.

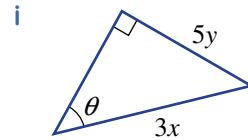
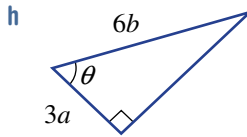
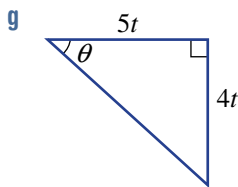
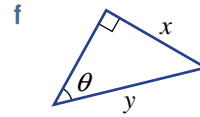
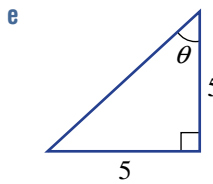
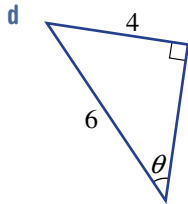
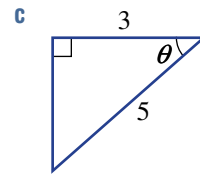
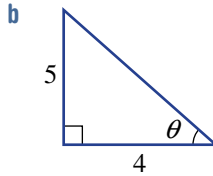
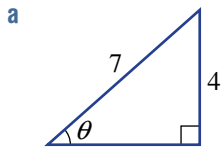

- 2 Here are two similar triangles A and B.

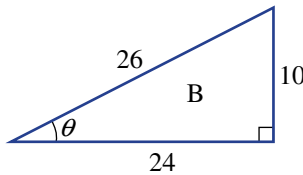
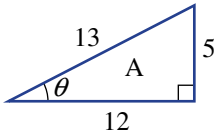

- a**
- Write the ratio $\sin \theta$ (as a fraction) for triangle A.
 - Write the ratio $\sin \theta$ (as a fraction) for triangle B.
 - What do you notice about your two answers from parts **a i** and **ii** above?
- b**
- Write the ratio $\cos \theta$ (as a fraction) for triangle A.
 - Write the ratio $\cos \theta$ (as a fraction) for triangle B.
 - What do you notice about your two answers from parts **b i** and **ii** above?
- c**
- Write the ratio $\tan \theta$ (as a fraction) for triangle A.
 - Write the ratio $\tan \theta$ (as a fraction) for triangle B.
 - What do you notice about your two answers from parts **c i** and **ii** above?
- 3 For each of these triangles, write a ratio (in simplified fraction form) for $\sin \theta$, $\cos \theta$ and $\tan \theta$.

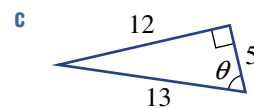
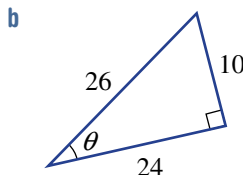
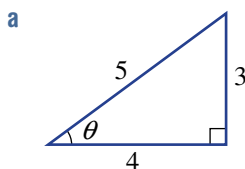

4 For the triangle shown on the right, write a ratio (in fraction form) for:

a $\sin \theta$

b $\sin \alpha$

c $\cos \theta$

d $\tan \theta$

e $\cos \alpha$

f $\tan \theta$

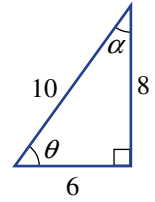

PROBLEM-SOLVING

5, 6

6, 7

7, 8

5 A vertical flag pole casts a shadow 20 m long. If the pole is 15 m high, find the ratio for $\tan \theta$.

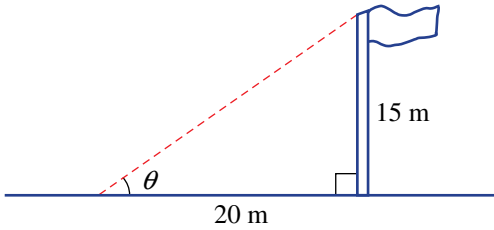

6 The facade of a Roman temple has the given measurements in feet (f) below. Write down the ratio for:

a $\sin \theta$

b $\cos \theta$

c $\tan \theta$

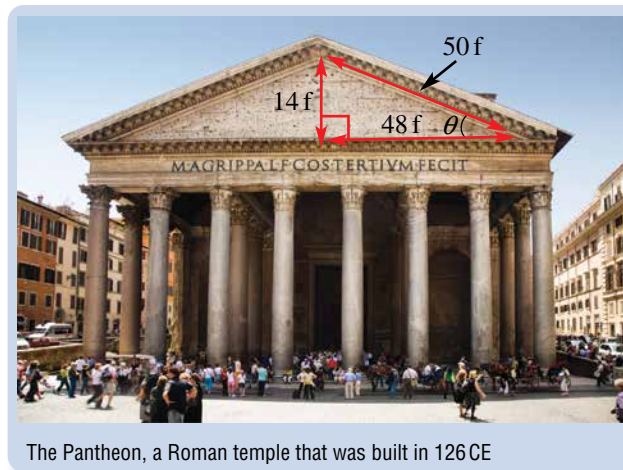

7 For each of the following:

i use Pythagoras' theorem to find the unknown side

ii find the ratios for $\sin \theta$, $\cos \theta$ and $\tan \theta$.

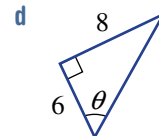
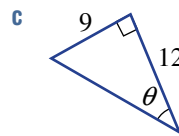
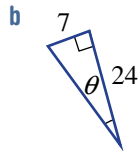
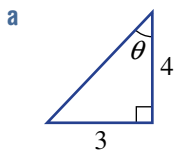

8 a Draw a right-angled triangle and mark one of the angles as θ . Mark in the length of the opposite side as 15 units and the length of the hypotenuse as 17 units.

b Using Pythagoras' theorem, find the length of the adjacent side.

c Determine the ratios for $\sin \theta$, $\cos \theta$ and $\tan \theta$.

REASONING

9

9, 10

9–11

9 This triangle has angles 90° , 60° and 30° and side lengths 1, 2 and $\sqrt{3}$.

a Write a ratio for:

i $\sin 30^\circ$

ii $\cos 30^\circ$

iii $\tan 30^\circ$

iv $\sin 60^\circ$

v $\cos 60^\circ$

vi $\tan 60^\circ$

b What do you notice about the following pairs of ratios?

i $\cos 30^\circ$ and $\sin 60^\circ$

ii $\sin 30^\circ$ and $\cos 60^\circ$

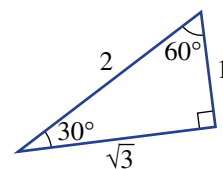

10 a Measure all the side lengths of this triangle to the nearest millimetre.

b Use your measurements from part a to find an approximate ratio for:

i $\cos 40^\circ$

ii $\sin 40^\circ$

iii $\tan 40^\circ$

iv $\sin 50^\circ$

v $\tan 50^\circ$

vi $\cos 50^\circ$

c Do you notice anything about the trigonometric ratios for 40° and 50° ?

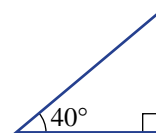

11 Decide if it is possible to draw a right-angled triangle with the given properties. Explain.

a $\tan \theta = 1$

b $\sin \theta = 1$

c $\cos \theta = 0$

d $\sin \theta > 1$ or $\cos \theta > 1$

ENRICHMENT: Pythagorean extensions

-

-

12

12 a Given that θ is acute and $\cos \theta = \frac{4}{5}$, find $\sin \theta$ and $\tan \theta$. (*Hint*: Use Pythagoras' theorem.)

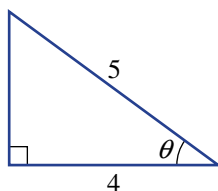

b For each of the following, draw a right-angled triangle then use it to find the other two trigonometric ratios.

i $\sin \theta = \frac{1}{2}$

ii $\cos \theta = \frac{1}{2}$

iii $\tan \theta = 1$

c Use your results from part a to calculate $(\cos \theta)^2 + (\sin \theta)^2$. What do you notice?

d Evaluate $(\cos \theta)^2 + (\sin \theta)^2$ for other combinations of $\cos \theta$ and $\sin \theta$. Research and describe what you have found.

3F Finding unknown side lengths

LEARNING INTENTIONS

- To know how to evaluate a trigonometric value on a calculator
- To be able to set up and solve a trigonometric equation to find an unknown side length in the numerator

For similar triangles we know that the ratio of corresponding sides is always the same. This implies that the three trigonometric ratios for similar right-angled triangles are also constant if the internal angles are equal. Since ancient times, mathematicians have attempted to tabulate these ratios for varying angles. Here are the ratios for some angles in a right-angled triangle, correct to up to three decimal places.

Angle (θ)	$\sin \theta$	$\cos \theta$	$\tan \theta$
0°	0	1	0
15°	0.259	0.966	0.268
30°	0.5	0.866	0.577
45°	0.707	0.707	1
60°	0.866	0.5	1.732
75°	0.966	0.259	3.732
90°	1	0	undefined

In modern times these values can be evaluated using calculators to a high degree of accuracy and can be used to help solve problems involving triangles with unknown side lengths.



A Segway's gyroscopes and tilt-sensors detect the angle and direction that a rider leans and then the wheels roll to maintain balance. Its microprocessors apply complex motion-control algorithms, including trigonometry calculations using the angle of tilt.

Lesson starter: Calculator start-up



All scientific or CAS calculators can produce accurate values of $\sin \theta$, $\cos \theta$ and $\tan \theta$.

- Ensure that your calculator is in degree mode.
- Check the values in the above table to ensure that you are using the calculator correctly.
- Use trial and error to find (to the nearest degree) an angle θ which satisfies these conditions:
 - $\sin \theta = 0.454$
 - $\cos \theta = 0.588$
 - $\tan \theta = 9.514$

KEY IDEAS

- If θ is in degrees, the ratios for $\sin \theta$, $\cos \theta$ and $\tan \theta$ can be found accurately using a calculator in **degree mode**.
- If the angles and one side length of a right-angled triangle are known, then the other side lengths can be found using the $\sin \theta$, $\cos \theta$ and $\tan \theta$ ratios.

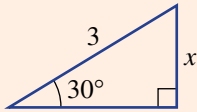

$$\sin 30^\circ = \frac{x}{3}$$

$$\therefore x = 3 \times \sin 30^\circ$$

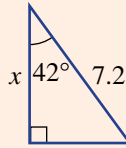

$$\cos 42^\circ = \frac{x}{7.2}$$

$$\therefore x = 7.2 \times \cos 42^\circ$$

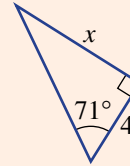

$$\tan 71^\circ = \frac{x}{4}$$

$$\therefore x = 4 \times \tan 71^\circ$$

BUILDING UNDERSTANDING

- 1 For the marked angle θ , decide if x represents the length of the opposite (O), adjacent (A) or hypotenuse (H) side.

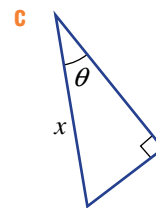
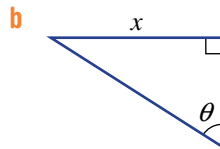
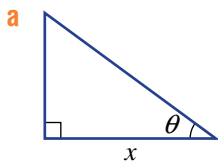

- 2 Decide if you would use $\sin \theta = \frac{O}{H}$, $\cos \theta = \frac{A}{H}$ or $\tan \theta = \frac{O}{A}$ to help find the value of x in these triangles. Do not find the value of x , just state which ratio would be used.

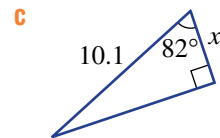
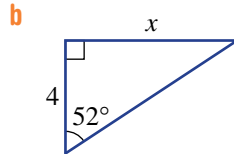
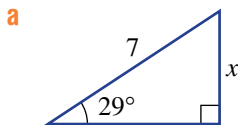

**Example 7 Using a calculator**

Use a calculator to evaluate the following, correct to two decimal places.

a $\sin 50^\circ$

b $\cos 16^\circ$

c $\tan 15.6^\circ$

SOLUTION

a $\sin 50^\circ = 0.77$ (to 2 d.p.)

b $\cos 16^\circ = 0.96$ (to 2 d.p.)

c $\tan 15.6^\circ = 0.28$ (to 2 d.p.)

EXPLANATION

$\sin 50^\circ = 0.766044\dots$ the 3rd decimal place is greater than 4 so round up.

$\cos 16^\circ = 0.961261\dots$ the 3rd decimal place is less than 5 so round down.

$\tan 15.6^\circ = 0.2792\dots$ the 3rd decimal place is greater than 4 so round up.

Now you try

Use a calculator to evaluate the following, correct to two decimal places.

a $\sin 70^\circ$

b $\cos 29^\circ$

c $\tan 54.3^\circ$

**Example 8 Solving for x in the numerator of a trigonometric ratio**

Find the value of x in the equation $\cos 20^\circ = \frac{x}{3}$, correct to two decimal places.

SOLUTION

$$\cos 20^\circ = \frac{x}{3}$$

$$\begin{aligned} x &= 3 \times \cos 20^\circ \\ &= 2.82 \text{ (to 2 d.p.)} \end{aligned}$$

EXPLANATION

Multiply both sides of the equation by 3 and round as required.

Now you try

Find the value of x in the equation $\sin 40^\circ = \frac{x}{5}$, correct to two decimal places.



Example 9 Finding unknown side lengths

For each triangle, find the value of x correct to two decimal places.

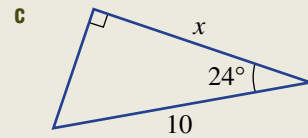
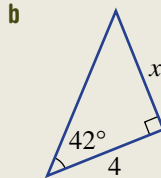
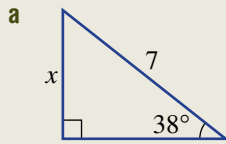

SOLUTION

$$\begin{aligned} \mathbf{a} \quad \sin 38^\circ &= \frac{O}{H} \\ \sin 38^\circ &= \frac{x}{7} \\ x &= 7 \sin 38^\circ \\ &= 4.31 \text{ (to 2 d.p.)} \end{aligned}$$

$$\begin{aligned} \mathbf{b} \quad \tan 42^\circ &= \frac{O}{A} \\ \tan 42^\circ &= \frac{x}{4} \\ x &= 4 \tan 42^\circ \\ &= 3.60 \text{ (to 2 d.p.)} \end{aligned}$$

$$\begin{aligned} \mathbf{c} \quad \cos 24^\circ &= \frac{A}{H} \\ \cos 24^\circ &= \frac{x}{10} \\ x &= 10 \cos 24^\circ \\ &= 9.14 \text{ (to 2 d.p.)} \end{aligned}$$

EXPLANATION

As the opposite side (O) and the hypotenuse (H) are involved, the $\sin \theta$ ratio must be used.

Multiply both sides by 7 and evaluate using a calculator.

As the opposite side (O) and the adjacent side (A) are involved, the $\tan \theta$ ratio must be used.

Multiply both sides by 4 and evaluate.

As the adjacent side (A) and the hypotenuse (H) are involved, the $\cos \theta$ ratio must be used.

Multiply both sides by 10.

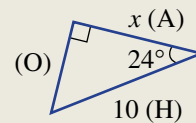
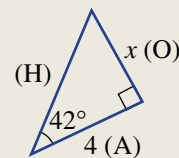
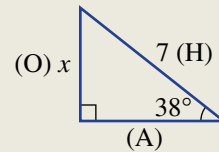

Now you try

For each triangle, find the value of x correct to two decimal places.

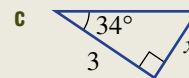
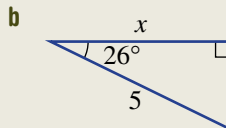
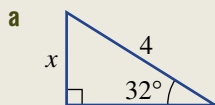

Exercise 3F

FLUENCY

1, 2–3(½)

1, 2(⅓), 3(½)

2–3(⅓)

- Example 7** 1 Use a calculator to evaluate the following, correct to two decimal places.
- a** $\sin 47^\circ$ **b** $\cos 84^\circ$ **c** $\tan 14.1^\circ$ **d** $\sin 27.4^\circ$

- Example 8** 2 For each of the following, find the value of x correct to two decimal places.

a $\sin 50^\circ = \frac{x}{4}$ **b** $\tan 81^\circ = \frac{x}{3}$ **c** $\cos 33^\circ = \frac{x}{6}$
d $\cos 75^\circ = \frac{x}{3.5}$ **e** $\sin 24^\circ = \frac{x}{4.2}$ **f** $\tan 42^\circ = \frac{x}{10}$
g $\frac{x}{7.1} = \tan 18.4^\circ$ **h** $\frac{x}{5.3} = \sin 64.7^\circ$ **i** $\frac{x}{12.6} = \cos 52.9^\circ$

- Example 9** 3 For the triangles given below, find the value of x correct to two decimal places.

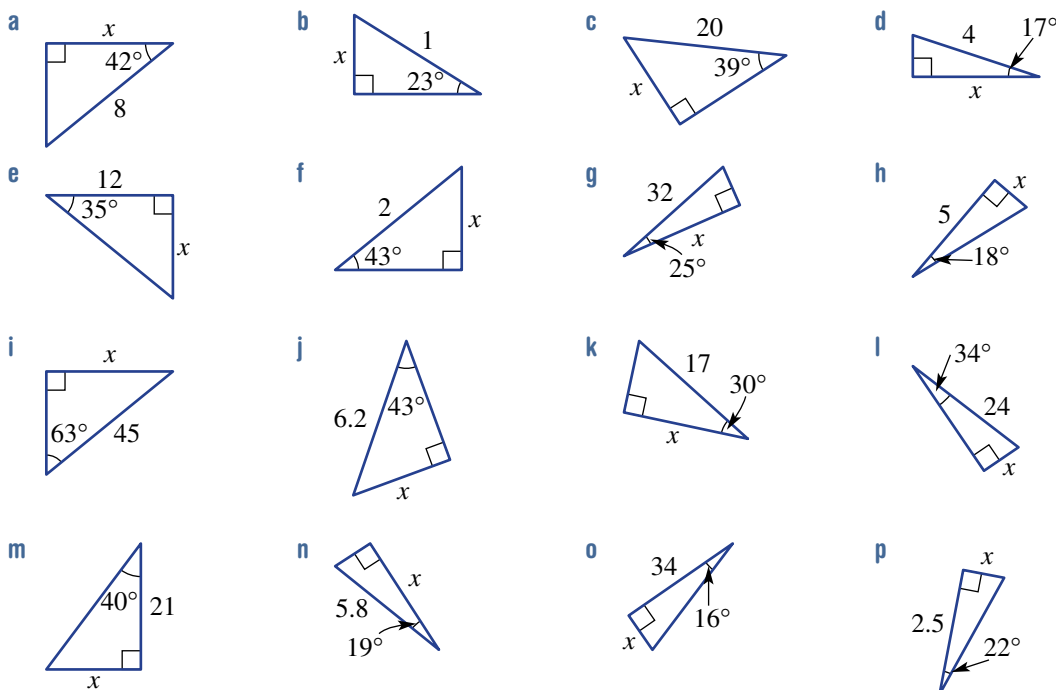

PROBLEM-SOLVING

4, 5

4–6

5–7

- 4** Amy walks 5.4 m up a ramp that is inclined at 12° to the horizontal. How high (correct to two decimal places) is she above her starting point?

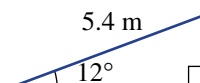

- 5** Kane wanted to measure the width of a river. He placed two markers, A and B , 72 m apart along the bank. C is a point directly opposite marker B . Kane measured angle CAB to be 32° . Find the width of the river correct to two decimal places.

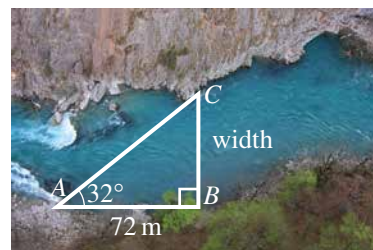

- 6 One end of a 12.2 m rope is tied to a boat. The other end is tied to an anchor, which is holding the boat steady in the water. If the anchor is making an angle of 34° with the vertical, how deep is the water? Give your answer correct to two decimal places.

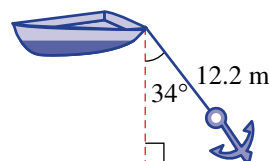

- 7 Find the length AB in these diagrams. Round to two decimal places where necessary.

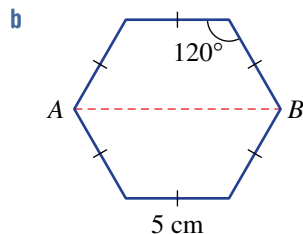
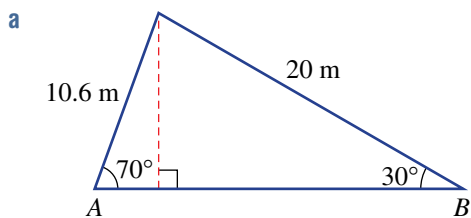

REASONING

8

8, 9

8, 9

- 8 Consider the right-angled triangle shown.

- Find the size of $\angle C$.
- Calculate the value of x correct to three decimal places using the sine ratio.
- Calculate the value of x correct to three decimal places using the cosine ratio.
- Comment on your answers to parts **b** and **c**.

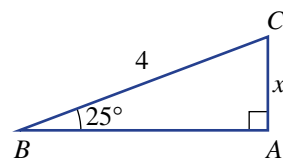

- 9 Complementary angles sum to 90° .

- a Find the complementary angles to these angles.

i 10°

ii 28°

iii 54°

iv 81°

- b Evaluate:

i $\sin 10^\circ$ and $\cos 80^\circ$

ii $\sin 28^\circ$ and $\cos 62^\circ$

iii $\cos 54^\circ$ and $\sin 36^\circ$

iv $\cos 81^\circ$ and $\sin 9^\circ$

- c What do you notice in part **b**?

- d Complete the following.

i $\sin 20^\circ = \cos \underline{\hspace{2cm}}$

ii $\sin 59^\circ = \cos \underline{\hspace{2cm}}$

iii $\cos 36^\circ = \sin \underline{\hspace{2cm}}$

iv $\cos 73^\circ = \sin \underline{\hspace{2cm}}$

ENRICHMENT: Exact values

–

–

10

- 10 $\sqrt{2}$, $\sqrt{3}$ and $\frac{1}{\sqrt{2}}$ are examples of exact values.

- For the triangle shown (right), use Pythagoras' theorem to find the exact length BC .
- Use your result from part **a** to write down the exact value of:
 - $\sin 45^\circ$
 - $\cos 45^\circ$
 - $\tan 45^\circ$
- For the second triangle (below right), use Pythagoras' theorem to find the exact length BC .
- Use your result from part **c** to write down the exact value of:
 - $\sin 30^\circ$
 - $\cos 30^\circ$
 - $\tan 30^\circ$
 - $\sin 60^\circ$
 - $\cos 60^\circ$
 - $\tan 60^\circ$

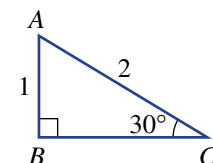
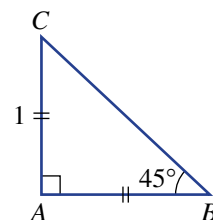

3A/B



1 Find the length of the missing side in these right-angled triangles. Round to two decimal places.

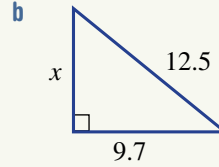
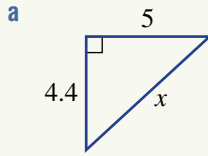

3A/B

2 Find the exact value of x in these right-angled triangles.

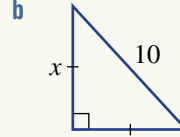
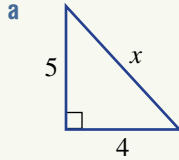

3C



3 A ladder 230 cm long is placed 50 cm from the edge of a building, how far up the side of the building will this ladder reach? Round to one decimal place.

3D



Ext

4 Find the length of the diagonals of these prisms, correct to one decimal place.

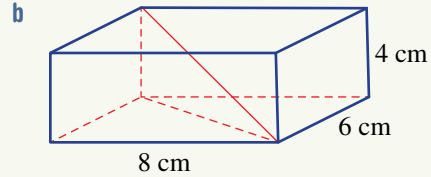
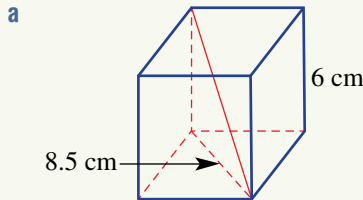

3E

5 Consider the triangle ABC .

- a Name the hypotenuse.
- b Name the side adjacent to angle ACB .
- c Write the ratio for $\cos \theta$.
- d Write the ratio for $\tan \theta$.

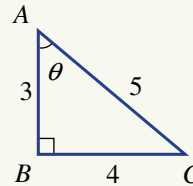

3F



6 Solve for x , correct to two decimal places.

a $x = 12.7 \cos 54^\circ$

b $\tan 30^\circ = \frac{x}{12}$

3F



7 Find the value of x , correct to two decimal places.

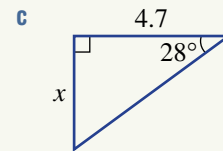
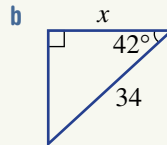
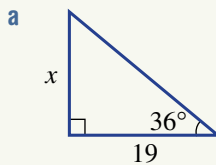

3A-F



8 Triangle ABC is equilateral with a perimeter of 12 cm.

- a Find the height AD using any suitable method, correct to three decimal places.
- b Calculate the area of the triangle ABC , correct to one decimal place.

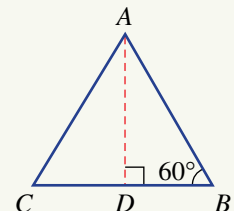

3G Solving for the denominator

LEARNING INTENTIONS

- To know how to rearrange an equation to make a pronumeral in the denominator of a fraction the subject
- To be able to solve a trigonometric equation with an unknown side length in the denominator

So far we have constructed trigonometric ratios using a pronumeral that has always appeared in the numerator.

$$\text{For example: } \frac{x}{5} = \sin 40^\circ$$

This makes it easy to solve for x as both sides of the equation can be multiplied by 5.

If, however, the pronumeral appears in the denominator, there are a number of algebraic steps that can be taken to find the solution.



Trigonometry is an essential tool for builders and carpenters. Given the roof pitch (i.e. angle) and its horizontal span, the lengths of the rafters and trusses are calculated using trigonometry.

Lesson starter: Solution steps

Three students attempt to solve $\sin 40^\circ = \frac{5}{x}$ for x .

Nick says $x = 5 \times \sin 40^\circ$.

Sharee says $x = \frac{5}{\sin 40^\circ}$.

Dori says $x = \frac{1}{5} \times \sin 40^\circ$.

- Which student has the correct solution?
- Can you show the algebraic steps that support the correct answer?

KEY IDEAS

- If the unknown value of a trigonometric ratio is in the **denominator**, you need to rearrange the equation to make the pronumeral the subject.

For example: For the triangle shown,

$$\cos 30^\circ = \frac{5}{x}$$

Multiply both sides by x .

$$x \times \cos 30^\circ = 5$$

Divide both sides by $\cos 30^\circ$.

$$x = \frac{5}{\cos 30^\circ}$$

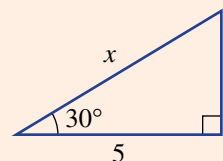

BUILDING UNDERSTANDING

1 Solve these simple equations for x .

a $\frac{4}{x} = 2$

b $\frac{20}{x} = 4$

c $5 = \frac{35}{x}$

d $\frac{10}{x} = 2.5$

2 Decide whether the pronumeral x will sit in the numerator (N) or denominator (D) for the trigonometric ratios for these diagrams.

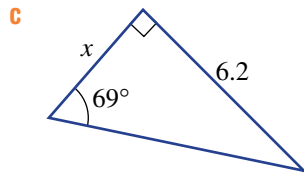
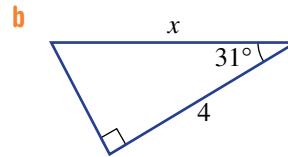
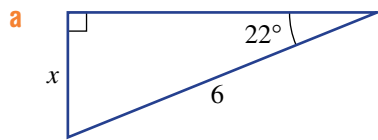

 Example 10 Solving for a pronumeral in the denominator

Solve for x in the equation $\cos 35^\circ = \frac{2}{x}$, correct to two decimal places.

SOLUTION

$$\begin{aligned}\cos 35^\circ &= \frac{2}{x} \\ x \cos 35^\circ &= 2 \\ x &= \frac{2}{\cos 35^\circ} \\ &= 2.44 \text{ (to 2 d.p.)}\end{aligned}$$

EXPLANATION

Multiply both sides of the equation by x .
Divide both sides of the equation by $\cos 35^\circ$.
Evaluate and round to two decimal places.

Now you try

Solve for x in the equation $\sin 62^\circ = \frac{3}{x}$, correct to two decimal places.

Example 11 Finding unknown side lengths using trigonometry

Find the values of the pronumerals, correct to two decimal places.

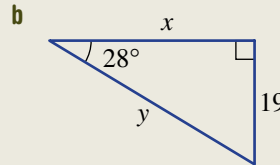
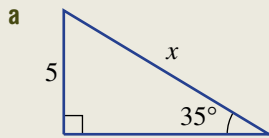

SOLUTION

a

$$\sin 35^\circ = \frac{O}{H}$$

$$\sin 35^\circ = \frac{5}{x}$$

$$x \sin 35^\circ = 5$$

$$x = \frac{5}{\sin 35^\circ}$$

$$= 8.72 \text{ (to 2 d.p.)}$$

b

$$\tan 28^\circ = \frac{O}{A}$$

$$\tan 28^\circ = \frac{19}{x}$$

$$x \tan 28^\circ = 19$$

$$x = \frac{19}{\tan 28^\circ}$$

$$= 35.73 \text{ (to 2 d.p.)}$$

$$\sin 28^\circ = \frac{19}{y}$$

$$y \sin 28^\circ = 19$$

$$y = \frac{19}{\sin 28^\circ}$$

$$= 40.47 \text{ (to 2 d.p.)}$$

EXPLANATION

As the opposite side (O) is given and we require the hypotenuse (H), use $\sin \theta$.

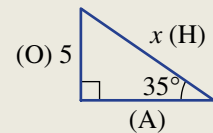

Multiply both sides of the equation by x then divide both sides of the equation by $\sin 35^\circ$.

Evaluate on a calculator and round to two decimal places.

As the opposite side (O) is given and the adjacent (A) is required, use $\tan \theta$.

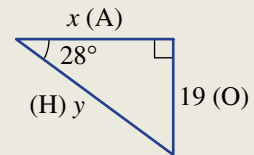

Multiply both sides of the equation by x .

Divide both sides of the equation by $\tan 28^\circ$ and round the answer to two decimal places.

y can be found by using $\sin \theta$.

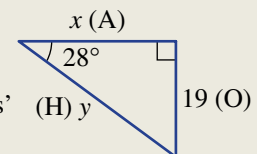

Alternatively, Pythagoras' theorem could be used: $x^2 + 19^2 = y^2$, where $x = \frac{19}{\tan 28^\circ}$

Now you try

Find the values of the pronumerals, correct to two decimal places.

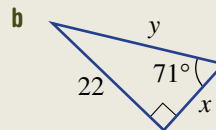
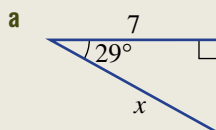

Exercise 3G

FLUENCY

1–3(1/2)

1(1/3), 2–3(1/2)

1–3(1/3)

Example 10

1 For each of the following equations, find the value of x correct to two decimal places.

a $\tan 64^\circ = \frac{2}{x}$

b $\cos 67^\circ = \frac{5}{x}$

c $\sin 12^\circ = \frac{3}{x}$

d $\sin 38.3^\circ = \frac{5.9}{x}$

e $\frac{45}{x} = \tan 21.4^\circ$

f $\frac{18.7}{x} = \cos 32^\circ$

Example 11a

2 Find the value of x correct to two decimal places using the sine, cosine or tangent ratios.

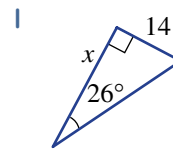
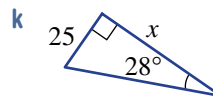
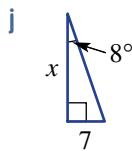
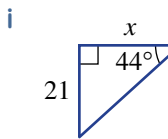
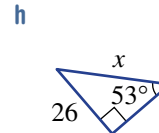
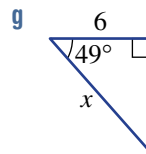
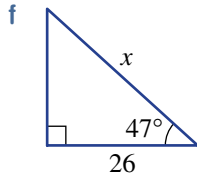
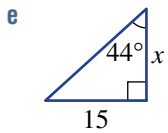
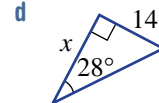
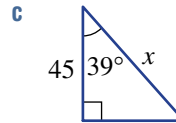
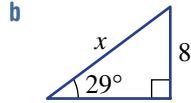
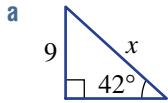

Example 11b

3 Find the value of each pronumeral correct to one decimal place.

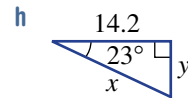
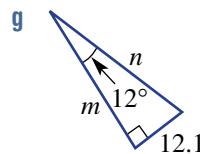
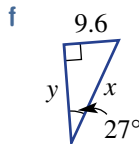
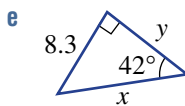
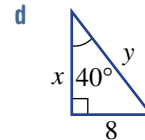
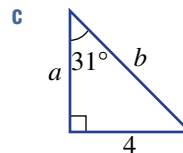
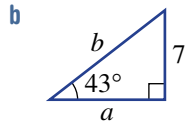
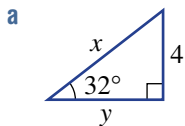

PROBLEM-SOLVING

4, 5

4–6

5, 6



4 A kite is flying at a height of 27 m above the anchor point. If the string is inclined at an angle of 42° to the horizontal, find the length of the string, correct to the nearest metre.

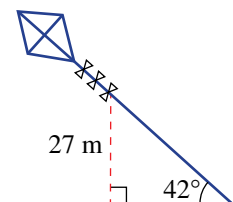

- 5 A paraglider flying at a height of 800 m descends at an angle of 12° to the horizontal. How far (to the nearest metre) does it travel as it descends to the ground?

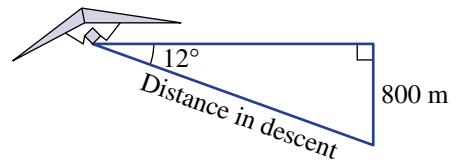

- 6 Find the perimeter of these triangles, correct to one decimal place.

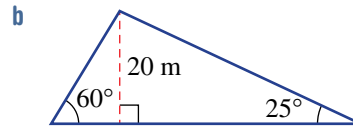
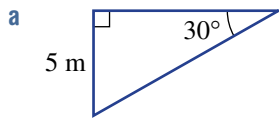

REASONING

7

7

7

- 7 In calculating the value of x for this triangle, two students come up with these answers, correct to two decimal places.

A $x = \frac{5}{\sin 31^\circ} = \frac{5}{0.52} = 9.62$

B $x = \frac{5}{\sin 31^\circ} = 9.71$

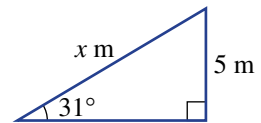

- a Which of the two answers is more accurate and why?
 b What advice would you give to the student whose answer is not accurate?
 c Find the difference in the answers for these triangles when methods **A** and **B** are used to calculate the value of x correct to two decimal places.

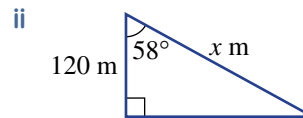
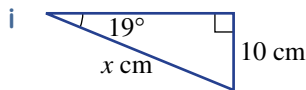

ENRICHMENT: Linking $\tan \theta$ to $\sin \theta$ and $\cos \theta$

-

-

8

- 8 a For this triangle, find the length of these sides correct to three decimal places.

i AB

ii BC

- b Calculate these ratios to two decimal places.

i $\sin 20^\circ$

ii $\cos 20^\circ$

iii $\tan 20^\circ$

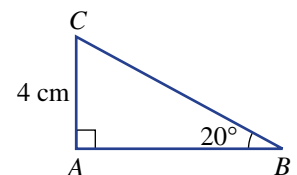

- c Evaluate $\frac{\sin 20^\circ}{\cos 20^\circ}$ using your results from part **b**. What do you notice?

- d For this triangle with side lengths a , b and c , find an expression for:

i $\sin \theta$

ii $\cos \theta$

iii $\tan \theta$

iv $\frac{\sin \theta}{\cos \theta}$

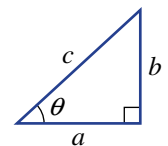

- e Simplify your expression for part **d iv**. What do you notice?

Using a CAS calculator 3G: Trigonometry

This activity is in the Interactive Textbook in the form of a printable PDF.

3H Finding unknown angles

LEARNING INTENTIONS

- To understand that the inverse trigonometric ratios are used to find angles in right-angled triangles
- To know that two side lengths are required to find angles in right-angled triangles
- To know how to use a calculator to find a value using an inverse trigonometric ratio
- To be able to find the value of an angle in a right-angled triangle given two side lengths

Logically, if you can use trigonometry to find a side length of a right-angled triangle given one angle and one side, you should be able to find an angle if you are given two sides.

We know that $\sin 30^\circ = \frac{1}{2}$, so if we were to determine θ when $\sin \theta = \frac{1}{2}$, the answer would be $\theta = 30^\circ$.

We write this as $\theta = \sin^{-1}\left(\frac{1}{2}\right) = 30^\circ$ and we say that the inverse sine of $\frac{1}{2}$ is 30° .

Calculators can be used to help solve problems using inverse sine (\sin^{-1}), inverse cosine (\cos^{-1}) and inverse tangent (\tan^{-1}). For angles in degrees, ensure your calculator is in degree mode.

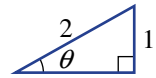

Lesson starter: Trial and error can be slow

We know that for this triangle, $\sin \theta = \frac{1}{3}$.

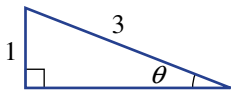

- Guess the angle θ .
- For your guess use a calculator in degree mode to see if $\sin \theta = \frac{1}{3} = 0.333\dots$
- Update your guess and use your calculator to check once again.
- Repeat this trial-and-error process until you think you have the angle θ correct to three decimal places.
- Now evaluate $\sin^{-1}\left(\frac{1}{3}\right)$ using the $\boxed{\sin^{-1}}$ button on your calculator and check your guess.



The International Space Station has a 16.94 m robotic arm with four segments that's used on spacewalks, and capturing and releasing visiting spacecraft. Trigonometry is used to calculate the required angle between segments for grabbing specific spacecraft.

KEY IDEAS

■ **Inverse sine** (\sin^{-1}), **inverse cosine** (\cos^{-1}) and **inverse tangent** (\tan^{-1}) can be used to find angles in right-angled triangles.

- $\sin \theta = \frac{a}{c}$ means $\theta = \sin^{-1}\left(\frac{a}{c}\right)$
- $\cos \theta = \frac{b}{c}$ means $\theta = \cos^{-1}\left(\frac{b}{c}\right)$
- $\tan \theta = \frac{a}{b}$ means $\theta = \tan^{-1}\left(\frac{a}{b}\right)$

■ Note that $\sin^{-1} x$ does *not* mean $\frac{1}{\sin x}$.

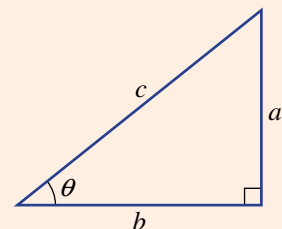

BUILDING UNDERSTANDING



1 Use a calculator to evaluate the following, rounding the answer to two decimal places.

a $\sin^{-1}(0.2)$

b $\cos^{-1}(0.75)$

c $\tan^{-1}(0.5)$

2 State the missing number.

a If $\sin 30^\circ = \frac{1}{2}$ then $30^\circ = \sin^{-1}(\text{_____})$.

b If $\cos 50^\circ = 0.64$ then $\text{_____} = \cos^{-1}(0.64)$.

c If $\tan 45^\circ = 1$ then $\text{_____} = \tan^{-1}(\text{_____})$.

3 Which trigonometric ratio should be used to solve for θ ?

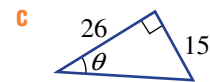
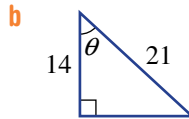
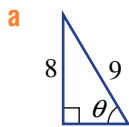

Example 12 Using inverse trigonometric ratios

Find the value of θ to the level of accuracy indicated.

a $\sin \theta = 0.3907$ (nearest degree)

b $\tan \theta = \frac{1}{2}$ (one decimal place)

SOLUTION

a $\sin \theta = 0.3907$

$$\begin{aligned}\theta &= \sin^{-1}(0.3907) \\ &= 23^\circ \text{ (to nearest degree)}\end{aligned}$$

b $\tan \theta = \frac{1}{2}$

$$\begin{aligned}\theta &= \tan^{-1}\left(\frac{1}{2}\right) \\ &= 26.6^\circ \text{ (to 1 d.p.)}\end{aligned}$$

EXPLANATION

Use the \sin^{-1} key on your calculator.
Round to the nearest whole number.

Use the \tan^{-1} key on your calculator and round
the answer to one decimal place.

Now you try

Find the value of θ to the level of accuracy indicated.

a $\cos \theta = 0.416$ (nearest degree)

b $\tan \theta = \frac{5}{3}$ (one decimal place)

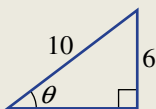
**Example 13** Finding an unknown angleFind the value of θ to the nearest degree.**SOLUTION**

$$\begin{aligned}\sin \theta &= \frac{O}{H} \\ &= \frac{6}{10}\end{aligned}$$

$$\begin{aligned}\theta &= \sin^{-1}\left(\frac{6}{10}\right) \\ &= 37^\circ \text{ (to the nearest degree)}\end{aligned}$$

EXPLANATION

As the opposite side (O) and the hypotenuse (H) are given, use $\sin \theta$.

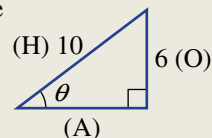

Use the \sin^{-1} key on your calculator and round as required.

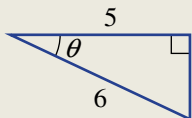
Now you tryFind the value of θ to the nearest degree.**Exercise 3H****FLUENCY**1–3($\frac{1}{2}$)1–2($\frac{1}{3}$), 3($\frac{1}{2}$)1–3($\frac{1}{3}$)

Example 12a

1 Find the value of θ to the nearest degree.

a $\cos \theta = 0.8660$

b $\sin \theta = 0.7071$

c $\tan \theta = 0.5774$

d $\sin \theta = 1$

e $\tan \theta = 1.192$

f $\cos \theta = 0$



Example 12b

2 Find the angle θ correct to two decimal places.

a $\sin \theta = \frac{4}{7}$

b $\sin \theta = \frac{1}{3}$

c $\sin \theta = \frac{9}{10}$

d $\cos \theta = \frac{1}{4}$

e $\cos \theta = \frac{4}{5}$

f $\cos \theta = \frac{7}{9}$

g $\tan \theta = \frac{3}{5}$

h $\tan \theta = \frac{8}{5}$

i $\tan \theta = 12$



Example 13 3 Find the value of θ to the nearest degree.

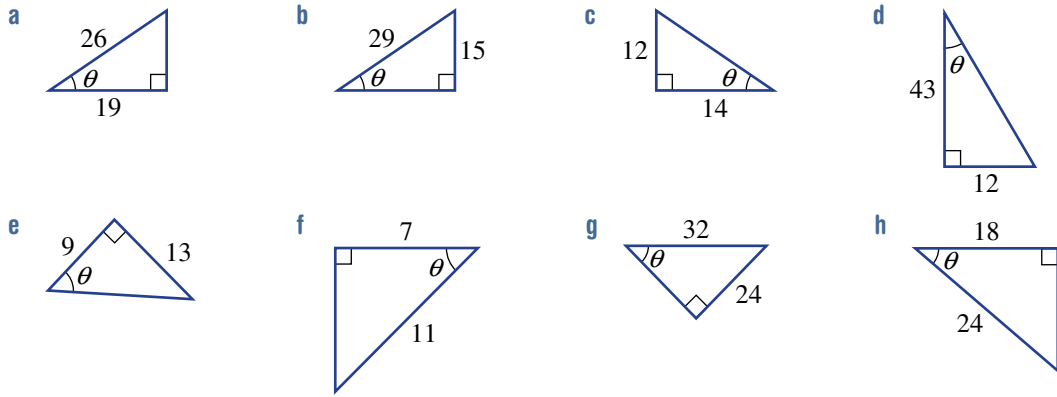

PROBLEM-SOLVING

4–6

5–7

6–8



4 A road rises at a grade of 3 in 10. Find the angle (to the nearest degree) the road makes with the horizontal.

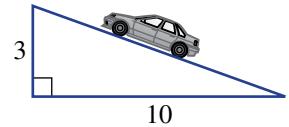

5 Adam, who is 1.8 m tall, holds up a plank of wood that is 4.2 m long. Find the angle that the plank makes with the ground, correct to one decimal place.

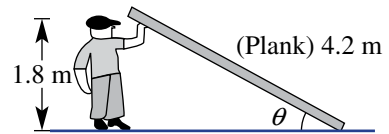

6 A children's slide has a length of 5.8 m. The vertical ladder is 2.6 m high. Find the angle the slide makes with the ground, correct to one decimal place.

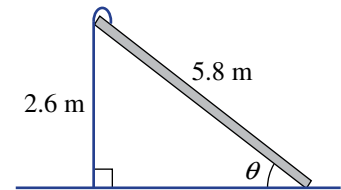

7 When a 2.8 m long seesaw is at its maximum height it is 1.1 m off the ground. What angle (correct to two decimal places) does the seesaw make with the ground?

8 Find the value of θ , correct to one decimal place.

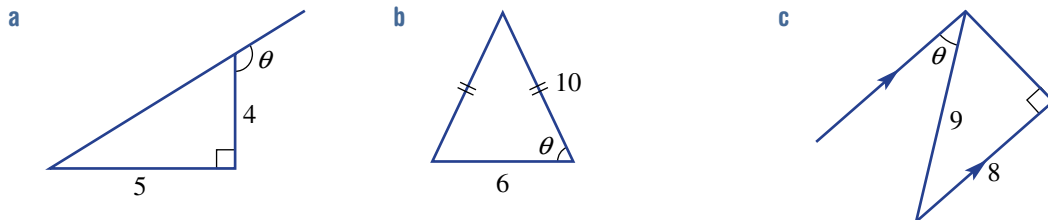

REASONING

9

9, 10

10, 11

- 9 Find all the angles to the nearest degree in right-angled triangles with these side lengths.
- a 3, 4, 5
 - b 5, 12, 13
 - c 7, 24, 25

- 10 For what value of θ is $\sin \theta = \cos \theta$?

- 11 If M is the midpoint of AB , decide whether $\angle ACM$ is exactly half of angle $\angle ACB$. Investigate and explain.

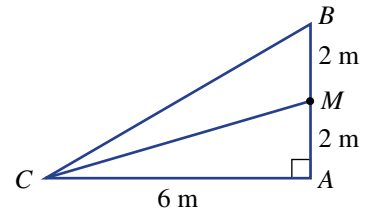

ENRICHMENT: Viewing angle

-

-

12

- 12 Jo has forgotten her glasses and is trying to view a painting in a gallery. Her eye level is at the same level as the base of the painting and the painting is 1 metre tall. Answer the following to the nearest degree for angles and to two decimal places for lengths.

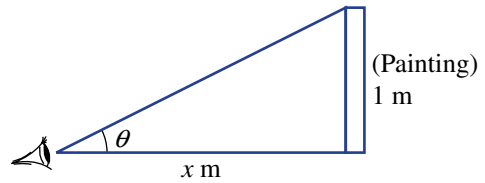

- a If $x = 3$, find the viewing angle θ .
- b If $x = 2$, find the viewing angle θ .
- c If Jo can stand no closer than 1 metre from the painting, what is Jo's largest viewing angle?
- d When the viewing angle is 10° , Jo has trouble seeing the painting. How far is she from the painting at this viewing angle?
- e Theoretically, what would be the largest viewing angle if Jo could go as close as she would like to the painting?



The following problems will investigate practical situations drawing upon knowledge and skills developed throughout the chapter. In attempting to solve these problems, aim to identify the key information, use diagrams, formulate ideas, apply strategies, make calculations and check and communicate your solutions.

Rabbit roof

- 1 Sophie is building a hutch for her pet rabbit and wants to include a sloping roof to keep the rain off. A cross-section of the hutch is shown here.

The minimum height at one side is 60 cm and a 10 cm roof overhang is required at each side. The width of the hutch is 80 cm, but the taller side, x cm, can vary depending on the slope of the roof (θ).

Sophie is investigating the relationship between the height of the hutch (x cm) and the roof span (y cm). The angle or slope of the roof is also of interest as these measurements affect lengths and the costs of materials.

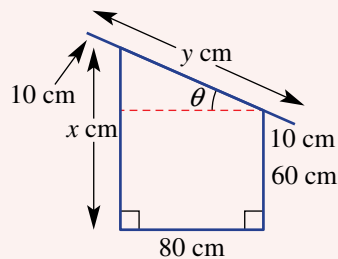

- a** If Sophie chooses the angle for the roof to be 30° , find these lengths correct to one decimal place.
- Wall height, x cm
 - Roof span, y cm
- b** If Sophie chooses the wall height, x cm, to be 90 cm, find these measurements correct to one decimal place.
- Roof span, y cm
 - Roof angle θ
- c** If Sophie chooses the roof span, y cm, to be 120 cm, find these measurements correct to one decimal place where necessary.
- Wall height, x cm
 - Roof angle θ
- d** Write a rule for each of the following:
- y in terms of θ
 - y in terms of x
 - x in terms of θ
 - x in terms of y .
- e** Given the size of the available materials, Sophie will save money if the roof span, y cm, is less than 110 cm, but she feels that the angle θ needs to be larger than 25° for sufficient water run-off. Investigate to see if this is achievable and give reasons.

Solving the pyramid

- 2 Richard is studying ancient pyramids and notices that many of them are in fact right square-based pyramids. Such structures have the following properties:

- The base is a square.
- The apex is directly above the centre of the base.

Richard is interested in the properties of such a solid and how Pythagoras' theorem can be used to find various lengths. Given two lengths, Richard is looking to 'solve the pyramid' by finding the lengths of all the other edges, heights or diagonals.

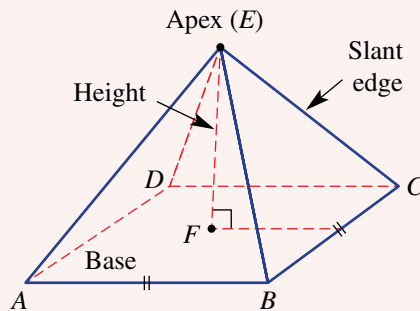

a There are many right-angled triangles that can be drawn inside or on the surface of a right, square-based pyramid. Make three copies of the pyramid and shade in a different right-angled triangle for each one. An example is shown at right.

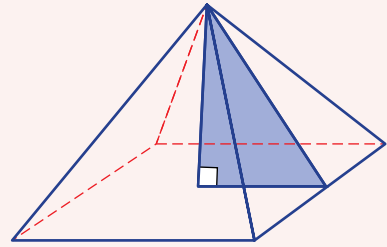

b Richard is interested in finding the length of a slant edge. A square-based pyramid has base length 100 m and height 50 m. Use various right-angled triangles to find the following lengths. Round each answer correct to one decimal place, but try not to accumulate errors by using rounded answers for subsequent calculations. (Use stored answers in a calculator.) Refer to the diagram at the top of the page.

i AC

ii CF

iii CE (slant edge)

c A pyramid has base length 100 m and slant edge 80 m. Calculate the height of the pyramid correct to one decimal place.

d A pyramid has slant edge 80 m and height 50 m.

i First check that you can solve for an unknown in the triangle shown here.

Round to one decimal place.

ii Now find the base length of the pyramid described above. Round to one decimal place.

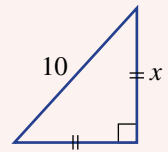

Communications cabling

3 A 300 m high communications tower is to be supported by six cables, including three reaching to the very top and three reaching to a point somewhere up the tower. Each of the three anchor points on the ground is shared by two cables as shown. The anchor points are 200 m from the base of the tower.

The construction designers are interested in the total length of cable required to support the tower, as well as the position of point A for the shorter cable. They are exploring the distance between points A and B and the angles the cables make with the ground.

Round all answers in this word problem to two decimal places where necessary.

a For each long cable that joins to the tower at the very top, find:

i its length

ii its angle of elevation from ground level.

b If point A is positioned halfway up the tower, find:

i the angle of elevation of the shorter cables

ii the total length of cable required for all six cables.

c If 2000 m of cable is used in total for the six cables, find the position at which the shorter cables connect to the tower (point A).

d The designers decide that the distance AB on a second 300 m high tower should be 100 m. They are hoping to use less than 1900 m of cabling. Will this be possible? Give reasons.

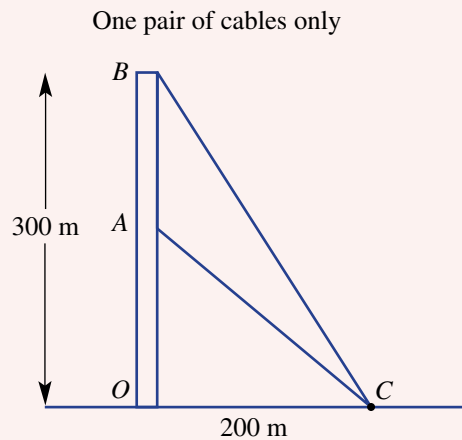

31 Applying trigonometry EXTENDING

LEARNING INTENTIONS

- To know the meaning of angle of elevation and angle of depression
- To be able to draw a diagram from information in a word problem and identify any right-angled triangles in the diagram
- To know how to use alternate angles to mark equal angles in diagrams with parallel lines
- To be able to apply trigonometry to find unknown side lengths and angles

In many situations, angles are measured up or down from the horizontal. These are called angles of elevation and depression. Combined with the mathematics of trigonometry, these angles can be used to solve problems, provided right-angled triangles can be identified. The line of sight to a helicopter 100 m above the ground, for example, creates an angle of elevation inside a right-angled triangle.

Lesson starter: Illustrate the situation

For the situation described below, draw a detailed diagram showing these features:

- an angle of elevation
- an angle of depression
- any given lengths
- a right-angled triangle that will help to solve the problem.

A cat and a bird eye each other from their respective positions. The bird is 20 m up a tree and the cat is on the ground 30 m from the base of the tree. Find the angle their line of sight makes with the horizontal.

Compare your diagram with those of others in your class. Is there more than one triangle that could be drawn and used to solve the problem?



By using trigonometry and higher-level mathematics, it can be shown that the angle of elevation from an observer to a rainbow's highest point, red, is always 42° . In a fainter secondary rainbow, the highest point, violet, always has a 51° angle of elevation.

KEY IDEAS

- To solve application problems involving trigonometry follow these steps.
 - 1 Draw a diagram and label the key information.
 - 2 Identify and draw the appropriate right-angled triangles separately.
 - 3 Solve using trigonometry to find the missing measurements.
 - 4 Express your answer in words.
- The **angle of elevation** or **depression** of a point, Q , from another point, P , is given by the angle the line PQ makes with the horizontal.

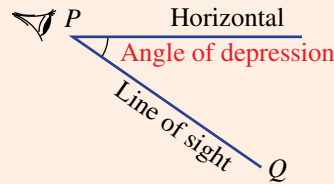
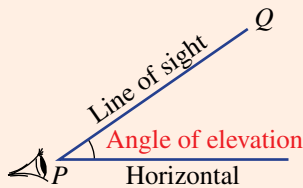

- Angles of elevation or depression are always measured from the horizontal.
- In this diagram the angle of elevation of B from A is equal to the angle of depression of A from B . They are equal alternate angles in parallel lines.

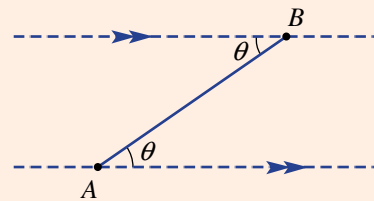

BUILDING UNDERSTANDING

- 1 State the values of the pronumerals in this diagram.

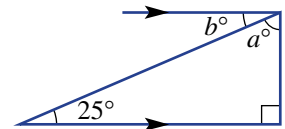

- 2 For this diagram:

- a what is the angle of elevation of B from A ?
- b what is the angle of depression of A from B ?

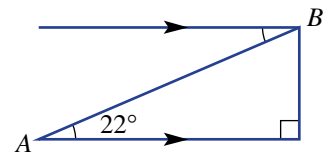

- 3 Complete these tasks for the diagram shown.

- a State where you would mark in the following:
 - i the angle of elevation (θ) of B from A
 - ii the angle of depression (α) of A from B .
- b Is $\theta = \alpha$ in your diagram? Why?

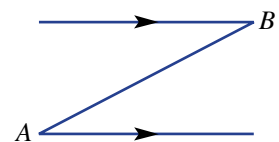



Example 14 Using angles of elevation

The angle of elevation of the top of a tower from a point on the ground 30 m away from the base of the tower is 28° . Find the height of the tower to the nearest metre.

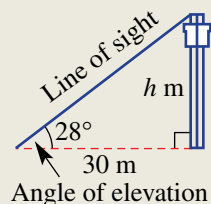

SOLUTION

Let the height of the tower be h m.

$$\begin{aligned}\tan 28^\circ &= \frac{O}{A} \\ &= \frac{h}{30} \\ h &= 30 \tan 28^\circ \\ &= 15.951\dots\end{aligned}$$

The height is 16 m, to the nearest metre.

EXPLANATION

As the opposite side (O) is required and the adjacent (A) is given, use $\tan \theta$.

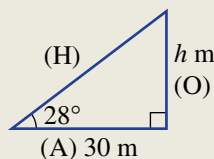

Multiply both sides by 30 and evaluate. Round to the nearest metre and write the answer in words.

Now you try

The angle of elevation to the top of a tree from a point 50 m away from the base of the tree is 32° . Find the height of the tree to the nearest metre.



Example 15 Using angles of depression

The angle of depression from a bird 25 m up a tree to a worm on the ground is 28° . Find the direct distance between the bird and the worm to the nearest metre.

SOLUTION

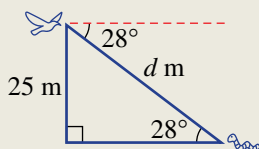

Let d m be the distance between the bird and worm.

$$\begin{aligned}\sin 28^\circ &= \frac{25}{d} \\ d \sin 28^\circ &= 25 \\ d &= \frac{25}{\sin 28^\circ} \\ &= 53.2513\dots\end{aligned}$$

The distance is 53 m to the nearest metre.

EXPLANATION

Draw a diagram, marking in the angle of depression below the horizontal. Use alternate angles to mark the angle inside the triangle.

Use sine given the opposite and hypotenuse are involved.

Multiply both sides by d and divide both sides by $\sin 28^\circ$.

Round to the nearest metre and answer in words.

Now you try

The angle of depression from a tennis umpire in a chair 4 m high to a moth on the court is 22° . Find the direct distance between the umpire and the moth to the nearest metre.

**Example 16 Finding an angle of depression**

From the top of a vertical cliff Andrea spots a boat out at sea. If the top of the cliff is 42 m above sea level and the boat is 90 m away from the base of the cliff, find the angle of depression from Andrea to the boat to the nearest degree.

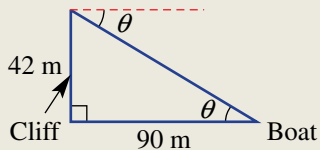
SOLUTION

$$\begin{aligned}\tan \theta &= \frac{O}{A} \\ &= \frac{42}{90}\end{aligned}$$

$$\theta = \tan^{-1}\left(\frac{42}{90}\right)$$

$$\theta = 25.0168\dots^\circ$$

The angle of depression is 25° , to the nearest degree.

EXPLANATION

Draw a diagram and label all the given measurements. The angle of depression is the angle below the horizontal (red dashed line). Use alternate angles in parallel lines to mark θ inside the triangle.

As the opposite (O) and adjacent sides (A) are given, use $\tan \theta$.

Use the \tan^{-1} key on your calculator.

Round to the nearest degree and express the answer in words.

Now you try

A drone films a concert on a stage from the air. If the drone is 20 m above the level of the stage and a horizontal distance of 50 m from the stage, find the angle of depression from the drone to the stage to the nearest degree.





Example 17 Applying trigonometry

An aeroplane flying at an altitude of 1500 m starts to climb at an angle of 15° to the horizontal when the pilot sees a mountain peak 2120 m high, 2400 m away from him horizontally. Will the aeroplane clear the mountain?

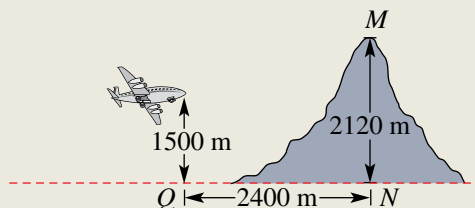

SOLUTION

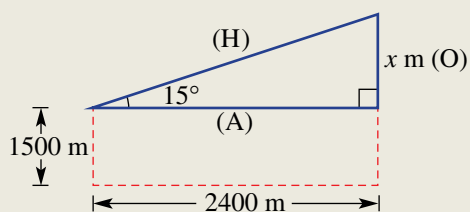

$$\tan 15^\circ = \frac{x}{2400}$$

$$x = 2400 \tan 15^\circ$$

$$= 643.078\dots$$

x needs to be greater than $2120 - 1500 = 620$

Since $x > 620$ m the aeroplane will clear the mountain peak.

EXPLANATION

Draw a diagram, identifying and labelling the right-angled triangle to help solve the problem.

The aeroplane will clear the mountain if the opposite (O) is greater than $(2120 - 1500)$ m = 620 m

Set up the trigonometric ratio using \tan .
Multiply by 2400 and evaluate.

Answer the question in words.

Now you try

A submarine initially at sea level dives at an angle of 11° to the horizontal. At a horizontal distance of 1200 m there is an uncharted reef at a depth of 240 m. Will the submarine pass over the reef at that point?

Exercise 3I

FLUENCY

1–6

1–7

3, 5, 7, 8

Example 14



- 1 The angle of elevation of the top of a tower from a point on the ground 40 m from the base of the tower is 36° . Find the height of the tower to the nearest metre.

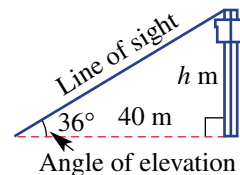

- 2 The angle of elevation of the top of a castle wall from a point on the ground 25 m from the base of the wall is 32° . Find the height of the castle wall to the nearest metre.



- 3 From a point on the ground, Emma measures the angle of elevation of an 80 m tower to be 27° . Find how far Emma is from the base of the tower, correct to the nearest metre.

Example 15



- 4 From a pedestrian overpass, Chris spots a landmark at an angle of depression of 32° . How far away (to the nearest metre) is the landmark from the base of the 24 m high overpass?

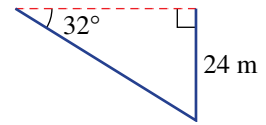

- 5 From a lookout tower, David spots a bushfire at an angle of depression of 25° . If the lookout tower is 42 m high, how far away (to the nearest metre) is the bushfire from the base of the tower?

Example 16



- 6 From the top of a vertical cliff, Josh spots a swimmer out at sea. If the top of the cliff is 38 m above sea level and the swimmer is 50 m from the base of the cliff, find the angle of depression from Josh to the swimmer, to the nearest degree.



- 7 From a ship, a person is spotted floating in the sea 200 m away. If the viewing position on the ship is 20 m above sea level, find the angle of depression from the ship to the person in the sea. Give your answer to the nearest degree.



- 8 A power line is stretched from a pole to the top of a house. The house is 4.1 m high and the power pole is 6.2 m high. The horizontal distance between the house and the power pole is 12 m. Find the angle of elevation of the top of the power pole from the top of the house, to the nearest degree.

PROBLEM-SOLVING

9, 10

9–11

9, 12, 13

Example 17



- 9 An aeroplane flying at 1850 m starts to climb at an angle of 18° to the horizontal to clear a mountain peak 2450 m high and a horizontal distance of 2600 m away. Will the aeroplane clear the mountain?

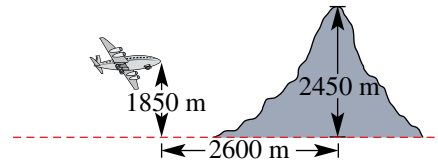

- 10 A road has a steady gradient of 1 in 10.
 a What angle does the road make with the horizontal? Give your answer to the nearest degree.
 b A car starts from the bottom of the inclined road and drives 2 km along the road. How high vertically has the car climbed? Use your rounded answer from part a and give your answer correct to the nearest metre.



- 11 A house is to be built using the design shown on the right. The eaves are 600 mm and the house is 7200 mm wide, excluding the eaves. Calculate the length (to the nearest mm) of a sloping edge of the roof, which is pitched at 25° to the horizontal.

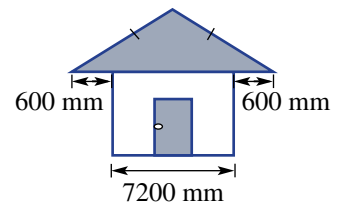

- 12 A garage is to be built with measurements as shown in the diagram on the right. Calculate the sloping length and pitch (angle) of the roof if the eaves extend 500 mm on each side. Give your answers correct to the nearest unit.

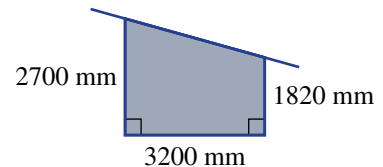

- 13 The chains on a swing are 3.2 m long and the seat is 0.5 m off the ground when it is in the vertical position. When the swing is pulled as far back as possible, the chains make an angle of 40° with the vertical. How high off the ground, to the nearest cm, is the seat when it is at this extreme position?

REASONING

14

14

14, 15

- 14 A person views a vertical monument x metres away as shown.

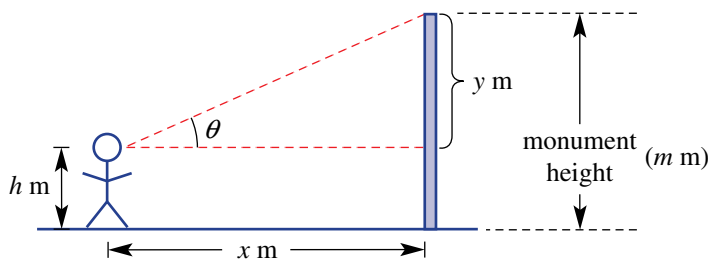

- a If $h = 1.5$, $x = 20$ and $\theta = 15^\circ$, find the height of the monument to two decimal places.
 b If $h = 1.5$, $x = 20$ and $y = 10$, find θ correct to one decimal place.
 c Let the height of the monument be m metres. Write expressions for:
 i m using (in terms of) y and h
 ii y using (in terms of) x and θ
 iii m using (in terms of) x , θ and h .
- 15 Find an expression for the area of this triangle using a and θ .

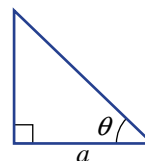

ENRICHMENT: Plane trigonometry

-

-

16-18

- 16 An aeroplane takes off and climbs at an angle of 20° to the horizontal, at 190 km/h a speed of along its flight path for 15 minutes.
- a i Find the distance the aeroplane travels in 15 minutes.
 ii Calculate the height of the aeroplane after 15 minutes correct to two decimal places.
 b If the angle at which the aeroplane climbs is twice the original angle but its speed is halved, will it reach a greater height after 15 minutes? Explain.
 c If the aeroplane's speed is doubled and its climbing angle is halved, will the aeroplane reach a greater height after 15 minutes? Explain.
- 17 The residents of Skeville live 12 km from an airport. They maintain that any aeroplane flying at a height lower than 4 km disturbs their peace. Each Sunday they have an outdoor concert from 12:00 noon till 2:00 p.m.
- a Will an aeroplane taking off from the airport at an angle of 15° over Skeville disturb the residents?
 b When the aeroplane in part a is directly above Skeville, how far (to the nearest metre) has it flown?
 c If the aeroplane leaves the airport at 11:50 a.m. on Sunday and travels at an average speed of 180 km/h, will it disturb the start of the concert?
 d Investigate what average speed (correct to the nearest km/h) the aeroplane can travel at so that it does not disturb the concert. Assume it leaves at 11:50 a.m.
- 18 Peter observes an aeroplane flying directly overhead at a height of 820 m. Twenty seconds later, the angle of elevation of the aeroplane from Peter is 32° . Assume the aeroplane flies horizontally.
- a How far (to the nearest metre) did the aeroplane fly in 20 seconds?
 b What is the aeroplane's speed in km/h, correct to the nearest km/h?

3J Bearings EXTENDING

LEARNING INTENTIONS

- To understand how true bearings are measured and written
- To be able to state the true bearing of one point from another
- To know that opposite directions differ by 180°
- To be able to use compass directions to draw diagrams and form right-angled triangles labelled with angles from bearings
- To be able to use trigonometry to solve problems involving bearings
- To be able to calculate bearings from recorded measurements

Bearings are used to indicate direction and therefore are commonly used to navigate the sea or air in ships or planes. Bushwalkers use bearings with a compass to help follow a map and navigate bushland. The most common type of bearing is the true bearing measured clockwise from north.

Lesson starter: Opposite directions

Marg at point A and Jim at point B start walking toward each other. Marg knows that she has to face 50° south of due east.

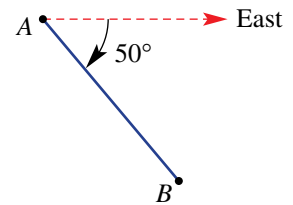

- Measured clockwise from north, can you help Marg determine the true compass bearing that she should walk on?
- Can you find the bearing Jim should walk on?
- Draw a detailed diagram that supports your answers above.

KEY IDEAS

- This mariner's compass shows 16 different directions.

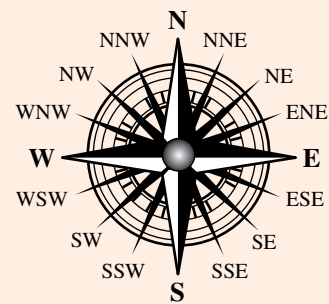

- A **true bearing** is an angle measured clockwise from north.
 - True bearings are written using three digits. For example: 008° T, 032° T or 120° T.
- To describe the true bearing of an object positioned at A from an object positioned at O , we need to start at O , face north then turn clockwise through the required angle to face the object at A .

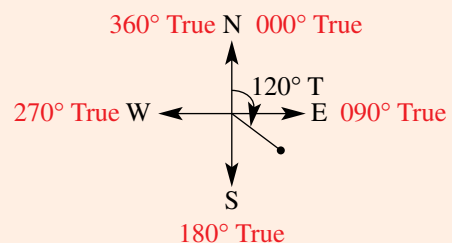

- Opposite directions differ by 180° .
 - $\theta + 180^\circ$ is the opposite bearing if $0^\circ \leq \theta < 180^\circ$.
 - $\theta - 180^\circ$ is the opposite bearing if $180^\circ \leq \theta < 360^\circ$.
- When solving problems with bearings, draw a diagram including four point compass directions (N, E, S, W) at each point.

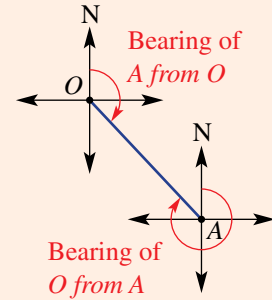

BUILDING UNDERSTANDING

1 Give the true bearings for these common directions.

- a North (N)
- b North-east (NE)
- c East (E)
- d South-east (SE)
- e South (S)
- f South-west (SW)
- g West (W)
- h North-west (NW)

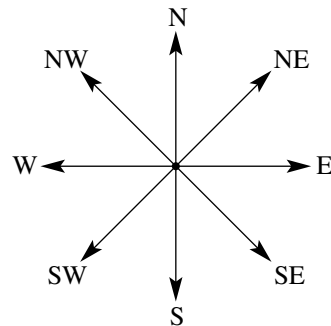

2 State the true bearings shown in these diagrams. Use three digits, for example, 045° T.

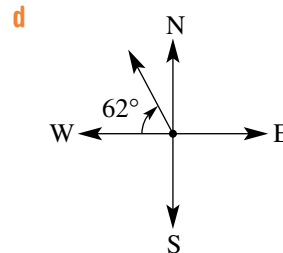
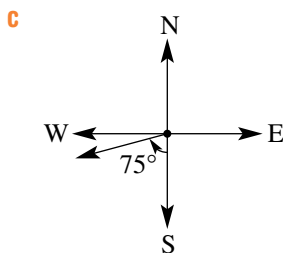
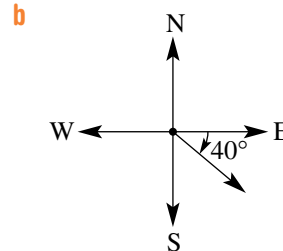
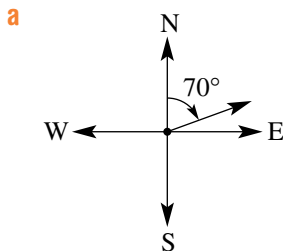

Example 18 Stating true bearings

For the diagram shown give:

- a the true bearing of A from O
- b the true bearing of O from A.

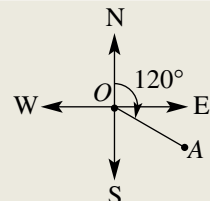

SOLUTION

a The bearing of A from O is 120° T.

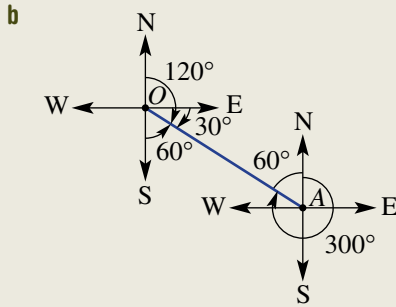

The bearing of O from A is:
 $(360 - 60)^\circ$ T = 300° T

EXPLANATION

Start at O , face north and turn clockwise until you are facing A .

Start at A , face north and turn clockwise until you are facing O . Mark in a compass at A and use alternate angles in parallel lines to mark a 60° angle.

The true bearing is then 60° short of 360° .
 Alternatively, add 180° to 120° to get the opposite direction.

Now you try

For the diagram shown give:

- a the true bearing of A from O
- b the true bearing of O from A .

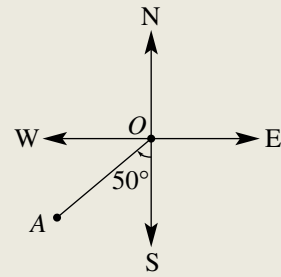

Example 19 Using bearings with trigonometry

A bushwalker walks 3 km on a true bearing of 060° from point A to point B . Find how far east (correct to one decimal place) point B is from point A .

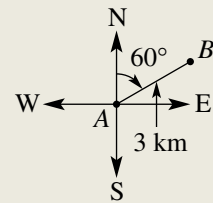

SOLUTION

Let the distance travelled towards the east be d km.

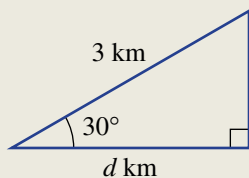

EXPLANATION

Define the distance required and draw and label the right-angled triangle.

As the adjacent (A) is required and the hypotenuse (H) is given, use $\cos \theta$.

Continued on next page

$$\cos 30^\circ = \frac{d}{3}$$

$$\begin{aligned} d &= 3 \cos 30^\circ \\ &= 2.6 \text{ (to 1 d.p.)} \end{aligned}$$

\therefore The distance east is 2.6 km.

Multiply both sides of the equation by 3 and evaluate, rounding to one decimal place.

Express the answer in words.

Now you try

A ship sails 10 km on a true bearing of 055° from point A to point B . Find how far north (correct to one decimal place) point B is from point A .

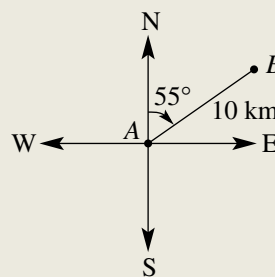

Example 20 Calculating a bearing

A fishing boat starts from point O and sails 75 km on a bearing of 160° T to point B .

- How far east (to the nearest kilometre) of its starting point is the boat?
- What is the true bearing of O from B ?

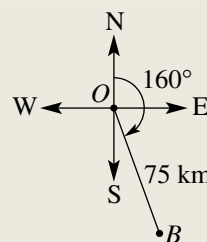

SOLUTION

- Let the distance travelled towards the east be d km.

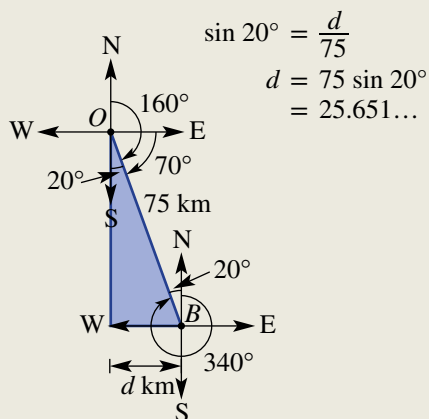

The boat has travelled 26 km to the east of its starting point, to the nearest kilometre.

EXPLANATION

Draw a diagram and label all the given measurements. Mark in a compass at B and use alternate angles to label extra angles.

Set up a trigonometric ratio using sine and solve for d .

Round to the nearest kilometre and write the answer in words.

- b** The bearing of O from B is $(360 - 20)^\circ \text{T} = 340^\circ \text{T}$

Start at B , face north then turn clockwise to face O .

Alternatively, add 180° to 160° to get the opposite direction.

Alternate angle = 20°

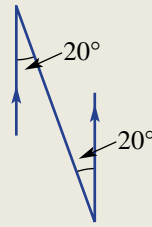

Now you try

A hiker walks 2 km on a true bearing of 120° from point A to point B .

- a** Find how far east (correct to one decimal place) point B is from point A .
b What is the bearing of A from B ?

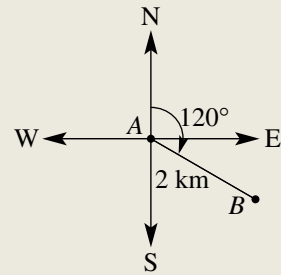

Exercise 3J

FLUENCY

1-4

$1(\frac{1}{2})$, 2, 4, 5

$1(\frac{1}{2})$, 3-5

Example 18

- 1** For each diagram shown, write:

i the true bearing of A from O

ii the true bearing of O from A .

a

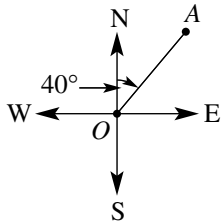

b

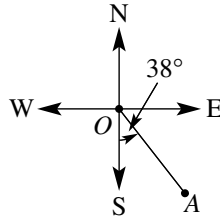

c

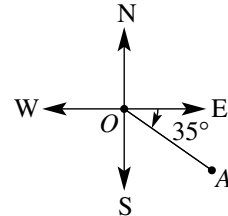

d

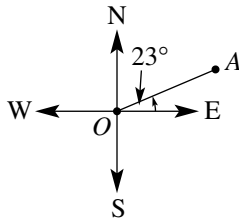

e

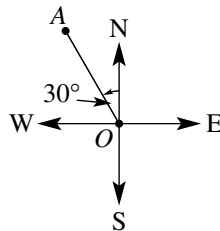

f

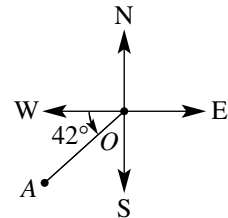

Example 19



- 2 A bushwalker walks 4 km on a true bearing of 055° from point A to point B . Find how far east point B is from point A , correct to two decimal places.

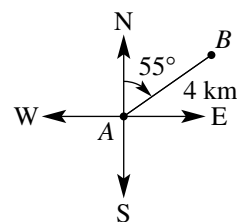

- 3 A speed boat travels 80 km on a true bearing of 048° . Find how far east of its starting point the speed boat is, correct to two decimal places.

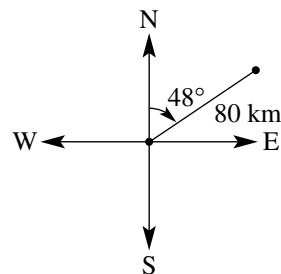

- 4 After walking due east, then turning and walking due south, a hiker is 4 km, 148° T from her starting point. Find how far she walked in a southerly direction, correct to one decimal place.

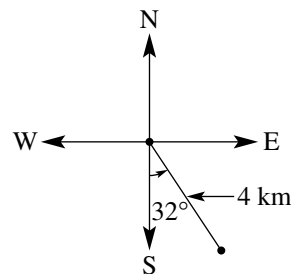

- 5 A four-wheel drive vehicle travels for 32 km on a true bearing of 200° . How far west (to the nearest kilometre) of its starting point is it?

PROBLEM-SOLVING

6–8

6, 8, 9

7–10

Example 20



- 6 A fishing boat starts from point O and sails 60 km on a true bearing of 140° to point B .
- How far east of its starting point is the boat, to the nearest kilometre?
 - What is the bearing of O from B ?

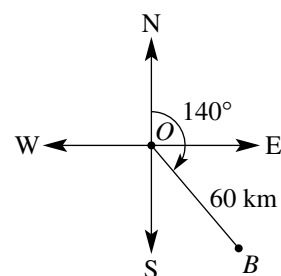

- 7 Two towns, A and B , are 12 km apart. The true bearing of B from A is 250° .
- How far west of A is B , correct to one decimal place?
 - Find the bearing of A from B .

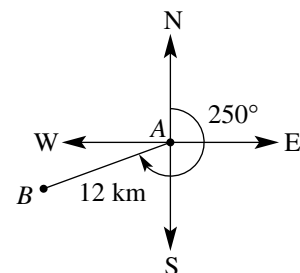

- 8 A helicopter flies on a true bearing of 140° for 210 km then flies due east for 175 km. How far east (to the nearest kilometre) has the helicopter travelled from its starting point?
- 9 Christopher walks 5 km south then walks on a true bearing of 036° until he is due east of his starting point. How far is he from his starting point, to one decimal place?
- 10 Two cyclists leave from the same starting point. One cyclist travels due west while the other travels on a true bearing of 202° . After travelling for 18 km, the second cyclist is due south of the first cyclist. How far (to the nearest metre) has the first cyclist travelled?

REASONING

11

11

11, 12

- 11 A true bearing is a° . Write an expression for the true bearing of the opposite direction of a° if:
- a is between 0 and 180
 - a is between 180 and 360.
- 12 A hiker walks on a triangular pathway starting at point A , walking to point B then C , then A again as shown.
- Find the bearing from B to A .
 - Find the bearing from B to C .
 - Find the bearing from C to B .
 - If the initial bearing was instead 133° and $\angle ABC$ is still 75° , find the bearing from B to C .
 - If $\angle ABC$ was 42° , with the initial bearing of 140° , find the bearing from B to C .

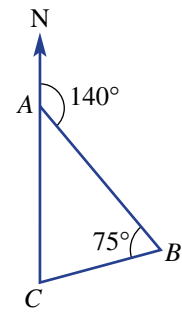

ENRICHMENT: Speed trigonometry

-

-

13, 14

- 13 An aeroplane flies on a true bearing of 168° for two hours at an average speed of 310 km/h. How far (to the nearest kilometre):
- has the aeroplane travelled?
 - south of its starting point is the aeroplane?
 - east of its starting point is the aeroplane?
- 14 A pilot intends to fly directly to Anderly, which is 240 km due north of his starting point. The trip usually takes 50 minutes. Due to a storm, the pilot changes course and flies to Boxleigh on a true bearing of 320° for 150 km, at an average speed of 180 km/h.
- Find (to the nearest kilometre) how far:
 - north the plane has travelled from its starting point
 - west the plane has travelled from its starting point.
 - How many kilometres is the plane from Anderly?
 - From Boxleigh the pilot flies directly to Anderly at 240 km/h.
 - Compared to the usual route, how many extra kilometres (to the nearest kilometre) has the pilot travelled in reaching Anderly?
 - Compared to the usual trip, how many extra minutes (correct to one decimal place) did the trip to Anderly take?



Viewing angle

Lucas is keen to maximise his experience at the outdoor cinema and usually sits at a distance of 20 metres horizontally from the screen. The base of the screen is 3 metres above the ground and the screen is 5 metres in height. Lucas' eye level is 1 metre above ground level as shown.

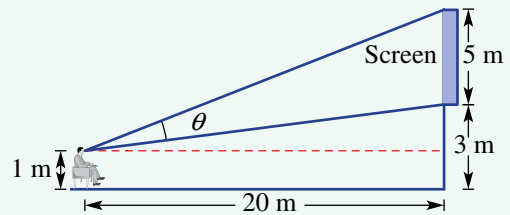

Present a report for the following tasks and ensure that you show clear mathematical workings and explanations where appropriate. Use two decimal places for all rounding.

Preliminary task

- What is the vertical distance between Lucas' eye level and the base of the screen?
- Find the angle of elevation from Lucas' eye level to the base of the screen.
- Find the angle of elevation from Lucas' eye level to the top of the screen.
- Find Lucas' viewing angle (θ).

Modelling task

Formulate

- The problem is to determine how close Lucas should sit to maximise his viewing angle. Write down all the relevant information that will help solve this problem with the aid of a diagram.

Solve

- Determine Lucas' viewing angle if the 20 metre horizontal distance is changed to:
 - 14 metres
 - 8 metres
 - 2 metres.

Evaluate and verify

- Choose integer values for the horizontal distance between Lucas and the screen and determine which integer horizontal distance delivers the largest viewing angle and state the corresponding viewing angle.
- Find the viewing angle for the following horizontal distances:
 - your answer from part **c** plus 0.1 metres
 - your answer from part **c** minus 0.1 metres.
- Do your results from part **d** confirm that you have found a distance which maximises the viewing angle? Explain why.
- Refine your choices for the horizontal distance and determine a distance correct to one decimal place that maximises Lucas' viewing angle.
- Draw a scale diagram illustrating where Lucas should sit to maximise his viewing angle. Decide if this position for Lucas is reasonable.

Communicate

- Summarise your results and describe any key findings.

Extension questions

- Investigate how varying the height of the base of the screen above the ground (previously 3 metres) changes the position that Lucas should sit to maximise the viewing angle. Show your calculations and make drawings to suit.
- Investigate how varying the height of the screen (previously 5 metres) changes the position that Lucas should sit to maximise the viewing angle. Show your calculations and make drawings to suit.

Generating Pythagorean triples

Key technology: Spreadsheets and programming

Pythagorean triples are sets of three positive integers which satisfy Pythagoras' theorem. Perhaps the most well-known example is (3, 4, 5), which is the triple with the smallest numbers such that $3^2 + 4^2 = 5^2$. The triple (3, 4, 5) is also a primitive (or base) triple from which a family of triples can be generated. The family is generated by multiplying all numbers in the triple by a positive integer. So by multiplying by 2 and 3, for example, we generate (6, 8, 10) and (9, 12, 15). Similarly (5, 12, 13) is a primitive triple for a different family of Pythagorean triples. It is useful to know some simple Pythagorean triples and we know that a triangle which uses these numbers as their side lengths will contain a right angle.



1 Getting started

- a Decide if the following sets of three numbers form a Pythagorean triple. That is, test if the three numbers satisfy the rule $a^2 + b^2 = c^2$.
 - i (4, 5, 6)
 - ii (6, 8, 10)
 - iii (9, 15, 17)
 - iv (7, 12, 13)
 - v (7, 24, 25)
- b Use the following primitive triples to write down five other triples.
 - i (3, 4, 5)
 - ii (5, 12, 13)
 - iii (8, 15, 17)

2 Applying an algorithm

Pythagorean triples (a, b, c) can be generated using the following rules where m and n are positive integers and $n < m$.

$$a = m^2 - n^2$$

$$b = 2mn$$

$$c = \sqrt{a^2 + b^2}$$

- a Using the following values of m and n and the above formulas generate the triples (a, b, c) .
 - i $m = 2$ and $n = 1$
 - ii $m = 3$ and $n = 1$
 - iii $m = 3$ and $n = 2$
- b The flowchart shown sets out the algorithm for generating Pythagorean triples for m and n less than 10. Run through the algorithm step by step writing the output (a, b, c) into this table.

a	b	c
3	4	5
8	6	

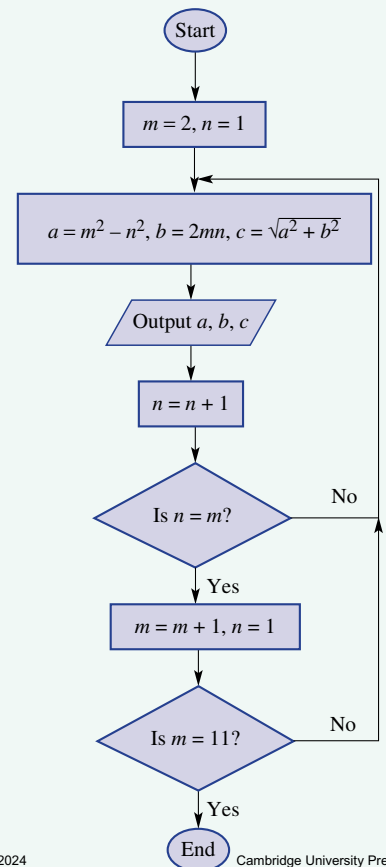

3 Using technology

This spreadsheet uses the previous formulas to generate Pythagorean triples.

	A	B	C	D
1	Pythagorean triples			
2				
3	<i>m</i> value	5		
4				
5	<i>n</i>	<i>a</i>	<i>b</i>	<i>c</i>
6	1	=B\$3^2-A6^2	=2*B\$3*A6	=SQRT(B6^2+C6^2)
7	=A6+1			

- Try entering the formulas into a spreadsheet. Note that the m value can be entered into cell B3.
- Fill down at cells A7, B6, C6 and D6 to generate the triples. Fill down to $n = 4$.
- Alter your m value and fill down once again so that the highest n value is one less than the chosen m value.
- Now alter your m values and try to generate all Pythagorean triples such that all a , b and c are less than 100. How many can you find? Check the internet to confirm your answer.

4 Extension

In the box is pseudocode which outlines the algorithm in the given flowchart.

```

m ← 2
n ← 1
while m < 11
  if n < m then
    a ← m2 - n2
    b ← 2mn
    c ← √(a2 + b2)
    print a, b, c
    n ← n + 1
  else
    m ← m + 1
    n ← 1
  end if
end while

```

- Describe how the while loop and if statement correctly manage the values of m and n .
- Use the algorithm to check that the output values match the output values obtained from the flowchart in part 2 above.
- How could the code be modified so that all Pythagorean triples are found where all values a , b and c are less than 100?
- Use a programming language like Python to write and run a program to generate Pythagorean triples.

Constructing triangles to solve problems

Illustrations for some problems may not initially look as if they include right-angled triangles. A common mathematical problem-solving technique is to construct right-angled triangles so that trigonometry can be used.

Car gap

Two cars are observed in the same lane from an overpass bridge 10 m above the road. The angles of depression to the cars are 20° and 35° .

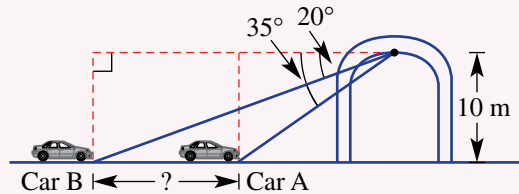

- Find the horizontal distance from car A to the overpass. Show your diagrams and working.
- Find the horizontal distance from car B to the overpass.
- Find the distance between the fronts of the two cars.

Now try these

Solve these similar types of problems. You will need to draw detailed diagrams and split the problem into parts. Refer to the problem above if you need help.

- An observer is 50 m horizontally from a hot air balloon. The angle of elevation to the top of the balloon is 60° and to the bottom of the balloon's basket is 40° . Find the total height of the balloon (to the nearest metre) from the base of the basket to the top of the balloon.
- A ship (at A) is 24 km due east of a lighthouse (L). The captain takes bearings from two landmarks, M and Q, which are due north and due south of the lighthouse respectively. The true bearings of M and Q from the ship are 322° and 244° respectively. How far apart are the two landmarks?

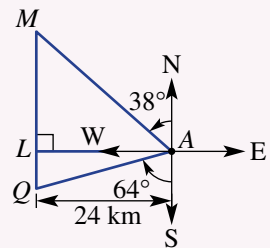

- From the top of a 90 m cliff the angles of depression of two boats in the water, both directly east of the lighthouse, are 25° and 38° respectively. What is the distance between the two boats to the nearest metre?

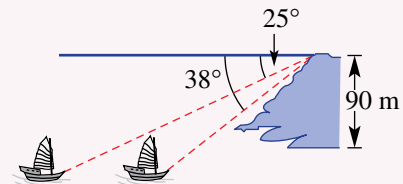

- A person on a boat 200 m out to sea views a 40 m high castle wall on top of a 32 m high cliff. Find the viewing angle between the base and top of the castle wall from the person on the boat.

- 1 A right-angled isosceles triangle has area of 4 square units. Determine the exact perimeter of the triangle.
- 2 Find the area of the triangle shown using trigonometry. (*Hint*: Insert a line showing the height of the triangle.)

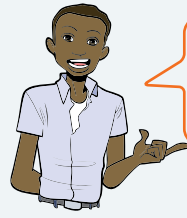
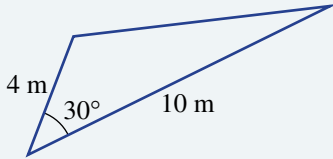

Up for a challenge? If you get stuck on a question, check out the 'Working with unfamiliar problems' poster at the end of the book to help you.

- 3 A rectangle $ABCD$ has sides $AB = CD = 34$ cm. E is a point on CD such that $CE = 9$ cm and $ED = 25$ cm. AE is perpendicular to EB . What is the length of BC ?
- 4 Find the bearing from B to C in this diagram.

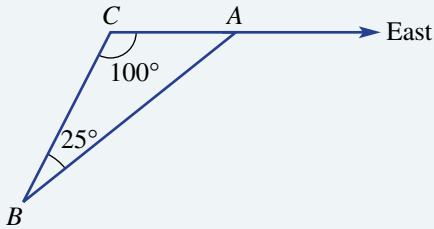

- 5 Which is a better fit? A square peg in a round hole or a round peg in a square hole. Use area calculations and percentages to investigate.
- 6 Boat A is 20 km from port on a true bearing of 025° and boat B is 25 km from port on a true bearing of 070° . Boat B is in distress. What bearing (to the nearest degree) should boat A travel on to reach boat B?
- 7 For positive integers m and n such that $n < m$, the Pythagorean triples (e.g. 3, 4, 5) can be generated using $a = m^2 - n^2$ and $b = 2mn$, where a and b are the two shorter sides of the right-angled triangle.
 - a Using these formulas and Pythagoras' theorem to calculate the third side, generate the Pythagorean triples for these values of m and n .
 - i $m = 2, n = 1$
 - ii $m = 3, n = 2$
 - b Using the expressions for a and b and Pythagoras' theorem, find a rule for c (the hypotenuse) in terms of n and m .



Finding the hypotenuse

$$c^2 = 2^2 + 1^2$$

$$= 5$$

$$c = \sqrt{5}$$

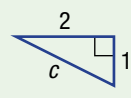
$$= 2.24 \text{ (to 2 d.p.)}$$

Shorter sides

$$a^2 + 5^2 = 7^2$$

$$a^2 = 7^2 - 5^2$$

$$= 24$$

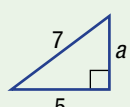
$$\therefore a = \sqrt{24}$$

Applications

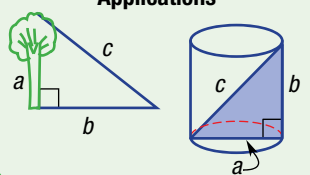

Pythagoras' theorem

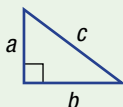

$$c^2 = a^2 + b^2$$

SOHCAHTOA

$$\sin \theta = \frac{O}{H} = \frac{4}{5}$$

$$\cos \theta = \frac{A}{H} = \frac{3}{5}$$

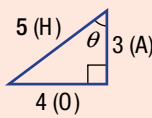
$$\tan \theta = \frac{O}{A} = \frac{4}{3}$$

Pythagoras' theorem and trigonometry

Bearings (Ext)

True bearings are measured clockwise from north.

360° T N 000° T

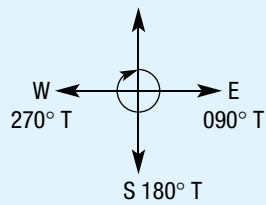

B is 150° T from A

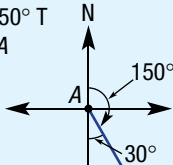

A is 330° T from B

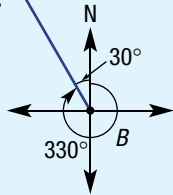

Finding side lengths

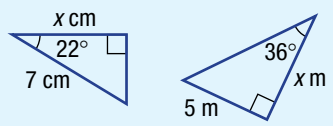

$$\cos 22^\circ = \frac{x}{7}$$

$$x = 7 \cos 22^\circ$$

$$= 6.49$$

(to 2 d.p.)

$$\tan 36^\circ = \frac{5}{x}$$

$$x \times \tan 36^\circ = 5$$

$$x = \frac{5}{\tan 36^\circ}$$

$$= 6.88 \text{ (to 2 d.p.)}$$

Elevation and depression (Ext)

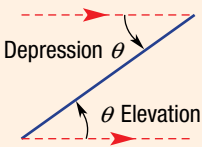

Finding angles

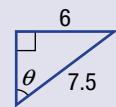

$$\sin \theta = \frac{6}{7.5}$$

$$\theta = \sin^{-1} \left(\frac{6}{7.5} \right)$$

$$= 53.13^\circ \text{ (to 2 d.p.)}$$

Chapter checklist with success criteria

A printable version of this checklist is available in the Interactive Textbook



3A

1. I can find the length of the hypotenuse using Pythagoras' theorem.

e.g. Find the length of the hypotenuse as an exact value and rounded to one decimal place.

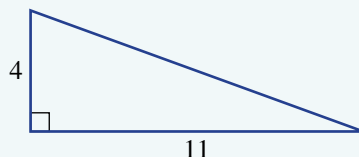

3B

2. I can find the length of a shorter side using Pythagoras' theorem.

e.g. Find the value of the pronumeral correct to one decimal place.

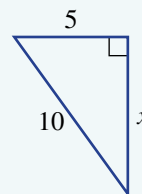

3C

3. I can apply Pythagoras' theorem.

e.g. Two flag poles are located 10 m apart. The flag poles are 4.5 m and 3 m high. A cable links the top of the two flag poles. Find the length of the cable correct to one decimal place.

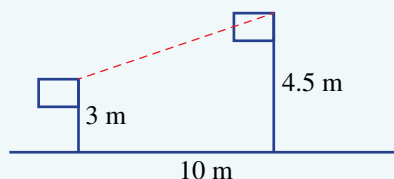

3D

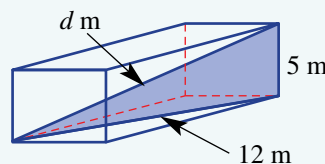
4. I can use Pythagoras in 3D.e.g. Find the distance, d m, from one corner to the opposite corner in the rectangular prism shown.

3E

5. I can write a trigonometric ratio.

e.g. Using the given sides, write a trigonometric ratio for the triangle shown.

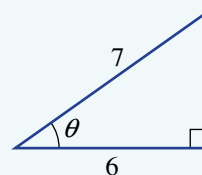

3F

6. I can evaluate a trigonometric ratio on a calculator.e.g. Evaluate $\cos 35^\circ$ correct to two decimal places.

3F

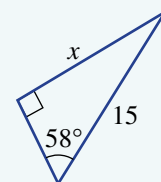
7. I can find a side length using a trigonometric ratio.e.g. Find the value of x , correct to one decimal place.

3G

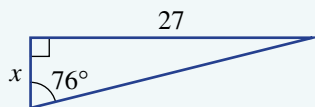
8. I can find a side length using a trigonometric ratio with the unknown in the denominator.e.g. Find the value of x , correct to one decimal place.

Chapter checklist with success criteria

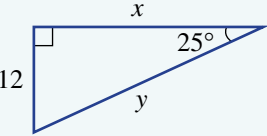
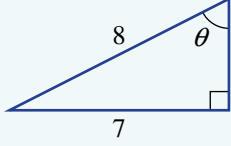
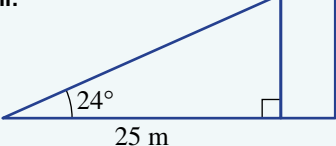
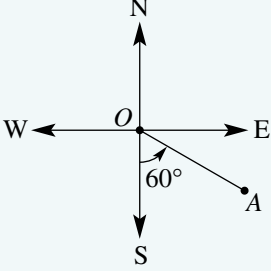
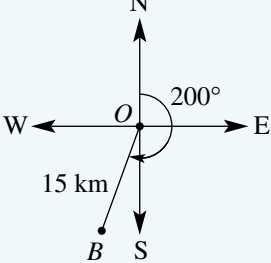
3G	<p>9. I can find multiple side lengths using trigonometry. e.g. Find the values of the pronumerals, correct to one decimal place, in the right-angled triangle shown.</p>		<input checked="" type="checkbox"/> <input type="checkbox"/>
3H	<p>10. I can use an inverse trigonometric ratio. e.g. Find the value of θ in $\cos \theta = 0.674$ correct to one decimal place.</p>		<input type="checkbox"/>
3H	<p>11. I can find an angle using trigonometric ratios. e.g. Find the value of θ, correct to the nearest degree.</p>		<input type="checkbox"/>
3I	<p>12. I can apply trigonometry using an angle of elevation. e.g. The angle of elevation of the top of a building from a point on the ground 25 m from the base of the building is 24°. Find the height of the building to the nearest metre.</p>		Ext <input type="checkbox"/>
3I	<p>13. I can apply trigonometry using an angle of depression. e.g. A duck on a lake spots a fish below the surface. The fish is 8 m below water level and a horizontal direct distance of 6 m from the duck. Find the angle of depression of the fish from the duck to the nearest degree.</p>		Ext <input type="checkbox"/>
3J	<p>14. I can state true bearings. e.g. For the diagram shown, give the true bearing of A from O and the true bearing of O from A.</p>		Ext <input type="checkbox"/>
3J	<p>15. I can use bearings with trigonometry. e.g. A yacht sails from point O for 15 km on a bearing of 200° T to point B. How far west is the yacht from its starting point (to the nearest km) and what is the bearing of O from B?</p>		Ext <input type="checkbox"/>

Short-answer questions

3A/B



1 Find the unknown length in these triangles. Give an exact answer.

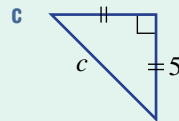
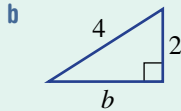
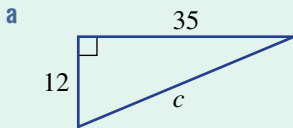

3B



2 A steel support beam of length 6.5 m is connected to a wall at a height of 4.7 m above the ground. Find the distance (to the nearest centimetre) between the base of the building and the point where the beam is joined to the ground.

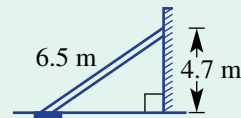

3A



3 For this double triangle, find:
 a AC
 b CD (correct to two decimal places).

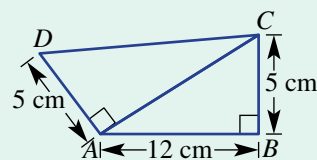

3C



4 Two cafés on opposite sides of an atrium in a shopping centre are respectively 10 m and 15 m above the ground floor. If the cafés are linked by a 20 m escalator, find the horizontal distance (to the nearest metre) across the atrium, between the two cafés.

3D



5 Find the values of the pronumerals in the three-dimensional objects shown below. Give the answer correct to two decimal places.

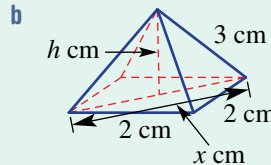
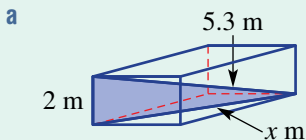

3F



6 Find the following values correct to two decimal places.
 a $\sin 40^\circ$ b $\tan 66^\circ$ c $\cos 44.3^\circ$

3F/G/H



7 Find the value of each pronumeral correct to two decimal places.

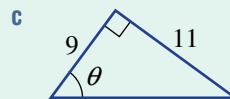
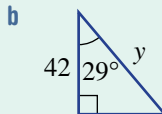
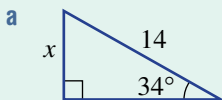

3I



8 The angle of elevation of the top of a lighthouse from a point on the ground 40 m from its base is 35° . Find the height of the lighthouse to two decimal places.

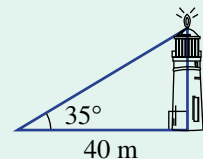

3I



9 From a point on the ground, Geoff measures the angle of elevation of a 120 m tall tower to be 34° . How far is Geoff from the base of the tower, correct to two decimal places?

3J

10 A yacht sails 80 km on a true bearing of 048° .

- a How far east of its starting point is the yacht, correct to two decimal places?
- b How far north of its starting point is the yacht, correct to two decimal places?

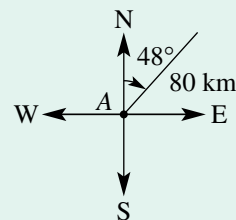

3J

11 A ship leaves Coffs Harbour and sails 320 km east. It then changes direction and sails 240 km due north to its destination. What will the ship's true bearing be from Coffs Harbour when it reaches its destination, correct to two decimal places?

3I

12 From the roof of a skyscraper, Aisha spots a car at an angle of depression of 51° . If the skyscraper is 78 m high, how far away is the car from the base of the skyscraper, correct to one decimal place?

3F

13 Penny wants to measure the width of a river. She places two markers, A and B , 10 m apart along one bank. C is a point directly opposite marker B . Penny measures angle BAC to be 28° . Find the width of the river to one decimal place.

3I

14 An aeroplane takes off and climbs at an angle of 15° to the horizontal, at a speed of 210 km/h along its flight path for 15 minutes.

- a Find the distance the aeroplane travels.
- b Find the height the aeroplane reaches, correct to two decimal places.

Multiple-choice questions

3A

1 For the right-angled triangle shown, the length of the hypotenuse can be found from the equation:

- A $c^2 = 5^2 + 12^2$ B $c^2 = 5^2 - 12^2$
 C $c^2 = 12^2 - 5^2$ D $c^2 = 5^2 \times 12^2$
 E $(5 + 12)^2$

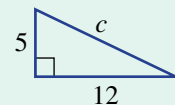

3B

2 For the right-angled triangle shown, the value of b is given by:

- A $\sqrt{0.7^2 + 0.4^2}$ B $\sqrt{0.7^2 - 0.4^2}$
 C $\sqrt{0.4^2 - 0.7^2}$ D $\sqrt{0.7^2 \times 0.4^2}$
 E $\sqrt{(0.7 - 0.4)^2}$

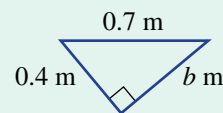

3B

3 For the right-angled triangle shown:

- A $x^2 = \frac{49}{2}$ B $7x^2 = 2$
 C $x^2 = \frac{7}{2}$ D $x^2 + 7^2 = x^2$
 E $x^2 = \frac{2}{7}$

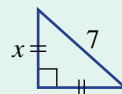

3E

4 For the triangle shown:

- A $\sin \theta = \frac{a}{b}$ B $\sin \theta = \frac{c}{a}$
 C $\sin \theta = \frac{a}{c}$ D $\sin \theta = \frac{b}{c}$
 E $\sin \theta = \frac{c}{b}$

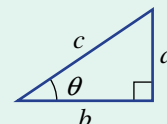

3F



- 5 The value of $\cos 46^\circ$ correct to four decimal places is:
 A 0.7193 B 0.6947 C 0.594
 D 0.6532 E 1.0355

3F



- 6 In the diagram the value of x , correct to two decimal places, is:
 A 40 B 13.61 C 4.70
 D 9.89 E 6.47

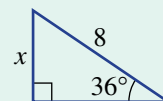

3G



- 7 The length of x in the triangle is given by:
 A $8 \sin 46^\circ$ B $8 \cos 46^\circ$ C $\frac{8}{\cos 46^\circ}$
 D $\frac{8}{\sin 46^\circ}$ E $\frac{\cos 46^\circ}{8}$

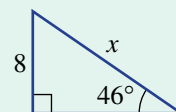

3J



Ext

- 8 The true bearing of A from O is 130° . The true bearing of O from A is:
 A 050° B 220° C 310°
 D 280° E 170°

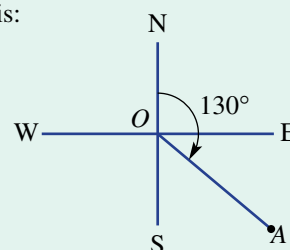

3G



- 9 A ladder is inclined at an angle of 28° to the horizontal. If the ladder reaches 8.9 m up the wall, the length of the ladder correct to the nearest metre is:
 A 19 m B 4 m C 2 m
 D 10 m E 24 m

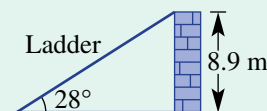

3H



- 10 The value of θ in the diagram, correct to two decimal places, is:
 A 0.73° B 41.81° C 48.19°
 D 33.69° E 4.181°

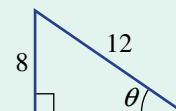

Extended-response questions



- 1 An extension ladder is initially placed so that it reaches 2 m up a wall. The foot of the ladder is 80 cm from the base of the wall.
- Find the length of the ladder, to the nearest centimetre, in its original position.
 - Without moving the foot, the ladder is extended so that it reaches 1 m further up the wall. How far (to the nearest centimetre) has the ladder been extended?
 - The ladder is placed so that its foot is now 20 cm closer to the base of the wall.
 - How far up the wall can the extended ladder length found in part **b** reach? Round to two decimal places.
 - Is this further than the distance in part **b**?

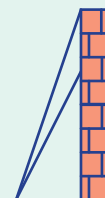

- 2** From the top of a 100 m cliff, Skevi sees a boat out at sea at an angle of depression of 12° .
- Draw a diagram for this situation.
 - Find how far out to sea the boat is to the nearest metre.
 - A swimmer is 2 km away from the base of the cliff and in line with the boat. What is the angle of depression to the swimmer, to the nearest degree?
 - How far away is the boat from the swimmer, to the nearest metre?
- 3** A pilot takes off from Amber Island and flies for 150 km at 040° T to Barter Island where she unloads her first cargo. She intends to fly to Dream Island, but a bad thunderstorm between Barter and Dream islands forces her to fly off-course for 60 km to Crater Atoll on a bearing of 060° T. She then turns on a bearing of 140° T and flies for 100 km until she reaches Dream Island, where she unloads her second cargo. She then takes off and flies 180 km on a bearing of 055° T to Emerald Island.
- How many extra kilometres did she fly trying to avoid the storm? Round to the nearest kilometre.
 - From Emerald Island she flies directly back to Amber Island. How many kilometres did she travel on her return trip? Round to the nearest kilometre.



4

Linear relationships

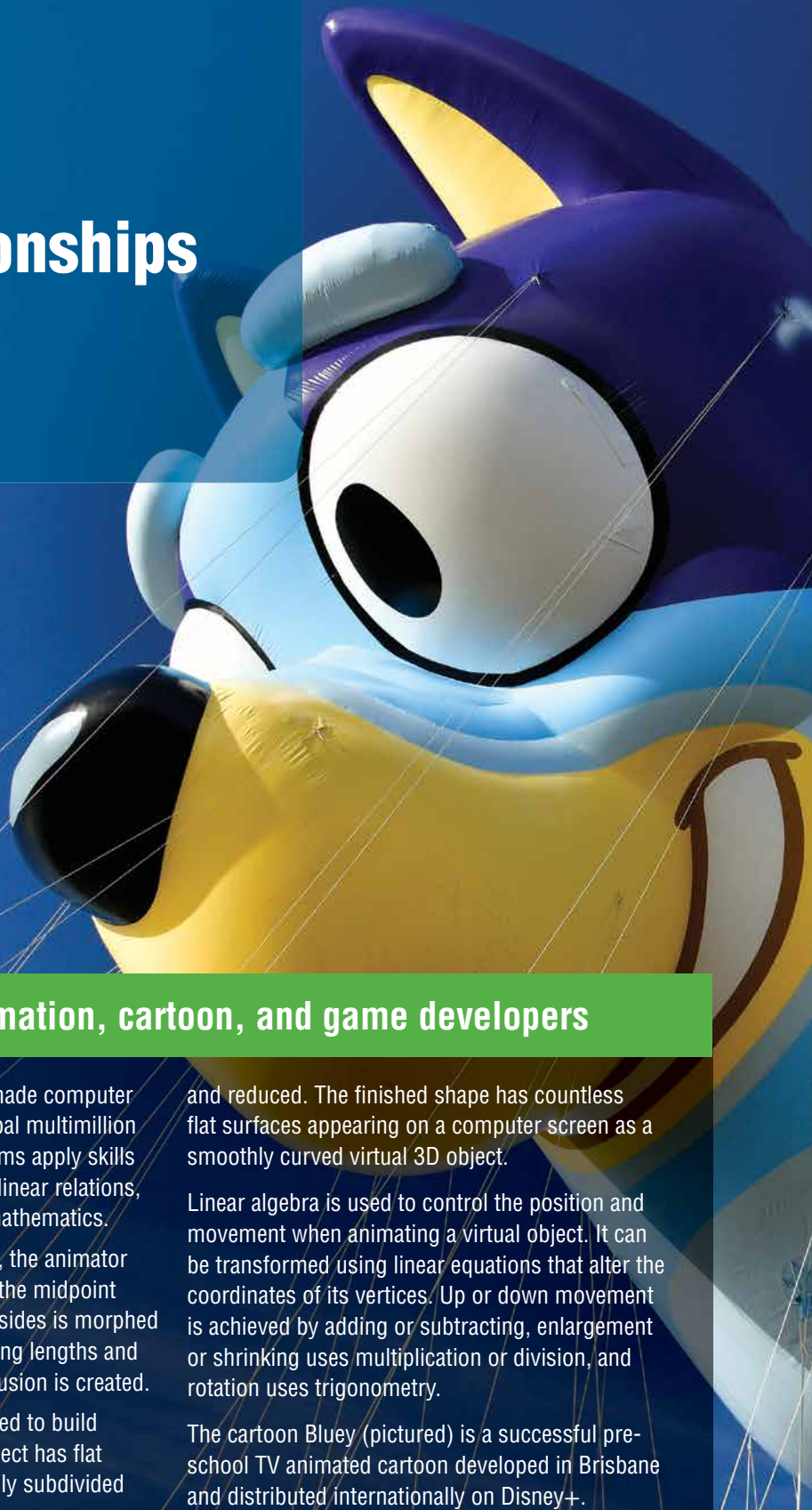

Maths in context: Animation, cartoon, and game developers

The virtual world of animation has made computer gaming and cartoon videos into global multimillion dollar industries. Animation algorithms apply skills from algebra, coordinate geometry, linear relations, trigonometry, and more advanced mathematics.

When designing a cartoon character, the animator codes a subdivision process. Using the midpoint formula, a 2D polygon with straight sides is morphed into a curve. By repeatedly subdividing lengths and slicing off corners, a virtual curve illusion is created.

A similar subdivision process is coded to build 3D shapes. The initial polyhedral object has flat polygon faces that are then repeatedly subdivided

and reduced. The finished shape has countless flat surfaces appearing on a computer screen as a smoothly curved virtual 3D object.

Linear algebra is used to control the position and movement when animating a virtual object. It can be transformed using linear equations that alter the coordinates of its vertices. Up or down movement is achieved by adding or subtracting, enlargement or shrinking uses multiplication or division, and rotation uses trigonometry.

The cartoon Bluey (pictured) is a successful pre-school TV animated cartoon developed in Brisbane and distributed internationally on Disney+.

Chapter contents

- 4A Introduction to linear relationships (CONSOLIDATING)
- 4B Graphing straight lines using intercepts
- 4C Lines with one intercept
- 4D Gradient
- 4E Gradient and direct proportion
- 4F Gradient–intercept form
- 4G Finding the equation of a line
- 4H Midpoint and length of a line segment
- 4I Parallel and perpendicular lines (EXTENDING)
- 4J Linear modelling
- 4K Graphical solutions to simultaneous equations

Australian Curriculum 9.0

ALGEBRA

Find the gradient of a line segment, the midpoint of the line interval and the distance between 2 distinct points on the Cartesian plane (AC9M9A03)

Use mathematical modelling to solve applied problems involving change including financial contexts; formulate problems, choosing to use either linear or quadratic functions; interpret solutions in terms of the situation; evaluate the model and report methods and findings (AC9M9A05)

Experiment with the effects of the variation of parameters on graphs of related functions, using digital tools, making connections between graphical and algebraic representations, and generalising emerging patterns (AC9M9A06)

MEASUREMENT

Use mathematical modelling to solve practical problems involving direct proportion, rates, ratio and scale, including financial contexts; formulate the problems and interpret solutions in terms of the situation; evaluate the model and report methods and findings (AC9M9M05)

© ACARA

Online resources

A host of additional online resources are included as part of your Interactive Textbook, including HOTmaths content, video demonstrations of all worked examples, auto-marked quizzes and much more.

4A Introduction to linear relationships CONSOLIDATING

LEARNING INTENTIONS

- To review the features of the Cartesian plane
- To understand that a linear relation is a set of ordered pairs that form a straight line when graphed
- To understand that the rule for a straight line graph gives the relationship between the x - and y -coordinates in the ordered pair
- To be able to use a linear rule to construct a table of ordered pairs and plot these on a Cartesian plane to form a straight line graph
- To be able to decide if a point is on a line using the line's rule
- To know what the x - and y -intercepts are and to be able to identify them on a graph or table

If two variables are related in some way, we can use mathematical rules to precisely describe this relationship. The most simple kind of mathematical relationship is one that can be illustrated with a straight line graph. These are called linear relations. The volume of petrol in your car at a service bowser, for example, might initially be 10 L then be increasing by 1.2 L per second after that. This is an example of a linear relationship between *volume* and *time* because the volume is increasing at a constant rate of 1.2 L/s.



A car's annual running costs can be \$4000 p.a., including fuel, repairs, registration and insurance. If a car cost \$17 000, the total cost, C , for n years could be expressed as the linear relation: $C = 4000n + 17\,000$.

Lesson starter: Is it linear?

Here are three rules linking x and y .

1 $y_1 = \frac{2}{x} + 1$

2 $y_2 = x^2 - 1$

3 $y_3 = 3x - 4$

First complete this simple table and graph.

x	1	2	3
y_1			
y_2			
y_3			

- Which of the three rules do you think is linear?
- How do the table and graph help you decide it's linear?

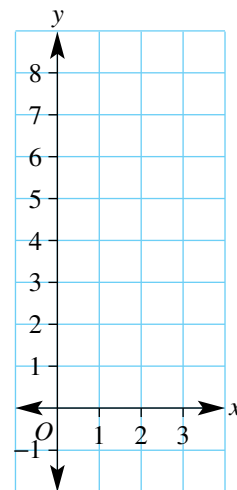

KEY IDEAS

- **Coordinate geometry** provides a link between geometry and algebra.
- The **Cartesian plane** (or number plane) consists of two axes which divide the number plane into four **quadrants**.
 - The horizontal x -axis and vertical y -axis intersect at right angles at the **origin** $O(0, 0)$.
 - A point is precisely positioned on a Cartesian plane using the **coordinate pair** (x, y) where x describes the horizontal position and y describes the vertical position of the point from the origin.

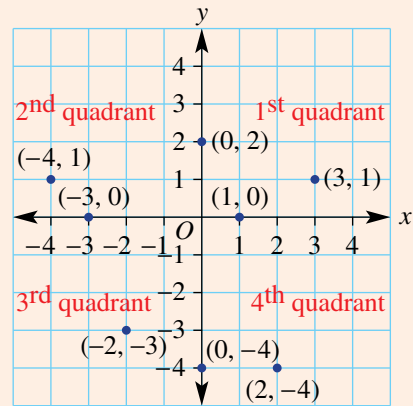

- A **linear relation** is a set of ordered pairs (x, y) that when graphed give a straight line.
- Linear relationships have rules that may be of the form:
 - $y = mx + c$. For example, $y = 2x + 1$.
 - $ax + by = d$ or $ax + by + c = 0$. For example, $2x - 3y = 4$ or $2x - 3y - 4 = 0$.
- The x -intercept is the point where the graph meets the x -axis.
- The y -intercept is the point where the graph meets the y -axis.

x	-2	-1	0	1	2	3
y	8	6	4	2	0	-2

x-intercept
↓
↑
y-intercept

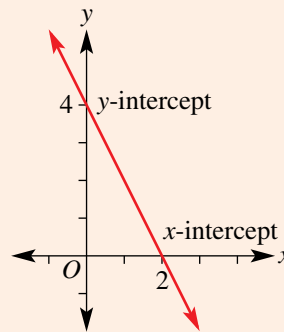

BUILDING UNDERSTANDING

- 1 Refer to the Cartesian plane shown.
 - a Give the coordinates of all the points A – L.
 - b State which points lie on:
 - i the x -axis
 - ii the y -axis.
 - c State which points lie inside the:
 - i 2nd quadrant
 - ii 4th quadrant.
- 2 For the rule $y = 3x - 4$, find the value of y for these x -values.
 - a $x = 2$
 - b $x = -1$

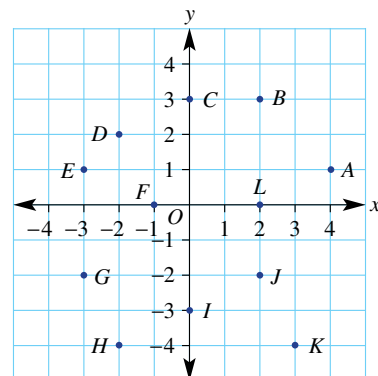

3 For the rule $y = -2x + 1$, find the value of y for these x -values.

a $x = 0$

b $x = -10$

4 Give the coordinates of three pairs of points on the line $y = x + 3$.



Example 1 Plotting points to graph straight lines

Using $-3 \leq x \leq 3$, construct a table of values and plot a graph for these linear relations.

a $y = x + 2$

b $y = -2x + 2$

SOLUTION

a

x	-3	-2	-1	0	1	2	3
y	-1	0	1	2	3	4	5

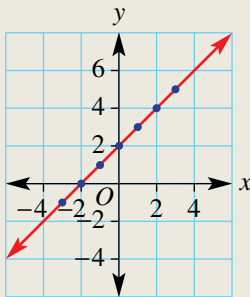

b

x	-3	-2	-1	0	1	2	3
y	8	6	4	2	0	-2	-4

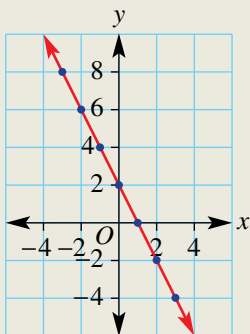

EXPLANATION

Use $-3 \leq x \leq 3$ as instructed and substitute each value of x into the rule $y = x + 2$.

The coordinates of the points are read from the table, i.e. $(-3, -1)$, $(-2, 0)$, etc.

Plot each point and join to form a straight line. Extend the line to show it continues in either direction.

Use $-3 \leq x \leq 3$ as instructed and substitute each value of x into the rule $y = -2x + 2$.

For example:

$$\begin{aligned} x = -3, y &= -2 \times (-3) + 2 \\ &= 6 + 2 \\ &= 8 \end{aligned}$$

Plot each point and join to form a straight line. Extend the line beyond the plotted points.

Now you try

Using $-3 \leq x \leq 3$, construct a table of values and plot a graph for these linear relations.

a $y = x - 1$

b $y = -3x + 1$



Example 2 Reading off the x -intercept and y -intercept

Write down the coordinates of the x -intercept and y -intercept from this table and graph.

a

x	-2	-1	0	1	2	3
y	6	4	2	0	-2	-4

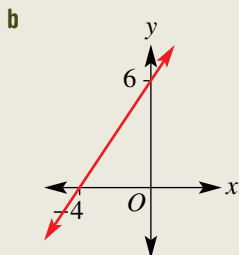

SOLUTION

a The x -intercept is at $(1, 0)$.

The y -intercept is at $(0, 2)$.

b The x -intercept is at $(-4, 0)$.

The y -intercept is at $(0, 6)$.

EXPLANATION

The x -intercept is at the point where $y = 0$ (on the x -axis).

The y -intercept is at the point where $x = 0$ (on the y -axis).

The x -intercept is at the point where $y = 0$ (on the x -axis).

The y -intercept is at the point where $x = 0$ (on the y -axis).

Now you try

Write down the coordinates of the x -intercept and y -intercept from this table and graph.

a

x	-3	-2	-1	0	1	2
y	4	3	2	1	0	-1

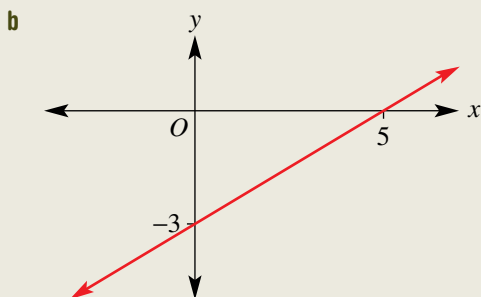



Example 3 Deciding if a point is on a line

Decide if the point $(-2, 4)$ is on the line with the given rules.

a $y = 2x + 10$

b $y = -x + 2$

SOLUTION

a $y = 2x + 10$

Substitute $x = -2$

$$y = 2(-2) + 10$$

$$= 6$$

\therefore the point $(-2, 4)$ is not on the line.

b $y = -x + 2$

Substitute $x = -2$

$$y = -(-2) + 2$$

$$= 4$$

\therefore the point $(-2, 4)$ is on the line.

EXPLANATION

Find the value of y by substituting $x = -2$ into the rule for y .

The y -value is not 4, so $(-2, 4)$ is not on the line.

By substituting $x = -2$ into the rule for the line, y is 4.

So $(-2, 4)$ is on the line.

Now you try

Decide if the point $(-1, 6)$ is on the line with the given rules.

a $y = -2x + 4$

b $y = 3x + 5$

Exercise 4A

FLUENCY

$1-3(\frac{1}{2})$

$1-4(\frac{1}{2})$

$1-4(\frac{1}{2})$

Example 1

- 1 Using $-3 \leq x \leq 3$, construct a table of values and plot a graph for these linear relations.

a $y = x - 1$

b $y = 2x - 3$

c $y = -x + 4$

d $y = -3x$

Example 2

- 2 Write down the coordinates of the x - and y -intercepts for the following tables and graphs.

a

x	-3	-2	-1	0	1	2	3
y	4	3	2	1	0	1	2

b

x	-3	-2	-1	0	1	2	3
y	-1	0	1	2	3	4	5

c

x	-1	0	1	2	3	4
y	10	8	6	4	2	0

d

x	-5	-4	-3	-2	-1	0
y	0	2	4	6	8	10

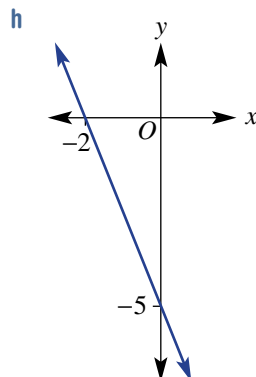
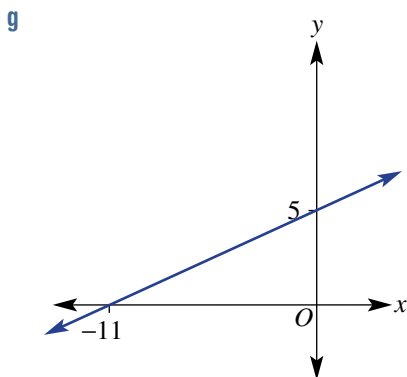
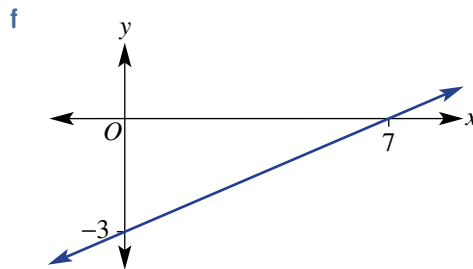
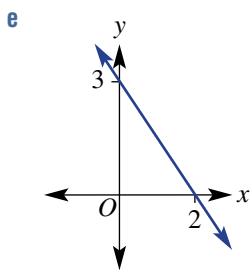

Example 3

3 Decide if the point $(1, 2)$ is on the line with the given rule.

a $y = x + 1$

b $y = 2x - 1$

c $y = -x + 3$

d $y = -2x + 4$

e $y = -x + 5$

f $y = -\frac{1}{2}x + \frac{1}{2}$

4 Decide if the point $(-3, 4)$ is on the line with the given rule.

a $y = 2x + 8$

b $y = x + 7$

c $y = -x - 1$

d $y = \frac{1}{3}x + 6$

e $y = -\frac{1}{3}x + 3$

f $y = \frac{5}{6}x + \frac{11}{2}$

PROBLEM-SOLVING

5

5, 6

5(1/2), 6

5 Find a rule in the form $y = mx + c$ (e.g. $y = 2x - 1$) that matches these tables of values.

a

x	0	1	2	3	4
y	2	3	4	5	6

b

x	-1	0	1	2	3
y	-2	0	2	4	6

c

x	-2	-1	0	1	2	3
y	-3	-1	1	3	5	7

d

x	-3	-2	-1	0	1	2
y	5	4	3	2	1	0

6 Match rules **a**, **b**, **c** and **d** to the graphs **A**, **B**, **C** and **D**.

a $y = 2x + 1$

b $y = -x - 1$

c $y = -2x + 3$

d $x + y = 2$

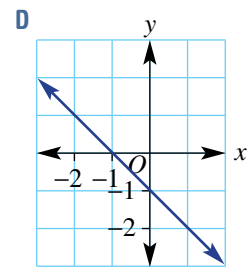
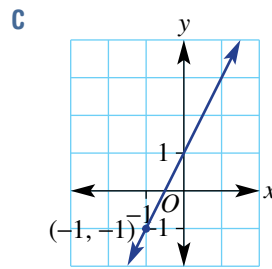
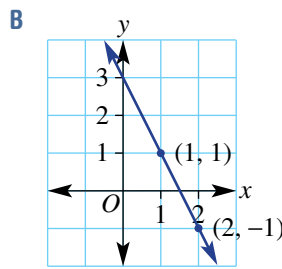
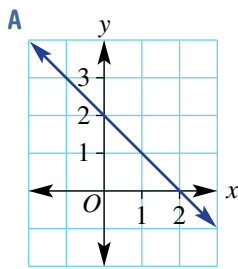

REASONING

7

7, 8

8, 9

7 Decide if the following rules are equivalent.

a $y = 1 - x$ and $y = -x + 1$

b $y = 1 - 3x$ and $y = 3x - 1$

c $y = -2x + 1$ and $y = -1 - 2x$

d $y = -3x + 1$ and $y = 1 - 3x$

8 Give reasons why the x -intercept on these graphs is at $(\frac{3}{2}, 0)$.

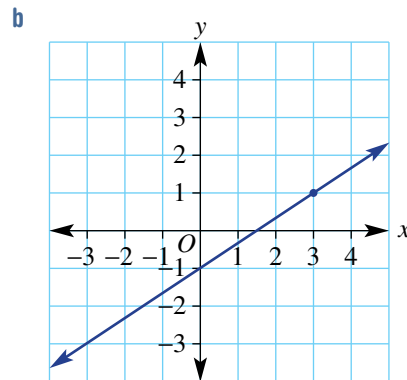
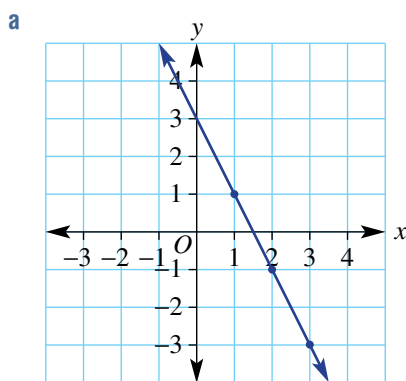

9 Decide if the following equations are true or false.

a $\frac{2x + 4}{2} = x + 4$

b $\frac{3x - 6}{3} = x - 2$

c $\frac{1}{2}(x - 1) = \frac{1}{2}x - \frac{1}{2}$

d $\frac{2}{3}(x - 6) = \frac{2}{3}x - 12$

ENRICHMENT: Tough rule finding

-

-

10

10 Find the linear rule linking x and y in these tables.

a

x	-1	0	1	2	3
y	5	7	9	11	13

b

x	-2	-1	0	1	2
y	22	21	20	19	18

c

x	0	2	4	6	8
y	-10	-16	-22	-28	-34

d

x	-5	-4	-3	-2	-1
y	29	24	19	14	9

e

x	1	3	5	7	9
y	1	2	3	4	5

f

x	-14	-13	-12	-11	-10
y	$5\frac{1}{2}$	5	$4\frac{1}{2}$	4	$3\frac{1}{2}$

4B Graphing straight lines using intercepts

LEARNING INTENTIONS

- To know that at most two points are required to sketch a straight line graph
- To know how to find the x - and y -intercepts from the rule for a linear graph
- To be able to sketch a linear graph by finding intercepts and joining in a line

When linear rules are graphed, all the points lie in a straight line. It is therefore possible to graph a straight line using only two points. Two critical points that help draw these graphs are the x -intercept and y -intercept introduced in the previous section.



Businesses claim a tax deduction for the annual decrease in the value, V , of equipment over n years. A straight line segment joining the intercepts $(0, V)$ and $(n, 0)$ shows that the rate of decrease per year is $\frac{V}{n}$.

Lesson starter: Two key points

Consider the relation $y = \frac{1}{2}x + 1$ and complete this table and graph.

x	-4	-3	-2	-1	0	1	2
y							

- What are the coordinates of the point where the line crosses the y -axis? That is, state the coordinates of the y -intercept.
- What are the coordinates of the point where the line crosses the x -axis? That is, state the coordinates of the x -intercept.
- Discuss how you might find the coordinates of the x - and y -intercepts without drawing a table and plotting points. Explain your method.

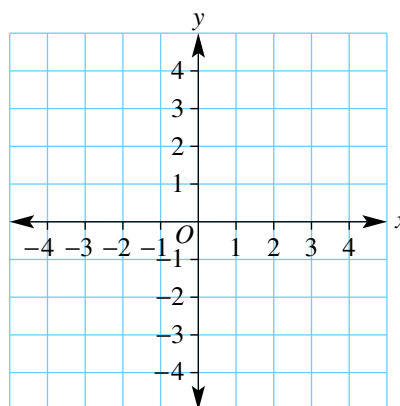

KEY IDEAS

- Two points are required to sketch a straight line graph. Often these points are the axes intercepts.
- The **y -intercept** is the point where the line intersects the y -axis (where $x = 0$).
 - Substitute $x = 0$ to find the y -intercept.
- The **x -intercept** is the point where the line intersects the x -axis (where $y = 0$).
 - Substitute $y = 0$ to find the x -intercept.

Example: $2x + 3y = 6$

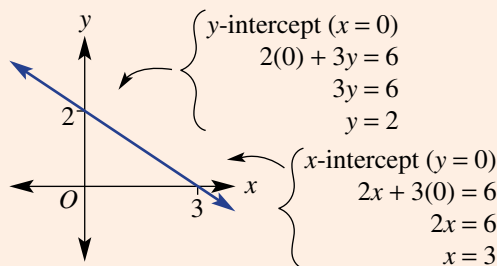

BUILDING UNDERSTANDING

- 1 Mark the following x - and y -intercepts on a set of axes and join in a straight line.
- a x -intercept: $(-2, 0)$, y -intercept: $(0, 3)$
 b x -intercept: $(4, 0)$, y -intercept: $(0, 6)$
- 2 a Find the value of y in these equations.
 i $2y = 6$ ii $y = 3 \times 0 + 4$ iii $-2y = 12$
 b Find the value of x in these equations.
 i $-4x = -40$ ii $0 = 2x - 2$ iii $\frac{1}{2}x = 3$
- 3 For these equations find the coordinates of the y -intercept by letting $x = 0$.
 a $x + y = 4$ b $x - y = 5$ c $2x + 3y = 9$
- 4 For these equations find the coordinates of the x -intercept by letting $y = 0$.
 a $2x - y = -4$ b $4x - 3y = 12$ c $y = 3x - 6$



Example 4 Sketching with intercepts

Sketch the graph of the following, showing the x - and y -intercepts.

a $2x + 3y = 6$

b $y = 2x - 6$

SOLUTION

a $2x + 3y = 6$

y -intercept (let $x = 0$):

$$2(0) + 3y = 6$$

$$3y = 6$$

$$y = 2$$

\therefore the y -intercept is at $(0, 2)$.

x -intercept (let $y = 0$):

$$2x + 3(0) = 6$$

$$2x = 6$$

$$x = 3$$

\therefore the x -intercept is at $(3, 0)$.

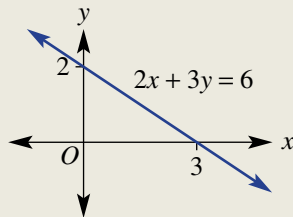

EXPLANATION

Only two points are required to generate a straight line. For the y -intercept, substitute $x = 0$ into the rule and solve for y by dividing each side by 3.

State the y -intercept.

Similarly to find the x -intercept, substitute $y = 0$ into the rule and solve for x .

State the x -intercept.

Mark and label the intercepts on the axes and sketch the graph by joining the two intercepts.

b $y = 2x - 6$

y -intercept (let $x = 0$):

$$y = 2(0) - 6$$

$$y = -6$$

\therefore the y -intercept is at $(0, -6)$.

x -intercept (let $y = 0$):

$$0 = 2x - 6$$

$$6 = 2x$$

$$x = 3$$

\therefore the x -intercept is at $(3, 0)$.

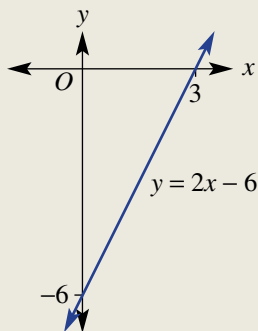

Substitute $x = 0$ for the y -intercept.

Simplify to find the y -coordinate.

Substitute $y = 0$ for the x -intercept. Solve the remaining equation for x by adding 6 to both sides and then divide both sides by 2.

Mark in the two intercepts and join to sketch the graph.

Now you try

Sketch the graph of the following, showing the x - and y -intercepts.

a $3x + 5y = 15$

b $y = 3x - 6$

Exercise 4B

FLUENCY

$1-2(\frac{1}{2})$

$1-3(\frac{1}{2})$

$1-3(\frac{1}{3})$

Example 4a

1 Sketch the graph of the following, showing the x - and y -intercepts.

a $x + y = 2$

b $x - y = -2$

c $2x + y = 4$

d $3x - y = 9$

e $4x - 2y = 8$

f $3x + 2y = 6$

g $y - 3x = 12$

h $-5y + 2x = -10$

i $-x + 7y = 21$

Example 4b

2 Sketch the graph of the following, showing the x - and y -intercepts.

a $y = 3x + 3$

b $y = 2x + 2$

c $y = x - 5$

d $y = -x - 6$

e $y = -2x - 2$

f $y = -2x + 4$

3 Sketch the graph of each of the following mixed linear relations.

a $x + 2y = 8$

b $3x - 5y = 15$

c $y = 3x - 6$

d $3y - 4x - 12 = 0$

e $2x - y - 4 = 0$

f $2x - y + 5 = 0$

PROBLEM-SOLVING

4, 5

4, 5

5, 6

- 4 The distance d metres of a vehicle from an observation point after t seconds is given by the rule $d = 8 - 2t$.
- Find the distance from the observation point initially (at $t = 0$).
 - Find after what time t the distance d is equal to 0 (substitute $d = 0$).
 - Sketch a graph of d versus t between the d and t intercepts.
- 5 The height, h metres, of a lift above the ground after t seconds is given by $h = 100 - 8t$.
- How high is the lift initially (at $t = 0$)?
 - How long does it take for the lift to reach the ground ($h = 0$)?
- 6 Find the x - and y -axis intercept coordinates of the graphs with the given rules. Write answers using fractions.
- | | | |
|-----------------|-----------------|------------------|
| a $3x - 2y = 5$ | b $x + 5y = -7$ | c $y - 2x = -13$ |
| d $y = -2x - 1$ | e $2y = x - 3$ | f $-7y = 1 - 3x$ |

REASONING

7

7, 8

8, 9

- 7 Use your algebra and fraction skills to help sketch graphs for these relations by finding x - and y -intercepts.
- | | | |
|-----------------------------------|-----------------------|----------------------------------|
| a $\frac{x}{2} + \frac{y}{3} = 1$ | b $y = \frac{8-x}{4}$ | c $\frac{y}{2} = \frac{2-4x}{8}$ |
|-----------------------------------|-----------------------|----------------------------------|
- 8 Explain why the graph of the equation $ax + by = 0$ must pass through the origin for any values of the constants a and b .
- 9 Write down the rule for the graph with these axes intercepts. Write the rule in the form $ax + by = d$.
- $(0, 4)$ and $(4, 0)$
 - $(0, 2)$ and $(2, 0)$
 - $(0, -3)$ and $(3, 0)$
 - $(0, 1)$ and $(-1, 0)$
 - $(0, k)$ and $(k, 0)$
 - $(0, -k)$ and $(-k, 0)$

ENRICHMENT: Intercept families

-

-

10

- 10 Find the coordinates of the x - and y -intercepts in terms of the constants a , b and c for these relations.
- | | | |
|-----------------|--------------------------|---------------------------|
| a $ax + by = c$ | b $y = \frac{a}{b}x + c$ | c $\frac{ax - by}{c} = 1$ |
| d $ay - bx = c$ | e $ay = bx + c$ | f $a(x + y) = bc$ |



Using a CAS calculator 4B: Sketching straight lines

This activity is in the Interactive Textbook in the form of a printable PDF.

4C Lines with one intercept

LEARNING INTENTIONS

- To know that vertical and horizontal lines and lines through the origin have only one intercept
- To know the equation form of both vertical and horizontal lines
- To be able to sketch vertical and horizontal lines
- To know the form of a linear equation that passes through the origin
- To understand that a second point is needed to sketch lines that pass through the origin
- To be able to sketch lines that pass through the origin

Lines with one intercept include vertical lines, horizontal lines and lines that pass through the origin.



Linear relationships with graphs through $(0, 0)$ include:

- Fertiliser in kg = usage rate in kg/acre \times number of acres;
- annual interest = interest rate p.a. \times amount invested;
- weekly pay = pay rate in \$/h \times number of hours.

Lesson starter: What rule satisfies all points?

Here is one vertical and one horizontal line.

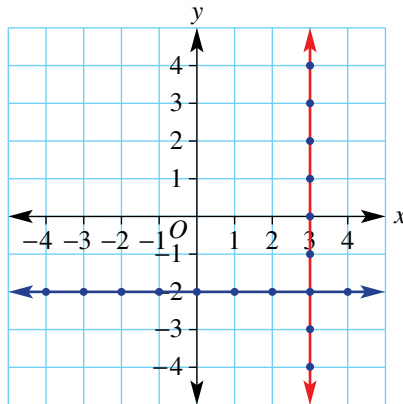

- For the vertical line shown, write down the coordinates of all the points shown as dots.
- What is always true for each coordinate pair?
- What simple equation describes every point on the line?
- For the horizontal line shown, write down the coordinates of all the points shown as dots.
- What is always true for each coordinate pair?
- What simple equation describes every point on the line?
- Where do the two lines intersect?

KEY IDEAS

■ Vertical line: $x = b$

- Parallel to the y -axis
- Equation of the form $x = b$, where b is a constant
- x -intercept is at $(b, 0)$

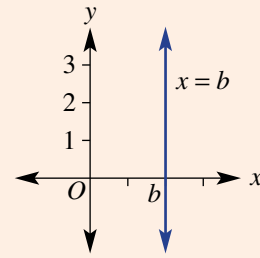

■ Horizontal line: $y = c$

- Parallel to the x -axis
- Equation of the form $y = c$, where c is a constant
- y -intercept is at $(0, c)$

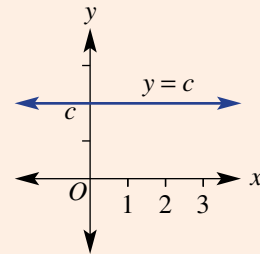

■ Lines through the origin $(0, 0)$: $y = mx$

- y -intercept is at $(0, 0)$
- x -intercept is at $(0, 0)$
- Substitute $x = 1$ or any other value of x to find a second point

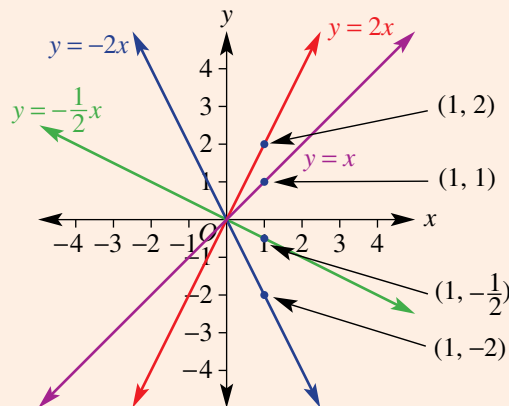

BUILDING UNDERSTANDING

1 State the coordinates of the x -intercept for these graphs.

a

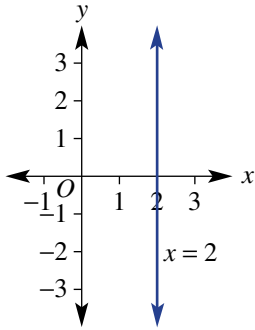

b

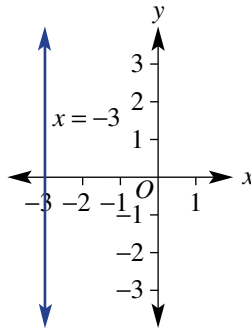

c

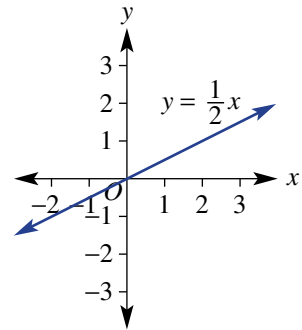

2 State the coordinates of the y -intercept for these graphs.

a

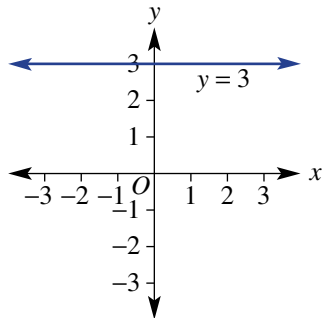

b

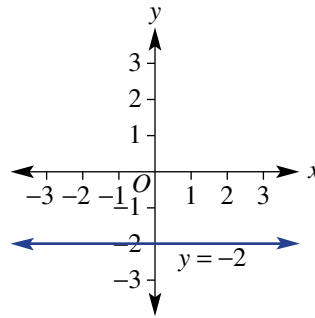

c

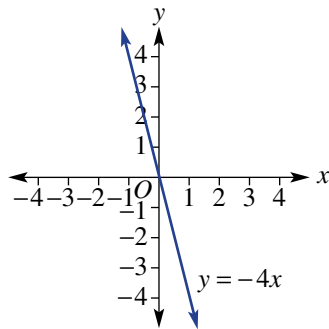

3 Find the value of y if $x = 1$ using these rules.

a $y = 5x$

b $y = \frac{1}{3}x$

c $y = -4x$

d $y = -0.1x$

**Example 5** Graphing vertical and horizontal lines

Sketch the graph of the following horizontal and vertical lines.

a $y = 3$

b $x = -4$

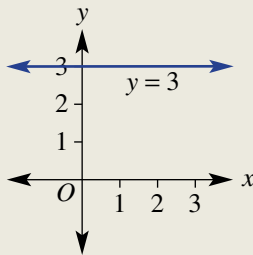
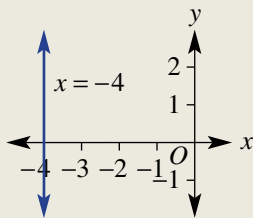
SOLUTION**a****b****EXPLANATION** y -intercept is at $(0, 3)$.Sketch a horizontal line through all points where $y = 3$. x -intercept is at $(-4, 0)$.Sketch a vertical line through all points where $x = -4$.**Now you try**

Sketch the graph of the following horizontal and vertical lines.

a $y = -1$

b $x = 3$

**Example 6** Sketching lines that pass through the originSketch the graph of $y = 3x$.**SOLUTION**The x - and the y -intercept are both at $(0, 0)$.Another point (let $x = 1$):

$$y = 3 \times (1)$$

$$y = 3$$

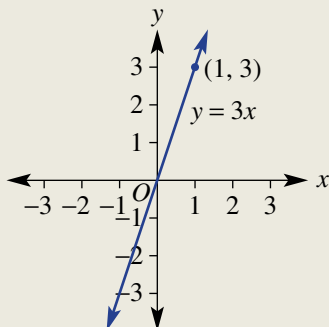
Another point is at $(1, 3)$.**EXPLANATION**The equation is of the form $y = mx$.As two points are required to generate the straight line, find another point by substituting $x = 1$.Other x -values could also be used.

Plot and label both points and sketch the graph by joining the points in a straight line.

Now you try

Sketch the graph of $y = -2x$.

Exercise 4C

FLUENCY

1-3($\frac{1}{2}$)

1-4($\frac{1}{2}$)

1-4($\frac{1}{2}$)

Example 5

1 Sketch the graph of the following horizontal and vertical lines.

- | | | | |
|-------------------|-------------------|-------------------|-------------------|
| a $x = 2$ | b $x = 5$ | c $y = 4$ | d $y = 1$ |
| e $x = -3$ | f $x = -2$ | g $y = -1$ | h $y = -3$ |

Example 6

2 Sketch the graph of the following linear relations that pass through the origin.

- | | | | |
|--------------------|--------------------|--------------------|-------------------|
| a $y = 2x$ | b $y = 5x$ | c $y = 4x$ | d $y = x$ |
| e $y = -4x$ | f $y = -3x$ | g $y = -2x$ | h $y = -x$ |

3 Sketch the graphs of these special lines all on the same set of axes and label with their equations.

- | | | | |
|-------------------|------------------------------|----------------------|---------------------|
| a $x = -2$ | b $y = -3$ | c $y = 2$ | d $x = 4$ |
| e $y = 3x$ | f $y = -\frac{1}{2}x$ | g $y = -1.5x$ | h $x = 0.5$ |
| i $x = 0$ | j $y = 0$ | k $y = 2x$ | l $y = 1.5x$ |

4 Give the equation of each of the following graphs.

a

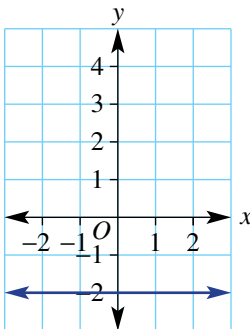

b

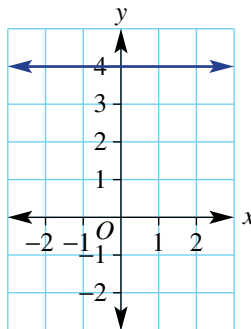

c

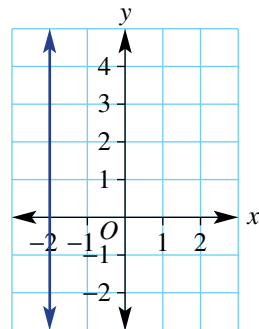

d

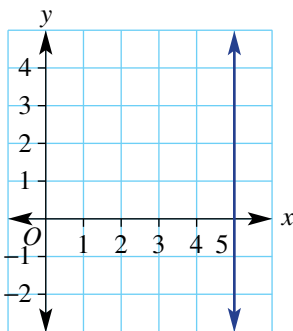

e

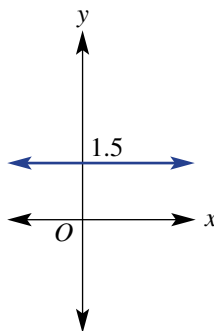

f

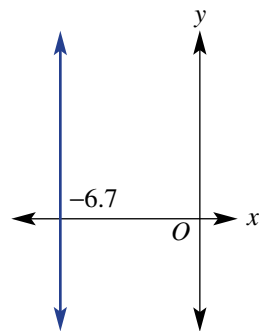

PROBLEM-SOLVING

5, 6

5, 6, $7(\frac{1}{2})$, 8 $5(\frac{1}{2})$, $7(\frac{1}{2})$, 8, 9

- 5 Find the equation of the straight line that is:
- parallel to the x -axis and passes through the point $(1, 3)$
 - parallel to the y -axis and passes through the point $(5, 4)$
 - parallel to the y -axis and passes through the point $(-2, 4)$
 - parallel to the x -axis and passes through the point $(0, 0)$.
- 6 If the surface of the sea is represented by the x -axis, state the equation of the following paths.
- A plane flies horizontally at 250 m above sea level. One unit is 1 metre.
 - A submarine travels horizontally 45 m below sea level. One unit is 1 metre.

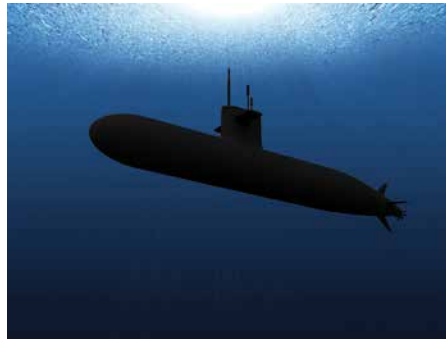

- 7 The graphs of these pairs of equations intersect at a point. Find the coordinates of the point.
- $x = 1, y = 2$
 - $x = -3, y = 5$
 - $x = 0, y = -4$
 - $x = 4, y = 0$
 - $y = -6x, x = 0$
 - $y = 3x, x = 1$
 - $y = -9x, x = 3$
 - $y = 8x, y = 40$
- 8 Find the area of the rectangle contained within the following four lines.
- $x = 1, x = -2, y = -3, y = 2$
 - $x = 0, x = 17, y = -5, y = -1$
- 9 The lines $x = -1, x = 3$ and $y = -2$ form three sides of a rectangle. Find the possible equation of the fourth line if:
- the area of the rectangle is:
 - 12 square units
 - 8 square units
 - 22 square units
 - the perimeter of the rectangle is:
 - 14 units
 - 26 units
 - 31 units

REASONING

10

10–11($\frac{1}{2}$)

10–12($\frac{1}{2}$)

10 The rules of the following graphs are of the form $y = mx$. Use the points marked with a dot to find m and hence state the equation.

a

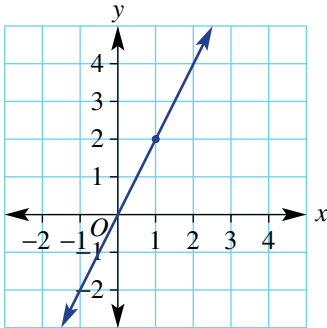

b

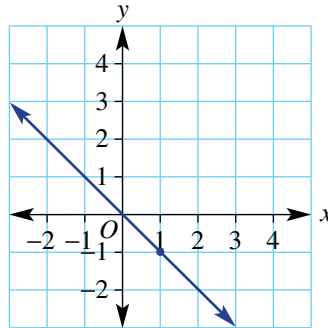

c

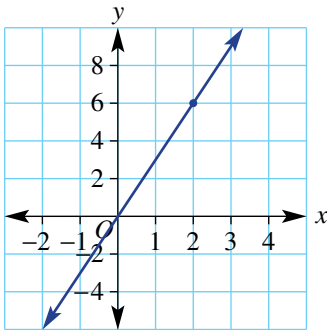

d

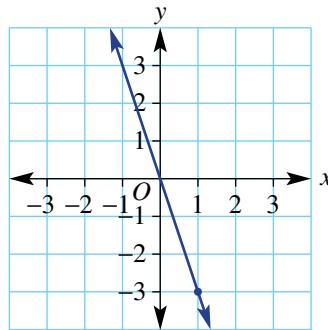

11 Find the equation of the line that passes through the origin and the given point.

a (1, 3)

b (1, 4)

c (1, -5)

d (1, -2)

12 Sketch the graph of each of the following by first making y or x the subject.

a $y - 8 = 0$

b $x + 5 = 0$

c $x + \frac{1}{2} = 0$

d $y - 0.6 = 0$

e $y + 3x = 0$

f $y - 5x = 0$

g $2y - 8x = 0$

h $5y + 7x = 0$

ENRICHMENT: Trisection

–

–

13–15

13 A vertical line, horizontal line and another line that passes through the origin all intersect at $(-1, -5)$. What are the equations of the three lines?

14 The lines $y = c$, $x = b$ and $y = mx$ all intersect at one point.

a State the coordinates of the intersection point.

b Find m in terms of c and b .

15 The area of a triangle formed by $x = 4$, $y = -2$ and $y = mx$ is 16 square units. Find the value of m given $m > 0$.

4D Gradient

LEARNING INTENTIONS

- To understand that the gradient is the ratio of the vertical change of a graph to its horizontal change between two points
- To understand that the gradient of a straight line is constant
- To know that the gradient can be positive, negative, zero or undefined
- To be able to find the gradient of a line using a graph or two given points

The gradient of a line is a measure of its slope. It is a number that describes the steepness of a line and is calculated by considering how far a line rises or falls between two points within a given horizontal distance. The horizontal distance between two points is called the *run* and the vertical distance is called the *rise*.

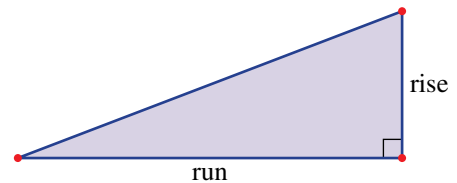

Lesson starter: Which line is the steepest?

The three lines shown below right connect the points A–H.

- Calculate the rise and run (working from left to right) and also the fraction $\frac{\text{rise}}{\text{run}}$ for these segments.
a AB **b** BC **c** BD **d** EF **e** GH
- What do you notice about the fractions $\frac{\text{rise}}{\text{run}}$ for parts **a**, **b** and **c**?
- How does the $\frac{\text{rise}}{\text{run}}$ for EF compare with the $\frac{\text{rise}}{\text{run}}$ for parts **a**, **b** and **c**? Which of the two lines is the steeper?
- Your $\frac{\text{rise}}{\text{run}}$ for GH should be negative. Why is this the case?
- Discuss whether or not GH is steeper than AD.

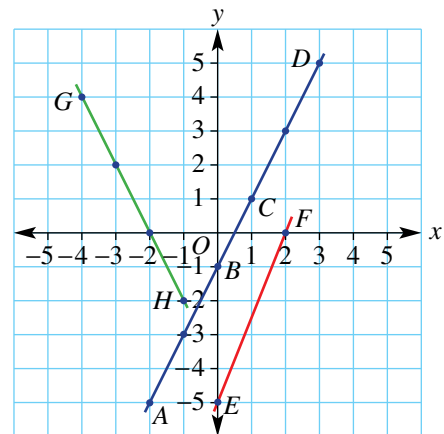

Use computer software (interactive geometry) to produce a set of axes and grid.

- Construct a line segment with endpoints on the grid. Show the coordinates of the endpoints.
- Calculate the rise (vertical distance between the endpoints) and the run (horizontal distance between the endpoints).
- Calculate the gradient as the *rise* divided by the *run*.
- Now drag the endpoints and explore the effect on the gradient.
- Can you drag the endpoints but retain the same gradient value? Explain why this is possible.
- Can you drag the endpoints so that the gradient is zero or undefined? Describe how this can be achieved.

KEY IDEAS

■ Gradient (m) = $\frac{\text{rise}}{\text{run}}$

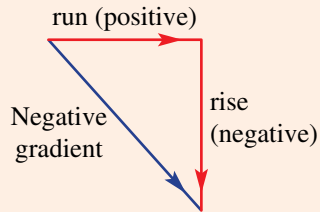
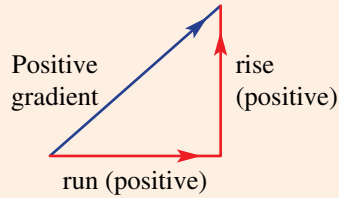

- When we work from left to right, the run is always positive.
- The gradient can be positive, negative, zero or undefined.
- A vertical line has an undefined gradient.

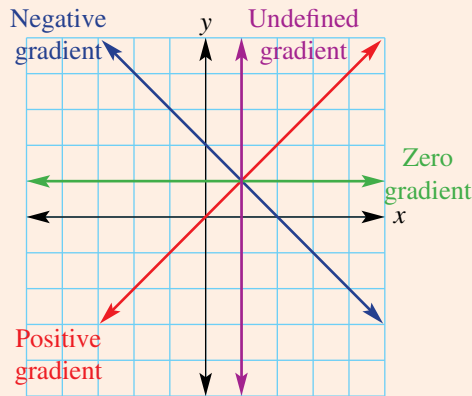

BUILDING UNDERSTANDING

1 Calculate the gradient using $\frac{\text{rise}}{\text{run}}$ for these lines. Remember to give a negative answer if the line is sloping downwards from left to right.

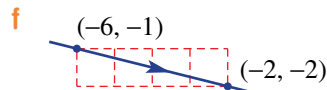
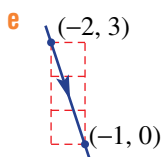
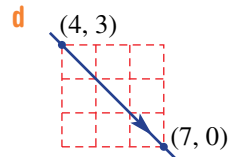
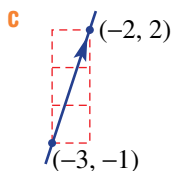
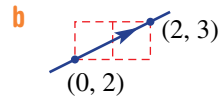
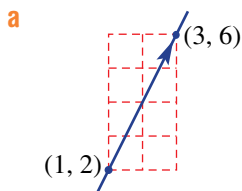

2 Use the words: positive, negative, zero or undefined to complete each sentence.

- a The gradient of a horizontal line is _____.
- b The gradient of the line joining (0, 3) with (5, 0) is _____.
- c The gradient of the line joining (-6, 0) with (1, 1) is _____.
- d The gradient of a vertical line is _____.

3 Use the gradient m ($= \frac{\text{rise}}{\text{run}}$) to find the missing value.

- a $m = 4$, rise = 8, run = ?
- b $m = 6$, rise = 3, run = ?
- c $m = \frac{3}{2}$, run = 4, rise = ?
- d $m = -\frac{2}{5}$, run = 15, rise = ?



Example 7 Finding the gradient of a line

For each graph, state whether the gradient is positive, negative, zero or undefined, then find the gradient where possible.

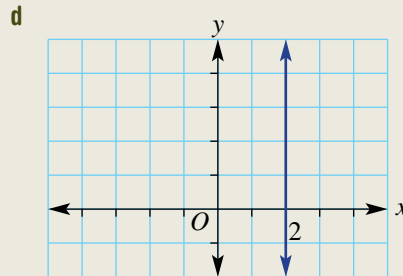
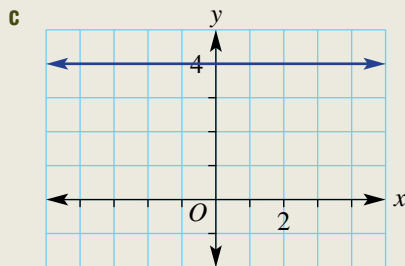
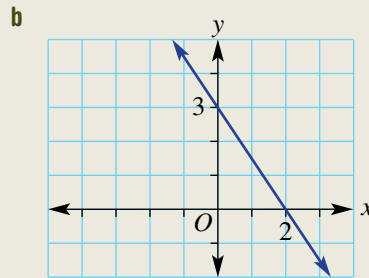
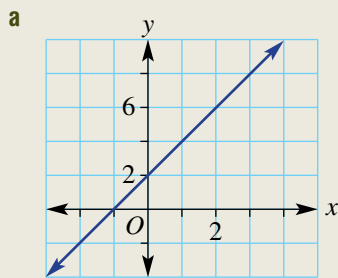

SOLUTION

a The gradient is positive.

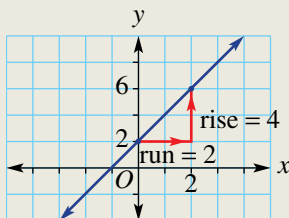

$$\begin{aligned} \text{Gradient} &= \frac{\text{rise}}{\text{run}} \\ &= \frac{4}{2} \\ &= 2 \end{aligned}$$

EXPLANATION

By inspection, the gradient will be positive since the graph rises from left to right. Select any two points and create a right-angled triangle to determine the rise and run. Substitute rise = 4 and run = 2.

b The gradient is negative.

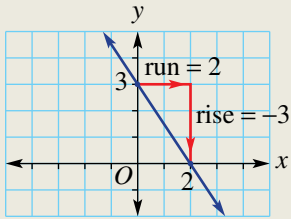

$$\begin{aligned}\text{Gradient} &= \frac{\text{rise}}{\text{run}} \\ &= \frac{-3}{2} \\ &= -\frac{3}{2}\end{aligned}$$

By inspection, the gradient will be negative since y -values decrease from left to right.

Rise = -3 and run = 2 .

c The gradient is 0.

The line is horizontal.

d The gradient is undefined.

The line is vertical.

Now you try

For each graph, state whether the gradient is positive, negative, zero or undefined, then find the gradient where possible.

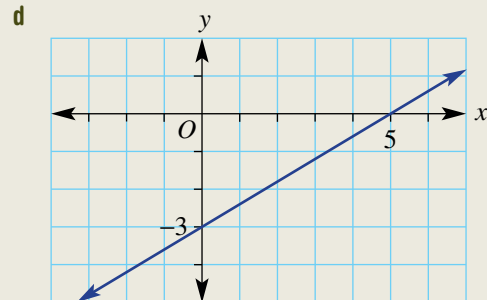
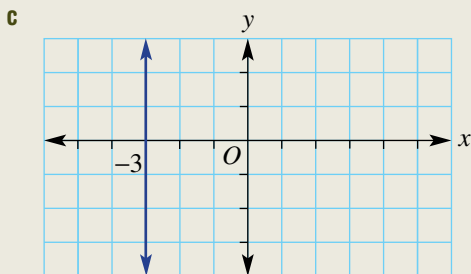
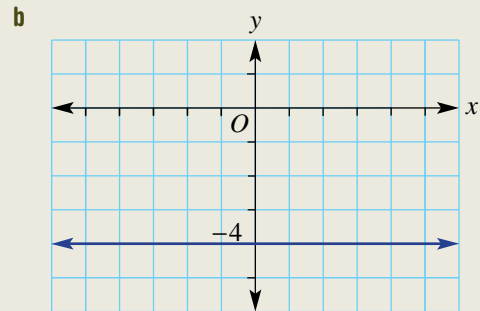
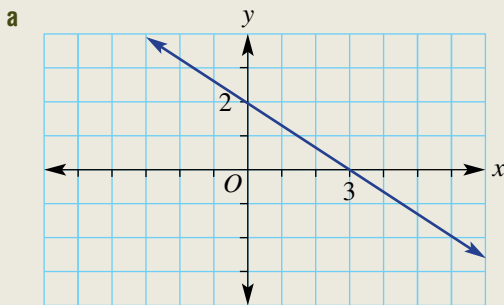



Example 8 Finding the gradient between two points

Find the gradient (m) of the line joining the given points.

a $A(3, 4)$ and $B(5, 6)$

b $A(-3, 6)$ and $B(1, -3)$

SOLUTION

$$\begin{aligned} \mathbf{a} \quad m &= \frac{\text{rise}}{\text{run}} \\ &= \frac{6-4}{5-3} \\ &= \frac{2}{2} \\ &= 1 \end{aligned}$$

EXPLANATION

Plot points to see a positive gradient and calculate rise and run.

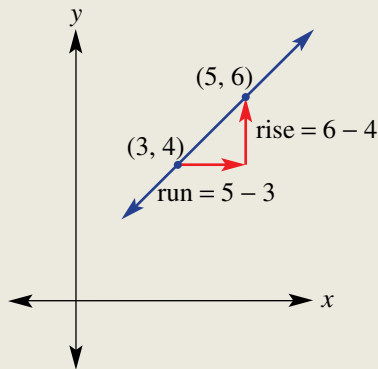

$$\begin{aligned} \mathbf{b} \quad m &= \frac{\text{rise}}{\text{run}} \\ &= \frac{-9}{4} \text{ or } -\frac{9}{4} \text{ or } -2.25 \end{aligned}$$

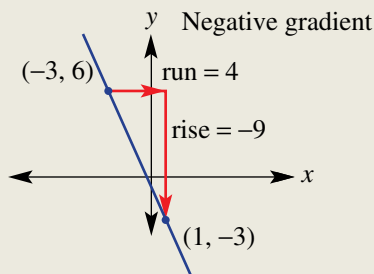

Now you try

Find the gradient (m) of the line joining the given points.

a $A(2, 6)$ and $B(3, 8)$

b $A(-5, 1)$ and $B(2, -3)$



Exercise 4D

FLUENCY

1, 2(1/2)

1, 2(1/2)

1-2(1/2), 3

Example 7

- 1 For each graph state whether the gradient is positive, negative, zero or undefined, then find the gradient where possible.

a

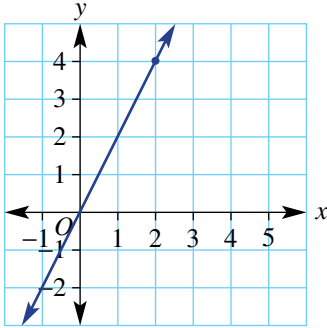

b

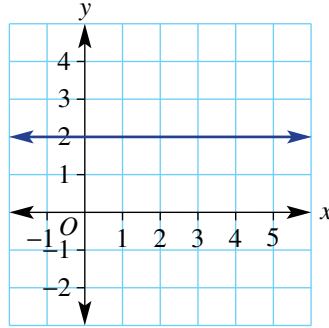

c

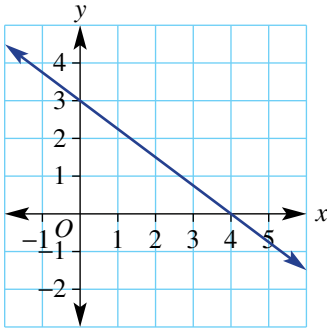

d

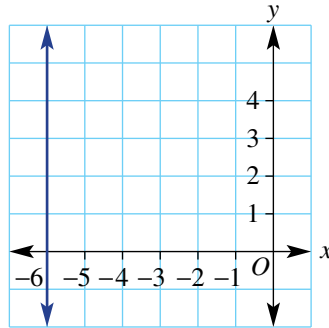

e

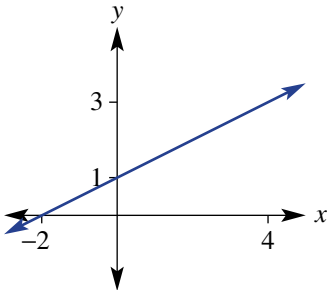

f

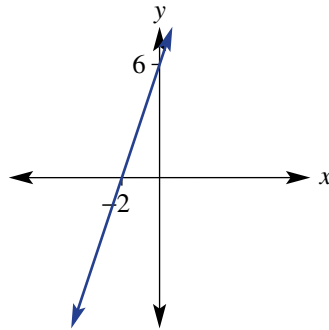

g

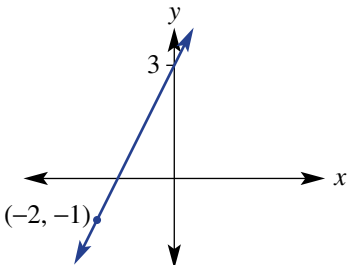

h

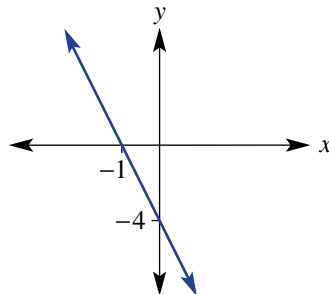

- Example 8**
- 2 Find the gradient of the lines joining the following pairs of points.
- | | | | | | |
|---|---------------------------|---|---------------------------|---|----------------------------|
| a | $A(2, 3)$ and $B(3, 5)$ | b | $C(2, 1)$ and $D(5, 5)$ | c | $E(1, 5)$ and $F(2, 7)$ |
| d | $G(-2, 6)$ and $H(0, 8)$ | e | $A(-4, 1)$ and $B(4, -1)$ | f | $C(-2, 4)$ and $D(1, -2)$ |
| g | $E(-3, 4)$ and $F(2, -1)$ | h | $G(-1, 5)$ and $H(1, 6)$ | i | $A(-2, 1)$ and $B(-4, -2)$ |
| j | $C(3, -4)$ and $D(1, 1)$ | k | $E(3, 2)$ and $F(0, 1)$ | l | $G(-1, 1)$ and $H(-3, -4)$ |
- 3 Find the gradient of the lines $A-F$ on this graph and grid.

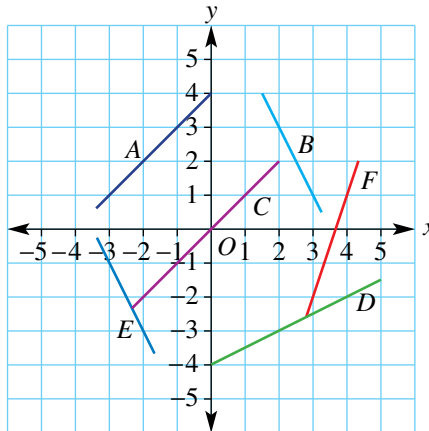

PROBLEM-SOLVING

4, 5

4-6

5-7

- 4 Find the gradient corresponding to the following slopes.
- A road falls 10 m for every 200 horizontal metres.
 - A cliff rises 35 metres for every 2 metres horizontally.
 - A plane descends 2 km for every 10 horizontal kilometres.
 - A submarine ascends 150 m for every 20 horizontal metres.
- 5 Find the missing number.
- The gradient joining the points $(0, 2)$ and $(1, ?)$ is 4.
 - The gradient joining the points $(?, 5)$ and $(1, 9)$ is 2.
 - The gradient joining the points $(-3, ?)$ and $(0, 1)$ is -1 .
 - The gradient joining the points $(-4, -2)$ and $(?, -12)$ is -4 .



- 6 A train climbs a slope with gradient 0.05. How far horizontally has the train travelled after rising 15 metres?
- 7 Complete this table showing the gradient, x -intercept and y -intercept for straight lines.

	A	B	C	D	E	F
Gradient	3	-1	$\frac{1}{2}$	$-\frac{2}{3}$	0.4	-1.25
x -intercept	-3			6	1	
y -intercept		-4	$\frac{1}{2}$			3

REASONING

8

8, 9

8, 9

8 Give a reason why a line with gradient $\frac{7}{11}$ is steeper than a line with gradient $\frac{3}{5}$.

9 The two points A and B shown here have coordinates (x_1, y_1) and (x_2, y_2) .

- Write a rule for the run using x_1 and x_2 .
- Write a rule for the rise using y_1 and y_2 .
- Write a rule for the gradient m using x_1, x_2, y_1 and y_2 .
- Use your rule to find the gradient between these pairs of points.
 - $(1, 1)$ and $(3, 4)$
 - $(0, 2)$ and $(4, 7)$
 - $(-1, 2)$ and $(2, -3)$
 - $(-4, -6)$ and $(-1, -2)$
- Does your rule work for points that include negative coordinates? Explain why.

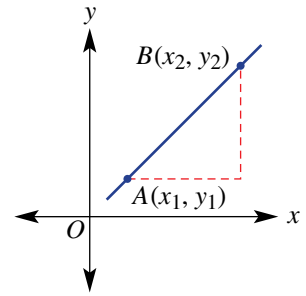

ENRICHMENT: Where does it hit?

-

-

10

10 The line here has gradient $-\frac{2}{3}$ which means that it falls 2 units for every 3 across. The y -intercept is at $(0, 3)$.

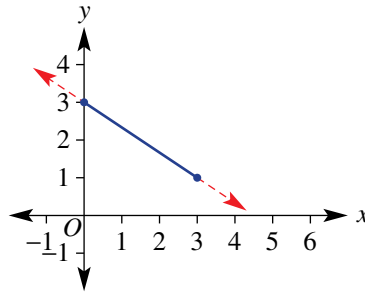

- Use the gradient to find the y -coordinate on the line where:
 - $x = 6$
 - $x = 9$
- What will be the x -intercept coordinates?
- What would be the x -intercept coordinates if the gradient was changed to the following?
 - $m = -\frac{1}{2}$
 - $m = -\frac{5}{4}$
 - $m = -\frac{7}{3}$
 - $m = -\frac{2}{5}$



4E Gradient and direct proportion

LEARNING INTENTIONS

- To understand what it means for two variables to be directly proportional
- To know the form of the equation that links two variables that are directly proportional
- To understand that the gradient of the graph equals the rate of change of one variable with respect to the other
- To be able to use a constant rate of change in a word problem to sketch a graph and form a linear rule

The connection between gradient, rate problems and direct proportion can be illustrated by the use of linear rules and graphs. If two variables are directly related, then the rate of change of one variable with respect to the other is constant. This implies that the rule linking the two variables is linear and can be represented as a straight line graph passing through the origin. The amount of water spraying from a sprinkler, for example, is directly proportional to the time since the sprinkler was turned on. The gradient of the graph of *water volume* versus *time* will equal the rate at which water is spraying from the sprinkler.



A bicycle's speed, v m/min, is in direct proportion to the number of pedal revolutions, P . For example, $v = 6P$ m/min for a wheel of circumference 2 m and gear ratio 3 : 1. If $P = 90$, $v = 540$ m/min, which is a speed of 32.4 km/h.

Lesson starter: Average speed

Over 5 hours, Sandy travels 420 km.

- What is Sandy's average speed for the trip?
- Is speed a rate? Discuss.
- Draw a graph of distance versus time, assuming a constant speed.
- Where does your graph intersect the axes and why?
- Find the gradient of your graph. What do you notice?
- Find a rule linking distance (d) and time (t).

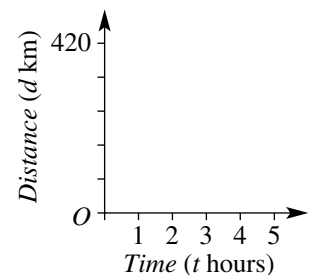

KEY IDEAS

■ If two variables are **directly proportional**:

- the rate of change of one variable with respect to the other is constant
- the graph is a straight line passing through the origin
- the rule is of the form $y = mx$ (or $y = kx$)
- the gradient (m) of the graph equals the rate of change of y with respect to x
- the letter m (or k) is called the constant of proportionality.

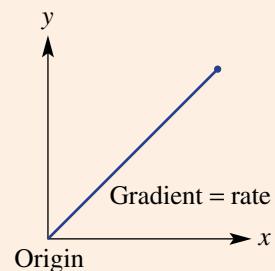

BUILDING UNDERSTANDING

1 This graph shows how far a cyclist travels over 4 hours.

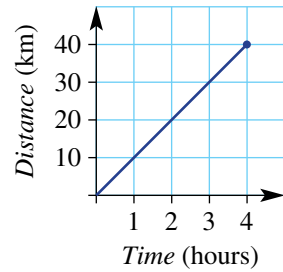

- a State how far the cyclist has travelled after:
 - i 1 hour
 - ii 2 hours
 - iii 3 hours.
- b State the speed of the cyclist (rate of change of distance over time).
- c Find the gradient of the graph.
- d What do you notice about your answers from parts b and c?

2 The rule linking the height of a plant and time is given by $h = 5t$ where h is in millimetres and t is in days.

- a Find the height of the plant after 3 days.
- b Find the time for the plant to reach:
 - i 30 mm
 - ii 10 cm.
- c State the missing values for h in this table.

t	0	1	2	3	4
h					

d Choose the correct graph that matches the information above.

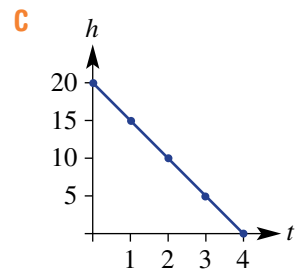
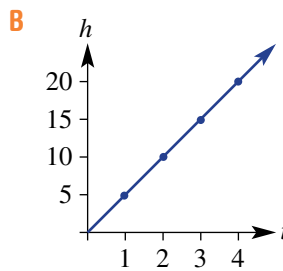
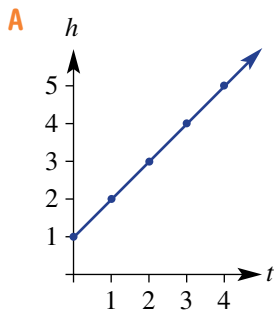

e Find the gradient of the graph.





Example 9 Exploring direct proportion

Water is poured into an empty tank at a constant rate. It takes 3 hours to fill the tank with 6000 litres.

- a What is the rate at which water is poured into the tank?
- b Draw a graph of volume (V litres) vs time (t hours) using $0 \leq t \leq 3$.
- c Find:
 - i the gradient of your graph
 - ii the rule for V .
- d Use your rule to find:
 - i the volume after 1.5 hours
 - ii the time to fill 5000 litres.

SOLUTION

a $6000 \text{ L in } 3 \text{ hours} = 2000 \text{ L/h}$

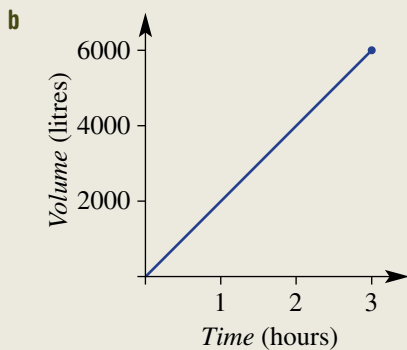

c i $\text{gradient} = \frac{6000}{3} = 2000$

ii $V = 2000t$

d i $V = 2000t$
 $= 2000 \times (1.5)$
 $= 3000 \text{ litres}$

ii $V = 2000t$
 $5000 = 2000t$
 $2.5 = t$

\therefore it takes $2\frac{1}{2}$ hours.

EXPLANATION

$6000 \text{ L per } 3 \text{ hours} = 2000 \text{ L per } 1 \text{ hour}$

Plot the two endpoints $(0, 0)$ and $(3, 6000)$ then join with a straight line.

The gradient is the same as the rate.

2000 L are filled for each hour.

Substitute $t = 1.5$ into your rule.

Substitute $V = 5000$ into the rule and solve for t .

Now you try

On a long-distance journey a car travels 450 km in 5 hours .

- a What is the rate of change of distance over time (i.e. speed)?
- b Draw a graph of distance ($d \text{ km}$) versus time ($t \text{ hours}$) using $0 \leq t \leq 5$.
- c Find:
 - i the gradient of your graph
 - ii the rule for d .
- d Use your rule to find:
 - i the distance after 3.5 hours
 - ii the time to travel 135 km .

Exercise 4E

FLUENCY

1–3

1–4

2–4

Example 9

- 1 A 300 litre fish tank takes 3 hours to fill from a hose.
- What is the rate at which water is poured into the tank?
 - Draw a graph of volume (V litres) vs time (t hours) using $0 \leq t \leq 3$.
 - Find:
 - the gradient of your graph
 - the rule for V .
 - Use your rule to find:
 - the volume after 1.5 hours
 - the time to fill 200 litres.
- 2 A solar-powered car travels 100 km in 4 hours.
- What is the rate of change of distance over time (i.e. speed)?
 - Draw a graph of distance (d km) versus time (t hours) using $0 \leq t \leq 4$.
 - Find:
 - the gradient of your graph
 - the rule for d .
 - Use your rule to find:
 - the distance after 2.5 hours
 - the time to travel 40 km.
- 3 Write down a rule linking the given variables.
- I travel 600 km in 12 hours. Use d for distance in km and t for time in hours.
 - A calf grows 12 cm in 6 months. Use g for growth height in cm and t for time in months.
 - The cost of petrol is \$100 for 80 litres. Use $\$C$ for cost and n for the number of litres.
 - The profit is \$10000 for 500 tonnes. Use $\$P$ for profit and t for the number of tonnes.
- 4 Use the gradient to find the rate of change of distance over time (speed) for these graphs. Use the units given on each graph.

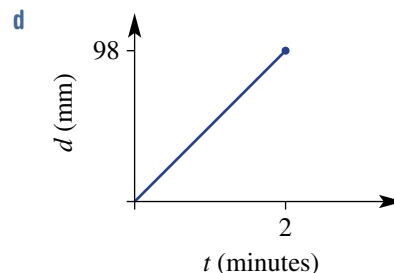
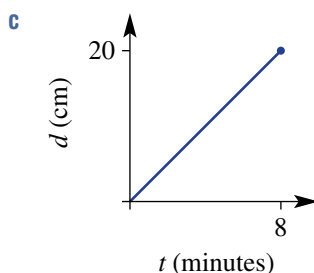
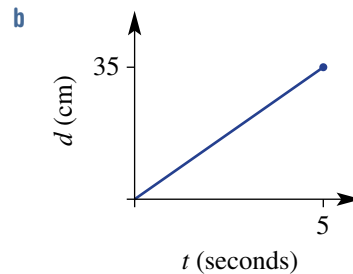
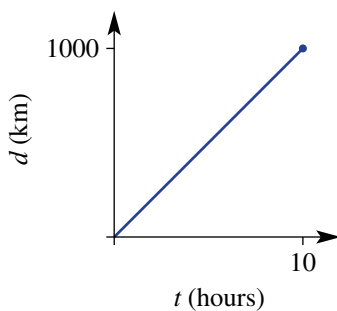

PROBLEM-SOLVING

5, 6

5–7

7, 8

- 5 The trip computer for a car shows that the fuel economy for a trip is 8.5 L per 100 km.
- How many litres would be used for 120 km?
 - How many litres would be used for 850 km?
 - How many kilometres could be travelled if the capacity of the car's petrol tank was 68 L?
- 6 Who is travelling the fastest?
- Mick runs 120 m in 20 seconds.
 - Sally rides 700 m in 1 minute.
 - Udhav jogs 2000 m in 5 minutes.
- 7 Which animal is travelling the slowest?
- A leopard runs 200 m in 15 seconds.
 - A jaguar runs 2.5 km in 3 minutes.
 - A panther runs 60 km in 1.2 hours.
- 8 An investment fund starts at \$0 and grows at a rate of \$100 per month. Another fund starts at \$4000 and reduces by \$720 per year. After how long will the funds have the same amount of money?



REASONING

9

9, 10

10–12

- 9 The circumference of a circle (given by $C = 2\pi r$) is directly proportional to its radius.
- Find the circumference of a circle with the given radius. Give an exact answer, e.g. 6π .
 - $r = 0$
 - $r = 2$
 - $r = 6$
 - Draw a graph of C against r for $0 \leq r \leq 6$. Use exact values for C .
 - Find the gradient of your graph. What do you notice?
- 10 Is the area of a circle directly proportional to its radius? Give a reason.
- 11 The base length of a triangle is 4 cm but its height h cm is variable.
- Write a rule for the area of this triangle.
 - What is the rate at which the area changes with respect to height h ?
- 12 Over a given time interval, is the speed of an object directly proportional to the distance travelled? Give a rule for speed (s) in terms of distance (d) if the time taken is 5 hours.

ENRICHMENT: Rate challenge

–

–

13, 14

- 13 Hose A can fill a bucket in 2 minutes and hose B can fill the same bucket in 3 minutes. How long would it take to fill the bucket if both hoses were used at the same time?
- 14 A river is flowing downstream at a rate of 2 km/h. Murray can swim at a rate of 3 km/h. Murray jumps in and swims downstream for a certain distance then turns around and swims upstream back to the start. In total it takes 30 minutes. How far did Murray swim downstream?



4F Gradient–intercept form

LEARNING INTENTIONS

- To know the gradient–intercept form of a straight line graph
- To be able to determine the gradient and y -intercept from the rule of a linear graph
- To be able to rearrange linear equations
- To be able to use the y -intercept and gradient to sketch a straight line graph

Shown here is the graph of the rule $y = 2x - 1$. It shows a gradient of 2 and a y -intercept at $(0, -1)$. The fact that these two numbers use numbers in the rule is no coincidence. This is why rules written in this form are called gradient–intercept form. Here are other examples of rules in this form:

$$y = -5x + 2, y = \frac{1}{2}x - 0.5 \text{ and } y = \frac{x}{5} + 20$$

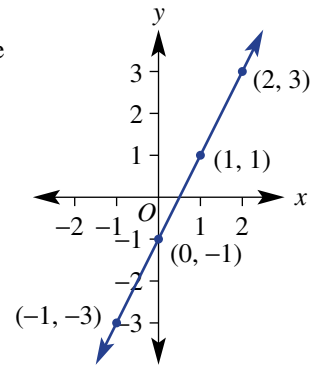

Lesson starter: Family traits

The graph of a linear relation can be sketched easily if you know the gradient and the y -intercept. If one of these is kept constant, we create a family of graphs.

Different y -intercepts and same gradient

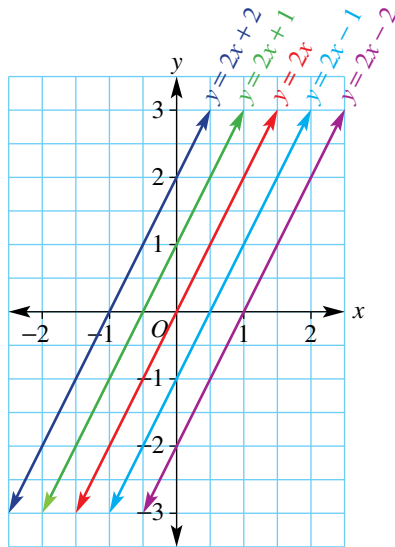

Different gradients and same y -intercept

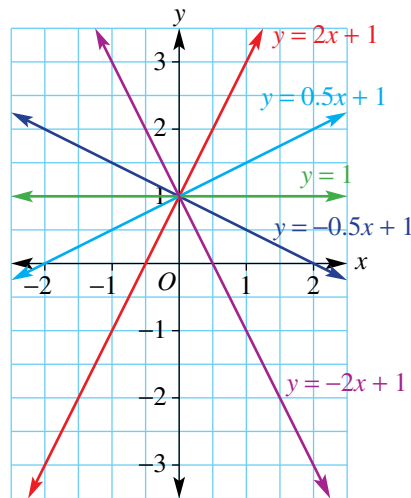

- For the first family, discuss the relationship between the y -intercept and the given rule for each graph.
- For the second family, discuss the relationship between the gradient and the given rule for each graph.

KEY IDEAS

- The **gradient–intercept form** of a straight line equation:

$$y = mx + c \quad (\text{or } y = mx + b \text{ depending on preference})$$

$$m = \text{gradient} \quad y\text{-intercept} = (0, c)$$

- If the y -intercept is $(0, 0)$, the equation becomes $y = mx$ and these graphs will therefore pass through the origin.

- To sketch a graph using the **gradient–intercept method**, locate the y -intercept and use the gradient to find a second point.

For example, if $m = \frac{2}{5}$, move 5 across (right) and 2 up.

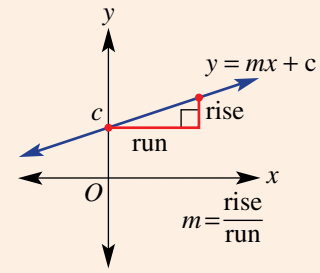

BUILDING UNDERSTANDING

- State a rule (in gradient–intercept form) for a straight line with the given properties.

a gradient = 2, y -intercept = $(0, 5)$	b gradient = -2 , y -intercept = $(0, 3)$
c gradient = -1 , y -intercept = $(0, -2)$	d gradient = $-\frac{1}{2}$, y -intercept = $(0, -10)$
- Substitute $x = -3$ to find the value of y for these rules.

a $y = x + 4$	b $y = 2x + 1$	c $y = -2x + 3$
---------------	----------------	-----------------
- Rearrange to make y the subject.

a $y - x = 7$	b $x + y = 3$	c $2y - 4x = 10$
---------------	---------------	------------------

Example 10 Stating the gradient and y -intercept

State the gradient and the y -intercept coordinates for the graphs of the following.

a $y = 2x + 1$

b $y = -3x$

SOLUTION

a $y = 2x + 1$

gradient = 2

y -intercept = $(0, 1)$

b $y = -3x$

gradient = -3

y -intercept = $(0, 0)$

EXPLANATION

The rule is given in gradient–intercept form.

The gradient is the coefficient of x .

The constant term is the y -coordinate of the y -intercept.

The gradient is the coefficient of x including the negative sign.

The constant term is not present, so $c = 0$.

Now you try

State the gradient and the y -intercept coordinates for the graphs of the following.

a $y = 5x - 2$

b $y = 6x$



Example 11 Rearranging linear equations

Rearrange these linear equations into the form shown in the brackets.

a $4x + 2y = 10$ ($y = mx + c$)

b $y = 4x - 7$ ($ax + by = d$)

SOLUTION

a $4x + 2y = 10$
 $2y = -4x + 10$
 $y = -2x + 5$

b $y = 4x - 7$
 $y - 4x = -7$
 i.e. $-4x + y = -7$
 or $4x - y = 7$

EXPLANATION

Subtract $4x$ from both sides. Here $10 - 4x$ is better written as $-4x + 10$.

Divide both sides by 2. For the right-hand side divide each term by 2.

Subtract $4x$ from both sides

Multiply both sides by -1 to convert between equivalent forms.

Now you try

Rearrange these linear equations into the form shown in the brackets.

a $10x + 2y = 20$ ($y = mx + c$)

b $y = -2x + 3$ ($ax + by = d$)



Example 12 Sketching linear graphs using the gradient and y-intercept

Find the value of the gradient and y-intercept for the following and sketch their graphs.

a $y = 2x - 1$

b $x + 2y = 6$

SOLUTION

a $y = 2x - 1$
 y-intercept = $(0, -1)$
 gradient = $2 = \frac{2}{1}$

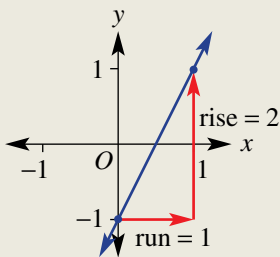

EXPLANATION

The rule is in gradient–intercept form so we can read off the gradient and the y-intercept.

Label the y-intercept at $(0, -1)$. From the gradient $\frac{2}{1}$, for every 1 across, move 2 up. From $(0, -1)$ this gives a second point at $(1, 1)$.

Mark and join the points to form a line.

Continued on next page

$$\begin{aligned} \text{b } x + 2y &= 6 \\ 2y &= -x + 6 \\ y &= \frac{-x + 6}{2} \\ &= -\frac{1}{2}x + 3 \end{aligned}$$

so the y -intercept is $(0, 3)$

$$m = -\frac{1}{2} = \frac{-1}{2}$$

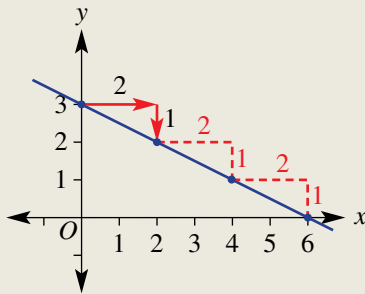

Rewrite in the form $y = mx + c$ to read off the gradient and y -intercept.

Make y the subject by subtracting x from both sides and then dividing both sides by 2.

$\frac{-x}{2}$ is the same as $-\frac{1}{2}x$ and $6 \div 2 = 3$.

Link the negative sign to the rise (-1) so the run is positive $(+2)$.

Mark the y -intercept at $(0, 3)$ then from this point move 2 right and 1 down to give a second point at $(2, 2)$.

Note that the x -intercept will be at $(6, 0)$. If the gradient is $-\frac{1}{2}$ then a run of 6 gives a fall of 3.

Now you try

Find the value of the gradient and y -intercept for the following and sketch their graphs.

a $y = 3x - 2$

b $2x - 5y = 10$

Exercise 4F

FLUENCY

$1-3(\frac{1}{2})$

$1-4(\frac{1}{2})$

$1-4(\frac{1}{3})$

Example 10

- 1 State the gradient and y -intercept coordinates for the graphs of the following.

a $y = 3x + 4$

b $y = -5x - 2$

c $y = -2x + 3$

d $y = \frac{1}{3}x - 4$

e $y = -4x$

f $y = 2x$

g $y = x$

h $y = -0.7x$

Example 11

- 2 Rearrange these linear equations into the form shown in the brackets.

a $2x + y = 3$ ($y = mx + c$)

b $-3x + y = -1$ ($y = mx + c$)

c $6x + 2y = 4$ ($y = mx + c$)

d $-3x + 3y = 6$ ($y = mx + c$)

e $y = 2x - 1$ ($ax + by = d$)

f $y = -3x + 4$ ($ax + by = d$)

g $3y = x - 1$ ($ax + by = d$)

h $7y - 2 = 2x$ ($ax + by = d$)

Example 12a

- 3 Find the gradient and y -intercept for the following and sketch their graphs.

a $y = x - 2$

b $y = 2x - 1$

c $y = \frac{1}{2}x + 1$

d $y = -\frac{1}{2}x + 2$

e $y = -3x + 3$

f $y = \frac{3}{2}x + 1$

g $y = -\frac{4}{3}x$

h $y = \frac{5}{3}x - \frac{1}{3}$

Example 12b 4 Find the gradient and y-intercept for the following and sketch their graphs. Rearrange each equation first.

a $x + y = 4$

b $x - y = 6$

c $x + 2y = 6$

d $x - 2y = 8$

e $2x - 3y = 6$

f $4x + 3y = 12$

g $x - 3y = -4$

h $2x + 3y = 6$

i $3x - 4y = 12$

j $x + 4y = 0$

k $x - 5y = 0$

l $x - 2y = 0$

PROBLEM-SOLVING

5

5, $6\frac{1}{2}$, 7

$6\frac{1}{2}$, 7

5 Match the following equations to the straight lines shown.

a $y = 3$

b $y = -2x - 1$

c $y = -2x - 4$

d $y = x + 3$

e $x = 2$

f $y = x + 2$

A

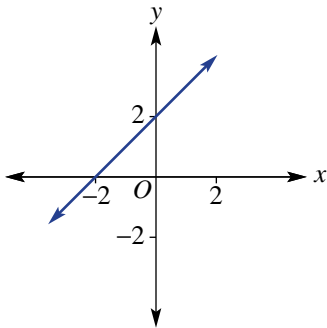

B

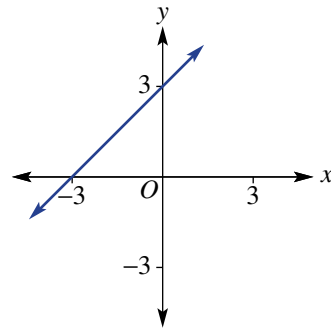

C

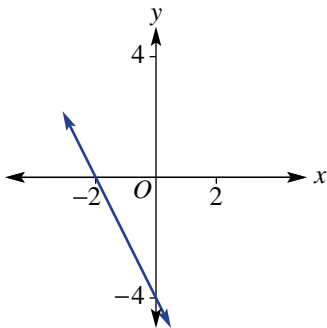

D

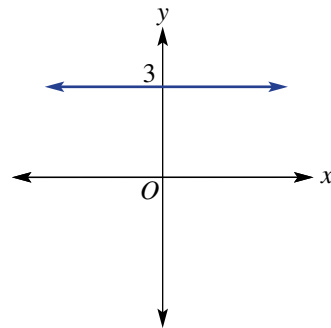

E

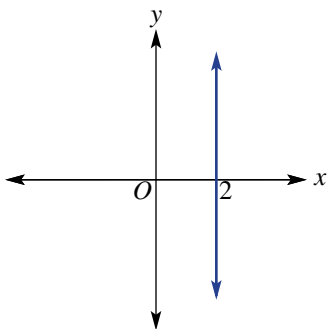

F

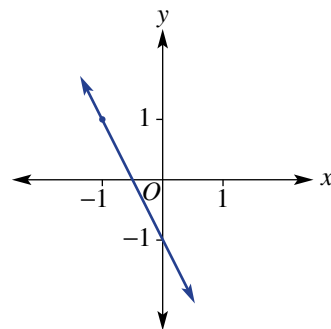

6 Sketch the graph of each of the following linear relations, by first finding the gradient and y-intercept.

a $5x - 2y = 10$

b $y = 6$

c $x + y = 0$

d $y = 5 - x$

e $y = \frac{x}{2} - 1$

f $4y - 3x = 0$

g $4x + y - 8 = 0$

h $2x + 3y - 6 = 0$

7 Which of these linear relations have a gradient of 2 and y-intercept at $(0, -3)$?

A $y = 2(x - 3)$

B $y = 3 - 2x$

C $y = \frac{3 - 2x}{-1}$

D $y = 2(x - 1.5)$

E $y = \frac{2x - 6}{2}$

F $y = \frac{4x - 6}{2}$

G $2y = 4x - 3$

H $-2y = 6 - 4x$

REASONING

8

8, 9

9, 10

8 Jeremy says that the graph of the rule $y = 2(x + 1)$ has gradient 2 and y-intercept $(0, 1)$.

a Explain his error.

b What can be done to the rule to help show the y-intercept?

9 A horizontal line has gradient 0 and y-intercept at $(0, k)$. Using gradient–intercept form, write the rule for the line.

10 Write the rule $ax + by = d$ in gradient–intercept form. Then state the gradient m and the y-intercept.

ENRICHMENT: The missing y-intercept

–

–

11

11 This graph shows two points $(-1, 3)$ and $(1, 4)$ with a gradient of $\frac{1}{2}$. By considering the gradient, the y-intercept can be calculated to be at $(0, 3.5)$ or $(0, \frac{7}{2})$ so $y = \frac{1}{2}x + \frac{7}{2}$.

Use this approach to find the rule of the line passing through these points.

a $(-1, 1)$ and $(1, 5)$

b $(-2, 4)$ and $(2, 0)$

c $(-1, -1)$ and $(2, 4)$

d $(-3, 1)$ and $(2, -1)$

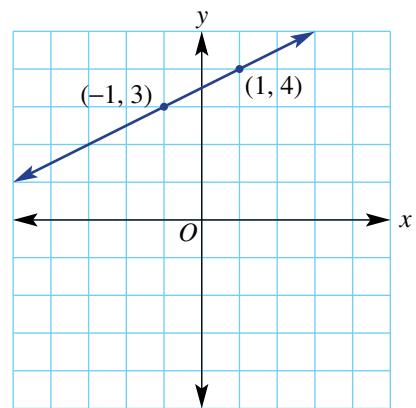

The equation of this straight section of mountain railway could be expressed in the form $y = mx + c$.

4A

1 Read off the coordinates of the x - and y -intercepts from this table and graph.

a

x	-2	-1	0	1	2	3
y	-8	-6	-4	-2	0	2

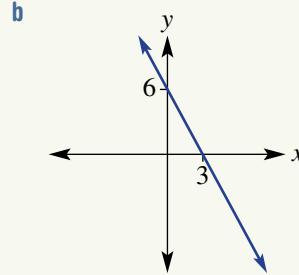

4A

2 Decide if the point $(-1, 3)$ is on the line with the given rules.

a $y = 2x - 1$

b $y = 2x + 5$

4B

3 Sketch the graph of the following relations, by first finding the x - and y -intercepts.

a $3x + 2y = 6$

b $y = \frac{3x}{4} + 3$

4C

4 Sketch the graphs of these special lines all on the same set of axes and label with their equations.

a $y = 2$

b $x = 4$

c $y = 2x$

4D

5 For each graph state whether the gradient is positive, negative, zero or undefined, then find the gradient where possible.

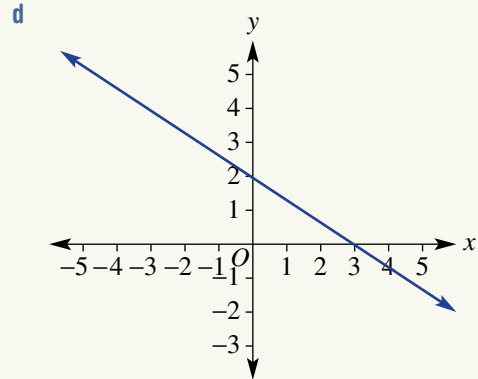
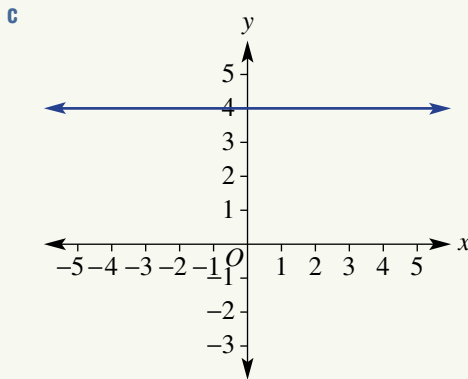
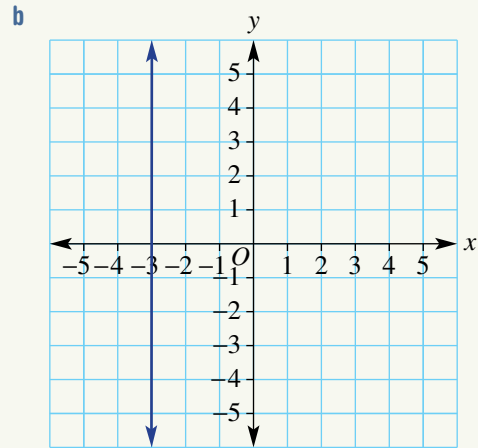
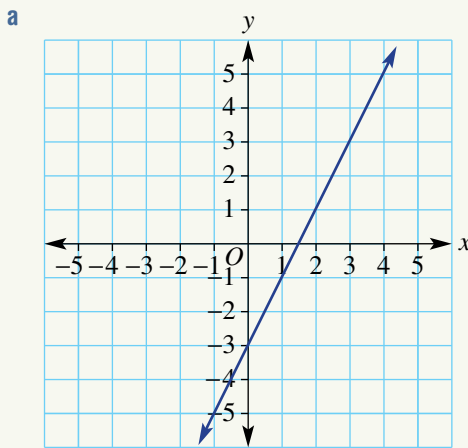

4D

6 Find the gradient (m) of the line joining the given points.

- a $P(2, 5)$ and $Q(4, 9)$
b $A(-3, 2)$ and $B(1, -10)$

4E

7 An empty tank on a water truck is being filled. It takes 4 hours to fill the tank with 6000 litres.

- a What is the rate at which water is poured into the tank?
b Draw a graph of volume (V litres) vs time (t hours) using $0 \leq t \leq 4$.
c Find:
i the gradient of your graph ii the rule for V .
d Use your rule to find:
i the volume after 3 hours ii the time to fill 5250 litres.



4F

8 Rearrange these linear equations into the form shown in the brackets.

- a $5x + y = 8$ ($y = mx + c$)
b $y = 3x - 5$ ($ax + by = d$)

4F

9 Find the value of the gradient and y-intercept for the following and use these to sketch their graphs.

- a $y = 3x - 2$
b $2x + 3y = 9$

4G Finding the equation of a line

LEARNING INTENTIONS

- To know that all straight line equations can be written in the form $y = mx + c$
- To know how to use the y -intercept and gradient to form a straight line equation
- To be able to find the equation of a line given two points

Using the gradient–intercept form, the rule (or equation) of a line can be found by calculating the value of the gradient and the y -intercept. Given a graph, the gradient can be calculated using two points. If the y -intercept is known, then the value of the constant in the rule is obvious. If it is not known, another point can be used to help find its value.



Engineers use linear equations to algebraically model straight supports, such as those in the Madrid airport. Using the slope of the support structure and a location in three dimensions, its linear equation can be found.

Lesson starter: But we don't know the y -intercept!

A line with the rule $y = mx + c$ passes through two points $(-1, 3)$ and $(1, -2)$.

- Using the information given, is it possible to find the value of m ? If so, calculate its value.
- The y -intercept is not given on the graph. Discuss what information could be used to find the value of the constant c in the rule. Is there more than one way you can find the y -intercept?
- Write the rule for the line.

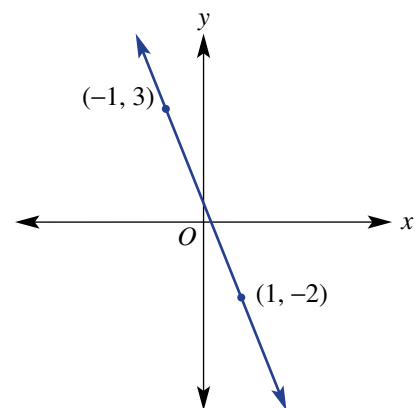

KEY IDEAS

- To find the equation of a line in gradient–intercept form $y = mx + c$, you need to find:
 - the value of the gradient (m) using $m = \frac{\text{rise}}{\text{run}}$
 - the value of the constant (c), by observing the y -intercept or by substituting another point.

BUILDING UNDERSTANDING

- 1 Substitute the given values of m and c into $y = mx + c$ to find the rule.
- a $m = 2, c = 5$ b $m = 4, c = -1$ c $m = -2, c = 5$
- 2 Substitute the point into the given rule and solve to find the value of c . For example, using $(3, 4)$, substitute $x = 3$ and $y = 4$ into the rule.
- a $(3, 4), y = x + c$ b $(-2, 3), y = 3x + c$ c $(3, -1), y = -2x + c$



Example 13 Finding the equation of a line given the y -intercept and another point

Determine the equation of the straight line shown here.

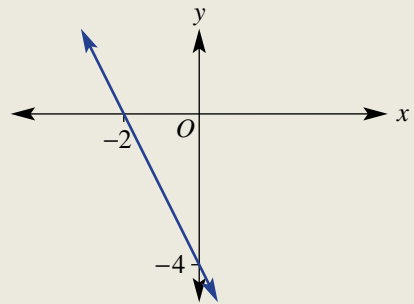
**SOLUTION**

$$\begin{aligned}
 y &= mx + c \\
 m &= \frac{\text{rise}}{\text{run}} \\
 &= \frac{-4}{2} \\
 &= -2
 \end{aligned}$$

$$\begin{aligned}
 \text{y-intercept} &= (0, -4) \\
 \therefore y &= -2x - 4
 \end{aligned}$$

EXPLANATION

Write down the general straight line equation.

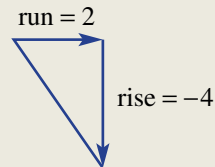

Read from the graph, so $c = -4$.

Substitute $m = -2$ and the value of c into the general equation.

Now you try

Determine the equation of the straight line shown here.

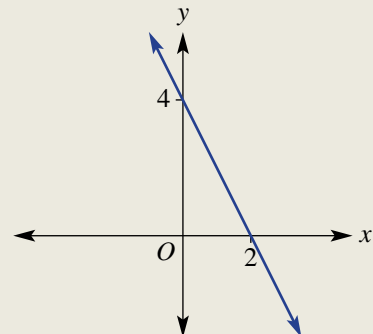



Example 14 Finding the equation of a line given the gradient and a point

Find the equation of the line which has a gradient m of $\frac{1}{3}$ and passes through the point $(9, 2)$.

SOLUTION

$$\begin{aligned} y &= mx + c \\ y &= \frac{1}{3}x + c \\ 2 &= \frac{1}{3}(9) + c \\ 2 &= 3 + c \\ -1 &= c \\ \therefore y &= \frac{1}{3}x - 1 \end{aligned}$$

EXPLANATION

Substitute $m = \frac{1}{3}$ into $y = mx + c$.

Since $(9, 2)$ is on the line, it must satisfy the equation $y = \frac{1}{3}x + c$; hence, substitute the point $(9, 2)$ where $x = 9$ and $y = 2$ to find c . Simplify and solve for c .

Write the equation in the form $y = mx + c$.

Now you try

Find the equation of the line which has a gradient m of $\frac{2}{3}$ and passes through the point $(-3, 4)$.

Exercise 4G

FLUENCY

1, 2–3($\frac{1}{2}$)1–3($\frac{1}{2}$)1($\frac{1}{2}$), 2–3($\frac{1}{3}$)

Example 13

1 Determine the equation of the following straight lines.

a

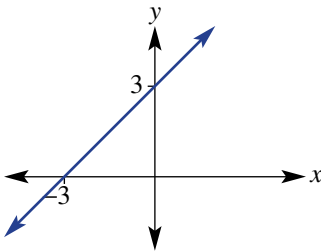

b

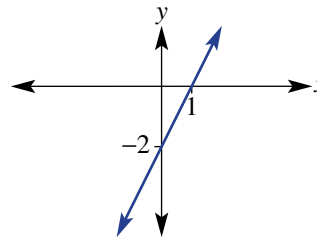

c

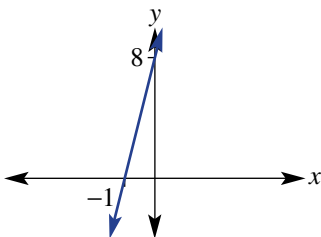

d

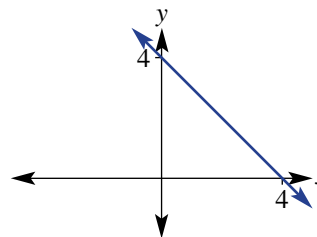

Example 14

2 Find the equation of the line for which the gradient and one point are given.

a $m = 3$, point $(1, 8)$

c $m = -3$, point $(2, 2)$

e $m = -3$, point $(-1, 6)$

g $m = -1$, point $(4, 4)$

i $m = -2$, point $(-1, 4)$

b $m = -2$, point $(2, -5)$

d $m = 1$, point $(1, -2)$

f $m = 5$, point $(2, 9)$

h $m = -3$, point $(3, -3)$

j $m = -4$, point $(-2, -1)$

3 Find the equation of these straight lines, which have fractional gradients.

a

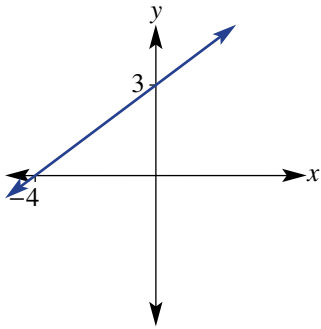

b

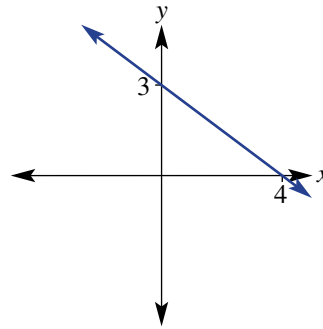

c

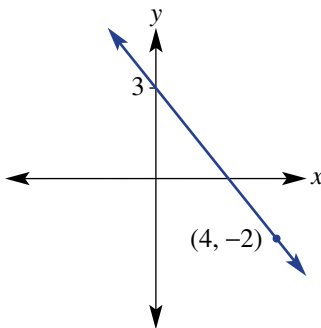

d

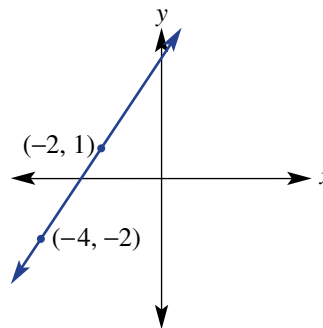

e

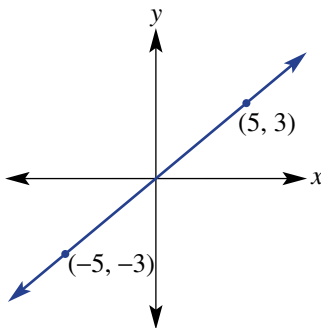

f

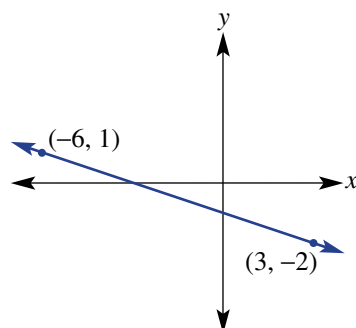

PROBLEM-SOLVING

 $4\left(\frac{1}{2}\right), 5$
 $4\left(\frac{1}{2}\right), 5-7$
 $4\left(\frac{1}{2}\right), 6-8$

4 For the line connecting the following pairs of points:

i find the gradient

a $(2, 6)$ and $(4, 10)$

c $(1, 7)$ and $(3, -1)$

ii find the equation.

b $(-3, 6)$ and $(5, -2)$

d $(-4, -8)$ and $(1, -3)$

- 5 A line has gradient -2 and y -intercept $(0, 5)$. Find its x -intercept coordinates.
- 6 A line passes through the points $(-1, -2)$ and $(3, 3)$. Find its x - and y -intercept coordinates.
- 7 The tap on a tank has been left on and water is running out. The volume of water in the tank after 1 hour is 100 L and after 5 hours the volume is 20 L. Assuming the relationship is linear, find a rule and then state the initial volume of water in the tank.



- 8 The coordinates $(0, 0)$ mark the take-off point for a rocket constructed as part of a science class. The positive x direction from $(0, 0)$ is considered to be east.
 - a Find the equation of the rocket's path if the rocket rises at a rate of 5 m vertically for every 1 m in an easterly direction.
 - b A second rocket is fired from 2 m vertically above the launch site of the first rocket. It rises at a rate of 13 m for every 2 m in an easterly direction. Find the equation describing its path.

REASONING	9	$9(1/2), 10$	10,11
------------------	---	--------------	-------

- 9 A line has equation $y = mx - 2$. Find the value of m if the line passes through:
 - a $(2, 0)$
 - b $(1, 6)$
 - c $(-1, 4)$
 - d $(-2, -7)$
- 10 A line with rule $y = 2x + c$ passes through $(1, 5)$ and $(2, 7)$.
 - a Find the value of c using the point $(1, 5)$.
 - b Find the value of c using the point $(2, 7)$.
 - c Does it matter which point you use? Explain.
- 11 A line passes through the origin and the point (a, b) . Write its equation in terms of a and b .

ENRICHMENT: The general rule	-	-	12
-------------------------------------	---	---	----

- 12 To find the equation of a line between two points (x_1, y_1) and (x_2, y_2) some people use the rule:

$$y - y_1 = m(x - x_1) \text{ where } m = \frac{y_2 - y_1}{x_2 - x_1}$$

Use this rule to find the equation of the line passing through these pairs of points. Write your answer in the form $y = mx + c$.

- a $(1, 2)$ and $(3, 6)$
- b $(0, 4)$ and $(2, 0)$
- c $(-1, 3)$ and $(1, 7)$
- d $(-4, 8)$ and $(2, -1)$
- e $(-3, -2)$ and $(4, 3)$
- f $(-2, 5)$ and $(1, -8)$

4H Midpoint and length of a line segment

LEARNING INTENTIONS

- To understand that a line segment has a midpoint and a length
- To know how to find the midpoint of a line segment between two points
- To understand how Pythagoras' theorem can be used to find the distance between two points
- To be able to find the length of a line segment

A line segment (or line interval) has a defined length and therefore must have a midpoint. Both the midpoint and length can be found by using the coordinates of the endpoints.



Industrial robots are programmed with the length algorithm to calculate the shortest straight line distance between two points in three dimensions, each located by coordinates (x, y, z) .

Lesson starter: Choosing a method

This graph shows a line segment between the points at $(-2, -1)$ and $(2, 3)$.

- What is the horizontal distance between the two points?
- What is the vertical distance between the two points?
- What is the x -coordinate of the point halfway along the line segment?
- What is the y -coordinate of the point halfway along the line segment?
- Discuss and explain a method for finding the midpoint of a line segment.
- Discuss and explain a method for finding the length of a line segment.

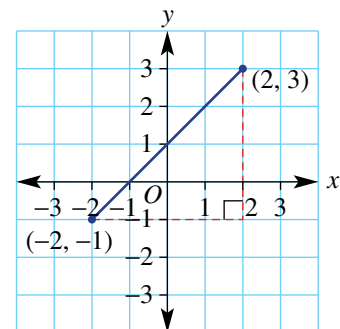

Using graphing software or interactive geometry software, produce a line segment like the one shown above. Label the coordinates of the endpoints and the midpoint. Also find the length of the line segment. Now drag one or both of the endpoints to a new position.

- Describe how the coordinates of the midpoint relate to the coordinates of the endpoints. Is this true for all positions of the endpoints that you choose?
- Now use your software to calculate the vertical distance and the horizontal distance between the two endpoints. Then square these lengths. Describe these squared lengths compared to the square of the length of the line segment. Is this true for all positions of the endpoints that you choose?

KEY IDEAS

■ **The midpoint** (M) of a line segment is the halfway point between the two endpoints.

- The x -coordinate of the midpoint is the average (mean) of the x -coordinates of the two endpoints.
- The y -coordinate of the midpoint is the average (mean) of the y -coordinates of the two endpoints.
- $M = \left(\frac{x_1 + x_2}{2}, \frac{y_1 + y_2}{2} \right)$

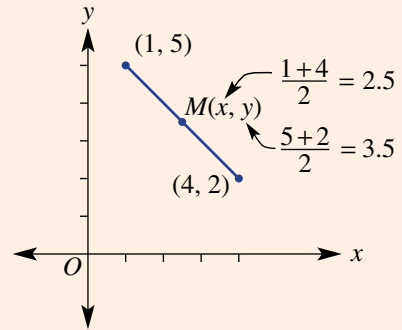

■ **The length of a line segment**

(or line interval) is found using Pythagoras' theorem. This gives the distance between any two points.

- The line segment is the hypotenuse (longest side) of a right-angled triangle.
- Find the horizontal distance by subtracting the lower x -coordinate from the upper x -coordinate.
- Find the vertical distance by subtracting the lower y -coordinate from the upper y -coordinate.

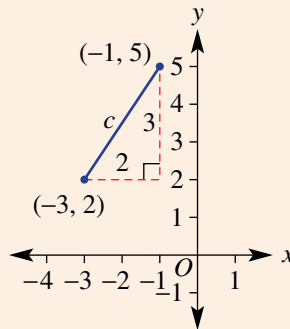

$$\begin{aligned} \text{horizontal distance} &= -1 - (-3) \\ &= 2 \\ \text{vertical distance} &= 5 - 2 \\ &= 3 \\ c^2 &= 2^2 + 3^2 \\ &= 13 \\ \therefore c &= \sqrt{13} \end{aligned}$$

BUILDING UNDERSTANDING

- Find the number that is 'halfway' between these pairs of numbers.

a 1, 7	b 5, 11	c -2, 4	d -6, 0
--------	---------	---------	---------
- Find the average (mean) of these pairs of numbers.

a 4, 7	b 0, 5	c -3, 0	d -4, -1
--------	--------	---------	----------
- Evaluate c correct to two decimal places where $c > 0$.

a $c^2 = 1^2 + 2^2$	b $c^2 = 5^2 + 7^2$	c $c^2 = 10^2 + 2^2$
---------------------	---------------------	----------------------

Example 15 Finding a midpoint of a line segment

Find the midpoint $M(x, y)$ of the line segment joining these pairs of points.

- a** (1, 0) and (4, 4) **b** (-3, -2) and (5, 3)

SOLUTION

a $x = \frac{1+4}{2} = 2.5$
 $y = \frac{0+4}{2} = 2$
 $\therefore M = (2.5, 2)$

EXPLANATION

Find the average (mean) of the x -coordinates and the y -coordinates of the two points.

Continued on next page

$$\begin{aligned} \text{b } x &= \frac{-3+5}{2} = 1 \\ y &= \frac{-2+3}{2} = 0.5 \\ \therefore M &= (1, 0.5) \end{aligned}$$

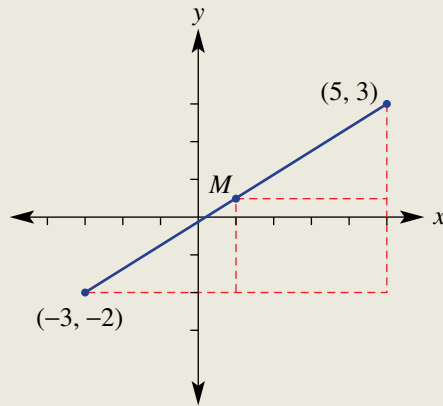

Now you try

Find the midpoint $M(x, y)$ of the line segment joining these pairs of points.

a (0, 2) and (4, 5)

b (-4, 1) and (2, -4)



Example 16 Finding the length of a line segment

Find the length of the segment joining $(-2, 2)$ and $(4, -1)$, correct to two decimal places.

SOLUTION

$$\begin{aligned} \text{Horizontal length} &= 4 - (-2) \\ &= 6 \\ \text{Vertical length} &= 2 - (-1) \\ &= 3 \end{aligned}$$

$$\begin{aligned} c^2 &= 6^2 + 3^2 \\ &= 45 \\ \therefore c &= \sqrt{45} \\ \therefore \text{length} &= 6.71 \text{ units (to 2 d.p.)} \end{aligned}$$

EXPLANATION

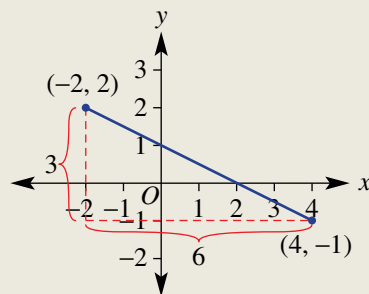

Apply Pythagoras' theorem $c^2 = a^2 + b^2$.
Round as required.

Now you try

Find the length of the segment joining $(-1, 5)$ and $(3, -2)$, correct to two decimal places.

Exercise 4H

FLUENCY

1–2(1/2)

1–2(1/2)

1–2(1/3)

Example 15

- 1 Find the midpoint $M(x, y)$ of the line segment joining these pairs of points.
- a (0, 0) and (6, 6)
 - b (0, 0) and (4, 4)
 - c (3, 0) and (5, 2)
 - d (-2, 0) and (0, 6)
 - e (-4, -2) and (2, 0)
 - f (1, 3) and (2, 0)
 - g (-3, 7) and (4, -1)
 - h (-2, -4) and (-1, -1)
 - i (-7, -16) and (1, -1)
 - j (-4, -3) and (5, -2)

Example 16



- 2 Find the length of the segment joining these pairs of points correct to two decimal places.
- a (1, 1) and (2, 6)
 - b (1, 2) and (3, 4)
 - c (0, 2) and (5, 0)
 - d (-2, 0) and (0, -4)
 - e (-1, 3) and (2, 1)
 - f (-2, -2) and (0, 0)
 - g (-1, 7) and (3, -1)
 - h (-4, -1) and (2, 3)
 - i (-3, -4) and (3, -1)

PROBLEM-SOLVING

3, 4

3–5

4–6

- 3 Find the missing coordinates in this table. M is the midpoint of points A and B .

A	B	M
(4, 2)		(6, 1)
	(0, -1)	(-3, 2)
	(4, 4)	(-1, 6.5)

- 4 A circle has centre (2, 1). Find the coordinates of the endpoint of a diameter if the other endpoint has these coordinates.
- a (7, 1)
 - b (3, 6)
 - c (-4, -0.5)

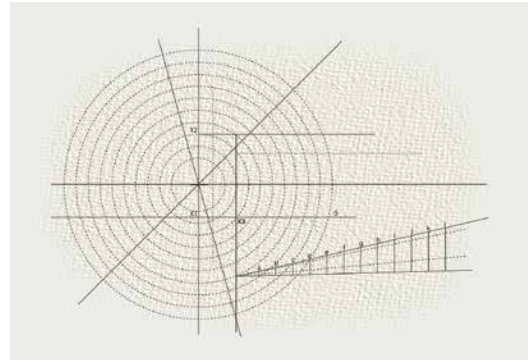

- 5 Find the perimeter of these shapes correct to one decimal place.
- a A triangle with vertices (-2, 0), (-2, 5) and (1, 3)
 - b A trapezium with vertices (-6, -2), (1, -2), (0, 4) and (-5, 4)
- 6 Find the coordinates of the four points which have integer coordinates and are a distance of $\sqrt{5}$ from the point (1, 2). (*Hint:* $5 = 1^2 + 2^2$.)

REASONING

7

7, 8

7, 8

- 7 A line segment has endpoints (x_1, y_1) and (x_2, y_2) and midpoint $M(x, y)$.
- a Write a rule for x , the x -coordinate of the midpoint.
 - b Write a rule for y , the y -coordinate of the midpoint.
 - c Test your rule to find the coordinates of M if $x_1 = -3, y_1 = 2, x_2 = 5$ and $y_2 = -3$.

- 8 A line segment has endpoints (x_1, y_1) and (x_2, y_2) . Assume $x_2 > x_1$ and $y_2 > y_1$.
- Write a rule for:
 - the horizontal distance between the endpoints
 - the vertical distance between the endpoints
 - the length of the segment.
 - Use your rule to show that the length of the segment joining $(-2, 3)$ with $(1, -3)$ is $\sqrt{45}$.

ENRICHMENT: Division by ratio

-

-

9

- 9 Looking from left to right, this line segment shows the point $P(-1, 0)$, which divides the segment in the ratio 1 : 2.

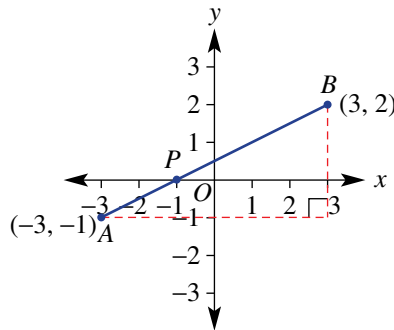

- What fraction of the horizontal distance between the endpoints is P from A ?
- What fraction of the vertical distance between the endpoints is P from A ?
- Find the coordinates of point P on the segment AB if it divides the segment in these ratios.
 - 2 : 1
 - 1 : 5
 - 5 : 1
- Find the coordinates of point P , which divides the segments with the given endpoints in the ratio 2 : 3.
 - $A(-3, -1)$ and $B(2, 4)$
 - $A(-4, 9)$ and $B(1, -1)$
 - $A(-2, -3)$ and $B(4, 0)$
 - $A(-6, -1)$ and $B(3, 8)$

41 Parallel and perpendicular lines EXTENDING

LEARNING INTENTIONS

- To understand what is meant by lines being parallel or perpendicular
- To know the relationship between the gradients of lines that are either parallel or perpendicular
- To be able to find the gradient of a perpendicular line
- To be able to find the equation of a line given a point and a line to which it is parallel or perpendicular

Parallel and perpendicular lines are commonplace in mathematics and in the world around us. Using parallel lines in buildings, for example, ensures that beams or posts point in the same direction. Perpendicular beams help to construct rectangular shapes, which are central in the building of modern structures.



The architect who designed this building has used linear equations to model the sets of parallel lines on its exterior. Shapes with parallel sides are arranged to emphasise the many parallel lines.

Lesson starter: How are they related?

This graph shows a pair of parallel lines and a line perpendicular to the other two. Find the equation of all three lines.

- What do you notice about the equations for the pair of parallel lines?
- What do you notice about the gradient of the line that is perpendicular to the other two lines?
- Write down the equations of three other lines that are parallel to $y = -2x$.
- Write down the equations of three other lines that are perpendicular to $y = -2x$.

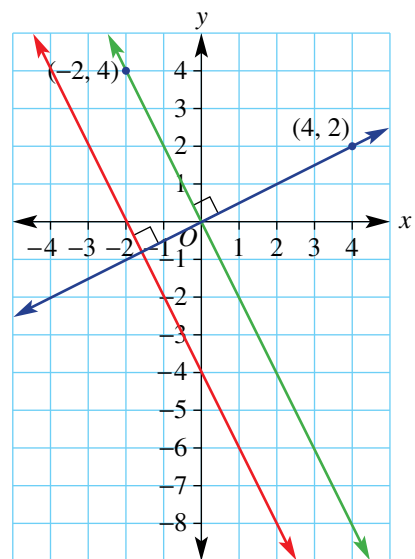

KEY IDEAS

- If two lines are **parallel** then they have the same gradient.
- If two **perpendicular** lines (at right angles) have gradients m_1 and m_2 then:

$$m_1 \times m_2 = -1 \text{ or } m_2 = -\frac{1}{m_1}$$

- The **negative reciprocal** of m_1 gives m_2 .

For example: If $m_1 = 4$ then $m_2 = -\frac{1}{4}$.

$$\text{If } m_1 = -\frac{2}{3} \text{ then } m_2 = \frac{-1}{\left(-\frac{2}{3}\right)} = -1 \times \left(-\frac{3}{2}\right) = \frac{3}{2}.$$

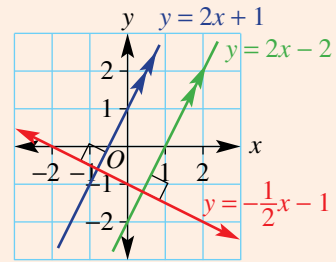

BUILDING UNDERSTANDING

- Decide if the pairs of lines with these equations are parallel (have the same gradient).
 - $y = 3x - 1$ and $y = 3x + 4$
 - $y = 7x - 2$ and $y = 2x - 7$
 - $y = x + 4$ and $y = x - 3$
 - $y = \frac{1}{2}x - 1$ and $y = -\frac{1}{2}x + 2$
- Two perpendicular lines with gradients m_1 and m_2 are such that $m_2 = -\frac{1}{m_1}$. Find m_2 for the given values of m_1 .
 - $m_1 = 5$
 - $m_1 = -3$
- Decide if the pairs of lines with these equations are perpendicular (i.e. whether $m_1 \times m_2 = -1$).
 - $y = 4x - 2$ and $y = -\frac{1}{4}x + 3$
 - $y = 2x - 3$ and $y = \frac{1}{2}x + 4$
 - $y = -\frac{1}{2}x + 6$ and $y = -\frac{1}{2}x - 2$
 - $y = -\frac{1}{5}x + 1$ and $y = 5x + 2$



Example 17 Finding the equation of a parallel line

Find the equation of a line which is parallel to $y = 3x - 1$ and passes through $(0, 4)$.

SOLUTION

$$y = mx + c$$

$$m = 3$$

$$c = 4$$

$$\therefore y = 3x + 4$$

EXPLANATION

Since it's parallel to $y = 3x - 1$, the gradient is the same so $m = 3$.

The y -intercept is given in the question, so $c = 4$.

Now you try

Find the equation of a line which is parallel to $y = 4x + 3$ and passes through $(0, -2)$.



Example 18 Finding the equation of a perpendicular line

Find the equation of a line which is perpendicular to the line $y = 2x - 3$ and passes through $(0, -1)$.

SOLUTION

$$y = mx + c$$

$$m = -\frac{1}{2}$$

$$c = -1$$

$$y = -\frac{1}{2}x - 1$$

EXPLANATION

Since it is perpendicular to $y = 2x - 3$,

$$m_2 = -\frac{1}{m_1} = -\frac{1}{2}.$$

The y-intercept is given.

Now you try

Find the equation of a line which is perpendicular to the line $y = -3x + 1$ and passes through $(0, 4)$.

Exercise 4I

FLUENCY

1, 2($\frac{1}{2}$)1, 2($\frac{1}{2}$), 31, 2($\frac{1}{2}$), 3

Example 17 1 Find the equation of the line that is parallel to the given line and passes through the given point.

- a** $y = 4x + 2$, $(0, 8)$
b $y = -2x - 3$, $(0, -7)$
c $y = \frac{2}{3}x + 6$, $(0, -5)$
d $y = -\frac{4}{5}x - 3$, $(0, \frac{1}{2})$

Example 18 2 Find the equation of the line that is perpendicular to the given line and passes through the given point.

- a** $y = 3x - 2$, $(0, 3)$
b $y = 5x - 4$, $(0, 7)$
c $y = -2x + 3$, $(0, -4)$
d $y = -x + 7$, $(0, 4)$
e $y = -7x + 2$, $(0, -\frac{1}{2})$
f $y = x - \frac{3}{2}$, $(0, \frac{5}{4})$

- 3 **a** Write the equation of the line parallel to $y = 4$ which passes through these points.
i $(0, 1)$ **ii** $(-3, -2)$
b Write the equation of the line parallel to $x = -2$ which passes through these points.
i $(3, 0)$ **ii** $(-3, -3)$
c Write the equation of the line perpendicular to $y = -3$ which passes through these points.
i $(2, 0)$ **ii** $(0, 0)$
d Write the equation of the line perpendicular to $x = 6$ which passes through these points.
i $(0, 7)$ **ii** $(0, -\frac{1}{2})$

PROBLEM-SOLVING

4

4, 5

4($\frac{1}{2}$), 5, 6

- 4 Find the equation of the line which is:
- parallel to the line with equation $y = -3x - 7$ and passes through $(3, 0)$; remember to substitute the point $(3, 0)$ to find the value of the y -intercept
 - parallel to the line with equation $y = \frac{1}{2}x + 2$ and passes through $(1, 3)$
 - perpendicular to the line with equation $y = 5x - 4$ and passes through $(1, 6)$
 - perpendicular to the line with equation $y = -x - \frac{1}{2}$ and passes through $(-2, 3)$.
- 5 A right-angled isosceles triangle has vertices at $(0, 3)$, $(3, 0)$ and $(-3, 0)$. Find the equation of each side.

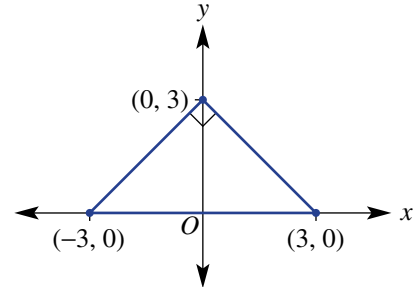

- 6 A parallelogram has two side lengths of 5 units. Three of its sides have equations $y = 0$, $y = 2$, $y = 2x$. Find the equation of the fourth side.

REASONING

7

7, 8

7, 8

- 7 a Using $m_2 = -\frac{1}{m_1}$, find the gradient of a line perpendicular to the line with the given gradient.
- $m_1 = \frac{2}{3}$
 - $m_1 = \frac{1}{5}$
 - $m_1 = -\frac{1}{7}$
 - $m_1 = -\frac{3}{11}$
- b If $m_1 = \frac{a}{b}$, find m_2 given $m_1 \times m_2 = -1$.
- 8 a Find the gradient of a line that is parallel to these lines.
- $2x + 4y = 9$
 - $3x - y = 8$
- b Find the gradient of a line that is perpendicular to these lines.
- $5x + 5y = 2$
 - $7x - y = -1$

ENRICHMENT: Perpendicular bisectors

-

-

9($\frac{1}{2}$)

- 9 If a line segment AB is cut by another line PQ at right angles through the midpoint (M) of AB , then PQ is called the perpendicular bisector. By first finding the midpoint of AB , find the equation of the perpendicular bisector of the segment connecting these points.
- $A(1, 1), B(3, 5)$
 - $A(0, 6), B(4, 0)$
 - $A(-2, 3), B(6, -1)$
 - $A(-6, -1), B(0, 2)$
 - $A(-1, 3), B(2, -4)$
 - $A(-6, -5), B(4, 7)$

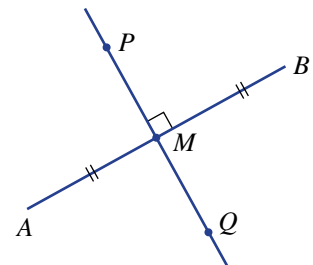

The following problems will investigate practical situations drawing upon knowledge and skills developed throughout the chapter. In attempting to solve these problems, aim to identify the key information, use diagrams, formulate ideas, apply strategies, make calculations and check and communicate your solutions.

Solar car battery

1 The battery power of two electric cars is analysed and compared by data scientists after testing the cars under average city driving conditions. The average distance covered in 1 hour under such conditions is 40 km.

- The Zet car battery is fully charged with 80 kWh reducing at a rate of 20 kWh per hour.
- The Spark car battery is fully charged with 60 kWh reducing at a rate of 12 kWh per hour.

The data scientists wish to investigate the life of each battery charge and compare the performance of each car's battery within the limits of average city driving conditions.

- Find a rule for the battery power P (kWh) over t hours for:
 - the Zet car
 - the Spark car.
- Find the battery power remaining (the value of P (kWh)) after 3 hours of average city driving for:
 - the Zet car
 - the Spark car.
- After how long will there be 40 kWh of power remaining for:
 - the Zet car?
 - the Spark car?
- Which car's battery has the longer travel time? Give reasons.
- If the cars are driven until their batteries are entirely depleted of power, how far could they travel under average city conditions? Recall that 40 km is covered in one hour.
- After how long will the cars have the same remaining battery power?
- A third car, the Watt, has a battery producing the following statistics:
 - 60 kWh after 1 hour of driving
 - 20 kWh after 4 hours of driving.

Find a rule for the Watt's remaining battery power P (kWh) after t hours and calculate how far this car can travel on one full charge.

Temperature vs coffee

2 Lydia owns a coffee shop and notices a decline in coffee sales as the maximum daily temperature rises over summer. She collects the following statistics by selecting 5 days within a two-month period.

Data point	1	2	3	4	5
Max. temperature	15	18	27	31	39
Coffee sales	206	192	165	136	110



Lydia wishes to analyse her collected data and see if there is a clear relationship between the maximum temperature and coffee sales. She wants to be better informed, so she can predict income from coffee sales in the future.

- a Copy and complete this graph for the 5 data points. Two points have been done for you.
- b Do you think there is a clear relationship between coffee sales and maximum temperature? Give a reason.
- c Using the coordinates of data points 1 and 5, find a rule linking coffee sales, C , and maximum temperature, T .
- d Using your rule from part c, predict the number of coffee sales for a day with the following maximum temperatures.
- i 25°C ii 35°C
- e Using your rule from part c, predict the maximum temperature for a day with the following number of coffee sales.
- i 150 ii 202
- f At what maximum temperature does your rule predict that there will be no coffee sales? Is this realistic?

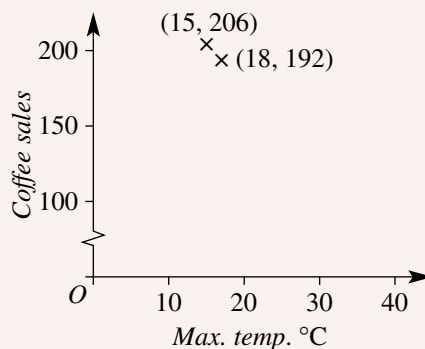

Rope course

- 3 Douglas is designing a rope obstacle course between two vertical trees which are 20 m apart. To help analyse his design, he draws the two trees represented by $x = -10$ and $x = 10$ on a Cartesian plane as shown.
- Two initial ropes AB and CD are used to start with. Douglas sets the heights of the points A , B , C and D as follows:
 $A = 3$ m, $B = 7$ m, $C = 9$ m, $D = 4$ m

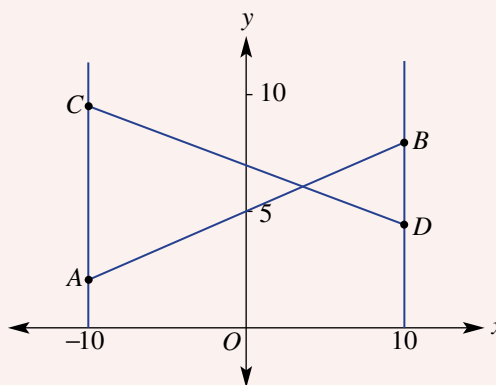

Douglas wants to be clear about his design so that he has a good idea about the amount of rope required and the positions of various key points on the obstacle course.

- a Find the lengths of the following ropes correct to two decimal places.
- i AB ii CD
- b Find the equation of the lines which describes the following ropes.
- i AB ii CD
- c Use an accurate graph to determine the approximate position at which the ropes intersect.
- d Douglas decides to place a third rope midway along and perpendicular to rope AB and run it from this position to the left tree.
- i Find an equation for this third rope. ii How high up the left tree will it reach?
 iii What will be the length of the rope correct to one decimal place?
- e Douglas decides that he wants a fourth rope running from the point D on the right tree to the left tree, joining somewhere between point A and the midpoint of AC . What are the minimum and maximum lengths of rope that he might need? Round to one decimal place where necessary.

4J Linear modelling

LEARNING INTENTIONS

- To understand whether or not a situation can be modelled by a linear rule
- To be able to form a linear rule to link two variables
- To be able to use a rule to sketch a graph and predict the value of one variable given the other

If a relationship between two variables is linear, the graph will be a straight line and the equation linking the two variables can be written in gradient–intercept form. The process of describing and using such line graphs and rules for the relationship between two variables is called linear modelling. A test car, for example, increasing its speed from 100 km/h to 200 km/h in 10 seconds with constant acceleration could be modelled by the rule $s = 10t + 100$. This rule could then be used to calculate the speed at different times in the test run.

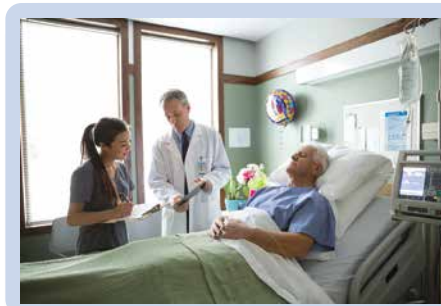
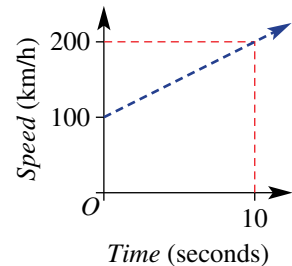

A doctor may prescribe 1400 mL of saline solution to be given intravenously over seven hours. The rate of infusion is 200 mL/h, and the remaining volume, V , after t hours has the linear equation: $V = -200t + 1400$.

Lesson starter: The test car

The graph shown above describes the speed of a racing car over a 10 second period.

- Explain why the rule is $s = 10t + 100$.
- Why might negative values of t not be considered for the graph?
- How could you accurately calculate the speed after 6.5 seconds?
- If the car continued to accelerate at the same rate, how could you accurately predict the car's speed after 13.2 seconds?

KEY IDEAS

- Many situations can often be **modelled** by using a linear rule or graph. The key elements of linear modelling include:
 - finding the rule linking the two variables
 - sketching a graph
 - using the graph or rule to predict or estimate the value of one variable given the other
 - finding the rate of change of one variable with respect to the other variable – this is equivalent to finding the gradient.

BUILDING UNDERSTANDING

- 1** A person gets paid \$50 plus \$20 per hour. Decide which rule describes the relationship between the pay P and number of hours worked, n .

<p>A $P = 50 + n$</p> <p>C $P = 50n + 20$</p>	<p>B $P = 50 + 20n$</p> <p>D $P = 20 + 50$</p>
---	--

- 2** The amount of money in a bank account is \$1000 and is increasing by \$100 per month.

 - a** Find the amount of money in the account after:

i 2 months	ii 5 months	iii 12 months
-------------------	--------------------	----------------------
 - b** State a rule for the amount of money A dollars after n months.

- 3** If $d = 5t - 4$, find:

<p>a d when $t = 10$</p> <p>c t when $d = 6$</p>	<p>b d when $t = 1.5$</p> <p>d t when $d = 11$</p>
--	--



Example 19 Applying linear relations

The deal offered by Bikeshare, a bicycle rental company, is a fixed charge of \$20 plus \$5 per hour of use.

- a** Write a rule for the total cost, C , of renting a bike for t hours.
- b** Sketch the graph of C versus t for $0 \leq t \leq 10$.
- c** What is the total cost when a bike is rented for 4 hours?
- d** If the total cost was \$50, for how many hours was a bike rented?

SOLUTION

- a** $C = 20 + 5t$
- b** C -intercept is 20

At $t = 10$, $C = 20 + 5(10)$
 $= 70$
 \therefore endpoint is $(10, 70)$

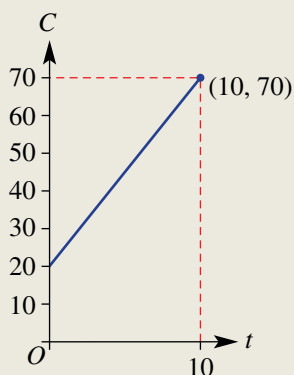

EXPLANATION

A fixed amount of \$20 plus \$5 for each hour.

Let $t = 0$ to find the C -intercept.

Letting $t = 10$ gives $C = 70$ and this gives the other endpoint.

Sketch the graph using the points $(0, 20)$ and $(10, 70)$.

$$\begin{aligned} \text{c } C &= 20 + 5t \\ &= 20 + 5(4) \\ &= 40 \end{aligned}$$

The cost is \$40.

Substitute $t = 4$ into the rule.

Answer the question using the correct units.

$$\begin{aligned} \text{d } C &= 20 + 5t \\ 50 &= 20 + 5t \\ 30 &= 5t \\ t &= 6 \end{aligned}$$

The bike was rented for 6 hours.

Write the rule and substitute $C = 50$. Solve the resulting equation for t by subtracting 20 from both sides then dividing both sides by 5.

Answer the question in words.

Now you try

A salesperson earns \$500 per week plus \$10 for each item sold.

- Write a rule for the total weekly wage, \$ W , if the salesperson makes x sales.
- Draw a graph of W versus x for $0 \leq x \leq 100$.
- How much does the salesperson earn in a week if they make 25 sales?
- In a particular week the salesperson earns \$850. How many sales did they make?

Exercise 4J

FLUENCY

1–3

1, 2, 4

2, 4

Example 19

- A sales representative earns \$400 a week plus \$20 for each sale she makes.
 - Write a rule which gives the total weekly wage, \$ W , if she makes x sales.
 - Draw a graph of W versus x for $0 \leq x \leq 40$.
 - How much does the sales representative earn in a particular week if she makes 12 sales?
 - In a particular week, the sales representative earns \$1000. How many sales did she make?
- A catering company charges \$500 for the hire of a marquee, plus \$25 per guest.
 - Write a rule for the cost, \$ C , of hiring a marquee and catering for n guests.
 - Draw a graph of C versus n for $0 \leq n \leq 100$.
 - How much would a party catering for 40 guests cost?
 - If a party cost \$2250, how many guests were catered for?
- A plumber charges a \$40 fee up-front and \$50 for each hour she works.
 - Find a linear equation for the total charge, \$ C , for n hours of work.
 - What is the cost if she works 4 hours?
 - If the plumber works on a job for two days and averages 6 hours per day, what will the total cost be?



- 4 The cost, $\$C$, of recording a music CD is $\$300$, plus $\$120$ per hour of studio time.
- Write a rule for the cost, $\$C$, of recording a CD requiring t hours of studio time.
 - Draw a graph of C versus t for $0 \leq t \leq 10$.
 - How much does a recording cost if it requires 6 hours of studio time?
 - If a recording cost $\$660$ to make, for how long was the studio used?

PROBLEM-SOLVING

5, 6

5, 6

6, 7

- 5 A petrol tank holds 66 litres of fuel. It contains 12 litres of petrol initially and the petrol pump fills it at 3 litres every 10 seconds.
- Write a linear equation for the amount of fuel (F litres) in the tank after t minutes.
 - How long will it take to fill the tank?
 - How long will it take to add 45 litres into the petrol tank?
- 6 A tank is initially full with 4000 litres of water and water is being used at a rate of 20 litres per minute.
- Write a rule for the volume, V litres, of water after t minutes.
 - Calculate the volume after 1.5 hours.
 - How long will it take for the tank to be emptied?
 - How long will it take for the tank to have only 500 litres?



- 7 A spa pool contains 1500 litres of water. It is draining at the rate of 50 litres per minute.
- Draw a graph of the volume of water, V litres, remaining after t minutes.
 - Write a rule for the volume of water at time t minutes.
 - What does the gradient represent?
 - What is the volume of water remaining after 5 minutes?
 - After how many minutes is the pool half empty?

REASONING

8

8

8, 9

- 8 The rule for distance travelled d km over a given time t hours for a moving vehicle is given by $d = 50 + 80t$.
- What is the speed of the vehicle?
 - If the speed was actually 70 km per hour, how would this change the rule? Give the new rule.
- 9 The altitude, h metres, of a helicopter t seconds after it begins its descent is given by $h = 350 - 20t$.
- At what rate is the helicopter's altitude decreasing?
 - At what rate is the helicopter's altitude increasing?
 - What is the helicopter's initial altitude?
 - How long will it take for the helicopter to reach the ground?
 - If instead the rule was $h = 350 + 20t$, describe what the helicopter would be doing.



ENRICHMENT: Sausages and cars

10, 11



10 Joanne organised a sausage sizzle to raise money for her science club. The hire of the barbecue cost Joanne \$20, and the sausages cost 40c each.

- a
 - i Write a rule for the total cost, $\$C$, if Joanne buys and cooks n sausages.
 - ii If the total cost was \$84, how many sausages did Joanne buy?
- b
 - i If Joanne sells each sausage for \$1.20, write a rule to find her profit, $\$P$, after buying and selling n sausages.
 - ii How many sausages must she sell to 'break even'?
 - iii If Joanne's profit was \$76, how many sausages did she buy and sell?



11 The directors of a car manufacturing company calculate that the set-up cost for a new component is \$6700 and each component would cost \$10 to make.

- a Write a rule for the total cost, $\$C$, of producing x components.
- b Find the cost of producing 200 components.
- c How many components could be produced for \$13 000?
- d Find the cost of producing 500 components.
- e If each component is able to be sold for \$20, how many must they sell to 'break even'?
- f Write a rule for the profit, $\$P$, in terms of x .
- g Write a rule for the profit, $\$T$, per component in terms of x .
- h Find x , the number of components, if the profit per component is to be \$5.

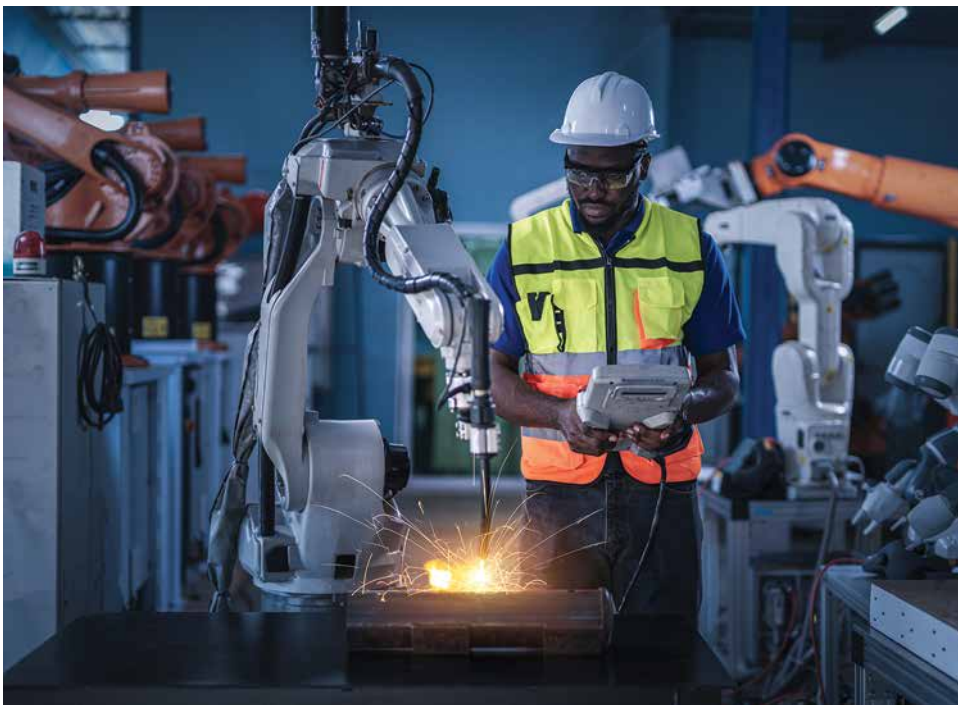

4K Graphical solutions to simultaneous equations

LEARNING INTENTIONS

- To understand that two different straight line graphs intersect at exactly one point unless the lines are parallel
- To know that the point of intersection of two lines is the solution of the simultaneous equations
- To know how to use the linear rules to check if a point is at the intersection of the two lines
- To be able to use the graphs of two straight lines to read off the coordinates of the point of intersection

To find a point that satisfies more than one equation involves finding the solution to simultaneous equations. An algebraic approach was considered in Chapter 2. A graphical approach involves locating an intersection point.



Revenue, R , and costs, C , often have linear equations, such as $R = 1000n$ and $C = 400n + 3000$, for producing n surfboards. The break-even point of a business is where these two linear graphs intersect; profit starts as revenue begins to exceed costs.

Lesson starter: Accuracy counts

Two graphs have the rules $y = x$ and $y = 2 - 4x$.

Accurately sketch the graphs of both rules on a large set of axes like the one shown.

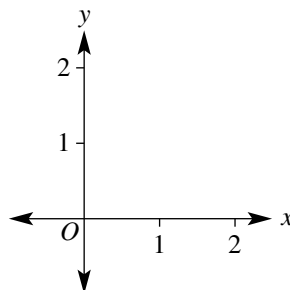

- State the x -value of the point at the intersection of your two graphs.
- State the y -value of the point at the intersection of your two graphs.
- Discuss how you could use the rules to check if your point is correct.
- If your point does not satisfy both rules, check the accuracy of your graphs and try again.

KEY IDEAS

- When we consider two or more equations at the same time, they are called **simultaneous equations**.
- To determine the **point of intersection** of two lines, we can use an accurate graph and determine its coordinates (x, y) .
- Two situations can arise for the intersection of two different lines.
 - The two graphs intersect at one point only and there is one solution (x, y) .
 - The point of intersection is simultaneously on both lines and is the **solution** to the simultaneous equations.
 - The two lines are parallel and there is no intersection.

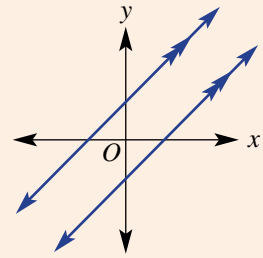
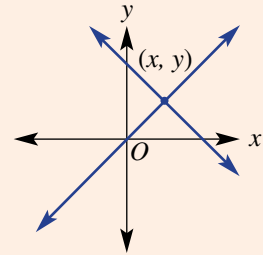

BUILDING UNDERSTANDING

1 Give the coordinates of the point of intersection for these pairs of lines.

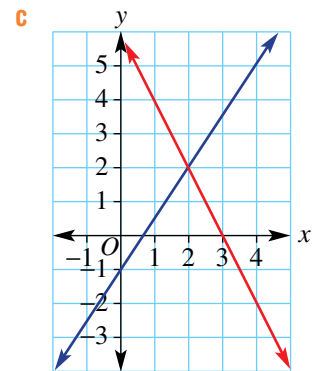
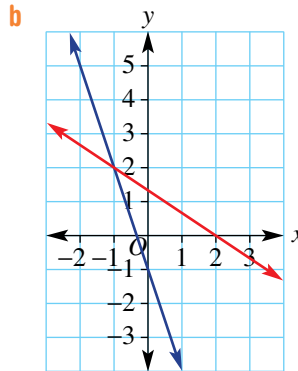
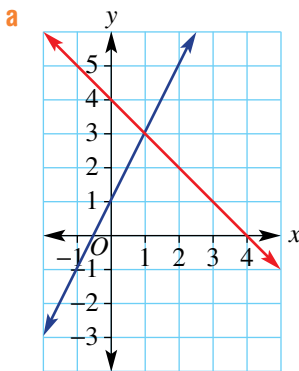

2 Decide if the point $(1, 3)$ satisfies these equations. (*Hint:* Substitute $(1, 3)$ into each equation to see if the equation is true.)

a $y = 2x + 1$

b $y = -x + 5$

c $y = -2x - 1$

d $y = 4x - 1$

3 Consider the two lines with the rules $y = 5x$ and $y = 3x + 2$ and the point $(1, 5)$.

a Substitute $(1, 5)$ into $y = 5x$. Does $(1, 5)$ sit on the line with equation $y = 5x$?

b Substitute $(1, 5)$ into $y = 3x + 2$. Does $(1, 5)$ sit on the line with equation $y = 3x + 2$?

c Is $(1, 5)$ the intersection point of the lines with the given equations?



Example 20 Checking an intersection point

Decide if the given point is at the intersection of the two lines with the given equations.

- a** $y = 2x + 3$ and $y = -x$ with point $(-1, 1)$
b $y = -2x$ and $3x + 2y = 4$ with point $(2, -4)$

SOLUTION

- a** Substitute $x = -1$.
 $y = 2x + 3$
 $= 2 \times (-1) + 3$
 $= -2 + 3$
 $= 1$
 So $(-1, 1)$ satisfies $y = 2x + 3$.
 $y = -x$
 $= -(-1)$
 $= 1$
 So $(-1, 1)$ satisfies $y = -x$.
 $\therefore (-1, 1)$ is the intersection point.

- b** Substitute $x = 2$.
 $y = -2x$
 $= -2 \times (2)$
 $= -4$
 So $(2, -4)$ satisfies $y = -2x$.
 $3x + 2y$
 $= 3 \times (2) + 2 \times (-4)$
 $= 6 + (-8)$
 $= -2$
 $\neq -4$
 So $(2, -4)$ is not on the line.
 $\therefore (2, -4)$ is not the intersection point.

EXPLANATION

Substitute $x = -1$ into $y = 2x + 3$ to see if $y = 1$.
 If so, then $(-1, 1)$ is on the line.

Repeat for $y = -x$.

If $(-1, 1)$ is on both lines then it must be the intersection point.

Substitute $x = 2$ into $y = -2x$ to see if $y = -4$.
 If so, then $(2, -4)$ is on the line.

Substitute $x = 2$ and $y = -4$ to see if $3x + 2y = 4$ is true.

Clearly, the equation is not satisfied.

As the point is not on both lines, it cannot be the intersection point.

Now you try

Decide if the given point is at the intersection of the two lines with the given equations.

- a** $y = 3x - 5$ and $y = -2x$ with point $(1, -2)$
b $y = -4x$ and $3x - y = 2$ with point $(2, -8)$



Example 21 Solving simultaneous equations graphically

Solve the simultaneous equations $y = 2x - 2$ and $x + y = 4$ graphically.

SOLUTION

$$y = 2x - 2$$

y-intercept (let $x = 0$):

$$y = 2 \times (0) - 2$$

$$y = -2$$

x-intercept (let $y = 0$):

$$0 = 2x - 2$$

$$2 = 2x$$

$$x = 1$$

$$x + y = 4$$

y-intercept (let $x = 0$):

$$(0) + y = 4$$

$$y = 4$$

x-intercept (let $y = 0$):

$$x + (0) = 4$$

$$x = 4$$

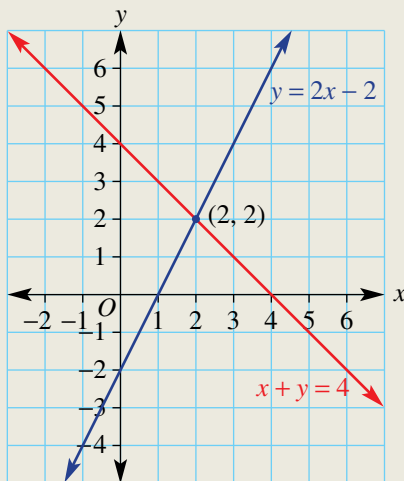

The intersection point is $(2, 2)$.

EXPLANATION

Sketch each linear graph by first finding the y-intercept (substitute $x = 0$) and the x-intercept (substitute $y = 0$) and solve the resulting equation.

Repeat the process for the second equation.

Sketch both graphs on the same set of axes by marking the intercepts and joining with a straight line.

Ensure that the axes are scaled accurately.

Locate the intersection point and read off the coordinates.

The point $(2, 2)$ simultaneously belongs to both lines.

Now you try

Solve the simultaneous equations $y = -x + 1$ and $2x + y = 3$ graphically.

Exercise 4K

FLUENCY

1, 2(1/2)

1-2(1/2)

1(1/2), 2(1/3)

- Example 20**
- 1** Decide if the given point is at the intersection of the two lines with the given equations.
- $y = 3x - 4$ and $y = 2x - 2$ with point $(2, 2)$
 - $y = -x + 3$ and $y = -x$ with point $(2, 1)$
 - $y = -4x + 1$ and $y = -x - 1$ with point $(1, -3)$
 - $x - y = 10$ and $2x + y = 8$ with point $(6, -4)$
 - $2x + y = 0$ and $y = 3x + 4$ with point $(-1, 2)$
 - $x - 3y = 13$ and $y = -x - 1$ with point $(4, -3)$
- Example 21**
- 2** Solve these pairs of simultaneous equations graphically by finding the coordinates of the intersection point.
- | | | |
|---|---|---|
| <p>a $2x + y = 6$
$x + y = 4$</p> | <p>b $3x - y = 7$
$y = 2x - 4$</p> | <p>c $y = x - 6$
$y = -2x$</p> |
| <p>d $y = 2x - 4$
$x + y = 5$</p> | <p>e $2x - y = 3$
$3x + y = 7$</p> | <p>f $y = 2x + 1$
$y = 3x - 2$</p> |
| <p>g $x + y = 3$
$3x + 2y = 7$</p> | <p>h $y = x + 2$
$y = 3x - 2$</p> | <p>i $y = x - 3$
$y = 2x - 7$</p> |
| <p>j $y = 3$
$x + y = 2$</p> | <p>k $y = 2x - 3$
$x = -1$</p> | <p>l $y = 4x - 1$
$y = 3$</p> |

PROBLEM-SOLVING

3, 4

3, 4

4, 5

- 3** A company manufactures electrical components. The cost, $\$C$ (including rent, materials and labour), is given by the rule $C = n + 3000$, and its revenue, $\$R$, is given by the rule $R = 5n$, where n is the number of components produced.
- Sketch the graphs of C and R on the same set of axes and determine the point of intersection.
 - State the number of components, n , for which the costs $\$C$ are equal to the revenue $\$R$.
- 4** BasketCo. manufactures baskets. Its costs, $\$C$, are given by the rule $C = 4n + 2400$, and its revenue, $\$R$, is given by the rule $R = 6n$, where n is the number of baskets produced. Sketch the graphs of C and R on the same set of axes and determine the number of baskets produced if the costs equal the revenue.
- 5** Two asteroids are 1000 km apart and are heading straight for each other. One asteroid is travelling at 59 km per second and the other at 41 km per second. How long will it be before they collide?

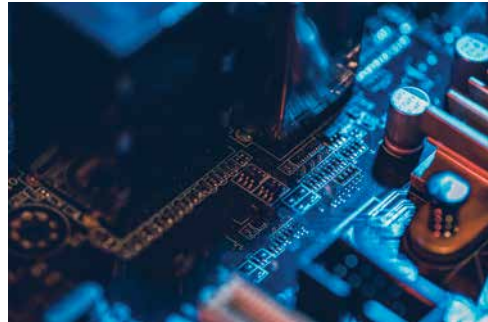

REASONING

6

6, 7

6–8

- 6 Explain why the graphs of the rules $y = 3x - 7$ and $y = 3x + 4$ have no intersection point.
- 7 For the following families of graphs, determine their points of intersection (if any).
- $y = x, y = 2x, y = 3x$
 - $y = x, y = -2x, y = 3x$
 - $y = x + 1, y = x + 2, y = x + 3$
 - $y = -x + 1, y = -x + 2, y = -x + 3$
 - $y = 2x + 1, y = 3x + 1, y = 4x + 1$
 - $y = 2x + 3, y = 3x + 3, y = 4x + 3$
- 8 a If two lines have the equations $y = 3x + 1$ and $y = 2x + c$, find the value of c if the intersection point is at $x = 1$.
- b If two lines have the equations $y = mx - 4$ and $y = -2x - 3$, find the value of m if the intersection point is at $x = -1$.

ENRICHMENT: Intersecting to find triangular areas

–

–

9, 10

- 9 The three lines with equations $y = 0$, $y = x + 2$ and $y = -2x + 5$ are illustrated here.

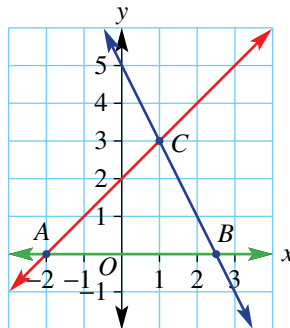

- State the coordinates of the intersection point of $y = x + 2$ and $y = -2x + 5$.
 - Use $A = \frac{1}{2}bh$ to find the area of the enclosed triangle ABC .
- 10 Use the method outlined in Question 9 to find the area enclosed by these sets of three lines.
- $y = 0, y = x + 3$ and $y = -2x + 9$
 - $y = 0, y = \frac{1}{2}x + 1$ and $y = -x + 10$
 - $y = 2, x - y = 5$ and $x + y = 1$
 - $y = -5, 2x + y = 3$ and $y = x$
 - $x = -3, y = -3x$ and $x - 2y = -7$



Using a CAS calculator 4K: Finding intersection points

This activity is in the Interactive Textbook in the form of a printable PDF.

Swimming at number 4

At a swim meet, Jess is the fourth and fastest swimmer in her team of 4 which swims the medley relay. Her average speed is 1.5 metres per second. During the race, she often finds herself in second position just before she dives in and needs to catch up so that she wins the race for her team. Each swimmer needs to swim 50 metres.

In the relay Adrianna is the last swimmer of another team which is currently in the lead before she dives in. To win Jess needs to catch up and overtake Adrianna. Adrianna's average speed is 1.4 metres per second.

For this task, d metres is the distance travelled by a swimmer and t seconds is the time in seconds after Adrianna dives into the water.

Present a report for the following tasks and ensure that you show clear mathematical workings and explanations where appropriate.

Preliminary task

- Write a rule for Adrianna's distance (d metres) in terms of time (t seconds).
- Find how long it takes for Adrianna to complete the 50 metres to the nearest tenth of a second.
- If Jess dives into the water 2 seconds after Adrianna, then the rule describing Jess's distance after t seconds is given by: $d = 1.5t - 3$.
 - Find how long it takes for Jess to complete the 50 metres, after Adrianna dives into the water, to the nearest tenth of a second.
 - Sketch a graph of d vs t for both Jess and Adrianna on the same set of axes. Show the coordinates of any endpoints and intercepts.
 - Does Jess overtake Adrianna? If so, after how many seconds?

Modelling task

- | | |
|----------------------------|---|
| Formulate | a The problem is to determine the maximum head start that Adrianna can have so that Jess wins the relay for her team. Write down all the relevant information that will help solve this problem. |
| Solve | b Jess dives into the water 1 second after Adrianna. i.e. when $t = 1$ then $d = 0$ for Jess. <ol style="list-style-type: none"> Find a rule for Jess's distance (d metres) after t seconds. Find the time taken for Jess to complete the 50 metres, after Adrianna dives into the water, to the nearest tenth of a second. Sketch a graph of d vs t for both Jess and Adrianna on the same set of axes. Show the coordinates of any endpoints and intercepts. Decide if Jess overtakes Adrianna. If so, after how many seconds? |
| Evaluate and verify | c Repeat part b if Jess dives into the water 3 seconds after Adrianna.
d If Jess catches up to Adrianna at exactly the time when Adrianna finishes the relay: <ol style="list-style-type: none"> illustrate this situation with a graph determine the head start, in seconds to one decimal place, that Adrianna had in this situation. |
| Communicate | e Decide under what circumstances will Jess win the relay for her team. Justify your answer.
f Summarise your results and describe any key findings. |

Extension questions

- If Jess's swim speed was able to be increased to 1.6 m/s, investigate the maximum head start that Adrianna could have so that Jess wins the relay.
- If in one particular race Adrianna has a 2.1 second head start, determine Jess's minimum speed if she is to win the relay.

Hybrid linear journeys

Key technology: Graphing

When straight lines are used to describe travel situations, we use lines with different gradients and y -intercepts over different values of t (time) on the horizontal x -axis. Such relations are called hybrid or piecewise functions. For each part of the graph, we limit the x values and describe them using inequality symbols. For example, the rule $y = 50x + 100$ might be valid for $0 \leq x \leq 5$.



1 Getting started

A journey in a car involves the following three components.

- Section A: Travelling 200 km in 2 hours
- Section B: Resting for 3 hours
- Section C: Travelling 150 km in 3 hours
 - a Find the speed of the car for:
 - i Section A
 - ii Section B
 - iii Section C.
 - b What is the total distance travelled?
 - c Draw a travel graph for this journey using t for time in hours on the horizontal x axis and d for distance on the vertical axis in kilometres.

2 Using technology

We will now use three linear rules and a graphing program like Desmos to create the travel graph.

The image shows how to create the three rules for the different values of x . The values of a, b, c, d, f and g define the gradients and y -intercepts of the graph and are not yet correct for the given journey description in part 1 above.



- a** Build a Desmos graph as shown adding sliders for the values of a , b , c , d , f and g and the points $(0, 0)$, $(2, 200)$, $(5, 200)$, $(8, 350)$. Adjust the range for each slider to suit.
- b** Now adjust your sliders so that the three lines pass through the correct points and that your graph matches your graph from part **1 c**.
- c** Write down the rules for the three graphs and check that they are correct by seeing if the points satisfy the equations exactly. Do this by substituting a selected point into one of the rules which passes through that point.

3 Applying an algorithm

We will now create a new graph using technology for a four-part journey using the points $(0, 0)$, $(3, 240)$, $(5, 400)$, $(6, 400)$ and $(8, 600)$.

- a** Follow these steps.
 - Step 1: Add the five given points and adjust the graph scales to suit.
 - Step 2: Add a linear relation of the form $y = ax + b$ for the time between the first two points.
 - Step 3: Add sliders for the pronumerals a and b .
 - Step 4: Alter the sliders so that the graph passes through the two points.
 - Step 5: Repeat from Step 2 moving to the next pair of points until your travel graph is complete.
- b** Write down the rules for the four graphs and check that they are correct by seeing if the points satisfy the equations exactly.
- c** Calculate the gradient of each graph and describe what the gradient means in terms of the journey.

4 Extension

- a** Consider a car journey using the points $(0, 0)$, $(3, 200)$, $(5, 200)$ and $(6.5, 330)$ and create a travel graph similar to the above.
- b** Describe why fractions need to be used in the Step adjustment when altering the range of values for the sliders.



Coming and going

The distance between two towns, Palton and Verton, is 100 km. Two cyclists travel in opposite directions between the towns, starting their journeys at the same time. Cyclist A travels from Palton to Verton at a speed of 20 km/h while cyclist B travels from Verton to Palton at a speed of 25 km/h.

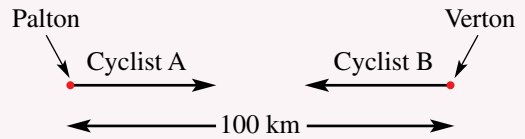

Measuring the distance from Palton

- Using d_A km as the distance cyclist A is from Palton after t hours, explain why the rule connecting d_A and t is $d_A = 20t$.
- Using d_B km as the distance cyclist B is from Palton after t hours, explain why the rule connecting d_B and t is $d_B = 100 - 25t$.

Technology: Spreadsheet (alternatively use a graphics or CAS calculator – see parts e and f below)

- Instructions:
 - Enter the time in hours into column A, starting at 0 hours.
 - Enter the formulas for the distances d_A and d_B into columns B and C.
 - Use the **Fill down** function to fill in the columns. Fill down until the distances show that both cyclists have completed their journey.

	A	B	C
1	0	= 20 * A1	= 100 - 25 * A1
2	= A1 + 1		
3			

- Determine how long it takes for cyclist A to reach Verton.
 - Determine how long it takes for cyclist B to reach Palton.
 - After which hour are the cyclists the closest?

Alternative technology: Graphics or CAS calculator

- Instructions:
 - Enter or define the formulas for the distances d_A and d_B .
 - Go to the table and scroll down to view the distance for each cyclist at hourly intervals. You may need to change the settings so that t increases by 1 each time.
- Determine how long it takes for cyclist A to reach Verton.
 - Determine how long it takes for cyclist B to reach Palton.
 - After which hour are the cyclists the closest?

Investigating the intersection

- a Change the time increment to a smaller unit for your chosen technology.
 - Spreadsheet: Try 0.5 hours using '= A1 + 0.5', or 0.1 hours using '= A1 + 0.1' in column A.
 - Graphics or CAS calculator: Try changing the t increment to 0.5 or 0.1.
- b Fill or scroll down to ensure that the distances show that both cyclists have completed their journey.
- c Determine the time at which the cyclists are the closest.
- d Continue altering the time increment until you are satisfied that you have found the time of intersection of the cyclists correct to one decimal place.
- e *Extension:* Complete part d above but find an answer correct to three decimal places.

The graph

- a Sketch a graph of d_A and d_B on the same set of axes. Scale your axes carefully to ensure that the full journey for both cyclists is represented.
- b Determine the intersection point as accurately as possible on your graph and hence estimate the time when the cyclists meet.
- c Use technology (graphing calculator) to confirm the point of intersection, and hence determine the time at which the cyclists meet, correct to three decimal places.

Algebra and proof

- a At the point of intersection it could be said that $d_A = d_B$.
This means that $20t = 100 - 25t$.
Solve this equation for t .
- b Find the exact distance from Palton at the point where the cyclists meet.

Reflection

Write a paragraph describing the journey of the two cyclists. Comment on:

- the speeds of the cyclists
- their meeting point
- the difference in computer and algebraic approaches in finding the time of the intersection point.



- 1 A tank with 520 L of water begins to leak at a rate of 2 L per day. At the same time, a second tank is being filled at a rate of 1 L per hour starting at 0 L. How long does it take for the tanks to have the same volume?



Up for a challenge? If you get stuck on a question, check out the 'Working with unfamiliar problems' poster at the end of the book to help you.

- 2 Two cars travel towards each other on a 400 km stretch of road. One car travels at 90 km/h and the other at 70 km/h. How long does it take before they pass each other?
- 3 The points $(-1, 4)$, $(4, 6)$, $(2, 7)$ and $(-3, 5)$ are the vertices of a parallelogram. Find the midpoints of its diagonals. What do you notice?
- 4 A trapezium is enclosed by the straight lines $y = 0$, $y = 3$, $y = 7 - x$, and $x = k$, where k is a constant. Find the possible values of k given the trapezium has an area of 24 units².
- 5 Prove that the triangle with vertices at the points $A(-1, 3)$, $B(0, -1)$ and $C(3, 2)$ is isosceles.
- 6 Find the perimeter (to the nearest whole number) and area of the triangle enclosed by the lines with equations $x = -4$, $y = x$ and $y = -2x - 3$.
- 7 $ABCD$ is a parallelogram. A , B and C have coordinates $(5, 8)$, $(2, 5)$ and $(3, 4)$ respectively. Find the coordinates of D .
- 8 A kite is formed by joining the points $A(a, b)$, $B(-1, 3)$, $C(x, y)$ and $D(3, -5)$.
- Determine the equations of the diagonals BD and AC of this kite.
 - Given $a = -5$ and $y = 4$, find the values of b and x .
 - Find the area of the kite (without the use of a calculator).



- 9 A trapezium is enclosed by the straight lines $y = 0$, $y = 6$, $y = 8 - 2x$, and $y = x + k$, where k is a constant. Find the possible values of k given the trapezium has an area of 66 units².

Chapter summary

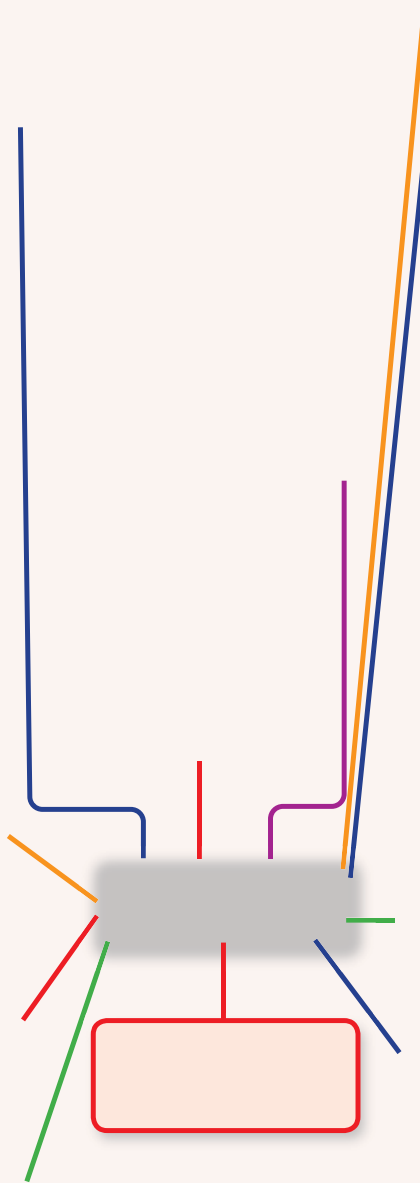

Chapter checklist with success criteria

A printable version of this checklist is available in the Interactive Textbook



4A

1. I can plot points to graph a straight line.

e.g. Using $-3 \leq x \leq 3$, construct a table of values and plot a graph of $y = 2x - 4$.



4A

2. I can identify the x - and y -intercept.

e.g. Write down the coordinates of the x - and y -intercepts from this graph.

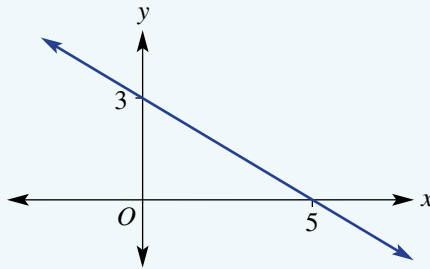

4A

3. I can determine if a point is on a line.

e.g. Decide if the point $(-2, 9)$ is on the line with rule $y = -2x + 3$.



4B

4. I can sketch a graph of a straight line labelling intercepts.

e.g. Sketch the graphs of $y = -2x + 4$ and $3x - 4y = 12$ showing x - and y -intercepts.



4C

5. I can graph horizontal and vertical lines.

e.g. Sketch $y = -2$ and $x = 5$.



4C

6. I can sketch lines of the form $y = mx$.

e.g. Sketch the graph of $y = 2x$.



4D

7. I can find the gradient of a line.

e.g. For the graphs shown, state whether the gradient is positive, negative, zero or undefined and find the gradient.

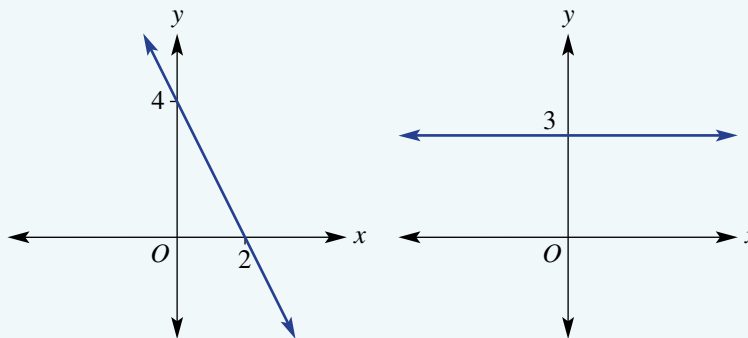

4D

8. I can find the gradient between two points.

e.g. Find the gradient of the line joining the points $(-1, 3)$ and $(4, 9)$.



4E

9. I can work with direct proportion.

e.g. A bathtub is being filled at a constant rate. It takes 10 minutes to fill the bath with 60 litres. Draw a graph of volume (V litres) vs time (t minutes) for $0 \leq t \leq 10$. Find the gradient of the graph and a rule for V . Use the rule to find the time for the bathtub to fill to 45 litres.



Chapter checklist and success criteria

		✓
4F	10. I can rearrange linear equations. e.g. Rearrange $2x + 3y = 8$ to the form $y = mx + c$.	<input type="checkbox"/>
4F	11 I can state the gradient and y-intercept from a linear rule. e.g. State the gradient and y-intercept of $y = -2x + 3$ and $2y - 4x = 5$.	<input type="checkbox"/>
4F	12. I can use the gradient and y-intercept to sketch a graph. e.g. Use the gradient and y-intercept of $y = 3x - 2$ and $2x + 3y = 8$ to sketch their graphs.	<input type="checkbox"/>
4G	13. I can determine the equation of a straight line graph given the y-intercept. e.g. Determine the equation of the straight line shown here.	<input type="checkbox"/>
4G	14. I can determine the equation of a line given the gradient and a point. e.g. Find the equation of the line which has a gradient of 2 and passes through the point $(-2, 5)$.	<input type="checkbox"/>
4H	15. I can find the midpoint of a line segment. e.g. Find the midpoint $M(x, y)$ of the line segment joining the points $(2, -1)$ and $(6, 4)$.	<input type="checkbox"/>
4H	16. I can find the length of a line segment. e.g. Find the length of the segment joining $(-2, 1)$ and $(3, 5)$, correct to two decimal places.	<input type="checkbox"/>
4I	17. I can find the equation of a parallel line. e.g. Find the equation of a line that is parallel to the line $y = -2x + 3$ and passes through $(0, 1)$.	(Ext) <input type="checkbox"/>
4I	18. I can find the equation of a perpendicular line. e.g. Find the equation of a line that is perpendicular to the line $y = 4x + 2$ and passes through $(0, -3)$.	(Ext) <input type="checkbox"/>
4J	19. I can apply linear relations. e.g. The hire of a jumping castle involves a set-up cost of \$80 and a per hour rate of \$40. Write a rule for the total cost, \$ C , of hiring a jumping castle for h hours and sketch its graph for $0 \leq h \leq 8$. Determine the total cost for hiring for 5 hours and how many hours it was hired for if the cost was \$200.	<input type="checkbox"/>
4K	20. I can check if a point is the intersection point of two lines. e.g. Determine if the point $(2, -1)$ is at the intersection of the lines with equations $y = -2x + 3$ and $2x - 3y = 7$.	<input type="checkbox"/>
4K	21. I can solve simultaneous equations graphically. e.g. Solve the simultaneous equations $y = 2x - 4$ and $x + y = 5$ graphically.	<input type="checkbox"/>

Short-answer questions

4A

- 1 Read off the coordinates of the
- x
- and
- y
- intercepts from the table and graph.

a

x	-2	-1	0	1	2
y	0	2	4	6	8

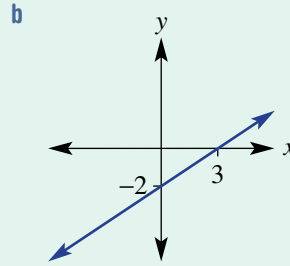

4B

- 2 Sketch the following linear graphs labelling
- x
- and
- y
- intercepts.

a $y = 2x - 4$ b $y = 3x + 9$ c $y = -2x + 5$ d $y = -x + 4$
 e $2x + 4y = 8$ f $4x - 2y = 10$ g $2x - y = 7$ h $-3x + 6y = 12$

4B

- 3 Violet leaves her beach house by car and drives back to her home. Her distance
- d
- kilometres from her home after
- t
- hours is given by
- $d = 175 - 70t$
- .

- a How far is her beach house from her home?
 b How long does it take to reach her home?
 c Sketch a graph of her journey between the beach house and her home.

4C

- 4 Sketch the following lines.

a $y = 3$ b $y = -2$ c $x = -4$
 d $x = 5$ e $y = 3x$ f $y = -2x$

4D

- 5 By first plotting the given points, find the gradient of the line passing through the points.

a (3, 1) and (5, 5) b (2, 5) and (4, 3) c (1, 6) and (3, 1)
 d (-1, 2) and (2, 6) e (-3, -2) and (1, 6) f (-2, 6) and (1, -4)

4E

- 6 An inflatable backyard swimming pool is being filled with water by a hose. It takes 4 hours to fill 8000 L.

- a What is the rate at which water is poured into the pool?
 b Draw a graph of volume (V litres) versus time (t hours) for $0 \leq t \leq 4$.
 c Find the gradient of your graph and give the rule for V in terms of t .
 d Use your rule to find the time to fill 5000 L.

4F

- 7 For each of the following linear relations, state the value of the gradient and the
- y
- intercept, and then sketch using the gradient–intercept method.

a $y = 2x + 3$
 b $y = -3x + 7$
 c $2x + 3y = 9$
 d $2y - 3x - 8 = 0$

4G

- 8 Give the equation of the straight line that:

- a has gradient 3 and passes through the point (0, 2)
 b has gradient -2 and passes through the point (3, 0)
 c has gradient $\frac{4}{3}$ and passes through the point (6, 3).

4G

9 Find the equations of the linear graphs below.

a

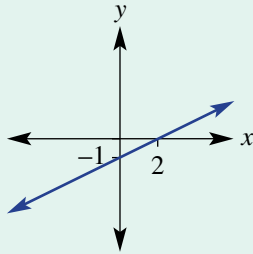

b

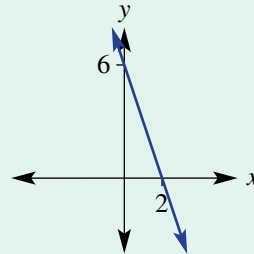

c

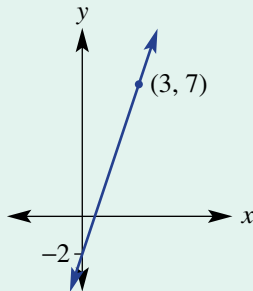

d

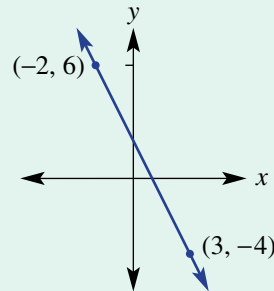

4H

10 For the line segment joining the following pairs of points, find:

- the midpoint
- the length (to two decimal places where applicable).



- | | | | |
|---|--------------------|---|----------------------|
| a | (2, 4) and (6, 8) | b | (5, 2) and (10, 7) |
| c | (-2, 1) and (2, 7) | d | (-5, 7) and (-1, -2) |

4H

11 Find the missing coordinate, n , if:

- the line joining $(-1, 3)$ and $(2, n)$ has gradient 2
- the line segment joining $(-2, 2)$ and $(4, n)$ has length 10, $n > 0$
- the midpoint of the line segment joining $(n, 1)$ and $(1, -3)$ is $(3.5, -1)$.

4I

12 Determine the linear equation that is:

Ext

- parallel to the line $y = 2x - 1$ and passes through the point $(0, 4)$
- parallel to the line $y = -x + 4$ and passes through the point $(0, -3)$
- perpendicular to the line $y = 2x + 3$ and passes through the point $(0, -1)$
- perpendicular to the line $y = -\frac{1}{3}x - 2$ and passes through the point $(0, 4)$
- parallel to the line $y = 3x - 2$ and passes through the point $(1, 4)$
- parallel to the line $3x + 2y = 10$ and passes through the point $(-2, 7)$.

4K

13 Determine if the point $(2, 5)$ is the intersection point of the graphs of the following pairs of equations.

- $y = 4x - 3$ and $y = -2x + 6$
- $3x - 2y = -4$ and $2x + y = 9$

4K

14 Find the point of intersection of the following straight lines.

- $y = 2x - 4$ and $y = 6 - 3x$
- $2x + 3y = 8$ and $y = -x + 2$

Multiple-choice questions

4A

1 The x - and y -intercepts of the graph of $2x + 4y = 12$ are respectively at:

- A (4, 0), (0, 2)
- B (3, 0), (0, 2)
- C (6, 0), (0, 3)
- D (2, 0), (0, 12)
- E (8, 0), (0, 6)

4B

2 The graph of $y = 3x - 6$ is represented by:

A

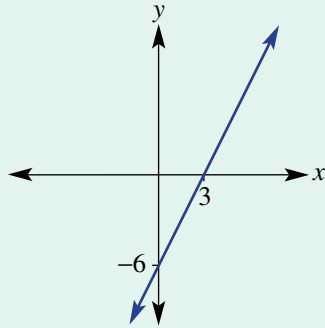

B

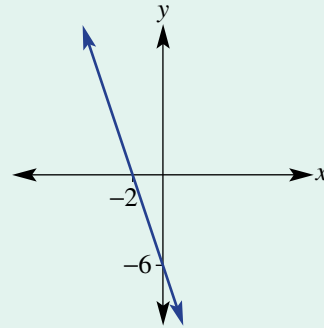

C

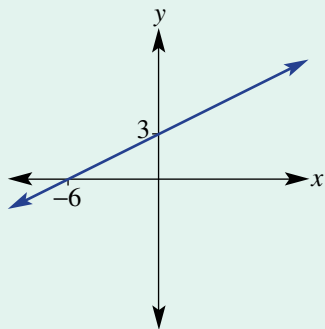

D

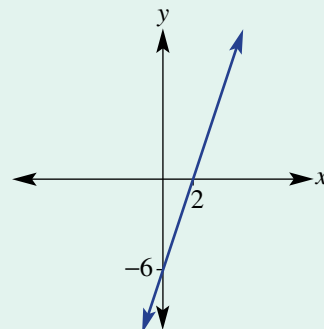

E

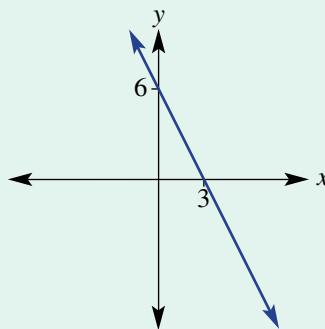

4D

3 The gradient of the line joining the points (1, -2) and (5, 6) is:

- A 2
- B 1
- C 3
- D -1
- E $\frac{1}{3}$

- 4A 4 The point that is not on the straight line $y = -2x + 3$ is:
- A (1, 1)
 - B (0, 3)
 - C (2, 0)
 - D (-2, 7)
 - E (3, -3)

- 4F 5 The linear graph that *does not* have a gradient of 3 is:
- A $y = 3x + 7$
 - B $\frac{y}{3} = x + 2$
 - C $2y - 6x = 1$
 - D $y - 3x = 4$
 - E $3x + y = -1$

- 4G 6 A straight line has a gradient of -2 and passes through the point (0, 5). Its equation is:
- A $2y = -2x + 10$
 - B $y = -2x + 5$
 - C $y = 5x - 2$
 - D $y - 2x = 5$
 - E $y = -2(x - 5)$

- 4G 7 The equation of the graph shown is:
- A $y = x + 1$
 - B $y = \frac{1}{2}x + 4$
 - C $y = 2x + 1$
 - D $y = -2x - 1$
 - E $y = \frac{1}{2}x + 2$

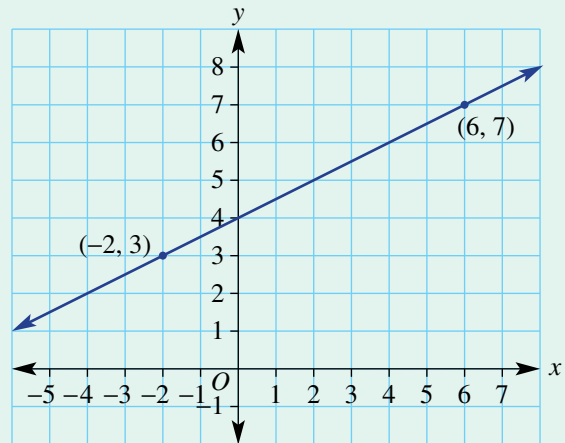

- 4H 8 The length of the line segment joining the points $A(1, 2)$ and $B(4, 6)$ is:
- A 5
 - B $\frac{4}{3}$
 - C 7
 - D $\sqrt{5}$
 - E $\sqrt{2}$

- 4I 9 The gradient of a line perpendicular to $y = 4x - 7$ would be:

- Ext
- A $\frac{1}{4}$
 - B 4
 - C -4
 - D $-\frac{1}{4}$
 - E -7

4K

- 10 The point of intersection of $y = 2x$ and $y = 6 - x$ is:
- A (6, 2)
 - B (-1, -2)
 - C (6, 12)
 - D (2, 4)
 - E (3, 6)

Extended-response questions

- 1 Joe requires an electrician to come to his house to do some work. He is trying to choose between two electricians he has been recommended.
- a The first electrician's cost, \$ C , is given by $C = 80 + 40n$ where n is the number of hours the job takes.
 - i State the hourly rate this electrician charges and his initial fee for coming to the house.
 - ii Sketch a graph of C versus n for $0 \leq n \leq 8$.
 - iii What is the cost of a job that takes 2.5 hours?
 - iv If the job costs \$280, how many hours did it take?
 - b The second electrician charges a callout fee of \$65 to visit the house and then \$45 per hour.
 - i Give the equation for the cost, \$ C , of a job that takes n hours.
 - ii Sketch the graph of part b i for $0 \leq n \leq 8$ on the same axes as the graph in part a.
 - c Determine the point of intersection of the two graphs.
 - d After how many hours does the first electrician become the cheaper option?
- 2 Abby has set up a small business making clay vases. Her production costs include a fixed weekly cost for equipment hire and a cost per vase for clay. Abby has determined that the total cost of producing 7 vases in a week was \$146 and the total cost of producing 12 vases in a week was \$186.
- a Find a linear rule relating the production cost, \$ C , to the number of vases produced, v .
 - b Use your rule to state:
 - i the initial cost of materials each week
 - ii the ongoing cost of production per vase.
 - c At a selling price of \$12 per vase Abby determines her weekly profit to be given by $P = 4v - 90$.
How many vases must she sell in order to make a profit?



5

Measurement

Maths in context: Measurement skills are essential to our civilization

Our lifestyles depend on experts accurately using measurement skills to design and construct our:

- houses containing rectangular prism rooms with surface areas painted, rectangular prism concrete foundations, rectangular house block's perimeter fenced.
- vehicles' circular wheels, circumferences fitted with tyres, arc shaped curves driven using steering mechanisms, circle sectors cleaned by windscreen wipers.
- water supply and sewage systems, crucial to health, using cylindrical pipes.
- farms with rectangular paddock perimeters fenced and areas growing food crops, cylindrical silos for grain storage, circular and rectangular irrigation areas.

Sport is for our health and cultural enjoyment, and measurement skills are essential for the construction of:

- cricket ovals and rectangular football fields.
- basketball and netball rectangular courts with centre circle, goal semi-circles and circular goal rings.
- running, cycling and ice speed-skating tracks following the outer perimeter of a rectangle with semicircles at each end.
- shot put, discus and javelin throwing circles with sector landing areas.
- swimming and diving pools containing rectangular or trapezoidal prism shaped volumes of water.

Chapter contents

- 5A Errors and accuracy in measurement
- 5B Length and perimeter (CONSOLIDATING)
- 5C Circle circumference and perimeter of a sector
- 5D Area
- 5E Perimeter and area of composite shapes
- 5F Surface area of prisms and pyramids
- 5G Surface area of cylinders
- 5H Volume of prisms
- 5I Volume of cylinders

Australian Curriculum 9.0

NUMBER

Recognise that the real number system includes the rational numbers and the irrational numbers, and solve problems involving real numbers using digital tools (AC9M9N01)

MEASUREMENT

Solve problems involving the volume and surface area of right prisms and cylinders using appropriate units (AC9M9M01)

Calculate and interpret absolute, relative and percentage errors in measurements, recognising that all measurements are estimates (AC9M9M04)

Use mathematical modelling to solve practical problems involving direct proportion, rates, ratio and scale, including financial contexts; formulate the problems and interpret solutions in terms of the situation; evaluate the model and report methods and findings (AC9M9M05)

© ACARA

Online resources

A host of additional online resources are included as part of your Interactive Textbook, including HOTmaths content, video demonstrations of all worked examples, auto-marked quizzes and much more.

5A Errors and accuracy in measurement

LEARNING INTENTIONS

- To understand that all measurements are estimates
- To be able to calculate absolute, relative and percentage errors in measurement
- To be able to find suitable upper and lower bounds for measurements and related calculations

The Hubble space telescope was launched in 1990 and has delivered millions of observations helping to produce thousands of scientific papers including stunning images of galaxies and other astronomical objects. Unfortunately, the first images produced by the telescope were fuzzy and out of focus due to an error in the shape of the main parabolic mirror. One theory is that a slight error in the calibration of the machine which polished the mirror resulted in an error of less than $1/50$ of the width of a human hair in the mirror's shape. This was enough to cause the received images to be out of focus. The problem was rectified by using a special lense to reverse the error in a similar way that eyeglasses are used to correct people's vision.



Lesson starter: Underweight gobbles

A confectionery company's most popular product is called a gobbler which can be purchased in bags of 50. Larry, an employee of the company, uses a digital scale which displays a whole number of grams for each measurement. Larry places one gobbler on the scale which displays 7 grams. He then calculates the weight of a bag of 50 gobblers as $50 \times 7 = 350$ grams.

- a** Would it be possible for the actual weight of the gobbler to be the following? Give a reason in each case.
- | | | | |
|--------------------|---------------------|-----------------------|----------------------|
| i 7.2 grams | ii 6.3 grams | iii 6.52 grams | iv 7.56 grams |
|--------------------|---------------------|-----------------------|----------------------|

Assume now that the weight of each gobbler is actually 6.71 grams when rounded to two decimal places.

- b** Find the weight of a bag of gobblers.
c Find the difference in the weight of a bag of gobblers and the weight of the bag calculated by Larry.
d Express your difference in part **c** above as a percentage of the actual weight of a bag of gobblers.
e As a consumer would you be satisfied or dissatisfied by the fact that the bag label says 350 grams? Give a reason.

KEY IDEAS

- All measurements are estimates of the actual quantity. The accuracy of each measurement may depend on:
 - the scale on the measuring instrument
 - the units used in the measurement
 - the person's ability in using the instrument and reading the scale.
- **Error** = measurement – actual value
 - The error could be positive or negative depending on the measurement.
 - The absolute value of the error gives the error as a positive number, ignoring the sign.
- Percentage error = $\frac{\text{Error}}{\text{Actual value}} \times \frac{100}{1}$
- The **limits of accuracy** are the smallest and largest possible values that a measurement could be.
 - A ruler with both cm and mm markings, for example, might produce a 36 mm recording. The lower limit would be 35.5 mm and the upper limit would be (but not including) 36.5 mm.
 - Lower limit = recorded measurement – $0.5 \times$ smallest unit of measure
 - Upper limit = recorded measurement + $0.5 \times$ smallest unit of measure

BUILDING UNDERSTANDING

1 What is the smallest unit marked on these measuring devices?

a Ruler



b Thermometer

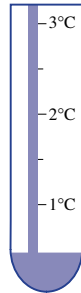

c Water container

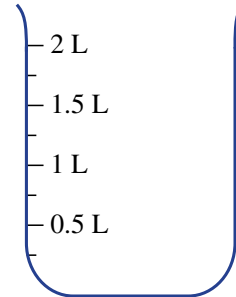

2 Find the absolute value of the following errors. Recall that the absolute value of the error gives the error as a positive number ignoring the negative sign if necessary.

a –23 grams

b –1.78 litres

c –41.1 seconds

3 Danny estimates that he might spend \$100 on a trip to the city one day but he actually spends \$80.

a What is the difference between Danny's estimate and his actual expenditure?

b Express the difference calculated in part a as a percentage of the actual expenditure. Use the

formula: Percentage error = $\frac{\text{Error}}{\text{Actual value}} \times \frac{100}{1}$

4 Matty uses a digital scale which records the number of kilograms as whole numbers. Decide if the following actual weights would produce a digital readout of 12 kg.

a 12.3 kg

b 12.42 kg

c 12.61 kg

d 11.83 kg

e 11.49 kg

**Example 1** Calculating absolute percentage error

Calculate the absolute percentage error for the following measurements and actual values.

- a** Measurement: 2.9 kg Actual value: 2.5 kg
b Measurement: 35 minutes Actual value: 40 minutes

SOLUTION

a Error = $2.9 - 2.5 = 0.4$ kg

$$\% \text{Error} = \frac{0.4}{2.5} \times \frac{100}{1}$$

$$= 16\%$$

b Error = $35 - 40 = -5$ minutes
 Absolute error = 5 minutes

$$\% \text{Error} = \frac{5}{40} \times \frac{100}{1}$$

$$= 12.5\%$$

EXPLANATION

Error = measurement – actual value

$$\text{Percentage error} = \frac{\text{Error}}{\text{Actual value}} \times \frac{100}{1}$$

To calculate the absolute error, ignore the negative sign after calculating the error.

Calculate the percentage error as per part **a** above.

Now you try

Calculate the absolute percentage error for the following measurements.

- a** Measurement: 44 seconds Actual value: 40 seconds
b Measurement: 4.7 litres Actual value: 5.0 litres

**Example 2** Finding the limits of accuracy in a measurement

A single chocolate is weighed using a digital scale which displays measurements in grams correct to one decimal place. The measurement given is 6.7 g.

- a** State the lower and upper limits of accuracy for this measurement.
b If the chocolates are sold in bags of 10, find the lower and upper limits of accuracy for the weight of a bag of chocolates.

SOLUTION

a Lower limit = $6.7 - 0.5 \times 0.1$

$$= 6.65 \text{ g}$$

 Upper limit = $6.7 + 0.5 \times 0.1$

$$= 6.75 \text{ g}$$

b Calculated weight = $10 \times 6.7 = 67 \text{ g}$
 Maximum error = $10 \times 0.05 = 0.5 \text{ g}$
 Lower limit = $67 - 0.5$

$$= 66.5 \text{ g}$$

 Upper limit = $67 + 0.5$

$$= 67.5 \text{ g}$$

EXPLANATION

Subtract $0.5 \times$ smallest unit (0.1 grams) to the recorded measurement.

Add $0.5 \times$ smallest unit (0.1 grams) to the recorded measurement.

First find the weight of the bag using the recorded measurement and calculate the maximum error possible.

Subtract or add the maximum error possible to calculate the lower and upper limits for the weight of the bag of 10 chocolates.

Now you try

A single teddy bear biscuit is weighed using a digital scale which displays measurements in grams correct to the nearest whole number. The measurement given is 58 g.

- State the lower and upper limits of accuracy for this measurement.
- If the biscuits are sold in boxes of 10, find the lower and upper limits of accuracy for the weight of a box of biscuits.

Exercise 5A

FLUENCY

1, $2\frac{1}{2}$, 3–5, $6\frac{1}{2}$ 1– $2\frac{1}{2}$, 3, 4, $6\frac{1}{2}$ 1– $2\frac{1}{2}$, 3, 5, $6\frac{1}{2}$

Example 1



- Calculate the absolute percentage error for the following measurements and actual values.
 - Measurement: 11 kg Actual value: 10 kg
 - Measurement: 19 L Actual value: 20 L
 - Measurement: 26 seconds Actual value: 25 seconds
 - Measurement: 2.8 kg Actual value: 3.2 kg



- Calculate the absolute percentage error for the following measurements and actual values.
 - Measurement: 57 g Actual value: 60 g
 - Measurement: 23.5 hours Actual value: 25 hours
 - Measurement: 3.4 mL Actual value: 3.2 mL
 - Measurement: 2.49 kL Actual value: 2.4 kL

Example 2



- A single packet of chips is weighed using a digital scale which displays measurements in grams correct to one decimal place. The measurement given is 25.5 g.
 - State the lower and upper limits of accuracy for this measurement.
 - If the chips are sold in boxes of 20, find the lower and upper limits of accuracy for the weight of a box.



- A single pen is weighed using a digital scale which displays in grams correct to the nearest whole number. The measurement given is 15 g.
 - State the lower and upper limits of accuracy for this measurement.
 - If the pens are sold in boxes of 30, find the lower and upper limits of accuracy for the weight of a box.

- 5 A single bottle of drink is measured using a measuring jug which includes a scale with markings for each 10 mL. The measurement given is 1.51 L.
- State the lower and upper limits of accuracy for this measurement.
 - If the drinks are sold in crates of 10, find the lower and upper limits of accuracy for the volume of drinks in a crate.
- 6 Give the limits of accuracy for these measurements.
- | | | | |
|---------------|-----------|------------|---------------|
| a 36 cm | b 103 m | c 3.2 mm | d 6.8 minutes |
| e 45.24 hours | f 83.51 g | g 3.106 kg | h 0.0357 L |

PROBLEM-SOLVING

7, 8

7–9

8–10

- 7 At a school fair you guess that there are 155 lollies in a jar when actually there were 180. Calculate your absolute percentage error. Round to one decimal place.
- 8 Armid measures the weight of one of 15 identical figurines. The scale gives a whole number of grams only and displays 45 grams. What is the difference between the lowest and highest possible weight of all 15 figurines?
- 9 Kelly measures her height and calculates a percentage error of 0.5%. If her actual height is 173.4 cm, find Kelly's possible recorded height. Round to one decimal place.
- 10 A Bordoodle dog's weight is recorded as 21.5 kg but the percentage error calculated after using a more accurate weighing device is 1.5%. Find the possible actual weights of the Bordoodle correct to one decimal place.





REASONING

11

11, 12

11–13

-  **11** One way to reduce the error when using measuring instruments is to take multiple readings and find the mean (average) of those measurements. The distance between two towns was measured four times and the results were 22.8 km, 22.9 km, 23.2 km and 23.0 km. The actual distance is known to be 23.1 km.
- Find the mean of the four recorded measurements.
 - Find the percentage error using your result from part **a**. Round to two decimal places.
- 12** Give a reason why a negative error might be recorded rather than an absolute value error.
-  **13** A 1% error, for example, can be interpreted as a 99% accuracy. Find the accuracy for the following errors.
- An error of 3 grams with an actual weight of 120 grams.
 - A measured time of 12.6 seconds against an actual time of 12.75 seconds. Round to one decimal place.

ENRICHMENT: World's most embarrassing mistakes

–

–

14

-  **14** One of the causes of some of history's most embarrassing mistakes relates to the misuse of measurement systems.
- The \$125 million Mars Climate orbiter was lost due to some confusion between units. The Jet Propulsions Laboratory used the Metric system for their calculations and the Astronautics Division used Imperial units. Assuming that one inch (2.54 cm) was mistaken for a centimetre find the percentage error correct to one decimal place.
 - In 1628 the Swedish Vasa Warship sank after sailing only a small distance out to sea. It was discovered that the measuring rulers used for one side of the ship were Swedish foot long rulers of length 29.69 cm including 12 inches and the rulers used for the other side of the ship were Amsterdam foot long rulers of length 28.31 cm which included 11 inches. This meant that one side of the ship contained more timber than the other side and hence the ship tilted and sank. Assuming that the Swedish 12 inch ruler was the correct ruler to use, find the percentage error made by the carpenters who used the Amsterdam 11 inch ruler if they were trying to measure a piece of wood which was supposed to be 2 feet 6 inches long. Round to one decimal place.
 - Research other famous embarrassing mistakes made using measuring instruments or units. Choose one example and calculate the percentage error made.



5B Length and perimeter CONSOLIDATING

LEARNING INTENTIONS

- To review the concept of perimeter
- To review metric units of length and how to convert between these
- To be able to find the perimeter of simple shapes

Length is at the foundation of measurement from which the concepts of perimeter, circumference, area and volume are developed. From the use of the royal cubit (distance from tip of middle finger to the elbow) used by the ancient Egyptians to the calculation of pi by computers, units of length have helped to create the world in which we live.



To determine the length of scaffolding required for a multistorey building, multiples of its perimeter are calculated.

Lesson starter: Not enough information?

All the angles at each vertex in this shape are 90° and the two given lengths are 10 cm and 13 cm.

- Do you think there is enough information to find the perimeter of the shape?
- If there is enough information, find the perimeter and discuss your method. If not, then list what information needs to be provided.

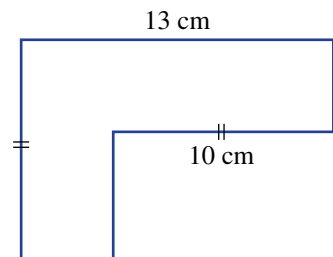

KEY IDEAS

- To convert between **metric units** of length, multiply or divide by the appropriate power of 10.

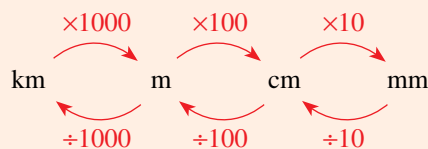

- **Perimeter** is the distance around the outside of a closed shape.
 - Sides with the same markings are of equal length.

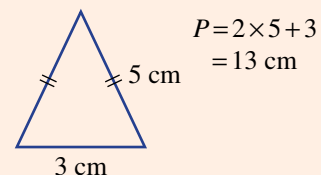

BUILDING UNDERSTANDING

- 1 Convert the following length measurements to the units given in the brackets.
- a 5 cm (mm) b 2.8 m (cm) c 521 mm (cm)
 d 83.7 cm (m) e 4.6 km (m) f 2170 m (km)
- 2 A steel beam is 8.25 m long and 22.5 mm wide. State the length and the width of the beam in centimetres.
- 3 Give the values of the pronumerals in these shapes. All angles at vertices are 90° .

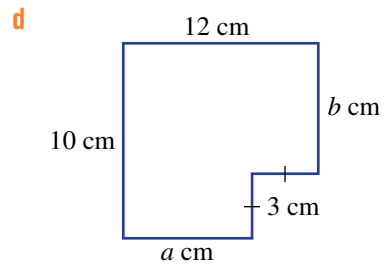
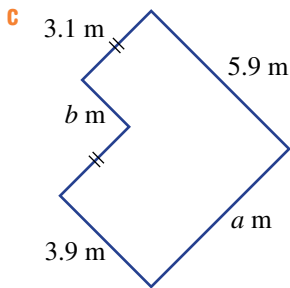
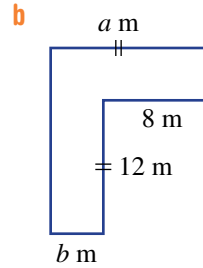
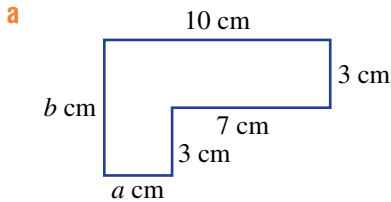



Example 3 Finding perimeters of simple shapes

Find the perimeter of each of the following shapes.

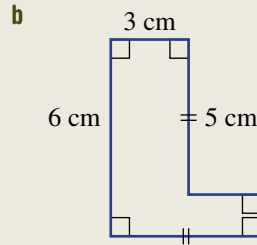
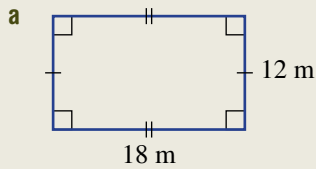

SOLUTION

a Perimeter = $2 \times 12 + 2 \times 18$
 $= 24 + 36$
 $= 60 \text{ m}$

b Perimeter = $(2 \times 5) + 6 + 3 + 2 + 1$
 $= 22 \text{ cm}$

Alternative method:

Perimeter = $2 \times 6 + 2 \times 5$
 $= 22 \text{ cm}$

EXPLANATION

There are two lengths of 12 m and two lengths of 18 m.

Missing sides are:
 $5 \text{ cm} - 3 \text{ cm} = 2 \text{ cm}$
 $6 \text{ cm} - 5 \text{ cm} = 1 \text{ cm}$

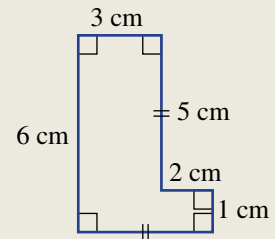

There are two opposite sides each of combined length 6 cm and two opposite sides each of combined length 5 cm.

Now you try

Find the perimeter of each of the following shapes.

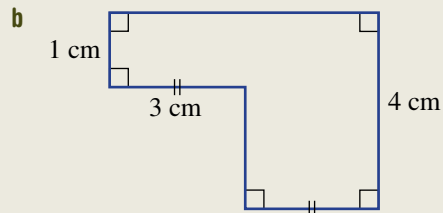
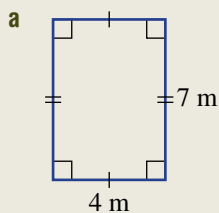



Example 4 Finding missing sides given a perimeter

Find the unknown side length in this shape with the given perimeter.

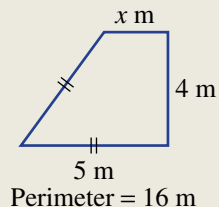

SOLUTION

$$\begin{aligned} 2 \times 5 + 4 + x &= 16 \\ 14 + x &= 16 \\ x &= 2 \end{aligned}$$

\therefore the missing length is 2 m.

EXPLANATION

Add all the lengths and set equal to the given perimeter.

Solve for the unknown.

Now you try

Find the unknown side length in this shape with the given perimeter.

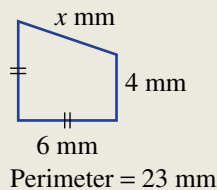

Exercise 5B

FLUENCY

1, $2\frac{1}{2}$, 3, 4 $1-2\frac{1}{2}$, 3, 4, $5\frac{1}{2}$ $2\frac{1}{2}$, 3, 4, $5\frac{1}{2}$

Example 3a

- 1 Find the perimeter of each of the following shapes.

a

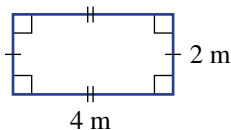

b

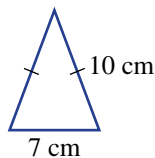

c

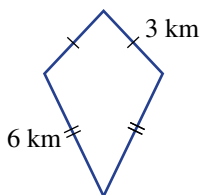

d

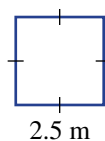

Example 3b

2 Find the perimeter of each of the following composite shapes.

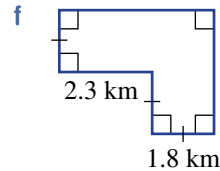
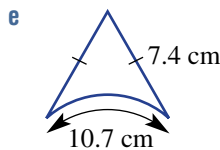
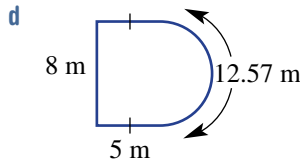
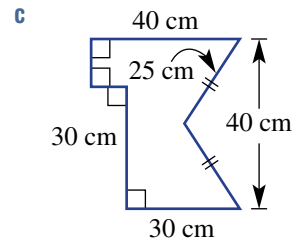
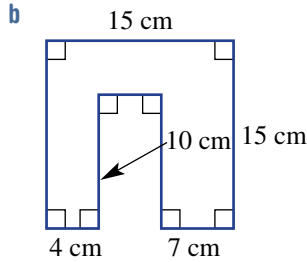
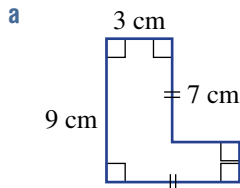

3 Find the perimeter of each of these shapes. You will need to convert the measurements to the same units. Give your answers in the units given in red.

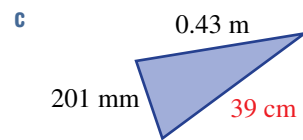
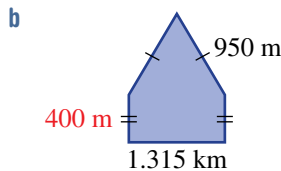
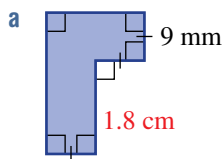

4 Convert the following measurements to the units given in the brackets.

- a 8 m (mm)
- b 110 000 mm (m)
- c 0.00001 km (cm)
- d 0.02 m (mm)
- e 28 400 cm (km)
- f 62 743 000 mm (km)

Example 4

5 Find the unknown side length in these shapes with the given perimeters.

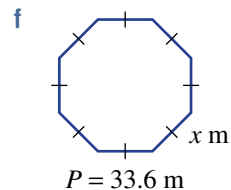
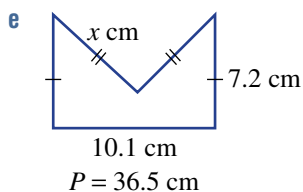
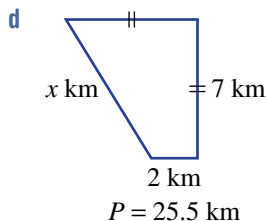
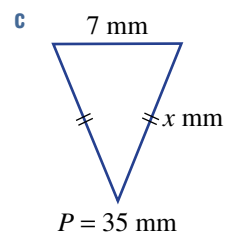
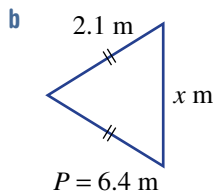
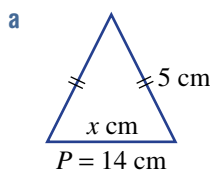

PROBLEM-SOLVING

6, 7

6–8

7–9

- 6 A lion enclosure is made up of five straight fence sections. Three sections are 20 m in length and the other two sections are 15.5 m and 32.5 m. Find the perimeter of the enclosure.



- 7 Find the perimeter of these shapes. Assume all angles are right angles.

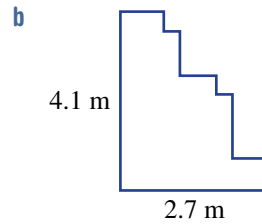
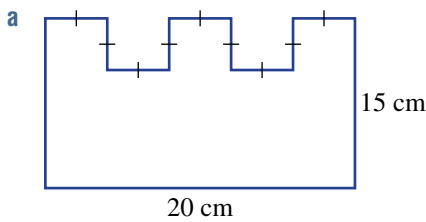

- 8 Find the value of x in these shapes with the given perimeter.

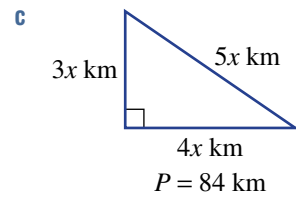
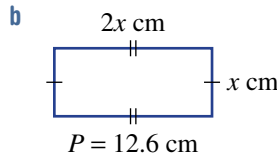
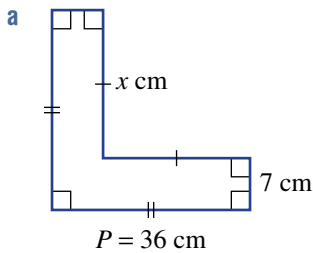

- 9 A photo 12 cm wide and 20 cm long is surrounded by a picture frame 3 cm wide. Find the outside perimeter of the framed photo.

REASONING

10

10, 11

11–13

- 10 Give the rule for the perimeter of these shapes using the given pronumerals, e.g. $P = 3a + 2b$.

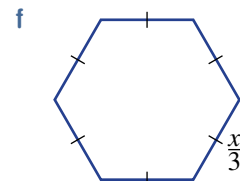
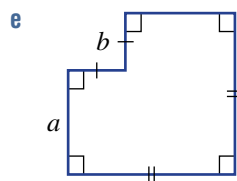
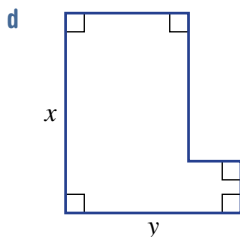
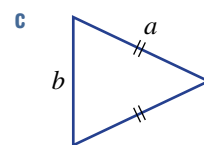
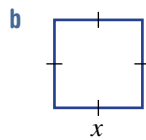
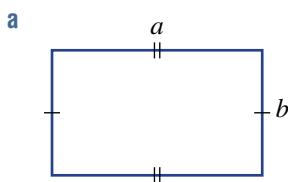

- 11 Explain why you do not need any more information to find the perimeter of this shape, assuming all angles are right angles.

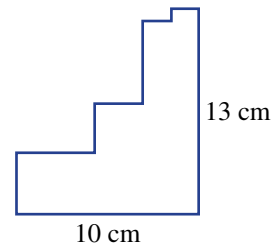

- 12 A square vegetable patch has its side length incorrectly recorded as 2.6 m to one decimal place when it was really 2.4 m.
- Calculate the percentage error for the recorded and actual measurement, correct to one decimal place.
 - Calculate the percentage error for the perimeter of the vegetable patch if the incorrect measurement is used. Round to one decimal place.
 - What do you notice about your answers to parts **a** and **b**?



- 13 A piece of string 1 m long is divided into parts according to the given ratios. Find the length of each part.
- 1 : 3
 - 2 : 3
 - 5 : 3
 - 1 : 2 : 3 : 4

ENRICHMENT: Picture framing

-

-

14

- 14 A square picture of side length 20 cm is surrounded by a frame of width x cm.
- Find the outside perimeter of the framed picture if:
 - $x = 2$
 - $x = 3$
 - $x = 5$
 - Write a rule for the perimeter P of the framed picture in terms of x .
 - Use your rule to find the perimeter if:
 - $x = 3.7$
 - $x = 7.05$
 - Use your rule to find the value of x if:
 - the perimeter is 90 cm
 - the perimeter is 102 cm.
 - Is there a value of x for which the perimeter is 75 cm? Explain.

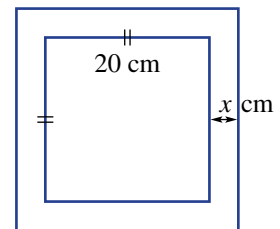

5C Circle circumference and perimeter of a sector

LEARNING INTENTIONS

- To know the features of a circle: circumference, radius, diameter, sector
- To know the formula for the circumference of a circle
- To be able to find an exact circumference or use a calculator to find it to a desired number of decimal places
- To understand that the arc length of a sector represents a fraction of the circumference
- To be able to find the perimeter of a sector

A portion of a circle enclosed by two radii and an arc is called a sector. The perimeter of a sector is made up of three components: two radii and the circular arc. Given an angle θ , it is possible to find the length of the arc using the rule for the circumference of a circle: $C = 2\pi r$ or $C = \pi d$.

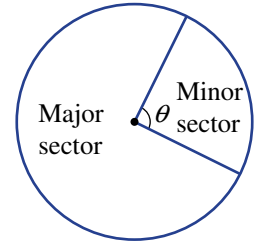

Lesson starter: Perimeter of a sector

A sector is formed by dividing a circle with two radius cuts. The angle between the two radii determines the size of the sector. The perimeter will therefore depend on both the length of the radii and the angle between them.

- Complete this table to see if you can determine a rule for the perimeter of a sector. Remember that the circumference, C , of a circle is given by $C = 2\pi r$ where r is the radius length.

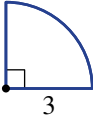
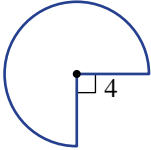
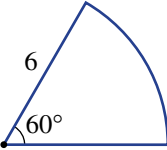
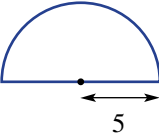
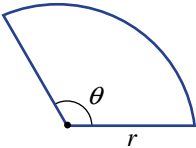
Shape	Fraction of full circle	Working and answer
	$\frac{90}{360} = \frac{1}{4}$	$P = 2 \times 3 + \frac{1}{4} \times 2\pi \times 3 \approx 10.71$
	$\frac{270}{360} =$	$P =$
		$P =$
		$P =$
		$P =$

KEY IDEAS

- **Circumference** of a circle $C = 2\pi r$ or $C = \pi d$.
 - $\frac{22}{7}$ or 3.14 can be used to approximate π or use technology for more precise calculations.
- A **sector** is a portion of a circle enclosed by two radii and an arc. Special sectors include:
 - a half circle, called a **semicircle**
 - a quarter circle, called a **quadrant**.
- The perimeter of a sector is given by $P = 2r + \frac{\theta}{360} \times 2\pi r$.

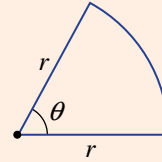
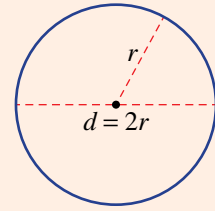

- The symbol for pi (π) can be used to write an answer exactly.

$$\begin{aligned} \text{For example: } C &= 2\pi r \\ &= 2\pi \times 3 \\ &= 6\pi \end{aligned}$$

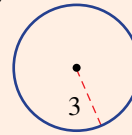

BUILDING UNDERSTANDING

- 1 a What is the radius of a circle if its diameter is 5.6 cm?
b What is the diameter of a circle if its radius is 48 mm?
- 2 Simplify these numbers to give an exact answer. Do not evaluate with a calculator or round off. The first one is done for you.

a $2 \times 3 \times \pi = 6\pi$	b $6 \times 2\pi$	c $3 + \frac{1}{2} \times 4\pi$
d $2 \times 6 + \frac{1}{4} \times 12\pi$	e $2 \times 4 + \frac{90}{360} \times 2 \times \pi \times 4$	f $3 + \frac{270}{360} \times \pi$
- 3 Determine the fraction of a circle shown in these sectors. Write the fraction in simplest form.

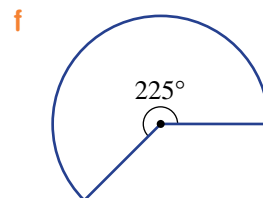
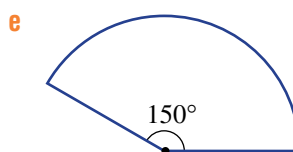
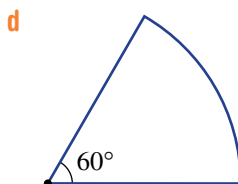
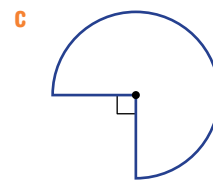
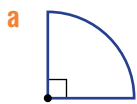



Example 5 Finding the circumference of a circle and the perimeter of a sector of a circle

Find the circumference of this circle and the perimeter of this sector correct to two decimal places.

a

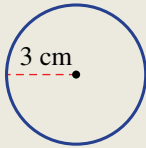

b

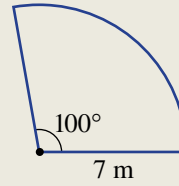

SOLUTION

$$\begin{aligned} \text{a } C &= 2\pi r \\ &= 2 \times \pi \times 3 \\ &= 6\pi \\ &= 18.85 \text{ cm (to 2 d.p.)} \end{aligned}$$

$$\begin{aligned} \text{b } P &= 2r + \frac{\theta}{360} \times 2\pi r \\ &= 2 \times 7 + \frac{100}{360} \times 2 \times \pi \times 7 \\ &= 14 + \frac{35\pi}{9} \\ &= 26.22 \text{ m (to 2 d.p.)} \end{aligned}$$

EXPLANATION

Use the formula $C = 2\pi r$ or $C = \pi d$ and substitute $r = 3$ (or $d = 6$).
 6π would be the exact answer and 18.85 is the rounded answer. Give units.

Write the formula.

The fraction of the circle is $\frac{100}{360}$ (or $\frac{5}{18}$).

$14 + \frac{35\pi}{9}$ is the exact answer.

Use a calculator and round to two decimal places.

Now you try

Find the circumference of this circle and the perimeter of this sector correct to two decimal places.

a

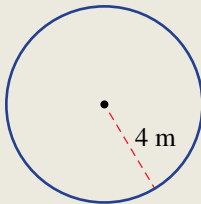

b

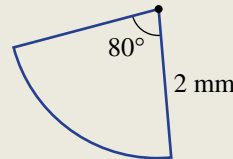

**Example 6** Finding the exact perimeter of a shape

Give the exact circumference/perimeter of these shapes.

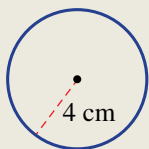
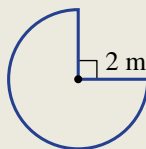
a**b****SOLUTION**

$$\begin{aligned} \text{a } C &= 2\pi r \\ &= 2 \times \pi \times 4 \\ &= 8\pi \text{ cm} \end{aligned}$$

$$\begin{aligned} \text{b } P &= 2 \times r + \frac{\theta}{360} \times 2\pi r \\ &= 2 \times 2 + \frac{270}{360} \times 2\pi \times 2 \\ &= 4 + \frac{3}{4} \times 4\pi \\ &= 4 + 3\pi \text{ m} \end{aligned}$$

EXPLANATIONWrite the formula with $r = 4$:

$$2 \times \pi \times 4 = 2 \times 4 \times \pi$$

Write the answer exactly in terms of π and include units.

Use the perimeter of a sector formula.

The angle inside the sector is 270° so the fraction is $\frac{270}{360} = \frac{3}{4}$. $4 + 3\pi$ cannot be simplified further.**Now you try**

Give the exact circumference/perimeter of these shapes.

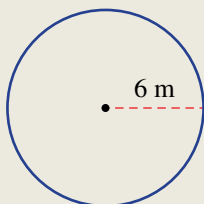
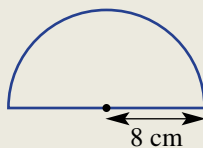
a**b****Exercise 5C****FLUENCY**1, 2–4($\frac{1}{2}$)1, 2–5($\frac{1}{2}$)2–5($\frac{1}{2}$)

Example 5a

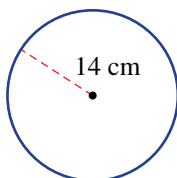
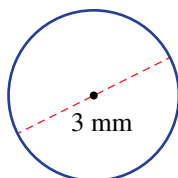
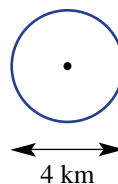
1 Find the circumference of these circles, correct to two decimal places. Use a calculator for the value of π .**a****b****c**

Example 5b

2 Find the perimeter of these sectors, correct to two decimal places.

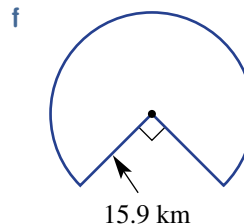
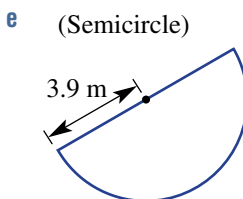
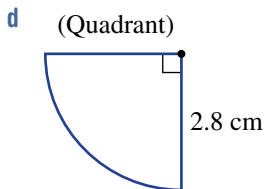
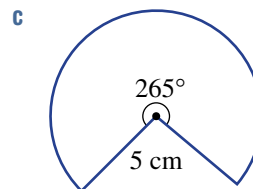
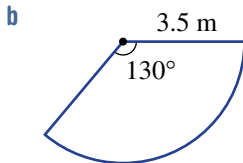
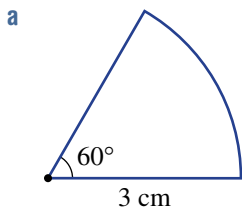

3 Find the circumference of these circles using the given approximation of π . Do not use a calculator.

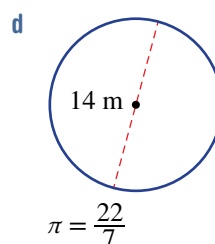
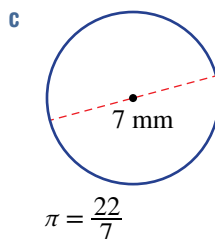
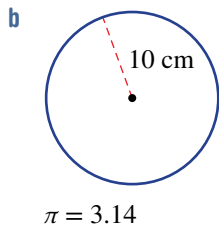
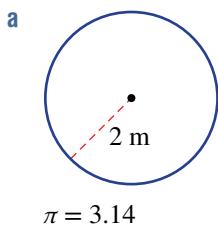

Example 6a

4 Give the exact circumference of these circles.

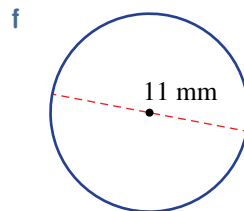
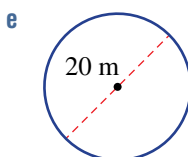
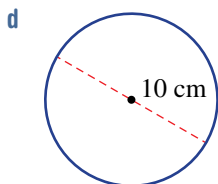
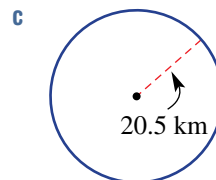
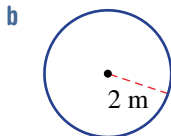
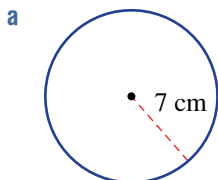

Example 6b

5 Give the exact perimeter of these sectors.

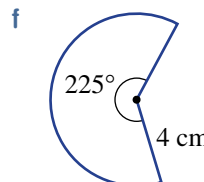
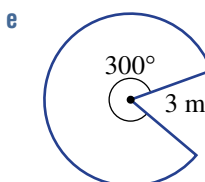
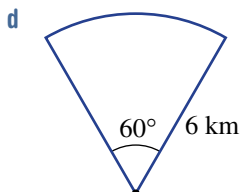
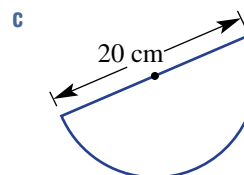
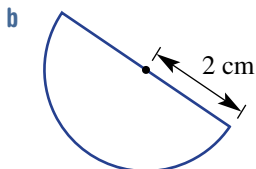
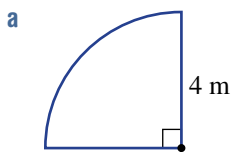

PROBLEM-SOLVING

6, 7

6–8

7–9

- 6 Find the distance around the outside of a circular pool of radius 4.5 m, correct to two decimal places.
- 7 Find the length of string required to surround the circular trunk of a tree that has a diameter of 1.3 m, correct to one decimal place.
- 8 The end of a cylinder has a radius of 5 cm. Find the circumference of the end of the cylinder, correct to two decimal places.
- 9 A wheel of radius 30 cm is rolled in a straight line.
- Find the circumference of the wheel correct to two decimal places.
 - How far, correct to two decimal places, has the wheel rolled after completing:
 - 2 rotations?
 - 10.5 rotations?
 - Can you find how many rotations would be required to cover at least 1 km in length? Round to the nearest whole number.

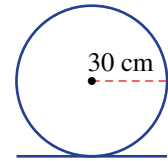

REASONING

10(1/2)

10

10(1/2), 11

- 10 Give exact answers for the perimeter of these shapes.

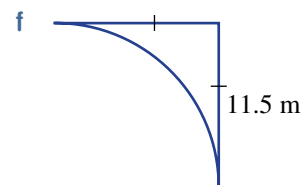
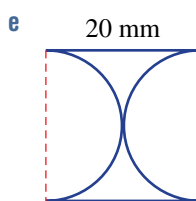
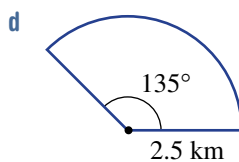
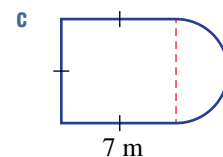
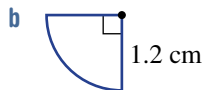
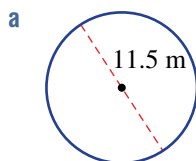

- 11 We know that the rule for the circumference of a circle is $C = 2\pi r$.
- Find a rule for r in terms of C .
 - Find the radius of a circle to one decimal place if its circumference is:
 - 10 cm
 - 25 m
 - Give the rule for the diameter of a circle in terms of its circumference C .
 - After 1000 rotations a wheel has travelled 2.12 km. Find its diameter to the nearest centimetre.

ENRICHMENT: The ferris wheel

–

–

12

- 12 A large ferris wheel has a radius of 21 m. Round the answers to two decimal places for these questions.
- Find the distance a person will travel on one rotation of the wheel.
 - A ride includes six rotations of the wheel. What distance is travelled in one ride?
 - How many rotations would be required to ride a distance of:
 - 500 m?
 - 2 km?
 - Another ferris wheel has a sign which reads, 'One ride of 10 rotations will cover 2 km'. What must be the diameter of the wheel?



5D Area

LEARNING INTENTIONS

- To review the concept of area
- To understand what a square unit represents
- To know how to convert between metric units of area
- To be able to find the area of two-dimensional shapes using their formulas

The number of square centimetres in this rectangle is 6; therefore the area is 6 cm^2 .

A quicker way to find the number of squares is to note that there are two rows of three squares and hence the area is $2 \times 3 = 6 \text{ cm}^2$. This leads to the formula $A = l \times w$ for the area of a rectangle.

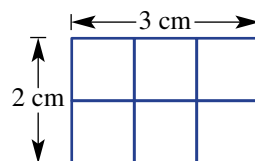

For many common shapes, such as the parallelogram and trapezium, the rules for their area can be developed through consideration of simple rectangles and triangles. Shapes that involve circles or sectors rely on calculations involving pi (π).

Lesson starter: Formula for the area of a sector

We know that the area of a circle with radius r is given by the rule $A = \pi r^2$.

Complete this table of values to develop the rule for the area of a sector.

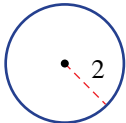
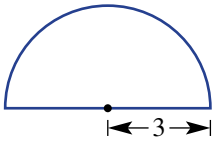
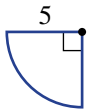
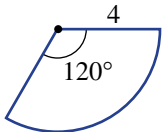
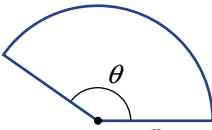
Shape	Fraction of full circle	Working and answer
	1	$A = \pi \times 2^2 \approx 12.57 \text{ units}^2$
	$\frac{180}{360} =$	$A = \frac{1}{2} \times$
		$A =$
		$A =$
		$A =$

KEY IDEAS

■ Conversion of area units

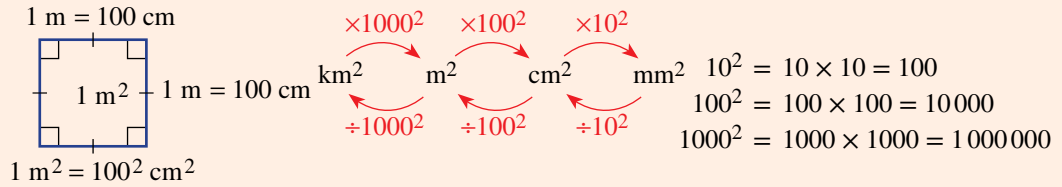

■ The area of a two-dimensional shape is a measure of the space enclosed within its boundaries. Some common formulas are shown.

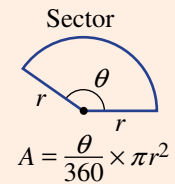
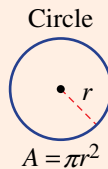
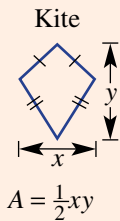
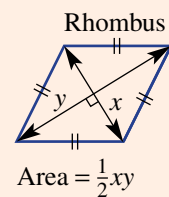
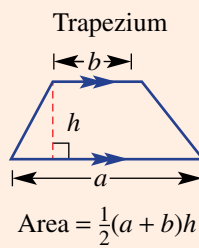
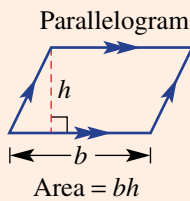
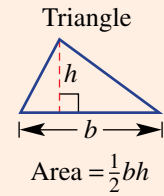
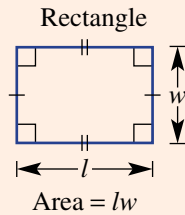
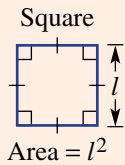

BUILDING UNDERSTANDING

- 1 Count the number of squares to find the area of these shapes. Each square in each shape represents one square unit.

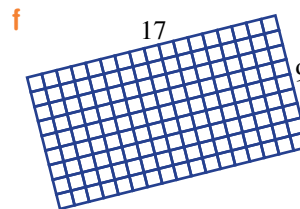
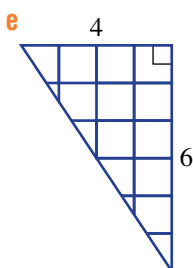
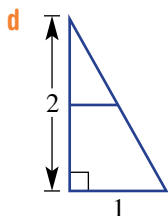
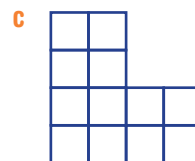
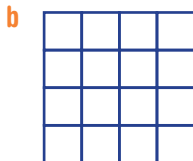
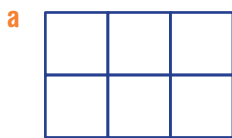

- 2 Name the shape that has the given area formula.

a $A = lw$

b $A = \pi r^2$

c $A = \frac{1}{2}xy$ (2 shapes)

d $A = \frac{\theta}{360} \times \pi r^2$

e $A = \frac{1}{2}bh$

f $A = \frac{1}{2}(a + b)h$

g $A = bh$

h $A = l^2$

i $A = \frac{1}{2}\pi r^2$

- 3 What fraction of a full circle is shown by these sectors? Simplify your fraction.

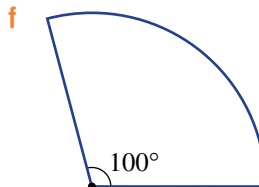
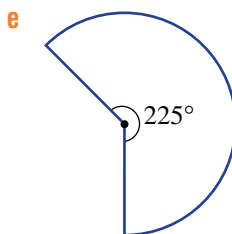
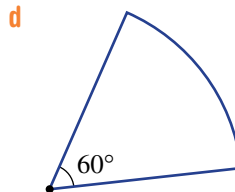
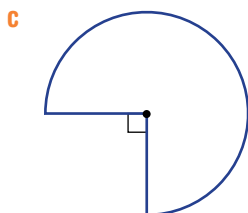
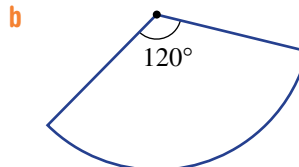
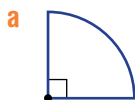

- 4 The shape below represents 3 m^2 .

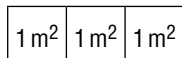

a What is the length and width of the shape in cm?

b Hence, give the area of the shape in cm^2 .

**Example 7** Converting units of area

Convert the following area measurements to the units given in the brackets.

a 859 mm^2 (cm^2)

b 2.37 m^2 (cm^2)

SOLUTION

$$\begin{aligned} \mathbf{a} \quad 859 \text{ mm}^2 &= 859 \div 10^2 \text{ cm}^2 \\ &= 8.59 \text{ cm}^2 \end{aligned}$$

$$\begin{aligned} \mathbf{b} \quad 2.37 \text{ m}^2 &= 2.37 \times 100^2 \text{ cm}^2 \\ &= 23\,700 \text{ cm}^2 \end{aligned}$$

EXPLANATION

$$\begin{array}{ccc} \text{cm}^2 & \text{mm}^2 & 859. \\ & \swarrow & \uparrow \\ & \div 10^2 = 100 & \end{array}$$

$$\begin{array}{ccc} & \times 100^2 = 10\,000 & \\ \text{m}^2 & \searrow & \swarrow \\ & & \text{cm}^2 \end{array} \quad 2.3700$$

Now you try

Convert the following area measurements to the units given in the brackets.

a $14\,210 \text{ cm}^2$ (m^2)

b 3.16 cm^2 (mm^2)

**Example 8** Finding areas of rectangles, triangles and parallelograms

Find the area of each of the following plane figures.

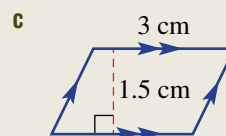
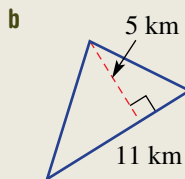
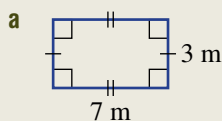
**SOLUTION**

$$\begin{aligned} \mathbf{a} \quad \text{Area} &= l \times w \\ &= 7 \times 3 \\ &= 21 \text{ m}^2 \end{aligned}$$

$$\begin{aligned} \mathbf{b} \quad \text{Area} &= \frac{1}{2} \times b \times h \\ &= \frac{1}{2} \times 11 \times 5 \\ &= 27.5 \text{ km}^2 \end{aligned}$$

$$\begin{aligned} \mathbf{c} \quad \text{Area} &= b \times h \\ &= 3 \times 1.5 \\ &= 4.5 \text{ cm}^2 \end{aligned}$$

EXPLANATION

Use the area formula for a rectangle.
Substitute $l = 7$ and $w = 3$.
Include the correct units.

Use the area formula for a triangle.
Substitute $b = 11$ and $h = 5$.
Include the correct units.

Use the area formula for a parallelogram.
Multiply the base length by the perpendicular height.

Now you try

Find the area of each of the following plane figures.

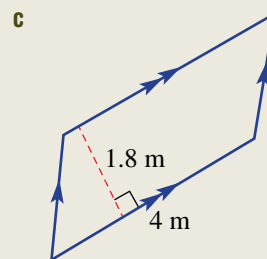
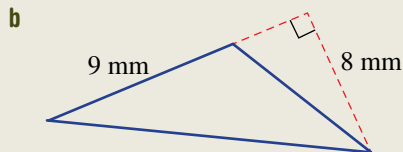
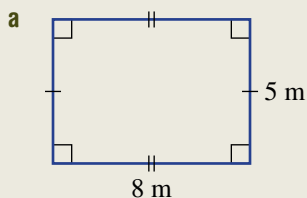

Example 9 Finding areas of rhombuses and trapeziums

Find the area of each of the following plane figures.

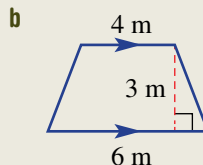
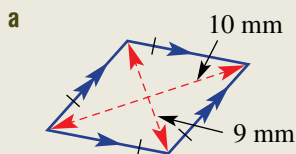

SOLUTION

$$\begin{aligned} \text{a Area} &= \frac{1}{2} \times x \times y \\ &= \frac{1}{2} \times 10 \times 9 \\ &= 45 \text{ mm}^2 \end{aligned}$$

$$\begin{aligned} \text{b Area} &= \frac{1}{2}(a + b)h \\ &= \frac{1}{2}(4 + 6) \times 3 \\ &= 15 \text{ m}^2 \end{aligned}$$

EXPLANATION

Use the area formula for a rhombus.

Substitute $x = 10$ and $y = 9$.

Include the correct units.

Use the area formula for a trapezium.

Substitute $a = 4$, $b = 6$ and $h = 3$.

$$\frac{1}{2} \times (4 + 6) \times 3 = 5 \times 3$$

Now you try

Find the area of each of the following plane figures.

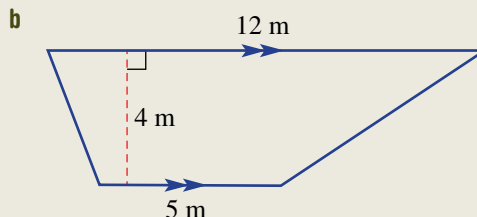
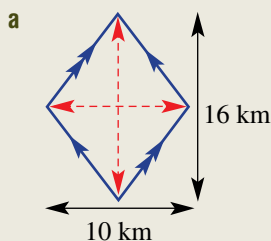



Example 10 Finding areas of circles and sectors

Find the area of this circle and sector correct to two decimal places.

a

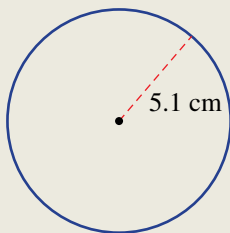

b

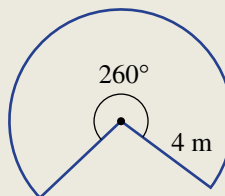

SOLUTION

$$\begin{aligned} \text{a } A &= \pi r^2 \\ &= \pi \times (5.1)^2 \\ &= 81.71 \text{ cm}^2 \text{ (to 2 d.p.)} \end{aligned}$$

$$\begin{aligned} \text{b } A &= \frac{\theta}{360} \times \pi r^2 \\ &= \frac{260}{360} \times \pi \times 4^2 \\ &= \frac{13}{18} \times \pi \times 16 \\ &= 36.30 \text{ m}^2 \text{ (to 2 d.p.)} \end{aligned}$$

EXPLANATION

Write the rule and substitute $r = 5.1$.
81.7128... rounds to 81.71 as the third decimal place is 2.

Use the sector formula.

The fraction of the full circle is $\frac{260}{360} = \frac{13}{18}$,
so multiply this by πr^2 to get the sector area.
 $\frac{104\pi}{9} \text{ m}^2$ would be the exact answer.

Now you try

Find the area of this circle and sector correct to two decimal places.

a

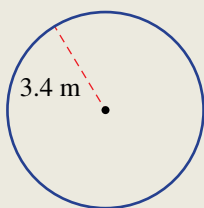

b

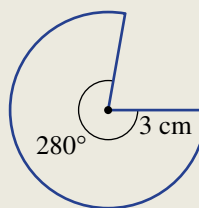

Exercise 5D

FLUENCY

1, 2–5($\frac{1}{2}$), 6, 7($\frac{1}{2}$)

2–5($\frac{1}{2}$), 6, 7($\frac{1}{2}$)

2–5($\frac{1}{3}$), 6, 7($\frac{1}{3}$)

1 Convert the following area measurements to the units given in the brackets.

Example 7a

- a i 236 mm² (cm²)
ii 48 000 cm² (m²)

Example 7b

- b i 4.16 m² (cm²)
ii 3.5 cm² (mm²)

Example 7 2 Convert the following area measurements to the units given in the brackets.

- a 2 cm^2 (mm^2) b 500 mm^2 (cm^2) c 2.1 m^2 (cm^2)
 d $210\,000 \text{ cm}^2$ (m^2) e 0.001 km^2 (m^2) f $3\,200\,000 \text{ m}^2$ (km^2)

Example 8 3 Find the area of each of the following plane figures.

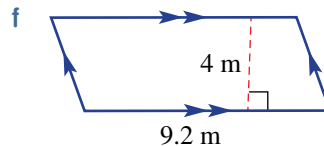
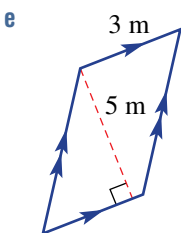
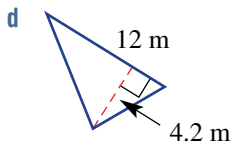
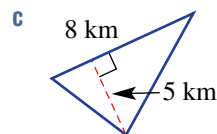
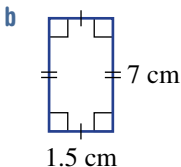
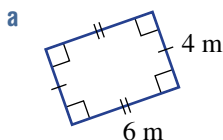

Example 9 4 Find the area of each of the following plane figures.

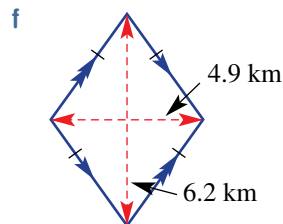
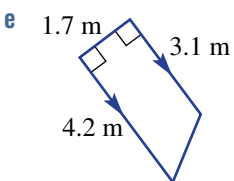
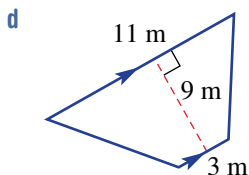
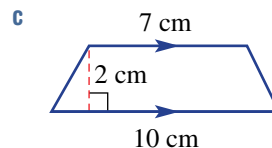
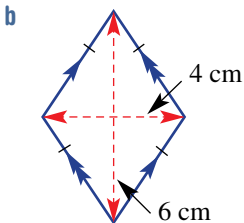
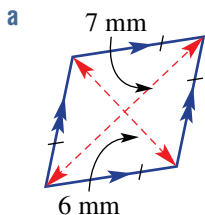

5 Find the area of each of the following mixed plane figures.

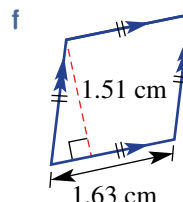
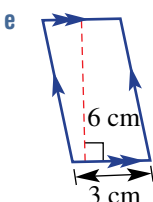
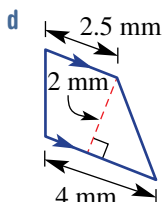
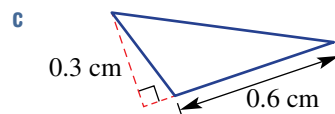
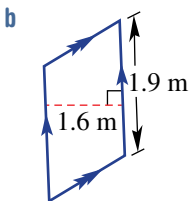
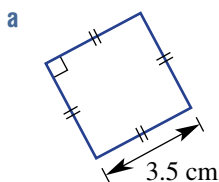

Example 10a 6 Find the area of these circles using the given value for pi (π). Round to two decimal places.



a $\pi = 3.14$

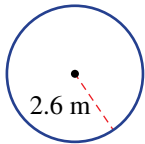

b $\pi = \frac{22}{7}$



c π (from calculator)

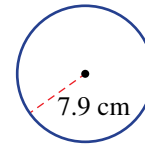

Example 10b 7 Find the area of these sectors rounding to two decimal places.

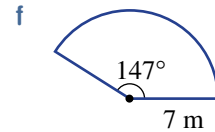
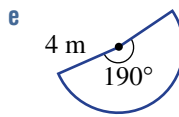
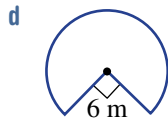
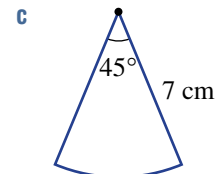
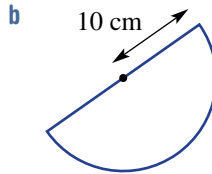
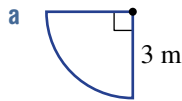

PROBLEM-SOLVING

8–10

8–11

8, 11, 12

8 Convert the following measurements to the units given in the brackets.

a 1.5 km^2 (cm^2)

b 0.000005 m^2 (mm^2)

c $75\,000 \text{ mm}^2$ (m^2)

9 A valuer tells you that your piece of land has an area of one-half a square kilometre (0.5 km^2). How many square metres (m^2) do you own?



10 An old picture frame that was once square now leans to one side to form a rhombus. If the distances between pairs of opposite corners are 85 cm and 1.2 m, find the area enclosed within the frame in m^2 .



11 A pizza shop is considering increasing the diameter of its family pizza tray from 32 cm to 34 cm. Find the percentage increase in area, correct to two decimal places.



12 A tennis court area is illuminated by four corner lights. The illumination of the sector area close to each light is considered to be good (G) while the remaining area is considered to be lit satisfactorily (S).

What percentage of the area is considered ‘good’? Round to the nearest per cent.

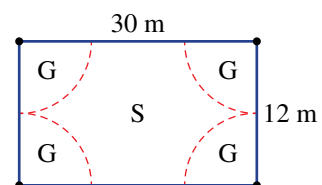

REASONING

13

13

14, 15



13 The rule for the area of a circle is given by $A = \pi r^2$.

a Rearrange this rule to find a rule for r in terms of A .

b Find the radius of a circle with the given areas. Round to one decimal place.

i 5 cm^2

ii 6.9 m^2

iii 20 km^2



14 A sector has a radius of 3 m.

a Find the angle θ , correct to the nearest degree, if its area is:

i 5 m^2

ii 25 m^2

b Explain why the area of the sector could not be 30 m^2 .

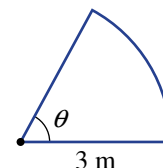

15 The side length of a square is recorded as 6.4 cm.

a Give the upper and lower limits of accuracy for this measurement.

b Find the upper and lower limits for this square's perimeter.

c Find the upper and lower limits for the area of this square, to one decimal place.

ENRICHMENT: Windows

-

-

16, 17



16 Six square windows of side length 2 m are to be placed into a 12 m wide by 8.5 m high wall as shown. The windows are to be positioned so that the vertical spacings between the windows and the wall edges are equal. Similarly, the horizontal spacings are also equal.

a i Find the horizontal distance between the windows.

ii Find the vertical distance between the windows.

b Find the area of the wall not including the window spaces.

c If the wall included 3 rows of 4 windows (instead of 2 rows of 3), investigate if it would be possible to space all the windows so that the horizontal and vertical spacings are uniform (although not necessarily equal to each other).

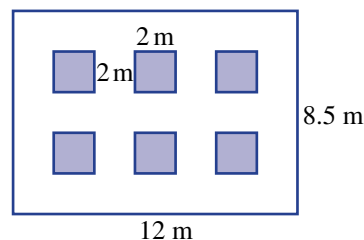

17 A rectangular window is wiped by a wiper blade forming the given sector shape.

What percentage area is cleaned by the wiper blade? Round to one decimal place.

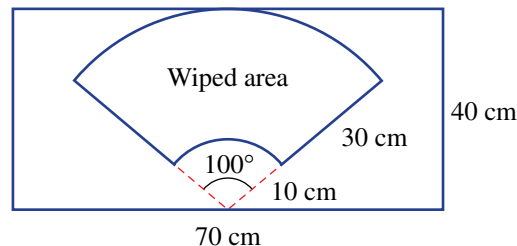

Using a CAS calculator 5D: Measurement formulas

This activity is in the Interactive Textbook in the form of a printable PDF.

5E Perimeter and area of composite shapes

LEARNING INTENTIONS

- To know that composite shapes are made up of more than one basic shape
- To be able to identify the regular shapes that make up a composite shape
- To be able to use addition or subtraction of known shapes to find the perimeter and area of composite shapes

Composite shapes can be thought of as a combination of simpler shapes such as triangles and rectangles. Finding perimeters and areas of such shapes is a matter of identifying the more basic shapes they consist of and combining any calculations in an organised fashion.



For this high-rise office building in Oslo, Norway, the architect has designed windows with triangular, trapezoidal and composite shapes.

Lesson starter: Incorrect layout

Three students write their solution to finding the area of this shape on the board.

Chris	Matt	Moira
$A = l \times w$ $= 50 + \frac{1}{2}\pi r^2$ $= \frac{1}{2}\pi \times 5^2$ $= 39.27 + 50$ $= 89.27 \text{ cm}^2$	$A = \frac{1}{2}\pi \times 5^2$ $= 39.27 + 10 \times 5$ $= 89.27 \text{ cm}^2$	$A = l \times w + \frac{1}{2}\pi r^2$ $= 10 \times 5 + \frac{1}{2}\pi \times 5^2$ $= 89.27 \text{ cm}^2$

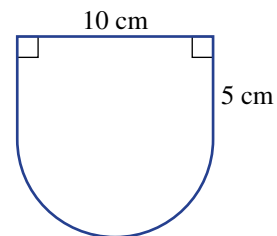

- All three students have the correct answer but only one student receives full marks. Who is it?
- Explain what is wrong with the layout of the other two solutions.

KEY IDEAS

- **Composite shapes** are made up of more than one basic shape.
- Addition and/or subtraction can be used to find areas and perimeters of composite shapes.
- The layout of the relevant mathematical working needs to make sense so that the reader of your work understands each step.

BUILDING UNDERSTANDING

1 Name the two different shapes that make up these composite shapes, e.g. square and semicircle.

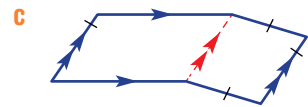
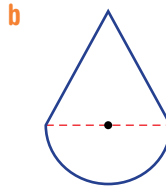

2 State the missing components to complete the working to find the perimeter and area of these composite shapes.

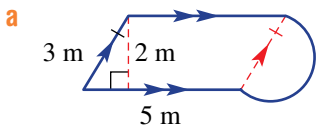

$$\begin{aligned}
 P &= 2 \times \underline{\hspace{2cm}} + 3 + \frac{1}{2} \times 2\pi r \\
 &= \underline{\hspace{2cm}} + 3 + \underline{\hspace{2cm}} \\
 &= \underline{\hspace{2cm}} \text{ m}
 \end{aligned}$$

$$\begin{aligned}
 A &= bh + \frac{1}{2} \underline{\hspace{2cm}} \\
 &= 5 \times \underline{\hspace{2cm}} + \frac{1}{2} \times \underline{\hspace{2cm}} \\
 &= \underline{\hspace{2cm}} + \underline{\hspace{2cm}} \\
 &= \underline{\hspace{2cm}} \text{ m}^2
 \end{aligned}$$

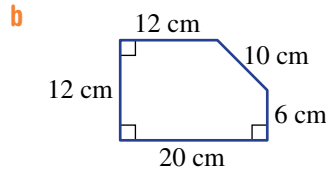

$$\begin{aligned}
 P &= 20 + 12 + \underline{\hspace{2cm}} + \underline{\hspace{2cm}} + \underline{\hspace{2cm}} \\
 &= \underline{\hspace{2cm}} \text{ cm}
 \end{aligned}$$

$$\begin{aligned}
 A &= lw - \frac{1}{2}bh \\
 &= 12 \times \underline{\hspace{2cm}} - \frac{1}{2} \times 8 \times \underline{\hspace{2cm}} \\
 &= \underline{\hspace{2cm}} - \underline{\hspace{2cm}} \\
 &= \underline{\hspace{2cm}} \text{ cm}^2
 \end{aligned}$$

Example 11 Finding perimeters and areas of composite shapes

Find the perimeter and area of this composite shape, rounding answers to two decimal places.

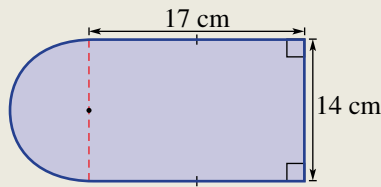

SOLUTION

$$\begin{aligned} P &= 2 \times l + w + \frac{1}{2} \times 2\pi r \\ &= 2 \times 17 + 14 + \frac{1}{2} \times 2\pi \times 7 \\ &= 34 + 14 + \pi \times 7 \\ &= 69.99 \text{ cm (to 2 d.p.)} \end{aligned}$$

$$\begin{aligned} A &= l \times w + \frac{1}{2}\pi r^2 \\ &= 17 \times 14 + \frac{1}{2} \times \pi \times 7^2 \\ &= 238 + \frac{1}{2} \times \pi \times 49 \\ &= 314.97 \text{ cm}^2 \text{ (to 2 d.p.)} \end{aligned}$$

EXPLANATION

3 straight sides \square + semicircle arc \frown

Substitute $l = 17$, $w = 14$ and $r = 7$.

Simplify.

Calculate and round to two decimal places.

Area of rectangle \square + area of semicircle \frown

Substitute $l = 17$, $w = 14$ and $r = 7$.

Simplify.

Calculate and round to two decimal places.

Now you try

Find the perimeter and area of this composite shape, rounding answers to two decimal places.

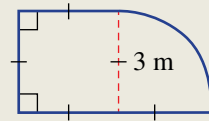

Example 12 Finding an area using subtraction

Find the shaded area of this composite shape.

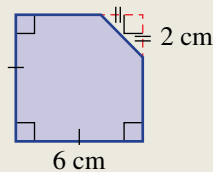

SOLUTION

$$\begin{aligned} \text{Shaded area} &= l^2 - \frac{1}{2}bh \\ &= 6 \times 6 - \frac{1}{2} \times 2 \times 2 \\ &= 36 - 2 \\ &= 34 \text{ cm}^2 \end{aligned}$$

EXPLANATION

Use the full outer square and subtract the triangle area in the top right corner.

Include units.

Now you try

Find the shaded area of this composite shape.

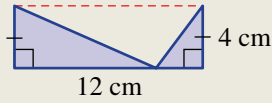

Exercise 5E

FLUENCY

1–3(1/2)

1–4(1/2)

1–4(1/2)

- Example 11** 1 Find the perimeter and the area of each of these simple composite shapes, rounding answers to two decimal places where necessary.

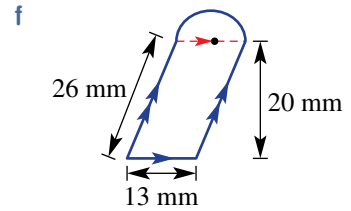
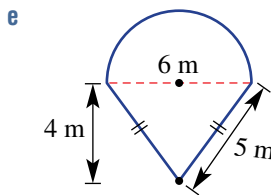
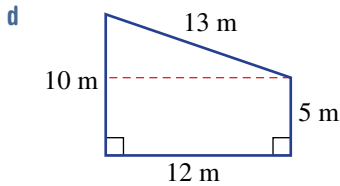
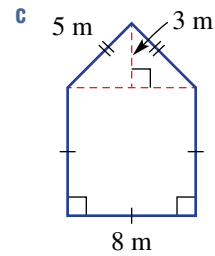
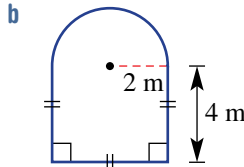
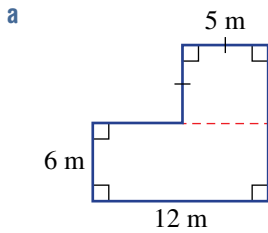

- 2 Find the area of the following composite shapes.

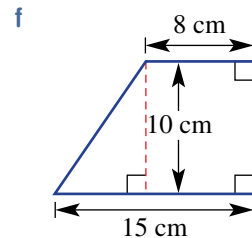
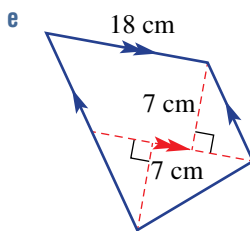
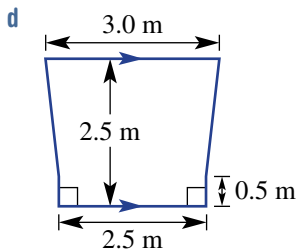
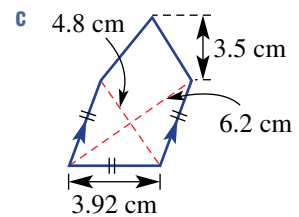
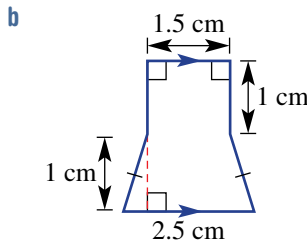
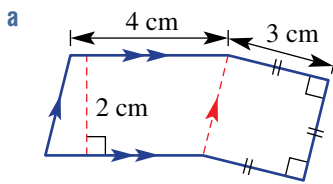

Example 12 3 Find the shaded area of each of these composite shapes.

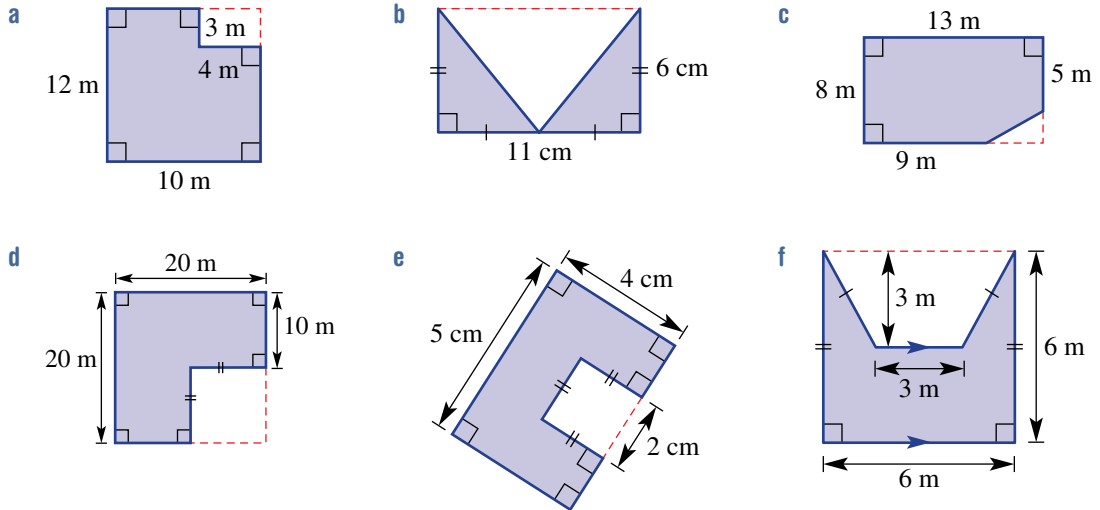

4 Find the area of the shaded region of the following shapes. Round to one decimal place where necessary.

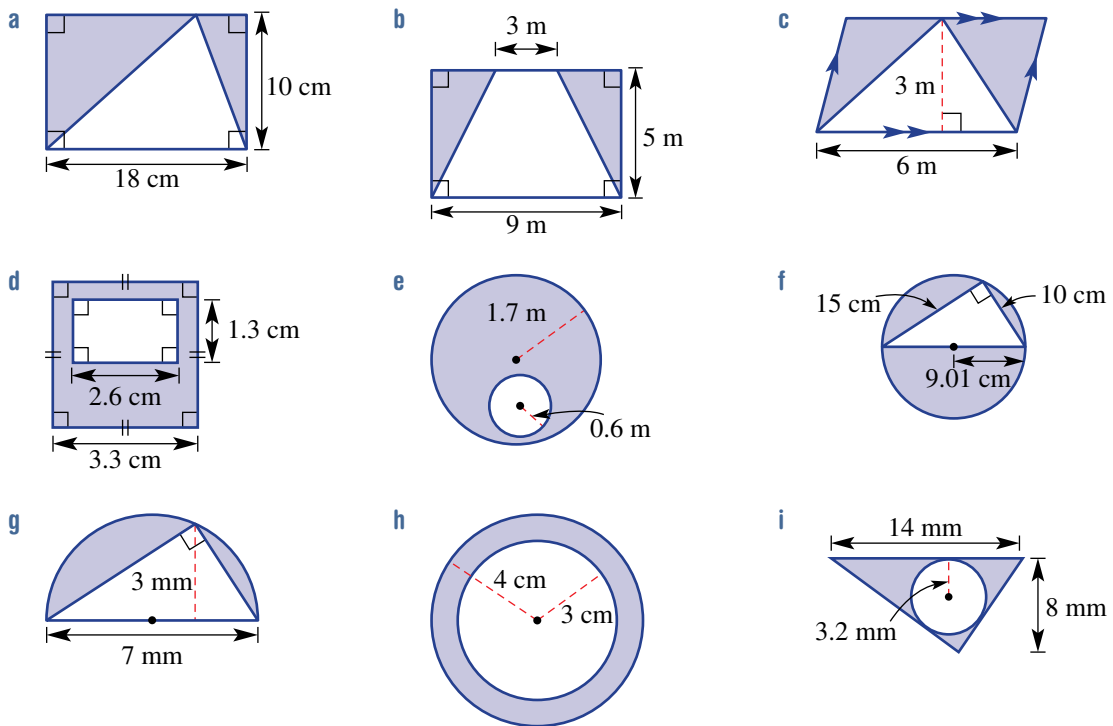

PROBLEM-SOLVING

5, 6

6, 7(1/2), 8

6–9



5 An area of lawn is made up of a rectangle measuring 10 m by 15 m and a semicircle of radius 5 m. Find the total area of lawn, correct to two decimal places.



6 Twenty circular pieces of pastry, each of diameter 4 cm, are cut from a rectangular sheet of pastry 20 cm long and 16 cm wide. What is the area, correct to two decimal places, of pastry remaining after the 20 pieces are removed?

- 7 Find the perimeter and the area of the following composite shapes, correct to two decimal places where necessary.

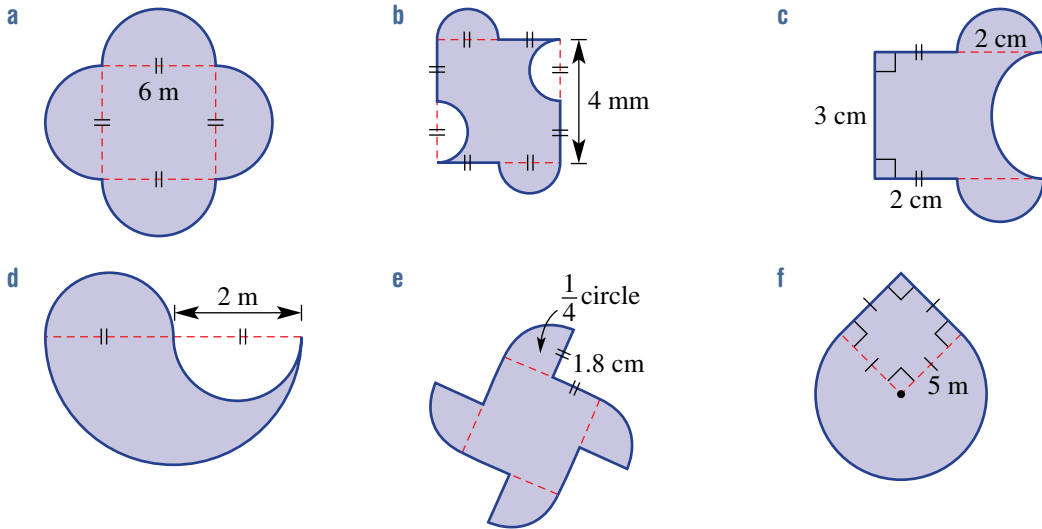

- 8 These shapes include sectors. Find their area, correct to one decimal place.

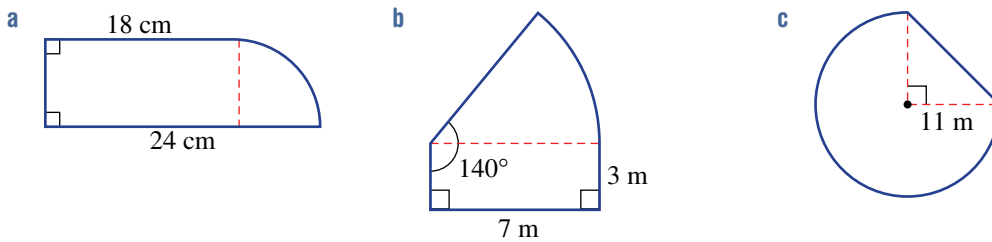

- 9 A new car manufacturer is designing a logo. It is in the shape of a diamond inside a rectangle. The diamond is to have a horizontal width of 3 cm and an area equal to one-sixth of the area of the rectangle. Find the required height of the diamond.

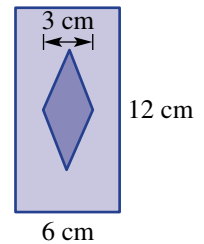

REASONING 10(1/2) 10, 11 10(1/2), 11, 12

10 Using exact values (e.g. $10 + 4\pi$), find the area of the shapes given in Question 7.

11 A circle of radius 10 cm has a hole cut out of its centre to form a ring. Find the radius of the hole if the remaining area is 50% of the original area. Round to one decimal place.

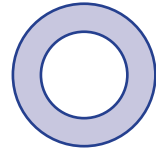

12 Use Pythagoras' theorem (illustrated in this diagram) to help explain why these composite shapes include incorrect information.

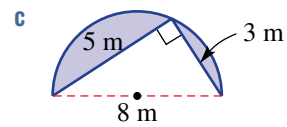
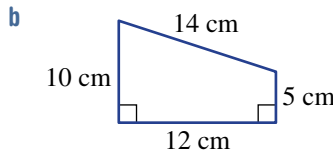
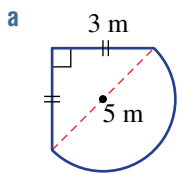
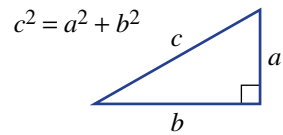

ENRICHMENT: Construction cut-outs - - 13, 14

13 The front of a grandfather clock consists of a timber board with dimensions as shown. A circle of radius 20 cm is cut from the board to form the clock face. Find the remaining area of the timber board correct to one decimal place.

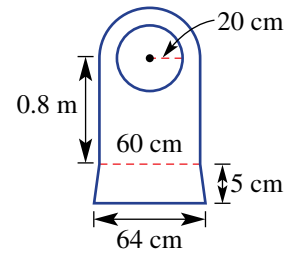

14 The number 10 is cut from a rectangular piece of paper. The dimensions of the design are shown below.

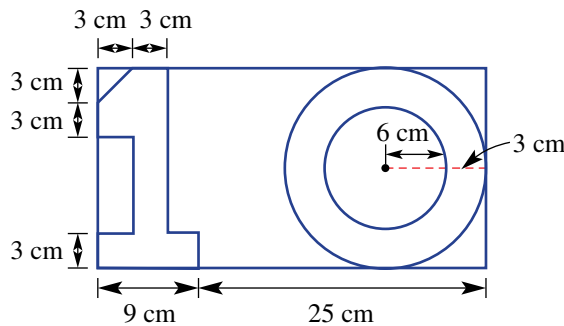

- a Find the length and width of the rectangular piece of paper.
- b Find the sum of the areas of the two cut-out digits, 1 and 0, correct to one decimal place.
- c Find the area of paper remaining after the digits have been removed (include the centre of the '0' in your answer) and round to one decimal place.

5A 1 Calculate the absolute percentage error if the recorded measurement is 1.2 m but the actual measurement is 1.5 m.

5A 2 Lengths of ribbon are measured with a tape measure with markings correct to the millimetre. A length of ribbon is measured as 25.4 cm. State the lower and upper limits of accuracy for this measurement.

5B/C 3 Find the perimeter of each of the following shapes. Round to one decimal place in part **b**.

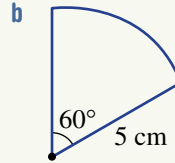
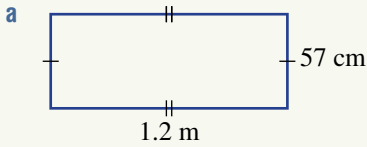

5C/5D



4 Find, correct to one decimal place, the circumference and area of these circles.

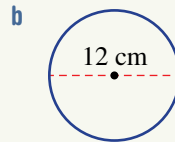
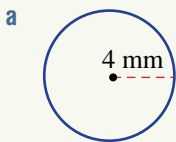

5D



5 Find the exact area of the following.

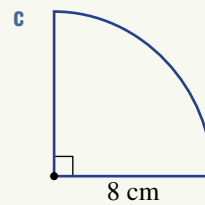
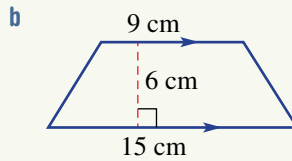
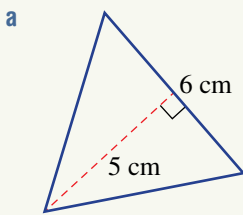

5D

6 Convert $85\,000\text{ mm}^2$ to cm^2 .

5E



7 Find the perimeter and area of these composite shapes, rounding answers to two decimal places in part **a**. (*Hint: Use Pythagoras' theorem in part b.*)

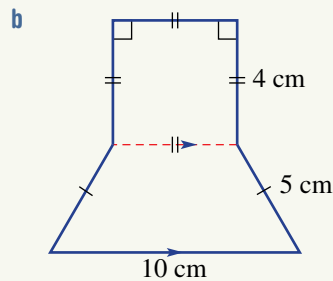
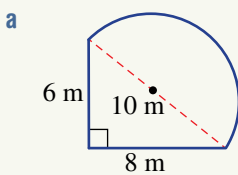

5E

8 Find, correct to two decimal places, the area of the shaded region.

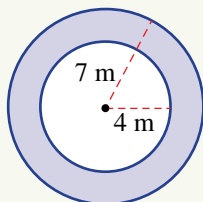

5F Surface area of prisms and pyramids

LEARNING INTENTIONS

- To understand what is meant by the surface area of a solid
- To know how to identify the surfaces of a three-dimensional shape using a net or otherwise
- To be able to use area formulas to calculate the surface area of a prism or pyramid

Three-dimensional objects or solids have outside surfaces that together form the surface area. Nets are very helpful for determining the number and shape of the surfaces of a three-dimensional object.

For this section we will deal with right prisms and pyramids. A right prism has a uniform cross-section with two identical ends and the remaining sides are rectangles. A right pyramid has its apex sitting above the centre of its base.

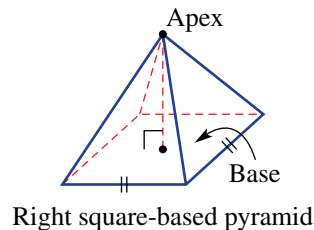
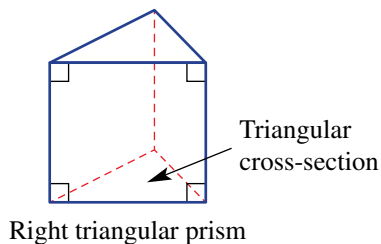

Lesson starter: Drawing prisms and pyramids

Prisms are named by the shape of their cross-section and pyramids by the shape of their base.

- Try to draw as many different right prisms and pyramids as you can.
- Describe the different kinds of shapes that make up the surface of your solids.
- Which solids are the most difficult to draw and why?

Truncated icosahedron

An icosahedron has 20 equilateral triangle faces. If its 12 vertices are truncated, i.e. sliced off, it then has 20 hexagon and 12 pentagon faces. These faces form the surface area net of a soccer ball.

KEY IDEAS

- The **surface area** (A) of a solid is the sum of the areas of all the surfaces.
- A **net** is a two-dimensional illustration of all the surfaces of a solid.
- A right **prism** is a solid with a uniform cross-section with two identical ends and the remaining sides are rectangles.
 - They are named by the shape of their cross-section.

■ The nets for a **rectangular prism (cuboid)** and square-based **pyramid** are shown here.

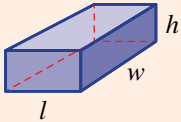
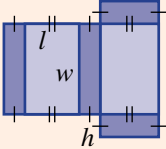
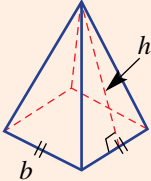
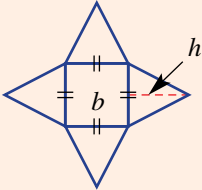
Solid	Net	A
Rectangular prism 		$A = 2 \times \text{top} + 2 \times \text{side} + 2 \times \text{end}$ $A = 2lw + 2wh + 2lh$
Square-based pyramid 		$A = \text{base} + 4 \times \text{side}$ $A = b^2 + 4\left(\frac{1}{2}bh\right)$ $= b^2 + 2bh$

BUILDING UNDERSTANDING

1 Sketch a suitable net for these prisms and pyramids and name each solid.

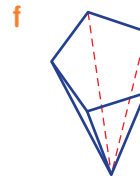
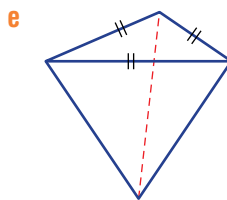
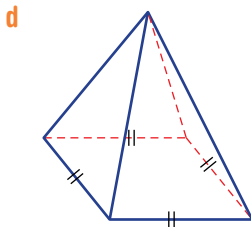
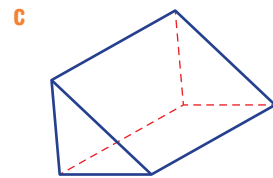
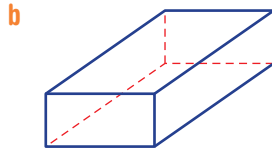
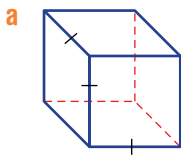

2 State the missing components to complete the working to find the surface area of these solids.

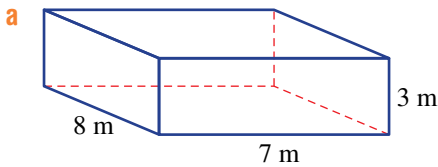

$$\begin{aligned}
 A &= 2 \times 8 \times 7 + 2 \times 8 \times \underline{\quad} \\
 &\quad + 2 \times \underline{\quad} \times \underline{\quad} \\
 &= \underline{\quad} + \underline{\quad} + \underline{\quad} \\
 &= \underline{\quad} \text{ m}^2
 \end{aligned}$$

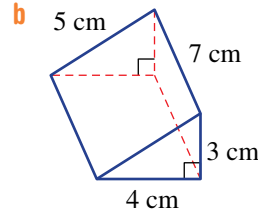

$$\begin{aligned}
 A &= 2 \times \frac{1}{2} \times 4 \times \underline{\quad} + 5 \times 7 \\
 &\quad + 4 \times \underline{\quad} + \underline{\quad} \times \underline{\quad} \\
 &= \underline{\quad} + \underline{\quad} + \underline{\quad} + \underline{\quad} \\
 &= \underline{\quad} \text{ cm}^2
 \end{aligned}$$



Example 13 Finding a surface area

Find the surface area of this right rectangular prism and this right square-based pyramid.

a

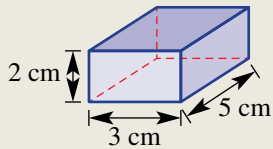

b

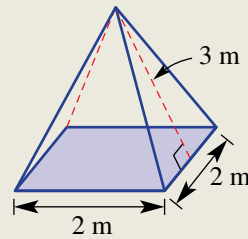

SOLUTION

a $A = 2 \times \text{top} + 2 \times \text{side} + 2 \times \text{end}$

$$\begin{aligned} A &= 2 \times (5 \times 3) + 2 \times (5 \times 2) + 2 \times (2 \times 3) \\ &= 30 + 20 + 12 \\ &= 62 \text{ cm}^2 \end{aligned}$$

EXPLANATION

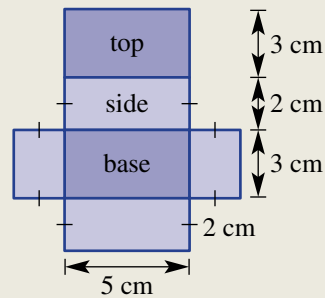

b $A = \text{base} + 4 \times \text{side}$

$$\begin{aligned} A &= 2 \times 2 + 4 \times \frac{1}{2} \times 2 \times 3 \\ &= 4 + 12 \\ &= 16 \text{ m}^2 \end{aligned}$$

Square base + 4 identical triangles

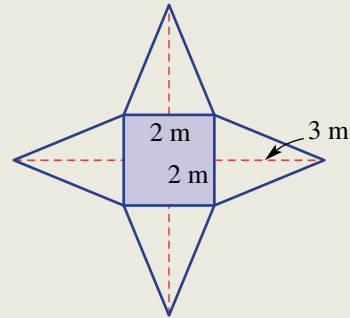

Now you try

Find the surface area of this right rectangular prism and this right square-based pyramid.

a

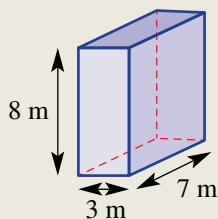

b

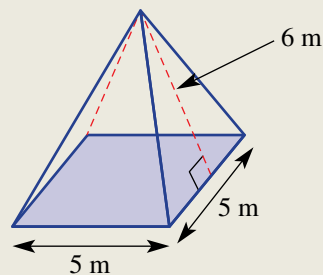

Exercise 5F

FLUENCY

1, 2, 3(1/2)

1, 2, 3(1/2), 4

1-2(1/3), 3(1/2), 4

Example 13a 1 Find the surface area of the following right rectangular prisms. Draw a net of the solid to help you.

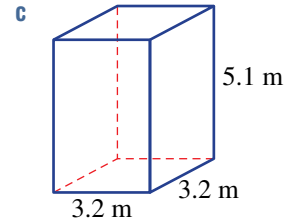
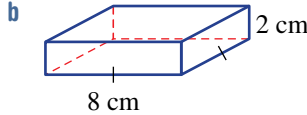
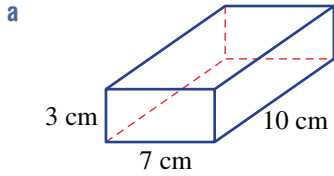

Example 13b 2 Find the surface area of each of these right square-based pyramids. Draw a net to help you.

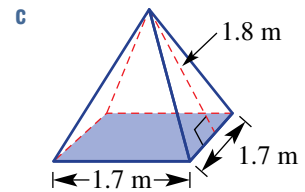
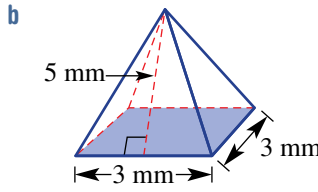
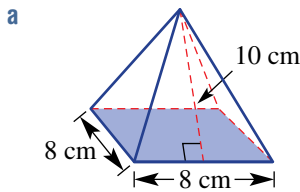

3 Find the surface area of each of the following solid objects.

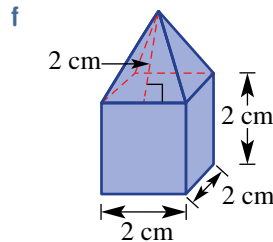
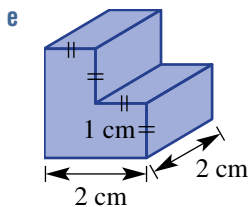
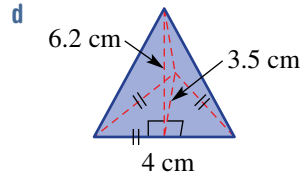
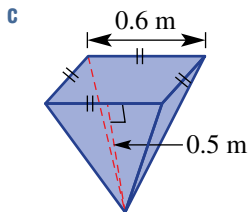
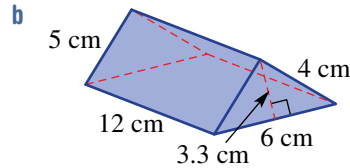
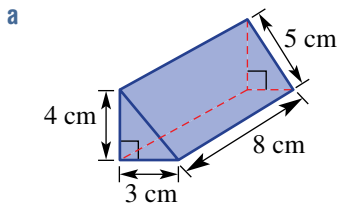

4 Find the surface area of a cube of side length 1 metre.

PROBLEM-SOLVING 5, 6 6, 7 7, 8

5 A rectangular box is to be covered in material. How much is required to cover the entire box if it has the dimensions 1.3 m, 1.5 m and 1.9 m?

6 Two wooden boxes, both with dimensions 80 cm, 1 m and 25 cm, are placed on the ground, one on top of the other as shown. The entire outside surface is then painted. Find the area of the painted surface.

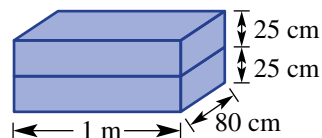

7 The outside four walls and roof of a barn (shown) are to be painted.
a Find the surface area of the barn, not including the floor.
b If 1 litre of paint covers 10 m^2 , find how many litres are required to complete the job.

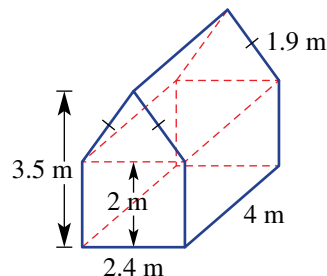

8 An open top rectangular box 20 cm wide, 25 cm long and 10 cm high is made from wood 1 cm thick. Find the surface area:
a outside the box (do not include the top edge)
b inside the box (do not include the top edge).

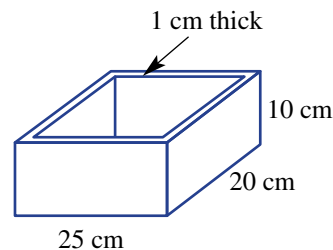

REASONING 9 9 9, 10

9 Draw the stack of 1 cm cube blocks that gives the minimum outside surface area and state this surface area if there are:
a 2 blocks **b** 4 blocks **c** 8 blocks

10 Cubes of side length one unit are stacked as shown.

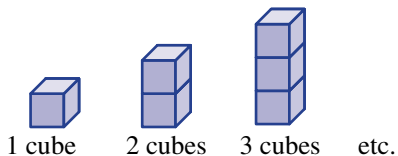

a Complete this table.

Number of cubes (n)	1	2	3	4	5	6	7	8	9
Surface area (S)									

- b Can you find the rule for the surface area (S) for n cubes stacked in this way? Write down the rule for S in terms of n .
- c Investigate other ways of stacking cubes and look for rules for surface area in terms of n , the number of cubes.

ENRICHMENT: Pythagoras required - - 11

11 For prisms and pyramids involving triangles, Pythagoras' theorem ($c^2 = a^2 + b^2$) can be used. Apply the theorem to help find the surface area of these solids. Round to one decimal place.

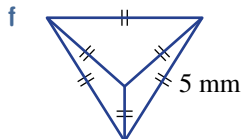
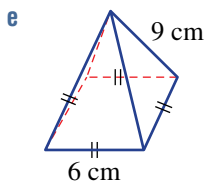
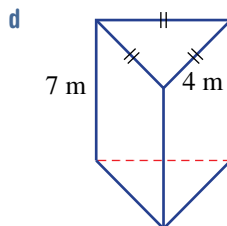
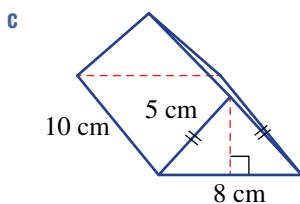
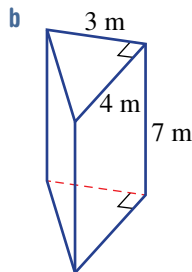
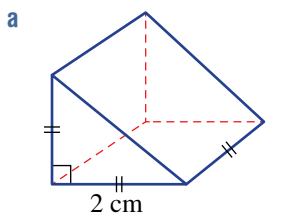

$$a^2 + b^2 = c^2$$

5G Surface area of cylinders

LEARNING INTENTIONS

- To know the shapes that form the net of a cylinder
- To know the formulas for the area of the different surfaces of a cylinder
- To be able to find the surface area of a cylinder and identify which surfaces to include
- To be able to adapt the formulas to find the surface area of cylindrical portions

The net of a cylinder includes two circles and one rectangle with the length of the rectangle equal to the circumference of the circle. The sum of the area of all these shapes will give the surface area of a cylinder.

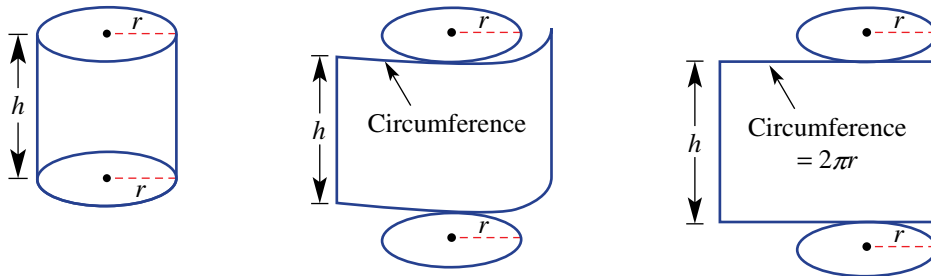

Lesson starter: Curved area

- Roll a piece of paper to form the curved surface of a cylinder.
- Do not stick the ends together because this will allow the paper to return to a flat surface.
- What shape is the paper when lying flat on a table?
- When curved to form the cylinder, what do the sides of the rectangle represent on the cylinder?
How does this help to find the surface area of a cylinder?



KEY IDEAS

- Surface area of a **cylinder** = 2 circles + 1 rectangle

$$= 2 \times \pi r^2 + 2\pi r \times h$$

$$\therefore A = 2\pi r^2 + 2\pi rh$$

2 circular ends

curved area

- $A = 2\pi r^2 + 2\pi rh = 2\pi r(r + h)$

- In many problems, you will need to decide which parts of the surface of the cylinder should be included.

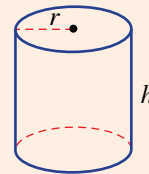

BUILDING UNDERSTANDING

- 1 Sketch a net suited to these cylinders. Label the sides using the given measurements. C represents the circumference.

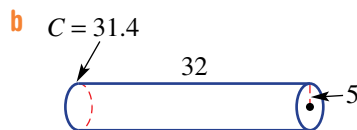
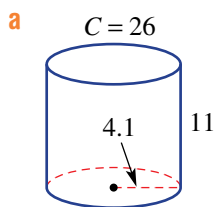

- 2 The curved surface of these cylinders is flattened out to form a rectangle. What would be the length and width of each rectangle? Round to two decimal places where necessary.

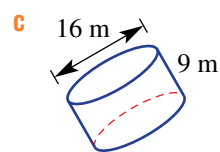
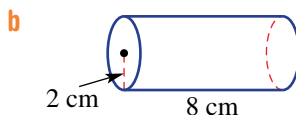
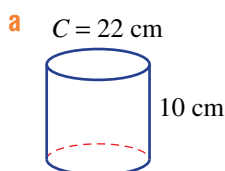

Example 14 Finding the surface area of a cylinder

Find the surface area of this cylinder, rounding to two decimal places.

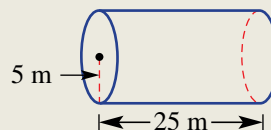

SOLUTION

$$\begin{aligned}
 A &= 2\pi r^2 + 2\pi rh \\
 &= 2 \times \pi \times 5^2 + 2\pi \times 5 \times 25 \\
 &= 50 \times \pi + 250 \times \pi \\
 &= 50\pi + 250\pi \\
 &= 300\pi \\
 &= 942.48 \text{ m}^2 \text{ (to 2 d.p.)}
 \end{aligned}$$

EXPLANATION

Surface area is made up of 2 circular ends and one rolled rectangular side.

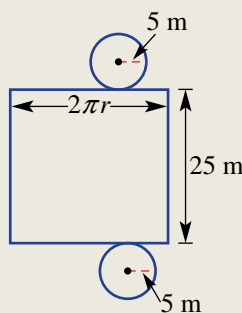

Apply the formula with $r = 5$ and $h = 25$.
Round as required.

Now you try

Find the surface area of this cylinder, rounding to two decimal places.

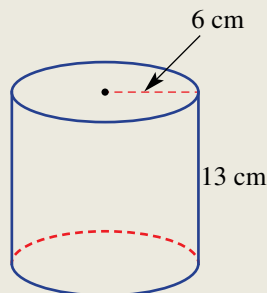



Example 15 Finding surface areas of cylindrical portions

Find the surface area of this half cylinder, rounding to two decimal places.

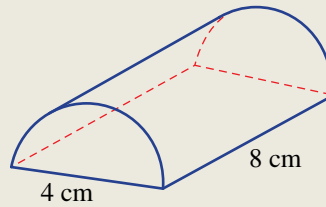

SOLUTION

$$\begin{aligned} A &= 2\left(\frac{1}{2}\pi r^2\right) + \frac{1}{2}(2\pi r) \times 8 + 4 \times 8 \\ &= 2 \times \frac{1}{2}\pi \times 2^2 + \frac{1}{2} \times 2 \times \pi \times 2 \times 8 + 32 \\ &= 20\pi + 32 \\ &= 94.83 \text{ cm}^2 \text{ (to 2 d.p.)} \end{aligned}$$

EXPLANATION

As well as half the curved surface of the cylinder, include the rectangular base (4×8) and the two semicircular ends ($\frac{1}{2}\pi r^2$) each with $r = 2$.

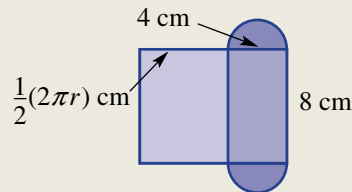

Now you try

Find the surface area of this half cylinder, rounding to two decimal places.

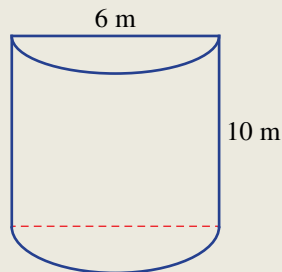

If three tennis balls fit exactly into a cylindrical tube, which is greater, the tube's height or its top circumference?

Exercise 5G

FLUENCY

1–3

1–4

2–4

Example 14



- 1 Find the surface area of these cylinders, rounding to two decimal places. Use a net to help.

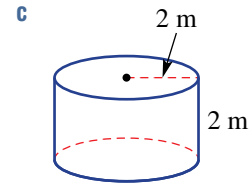
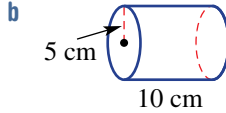
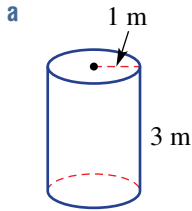

- 2 Find the surface area of these cylinders, rounding to one decimal place. Remember that the radius of a circle is half the diameter.

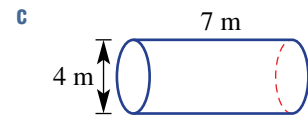
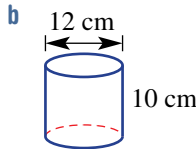
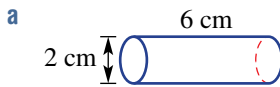

- 3 Find the surface area of a cylindrical plastic container of height 18 cm and with a circle of radius 3 cm at each end. Give the answer correct to two decimal places.



- 4 Find the area of the curved surface only for these cylinders, correct to two decimal places.

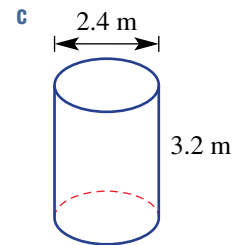
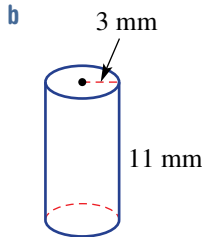
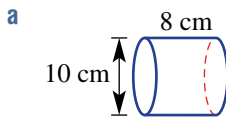

PROBLEM-SOLVING

$5\frac{1}{2}$, 6

$5\frac{1}{2}$, 6, 7

$5\frac{1}{2}$, 7, 8

Example 15

- 5 Find the surface area of these solids, rounding to two decimal places.

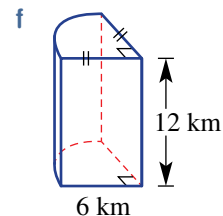
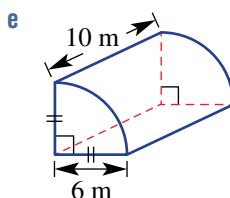
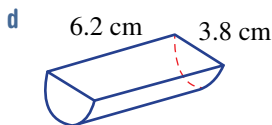
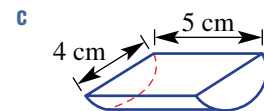
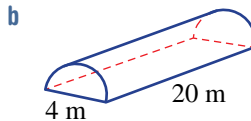
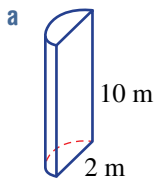

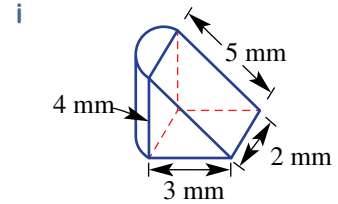
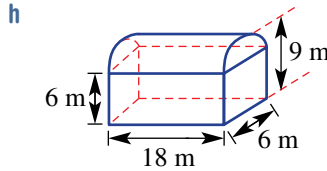
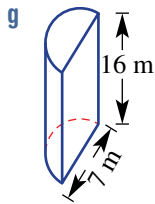

6 A water trough is in the shape of a half cylinder. Its semicircular ends have diameter 40 cm and the trough length is 1 m. Find the outside surface area in cm^2 of the curved surface plus the two semicircular ends, correct to two decimal places.

7 A log with diameter 60 cm is 3 m in length. Its hollow centre is 20 cm in diameter. Find the surface area of the log in cm^2 , including the ends and the inside, correct to one decimal place.

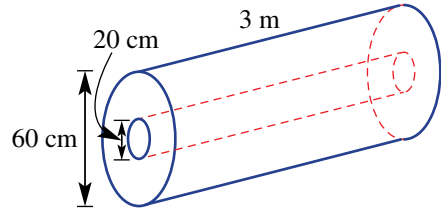

8 A cylindrical roller is used to press crushed rock in preparation for a tennis court. The rectangular tennis court area is 30 m long and 15 m wide. The roller has a width of 1 m and diameter 60 cm.

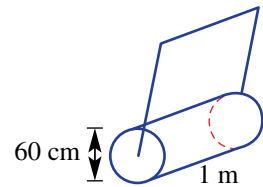

- Find the surface area of the curved part of the roller in cm^2 correct to three decimal places.
- Find the area, in m^2 to two decimal places, of crushed rock that can be pressed after:
 - 1 revolution
 - 20 revolutions.
- Find the minimum number of complete revolutions required to press the entire tennis court area.

REASONING	9	9, 10	9, 10
------------------	---	-------	-------

- 9** It is more precise to give exact values for calculations involving π , e.g. 24π . Give the exact answers for the surface area of the cylinders in Question 1.
- 10** A cylinder cut in half gives half the volume but not half the surface area. Explain why.

ENRICHMENT: Solid sectors	–	–	11
----------------------------------	---	---	----

11 The sector area rule $A = \frac{\theta}{360} \times \pi r^2$ can be applied to find the surface areas of solids which have ends that are sectors. Find the exact surface area of these solids.

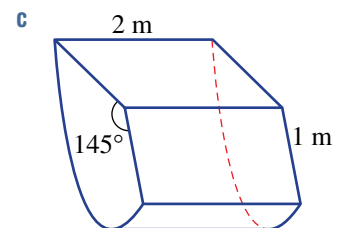
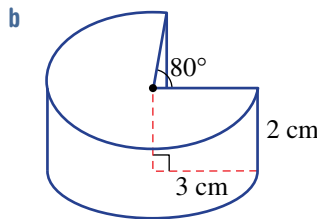
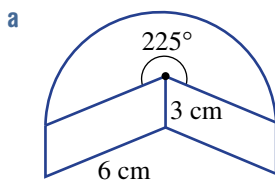

The following problems will investigate practical situations drawing upon knowledge and skills developed throughout the chapter. In attempting to solve these problems, aim to identify the key information, use diagrams, formulate ideas, apply strategies, make calculations and check and communicate your solutions.

The penny-farthing

- 1 The penny-farthing was the first machine to be called a bicycle. It was a popular mode of transport in the late 19th century.

Edward's penny-farthing has a large wheel diameter of 135 cm and a small wheel diameter of 45 cm.

Edward is interested in the number of wheel rotations required over a certain distance and the relationship between the number of rotations of the small wheel and the large wheel.

- Find the circumference of the following correct to two decimal places.
 - the small wheel
 - the large wheel
- To cover the same distance, how many times does the small wheel need to turn for each turn of the large wheel?
- Edward rides the penny-farthing and the large wheel rotates 10 times.
 - How far does he travel correct to the nearest cm?
 - How many times does the small wheel turn?
- Edward wants to ride to school, which is a 1 km journey. How many rotations of the large wheel will occur? Round to the nearest integer.
- On another journey, the small wheel makes 100 more rotations than the large wheel. How far did the penny-farthing travel? Round to the nearest metre.

Fishing sinkers

- 2 Fishing lines often have a metal sinker attached to the line so that the hook and bait sink below the surface of the water. Each sinker must have a hole in it so the line can be properly attached.

The 'Catch Fish' company produces sinkers of various shapes and sizes and coats them with a special anti-rust paint.

The Catch Fish company is interested in the surface area of each sinker so that it can calculate how much paint is required and the associated cost.

- The most basic sinker is a cube of side length 1.5 cm with a single hole of width 0.5 cm as shown. Find the surface area of this sinker including the surface inside the hole.

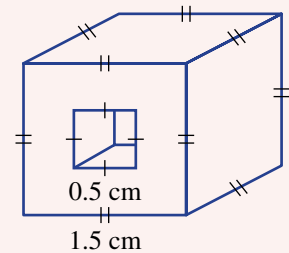

- A cylindrical sinker has dimensions as shown. Find the surface area of this sinker, including inside the hole, correct to two decimal places.

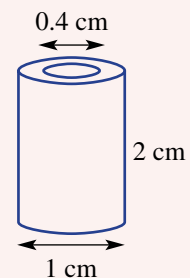

- c** The company chooses to make 1000 of the cube sinkers (from part **a**) and 1000 of the cylindrical sinkers (from part **b** above). The paint costs \$120 per litre and each litre covers 10 m^2 or $100\,000\text{ cm}^2$.
- What is the surface area for the 2000 sinkers? Round to the nearest cm^2 .
 - How much will it cost to paint all the sinkers? Assume that paint can be purchased in any quantity and round to the nearest dollar.
- d** The Catch Fish company decides to adjust the 2 cm height of the cylindrical sinker so that its surface area is the same as the cube sinker. Investigate to find the new height of the cylindrical sinker.

Circle bands

- 3** Bridget is playing with an elastic band and a number of one dollar coins, each of diameter 25 mm.

She lays a number of the coins flat on a table to form different shapes then places an elastic band around them.

Bridget is interested in the length of the elastic band around each shape formed by the coins and how much further the band needs to stretch as she adds more coins.

- a** What is the length of elastic band required to stretch around the following shapes? Round to the nearest mm.

- A single dollar coin
- Two touching coins as shown

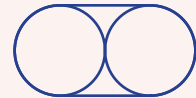

- b** Bridget tries placing a band around three and four coins.

How much further will the band need to stretch for the four-coin shape compared to the three-coin shape?

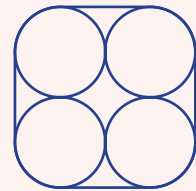
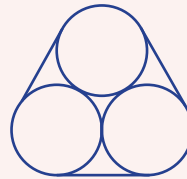

- c** Bridget arranges six coins in three rows to form a triangle as shown.

- How much further does the band need to stretch compared to the three-coin shape above?
- If the triangle pattern had n rows, find the rule for the length, L mm, of the elastic band in terms of n .

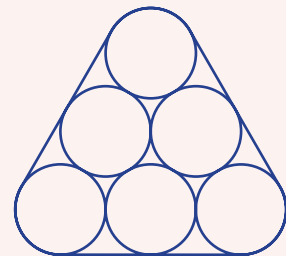

- d** Bridget arranges five coins so that the line segments joining the centres form a regular pentagon (with internal angle sum 540°).

How far does the elastic band need to stretch? Round to the nearest mm.

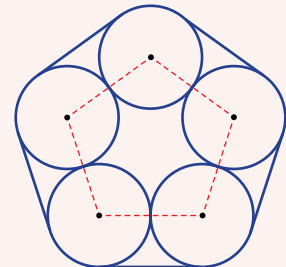

5H Volume of prisms

LEARNING INTENTIONS

- To review the concept of volume
- To know how to convert between metric units of volume
- To understand that volume can also be measured as capacity using litres, millilitres ...
- To know that solids with a uniform cross-section have a formula for volume
- To be able to find the volume of right prisms and solids with a constant cross-section

Volume is the number of cubic units contained within a three-dimensional object.

To find the volume for this solid we can count 24 individual cubic centimetres (24 cm^3) or multiply $3 \times 4 \times 2 = 24 \text{ cm}^3$.

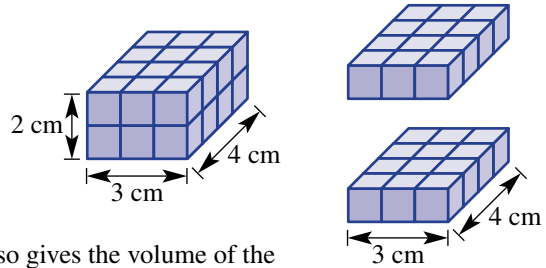

We can see that the area of the base ($3 \times 4 = 12 \text{ cm}^2$) also gives the volume of the base layer 1 cm high. The number of layers equals the height, hence, multiplying the area of the base by the height will give the volume.

This idea can be applied to all right prisms provided a uniform cross-section can be identified. In such solids, the height or length used to calculate the volume is the length of the edge running perpendicular to the base or cross-section, as this measurement counts the number of layers.

Lesson starter: Cubic units

Consider this 1 cm cube (not to scale) divided into cubic millimetres.

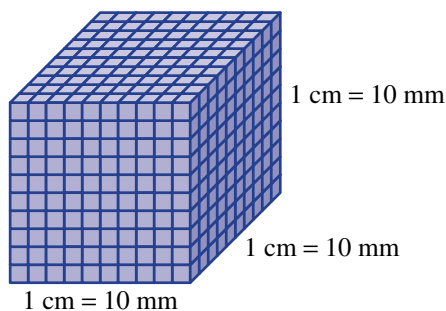

- How many cubic mm sit on one edge of the 1 cm cube?
- How many cubic mm sit on one layer of the 1 cm cube?
- How many layers are there?
- How many cubic mm are there in total in the 1 cm cube?
- Complete this statement: $1 \text{ cm}^3 = \underline{\hspace{2cm}} \text{ mm}^3$
- Explain how you can find how many:
 - cm^3 in 1 m^3
 - m^3 in 1 km^3

KEY IDEAS

- Common metric units for **volume** include **cubic kilometres** (km^3), **cubic metres** (m^3), **cubic centimetres** (cm^3) and **cubic millimetres** (mm^3).

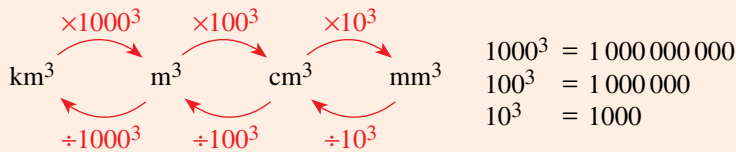

- Common units of **capacity** include:

- megalitres** (ML) 1 ML = 1000 kL
- litres** (L) 1 L = 1000 mL
- kilolitres** (kL) 1 kL = 1000 L
- millilitres** (mL)

- Also $1\text{ cm}^3 = 1\text{ mL}$ so $1\text{ L} = 1000\text{ cm}^3$ and $1\text{ m}^3 = 1000\text{ L}$

- For solids with a uniform **cross-section**:

Volume = area of cross-section \times perpendicular height

$$V = A \times \text{perp. height}$$

cross-section

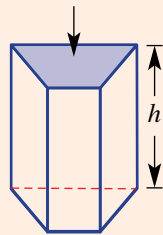

cross-section

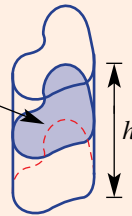

- The perpendicular 'height' is the length of the edge that runs perpendicular to the cross-section. This edge can be the vertical height or the length of a prism.

- Some common formulas for volume include:

Rectangular prism (cuboid)	Triangular prism
<p> $V = A \times \text{perp. height}$ $= l \times w \times h$ $= lwh$ </p>	<p> $V = A \times \text{perp. height}$ $= \left(\frac{1}{2} \times b \times h_1\right) \times h_2$ </p>

BUILDING UNDERSTANDING

1 Describe the cross-sectional shape for these prisms and state the perpendicular ‘height’ (i.e. the length of the edge perpendicular to the cross-section).

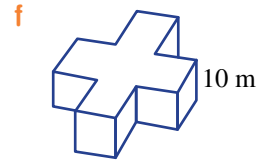
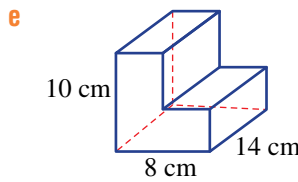
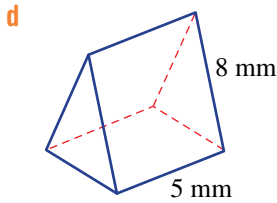
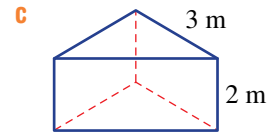
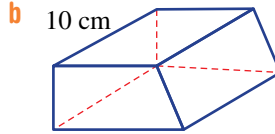
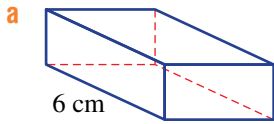

2 Find the volume of these three-dimensional rectangular prisms. Count the number of blocks if you wish.

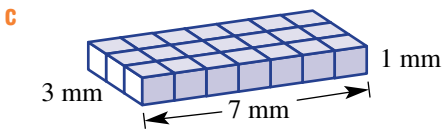
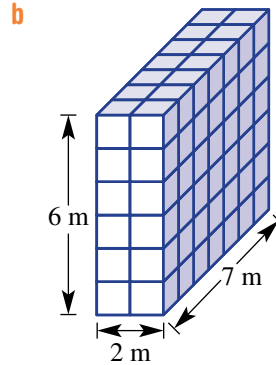
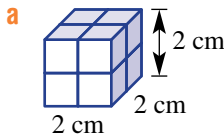

Example 16 Converting units of volume

Convert the following volume measurements to the units given in the brackets.

a 2.5 m^3 (cm^3)

b 458 mm^3 (cm^3)

SOLUTION

a $2.5 \text{ m}^3 = 2.5 \times 100^3 \text{ cm}^3$
 $= 2\,500\,000 \text{ cm}^3$

EXPLANATION

$\times 100^3 = 1\,000\,000$ $\overset{\text{m}^3}{\text{cm}^3}$ 2.500000

b $458 \text{ mm}^3 = 458 \div 10^3 \text{ cm}^3$
 $= 0.458 \text{ cm}^3$

cm^3 mm^3
 $\div 10^3 = 1000$

Now you try

Convert the following volume measurements to the units given in the brackets.

a 4.8 cm^3 (mm^3)

b $612\,000 \text{ cm}^3$ (m^3)



Example 17 Finding volumes of prisms and other solids

Find the volume of each of these three-dimensional objects.

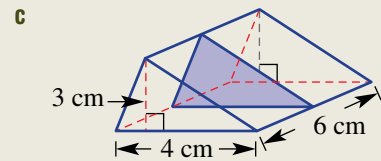
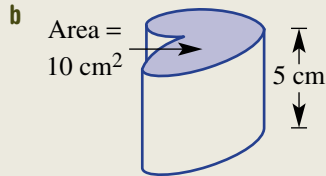
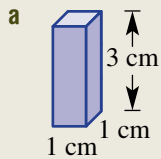

SOLUTION

$$\begin{aligned} \mathbf{a} \quad V &= l \times w \times h \\ &= 1 \times 1 \times 3 \\ &= 3 \text{ cm}^3 \end{aligned}$$

$$\begin{aligned} \mathbf{b} \quad V &= A \times \text{perp. height} \\ &= 10 \times 5 \\ &= 50 \text{ cm}^3 \end{aligned}$$

$$\begin{aligned} \mathbf{c} \quad V &= A \times \text{perp. height} \\ &= \left(\frac{1}{2} \times b \times h_1\right) \times h_2 \\ &= \left(\frac{1}{2} \times 4 \times 3\right) \times 6 \\ &= 36 \text{ cm}^3 \end{aligned}$$

EXPLANATION

The solid is a rectangular prism.
Length = 1 cm, width = 1 cm and
height = 3 cm

Volume = area of cross-section \times perpendicular height
Substitute cross-sectional area = 10
and perpendicular height = 5.

The cross-section is a triangle. The edge perpendicular to the
cross-section is the length (6 cm).

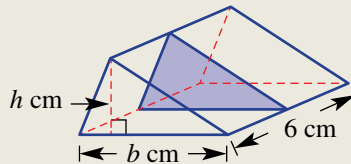

Now you try

Find the volume of each of these three-dimensional objects.

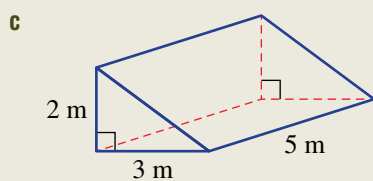
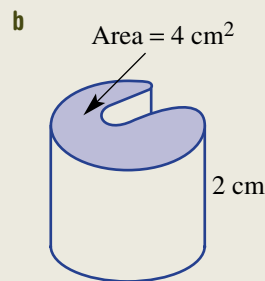
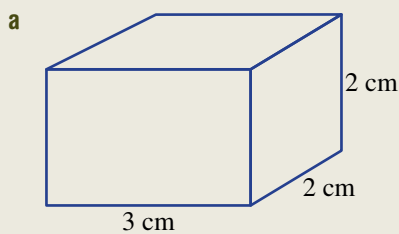

Exercise 5H

FLUENCY

1–3(1/2), 4

1–3(1/2), 4, 5

1–3(1/3), 4, 5

Example 16

1 Convert the following volume measurements to the units given in the brackets.

- | | | | | | |
|---|--------------------------------------|---|---|---|---|
| a | 3 cm^3 (mm^3) | b | 2000 mm^3 (cm^3) | c | 8.7 m^3 (cm^3) |
| d | 5900 cm^3 (m^3) | e | 0.00001 km^3 (m^3) | f | $21\,700 \text{ m}^3$ (km^3) |
| g | 3 L (mL) | h | 0.2 kL (L) | i | 3500 mL (L) |
| j | 0.021 L (mL) | k | 37\,000 L (kL) | l | 42\,900 kL (ML) |

Example 17a

2 Find the volume of these rectangular prisms.

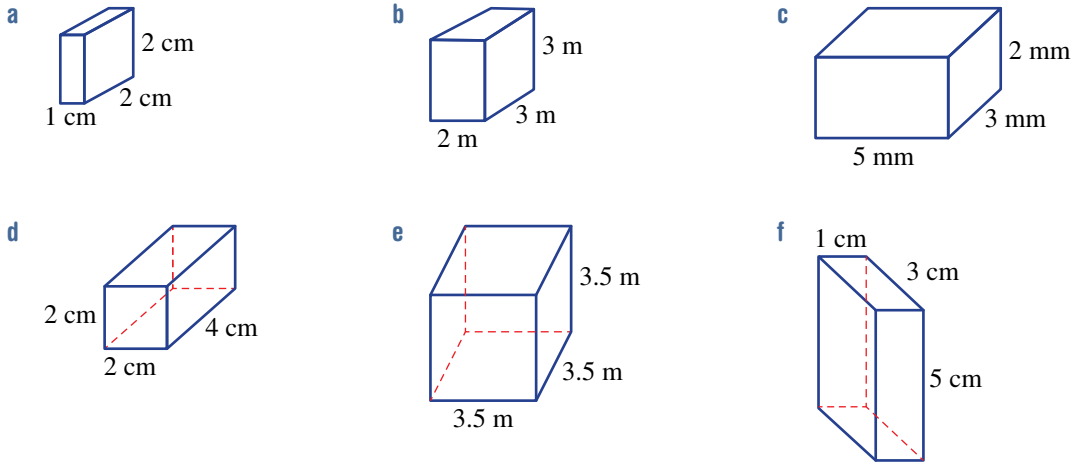

Example 17b

3 Find the volume of each of these three-dimensional objects. The cross-sectional area has been given.

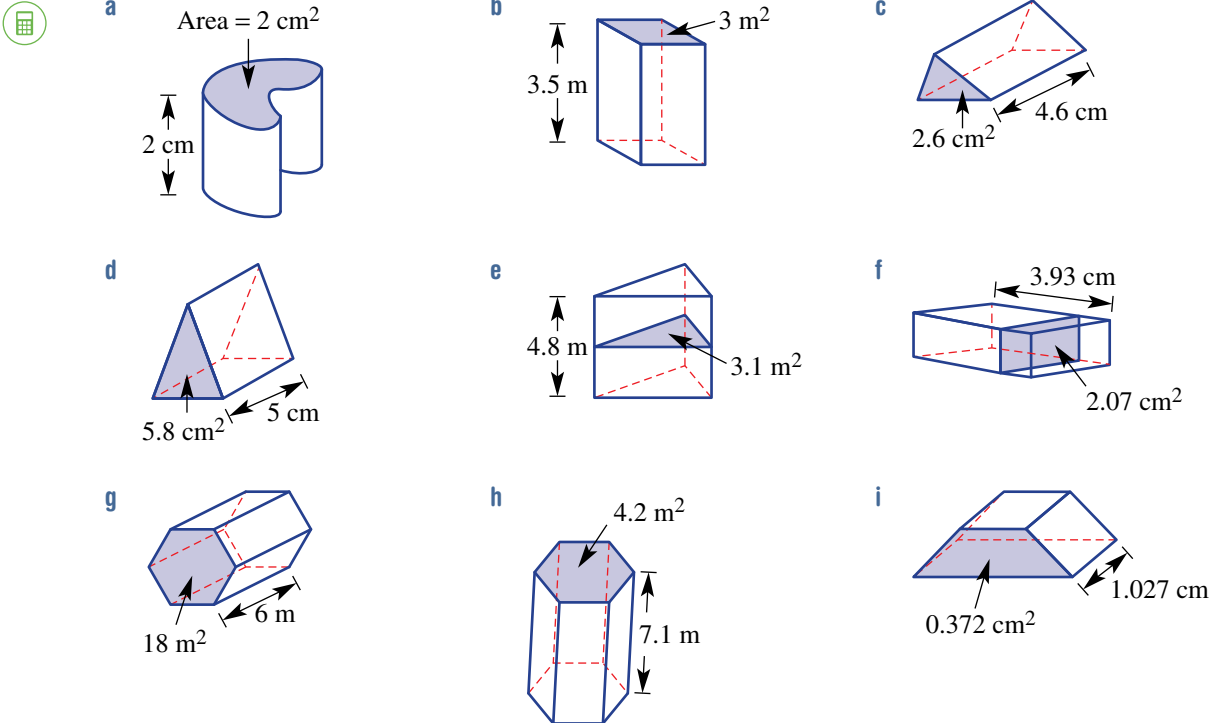

Example 17c



4 Find the volume of these triangular prisms.

a

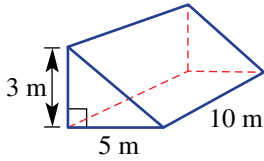

b

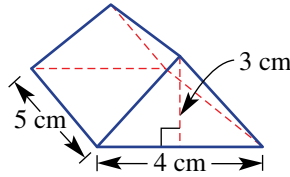

c

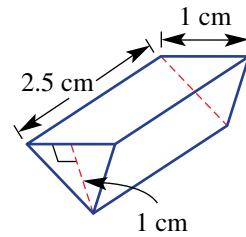

5 Find the volume of these solids. Convert your answer to litres. Recall $1 \text{ cm}^3 = 1 \text{ mL}$ and $1 \text{ L} = 1000 \text{ cm}^3$.

a

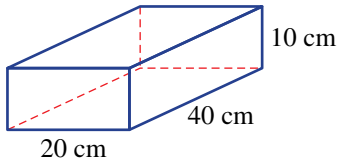

b

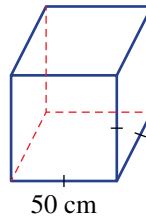

c

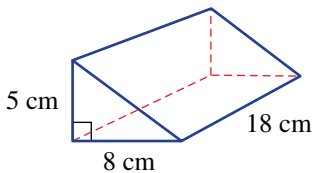

d

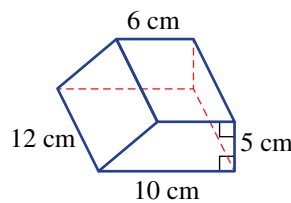

PROBLEM-SOLVING

6, 7

7-9

8-11



6 A brick is 10 cm wide, 20 cm long and 8 cm high. How much space would five of these bricks occupy?



7 How much air space is contained inside a rectangular cardboard box that has the dimensions 85 cm by 62 cm by 36 cm. Answer using cubic metres (m^3), correct to two decimal places.



8 25 L of water is poured into a rectangular fish tank which is 50 cm long, 20 cm wide and 20 cm high. Will it overflow?



9 Find the volume of each of the following solids, rounding to one decimal place where necessary.

a

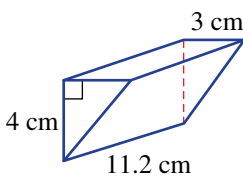

b

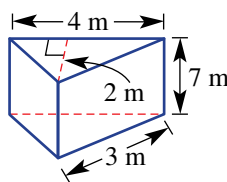

c

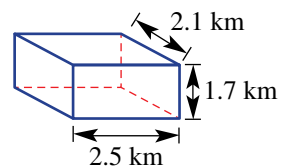

d

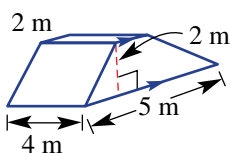

e

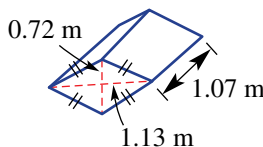

f

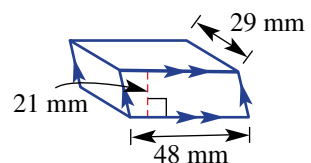

10 Use units for capacity to find the volume of these solids in litres.

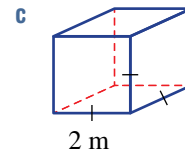
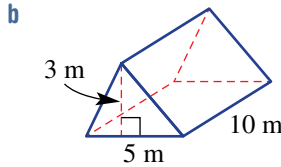
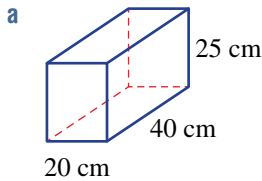

11 The given diagram is a sketch of a new 25 m swimming pool to be installed in a school sports complex.

- a Find the area of the shaded side of the pool.
- b Find the volume of the pool in litres.

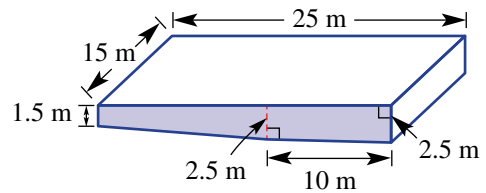

REASONING

12

12

12, 13

- 12 a What single number do you multiply by to convert from:
 - i L to cm^3 ?
 - ii L to m^3 ?
 - iii mL to mm^3 ?
- b What single number do you divide by to convert from:
 - i mm^3 to L?
 - ii m^3 to ML?
 - iii cm^3 to kL?

13 Write rules for the volume of these solids using the given pronumerals.

- a A rectangular prism with length = width = x and height h
- b A cube with side length s
- c A rectangular prism with a square base (with side length t) and height *six* times the side length of the base

ENRICHMENT: Volume of a pyramid

–

–

14

14 Earlier we looked at finding the surface area of a right pyramid like the one shown here.

Imagine the pyramid sitting inside a prism with the same base.

- a Make an educated guess as to what fraction the volume of the pyramid is of the volume of the prism.
- b Use the internet to find the actual answer to part a.
- c Draw some pyramids and find their volume using the results from part b.

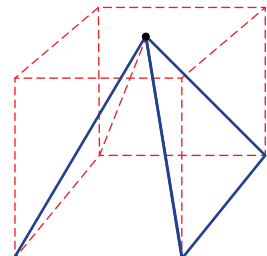

51 Volume of cylinders

LEARNING INTENTIONS

- To know that a cylinder is a solid with a constant circular cross-section
- To know how to find the volume of a cylinder
- To be able to convert the volume of a cylinder to capacity measured in mL, L, ...

A right cylinder has its outside surface at right angles to its base and top. It has a uniform cross-section (a circle) and so the volume of a cylinder can be calculated in a similar way to that of a right prism. Cylindrical objects are commonly used to store gases and liquids, and so working out the volume of a cylinder is an important measurement calculation.



An oil refinery converts crude oil into many products including petrol, diesel, jet fuel, motor oils and asphalt base. Cylinder volumes are calculated for its storage tanks and pipe capacity per m^3 .

Lesson starter: Writing the rule

Previously we used the formula $V = A \times h$ to find the volume of solids with a uniform cross-section.

- Discuss any similarities between the two given solids.
- How can the rule $V = A \times h$ be developed further to find the rule for the volume of a cylinder?

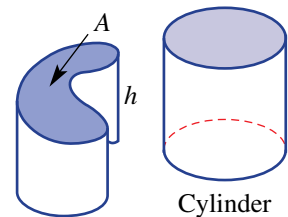

KEY IDEAS

- The volume of a cylinder is given by

$$V = \pi r^2 \times h \text{ or } V = \pi r^2 h$$

- r is the radius of the circular ends.
- h is the length or distance between the circular ends.

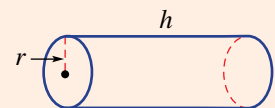

BUILDING UNDERSTANDING

1 Referring to the formula $V = \pi r^2 h$, state the values of r and h for these cylinders.

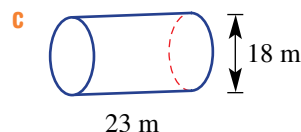
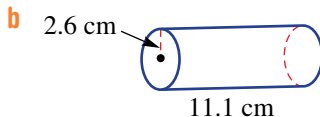
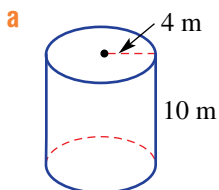

2 Convert the following to the units given in the brackets. Remember, $1 \text{ L} = 1000 \text{ cm}^3$ and $1 \text{ m}^3 = 1000 \text{ L}$.

a 2000 cm^3 (L)

b 4.3 cm^3 (mL)

c 3.7 L (cm^3)

d 1 m^3 (L)

e $38\,000 \text{ L}$ (m^3)

f 0.0002 m^3 (mL)



Example 18 Finding the volume of a cylinder

Find the volume of these cylinders correct to two decimal places.

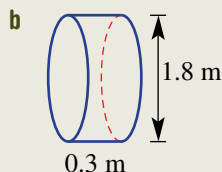
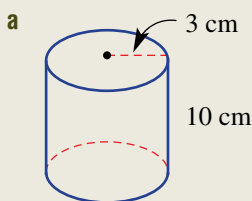

SOLUTION

$$\begin{aligned} \text{a } V &= \pi r^2 h \\ &= \pi \times (3)^2 \times 10 \\ &= 90\pi \\ &= 282.74 \text{ cm}^3 \text{ (to 2 d.p.)} \end{aligned}$$

$$\begin{aligned} \text{b } V &= \pi r^2 h \\ &= \pi \times (0.9)^2 \times 0.3 \\ &= 0.76 \text{ m}^3 \text{ (to 2 d.p.)} \end{aligned}$$

EXPLANATION

Substitute $r = 3$ and $h = 10$ into the rule.

$90\pi \text{ cm}^3$ would be the exact answer.

Include volume units.

The diameter is 1.8 m so $r = 0.9$.

Now you try

Find the volume of these cylinders correct to two decimal places.

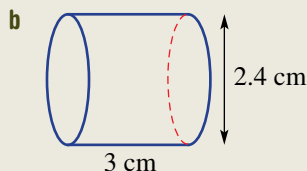
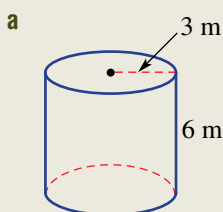



Example 19 Finding the capacity of a cylinder

Find the capacity, in litres, of a cylinder with radius 30 cm and height 90 cm. Round to the nearest litre.

SOLUTION

$$\begin{aligned} V &= \pi r^2 h \\ &= \pi \times (30)^2 \times 90 \\ &= 254\,469 \text{ cm}^3 \\ &= 254 \text{ L (to the nearest litre)} \end{aligned}$$

EXPLANATION

Substitute $r = 30$ and $h = 90$.
There are 1000 cm^3 in 1 L so divide by 1000 to convert to litres. 254.469 to nearest litre is 254 L.

Now you try

Find the capacity, in litres, of a cylinder with radius 40 cm and height 100 cm. Round to the nearest litre.

Exercise 5I

FLUENCY

1, 2(1/2)

1-2(1/2)

1-2(1/2)

Example 18

- 1 Find the volume of these cylinders correct to two decimal places.

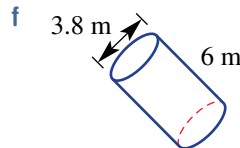
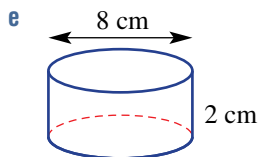
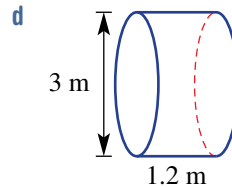
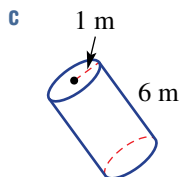
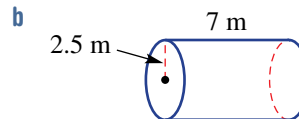
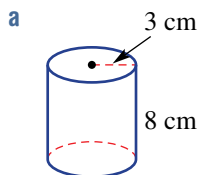

Example 19 2 Find the capacity, in litres, of these cylinders. Round to the nearest litre. Remember $1 \text{ L} = 1000 \text{ cm}^3$ and $1 \text{ m}^3 = 1000 \text{ L}$.

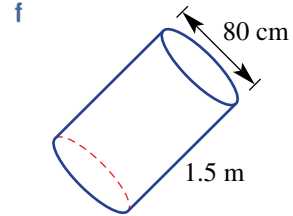
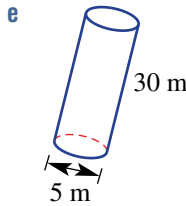
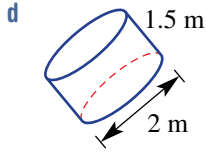
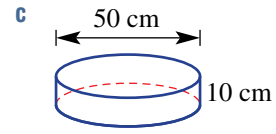
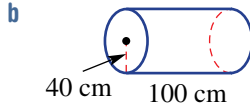
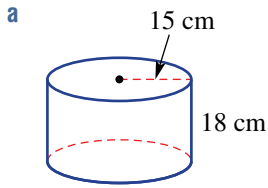

PROBLEM-SOLVING

3, 4

4, 5, 6($\frac{1}{2}$)

5, 6



3 A cylindrical water tank has a radius of 2 m and a height of 2 m.

- a** Find its capacity, in m^3 , rounded to three decimal places.
- b** Find its capacity, in litres, rounded to the nearest litre.



4 How many litres of gas can a tanker carry if it has a cylindrical tank that is 2 m in diameter and 12 m in length? Round to the nearest litre.



5 Of the following, determine which has the bigger volume and calculate the difference in volume to two decimal places: a cube with side length 1 m or a cylinder with radius 1 m and height 0.5 m.



6 Find the volume of these cylindrical portions correct to two decimal places.

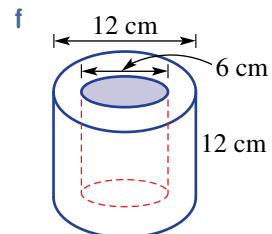
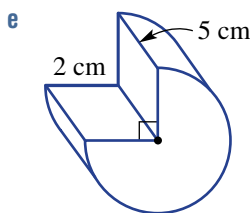
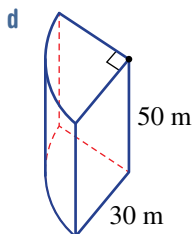
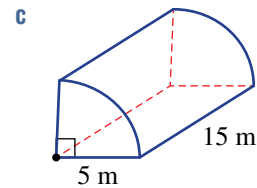
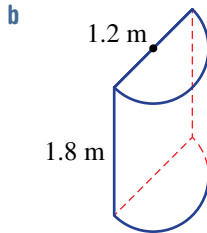
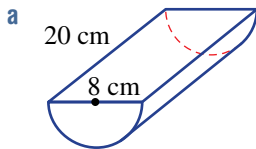

REASONING

7

7, 8($\frac{1}{2}$)

7, 8($\frac{1}{2}$), 9

- 7 The rule for the volume of a cylinder is $V = \pi r^2 h$. Show how you could use this rule to find, correct to three decimal places:

a h when $V = 20$ and $r = 3$

b r when $V = 100$ and $h = 5$.

- 8 Using exact values (e.g. 20π) find the volume of these solids.

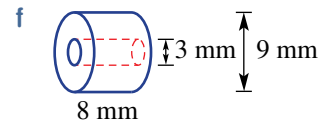
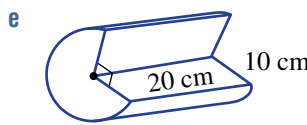
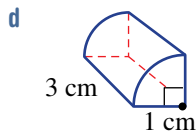
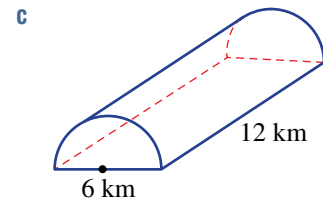
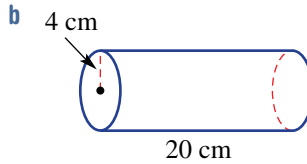
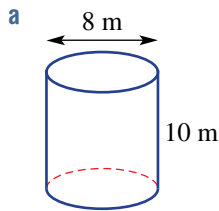

- 9 Draw a cylinder that has a circumference equal to its height. Try to draw it to scale.

ENRICHMENT: Solid sectors

–

–

10

- 10 You will recall that the area of a sector is given by $A = \frac{\theta}{360} \times \pi r^2$.

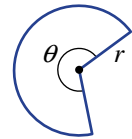

Use this fact to help find the volume of these solids, correct to two decimal places.

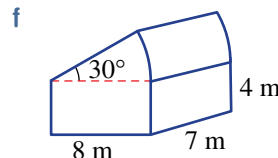
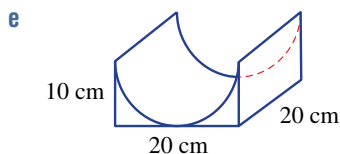
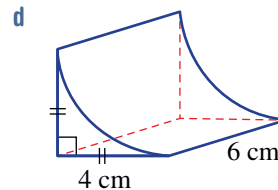
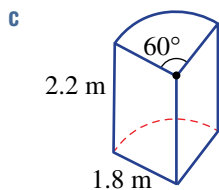
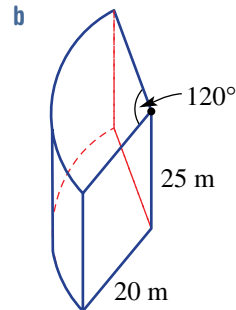
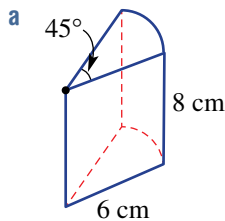

Pressing a new road

The construction of a new asphalt road involves pressing the surface with a roller. Two rollers are available, each with main roller wheels of varying diameter and width. The options are:

- Roller 1: Wheel diameter 1 metre and width 2 metres
- Roller 2: Wheel diameter 1.2 metres and width 2.5 metres.

The cost of hiring each roller depends on the number of revolutions in the following way:

- Roller 1: \$2.20 per revolution
- Roller 2: \$3 per revolution.

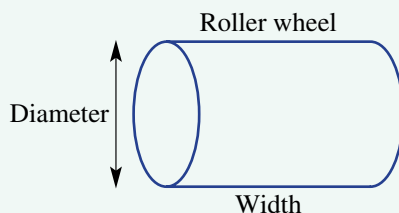

The rectangular section of road being built is 1 km long and 10 metres wide.

Present a report for the following tasks and ensure that you show clear mathematical workings and explanations where appropriate.

Preliminary task

- Find the following for Roller 1 correct to two decimal places:
 - the surface area of the roller wheel (curved surface area only)
 - the area of ground pressed after 10 revolutions.
- Find the surface area in square metres of a section of road which is 1 km long and 10 metres wide.
- How many rotations of the wheel would need to occur if Roller 1 was to travel a single-length of the road 1 km long? Round to one decimal place.

Modelling task

- | | |
|---------------------|---|
| Formulate | a The problem is to determine the cost of hiring each roller to press the entire 1 km stretch of road. Write down all the relevant information that will help solve this problem with the aid of diagrams. |
| Solve | b Using Roller 1 determine the total number of revolutions that the wheel needs to rotate if the entire 10 metre-wide road is to be pressed. Use the following assumptions. <ul style="list-style-type: none"> • It is not necessary to overlap one pressed strip with the next. • No revolutions are counted while the roller is manoeuvring into position at the start of each strip. c Calculate the cost of hiring Roller 1 to press the 1 km stretch of road.
d Repeat parts b and c for Roller 2. |
| Evaluate and verify | e Assume that each strip rolled must now overlap the previous pressed strip by 10 cm. Determine the total number of revolutions required for each of the two rollers under these conditions.
f Compare and comment on the cost of hiring the rollers if: <ol style="list-style-type: none"> no overlap is required between strips a 10 cm overlap is required between strips. |
| Communicate | g Summarise your results and describe any key findings. |

Extension questions

- If the overlap of each rolled strip is to be 50 cm instead, which roller would be cheaper to use? Give reasons.
- A third roller has wheel diameter 2 metres and width 4 metres and its cost per revolution is \$5. Will this roller be a cheaper option to press the 1 km stretch of road if a 10 cm overlap is required? Justify your answer.

Equal volumes and different surface areas

Key technology: Spreadsheets

While some solids have the same volume, they will not necessarily have the same surface area. This will depend on the base area and the height as well as the shape and the number of faces.

1 Getting started

We will start by considering three solids including a cube of side length 1 unit, a triangular prism with equilateral base side lengths 1 unit and cylinder with diameter 1 unit.

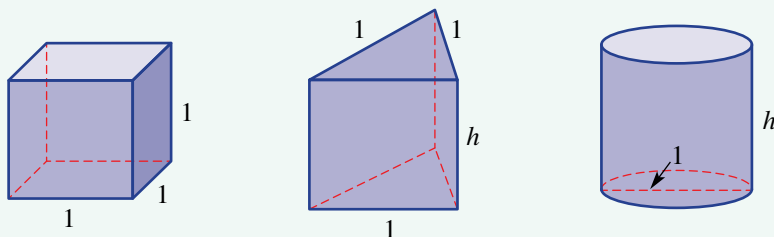

- State the volume and surface area of the cube.
- For the base of the triangular prism, find the perpendicular height a shown.
- Find the volume and surface area of the triangular prism if the height h is 1.5 units.
- Find the volume and surface area of the cylinder if its height h is 1.5 units.
- Compare the volumes and surface areas of the solids. Which solids have similar volumes and which solids have similar surface areas?

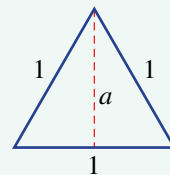

2 Using technology

The following spreadsheet varies the height by increments of 0.2 in column A and shows the formula for the volume of the triangular prism and cylinder. The formulas for the surface areas are not given.

	A	B	C	D	E
1	Equal volumes and	different surface areas			
2					
3	Cube volume = 1	Cube surface area = 6			
4					
5		Triangular prism		Cylinder	
6	Height	Volume	Surface area	Volume	Surface area
7	0.5	=SQRT(3)/4*A7		=PI()*0.25*A7	
8	=A7+0.2				
9					

- Enter the information into a spreadsheet and fill down at cells A8, B7 and D7.
- To the nearest 0.2, find the height required so that the volume of the following solids is as close as possible to the volume of the cube of side length 1.
 - Triangular prism
 - Cylinder
- Calculate the correct formula for the surface areas of the triangular prism and cylinder in terms of h then enter these into the spreadsheet in cells C7 and E7. Then fill down.
- For the heights found in part b compare the surface areas of the following solids with the surface area of the cube.
 - Triangular prism
 - Cylinder

3 Applying an algorithm

- a** We will repeat the questions in part **2** but use the following steps to find a more accurate solution.
- Step 1: Change the incremental increase in cell A8 to a smaller amount. Suggest start with 0.1.
 - Step 2: Fill down the columns so that the volumes for both the triangular prism and cylinder are greater than 6.
 - Step 3: Find the height required so that the volume of the following solids is close as possible to the volume of the cube of side length 1.
 - i** Triangular prism
 - ii** Cylinder
 - Step 4: For the heights found in Step 3, compare the surface areas of the following solids with the surface area of the cube.
 - Step 5: Repeat from Step 1 using a smaller incremental change and fill down.
- b** Comment on the shape of the triangular prism and cylinder that have the same volume as the cube. Discuss the differences in height and the surface area.

4 Extension

Another way to compare solids is to first ensure they have the same base area. So for the triangular prism, the triangular base will be of area 1 unit and the cylinder will have a circular base area of 1 unit.

- a** Find the side length of a triangular prism if the base is an equilateral triangle and the base area is 1 unit.
- b** Find the radius of the circular base of the cylinder if the base area is 1 unit.
- c** Set up a spreadsheet to find the volume and surface area of the triangular prism and cylinder of varying height.
- d** Repeat the algorithm in part **3** above and comment on the shape of the triangular prism and cylinder that have the same volume as the cube. Discuss the differences in height and the surface area.



Capacity and depth

Finding capacity

Find the capacity, in litres, of these containers (i.e. find the total volume of fluid they can hold).

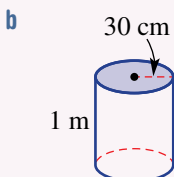
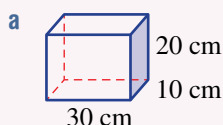

Remember: 1 millilitre (mL) of fluid occupies 1 cm^3 of space, therefore 1 litre (L) occupies 1000 cm^3 as there are 1000 mL in 1 litre.

Finding depth

The depth of water in a prism can be found if the base (cross-sectional) area and volume of water are given.

Consider a cuboid, as shown, with 2.4 L of water.

To find the depth of water:

- Convert the volume to cm^3 : $2.4 \text{ L} = 2.4 \times 1000 = 2400 \text{ cm}^3$
- Find the depth: $\text{Volume} = \text{area of base} \times d$
 $2400 = 20 \times 20 \times d$
 $2400 = 400 \times d$
 $\therefore d = 6$
 \therefore depth is 6 cm

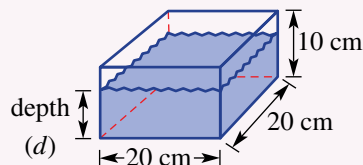

Use the above method to find the depth of water in these prisms.

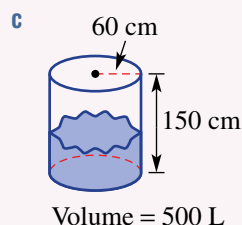
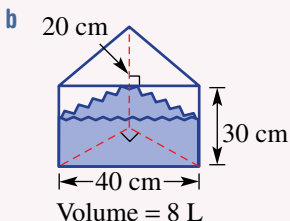
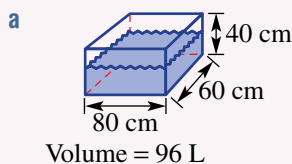

Volumes of odd-shaped objects

Some solids may be peculiar in shape and their volumes may be difficult to measure.

- a** A rare piece of rock is placed into a cylindrical jug of water and the water depth rises from 10 cm to 11 cm. The radius of the jug is 5 cm.
- Find the area of the circular base of the cylinder.
 - Find the volume of water in the jug before the rock is placed in the jug.
 - Find the volume of water in the jug including the rock.
 - Hence find the volume of the rock.
- b** Use the procedure outlined in part **a** to find the volume of an object of your choice. Explain and show your working and compare your results with those of other students in your class if they are measuring the volume of the same object.

- 1 The 100 m^2 flat roof of a factory feeds all the water collected to a rainwater tank. If there is 1 mm of rainfall, how many litres of water go into the tank?
- 2 What is the relationship between the shaded and non-shaded regions in this circular diagram?

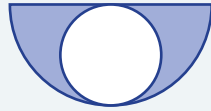

Up for a challenge? If you get stuck on a question, check out the 'Working with unfamiliar problems' poster at the end of the book to help you.



- 3 A goat is tethered to the centre of one side of a rectangular shed with a 10 m length of rope. What area of grass can the goat graze?

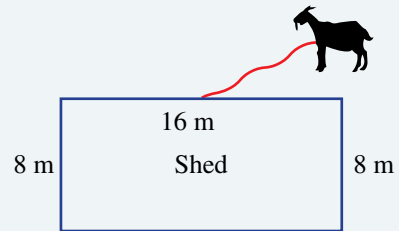

- 4 A rain gauge is in the shape of a triangular prism with dimensions as shown. What is the depth of water when it is half full?

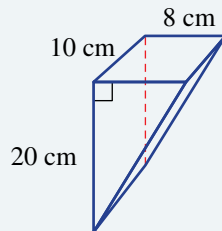

- 5 A rectangular fish tank has base area 0.3 m^2 and height 30 cm and is filled with 80 L of water. Ten large fish, each with volume 50 cm^3 , are placed into the tank. By how much does the water level rise?
- 6 Find the rule for the volume of a cylinder in terms of r only if the height is equal to its circumference.
- 7 The surface area of a cylinder is 2π square units. Find a rule for h in terms of r .
- 8 Give the dimensions of a cylinder that can hold 1 L of milk. What considerations are needed when designing containers for use by consumers?

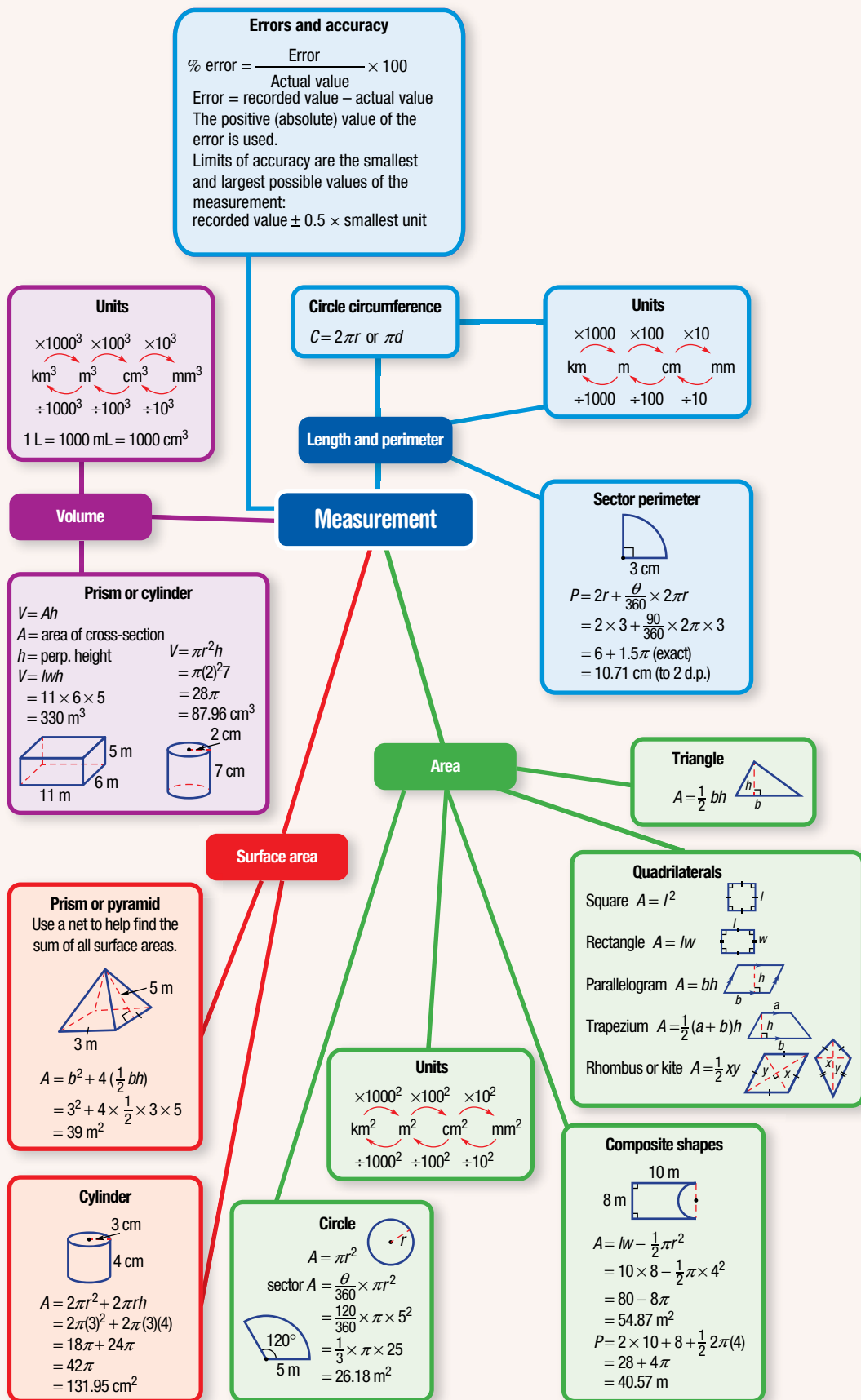

Chapter checklist with success criteria

A printable version of this checklist is available in the Interactive Textbook



5A	1. I can calculate the absolute percentage error. e.g. Calculate the absolute percentage error if the recorded time is 20 minutes and the actual time is 26 minutes.	<input type="checkbox"/>
5A	2. I can find the limits of accuracy in a measurement. e.g. A backpack is weighed using a digital scale which displays measurements in kilograms correct to one decimal place. If the measurement given is 6.7 kg, state the lower and upper limits of accuracy of this measurement.	<input type="checkbox"/>
5B	3. I can find the perimeter of simple shapes. e.g. Find the perimeter of the following shape.	<input type="checkbox"/>
5B	4. I can find the perimeter of composite shapes. e.g. Find the perimeter of the following shape.	<input type="checkbox"/>
5B	5. I can find a missing side length given a perimeter. e.g. Find the value of x if the perimeter of the given shape is 23 cm.	<input type="checkbox"/>
5C	6. I can find the circumference of a circle. e.g. Find the circumference of this circle both in exact form and rounded to two decimal places.	<input type="checkbox"/>
5C	7. I can find the perimeter of a sector. e.g. Find the perimeter of this sector correct to two decimal places.	<input type="checkbox"/>
5D	8. I can convert between units of area. e.g. Convert 3200 cm^2 to m^2 and 2.4 cm^2 to mm^2 .	<input type="checkbox"/>

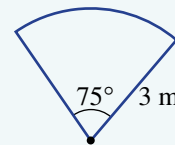
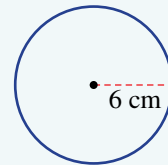
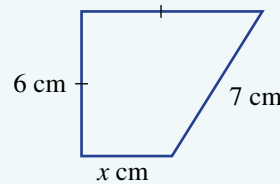
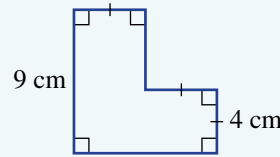
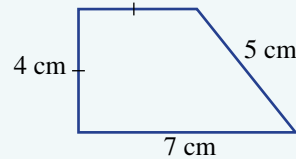

Chapter checklist with success criteria

			✓
5D	<p>9. I can find the area of simple shapes. e.g. Find the area of this rectangle and triangle.</p>		<input type="checkbox"/>
5D	<p>10. I can find the area of a trapezium or rhombus. e.g. Find the area of the following trapezium and rhombus.</p>		<input type="checkbox"/>
5D	<p>11. I can find the area of a circle. e.g. Find the area of this circle correct to two decimal places.</p>		<input type="checkbox"/>
5D	<p>12. I can find the area of a sector. e.g. Find the area of this sector correct to two decimal places.</p>		<input type="checkbox"/>
5E	<p>13. I can find the perimeter and area of composite shapes. e.g. Find the perimeter and area of this composite shape, rounding answers to two decimal places.</p>		<input type="checkbox"/>
5E	<p>14. I can find the area of a composite shape using subtraction. e.g. Find the shaded area of this composite shape.</p>		<input type="checkbox"/>
5F	<p>15. I can find the surface area of a prism. e.g. Find the surface area of this right rectangular prism.</p>		<input type="checkbox"/>

Chapter checklist with success criteria

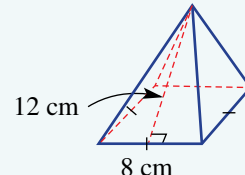
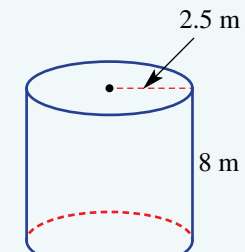
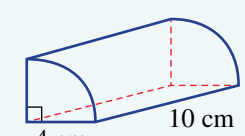
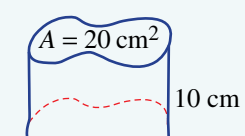
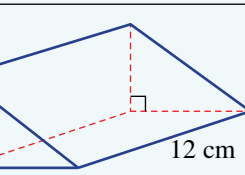
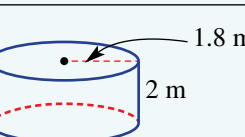
5F	<p>16. I can find the surface area of a pyramid. e.g. Find the surface area of this right square-based pyramid.</p>		<p style="text-align: right;">✓</p> <input type="checkbox"/>
5G	<p>17. I can find the surface area of a cylinder. e.g. Find the surface area of this cylinder correct to two decimal places.</p>		<input type="checkbox"/>
5G	<p>18. I can find the surface area of cylindrical portions. e.g. Find the surface area of this quarter-cylinder, rounding to two decimal places.</p>		<input type="checkbox"/>
5H	<p>19. I can convert between units of volume. e.g. Convert 3 m^3 to cm^3 and 1276 m^3 to cm^3.</p>		<input type="checkbox"/>
5H	<p>20. I can find the volume of an object with a constant cross-section. e.g. Find the volume of this solid object.</p>		<input type="checkbox"/>
5H	<p>21. I can find the volume of a prism. e.g. Find the volume of this triangular prism.</p>		<input type="checkbox"/>
5I	<p>22. I can find the volume of a cylinder. e.g. Find the volume of this cylinder correct to two decimal places.</p>		<input type="checkbox"/>
5I	<p>23. I can find volume in terms of capacity. e.g. Find the capacity in litres of a cylinder with radius 20 cm and height 80 cm. Round to the nearest litre.</p>		<input type="checkbox"/>

Short-answer questions

5B/D/H

1 Convert the following measurements to the units given in brackets.

- a 3.8 m (cm) b 1.27 km (m) c 273 mm^2 (cm^2)
 d 5.2 m^2 (cm^2) e 0.01 m^3 (cm^3) f $53\,100 \text{ mm}^3$ (cm^3)
 g 3100 mL (L) h 0.043 L (mL) i 2.83 kL (L)

5A

2 Calculate the absolute percentage error for the following recorded and actual measurements.

- a recorded: 2.4 L actual: 2.5 L
 b recorded: 3 seconds actual: 5 seconds

5B

3 Find the perimeter of each of the following shapes.

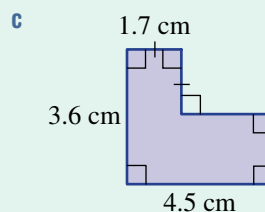
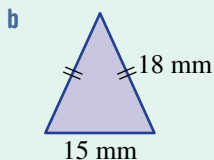
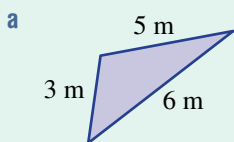

5D

4 Find the area of each of the following plane figures.

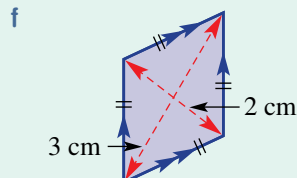
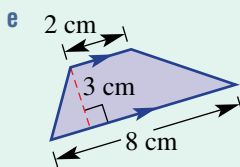
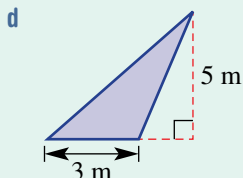
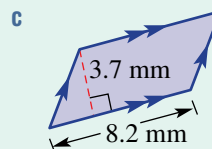
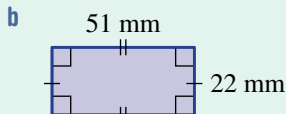
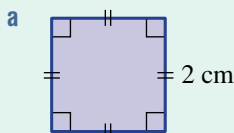

5E

5 A new garden bed is to be constructed inside a rectangular lawn area of length 10.5 m and width 3.8 m. The garden bed is to be the shape of a triangle with base 2 m and height 2.5 m. With the aid of a diagram, find:



- a the area of the garden bed
 b the area of the lawn remaining around the garden bed.

5C/D

6 Find the area and circumference or perimeter of each of the following shapes correct to two decimal places.

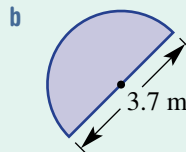
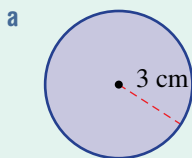

5C/D

7 Find the perimeter and area of these sectors. Round to two decimal places.

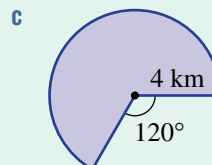
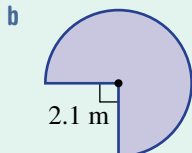
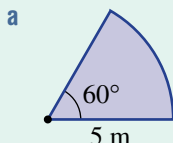

5E

- 8 Find the perimeter and area of each of the following composite shapes, correct to two decimal places.

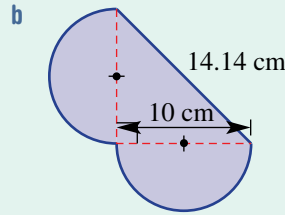
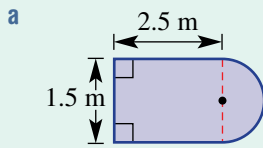

5F

- 9 Find the surface area of each of these solid objects.

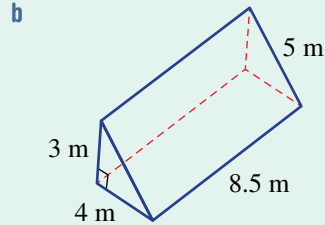
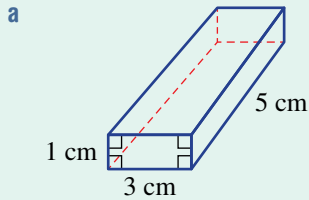

5G

- 10 Find the surface area of each of the following solid objects, correct to two decimal places.

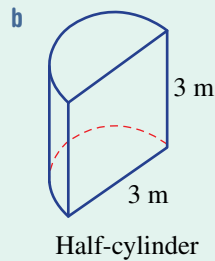
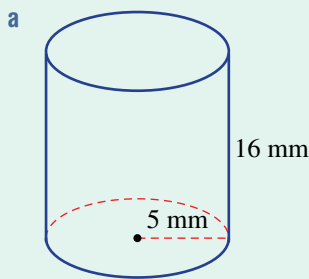

5H/I

- 11 Find the volume of each of these solid objects. Answer to the nearest litre in part c.

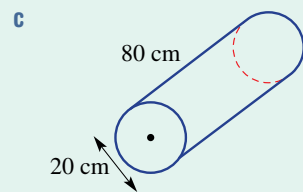
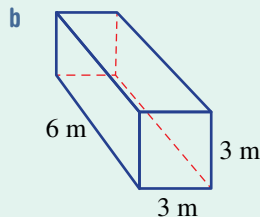
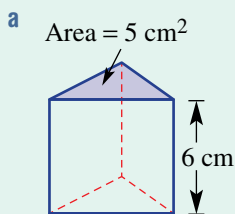

Multiple-choice questions

5A

- 1 A digital scale measures the weight of a bag of potato chips to the nearest gram to be 35 g. If the chips are sold in boxes of 10 bags, the lower limit of accuracy for the weight of a box is:
- A 355 g B 350 g C 340 g D 360 g E 345 g

5B/D

- 2 If the area of a square field is 25 km^2 , its perimeter is:
- A 10 km B 20 km C 5 km D 50 km E 25 km

5D

- 3 2.7 m^2 is the same as:
- A 270 cm^2 B 0.0027 km^2 C $27\,000 \text{ cm}^2$ D 2700 mm^2 E 27 cm^2

- 5D 4 A parallelogram has area 10 m^2 and base 5 m . Its perpendicular height is:
 A 50 m B 2 m C 50 m^2 D 2 m^2 E 0.5 m

- 5E 5 This composite shape could be considered as a rectangle with an area in the shape of a trapezium removed. The shape's area is:
 A 16 km^2 B 12 km^2 C 20 km^2
 D 24 km^2 E 6 km^2

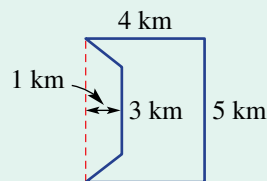

- 5C 6 A semicircular goal area has a diameter of 20 m . Its perimeter correct to the nearest metre is:
 A 41 m B 36 m C 83 m D 51 m E 52 m



- 5F 7 The surface area of the pyramid shown is:
 A 185 cm^2 B 105 cm^2 C 65 cm^2
 D 100 cm^2 E 125 cm^2

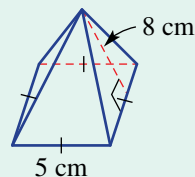

- 5G 8 The area of the curved surface only of this half cylinder with radius 5 mm and height 12 mm is closest to:
 A 942.5 mm^2 B 94.2 mm^2 C 377 mm^2
 D 471.2 mm^2 E 188.5 mm^2



- 5H 9 The cross-sectional area of a prism is 100 m^2 . If its volume is 6500 m^3 , the prism's total height would be:
 A 0.65 m B 650000 m C 65 m D 6.5 m E 650 m

- 5I 10 The exact volume of a cylinder with radius 3 cm and height 10 cm is:
 A $60\pi \text{ cm}^3$ B $80\pi \text{ cm}^3$ C $45\pi \text{ cm}^3$ D $30\pi \text{ cm}^3$ E $90\pi \text{ cm}^3$

Extended-response questions



- 1 An office receives five new desks with a bench shape made up of a rectangle and quarter-circle as shown.

The edge of the bench is lined with a rubber strip at a cost of $\$2.50$ per metre.

- a Find the length, in centimetres, of the rubber edging strip for one desk correct to two decimal places.
 b By converting your answer in part a to metres, find the total cost of the rubber strip for the five desks. Round to the nearest dollar.

The manufacturer claims that the desktop area space is more than 1.5 m^2 .

- c Find the area of the desktop in cm^2 correct to two decimal places.
 d Convert your answer to m^2 and determine whether or not the manufacturer's claim is correct.

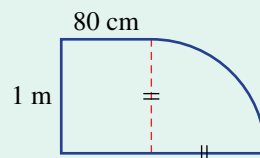



2 Circular steel railing of diameter 6 cm is to be used to fence the side of a bridge. The railing is hollow and the radius of the hollow circular space is 2 cm.

a By adding the given information to this diagram of the cross-section of the railing, determine the thickness of the steel.

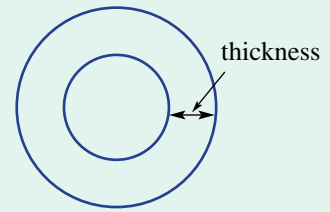

b Determine, correct to two decimal places, the area of steel in the cross-section.

Eight lengths of railing each 10 m long are required for the bridge.

c Using your result from part **b**, find the volume of steel required for the bridge in cm^3 .

d Convert your answer in part **c** to m^3 .

The curved outside surface of the steel railings is to be painted to help protect the steel from the weather.

e Find the outer circumference of the cross-section of each railing correct to two decimal places.

f Find the surface area in m^2 of the eight lengths of railing that are to be painted. Round to the nearest m^2 .

The cost of the railing paint is \$80 per m^2 .

g Using your answer from part **f**, find the cost of painting the bridge rails to the nearest dollar.



Reviewing number and financial mathematics

Short-answer questions

- Evaluate the following.
 - $\frac{3}{7} + \frac{1}{4}$
 - $2\frac{1}{3} - 1\frac{5}{9}$
 - $\frac{9}{10} \times \frac{5}{12}$
 - $3\frac{3}{4} \div 2\frac{1}{12}$
- Convert each of the following to a percentage.
 - 0.6
 - $\frac{5}{16}$
 - 2 kg out of 20 kg
 - 75c out of \$3
- Write these rates and ratios in simplest form.
 - Prize money is shared between two people in the ratio 60 : 36.
 - Jodie travels 165 km in 3 hours.
 - 3 mL of rain falls in $1\frac{1}{4}$ hours.
- Calculate the new value.
 - Increase \$60 by 12%
 - Decrease 70 cm by 8%
- Jeff earns a weekly retainer of \$400 plus 6% of the sales he makes. If he sells \$8200 worth of goods, how much will he earn for the week?

Multiple-choice questions

- $-3 + (4 + (-10)) \times (-2)$ is equal to:
 - 21
 - 9
 - 18
 - 15
 - 6
- The estimate of $221.7 \div 43.4 - 0.0492$ using one significant figure rounding is:
 - 4.9
 - 5.06
 - 5.5
 - 5
 - 4.95
- \$450 is divided in the ratio 4 : 5. The value of the smaller portion is:
 - \$210
 - \$250
 - \$90
 - \$200
 - \$220
- A book that costs \$27 is discounted by 15%. The new price is:
 - \$20.25
 - \$31.05
 - \$4.05
 - \$22.95
 - \$25.20
- Anna is paid a normal rate of \$12.10 per hour. If in a week she works 6 hours at the normal rate, 2 hours at time and a half and 3 hours at double time, how much does she earn?
 - \$181.50
 - \$145.20
 - \$193.60
 - \$175.45
 - \$163.35

Extended-response question

- Jim and Jill are trialling new banking arrangements.
 - Jill plans to trial a simple interest plan. Before investing her money she increases the amount in her account by 20% to \$21 000.
 - What was the original amount in her account?
 - Jill invests the \$21 000 for 4 years at an interest rate of 3% p.a. How much does she have in her account at the end of the 4 years?
 - Jill continues with this same plan and after a certain number of years has received \$5670 interest. For how many years has she had the money invested?
 - What percentage increase does this interest represent on her initial investment?

- b** Jim is investing his \$21 000 in an account that compounds annually at 3% p.a. How much does he have after 4 years to the nearest cent?
- c i** Who had the more money in their investment after 4 years and by how much? Round to the nearest dollar.
- ii** Who will have the more money after 10 years and by how much? Round to the nearest dollar.

Expressions and linear equations

Short-answer questions

- 1** Solve the following equations and inequalities.
- | | |
|---------------------------------|-----------------------------------|
| a $3x + 7 = 25$ | b $\frac{2x - 1}{4} > 2$ |
| c $4(2m + 3) = 15$ | d $-3(2y + 4) - 2y = -4$ |
| e $3(a + 1) \leq 4 - 8a$ | f $3(2x - 1) = -2(4x + 3)$ |
- 2** Noah receives m dollars pocket money per week. His younger brother Jake gets \$6, which is half of \$3 less than Noah's amount.
- a** Write an equation to represent the problem.
- b** Solve the equation in part **a** to determine how much Noah receives each week.
- 3** The formula $S = \frac{n}{2}(a + l)$ gives the sum S of a sequence of n numbers with first term a and last term l .
- a** Find the sum of the sequence of ten terms 2, 5, 8, ..., 29.
- b** Rearrange the formula to make l the subject.
- c** If a sequence of eight terms has a sum of 88 and a first term equal to 4, use your answer to part **b** to find the last term of this sequence.
- Ext** **4** Solve the following equations simultaneously.
- | | |
|---------------------------------------|--|
| a $x + 4y = 18$
$x = 2y$ | b $7x - 2y = 3$
$y = 2x - 3$ |
| c $2x + 3y = 4$
$x + y = 3$ | d $3x + 4y = 7$
$5x + 2y = -7$ |

Multiple-choice questions

- 1** The simplified form of $5ab + 6a \div 2 + a \times 2b - a$ is:
- A** $10ab$ **B** $10ab + 3a$ **C** $13ab - a$
D $5ab + 3a + 2b$ **E** $7ab + 2a$
- 2** The expanded form of $-2(3m - 4)$ is:
- A** $-6m + 8$ **B** $-6m + 4$ **C** $-6m - 8$ **D** $-5m - 6$ **E** $5m + 8$
- 3** The solution to $\frac{d}{4} - 7 = 2$ is:
- A** $d = -20$ **B** $d = 15$ **C** $d = 36$ **D** $d = 1$ **E** $d = 30$

4 The solution to $1 - 3x < 10$ represented on a number line is:

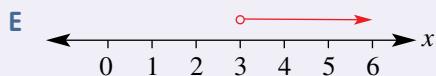
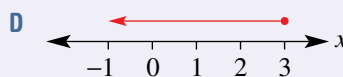
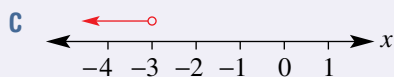
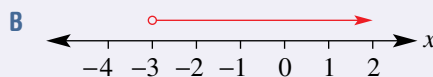
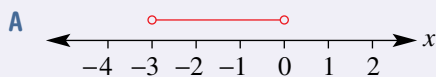

5 The formula $m = \sqrt{\frac{b-1}{a}}$ with b as the subject is:

A $b = a\sqrt{m} + 1$

B $b = \frac{m^2}{a} + 1$

C $b = a^2m^2 + 1$

D $b = am^2 + 1$

E $b = m^2\sqrt{a} + 1$

Extended-response question

a Chris referees junior basketball games on a Sunday. He is paid \$20 plus \$12 per game he referees. He is trying to earn more than \$74 one Sunday. Let x be the number of games he referees.

i Write an inequality to represent the problem.

ii Solve the inequality to find the minimum number of games he must referee.

Ext b Two parents support the game by buying raffle tickets and badges. One buys 5 raffle tickets and 2 badges for \$11.50 while the other buys 4 raffle tickets and 3 badges for \$12. Determine the cost of a raffle ticket and the cost of a badge by:

i defining two variables

ii setting up two equations to represent the problem

iii solving your equations simultaneously.

Pythagoras' theorem and trigonometry

Short-answer questions

1 Find the value of the pronumerals, correct to one decimal place.

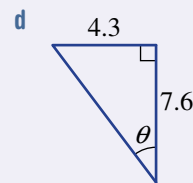
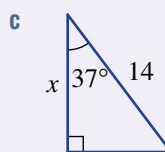
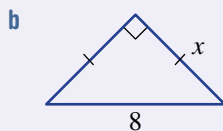
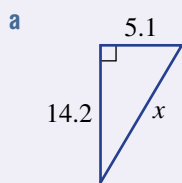

2 Find the value of the pronumerals. Round to one decimal place where necessary.

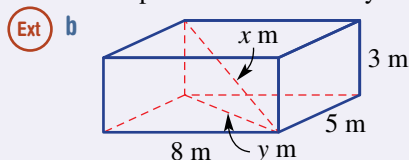
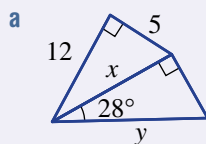

- 3** A wire is to be connected from the edge of the top of a 28 m high building to the edge of the top of a 16 m high building. The buildings are 15 m apart.
- a** What length of wire, to the nearest centimetre, is required?
 - b** What is the angle of depression from the top of the taller building to the top of the smaller building? Round to one decimal place.
- 4** A yacht sails 18 km from its start location on a bearing of 295°T .
- a** How far east or west is it from its start location? Answer correct to one decimal place.
 - b** On what true bearing would it need to sail to return directly to its start location?

Multiple-choice questions

1 The exact value of x in the triangle shown is:

- A** 3.9
- B** $\sqrt{113}$
- C** $\sqrt{57}$
- D** $\sqrt{15}$
- E** 2.7

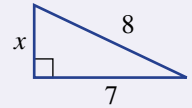

2 The correct expression for the triangle shown is:

- A** $x = \frac{6}{\sin 42^\circ}$
- B** $x = 6 \tan 42^\circ$
- C** $x = 6 \sin 42^\circ$
- D** $x = \frac{6}{\cos 42^\circ}$
- E** $x = \frac{\sin 42^\circ}{6}$

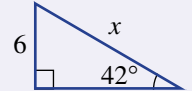

3 The correct expression for the angle θ is:

- A** $\theta = \tan^{-1}\left(\frac{x}{z}\right)$
- B** $\theta = \sin^{-1}\left(\frac{x}{z}\right)$
- C** $\theta = \tan^{-1}\left(\frac{y}{x}\right)$
- D** $\theta = \cos^{-1}\left(\frac{z}{x}\right)$
- E** $\theta = \cos^{-1}\left(\frac{x}{y}\right)$

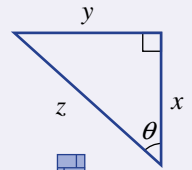

- 4** A 5 m plank of wood is leaning up against the side of a building as shown. If the plank touches the ground 3 m from the base of the building, the angle the wood makes with the building is closest to:

- A** 36.9°
- B** 59°
- C** 53.1°
- D** 31°
- E** 41.4°

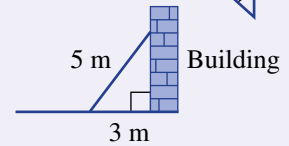

- 5** The true bearing of A from O is:

- A** 025°
- B** 125°
- C** 155°
- D** 065°
- E** 115°

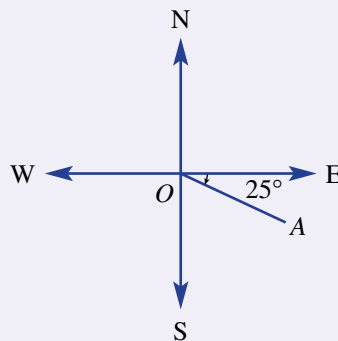

Extended-response question

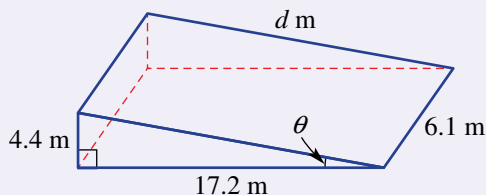

A skateboard ramp is constructed as shown.

-  **a** Calculate the distance d metres up the ramp, correct to two decimal places.



- b** What is the angle of inclination (θ) between the ramp and the ground, correct to one decimal place?
-  **c i** A skateboarder rides from one corner of the ramp diagonally to the other corner. What distance would be travelled? Round to one decimal place.
- ii** If the skateboarder travels at an average speed of 10 km/h, how many seconds does it take to ride diagonally across the ramp? Answer correct to one decimal place.

Linear relationships**Short-answer questions**

- 1** Sketch the following linear graphs labelling x - and y -intercepts.
- $y = 2x - 6$
 - $3x + 4y = 24$
 - $y = 4x$
- 2** Find the gradient of each of the following.
- The line passing through the points $(-1, 2)$ and $(2, 4)$
 - The line passing through the points $(-2, 5)$ and $(1, -4)$
 - The line with equation $y = -2x + 5$
 - The line with equation $-4x + 3y = 9$
- 3** Give the equation of the following lines in gradient–intercept form.
- The line with the given graph
 - The line with gradient 3 and passing through the point $(2, 5)$
 -  The line parallel to the line with equation $y = 2x - 1$ and passing through the origin
 -  The line perpendicular to the line with equation $y = 3x + 4$ and passing through the point $(0, 2)$
- 4** Solve the simultaneous equations $y = 2x - 4$ and $x + y = 5$ graphically by finding the coordinates of the point of intersection.

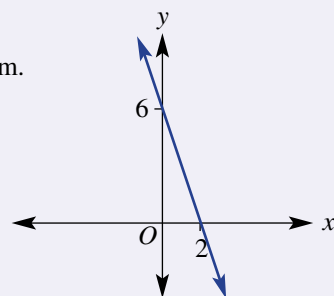

Multiple-choice questions

- 1 The coordinates of the x - and y -intercepts respectively for the graph shown are:

- A $(-2, 4)$ and $(4, -2)$
 B $(0, 4)$ and $(-2, 0)$
 C $(-2, 0)$ and $(0, 4)$
 D $(4, 0)$ and $(0, -2)$
 E $(2, 0)$ and $(0, -4)$

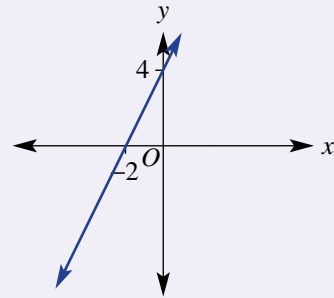

- 2 The graph shown has equation:

- A $y = 3x$
 B $y = 3$
 C $y = x + 3$
 D $x = 3$
 E $x + y = 3$

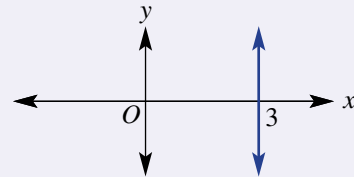

- 3 If the point $(-1, 3)$ is on the line $y = 2x + c$, the value of c is:

- A 1 B 5 C -7 D -5 E -1

- 4 The line passing through the points $(-3, -1)$ and $(1, y)$ has gradient 2. The value of y is:

- A 3 B 5 C 7 D 1 E 4

- 5 The midpoint and length (to one decimal place) of the line segment joining the points $(-2, 1)$ and $(4, 6)$ are:

- A $(1, 3.5)$ and 7.8 B $(3, 5)$ and 5.4 C $(3, 3.5)$ and 6.1
 D $(1, 3.5)$ and 3.3 E $(3, 3.5)$ and 3.6

Extended-response question

Doug works as a labourer. He is digging a trench and has 180 kg of soil to remove. He has taken 3 hours to remove 36 kg.

- What is the rate at which he is removing the soil?
- If he maintains this rate, write a rule for the amount of soil, S (kg), remaining after t hours.
- Draw a graph of your rule.
- How long will it take to remove all of the soil?
- Doug is paid \$40 for the job plus \$25 per hour worked.
 - Write a rule for his pay P dollars for working h hours.
 - How much will he be paid to remove all the soil?

Measurement

Short-answer questions

- A digital scale records the weight of a parcel to be 6.4 kg.
 - If the reading is mistakenly recorded as 6.0 kg, what is the percentage error?
 - What is the lower and upper limit of accuracy of the true recording?
- Find the area of each of the figures below. Round to two decimal places where necessary.

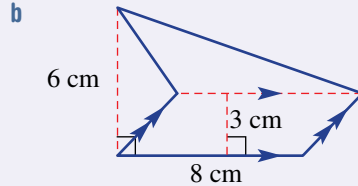
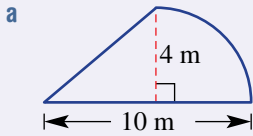

- A tin of varnish for the timber (shaded) on the deck shown covers 6.2 square metres. How many tins will be required to completely varnish the deck?

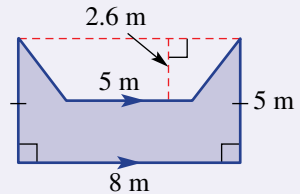

- Find the surface area of these solid objects. Round to two decimal places where necessary.

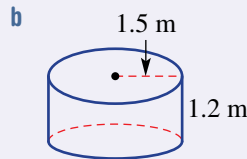
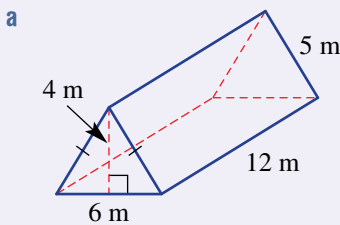

- Find the volume of the given prisms.

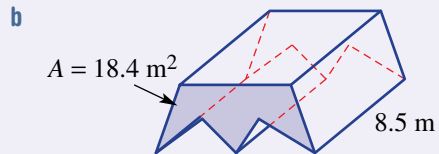
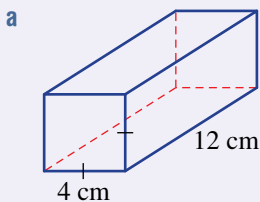

Multiple-choice questions

- The perimeter and area of the figure shown are:

- 20.2 m, 22.42 m²
- 24.8 m, 22.42 m²
- 24.8 m, 25.15 m²
- 20.2 m, 25.15 m²
- 21.6 m, 24.63 m²

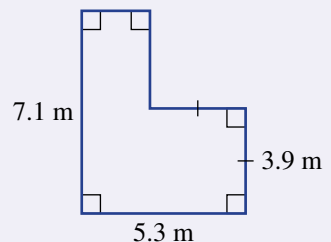

2 The exact perimeter in centimetres of this sector is:

- A 127.2
 B $\frac{81\pi}{2} + 27$
 C $12\pi + 27$
 D 45.8
 E $6\pi + 27$

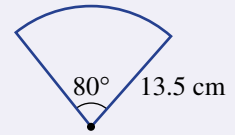

3 420 cm^2 is equivalent to:

- A 4.2 m^2 B 0.42 m^2 C 42000 m^2 D 0.042 m^2 E 0.0042 m^2

4 This square pyramid has a surface area of:

- A 525 m^2
 B 300 m^2
 C 750 m^2
 D 450 m^2
 E 825 m^2

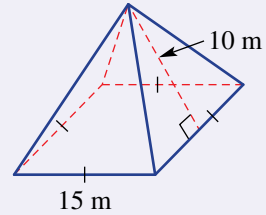

5 The volume of the cylinder shown is closest to:

- A 703.7 cm^3 B 351.9 cm^3 C 2814.9 cm^3
 D 452.4 cm^3 E 1105.8 cm^3

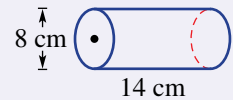

Extended-response question

6 A barn in the shape of a rectangular prism with a semicylindrical roof and with the dimensions shown is used to store hay.

a The roof and the two long side walls of the barn are to be painted. Calculate the surface area to be painted correct to two decimal places.

b A paint roller has a width of 20 cm and a radius of 3 cm.

- i Find the area of the curved surface of the paint roller in m^2 . Round to four decimal places.
 ii Hence, state the area that the roller will cover in 100 revolutions.

c Find the minimum number of revolutions required to paint the area of the barn in part a with one coat.

d Find the volume of the barn correct to two decimal places.

e A rectangular bail of hay has dimensions 1 m by 40 cm by 40 cm. If there are 115 bails of hay in the barn, what volume of air space remains? Answer to two decimal places.

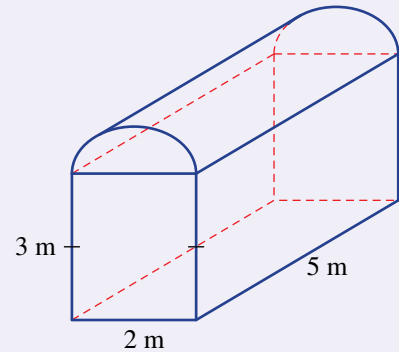

6

Indices and surds

Maths in context: Indices and the frequencies of piano notes

An octave is group of consecutive notes (i.e., 12 semi-tones). If a C starts an octave, then this C's frequency is doubled for the next higher C. A piano's lowest C frequency multiplied by $2^1, 2^2, 2^3, 2^4, \text{etc.}$, calculates all its higher C frequencies. The highest C frequency multiplied by $2^{-1}, 2^{-2}, 2^{-3}, 2^{-4}, \text{etc.}$, gives all its lower C frequencies.

Within an octave, from one semitone to the next, the frequency increases by $\times 2^{\frac{1}{12}}$ because $(2^{\frac{1}{12}})^{12} = 2^{\frac{1}{12} \times 12} = 2$. Hence in one octave, the 11 notes above C are found by multiplying the C frequency by

$$2^{\frac{1}{12}}, (2^{\frac{1}{12}})^2, \dots, (2^{\frac{1}{12}})^{10}, (2^{\frac{1}{12}})^{11}.$$

The Middle C frequency is 261.6 Hz (hertz = cycles/s).

The 2nd note, C sharp, has frequency $261.6 \times 2^{\frac{1}{12}} = 277.2$ Hz.

The 3rd note, D, has frequency $261.6 \times (2^{\frac{1}{12}})^2 = 293.6$ Hz.

The 12th note, B, has frequency $261.6 \times (2^{\frac{1}{12}})^{11} = 408.9$ Hz.

The next higher C frequency is $261.6 \times (2^{\frac{1}{12}})^{12} = 261.6 \times 2 = 523.2$ Hz.



Tuning a piano to concert pitch involves tuning the A above middle C to 440 Hz. Each note above A is $\times 2^{\frac{1}{12}}$ of the frequency of the note below it. Each note below A is $\times 2^{-\frac{1}{12}}$ of the note above's frequency. Middle C is 9 semi-tones below A, so Middle C frequency is $440 \times \left(2^{-\frac{1}{12}}\right)^9 = 261.6$ Hz.

Chapter contents

- 6A Index notation (CONSOLIDATING)
- 6B Index laws for multiplication and division
- 6C Index laws for power of a power and the zero index
- 6D Index laws for brackets and fractions
- 6E Negative indices
- 6F Scientific notation
- 6G Scientific notation using significant figures
- 6H Fractional indices and surds (EXTENDING)
- 6I Simple operations with surds (EXTENDING)

Australian Curriculum 9.0

NUMBER

Recognise that the real number system includes the rational numbers and the irrational numbers, and solve problems involving real numbers using digital tools (AC9M9N01)

ALGEBRA

Apply the exponent laws to numerical expressions with integer exponents and extend to variables (AC9M9A01)

MEASUREMENT

Solve problems involving very small and very large measurements, time scales and intervals expressed in scientific notation (AC9M9M02)

© ACARA

Online resources

A host of additional online resources are included as part of your Interactive Textbook, including HOTmaths content, video demonstrations of all worked examples, auto-marked quizzes and much more.

6A Index notation CONSOLIDATING

LEARNING INTENTIONS

- To know that indices are used as a shorthand way of representing repeated multiplication of the same factor
- To know how to interpret the base and index to write a term in expanded form
- To be able to evaluate powers
- To be able to use indices to write a product in index form
- To know how to use a factor tree to write a number as a product of its prime factors

When a product includes the repeated multiplication of the same factor, indices can be used to produce a more concise expression. For example, $5 \times 5 \times 5$ can be written as 5^3 and $x \times x \times x \times x \times x$ can be written as x^5 . The expression 5^3 is called a power, and we say '5 to the power of 3'. The 5 is called the base and the 3 is the index, exponent or power. Numbers written with indices are common in mathematics and can be applied to many types of problems. The mass of a 100 kg limestone block, for example, might decrease by 2 per cent per year for 20 years. The mass after 20 years could be calculated by multiplying 100 by 0.98, 20 times. This is written as $100 \times (0.98)^{20}$.



A wide range of people use the index laws in their profession, including scientists, chemists, radiographers, financial planners, economists, actuaries, astronomers, geologists, computer programmers, and medical, electrical, sound and aerospace engineers.

Lesson starter: Who has the most?

A person offers you one of two prizes.



- Which offer would you take?
- Try to calculate the final amount for prize B.
- How might you use indices to help calculate the value of prize B?
- How can a calculator help to find the amount for prize B using the power button (\square^{\square})?

KEY IDEAS

- **Indices** (plural of **index**) can be used to represent a product of the same factor.
- The **base** is the factor in the product.
- The index (**exponent** or **power**) is the number of times the factor (base number) is written.
- Note that $a^1 = a$.
For example: $5^1 = 5$
- **Prime factorisation** involves writing a number as a product of its prime factors.

$$108 = 2 \times 2 \times 3 \times 3 \times 3$$

$$= \underbrace{2^2 \times 3^3}_{\text{prime factor form}}$$

Expanded form	Index form	
$2 \times 2 \times 2 \times 2 \times 2$	$= 2^5 = 32$	← basic numeral
	↑	base
	↑	index

$x \times x \times x \times x$	$= x^4$	
	↑	base
	↑	index

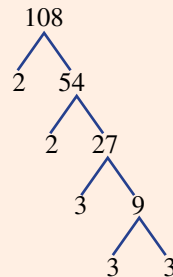

BUILDING UNDERSTANDING

1 State the missing index.

a $5^{\square} = 25$

b $2^{\square} = 8$

c $(-2)^{\square} = -8$

d $(-4)^{\square} = 16$

2 State the number or pronumeral that is the base in these expressions.

a 3^7

b $(-7)^3$

c $\left(\frac{2}{3}\right)^4$

d y^{10}

3 State the number that is the index in these expressions.

a 4^3

b $(-3)^7$

c $\left(\frac{1}{2}\right)^4$

d $(xy)^{13}$

4 State the prime factors of these numbers.

a 6

b 15

c 30

d 77

**Example 1 Writing in expanded form**

Write in expanded form:

a a^3

b $(xy)^4$

c $2a^3b^2$

SOLUTION

a $a^3 = a \times a \times a$

b $(xy)^4 = xy \times xy \times xy \times xy$

c $2a^3b^2 = 2 \times a \times a \times a \times b \times b$

EXPLANATIONFactor a is written three times.Factor xy is written four times.Factor a is written three times and factor b is written twice. Factor 2 only appears once.**Now you try**

Write in expanded form:

a b^4

b $(mn)^3$

c $5a^2b$

**Example 2 Expanding and evaluating**

Write each of the following in expanded form and then evaluate.

a 5^3

b $(-2)^5$

c $\left(\frac{2}{5}\right)^3$

SOLUTION

a $5^3 = 5 \times 5 \times 5$
 $= 125$

b $(-2)^5 = (-2) \times (-2) \times (-2) \times (-2) \times (-2)$
 $= -32$

c $\left(\frac{2}{5}\right)^3 = \frac{2}{5} \times \frac{2}{5} \times \frac{2}{5}$
 $= \frac{8}{125}$

EXPLANATION

Write in expanded form with 5 written three times and evaluate.

Write in expanded form with -2 written five times and evaluate.

Write in expanded form. Evaluate by multiplying numerators and denominators.

Now you try

Write each of the following in expanded form and then evaluate.

a 2^4

b $(-3)^3$

c $\left(\frac{4}{3}\right)^2$



Example 3 Writing in index form

Write each of the following in index form.

a $6 \times x \times x \times x \times x$

c $8 \times a \times a \times 8 \times b \times b \times a \times b$

b $\frac{3}{7} \times \frac{3}{7} \times \frac{4}{5} \times \frac{4}{5} \times \frac{4}{5}$

SOLUTION

a $6 \times x \times x \times x \times x = 6x^4$

b $\frac{3}{7} \times \frac{3}{7} \times \frac{4}{5} \times \frac{4}{5} \times \frac{4}{5} = \left(\frac{3}{7}\right)^2 \times \left(\frac{4}{5}\right)^3$

c $8 \times a \times a \times 8 \times b \times b \times a \times b$
 $= 8 \times 8 \times a \times a \times a \times b \times b \times b$
 $= 8^2 a^3 b^3$

EXPLANATION

Factor x is written 4 times, 6 only once.

There are two groups of $\left(\frac{3}{7}\right)$ and three groups of $\left(\frac{4}{5}\right)$.

Group the numerals and like pronumerals and write in index form.

Now you try

Write each of the following in index form.

a $2 \times y \times y \times y$

b $\frac{5}{9} \times \frac{5}{9} \times \frac{5}{9} \times \frac{3}{7} \times \frac{3}{7}$

c $3 \times a \times 3 \times 3 \times a$



Example 4 Finding the prime factor form

Express 48 as a product of its prime factors in index form.

SOLUTION

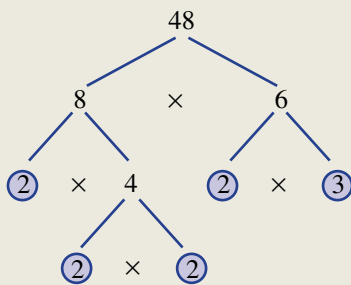

$\therefore 48 = 2 \times 2 \times 2 \times 2 \times 3$
 $= 2^4 \times 3$

EXPLANATION

Choose a pair of factors of 48, for example 8 and 6.

Choose a pair of factors of 8, i.e. 2 and 4.

Choose a pair of factors of 6, i.e. 2 and 3.

Continue this process until the factors are all prime numbers (circled numbers).

Write the prime factors of 48.

Express in index notation.

Now you try

Express 60 as a product of its prime factors in index form.

Exercise 6A

FLUENCY

1-6($\frac{1}{2}$)1-7($\frac{1}{2}$)1-7($\frac{1}{3}$)

Example 1

1 Write each of the following in expanded form.

a b^3

b x^3

c $(5a)^4$

d $(3y)^3$

e $(pq)^2$

f $-3s^3t^2$

g $6x^3y^5$

h $5(yz)^6$

Example 2

2 Write each of the following in expanded form and then evaluate.

a 6^2

b 2^4

c 3^5

d 12^1

e $(-2)^3$

f $(-1)^7$

g $(-3)^4$

h $(-5)^2$

i $(\frac{2}{3})^3$

j $(\frac{3}{4})^2$

k $(\frac{1}{6})^3$

l $(\frac{5}{2})^2$

m $(\frac{2}{-3})^3$

n $(\frac{-3}{4})^4$

o $(\frac{-1}{4})^2$

p $(\frac{5}{-2})^5$

Example 3a

3 Write each of the following in index form.

a $3 \times 3 \times 3$

b $8 \times 8 \times 8 \times 8 \times 8 \times 8$

c $y \times y$

d $3 \times x \times x \times x$

e $4 \times c \times c \times c \times c \times c \times c$

f $5 \times 5 \times 5 \times d \times d$

g $x \times x \times y \times y \times y$

h $7 \times b \times 7 \times b \times 7$

Example 3b

4 Write each of the following in index form.

a $\frac{2}{3} \times \frac{2}{3} \times \frac{2}{3} \times \frac{2}{3}$

b $\frac{3}{5} \times \frac{3}{5} \times \frac{3}{5} \times \frac{3}{5} \times \frac{3}{5}$

c $\frac{4}{7} \times \frac{4}{7} \times \frac{1}{5} \times \frac{1}{5} \times \frac{1}{5} \times \frac{1}{5}$

d $\frac{7x}{9} \times \frac{7x}{9} \times \frac{y}{4} \times \frac{y}{4} \times \frac{y}{4}$

Example 3c

5 Write each of the following in index form.

a $3 \times x \times y \times x \times 3 \times x \times 3 \times y$

b $3x \times 2y \times 3x \times 2y$

c $4d \times 2e \times 4d \times 2e$

d $6by(6by)(6y)$

e $3pq(3pq)(3pq)(3pq)$

f $7mn \times 7mn \times mn \times 7$

Example 4

6 Express each of the following as a product of prime factors in index form.

a 10

b 8

c 144

d 512

e 216

f 500

7 If $a = 3$, $b = 2$ and $c = -3$, evaluate these expressions.

a $(ab)^2$

b $(bc)^3$

c $(\frac{a}{c})^4$

d $(\frac{b}{c})^3$

e $(abc)^1$

f $c^2 + ab$

g ab^2c

h c^2ab^3

PROBLEM-SOLVING

8, 9

8-10

9-11

8 Find the missing number.

a $3^{\square} = 81$

b $2^{\square} = 256$

c $\square^3 = 125$

d $\square^5 = 32$

e $\square^3 = -64$

f $\square^7 = -128$

g $\square^3 = \frac{1}{8}$

h $(\frac{2}{3})^{\square} = \frac{16}{81}$

- 9 A bacterium splits in two every 5 minutes. New cells also continue splitting in the same way. Use a table to help.
- a How long will it take for 1 cell to divide into:
- i 4 cells? ii 16 cells? iii 64 cells?
- b A single cell is set aside to divide for 2 hours. How many cells will there be after this time?



- 10 A sharebroker says he can triple your money every year, so you invest \$1000 with him.
- a How much should your investment be worth in 5 years' time?
- b For how many years should you invest if you were hoping for a total of at least \$100 000? Give a whole number of years.
- 11 The weight of a 12 kg fat cat reduces by 10% each month. How long does it take for the cat to be at least 6 kg lighter than its original weight? Give your answer as a whole number of months.

REASONING

12, 13

12, 13

12, 13, 14(1/2)

- 12 a Evaluate the following.
- i 2^3 ii $(-3)^2$ iii $-(3)^2$ iv $-(-3)^2$
- b Explain why the answers to parts i and ii are positive.
- c Explain why the answers to parts iii and iv are negative.
- 13 a Evaluate the following.
- i 2^3 ii $(-2)^3$ iii $-(2)^3$ iv $-(-2)^3$
- b Explain why the answers to parts i and iv are positive.
- c Explain why the answers to parts ii and iii are negative.
- 14 It is often easier to evaluate a decimal raised to a power by first converting the decimal to a fraction, as shown on the right. Use this idea to evaluate these decimals as fractions.
- a $(0.5)^3$ b $(0.25)^2$ c $(0.2)^3$
- d $(0.5)^6$ e $(0.7)^2$ f $(1.5)^4$
- g $(2.6)^2$ h $(11.3)^2$ i $(3.4)^2$

$$\begin{aligned}(0.5)^4 &= \left(\frac{1}{2}\right)^4 \\ &= \frac{1}{2} \times \frac{1}{2} \times \frac{1}{2} \times \frac{1}{2} \\ &= \frac{1}{16}\end{aligned}$$

ENRICHMENT: LCM and HCF from prime factorisation

-

-

15

- 15 Last year you may have used prime factorisation to find the LCM (lowest common multiple) and the HCF (highest common factor) of two numbers. Here are the definitions.
- The LCM of two numbers in their prime factor form is the product of all the different primes raised to their highest power.
 - The HCF of two numbers in their prime factor form is the product of all the common primes raised to their smallest power.

For example: $12 = 2^2 \times 3$ and $30 = 2 \times 3 \times 5$

The prime factors 2 and 3 are common.

$$\begin{aligned}\therefore \text{HCF} &= 2 \times 3 \\ &= 6\end{aligned}\quad \begin{aligned}\therefore \text{LCM} &= 2^2 \times 3 \times 5 \\ &= 60\end{aligned}$$

Find the LCM and HCF of these pairs of numbers by first writing them in prime factor form.

- a 4, 6 b 42, 28 c 24, 36 d 10, 15
- e 40, 90 f 100, 30 g 196, 126 h 2178, 1188

6B Index laws for multiplication and division

LEARNING INTENTIONS

- To understand that only terms with the same base can be multiplied or divided
- To know that multiplying terms with the same base involves adding the powers
- To know that dividing terms with the same base involves subtracting the powers
- To be able to combine terms under multiplication and division using index laws

An index law (or identity) is an equation that is true for all possible values of the variables in that equation. When multiplying or dividing numbers with the same base, index laws can be used to simplify the expression.

Consider $a^m \times a^n$.

Using expanded form:

$$\begin{aligned} a^m \times a^n &= \underbrace{a \times a \times a \times \dots \times a}_{m \text{ factors of } a} \times \underbrace{a \times a \times \dots \times a}_{n \text{ factors of } a} \\ &= \underbrace{a \times a \times a \times \dots \times a}_{m+n \text{ factors of } a} \\ &= a^{m+n} \end{aligned}$$

So the total number of factors of a is $m + n$.

Also:

$$\begin{aligned} a^m \div a^n &= \frac{\overbrace{a \times a \times \dots \times a}^{m \text{ factors of } a}}{\underbrace{a \times \dots \times a}_{n \text{ factors of } a}} \\ &= a^{m-n} \end{aligned}$$

So the total number of factors of a is $m - n$.



Biologists and statisticians use indices when modelling exponential population growth, such as, a bacteria population $P = 2^n$ after n generations, and Australia's projected population $P = 25 \times 1.04^n$ in millions, n years from 2018.

Lesson starter: Discovering laws for multiplication and division

Consider the two expressions $2^3 \times 2^5$ and $6^8 \div 6^6$.

Complete this working.

$$\begin{aligned} 2^3 \times 2^5 &= 2 \times \square \times \square \times 2 \times \square \times \square \times \square \times \square \\ &= 2^{\square} \\ 6^8 \div 6^6 &= \frac{6 \times \square \times \square \times \square \times \square \times \square \times \square \times \square}{6 \times \square \times \square \times \square \times \square \times \square} \\ &= \frac{6 \times 6}{1} \\ &= 6^{\square} \end{aligned}$$

- What do you notice about the given expression and the answer in each case? Can you express this as a rule or law in words?
- Repeat the type of working given above and test your laws on these expressions.

a $3^2 \times 3^7$

b $4^{11} \div 4^8$

KEY IDEAS

- **Index law for multiplication:** $a^m \times a^n = a^{m+n}$
 - When multiplying terms with the same base, add the powers.
- **Index law for division:** $a^m \div a^n = \frac{a^m}{a^n} = a^{m-n}$
 - When dividing terms with the same base, subtract the powers.

BUILDING UNDERSTANDING

- 1 State the missing words.
 - a The index law for multiplication states that if you _____ two terms with the same _____ you _____ the powers.
 - b The index law for division states that if you _____ two terms with the same _____ you _____ the powers.
- 2 Give the missing numbers to complete the following.
 - a $3^2 \times 3^4 = 3 \times \square \times 3 \times \square \times \square \times \square$
 $= 3^{\square}$
 - b $5^5 \div 5^3 = \frac{5 \times \square \times \square \times \square \times \square}{5 \times \square \times \square}$
 $= 5^{\square}$
- 3 Decide if these statements are true or false.
 - a $5 \times 5 \times 5 \times 5 = 5^4$
 - b $2^6 \times 2^2 = 2^{6+2}$
 - c $7^2 \times 7^4 = 7^{4-2}$
 - d $8^4 \div 8^2 = 8^{4+2}$
 - e $a \times a^2 = a^3$
 - f $x^7 \div x = x^7$



Example 5 Using laws for multiplication and division with numerical bases

Simplify, giving your answer in index form.

a $3^6 \times 3^4$

b $7^9 \div 7^5$

SOLUTION

$$\begin{aligned} \text{a } 3^6 \times 3^4 &= 3^{6+4} \\ &= 3^{10} \end{aligned}$$

$$\begin{aligned} \text{b } 7^9 \div 7^5 &= 7^{9-5} \\ &= 7^4 \end{aligned}$$

EXPLANATION

$$a^m \times a^n = a^{m+n} \text{ (add the powers)}$$

The base 3 is retained as the power acts as a counter.

$$a^m \div a^n = a^{m-n} \text{ (subtract the powers)}$$

Now you try

Simplify, giving your answer in index form.

a $2^4 \times 2^5$

b $9^7 \div 9^3$

**Example 6 Using the index law for multiplication**

Simplify each of the following using the index law for multiplication.

a $x^4 \times x^5$

b $x^3y^4 \times x^2y$

c $3m^4 \times 2m^5$

SOLUTION

a $x^4 \times x^5 = x^{4+5}$
 $= x^9$

b $x^3y^4 \times x^2y = x^{3+2}y^{4+1}$
 $= x^5y^5$

c $3m^4 \times 2m^5 = 3 \times 2 \times m^{4+5}$
 $= 6m^9$

EXPLANATION

Use the index law for multiplication to add the indices.

Use the index law for multiplication to add the indices corresponding to each different base. Recall $y = y^1$.Multiply the numbers then use the index law for multiplication to add the indices of the base m .**Now you try**

Simplify each of the following using the index law for multiplication.

a $x^2 \times x^9$

b $a^2b^4 \times ab^3$

c $4m^2 \times 7m^3$

**Example 7 Using the index law for division**

Simplify each of the following using the index law for division.

a $x^{10} \div x^2$

b $\frac{8a^6b^3}{12a^2b^2}$

SOLUTION

a $x^{10} \div x^2 = x^{10-2}$
 $= x^8$

b $\frac{8a^6b^3}{12a^2b^2} = \frac{\overset{2}{8}a^{6-2}b^{3-2}}{\overset{3}{12}}$
 $= \frac{2a^4b}{3}$

EXPLANATION

Use the index law for division to subtract the indices.

Cancel the numbers using the highest common factor (4) and use the index law for division to subtract the indices for each different base.

Now you try

Simplify each of the following using the index law for division.

a $a^7 \div a^3$

b $\frac{4x^6y^4}{10x^3y^3}$



Example 8 Combining the index laws for multiplication and division

Simplify each of the following using the index laws for multiplication and division.

a $x^2 \times x^3 \div x^4$

b $\frac{2a^3b \times 8a^2b^3}{4a^4b^2}$

SOLUTION

a $x^2 \times x^3 \div x^4 = x^5 \div x^4$
 $= x$

b $\frac{2a^3b \times 8a^2b^3}{4a^4b^2} = \frac{16a^5b^4}{4a^4b^2}$
 $= 4ab^2$

EXPLANATION

Add the indices for $x^2 \times x^3$.

Subtract the indices for $x^5 \div x^4$.

Multiply the numbers and use the index law for multiplication to add the indices for each different base in the numerator.

Use the index law for division to subtract the indices of each different base and cancel the 16 with the 4.

Now you try

Simplify each of the following using the index laws for multiplication and division.

a $a^4 \times a^3 \div a^2$

b $\frac{5a^2b^3 \times 4ab^2}{10ab^3}$

Exercise 6B

FLUENCY

1, 2–5($\frac{1}{2}$)2–6($\frac{1}{3}$)2–6($\frac{1}{4}$)

1 Simplify, giving your answers in index form.

Example 5a

a i $2^4 \times 2^3$

ii $5^6 \times 5^3$

Example 5b

b i $3^7 \div 3^4$

ii $6^8 \div 6^3$

Example 5

2 Simplify, giving your answers in index form.

a $7^2 \times 7^4$

b $8^9 \times 8$

c $3^4 \times 3^4$

d $6^5 \times 6^9$

e $5^4 \div 5$

f $10^6 \div 10^5$

g $9^9 \div 9^6$

h $(-2)^5 \div (-2)^3$

Example 6

3 Simplify each of the following using the index law for multiplication.

a $x^4 \times x^3$

b $a^6 \times a^3$

c $t^5 \times t^3$

d $y \times y^4$

e $d^2 \times d$

f $y^2 \times y \times y^4$

g $b \times b^5 \times b^2$

h $q^6 \times q^3 \times q^2$

i $x^3y^3 \times x^4y^2$

j $x^7y^3 \times x^2y$

k $5x^3y^5 \times xy^4$

l $xy^4z \times 4xy$

m $3m^3 \times 5m^2$

n $4e^4f^2 \times 2e^2f^2$

o $5c^4d \times 4c^3d$

p $9yz^2 \times 2yz^5$

Example 7

4 Simplify each of the following using the index law for division.

a $a^6 \div a^4$

b $x^5 \div x^2$

c $\frac{q^{12}}{q^2}$

d $\frac{d^7}{d^6}$

e $\frac{8b^{10}}{4b^5}$

f $\frac{12d^{10}}{36d^5}$

g $\frac{4a^{14}}{2a^7}$

h $\frac{18y^{15}}{9y^7}$

i $9m^3 \div m^2$

j $14x^4 \div x$

k $5y^4 \div y^2$

l $6a^6 \div a^5$

m $\frac{3m^7}{12m^2}$

n $\frac{5w^2}{25w}$

o $\frac{4a^4}{20a^3}$

p $\frac{7x^5}{63x}$

q $\frac{16x^8y^6}{12x^2y^3}$

r $\frac{6s^6t^3}{14s^5t}$

s $\frac{8m^5n^4}{6m^4n^3}$

t $-\frac{5x^2y}{xy}$

Example 8

5 Simplify each of the following using the index laws for multiplication and division.

a $b^5 \times b^2 \div b$

b $y^5 \times y^4 \div y^3$

c $c^4 \div c \times c^4$

d $x^4 \times x^2 \div x^5$

e $\frac{t^4 \times t^3}{t^6}$

f $\frac{p^2 \times p^7}{p^3}$

g $\frac{d^5 \times d^3}{d^2}$

h $\frac{x^9 \times x^2}{x}$

i $\frac{3x^3y^4 \times 8xy}{6x^2y^2}$

j $\frac{9b^4}{2g^3} \times \frac{4g^4}{3b^2}$

k $\frac{24m^7n^5}{5m^3n} \times \frac{5m^2n^4}{8mn^2}$

l $\frac{p^4q^3}{p^2q} \times \frac{p^6q^4}{p^3q^2}$

6 Simplify each of the following.

a $\frac{m^4}{n^2} \times \frac{m}{n^3}$

b $\frac{x}{y} \times \frac{x^3}{y}$

c $\frac{a^4}{b^3} \times \frac{b^6}{a}$

d $\frac{12a}{3c^3} \times \frac{6a^4}{4c^4}$

e $\frac{3f^2 \times 8f^7}{4f^3}$

f $\frac{4x^2b \times 9x^3b^2}{3xb}$

g $\frac{8k^4m^5}{5km^3} \times \frac{15km}{4k}$

h $\frac{12x^7y^3}{5x^4y} \times \frac{25x^2y^3}{8xy^4}$

i $\frac{9m^5n^2 \times 4mn^3}{12mn \times m^4n^2} \times \frac{m^3n^2}{2m^2n}$

PROBLEM-SOLVING

7–8($\frac{1}{2}$)7–8($\frac{1}{2}$)8($\frac{1}{2}$), 9

7 Write the missing number.

a $2^7 \times 2^{\square} = 2^{19}$

b $6^{\square} \times 6^3 = 6^{11}$

c $11^6 \div 11^{\square} = 11^3$

d $19^{\square} \div 19^2 = 19$

e $x^6 \times x^{\square} = x^7$

f $a^{\square} \times a^2 = a^{20}$

g $b^{13} \div b^{\square} = b$

h $y^{\square} \div y^9 = y^2$

i $\square \times x^2 \times 3x^4 = 12x^6$

j $15y^4 \div (\square y^3) = y$

k $\square a^9 \div (4a) = \frac{a^8}{2}$

l $13b^6 \div (\square b^5) = \frac{b}{3}$

8 Evaluate without using a calculator.

a $7^7 \div 7^5$

b $10^6 \div 10^5$

c $13^{11} \div 13^9$

d $2^{20} \div 2^{17}$

e $101^5 \div 101^4$

f $200^{30} \div 200^{28}$

g $7 \times 31^{16} \div 31^{15}$

h $3 \times 50^{200} \div 50^{198}$

9 If m and n are positive integers, how many combinations of m and n satisfy the following?

- a $a^m \times a^n = a^8$
 b $a^m \times a^n = a^{15}$

REASONING

10

10, 11($\frac{1}{2}$)

11–12($\frac{1}{2}$)

10 The given answers are incorrect. Give the correct answer and explain the error made.

- a $a^4 \times a = a^4$ b $x^7 \div x = x^7$ c $3a^5 \div 6a^3 = 2a^2$
 d $5x^7 \div 10x^3 = \frac{1}{2x^4}$ e $2x^7 \times 3x^4 = 5x^{11}$ f $a^5 \div a^2 \times a = a^5 \div a^3 = a^2$

11 Given that $a = 2x$, $b = 4x^2$ and $c = 5x^3$, find expressions for:

- a $2a$ b $3b$ c $2c$ d $-2a$
 e abc f $\frac{c}{b}$ g $\frac{ab}{c}$ h $\frac{-2bc}{a}$

12 Simplify these expressions using the given pronumerals.

- a $2^x \times 2^y$ b $5^a \times 5^b$ c $t^x \times t^y$
 d $3^x \div 3^y$ e $10^p \div 10^q$ f $2^p \times 2^q \div 2^r$
 g $10^p \div 10^q \div 10^r$ h $2^a \times 2^{a+b} \times 2^{3a-b}$ i $a^{x-2}b^x \times a^{2x}b^3$
 j $a^x b^y \times a^y b^x$ k $a^x b^y \div (a^y b^x)$ l $w^{x+2}b^x \div w^{2x} \times b^3$
 m $\frac{a^x \times 3a^y}{3a^2}$ n $\frac{4p^a \times 5q^b}{20q^5}$ o $\frac{10k^x m^y}{8km^3} \div \frac{5k^x m^{2x}}{16k}$

ENRICHMENT: Equal to ab

–

–

13, 14

13 Show working to prove that these expressions simplify to ab .

- a $\frac{5a^2b^7}{9a^3b} \times \frac{9a^4b^2}{5a^2b^7}$ b $\frac{3a^5bc^3}{6a^4c} \times \frac{4b^3}{2abc} \times \frac{2a^3b^2c}{2a^2b^4c^2}$
 c $\frac{3a^4b^5}{a^5b^2} \div \frac{6b^3}{2a^2b}$ d $\frac{2a}{3a^2b^3} \times \frac{9a^4b^7}{ab^5} \div \frac{6a}{b^2}$

14 Make up your own expressions which simplify to ab . Test them on a friend.

6C Index laws for power of a power and the zero index

LEARNING INTENTIONS

- To know how to raise a term in index form to a power
- To know the rule for the zero power
- To be able to simplify expressions involving a power of a power and the zero power

Sometimes we find expressions already written in index form are raised to another power, such as $(2^3)^4$ or $(a^2)^5$.

Consider $(a^m)^n$.

$$\begin{aligned} \text{Using expanded form } (a^m)^n &= \overbrace{a^m \times a^m \times \dots \times a^m}^{n \text{ factors of } a^m} \\ &= \underbrace{a \times a \times \dots \times a}_{m \text{ factors of } a} \times \underbrace{a \times a \times \dots \times a}_{m \text{ factors of } a} \times \dots \times \underbrace{a \times a \times \dots \times a}_{m \text{ factors of } a} \\ &= a^{m \times n} \end{aligned}$$

So the total number of factors of a is $m \times n$.

$$\begin{aligned} \text{We also know that } a^m \div a^m &= \frac{\overbrace{a \times a \times \dots \times a}^m}{\underbrace{a \times a \times \dots \times a}_m} \\ &= \frac{1}{1} \\ &= 1 \end{aligned}$$

$$\begin{aligned} \text{But using index law for division: } a^m \div a^m &= a^{m-m} \\ &= a^0 \end{aligned}$$

This implies that $a^0 = 1$.

Lesson starter: Discovering laws for power of a power and the zero index

Use the expanded form of 5^3 to simplify $(5^3)^2$ as shown.

$$\begin{aligned} (5^3)^2 &= (5 \times \square \times \square) \times (5 \times \square \times \square) \\ &= 5^{\square} \end{aligned}$$

- Repeat the above steps to simplify $(3^2)^4$ and $(x^4)^2$.
- What do you notice about the given expression and answer in each case? Can you express this as a law or rule in words?

Now complete this table.

Index form	3^5	3^4	3^3	3^2	3^1	3^0
Basic numeral	243	81				

- What pattern do you notice in the basic numerals?
- What conclusion do you come to regarding 3^0 ?

KEY IDEAS

■ **Index law power of a power:** $(a^m)^n = a^{mn}$

- When raising a term in index form to another power, retain the base and multiply the indices. For example: $(x^2)^3 = x^{2 \times 3} = x^6$.

■ **The zero index:** $a^0 = 1$, where $a \neq 0$

- Any expression except 0 raised to the power of zero is 1. For example: $(2a)^0 = 1$.

BUILDING UNDERSTANDING

1 State the missing words or numbers in these sentences.

- a When raising a term or numbers in index form to another power, _____ the indices.
 b Any expression (except 0) raised to the power 0 is equal to _____.

2 State the missing numbers in these tables.

a

Index form	2^6	2^5	2^4	2^3	2^2	2^1	2^0
Basic numeral	64	32					

b

Index form	4^5	4^4	4^3	4^2	4^1	4^0
Basic numeral	1024	256				

3 State the missing numbers in this working.

a $(4^2)^3 = (4 \times \square) \times (4 \times \square) \times (4 \times \square)$
 $= 4^\square$

b $(a^2)^5 = (a \times \square) \times (a \times \square) \times (a \times \square) \times (a \times \square) \times (a \times \square)$
 $= a^\square$



Example 9 Using the index law for power of a power

Apply the index law for power of a power to simplify each of the following.

a $(x^5)^4$

b $3(y^5)^2$

SOLUTION

a $(x^5)^4 = x^{5 \times 4}$
 $= x^{20}$

b $3(y^5)^2 = 3y^{5 \times 2}$
 $= 3y^{10}$

EXPLANATION

Retain x as the base and multiply the indices.

Retain y and multiply the indices. The power only applies to the bracketed term.

Continued on next page

Now you try

Apply the index law for power of a power to simplify each of the following.

a $(a^3)^2$

b $5(b^2)^7$

**Example 10 Using the zero index**

Apply the zero index rule to evaluate each of the following.

a $(-3)^0$

b $-(5x)^0$

c $2y^0 - (3y)^0$

SOLUTION

a $(-3)^0 = 1$

b $-(5x)^0 = -1$

$$\begin{aligned} \text{c } 2y^0 - (3y)^0 &= 2 \times 1 - 1 \\ &= 2 - 1 \\ &= 1 \end{aligned}$$

EXPLANATION

Any number raised to the power of 0 is 1.

Everything in the brackets is to the power of 0 so $(5x)^0$ is 1.

$2y^0$ has no brackets so the power applies to the y only, so $2y^0 = 2 \times y^0 = 2 \times 1$ while $(3y)^0 = 1$.

Now you try

Apply the zero index rule to evaluate each of the following.

a $(-2)^0$

b $-(4a)^0$

c $6x^0 - (2x)^0$

**Example 11 Combining index laws**

Simplify each of the following by applying the various index laws.

a $(x^2)^3 \times (x^3)^5$

b $\frac{(m^3)^4}{m^7}$

c $\frac{4x^2 \times 3x^3}{6x^5}$

SOLUTION

$$\begin{aligned} \text{a } (x^2)^3 \times (x^3)^5 &= x^6 \times x^{15} \\ &= x^{21} \end{aligned}$$

$$\begin{aligned} \text{b } \frac{(m^3)^4}{m^7} &= \frac{m^{12}}{m^7} \\ &= m^5 \end{aligned}$$

EXPLANATION

Use the index law for power of a power to remove brackets first by multiplying indices. Then use the index law for multiplication to add indices.

Remove brackets by multiplying indices then simplify using the index law for division.

$$\begin{aligned} \text{c } \frac{4x^2 \times 3x^3}{6x^5} &= \frac{12x^5}{6x^5} \\ &= 2x^0 \\ &= 2 \times 1 \\ &= 2 \end{aligned}$$

Simplify the numerator first by multiplying numbers and adding indices of base x .

Then cancel and subtract indices.

The zero power says $x^0 = 1$.

Now you try

Simplify each of the following by applying the various index laws.

a $(y^3)^4 \times (y^2)^3$

b $\frac{(t^2)^4}{t^3}$

c $\frac{5m^2 \times 2m^4}{10m^5}$

Exercise 6C

FLUENCY

1–5(1/2)

1–6(1/2)

1–6(1/3)

Example 9

- 1 Apply the index law for power of a power to simplify each of the following. Leave your answers in index form.

a $(x^2)^5$

b $(b^3)^4$

c $(a^4)^5$

d $(m^6)^2$

e $(3^2)^3$

f $(4^3)^5$

g $(3^5)^6$

h $(7^5)^2$

i $4(q^7)^4$

j $3(m^2)^5$

k $-3(c^2)^5$

l $-4(a^7)^3$

Example 10a, b

- 2 Evaluate each of the following.

a 5^0

b 9^0

c $(-6)^0$

d $(-3)^0$

e $-(4^0)$

f $\left(\frac{3}{4}\right)^0$

g $\left(-\frac{1}{7}\right)^0$

h $(4y)^0$

Example 10c

- 3 Evaluate each of the following.

a $5m^0$

b $-3p^0$

c $6x^0 - 2x^0$

d $-5n^0 - (8n)^0$

e $(3x^4)^0 + 3x^0$

f $1^0 + 2^0 + 3^0$

g $(1 + 2 + 3)^0$

h $100^0 - a^0$

Example 11a

- 4 Simplify each of the following by combining various index laws.

a $4 \times (4^3)^2$

b $(3^4)^2 \times 3$

c $x \times (x^0)^5$

d $y^5 \times (y^2)^4$

e $b^5 \times (b^3)^3$

f $(a^2)^3 \times a^4$

g $(d^3)^4 \times (d^2)^6$

h $(y^2)^6 \times (y)^4$

i $z^4 \times (z^3)^2 \times (z^5)^3$

j $a^3 f \times (a^4)^2 \times (f^4)^3$

k $x^2 y \times (x^3)^4 \times (y^2)^2$

l $(s^2)^3 \times 5(r^0)^3 \times r s^2$

Example 11b

- 5 Simplify each of the following.

a $7^8 \div (7^3)^2$

b $(4^2)^3 \div 4^5$

c $(3^6)^3 \div (3^5)^2$

d $(m^3)^6 \div (m^2)^9$

e $(y^5)^3 \div (y^6)^2$

f $(h^{11})^2 \div (h^5)^4$

g $\frac{(b^2)^5}{b^4}$

h $\frac{(x^4)^3}{x^7}$

i $\frac{(y^3)^3}{y^3}$

Example 11c

6 Simplify each of the following using various index laws.

a $\frac{3x^4 \times 6x^3}{9x^{12}}$

b $\frac{5x^5 \times 4x^2}{2x^{10}}$

c $\frac{24(x^4)^4}{8(x^4)^2}$

d $\frac{4(d^4)^3 \times (e^4)^2}{8(d^2)^5 \times e^7}$

e $\frac{6(m^3)^2(n^5)^3}{15(m^5)^0(n^2)^7}$

f $\frac{2(a^3)^4(b^2)^6}{16(a^0)(b^6)^2}$

PROBLEM-SOLVING

7

7, 8

8, 9

7 There are 100 rabbits on Mt Burrow at the start of the year 2010. The rule for the number of rabbits N after t years (from the start of the year 2010) is $N = 100 \times 2^t$.

a Find the number of rabbits when:

i $t = 2$

ii $t = 6$

iii $t = 0$

b Find the number of rabbits at the beginning of:

i 2013

ii 2017

iii 2020

c How many years will it take for the population to first rise to more than 500 000? Give a whole number of years.

8 If m and n are positive integers, in how many ways can $(a^m)^n = a^{16}$?

9 Evaluate these without using a calculator.

a $(2^4)^8 \div 2^{30}$

b $(10^3)^7 \div 10^{18}$

c $(x^4)^9 \div x^{36}$

d $((-1)^{11})^2 \times ((-1)^2)^{11}$

e $-2((-2)^3)^3 \div (-2)^8$

f $\frac{(a^2)^3}{(b^4)^7} \times \frac{(b^7)^4}{(a^3)^2}$

REASONING

10

10, 11

11, 12

10 Explain the error made in the following problems then give the correct answer.

a $(a^4)^5 = a^9$

b $3(x^3)^2 = 9x^6$

c $(2x)^0 = 2$

11 a Simplify these by first working with the inner brackets. Leave your answer in index form.

i $((2^3)^4)^2$

ii $(((-2)^2)^5)^3$

iii $((x^6)^2)^7$

iv $((a^2)^4)^3)^2$

b Simplify these expressions.

i $((2^a)^b)^c$

ii $((a^m)^n)^p$

iii $(x^{2y})^{3z}$

12 a Show that $\frac{5a^2b}{2ab^2} \div \frac{10a^4b^7}{4a^3b^8}$ is equal to 1.

b Make up your own expression like the one above for which the answer is equal to 1. Test it on a friend.

ENRICHMENT: Changing the base

-

-

13($\frac{1}{2}$)

13 The base of a number in index form can be changed using the index law for power of a power.

$$\text{For example: } 8^2 = (2^3)^2 \\ = 2^6$$

Change the base numbers and simplify the following using the smallest possible base integer.

a 8^4

b 32^3

c 9^3

d 81^5

e 25^5

f 243^{10}

g 256^9

h 2401^{20}

i $100\,000^{10}$

6D Index laws for brackets and fractions

LEARNING INTENTIONS

- To understand that all numbers or pronumerals multiplied or divided in brackets are raised to the power outside the brackets
- To be able to expand brackets involving powers
- To be able to combine all index laws to simplify expressions

It is common to find expressions such as $(2x)^3$ and $(\frac{x}{3})^4$ in mathematical problems. These differ from most of the expressions in previous sections in that they contain two or more numbers or pronumerals connected by multiplication or division and raised to a power. These expressions can also be simplified using two index laws, which effectively remove the brackets.

Consider $(a \times b)^m$.

Using expanded form:

$$\begin{aligned}
 (a \times b)^m &= \overbrace{ab \times ab \times ab \times \dots \times ab}^{m \text{ factors of } ab} \\
 &= \overbrace{a \times a \times \dots \times a}^{m \text{ factors of } a} \times \overbrace{b \times b \times \dots \times b}^{m \text{ factors of } b} \\
 &= a^m \times b^m
 \end{aligned}$$

So, this becomes a product of m factors of a and m factors of b .

Also:

$$\begin{aligned}
 \left(\frac{a}{b}\right)^m &= \overbrace{\frac{a}{b} \times \frac{a}{b} \times \frac{a}{b} \times \dots \times \frac{a}{b}}^{m \text{ factors of } \frac{a}{b}} \\
 &= \frac{\overbrace{a \times a \times a \times \dots \times a}^{m \text{ factors of } a}}{\overbrace{b \times b \times b \times \dots \times b}^{m \text{ factors of } b}} \\
 &= \frac{a^m}{b^m}
 \end{aligned}$$

So to remove the brackets, we can raise each of a and b to the power m .

Lesson starter: Discovering laws for brackets and fractions

Use the expanded form of $(2x)^3$ and $(\frac{x}{3})^4$ to help simplify the expressions.

$$\begin{aligned}
 (2x)^3 &= 2x \times \square \times \square \\
 &= 2 \times 2 \times 2 \times \square \times \square \times \square \\
 &= 2^{\square} \times \square^{\square}
 \end{aligned}$$

$$\begin{aligned}
 \left(\frac{x}{3}\right)^4 &= \frac{x}{3} \times \square \times \square \times \square \\
 &= \frac{x \times \square \times \square \times \square}{3 \times \square \times \square \times \square} \\
 &= \frac{\square^{\square}}{\square^{\square}}
 \end{aligned}$$

- Repeat these steps to also simplify the expressions $(3y)^4$ and $(\frac{x}{2})^5$.
- What do you notice about the given expressions and the answer in each case? Can you express this as a rule or law in words?

KEY IDEAS

■ **Index law for brackets:** $(a \times b)^m = (ab)^m = a^m b^m$

- When multiplying two or more numbers raised to the power of m , raise each number in the brackets to the power of m . For example: $(2x)^2 = 2^2 x^2 = 4x^2$.

■ **Index law for fractions:** $\left(\frac{a}{b}\right)^m = \frac{a^m}{b^m}$ and $b \neq 0$

- When dividing two numbers raised to the power of m , raise each number in the brackets to the power of m . For example: $\left(\frac{y}{3}\right)^3 = \frac{y^3}{3^3} = \frac{y^3}{27}$.

BUILDING UNDERSTANDING

1 State the missing terms to complete the index laws for brackets and fractions.

a $(a \times b)^m = a^m \times \square$

b $\left(\frac{a}{b}\right)^m = \frac{a^m}{\square}$

2 State the missing terms to complete this working.

a $(5a)^3 = 5a \times \square \times \square$
 $= 5 \times 5 \times 5 \times a \times \square \times \square$
 $= 5^3 \times \square$

b $\left(\frac{x}{6}\right)^3 = \frac{x}{6} \times \square \times \square$
 $= \frac{x \times \square \times \square}{6 \times \square \times \square}$
 $= \frac{x^3}{\square}$



Example 12 Using the index law for brackets

Expand each of the following using the index law for brackets.

a $(5b)^3$

b $(-2x^3y)^4$

c $4(c^2d^3)^5$

d $3a^2(2a^3)^4$

SOLUTION

a $(5b)^3 = 5^3 b^3$
 $= 125b^3$

b $(-2x^3y)^4 = (-2)^4 (x^3)^4 y^4$
 $= 16x^{12}y^4$

c $4(c^2d^3)^5 = 4(c^2)^5 (d^3)^5$
 $= 4c^{10}d^{15}$

EXPLANATION

Raise each numeral and pronumeral in the brackets to the power of 3.
 Evaluate $5^3 = 5 \times 5 \times 5$.

Raise each value in the brackets to the power of 4.
 Evaluate $(-2)^4$ and simplify using the index law for power of a power.

Raise each value in the brackets to the power of 5.
 Note that the coefficient (4) is not raised to the power of 5.
 Simplify using index laws.

$$\begin{aligned} \text{d } 3a^2(2a^3)^4 &= 3a^2(2^4)(a^3)^4 \\ &= 3a^2 \times 16 \times a^{12} \\ &= 48a^{14} \end{aligned}$$

Raise each value in the brackets to the power of 4.
Use the index law for multiplication to combine terms with the same base: $a^2 \times a^{12} = a^{2+12}$.

Now you try

Expand each of the following using the index law for brackets.

$$\text{a } (3a)^2 \qquad \text{b } (-3x^2y^3)^3 \qquad \text{c } 5(a^2b)^4 \qquad \text{d } 4b^3(2b^4)^2$$



Example 13 Using the index law for fractions

Apply the index law for fractions to the following.

$$\text{a } \left(\frac{6}{b}\right)^3 \qquad \text{b } \left(\frac{-2a^2}{3bc^3}\right)^4 \qquad \text{c } \left(\frac{x^2y^3}{c}\right)^3 \times \left(\frac{xc}{y}\right)^4$$

SOLUTION

$$\begin{aligned} \text{a } \left(\frac{6}{b}\right)^3 &= \frac{6^3}{b^3} \\ &= \frac{216}{b^3} \end{aligned}$$

$$\begin{aligned} \text{b } \left(\frac{-2a^2}{3bc^3}\right)^4 &= \frac{(-2)^4a^8}{3^4b^4c^{12}} \\ &= \frac{16a^8}{81b^4c^{12}} \end{aligned}$$

$$\begin{aligned} \text{c } \left(\frac{x^2y^3}{c}\right)^3 \times \left(\frac{xc}{y}\right)^4 &= \frac{x^6y^9}{c^3} \times \frac{x^4c^4}{y^4} \\ &= \frac{x^{10}y^9c^4}{c^3y^4} \\ &= x^{10}y^5c \end{aligned}$$

EXPLANATION

Raise each value in the brackets to the power of 3 and evaluate 6^3 .

Raise each value in the brackets to the power of 4.
Recall $(a^2)^4 = a^{2 \times 4}$ and $(c^3)^4 = c^{3 \times 4}$.
Evaluate $(-2)^4$ and 3^4 .

Raise each value in the brackets to the power.
Multiply the numerators using the index law for multiplication then divide using the index law for division.

Now you try

Apply the index law for fractions to the following.

$$\text{a } \left(\frac{2}{x}\right)^5 \qquad \text{b } \left(\frac{-3m^3}{2np^2}\right)^2 \qquad \text{c } \left(\frac{xy^2}{2}\right)^3 \times \left(\frac{x}{3y}\right)^2$$

Exercise 6D

FLUENCY

1–3($\frac{1}{2}$)1–4($\frac{1}{2}$)1–4($\frac{1}{3}$)

Example 12a–c

1 Expand each of the following using the index law for brackets.

a $(5y)^2$

b $(4a^2)^3$

c $(-3r)^2$

d $-(3b)^4$

e $-(7r)^3$

f $(-2h^2)^4$

g $(5c^2d^3)^4$

h $(2x^3y^2)^5$

i $9(p^2q^4)^3$

j $(8t^2u^9v^4)^0$

k $-4(p^4qr)^2$

l $(-5s^7t)^2$

Example 12d

2 Simplify each of the following by applying the various index laws.

a $a(3b)^2$

b $a(3b^2)^3$

c $-3(2a^3b^4)^2a^2$

d $2(3x^2y^3)^3$

e $(-4b^2c^5d)^3$

f $a(2a)^3$

g $a(3a^2)^2$

h $5a^3(-2a^4b)^3$

i $-5(-2m^3p^2t)^5$

j $-(-7d^2f^4g)^2$

k $-2(-2^3x^4yz^3)^3$

l $-4a^2b^3(-2a^3b^2)^2$

m $(a^2b)^3 \times (ab^2)^4$

n $\frac{(2m^3n)^3}{m^4}$

o $\frac{3(2^2c^4d^5)^3}{(2cd^2)^4}$

Example 13a,b

3 Apply the index law for fractions to expand the following.

a $\left(\frac{p}{q}\right)^3$

b $\left(\frac{x}{y}\right)^4$

c $\left(\frac{4}{y}\right)^3$

d $\left(\frac{2}{r^3}\right)^2$

e $\left(\frac{s^3}{7}\right)^2$

f $\left(\frac{2m}{n}\right)^5$

g $\left(\frac{3n^3}{2m^4}\right)^3$

h $\left(\frac{-2r}{n}\right)^4$

i $\left(\frac{-3f}{2^3g^5}\right)^2$

j $\left(\frac{-3x}{2y^3g^5}\right)^2$

k $\left(\frac{3km^3}{4n^7}\right)^3$

l $-\left(\frac{-5w^4y}{2x^3}\right)^2$

Example 13c

4 Simplify each of the following.

a $\left(\frac{x^2}{y}\right)^3 \times \frac{2x}{y^4}$

b $\left(\frac{a^2b}{c}\right)^4 \times \left(\frac{b^2}{c}\right)^3$

c $\left(\frac{pq^3}{r^2}\right)^2 \times \left(\frac{p^0q^2}{r}\right)^4$

d $\left(\frac{a^3b}{c}\right)^3 \times \left(\frac{ac^4}{b}\right)^2$

e $\left(\frac{x^2z}{y}\right)^4 \times \left(\frac{xy^2}{z}\right)^3$

f $\left(\frac{r^3s}{t}\right)^2 \div \left(\frac{s}{rt^4}\right)^3$

PROBLEM-SOLVING

5

5, 6($\frac{1}{2}$)5, 6($\frac{1}{2}$)

5 The rule for the number of seeds germinating in a glasshouse over a two-week period is given by

 $N = \left(\frac{t}{2}\right)^3$ where N is the number of germinating seeds and t is the number of days.

a Find the number of germinating seeds after:

i 4 days

ii 10 days

b Use the index law for fractions to rewrite the rule without brackets.

c Use your rule in part b to find the number of seeds germinating after:

i 6 days

ii 4 days

d Find the number of days required to germinate:

i 64 seeds

ii 1 seed



6 Find the value of a that makes these equations true, given $a > 0$.

a $\left(\frac{a}{3}\right)^2 = \frac{4}{9}$

b $\left(\frac{a}{2}\right)^4 = 16$

c $(5a)^3 = 1000$

d $(2a)^4 = 256$

e $\left(\frac{2a}{3}\right)^2 = \frac{4}{9}$

f $\left(\frac{6a}{7}\right)^3 = 1728$

REASONING 7 7, 8 7, 8

7 Decide if the following are true or false. Give reasons.

a $(-2x)^2 = -(2x)^2$

b $(-3x)^3 = -(3x)^3$

c $\left(\frac{-5}{x}\right)^5 = -\left(\frac{5}{x}\right)^5$

d $\left(\frac{-4}{x}\right)^4 = -\left(\frac{4}{x}\right)^4$

8 Rather than evaluating $\frac{2^4}{4^4}$ as $\frac{16}{256} = \frac{1}{16}$, it is easier to evaluate $\frac{2^4}{4^4}$ in the way shown below.

$$\frac{2^4}{4^4} = \left(\frac{2}{4}\right)^4 = \left(\frac{1}{2}\right)^4 = \frac{1^4}{2^4} = \frac{1}{16}$$

a Explain why this method is helpful.

b Use this idea to evaluate these without the use of a calculator.

i $\frac{6^3}{3^3}$

ii $\frac{10^4}{5^4}$

iii $\frac{4^4}{12^4}$

iv $\frac{3^3}{30^3}$

ENRICHMENT: False laws - - 9

9 Consider the equation $(a + b)^2 = a^2 + b^2$.

a Using $a = 2$ and $b = 3$, evaluate $(a + b)^2$.

b Using $a = 2$ and $b = 3$, evaluate $a^2 + b^2$.

c Would you say that the equation is true for all values of a and b ?

d Now decide whether $(a - b)^2 = a^2 - b^2$ for all values of a and b . Give an example to support your answer.

e Decide if these equations are true or false for all values of a and b .

i $(-ab)^2 = a^2b^2$

ii $-(ab)^2 = a^2b^2$

iii $\left(\frac{-a}{b}\right)^3 = \frac{-a^3}{b^3} (b \neq 0)$

iv $\left(\frac{-a}{b}\right)^4 = \frac{-a^4}{b^4} (b \neq 0)$



Index laws are routinely used in the finance industry, including by corporate and personal financial advisors and investment bankers. For example, \$ P invested at $r\%$ p.a. for n years increases to $\$A = P\left(1 + \frac{r}{100}\right)^n$.

6E Negative indices

LEARNING INTENTIONS

- To understand that negative indices relate to division
- To know how to express a term involving a negative index with a positive index
- To be able to write expressions involving negative indices with positive indices
- To be able to evaluate numbers raised to negative indices without a calculator

We know that $2^3 = 8$ and $2^0 = 1$, but what about 2^{-1} or 2^{-6} ? Such numbers written in index form using negative indices also have meaning in mathematics.

Consider $a^2 \div a^5$.

Method 1: Using the index law *Method 2:* By cancelling for division

$$\begin{aligned} \frac{a^2}{a^5} &= a^{2-5} & \frac{a^2}{a^5} &= \frac{a^1 \times a^1}{a \times a \times a \times a_1 \times a_1} \\ &= a^{-3} & &= \frac{1}{a^3} \\ & & \therefore a^{-3} &= \frac{1}{a^3} \end{aligned}$$

Also, using the index law for multiplication we can write:

$$\begin{aligned} a^m \times a^{-m} &= a^{m+(-m)} \\ &= a^0 \\ &= 1 \end{aligned}$$

So dividing by a^m we have $a^{-m} = \frac{1}{a^m}$ or dividing by a^{-m} we have $a^m = \frac{1}{a^{-m}}$.



Audio engineers who set up loud speaker systems for live performances know that, as sound travels from its source, its intensity, I , is inversely proportional (\propto) to the distance, d , squared, i.e. $I \propto \frac{1}{d^2}$ or $I \propto d^{-2}$

Lesson starter: Continuing the pattern

Explore the use of negative indices by completing this table.

Index form	2^4	2^3	2^2	2^1	2^0	2^{-1}	2^{-2}	2^{-3}
Whole number or fraction	16	8					$\frac{1}{4} = \frac{1}{2^2}$	



- What do you notice about the numbers with negative indices in the top row in comparison to the fractions in the second row?
- Can you describe this connection formally in words?
- What might be another way of writing 2^{-7} or 5^{-4} ?

KEY IDEAS

- $a^{-m} = \frac{1}{a^m}$ For example: $2^{-3} = \frac{1}{2^3} = \frac{1}{8}$ (2^{-3} is the reciprocal of 2^3)
- $\frac{1}{a^{-m}} = a^m$ For example: $\frac{1}{2^{-3}} = 2^3 = 8$ (2^3 is the reciprocal of 2^{-3})
- a^{-1} is the reciprocal of a^1 , which is $\frac{1}{a}$ For example: $5^{-1} = \frac{1}{5}$, which is the reciprocal of 5
- $\left(\frac{a}{b}\right)^{-1}$ is the reciprocal of $\frac{a}{b}$, which is $\frac{b}{a}$ For example: $\left(\frac{2}{3}\right)^{-1} = \frac{3}{2}$, which is the reciprocal of $\frac{2}{3}$

BUILDING UNDERSTANDING

1 State the following using positive indices. For example: $\frac{1}{8} = \frac{1}{2^3}$.

a $\frac{1}{4}$

b $\frac{1}{9}$

c $\frac{1}{125}$

d $\frac{1}{27}$

2 State the missing numbers in these patterns.

a

Index form	3^4	3^3	3^2	3^1	3^0	3^{-1}	3^{-2}	3^{-3}
Whole number or fraction	81	27					$\frac{1}{9} = \frac{1}{3^2}$	

b

Index form	10^4	10^3	10^2	10^1	10^0	10^{-1}	10^{-2}	10^{-3}
Whole number or fraction	10000							$\frac{1}{1000} = \frac{1}{10^3}$



Example 14 Writing expressions using positive indices

Express each of the following with positive indices only.

a x^{-2}

b $3a^{-2}b^4$

SOLUTION

a $x^{-2} = \frac{1}{x^2}$

$$\begin{aligned} \text{b } 3a^{-2}b^4 &= \frac{3}{1} \times \frac{1}{a^2} \times \frac{b^4}{1} \\ &= \frac{3b^4}{a^2} \end{aligned}$$

EXPLANATION

$a^{-m} = \frac{1}{a^m}$

Rewrite a^{-2} using a positive power and combine numerators and denominators.

Now you try

Express each of the following with positive indices only.

a a^{-3}

b $2x^{-4}y^3$



Example 15 Using $\frac{1}{a^{-m}} = a^m$

Express each of the following using positive indices only.

a $\frac{1}{c^{-2}}$

b $\frac{5}{x^3y^{-4}}$

c $\frac{x^{-3}}{y^{-5}}$

SOLUTION

a $\frac{1}{c^{-2}} = c^2$

b $\frac{5}{x^3y^{-4}} = \frac{5}{x^3} \times \frac{1}{y^{-4}}$
 $= \frac{5y^4}{x^3}$

c $\frac{x^{-3}}{y^{-5}} = x^{-3} \times \frac{1}{y^{-5}}$
 $= \frac{1}{x^3} \times \frac{y^5}{1}$
 $= \frac{y^5}{x^3}$

EXPLANATION

$$\frac{1}{a^{-m}} = a^m$$

Express $\frac{1}{y^{-4}}$ as a positive power, y^4 .

Express x^{-3} and $\frac{1}{y^{-5}}$ with positive indices using

$$a^{-m} = \frac{1}{a^m} \text{ and } \frac{1}{a^{-m}} = a^m.$$

Now you try

Express each of the following using positive indices only.

a $\frac{1}{a^{-3}}$

b $\frac{6}{a^2b^{-5}}$

c $\frac{x^{-2}}{y^{-4}}$



Example 16 Evaluating without a calculator

Express using positive powers only, then evaluate without using a calculator.

a 3^{-4}

b $\frac{-5}{3^{-2}}$

c $\left(\frac{2}{3}\right)^{-4}$

SOLUTION

a $3^{-4} = \frac{1}{3^4}$
 $= \frac{1}{81}$

b $\frac{-5}{3^{-2}} = -5 \times \frac{1}{3^{-2}}$
 $= -5 \times 3^2$
 $= -5 \times 9$
 $= -45$

EXPLANATION

Express 3^{-4} as a positive power and evaluate 3^4 .

Express $\frac{1}{3^{-2}}$ as a positive power and simplify.

$$\begin{aligned}
 \text{c } \left(\frac{2}{3}\right)^{-4} &= \frac{2^{-4}}{3^{-4}} \\
 &= 2^{-4} \times \frac{1}{3^{-4}} \\
 &= \frac{1}{2^4} \times 3^4 \\
 &= \frac{3^4}{2^4} = \frac{81}{16}
 \end{aligned}$$

Apply the power to each numeral in the brackets using the index law for fractions.

Express 2^{-4} and $\frac{1}{3^{-4}}$ with positive indices and evaluate.

Now you try

Express using positive powers only, then evaluate without using a calculator.

a 2^{-5}

b $\frac{-4}{2^{-3}}$

c $\left(\frac{5}{7}\right)^{-2}$

Exercise 6E

FLUENCY

1-3($\frac{1}{2}$)1-4($\frac{1}{3}$)1-4($\frac{1}{4}$)

Example 14

1 Express each of the following with positive indices only.

a x^{-5}

b a^{-4}

c b^{-6}

d 5^{-2}

e 4^{-3}

f 9^{-1}

g $5x^{-2}$

h $4y^{-3}$

i $3m^{-5}$

j p^7q^{-2}

k mn^{-4}

l x^4y^{-4}

m $2a^{-3}b^{-1}$

n $7r^{-2}s^{-3}$

o $5^{-1}u^{-8}v^2$

p $9^{-1}m^{-3}n^{-5}$

Example 15a

2 Express each of the following using positive indices only.

a $\frac{1}{y^{-1}}$

b $\frac{1}{b^{-2}}$

c $\frac{1}{m^{-5}}$

d $\frac{1}{x^{-4}}$

e $\frac{7}{q^{-1}}$

f $\frac{3}{t^{-2}}$

g $\frac{5}{h^{-4}}$

h $\frac{4}{p^{-4}}$

i $\frac{a}{b^{-2}}$

j $\frac{e}{d^{-1}}$

k $\frac{2n^2}{m^{-3}}$

l $\frac{y^5}{3x^{-2}}$

m $\frac{-3}{7y^{-4}}$

n $\frac{-2}{b^{-8}}$

o $\frac{-3g}{4h^{-3}}$

p $\frac{(-3u)^2}{5t^{-2}}$

Example 15b

3 Express each of the following using positive indices only.

a $\frac{7}{x^{-4}y^3}$

b $\frac{1}{u^{-3}v^2}$

c $\frac{a^{-3}5^{-1}}{y^{-3}}$

d $\frac{2a^{-4}}{b^{-5}c^2}$

e $\frac{5a^2c^{-4}}{6b^{-2}d}$

f $\frac{5^{-1}h^3k^{-2}}{4^{-1}m^{-2}p}$

g $\frac{4t^{-1}u^{-2}}{3^{-1}v^2w^{-6}}$

h $\frac{4^{-1}x^2y^{-5}}{4m^{-1}n^{-4}}$

Example 15c

4 Express each of the following using positive indices only.

a $\frac{a^{-3}}{b^{-3}}$

b $\frac{x^{-2}}{y^{-5}}$

c $\frac{g^{-2}}{h^{-3}}$

d $\frac{m^{-1}}{n^{-1}}$

e $\frac{5^{-1}}{7^{-3}}$

f $\frac{3^{-2}}{4^{-3}}$

g $\frac{5^{-2}}{6^{-1}}$

h $\frac{4^{-3}}{8^{-2}}$

PROBLEM-SOLVING

5($\frac{1}{2}$)5($\frac{1}{2}$), 65($\frac{1}{3}$), 6, 7

Example 16

5 Evaluate without the use of a calculator. (*Hint*: Write expressions using positive indices.)

a 5^{-1}

b 3^{-2}

c $(-4)^{-2}$

d -5^{-2}

e 4×10^{-2}

f -5×10^{-3}

g -3×2^{-2}

h $8 \times (2^2)^{-2}$

i $6^4 \times 6^{-6}$

j $8^{-7} \times (8^2)^3$

k $(5^2)^{-1} \times (2^{-2})^{-1}$

l $(3^{-2})^2 \times (7^{-1})^{-1}$

m $\frac{1}{8^{-1}}$

n $\frac{1}{10^{-2}}$

o $\frac{-2}{5^{-3}}$

p $\frac{2}{2^{-3}}$

q $\frac{-5}{2^{-1}}$

r $\frac{2^3}{2^{-3}}$

s $\left(\frac{3}{8}\right)^{-2}$

t $\left(\frac{-4}{3}\right)^{-3}$

u $\frac{(-5)^2}{2^{-2}}$

v $\frac{(3^{-2})^3}{3^{-5}}$

w $\frac{(-2^{-3})^{-3}}{(2^{-2})^{-4}}$

x $\left(\frac{2^{-4}}{7^{-2}}\right)^{-1} \times \left(\frac{7^{-1}}{2^{-1}}\right)^{-4}$

6 The mass of a small insect is 2^{-9} kg. How many grams is this? Round to two decimal places.7 Find the value of x in these equations.

a $2^x = \frac{1}{16}$

b $5^x = \frac{1}{625}$

c $(-3)^x = \frac{1}{81}$

d $(0.5)^x = 2$

e $(0.2)^x = 25$

f $3(2^{2x}) = 0.75$

REASONING

8

8

8, 9

8 Describe the error made in these problems then give the correct answer.

a $2x^{-2} = \frac{1}{2x^2}$

b $\frac{5}{a^4} = \frac{a^{-4}}{5}$

c $\frac{2}{(3b)^{-2}} = \frac{2b^2}{9}$

9 Consider the number $\left(\frac{2}{3}\right)^{-1}$.

a Complete this working: $\left(\frac{2}{3}\right)^{-1} = \frac{1}{\left(\frac{2}{3}\right)} = 1 \div \boxed{} = 1 \times \boxed{} = \frac{3}{2}$

b Show similar working as in part a to simplify these.

i $\left(\frac{5}{4}\right)^{-1}$

ii $\left(\frac{2}{7}\right)^{-1}$

iii $\left(\frac{x}{3}\right)^{-1}$

iv $\left(\frac{a}{b}\right)^{-1}$

c What conclusion can you come to regarding the simplification of fractions raised to the power -1 ?

d Simplify these fractions.

i $\left(\frac{2}{3}\right)^{-2}$

ii $\left(\frac{4}{5}\right)^{-2}$

iii $\left(\frac{1}{2}\right)^{-5}$

iv $\left(\frac{7}{3}\right)^{-3}$

ENRICHMENT: Exponential equations

-

-

10

10 To find x in $2^x = 32$ you could use trial and error; however, the following approach is more useful.

$$2^x = 32$$

$$2^x = 2^5 \text{ (express 32 using a matching base)}$$

$$\therefore x = 5$$

Use this idea to solve for x in these equations.

a $2^x = 16$

b $3^x = 81$

c $\left(\frac{1}{2}\right)^x = \frac{1}{8}$

d $\left(\frac{1}{7}\right)^x = \frac{1}{49}$

e $\left(\frac{2}{3}\right)^x = \frac{16}{81}$

f $4^{2x} = 64$

g $3^{x+1} = 243$

h $2^{3x-1} = 64$

6F Scientific notation

LEARNING INTENTIONS

- To understand that scientific notation is a shorthand way of writing very large and very small numbers
- To know the general form of scientific notation
- To understand when positive or negative powers of 10 are used in scientific notation
- To be able to convert between scientific notation and decimal form
- To know how to convert between large and small units of time

It is common in the practical world to be working with very large or very small numbers. For example, the number of cubic metres of concrete used to build the Hoover Dam in the United States was $3\,400\,000\text{ m}^3$ and the mass of a molecule of water is $0.000000000000000000000000299$ grams. Such numbers can be written more efficiently using powers of 10 with positive or negative indices. This is called scientific notation or standard form. The number is written using a number between 1 inclusive and 10 and this is multiplied by a power of 10. Such notation is also used to state very large and very small time intervals.

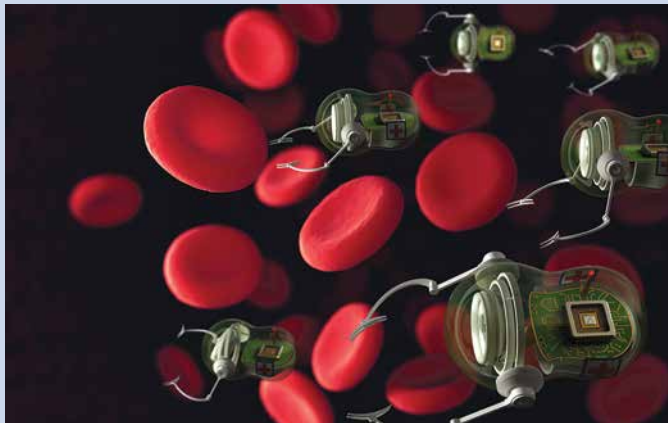

Nano-robotics is an area of experimental research for disease control, such as targeted cancer drug delivery. Nanobots are micrometres long, 3×10^{-6} m, with components nanometres long, e.g. (1×10^{-9}) m. One nanometre is around $\frac{1}{100\,000}$ of a hair's diameter.

Lesson starter: Building scientific notation

Use the information given to complete the table.

Decimal form	Working	Scientific notation
2 350 000	$2.35 \times 1\,000\,000$	2.35×10^6
502 170		
314 060 000		
0.000298	$2.98 \div 10\,000 = \frac{2.98}{10^4}$	2.98×10^{-4}
0.000004621		
0.003082		

- Discuss how each number using scientific notation is formed.
- When are positive indices used and when are negative indices used?
- Where does the decimal point appear to be placed when using scientific notation?

KEY IDEAS

- Numbers written in **scientific notation** are expressed in the form $a \times 10^m$ where $1 \leq a < 10$ or $-10 < a \leq -1$ and m is an integer.
- Large numbers will use positive powers of 10.
For example: 38 million years = 38 000 000 years
 $= 3.8 \times 10^7$ years
- Small numbers will use negative powers of 10.
For example: 417 nanoseconds = 0.000000417 seconds
 $= 4.17 \times 10^{-7}$ seconds
- To write numbers using scientific notation, place the decimal point after the first non-zero digit then multiply by a power of 10.
- There are common prefixes for units that correspond to powers of 10.
 - tera: 10^{12} e.g. One terabyte = 10^{12} bytes
 - giga: 10^9
 - mega: 10^6
 - kilo: 10^3
 - milli: 10^{-3} e.g. one milligram = 10^{-3} grams
 - micro: 10^{-6}
 - nano: 10^{-9}
 - pico: 10^{-12}
- Examples of units for which very large or small numbers may be used:
 - 2178 km = 2178×10^3 m = 2 178 000 m = 2.178×10^6 metres
 - 2320 tonnes = 2 320 000 kg or 2.32×10^6 kg
 - 16 gigabytes = 16 000 000 000 bytes or 1.6×10^{10} bytes
 - 109 milliseconds (thousandths of a second) = 109×10^{-3} seconds = 0.109 seconds or 1.09×10^{-1} seconds
 - 27 microns (millionth of a metre) = 0.000027 m or 2.7×10^{-5} metres
 - 54 nanoseconds (billionth of a second) = 0.000000054 or 5.4×10^{-8} seconds

BUILDING UNDERSTANDING

- 1 Which of the numbers 1000, 10 000 or 100 000 completes each equation?

a $6.2 \times \underline{\quad} = 62\,000$	b $9.41 \times \underline{\quad} = 9410$
c $1.03 \times \underline{\quad} = 103\,000$	d $3.2 \div \underline{\quad} = 0.0032$
e $5.16 \div \underline{\quad} = 0.0000516$	f $1.09 \div \underline{\quad} = 0.000109$
- 2 State the following as powers of 10.

a 100 000	b 100	c 1 000 000 000
-----------	-------	-----------------
- 3 If these numbers were written using scientific notation, would positive or negative indices be used?

a 2000	b 0.0004	c 19 300	d 0.00101431
--------	----------	----------	--------------

**Example 17 Writing numbers using scientific notation**

Write the following numbers using scientific notation.

a 4 500 000

b 0.0000004

SOLUTION

a $4\ 500\ 000 = 4.5 \times 10^6$

b $0.0000004 = 4 \times 10^{-7}$

EXPLANATIONPlace the decimal point after the first non-zero digit (4) then multiply by 10^6 since the decimal place has been moved 6 places to the left.The first non-zero digit is 4. Multiply by 10^{-7} since the decimal place has been moved 7 places to the right.**Now you try**

Write the following numbers using scientific notation.

a 720 000

b 0.000003

**Example 18 Writing numbers in decimal form**

Express each of the following in decimal form.

a 9.34×10^5

b 4.71×10^{-5}

SOLUTION

a $9.34 \times 10^5 = 934\ 000$

b $4.71 \times 10^{-5} = 0.0000471$

EXPLANATION

Move the decimal point 5 places to the right.

Move the decimal point 5 places to the left and insert zeros where necessary.

Now you try

Express each of the following in decimal form.

a 6.17×10^3

b 4.02×10^{-6}

Exercise 6F**FLUENCY**

1-5($\frac{1}{2}$)

1-5($\frac{1}{2}$)

1-5($\frac{1}{3}$)

Example 17a

1 Write the following using scientific notation.

a 43 000

b 2 300 000 000 000

c 16 000 000 000

d -7 200 000

e -3500

f -8 800 000

g 52 hundreds

h 3 million

i 21 thousands

Example 17b

2 Write the following using scientific notation.

- | | | | | | |
|---|----------------|---|-------------|---|----------------|
| a | 0.000003 | b | 0.0004 | c | -0.00876 |
| d | 0.00000000073 | e | -0.00003 | f | 0.000000000125 |
| g | -0.00000000809 | h | 0.000000024 | i | 0.0000345 |

3 Write each of the following numbers using scientific notation.

- | | | | | | |
|---|--------------|---|---------|---|----------|
| a | 6000 | b | 720 000 | c | 324.5 |
| d | 7869.03 | e | 8459.12 | f | 0.2 |
| g | 0.000328 | h | 0.00987 | i | -0.00001 |
| j | -460 100 000 | k | 17 467 | l | -128 |

Example 18a

4 Express each of the following in decimal form.

- | | | | | | |
|---|--------------------|---|--------------------|---|-----------------------|
| a | 5.7×10^4 | b | 3.6×10^6 | c | 4.3×10^8 |
| d | 3.21×10^7 | e | 4.23×10^5 | f | 9.04×10^{10} |
| g | 1.97×10^8 | h | 7.09×10^2 | i | 6.357×10^5 |

Example 18b

5 Express each of the following in decimal form.

- | | | | | | |
|---|-----------------------|---|------------------------|---|-----------------------|
| a | 1.2×10^{-4} | b | 4.6×10^{-6} | c | 8×10^{-10} |
| d | 3.52×10^{-5} | e | 3.678×10^{-1} | f | 1.23×10^{-7} |
| g | 9×10^{-5} | h | 5×10^{-2} | i | 4×10^{-1} |

PROBLEM-SOLVING

6-8($\frac{1}{2}$)6-8($\frac{1}{2}$), 9, 106-8($\frac{1}{2}$), 10, 11

6 Express each of the following approximate numbers using scientific notation.

- The mass of Earth is 6 000 000 000 000 000 000 000 kg.
- The diameter of Earth is 40 000 000 m.
- The diameter of a gold atom is 0.000000001 m.
- The radius of Earth's orbit around the Sun is 150 000 000 km.
- The universal constant of gravitation is $0.000000000667 \text{ Nm}^2/\text{kg}^2$.
- The half-life of polonium-214 is 0.00015 seconds.
- Uranium-238 has a half-life of 4 500 000 000 years.



7 Express each of the following in decimal form.

- Neptune is approximately 4.6×10^9 km from Earth.
- A population of bacteria contained 8×10^{12} organisms.
- The Moon is approximately 3.84×10^5 km from Earth.
- A fifty-cent coin is approximately 3.8×10^{-3} m thick.
- The diameter of the nucleus of an atom is approximately 1×10^{-14} m.
- The population of a city is 7.2×10^5 .



8 Write the following using scientific notation in the units given in the brackets. Use the key ideas for help with the prefixes.

- | | | | |
|---|----------------------------|---|------------------------------|
| a | 492 milliseconds (seconds) | b | 0.38 milliseconds (seconds) |
| c | 2.1 microseconds (seconds) | d | 0.052 microseconds (seconds) |
| e | 4 nanoseconds (seconds) | f | 139.2 nanoseconds (seconds) |
| g | 4 megabytes (bytes) | h | 2 terabytes (bytes) |
| i | 52 giganlitres (litres) | j | 0.182 megalitres (litres) |
| k | 18 picograms (grams) | l | 0.4 micrograms (grams) |

9 When Sydney was planning for the 2000 Olympic Games, the Olympic Organising Committee made the following predictions.

- The cost of staging the games would be A\$1.7 billion ($\1.7×10^9) (excluding infrastructure). In fact, \$140 million extra was spent on staging the games.
- The cost of constructing or upgrading infrastructure would be \$807 million.

Give each of the following answers in scientific notation.

- a The actual total cost of staging the Olympic Games.
b The total cost of staging the games and constructing or upgrading the infrastructure.

 10 Two planets are 2.8×10^8 km and 1.9×10^9 km from their closest sun. What is the difference between these two distances in scientific notation?

 11 Two particles weigh 2.43×10^{-2} g and 3.04×10^{-3} g. Find the difference in their weight in scientific notation.

REASONING

12($\frac{1}{2}$)12($\frac{1}{2}$)12–13($\frac{1}{3}$)

12 The number 47×10^4 is not written using scientific notation since 47 is not a number between 1 and 10. The following shows how to convert to scientific notation.

$$\begin{aligned} 47 \times 10^4 &= 4.7 \times 10 \times 10^4 \\ &= 4.7 \times 10^5 \end{aligned}$$

Write these numbers using scientific notation.

- | | | | |
|-------------------------|---------------------------|----------------------------|-----------------------------|
| a 32×10^3 | b 41×10^5 | c 317×10^2 | d 5714×10^2 |
| e 0.13×10^5 | f 0.092×10^3 | g 0.003×10^8 | h 0.00046×10^9 |
| i 61×10^{-3} | j 424×10^{-2} | k 1013×10^{-6} | l $490\,000 \times 10^{-1}$ |
| m 0.02×10^{-3} | n 0.0004×10^{-2} | o 0.00372×10^{-1} | p 0.04001×10^{-6} |

13 Use the index law: $(a^m)^n = a^{m \times n}$ and the index law: $(a \times b)^m = a^m \times b^m$ to simplify these numbers. Give your answer using scientific notation.

- | | | | |
|-----------------------------|-----------------------------|------------------------------------|------------------------------------|
| a $(2 \times 10^2)^3$ | b $(3 \times 10^4)^2$ | c $(2.5 \times 10^{-2})^2$ | d $(1.5 \times 10^{-3})^3$ |
| e $(2 \times 10^{-3})^{-3}$ | f $(5 \times 10^{-4})^{-2}$ | g $(\frac{1}{3} \times 10^2)^{-2}$ | h $(\frac{2}{5} \times 10^4)^{-1}$ |

ENRICHMENT: Scientific notation with index laws

–

–

14($\frac{1}{2}$), 15, 16

14 Use index laws to simplify these and write using scientific notation.

- | | |
|--|--|
| a $(3 \times 10^2) \times (2 \times 10^4)$ | b $(4 \times 10^4) \times (2 \times 10^7)$ |
| c $(8 \times 10^6) \div (4 \times 10^2)$ | d $(9 \times 10^{20}) \div (3 \times 10^{11})$ |
| e $(7 \times 10^2) \times (8 \times 10^2)$ | f $(1.5 \times 10^3) \times (8 \times 10^4)$ |
| g $(6 \times 10^4) \div (0.5 \times 10^2)$ | h $(1.8 \times 10^6) \div (0.2 \times 10^3)$ |
| i $(3 \times 10^{-4}) \times (3 \times 10^{-5})$ | j $(15 \times 10^{-2}) \div (2 \times 10^6)$ |
| k $(4.5 \times 10^{-3}) \div (3 \times 10^2)$ | l $(8.8 \times 10^{-1}) \div (8.8 \times 10^{-1})$ |

15 Determine, using index laws, how many seconds it takes for light to travel from the Sun to Earth given that Earth is 1.5×10^8 km from the Sun and the speed of light is 3×10^5 km/s.

16 Using index laws and the fact that the speed of light is equal to 3×10^5 km/s, determine:

- a how far light travels in one nanosecond (1×10^{-9} seconds). Answer using scientific notation in kilometres then convert your answer to centimetres.
b how long light takes to travel 300 kilometres. Answer in seconds.

6G Scientific notation using significant figures

LEARNING INTENTIONS

- To know the rules for counting significant figures
- To be able to determine the number of significant figures in a number
- To be able to write numbers in scientific notation rounded to a set number of significant figures
- To be able to use scientific notation on a calculator

The number of digits used to record measurements depends on how accurately the measurements can be recorded.

The volume of Earth, for example, has been calculated as $1\,083\,210\,000\,000\text{ km}^3$. This appears to show six significant figures and could be written using scientific notation as 1.08321×10^{12} . A more accurate calculation may include more non-zero digits in the last seven places.

The mass of a single oxygen molecule is known to be $0.0000000000000000000000000053\text{ g}$. This shows two significant figures and is written using scientific notation as 5.3×10^{-26} . On many calculators you will notice that very large or very small numbers are automatically converted to scientific notation using a certain number of significant figures. Numbers can also be entered into a calculator using scientific notation.



Palaeontologists, who study fossils, use 1 or 2 significant figures for the estimated time period when Tyrannosaurus Rex dinosaurs lived on Earth, i.e. from 7×10^7 years ago to 6.5×10^7 years ago.

Lesson starter: Significant discussions

Begin a discussion regarding significant figures by referring to these questions.

- Why is the volume of Earth given as $1\,083\,210\,000\,000\text{ km}^3$ written using seven zeros at the end of the number? Wouldn't the exact mass of Earth include some other digits in these places?
- Why is the mass of an oxygen molecule given as 5.3×10^{-26} written using only two significant digits? Wouldn't the exact mass of a water molecule include more decimal places?

KEY IDEAS

- **Significant figures** are counted from left to right starting at the first non-zero digit. Zeros with no non-zero digit on their right are not counted. For example:
 - 38 041 has five significant figures
 - 0.0016 has two significant figures
 - 3.21×10^4 has three significant figures.
- When using scientific notation the first significant figure sits to the left of the decimal point.
- Calculators can be used to work with scientific notation.
 - $\boxed{\text{E}}$ or $\boxed{\text{EE}}$ or $\boxed{\text{EXP}}$ or $\boxed{\times 10^x}$ are common key names on calculators.
 - Pressing $2.37 \boxed{\text{EE}} 5$ gives 2.37×10^5 and $2.37\text{E}5$ means 2.37×10^5 .

BUILDING UNDERSTANDING

- 1 State the missing numbers in these tables, rounding each number to the given number of significant figures.

a 57 263

Significant figures	Rounded number
4	
3	57 300
2	
1	

b 0.0036612

Significant figures	Rounded number
4	
3	
2	
1	0.004

- 2 Decide if the following numbers are written using scientific notation with three significant figures.

- a 4.21×10^4
 b 32×10^{-3}
 c 1803×10^6
 d 0.04×10^2
 e 1.89×10^{-10}
 f 9.04×10^{-6}
 g 5.56×10^{-14}
 h 0.213×10^2
 i 26.1×10^{-2}



Example 19 Stating the number of significant figures

State the number of significant figures given in these numbers.

- a 451 b 0.005012 c 3.2×10^7

SOLUTION

- a 3 significant figures
 b 4 significant figures
 c 2 significant figures

EXPLANATION

Starting at the '4' and moving right we count three digits.
 Start counting at the first non-zero digit.
 With scientific notation the first significant figure is to the left of the decimal point.

Now you try

State the number of significant figures given in these numbers.

- a 4174 b 0.0103 c 5.81×10^4



Example 20 Writing numbers in scientific notation using significant figures

Write these numbers using scientific notation and three significant figures.

a 2 183 000

b 0.0019482

SOLUTION

a $2\,183\,000 = 2.18 \times 10^6$ (to 3 sig. fig.)

b $0.0019482 = 1.95 \times 10^{-3}$ (to 3 sig. fig.)

EXPLANATION

Put the decimal point after the first non-zero digit. The decimal point has moved 6 places to the left, so multiply by 10^6 . Round the third significant figure down since the following digit is less than 5.

Move the decimal point 3 places to the right and multiply by 10^{-3} . Round the third significant figure up to 5 since the following digit is greater than 4.

Now you try

Write these numbers using scientific notation and two significant figures.

a 487 130

b 0.06531



Example 21 Using a calculator with scientific notation

Use a calculator to evaluate each of the following, leaving your answers in scientific notation correct to four significant figures.

a $3.67 \times 10^5 \times 23.6 \times 10^4$

b $7.6 \times 10^{-3} + \sqrt{2.4 \times 10^{-2}}$

SOLUTION

a $3.67 \times 10^5 \times 23.6 \times 10^4$
 $= 8.661 \times 10^{10}$ (to 4 sig. fig.)

b $7.6 \times 10^{-3} + \sqrt{2.4 \times 10^{-2}}$
 $= 0.1625$
 $= 1.625 \times 10^{-1}$ (to 4 sig. fig.)

EXPLANATION

Use a calculator and locate the button used to enter scientific notation. Write using scientific notation with four significant figures.

Use a calculator and locate the button used to enter scientific notation. Write using scientific notation with a number between 1 and 10.

Now you try

Use a calculator to evaluate each of the following, leaving your answers in scientific notation correct to three significant figures.

a $2.1 \times 10^3 \times 36.7 \times 10^5$

b $1.04 \times 10^{-4} + \sqrt{4.8 \times 10^{-3}}$

Exercise 6G

FLUENCY

1, 2-5($\frac{1}{2}$)2-6($\frac{1}{3}$)2-6($\frac{1}{4}$)

1 State the number of significant figures in these numbers.

Example 19a

a i 4361

ii 72

Example 19b

b i 0.016

ii 0.000749

Example 19c

c i 1.8×10^4

ii 1.402×10^{-3}

Example 19

2 State the number of significant figures in these numbers.

a 202

b 1007

c 30101

d 19

e 0.0183

f 0.2

g 0.706

h 0.00109

i 4.21×10^3

j 2.905×10^{-2}

k 1.07×10^{-6}

l 5.9×10^5

Example 20

3 Write these numbers using scientific notation and three significant figures.

a 242 300

b 171 325

c 2829

d 3 247 000

e 0.00034276

f 0.006859

g 0.01463

h 0.001031

i 23.41

j 326.042

k 19.618

l 0.172046

4 Write each number using scientific notation rounding to the number of significant figures given in the brackets.

a 47 760 (3)

b 21 610 (2)

c 4 833 160 (4)

d 37.16 (2)

e 99.502 (3)

f 0.014427 (4)

g 0.00201 (1)

h 0.08516 (1)

i 0.0001010 (1)

Example 21a

5 Use a calculator to evaluate each of the following, leaving your answers in scientific notation correct to four significant figures.

a 4^{-6}

b 78^{-3}

c $(-7.3 \times 10^{-4})^{-5}$

d $\frac{3.185}{7 \times 10^4}$

e $2.13 \times 10^4 \times 9 \times 10^7$

f $5.671 \times 10^2 \times 3.518 \times 10^5$

g $9.419 \times 10^5 \times 4.08 \times 10^{-4}$

h $2.85 \times 10^{-9} \times 6 \times 10^{-3}$

i 12345^2

j 87.14^8

k $\frac{1.8 \times 10^{26}}{4.5 \times 10^{22}}$

l $\frac{-4.7 \times 10^2 \times 6.1 \times 10^7}{3.2 \times 10^6}$

Example 21b

6 Use a calculator to evaluate each of the following, leaving your answers in scientific notation correct to five significant figures.

a $\sqrt{8756}$

b $\sqrt{634 \times 7.56 \times 10^7}$

c $8.6 \times 10^5 + \sqrt{2.8 \times 10^{-2}}$

d $-8.9 \times 10^{-4} + \sqrt{7.6 \times 10^{-3}}$

e $\frac{5.12 \times 10^{21} - 5.23 \times 10^{20}}{2 \times 10^6}$

f $\frac{8.942 \times 10^{47} - 6.713 \times 10^{44}}{2.5 \times 10^{19}}$

g $\frac{2 \times 10^7 + 3 \times 10^8}{5}$

h $\frac{4 \times 10^8 + 7 \times 10^9}{6}$

i $\frac{6.8 \times 10^{-8} + 7.5 \times 10^{27}}{4.1 \times 10^{27}}$

j $\frac{2.84 \times 10^{-6} - 2.71 \times 10^{-9}}{5.14 \times 10^{-6} + 7 \times 10^{-8}}$

PROBLEM-SOLVING

7, 8

8–10

9, 10

- 7 The mass of Earth is approximately 6 000 000 000 000 000 000 000 kg. Given that the mass of the Sun is 330 000 times the mass of Earth, find the mass of the Sun. Express your answer using scientific notation correct to three significant figures.



- 8 The diameter of Earth is approximately 12 756 000 m. If the Sun's diameter is 109 times that of Earth, calculate its diameter in kilometres. Express your answer using scientific notation correct to three significant figures.
- 9 Using the formula for the volume of a sphere, $V = \frac{4\pi r^3}{3}$, and, assuming Earth to be spherical, calculate the volume of Earth in km^3 . Use the data given in Question 8 and express your answer using scientific notation correct to three significant figures.
- 10 Write these numbers from largest to smallest.
 2.41×10^6 , 24.2×10^5 , 0.239×10^7 , 2421×10^3 , 0.02×10^8

REASONING

11

11, 12

12, 13

- 11 The following output is common on a number of different calculators and computers. Write down the number that you think they represent.
- | | |
|---------------------|-----------------------|
| a 4.26E6 | b 9.1E – 3 |
| c 5.04EXP11 | d 1.931EXP – 1 |
| e 2.1 ⁰⁶ | f 6.14 ⁻¹¹ |
- 12 Anton writes down $352\,000 \times 250\,000 = 8.8^{10}$. Explain his error.
- 13 a Round these numbers to three significant figures. Retain the use of scientific notation.
- | | | |
|-----------------------|----------------------------|-------------------------|
| i 2.302×10^2 | ii 4.9045×10^{-2} | iii 3.996×10^6 |
|-----------------------|----------------------------|-------------------------|
- b What do you notice about the digit that is the third significant figure?
 c Why do you think that it might be important to a scientist to show a significant figure that is a zero at the end of a number?

ENRICHMENT: Combining bacteria

–

–

14

- 14 A flask of type A bacteria contains 5.4×10^{12} cells and a flask of type B bacteria contains 4.6×10^8 cells. The two types of bacteria are combined in the same flask.
- a How many bacterial cells are there in the flask?
 b If type A bacterial cells double every 8 hours and type B bacterial cells triple every 8 hours how many cells are in the flask after:
- | | | |
|------------|------------|--------------|
| i one day? | ii a week? | iii 30 days? |
|------------|------------|--------------|
- Express your answers using scientific notation correct to three significant figures.

The following problems will investigate practical situations drawing upon knowledge and skills developed throughout the chapter. In attempting to solve these problems, aim to identify the key information, use diagrams, formulate ideas, apply strategies, make calculations and check and communicate your solutions.

Double the success

- 1 Through active investment, Angela's portfolio doubles in value every decade (10 years) and started with an initial investment of \$100 000.

Angela is interested in the value of her investment over time and the time that it takes for it to reach certain investment goals.

- a Complete this table showing the value of Angela's investment over 4 decades.

Decade (n)	0	1	2	3	4
Value (\$ V)	100 000				

- b Which rule links the value of Angela's investment, \$ V , over n decades?

A $V = 100\,000n$

B $V = 100\,000 \times 2^n$

C $V = 100\,000 \times n^2$

D $V = 2^n$

- c Use the correct rule from part b to calculate the value of Angela's investment after:

i 6 decades

ii 1.5 decades (to the nearest cent).

- d Use trial and error to find how long it takes for Angela's investment to grow in value to the following amounts. Round to the nearest year.

i \$150 000

ii \$1 000 000

- e A friend of Angela is claiming that their investment of \$50 000 is tripling in value every decade.

i Find a rule for the value, \$ V , of the friend's investment after n decades.

ii Assuming that the friend's investment started at the same time as Angela's, find how long it would take for the investments to be of the same value. Round to the nearest year. A trial and error approach is appropriate.

Rupert's Moon facts

- 2 Rupert is studying the Moon and finds these facts:

- Diameter 3475 km
- Mass: 7.35×10^{22} kg
- Average distance to Earth: 384 400 km
- Formation: 4.6 billion years ago
- NASA program cost: \$25.4 billion (about \$120 billion today)
- Dust particle diameter: 50 micrometres



Rupert is interested in the facts about the Moon and tries to make sense of all the numbers.

He wants to use scientific notation to deal with the size of the numbers involved.

- a Consider the average distance to Earth.

i Write this number using scientific notation.

ii If a rocket travels at 10 km per second, how long will it take to get to the Moon? Answer using hours and minutes.

- b Consider the Moon's diameter.

i Write this number using scientific notation.

ii Find the difference between the Moon's diameter and Earth's diameter (12 742 km).

Express your answer using scientific notation and two significant figures.

- c Consider the time of formation.
 - i Write this number using scientific notation.
 - ii Write in decimal form.
- d Consider the program cost at the time. If an average car at the time cost \$2000, how many cars could have been purchased for the same amount of money?
- e Consider the Moon's mass. How many times heavier is Earth if Earth's mass is 5.972×10^{24} kg? Round to the nearest integer.
- f Consider the diameter of a dust particle.
 - i Write this number in metres using scientific notation.
 - ii How many dust particles sitting in a single row would you need to make a line 1 m long?

Computer depreciation

- 3 Reynah buys a new computer and at the end of each year, notices that the computer's value has dropped by 50% from the previous year's value.

The rule for linking the computer's value, \$ V , n years after purchase is given by:

$$V = 3000 \times 0.5^n$$

Reynah is interested in the rate at which the computer's value is decreasing and the time that it takes for it to be valued at a certain price.

- a Find the initial value of the computer (i.e. find the value of V when $n = 0$).
- b Find the value of the computer after:
 - i 2 years
 - ii 5 years.
- c Use trial and error to find how long it takes for the computer to decrease in value to the following amounts. Answer in years correct to one decimal place.
 - i \$1000
 - ii \$200
- d The rule linking V with n can also be written as $V = 3000 \times 2^{-n}$.
 - i Explain why the rule can also be written this way.
 - ii Use this rule to verify your answers to part b.
- e Another computer costs \$5000 and reduces in value so that each year its value is one third of the value from the previous year. Write a rule connecting the computer's value, \$ V , after n years using:
 - i a positive index
 - ii a negative index.
- f After how long will the two computers above have the same value, assuming they were purchased at the same time? Answer in years correct to one decimal place.



6H Fractional indices and surds EXTENDING

LEARNING INTENTIONS

- To know how to use a root sign to rewrite numbers with a fractional index
- To understand what type of number is a surd
- To be able to evaluate numbers involving a fractional index
- To be able to use index laws with fractional indices

So far we have considered indices including positive and negative integers and zero. Numbers can also be expressed using fractional indices. Two examples are $9^{\frac{1}{2}}$ and $5^{\frac{1}{3}}$.

Using the index law for multiplication: $9^{\frac{1}{2}} \times 9^{\frac{1}{2}} = 9^{\frac{1}{2} + \frac{1}{2}} = 9^1 = 9$

Since $\sqrt{9} \times \sqrt{9} = 9$ and $9^{\frac{1}{2}} \times 9^{\frac{1}{2}} = 9^1$ then $9^{\frac{1}{2}} = \sqrt{9}$.

Using the index law for multiplication: $5^{\frac{1}{3}} \times 5^{\frac{1}{3}} \times 5^{\frac{1}{3}} = 5^{\frac{1}{3} + \frac{1}{3} + \frac{1}{3}} = 5^1 = 5$

Since $\sqrt[3]{5} \times \sqrt[3]{5} \times \sqrt[3]{5} = 5$ and $5^{\frac{1}{3}} \times 5^{\frac{1}{3}} \times 5^{\frac{1}{3}} = 5$ then $5^{\frac{1}{3}} = \sqrt[3]{5}$.

This shows that numbers with fractional powers can be written using root signs. In the example above, $9^{\frac{1}{2}}$ is the square root of 9 ($\sqrt{9}$) and $5^{\frac{1}{3}}$ is the cube root of 5 ($\sqrt[3]{5}$).

You will have noticed that $9^{\frac{1}{2}} = \sqrt{9} = 3 = \frac{3}{1}$ and so $9^{\frac{1}{2}}$ is a rational number (a fraction), but $5^{\frac{1}{3}} = \sqrt[3]{5}$ does not appear to be able to be expressed as a fraction. In fact, $\sqrt[3]{5}$ is irrational and cannot be expressed as a fraction and is called a surd. As a decimal $\sqrt[3]{5} = 1.70997594668\dots$, which is an infinite, non-recurring decimal with no repeated pattern. This is a characteristic of all surds.

Lesson starter: A surd or not?

Surds are numbers with a root sign that cannot be expressed as a fraction. As a decimal they are infinite and non-recurring (with no pattern).

Use a calculator to help complete the table on the right then decide if you think the numbers are surds.

Index form	With root sign	Decimal	Surd (Yes or No)
$2^{\frac{1}{2}}$	$\sqrt{2}$		
$4^{\frac{1}{2}}$	$\sqrt{4}$		
$11^{\frac{1}{2}}$			
$36^{\frac{1}{2}}$			
$\left(\frac{1}{9}\right)^{\frac{1}{2}}$			
$(0.1)^{\frac{1}{2}}$			
$3^{\frac{1}{3}}$	$\sqrt[3]{3}$		
$3^{\frac{1}{3}}$	$\sqrt[3]{8}$		
$15^{\frac{1}{3}}$			
$\left(\frac{1}{27}\right)^{\frac{1}{3}}$			
$5^{\frac{1}{4}}$			
$64^{\frac{1}{6}}$			

KEY IDEAS

- Numbers written with **fractional indices** can also be written using a root sign.

- $a^{\frac{1}{m}} = \sqrt[m]{a}$
- $\sqrt[n]{a}$ is written $a^{\frac{1}{n}}$

For example: $3^{\frac{1}{2}} = \sqrt{3}$, $7^{\frac{1}{3}} = \sqrt[3]{7}$, $2^{\frac{1}{5}} = \sqrt[5]{2}$

- Surds are irrational numbers written with a root sign.
 - Irrational numbers cannot be expressed as a fraction.
 - The decimal expansion is infinite and non-recurring with no pattern.

$$\sqrt{2} = 1.41421356237\dots$$

$$\sqrt[3]{10} = 2.15443469003\dots$$

$$3^{\frac{1}{2}} = 1.73205080757\dots$$

BUILDING UNDERSTANDING

- 1 Evaluate these numbers. What do you notice?

a 2^2 and $\sqrt{4}$

b 2^3 and $\sqrt[3]{8}$

c 3^2 and $\sqrt{9}$

d 3^3 and $\sqrt[3]{27}$

e 4^2 and $\sqrt{16}$

f 4^3 and $\sqrt[3]{64}$

- 2 State whether the following are true or false.

a Rational numbers can be written as fractions.

b A surd is a rational number.

c A surd in decimal form will be infinite and non-recurring (with no pattern).

d $\sqrt{3} = 3^{\frac{1}{2}}$

e $\sqrt{8} = 8^{\frac{1}{3}}$

f $5^{\frac{1}{3}} = \sqrt{5}$

g $10^{\frac{1}{6}} = \sqrt{6}$

- 3 Use a calculator to evaluate these surds and round to four decimal places.

a $7^{\frac{1}{2}}$ (or $\sqrt{7}$)

b $13^{\frac{1}{2}}$ (or $\sqrt{13}$)

c $83^{\frac{1}{2}}$ (or $\sqrt{83}$)

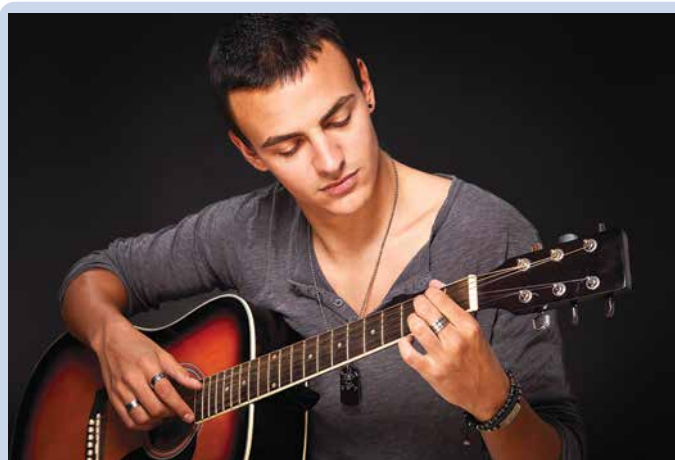

A classical guitar, of scale length L mm, has each fret x mm from the bridge, where $x = L \times 2^{-\frac{n}{12}}$ for the n th fret from the nut. The 12th fret is half the scale length, doubling the pitch to one octave higher.

**Example 22** Writing numbers using a root sign

Write these numbers using a root sign.

a $6^{\frac{1}{2}}$

b $2^{\frac{1}{5}}$

SOLUTION

a $6^{\frac{1}{2}} = \sqrt{6}$

b $2^{\frac{1}{5}} = \sqrt[5]{2}$

EXPLANATION $a^{\frac{1}{m}} = \sqrt[m]{a}$ so $6^{\frac{1}{2}} = \sqrt[2]{6}$ (or $\sqrt{6}$) the square root of 6. $\sqrt[5]{2}$ is called the 5th root of 2.**Now you try**

Write these numbers using a root sign.

a $7^{\frac{1}{2}}$

b $3^{\frac{1}{6}}$

**Example 23** Evaluating numbers with fractional indices

Evaluate:

a $144^{\frac{1}{2}}$

b $27^{\frac{1}{3}}$

SOLUTION

a $144^{\frac{1}{2}} = \sqrt{144}$
 $= 12$

b $27^{\frac{1}{3}} = \sqrt[3]{27}$
 $= 3$

EXPLANATION $a^{\frac{1}{m}} = \sqrt[m]{a}$ where $m = 2$ and the square root of 144 = 12 since $12^2 = 144$.The cube root of 27 is 3 since $3^3 = 3 \times 3 \times 3 = 27$.**Now you try**

Evaluate:

a $64^{\frac{1}{2}}$

b $216^{\frac{1}{3}}$



Example 24 Using index laws with fractional indices

Use index laws to simplify these expressions.

a $a^{\frac{1}{2}} \times a^{\frac{3}{2}}$

b $\frac{x^{\frac{1}{2}}}{x^{\frac{1}{3}}}$

c $(y^2)^{\frac{1}{4}}$

SOLUTION

$$\begin{aligned} \mathbf{a} \quad a^{\frac{1}{2}} \times a^{\frac{3}{2}} &= a^{\frac{1}{2} + \frac{3}{2}} \\ &= a^{\frac{4}{2}} \\ &= a^2 \end{aligned}$$

$$\begin{aligned} \mathbf{b} \quad \frac{x^{\frac{1}{2}}}{x^{\frac{1}{3}}} &= x^{\frac{1}{2} - \frac{1}{3}} \\ &= x^{\frac{1}{6}} \end{aligned}$$

$$\begin{aligned} \mathbf{c} \quad (y^2)^{\frac{1}{4}} &= y^{2 \times \frac{1}{4}} \\ &= y^{\frac{1}{2}} \end{aligned}$$

EXPLANATION

When multiplying indices with the same base add the powers.

When dividing indices with the same base, subtract the powers.

$$\frac{1}{2} - \frac{1}{3} = \frac{3}{6} - \frac{2}{6} = \frac{1}{6}$$

When raising a power to a power, multiply the indices:

$$2 \times \frac{1}{4} = \frac{2}{4} = \frac{1}{2}$$

Now you try

Use index laws to simplify these expressions.

a $x^{\frac{1}{2}} \times x^{\frac{5}{2}}$

b $\frac{a^{\frac{2}{3}}}{a^{\frac{1}{2}}}$

c $(b^{\frac{1}{3}})^6$

Exercise 6H

FLUENCY

1–4($\frac{1}{2}$)1–5($\frac{1}{2}$)1–5($\frac{1}{3}$)

Example 22

- 1 Write these numbers using a root sign.

a $3^{\frac{1}{2}}$

b $7^{\frac{1}{2}}$

c $5^{\frac{1}{3}}$

d $12^{\frac{1}{3}}$

e $31^{\frac{1}{5}}$

f $18^{\frac{1}{7}}$

g $9^{\frac{1}{9}}$

h $3^{\frac{1}{8}}$

- 2 Write these numbers in index form given that $\sqrt[n]{a} = a^{\frac{1}{n}}$.

a $\sqrt{8}$

b $\sqrt{19}$

c $\sqrt[3]{10}$

d $\sqrt[3]{31}$

e $\sqrt[4]{5}$

f $\sqrt[5]{9}$

g $\sqrt[8]{11}$

h $\sqrt[11]{20}$

Example 23 3 Without using a calculator, evaluate these numbers with fractional indices.

a $25^{\frac{1}{2}}$

b $49^{\frac{1}{2}}$

c $81^{\frac{1}{2}}$

d $169^{\frac{1}{2}}$

e $8^{\frac{1}{3}}$

f $64^{\frac{1}{3}}$

g $125^{\frac{1}{3}}$

h $1000^{\frac{1}{3}}$

i $16^{\frac{1}{4}}$

j $81^{\frac{1}{4}}$

k $625^{\frac{1}{4}}$

l $32^{\frac{1}{5}}$

Example 24 4 Use index laws to simplify these expressions. Leave your answer in index form.

a $a^{\frac{1}{2}} \times a^{\frac{1}{2}}$

b $a^{\frac{1}{3}} \times a^{\frac{1}{3}}$

c $a^{\frac{2}{3}} \times a^{\frac{4}{3}}$

d $a^2 \times a^{\frac{1}{2}}$

e $\frac{x^{\frac{2}{3}}}{x^{\frac{1}{3}}}$

f $\frac{x^{\frac{3}{2}}}{x^{\frac{1}{2}}}$

g $\frac{x^{\frac{7}{6}}}{x^{\frac{2}{6}}}$

h $\frac{x^{\frac{4}{3}}}{x^{\frac{1}{3}}}$

i $(y^2)^{\frac{1}{2}}$

j $(y^3)^{\frac{2}{3}}$

k $\left(y^{\frac{1}{2}}\right)^3$

l $\left(x^{\frac{1}{2}}\right)^{\frac{1}{2}}$

m $\left(x^{\frac{2}{3}}\right)^4$

n $\left(a^{\frac{2}{5}}\right)^{\frac{1}{3}}$

o $\left(a^{\frac{3}{4}}\right)^{\frac{1}{2}}$

p $\left(n^{\frac{2}{5}}\right)^{\frac{10}{3}}$

5 Use index laws to simplify these expressions.

a $a \times a^{\frac{1}{3}}$

b $a^{\frac{1}{2}} \times a^{\frac{1}{5}}$

c $a^{\frac{2}{3}} \times a^{\frac{3}{7}}$

d $a^5 \div a^{\frac{7}{3}}$

e $b^{\frac{2}{3}} \div b^{\frac{1}{2}}$

f $x^{\frac{4}{5}} \div x^{\frac{2}{3}}$

PROBLEM-SOLVING

6-7($\frac{1}{2}$)6-8($\frac{1}{2}$)6-8($\frac{1}{2}$)

6 Evaluate the following without a calculator. (*Hint*: First rewrite each question using positive indices using $a^{-m} = \frac{1}{a^m}$.)

a $4^{-\frac{1}{2}}$

b $8^{-\frac{1}{3}}$

c $32^{-\frac{1}{5}}$

d $81^{-\frac{1}{4}}$

e $25^{-\frac{1}{2}}$

f $27^{-\frac{1}{3}}$

g $1000^{-\frac{1}{3}}$

h $256^{-\frac{1}{4}}$

7 Find the length of the hypotenuse (c) in these right-angled triangles. Use Pythagoras' theorem ($c^2 = a^2 + b^2$) and write your answers as surds.

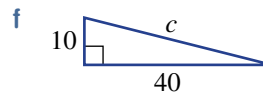
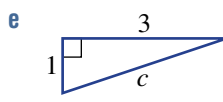
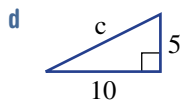
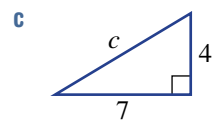
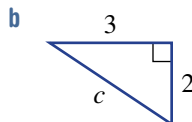
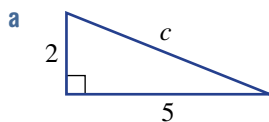

8 Note that $8^{\frac{2}{3}} = \left(8^{\frac{1}{3}}\right)^2$ using the index law for power of a power
 $= \left(\sqrt[3]{8}\right)^2$ since $8^{\frac{1}{3}} = \sqrt[3]{8}$
 $= 2^2$ $\sqrt[3]{8} = 2$ since $2^3 = 8$
 $= 4$

Use the approach shown in the example above to evaluate these numbers.

a $27^{\frac{2}{3}}$

b $64^{\frac{2}{3}}$

c $9^{\frac{3}{2}}$

d $25^{\frac{3}{2}}$

e $16^{\frac{5}{4}}$

f $4^{\frac{5}{2}}$

g $81^{\frac{3}{2}}$

h $125^{\frac{5}{3}}$

REASONING

9

9, 10

10, 11

9 Show working to prove that the answers to all these questions simplify to 1. Remember $a^0 = 1$.

a $a^{\frac{1}{2}} \times a^{-\frac{1}{2}}$

b $a^{\frac{2}{3}} \times a^{-\frac{2}{3}}$

c $a^{\frac{4}{7}} \times a^{-\frac{4}{7}}$

d $a^{\frac{5}{6}} \div a^{\frac{5}{6}}$

e $\left(a^{\frac{1}{2}}\right)^{\frac{1}{2}} \div a^{\frac{1}{4}}$

f $a^2 \div (a^3)^{\frac{2}{3}}$

10 A student tries to evaluate $9^{\frac{1}{2}}$ on a calculator and types $9^{1/2}$ and gets 4.5. You know that $9^{\frac{1}{2}} = \sqrt{9} = 3$. What has the student done wrong? (Note: ^ on some calculators is x^y .)

11 a Evaluate the following.

i $\sqrt{3^2}$

ii $\sqrt{5^2}$

iii $\sqrt{10^2}$

b Simplify $\sqrt{a^2}$ for $a \geq 0$.

c Use fractional indices to show that $\sqrt{a^2} = a$ if $a \geq 0$.

d Evaluate the following.

i $(\sqrt{4})^2$

ii $(\sqrt{9})^2$

iii $(\sqrt{36})^2$

e Simplify $(\sqrt{a})^2$.

f Use fractional indices to show that $(\sqrt{a})^2 = a$. Assume $a \geq 0$.

g Simplify:

i $\sqrt[3]{a^3}$

ii $\sqrt[5]{a^5}$

iii $(\sqrt[3]{a})^3$

iv $(\sqrt[6]{a})^6$

ENRICHMENT: Fractions raised to fractions

-

-

12($\frac{1}{2}$), 13

12 Note, for example, that $\left(\frac{4}{9}\right)^{\frac{1}{2}} = \sqrt{\frac{4}{9}} = \frac{2}{3}$ since $\frac{2}{3} \times \frac{2}{3} = \frac{4}{9}$. Now evaluate the following.

a $\left(\frac{16}{25}\right)^{\frac{1}{2}}$

b $\left(\frac{9}{49}\right)^{\frac{1}{2}}$

c $\left(\frac{4}{81}\right)^{\frac{1}{2}}$

d $\left(\frac{8}{27}\right)^{\frac{1}{3}}$

e $\left(\frac{64}{125}\right)^{\frac{1}{3}}$

f $\left(\frac{16}{81}\right)^{\frac{1}{4}}$

g $\left(\frac{256}{625}\right)^{\frac{1}{4}}$

h $\left(\frac{1000}{343}\right)^{\frac{1}{3}}$

13 Note that $\left(\frac{4}{9}\right)^{-\frac{1}{2}} = \frac{1}{\left(\frac{4}{9}\right)^{\frac{1}{2}}} = \frac{1}{\sqrt{\frac{4}{9}}} = \frac{1}{\frac{2}{3}} = \frac{3}{2}$. Now evaluate the following.

a $\left(\frac{9}{4}\right)^{-\frac{1}{2}}$

b $\left(\frac{49}{144}\right)^{-\frac{1}{2}}$

c $\left(\frac{8}{125}\right)^{-\frac{1}{3}}$

d $\left(\frac{1296}{625}\right)^{-\frac{1}{4}}$

6I Simple operations with surds EXTENDING

LEARNING INTENTIONS

- To understand that only like surds can be added and subtracted
- To know and be able to apply the rules for adding, subtracting, multiplying and dividing simple surds

Since surds, such as $\sqrt{2}$ and $\sqrt{7}$, are numbers, they can be added, subtracted, multiplied or divided. Expressions with surds can also be simplified, but this depends on the surds themselves and the types of operations that sit between them.

$\sqrt{2} + \sqrt{3}$ cannot be simplified since $\sqrt{2}$ and $\sqrt{3}$ are not 'like' surds. This is like trying to simplify $x + y$. However, $\sqrt{2} + 5\sqrt{2}$ simplifies to $6\sqrt{2}$; this is like simplifying $x + 5x = 6x$. Subtraction of surds is treated in the same manner.

Products and quotients involving surds can also be simplified as in these examples:

$$\sqrt{11} \times \sqrt{2} = \sqrt{22} \quad \text{and} \quad \sqrt{30} \div \sqrt{3} = \sqrt{10}$$

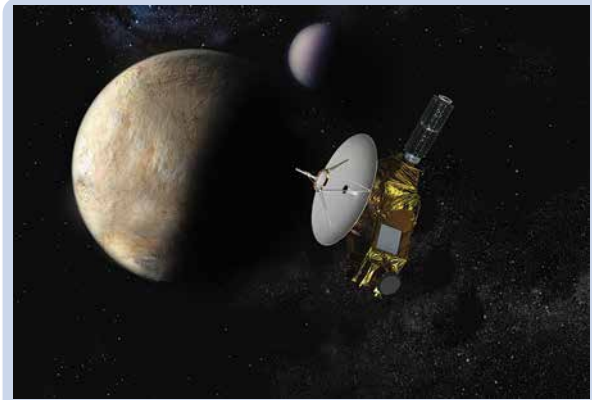

Engineers, architects, surveyors, navigators, physicists, geologists, astronomers and space scientists use surds, as they are exact values. For example, the formula for a spacecraft's escape velocity (from gravity) includes the number $\sqrt{2}$

$$v = \frac{\sqrt{2}\sqrt{GM}}{\sqrt{R}}$$

Lesson starter: Rules for multiplication and division

Use a calculator to find a decimal approximation for each of the expressions in these pairs.

- $\sqrt{2} \times \sqrt{3}$ and $\sqrt{6}$
- $\sqrt{10} \times \sqrt{5}$ and $\sqrt{50}$

What does this suggest about the simplification of $\sqrt{a} \times \sqrt{b}$?

Repeat the above exploration for the following:

- $\sqrt{6} \div \sqrt{2}$ and $\sqrt{\frac{6}{2}}$
- $\sqrt{80} \div \sqrt{8}$ and $\sqrt{\frac{80}{8}}$

What does this suggest about the simplification of $\sqrt{a} \div \sqrt{b}$?

KEY IDEAS

- **Surds** can be simplified using addition or subtraction if they are ‘like’ surds (have the same numeral under the root sign).

- $2\sqrt{3} + 3\sqrt{3} = 5\sqrt{3}$
- $11\sqrt{7} - 2\sqrt{7} = 9\sqrt{7}$
- $\sqrt{3} + \sqrt{5}$ cannot be simplified.

- $(\sqrt{a})^2 = a$

For example: $(\sqrt{5})^2 = 5$

- $\sqrt{a} \times \sqrt{b} = \sqrt{ab}$

For example: $\sqrt{5} \times \sqrt{3} = \sqrt{5 \times 3} = \sqrt{15}$

- $\sqrt{a} \div \sqrt{b} = \sqrt{\frac{a}{b}}$

For example: $\sqrt{10} \div \sqrt{5} = \sqrt{\frac{10}{5}} = \sqrt{2}$

BUILDING UNDERSTANDING

- 1 Decide if the following pairs of numbers contain ‘like’ surds.

a $3\sqrt{2}, 4\sqrt{2}$

b $5\sqrt{3}, 2\sqrt{3}$

c $4\sqrt{2}, 5\sqrt{7}$

d $\sqrt{3}, 2\sqrt{5}$

e $6\sqrt{6}, 3\sqrt{3}$

f $\sqrt{8}, 3\sqrt{8}$

g $19\sqrt{2}, -\sqrt{2}$

h $-3\sqrt{6}, 3\sqrt{5}$

- 2 a Use a calculator to find a decimal approximation for both $\sqrt{5} \times \sqrt{2}$ and $\sqrt{10}$. What do you notice?

- b Use a calculator to find a decimal approximation for both $\sqrt{15} \div \sqrt{5}$ and $\sqrt{3}$. What do you notice?



Example 25 Adding and subtracting surds

Simplify:

a $2\sqrt{5} + 6\sqrt{5}$

b $\sqrt{3} - 5\sqrt{3}$

SOLUTION

a $2\sqrt{5} + 6\sqrt{5} = 8\sqrt{5}$

b $\sqrt{3} - 5\sqrt{3} = -4\sqrt{3}$

EXPLANATION

This is like simplifying $2x + 6x = 8x$. $2\sqrt{5}$ and $6\sqrt{5}$ contain like surds.

This is similar to $x - 5x = -4x$ in algebra.

Now you try

Simplify:

a $6\sqrt{3} + 2\sqrt{3}$

b $2\sqrt{7} - 5\sqrt{7}$



Example 26 Multiplying and dividing surds

Simplify:

a $\sqrt{3} \times \sqrt{10}$

b $\sqrt{24} \div \sqrt{8}$

SOLUTION

$$\begin{aligned} \text{a } \sqrt{3} \times \sqrt{10} &= \sqrt{3 \times 10} \\ &= \sqrt{30} \end{aligned}$$

$$\begin{aligned} \text{b } \sqrt{24} \div \sqrt{8} &= \sqrt{\frac{24}{8}} \\ &= \sqrt{3} \end{aligned}$$

EXPLANATION

Use $\sqrt{a} \times \sqrt{b} = \sqrt{ab}$

Use $\sqrt{a} \div \sqrt{b} = \sqrt{\frac{a}{b}}$

Now you try

Simplify:

a $\sqrt{5} \times \sqrt{3}$

b $\sqrt{60} \div \sqrt{10}$

Exercise 6I

FLUENCY

1-2(1/2)

1-2(1/2)

1-2(1/3)

Example 25

1 Simplify by collecting like surds.

a $3\sqrt{7} + 5\sqrt{7}$

b $2\sqrt{11} + 6\sqrt{11}$

c $\sqrt{5} + 8\sqrt{5}$

d $3\sqrt{6} + \sqrt{6}$

e $3\sqrt{3} + 2\sqrt{5} + 4\sqrt{3}$

f $5\sqrt{7} + 3\sqrt{5} + 4\sqrt{7}$

g $3\sqrt{5} - 8\sqrt{5}$

h $6\sqrt{7} - 10\sqrt{7}$

i $3\sqrt{7} - 2\sqrt{7} + 4\sqrt{7}$

j $5\sqrt{14} + \sqrt{14} - 7\sqrt{14}$

k $3\sqrt{2} - \sqrt{5} + 4\sqrt{2}$

l $6\sqrt{3} + 2\sqrt{7} - 3\sqrt{3}$

Example 26

2 Simplify:

a $\sqrt{5} \times \sqrt{6}$

b $\sqrt{3} \times \sqrt{7}$

c $\sqrt{10} \times \sqrt{7}$

d $\sqrt{8} \times \sqrt{2}$

e $\sqrt{12} \times \sqrt{3}$

f $\sqrt{2} \times \sqrt{11}$

g $\sqrt{3} \times \sqrt{3}$

h $\sqrt{12} \times \sqrt{12}$

i $\sqrt{36} \div \sqrt{12}$

j $\sqrt{20} \div \sqrt{2}$

k $\sqrt{42} \div \sqrt{6}$

l $\sqrt{60} \div \sqrt{20}$

m $\sqrt{45} \div \sqrt{5}$

n $\sqrt{32} \div \sqrt{2}$

o $\sqrt{49} \div \sqrt{7}$

PROBLEM-SOLVING

3-4(1/2)

3-4(1/2)

3-5(1/3)

3 Simplify:

a $2 - \sqrt{3} + 6 - 2\sqrt{3}$

b $\sqrt{2} - \sqrt{3} + 5\sqrt{2}$

c $7\sqrt{5} - \sqrt{2} + 1 + \sqrt{2}$

d $\frac{\sqrt{2}}{3} + \frac{\sqrt{2}}{2}$

e $\frac{\sqrt{7}}{2} + \frac{\sqrt{7}}{5}$

f $\frac{2\sqrt{6}}{7} - \frac{\sqrt{6}}{2}$

g $\sqrt{10} - \frac{\sqrt{10}}{3}$

h $5 - \frac{2\sqrt{3}}{3} + \sqrt{3}$

i $\frac{2\sqrt{8}}{7} - \frac{5\sqrt{8}}{8}$

- 4 Note, for example, that $2\sqrt{3} \times 5\sqrt{2} = 2 \times 5 \times \sqrt{3} \times \sqrt{2}$
 $= 10\sqrt{6}$

Now simplify the following.

- | | |
|--------------------------------|--------------------------------|
| a $5\sqrt{2} \times 3\sqrt{3}$ | b $3\sqrt{7} \times 2\sqrt{3}$ |
| c $4\sqrt{5} \times 2\sqrt{6}$ | d $2\sqrt{6} \times 5\sqrt{3}$ |
| e $10\sqrt{6} \div 5\sqrt{2}$ | f $18\sqrt{12} \div 6\sqrt{2}$ |
| g $20\sqrt{28} \div 5\sqrt{2}$ | h $6\sqrt{14} \div 12\sqrt{7}$ |

- 5 Expand and simplify. Recall that $a(b + c) = a \times b + a \times c$.

- | | |
|--------------------------------------|---------------------------------------|
| a $2\sqrt{3}(3\sqrt{5} + 1)$ | b $\sqrt{5}(\sqrt{2} + \sqrt{3})$ |
| c $5\sqrt{6}(\sqrt{2} + 3\sqrt{5})$ | d $7\sqrt{10}(2\sqrt{3} - \sqrt{10})$ |
| e $\sqrt{13}(\sqrt{13} - 2\sqrt{3})$ | f $\sqrt{5}(\sqrt{7} - 2\sqrt{5})$ |

REASONING

6($\frac{1}{2}$)6($\frac{1}{2}$)6-7($\frac{1}{2}$)

- 6 Using $\sqrt{ab} = \sqrt{a} \times \sqrt{b}$, the surd $\sqrt{18}$ can be simplified as shown.

$$\begin{aligned}\sqrt{18} &= \sqrt{9 \times 2} \\ &= \sqrt{9} \times \sqrt{2} \\ &= 3\sqrt{2}\end{aligned}$$

This simplification is possible because 18 has a factor that is a square number (9). Use this technique to simplify these surds.

- | | | | |
|---------------|----------------|---------------|---------------|
| a $\sqrt{8}$ | b $\sqrt{12}$ | c $\sqrt{27}$ | d $\sqrt{45}$ |
| e $\sqrt{75}$ | f $\sqrt{200}$ | g $\sqrt{60}$ | h $\sqrt{72}$ |

- 7 Building on the idea discussed in Question 6, expressions such as $\sqrt{8} - \sqrt{2}$ can be simplified as shown:

$$\begin{aligned}\sqrt{8} - \sqrt{2} &= \sqrt{4 \times 2} - \sqrt{2} \\ &= 2\sqrt{2} - \sqrt{2} \\ &= \sqrt{2}\end{aligned}$$

Now simplify these expressions.

- | | | | |
|---------------------------|---------------------------|----------------------------|----------------------------|
| a $\sqrt{8} + 3\sqrt{2}$ | b $3\sqrt{2} - \sqrt{8}$ | c $\sqrt{18} + \sqrt{2}$ | d $5\sqrt{3} - 2\sqrt{12}$ |
| e $4\sqrt{8} - 2\sqrt{2}$ | f $\sqrt{27} + 2\sqrt{3}$ | g $3\sqrt{45} - 7\sqrt{5}$ | h $6\sqrt{12} - 8\sqrt{3}$ |

ENRICHMENT: Binomial products

-

-

8($\frac{1}{2}$)

- 8 Simplify the following by using the rule $(a + b)(c + d) = ac + ad + bc + bd$.

Note, $(a + b)^2 = (a + b)(a + b)$.

- | | |
|--|--|
| a $(\sqrt{2} + \sqrt{3})(\sqrt{2} + \sqrt{5})$ | b $(\sqrt{3} - \sqrt{5})(\sqrt{3} + \sqrt{2})$ |
| c $(2\sqrt{5} - 1)(3\sqrt{2} + 4)$ | d $(1 - 3\sqrt{7})(2 + 3\sqrt{2})$ |
| e $(2 - \sqrt{3})(2 + \sqrt{3})$ | f $(\sqrt{5} - 1)(\sqrt{5} + 1)$ |
| g $(3\sqrt{2} + \sqrt{3})(3\sqrt{2} - \sqrt{3})$ | h $(8\sqrt{2} + \sqrt{5})(8\sqrt{2} - \sqrt{5})$ |
| i $(1 + \sqrt{2})^2$ | j $(\sqrt{6} - 3)^2$ |
| k $(2\sqrt{3} - 1)^2$ | l $(\sqrt{2} + 2\sqrt{5})^2$ |

Rabbits and hares

The population of rabbits and hares in a particular part of the countryside are booming because fox numbers are low. The population

Month	Jan	Feb	Mar	Apr	May	Jun
Rabbit population	500	1000	2000	4000	8000	16 000
Hare population	1	3	9	27	81	343

numbers in the table on the right were recorded at the beginning of January through to June.

Present a report for the following tasks and ensure that you show clear mathematical workings and explanations where appropriate.

Preliminary task

- A population of a different colony of hares is modelled by the rule $P = 4^t$ where P is the population and t is in months. Find:
 - the population after 6 months
 - the number of whole months for the population to reach at least 1000.
- A population of a different colony of rabbits is modelled by the rule $P = 200 \times 2^t$ where P is the population and t is in months. Find:
 - the population after 6 months
 - the number of whole months for the population to reach at least 2000.

Modelling task

Formulate

- The problem is to determine the number of months required for the hare population to overtake the rabbit population. Write down all the relevant information that will help solve this problem.
- Copy and extend the given table showing the population of rabbits and hares in the first 12 months by continuing the pattern.

Month	Jan	Feb	Mar	Apr	May	Jun	Jul	Aug	Sep	Oct	Nov	Dec
Rabbit population	500	1000	2000	4000	8000	16 000						
Hare population	1	3	9	27	81	343						

Solve

- The rule for the population of rabbits is of the form $P = 500 \times (?)^t$. State the missing number.
- The rule for the population of hares is of the form $P = (?)^t$. State the missing number.
- Use the rules outlined in parts **c** and **d** to confirm the population of:
 - rabbits initially (at $t = 0$)
 - rabbits after 12 months
 - hares after 12 months.
- Use the rules outlined in parts **c** and **d** to estimate the population of:
 - rabbits after 2 years
 - hares after 3 years.
- Use your rules with a trial and error approach to determine the month in which the hare population overtakes the rabbit population.

Evaluate and verify

- Illustrate the increase in the population of rabbits and hares over two years by plotting a graph of the population of rabbits and hares. Use $0 \leq t \leq 12$ on the horizontal axis.
- If the rule for the population of hares is instead modelled by $P = 100 \times 2^t$, would there be a time when the hare population would overtake that of the rabbit population? Justify your response.

Communicate

- Summarise your results and describe any key findings.

Extension question

- Assume that the initial population of rabbits could vary where the population of rabbits is modelled by the rule $P = k \times 2^t$. Determine possible whole number values of k for which the population of hares overtakes that of rabbits after:
 - 12 months
 - 6 months
 - 5 years.

Constructing surds

Key technology: Dynamic geometry

We know that a surd is an irrational number meaning that it cannot be expressed exactly as a fraction. So to place a surd on a number line for example may be more challenging than placing a number like $\frac{3}{2}$, which is exactly half way between 1 and 2. However, the precise positions of surds on a number line can be located using geometric construction.



1 Getting started

We will start by considering the length of the diagonal of a square of side length one unit.

- Use Pythagoras' theorem to find the length of the diagonal of the given unit square. Give your answer as a surd and also as a decimal rounded to four decimal places using a calculator.

Now consider a rectangle with side lengths 1 and 2.

- Draw a diagram of the rectangle showing one of the diagonals.
- Use Pythagoras' theorem to find the surd which corresponds to the length of the diagonal of your rectangle.

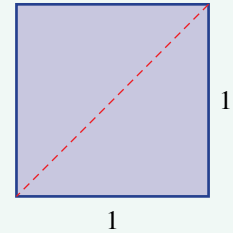

2 Using technology

Open a dynamic geometry program like Desmos and complete the following to place the surd $\sqrt{2}$ on a number line.

- Show a grid using the tools menu, then place a line horizontally through two points O and A.
- Add the line segment OB which is the diagonal of a unit square.
- Construct a circle with centre O and passing through B.
- Construct the line segment OC.
- Label the segment OC with its length. You have just placed $\sqrt{2}$ on a number line at point C.

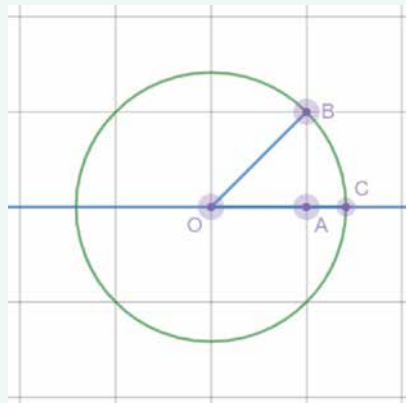

3 Applying an algorithm

In part 1b you drew a diagonal of a rectangle with length $\sqrt{5}$.

- Use dynamic geometry to place $\sqrt{5}$ on a number line. Your construction will be similar to that of part 2 but instead use two unit squares forming a rectangle of side lengths 1 and 2.
- Write down an algorithm (series of instructions) similar to those in part 2 which places the surd $\sqrt{5}$ on a number line.
- Note that when using dynamic geometry you can simply drag point B to a new position to construct a different surd. Try doing this as shown in this diagram.
- What size rectangle would you use to construct the surd $\sqrt{10}$?
- Use dynamic geometry to construct the following surds.
 - $\sqrt{10}$
 - $\sqrt{8}$
 - $\sqrt{29}$
 - $\sqrt{34}$

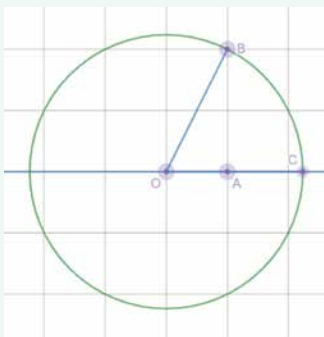

4 Extension

- All of the above constructed surds have been generated from a rectangle using integer side lengths. Is it possible to find integer values of a and b so that $\sqrt{a^2 + b^2} = \sqrt{6}$?
One way to construct $\sqrt{6}$ is to write it as $\sqrt{2^2 + (\sqrt{2})^2}$. This means that we can use the construction of $\sqrt{2}$ to form a rectangle with side lengths 2 and $\sqrt{2}$, which has a diagonal of length $\sqrt{6}$. The construction shown here uses the following.
 - $\sqrt{2}$ as OC
 - CB' with length 2
 - OB' with length $\sqrt{2^2 + (\sqrt{2})^2} = \sqrt{6}$
 - C' as $\sqrt{6}$ on the number line
- Construct $\sqrt{6}$ as above and label OC' with its length.
- Construct the following surds.
 - $\sqrt{7}$
 - $\sqrt{11}$
 - $\sqrt{19}$

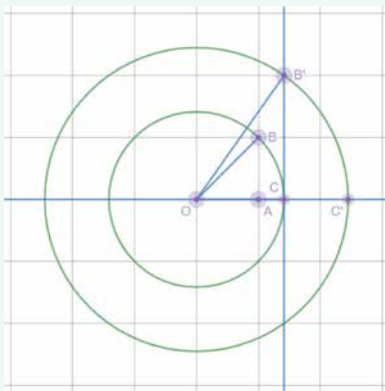

Cell growth

Many cellular organisms reproduce by a process of subdivision called mitosis. A single cell, for example, may divide into two every hour as shown below. After 2 hours the single starting cell has become four:

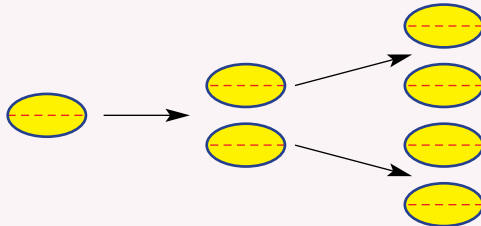

Dividing into two

A single cell divides into two every hour.

- a** How many cells will there be after the following number of hours? Explain how you obtained your answers.

i 1

ii 2

iii 5

- b** Complete the table showing the number of cells after n hours.

n hours	0	1	2	3	4	5	6
Number of cells, N	1	2	4				
N in index form	2^0	2^1	2^2				

- c** Write a rule for the number of cells N after n hours.

- d** Use your rule from part **c** to find the number of cells after:

i 8 hours

ii 12 hours

iii 2 days.

- e** Find how long it takes for a single cell to divide into a total of:

i 128 cells

ii 1024 cells

iii 65 536 cells.

Dividing into three or more

- a** Complete a table similar to the table in the previous section for a cell that divides into 3 every hour.

- b** Write a rule for N in terms of n if a cell divides into 3 every hour, and then use the rule to find the number of cells after:

i 2 hours

ii 4 hours

iii 8 hours.

- c** Write a rule for N in terms of n if a single cell divides into the following number of cells every hour.

i 4

ii 5

iii 10

Cell cycle times

- a** If a single cell divides into two every 20 minutes, investigate how many cells there will be after 4 hours.
- b** If a single cell divides into three every 10 minutes, investigate how many cells there will be after 2 hours.
- c** Use the internet to research the cell cycle time and the types of division for at least two different types of cells. Describe the cells and explain the reproductive process.

1 Determine the last digit of each of the following without using a calculator.

- a 2^{222}
 b 3^{300}
 c 6^{87}

2 Determine the smallest value of n such that:

- a $24n$ is a square number
 b $750n$ is a square number.

3 Simplify $\left(\frac{32}{243}\right)^{-\frac{2}{5}}$ without using a calculator.

4 If $2^x = t$, express the following in terms of t .

- a 2^{2x+1} b 2^{1-x}

5 A single cell divides in two every 5 minutes and each new cell continues to divide every 5 minutes. How long does it take for the cell population to reach at least 1 million?

6 Find the value of x if $3^{3x-1} = \frac{1}{27}$.

7 a Write the following in index form.

- i $\sqrt{2\sqrt{2}}$ ii $\sqrt{2\sqrt{2\sqrt{2}}}$ iii $\sqrt{2\sqrt{2\sqrt{2\sqrt{2}}}}$

b What value do your answers to part a appear to be approaching?

8 Determine the highest power of 2 that divides exactly into 2 000 000.

9 Simplify these surds.

- a $5\sqrt{8} - \sqrt{18}$
 b $\frac{1}{\sqrt{2}} + \sqrt{2}$
 c $(\sqrt{2} + 3\sqrt{5})^2 - (\sqrt{2} - 3\sqrt{5})^2$

10 Prove that:

- a $\frac{1}{\sqrt{2}} = \frac{\sqrt{2}}{2}$
 b $\frac{3}{\sqrt{3}} = \sqrt{3}$
 c $\frac{1}{\sqrt{2}-1} = \sqrt{2} + 1$

11 Solve for x . There are two solutions for each. (*Hint:* Let $a = 2^x$ in part a.)

- a $2^{2x} - 3 \times 2^x + 2 = 0$
 b $3^{2x} - 12 \times 3^x + 27 = 0$

12 Given that $2^4 \times 3^2 \times 5 = 720$, find the smallest whole number x so that $720x$ is a perfect cube.

13 Given that $4^y \times 9^x \times 27 = 4 \times 2^x \times 3^{2y}$, find the values of x and y .

Up for a challenge? If you get stuck on a question, check out the 'Working with unfamiliar problems' poster at the end of the book to help you.



Zero index

$$a^0 = 1$$

Any expression (except 0) to the power 0 equals 1.

$$\text{e.g. } 3x^0 = 3 \times 1 = 3$$

$$\text{while } (3x)^0 = 1$$

Surds (Ext)

A surd is a number written with a root sign which has a decimal representation that is infinite and non-recurring with no pattern. e.g. $\sqrt{2} = 1.41421356\dots$

Chapter checklist with success criteria

A printable version of this checklist is available in the Interactive Textbook



6A	1. I can write a power in expanded form. e.g. Write $(ab)^3$ in expanded form.	<input type="checkbox"/>
6A	2. I can evaluate a power. e.g. Write $(-4)^3$ in expanded form and then evaluate.	<input type="checkbox"/>
6A	3. I can write an expression in index form. e.g. Write $6 \times x \times x \times y \times x \times y$ in index form.	<input type="checkbox"/>
6A	4. I can express a number in prime factor form. e.g. Express 108 as a product of prime factors in index form.	<input type="checkbox"/>
6B	5. I can use the index laws for multiplication and division with numerical bases. e.g. Simplify $5^4 \times 5^3$ and $3^7 \div 3^4$, answering in index form.	<input type="checkbox"/>
6B	6. I can use the index law for multiplication. e.g. Simplify $3a^2b \times 4a^4b^3$.	<input type="checkbox"/>
6B	7. I can use the index law for division. e.g. Simplify $\frac{18x^6y^4}{12xy^3}$.	<input type="checkbox"/>
6B	8. I can combine the index laws for multiplication and division. e.g. Simplify $\frac{2a^5b^4 \times 6ab^2}{3a^4b^5}$.	<input type="checkbox"/>
6C	9. I can use the index law for power of a power. e.g. Simplify $(m^6)^5$.	<input type="checkbox"/>
6C	10. I can use the zero index. e.g. Evaluate 7^0 and $4x^0 - (5x)^0$.	<input type="checkbox"/>
6D	11. I can use the index law for brackets. e.g. Expand $4(m^3n)^5$ using the index law for brackets.	<input type="checkbox"/>
6D	12. I can use the index law for fractions. e.g. Apply the index law for fractions to $\left(\frac{-3}{b^5}\right)^4$.	<input type="checkbox"/>
6D	13. I can combine index laws. e.g. Use index laws to simplify $\left(\frac{2}{a^0b^3}\right)^2 \times \frac{a^4(b^4)^3}{6ab^2}$.	<input type="checkbox"/>
6E	14. I can write expressions using only positive indices. e.g. Express $2m^3n^{-2}$ and $\frac{5}{2x^{-3}}$ with positive indices only.	<input type="checkbox"/>
6E	15. I can evaluate negative powers without a calculator. e.g. Express with positive powers and then evaluate 4^{-3} and $\frac{4}{3^{-2}}$.	<input type="checkbox"/>
6F	16. I can write numbers in scientific notation. e.g. Write 123 000 and 0.00023 using scientific notation.	<input type="checkbox"/>

Chapter checklist with success criteria

			✓
6F	17. I can convert from scientific notation to decimal form. e.g. Express 4.2×10^5 and 3.5×10^{-3} in decimal form.		<input type="checkbox"/>
6G	18. I can state the number of significant figures. e.g. State the number of significant figures in 1027 and 0.024.		<input type="checkbox"/>
6G	19. I can write numbers in scientific notation using significant figures. e.g. Write 1 738 212 in scientific notation using three significant figures.		<input type="checkbox"/>
6G	20. I can use a calculator with scientific notation. e.g. Evaluate $7.2 \times 10^{-6} \times \sqrt{5.2 \times 10^3}$ using a calculator. Answer in scientific notation correct to three significant figures.		<input type="checkbox"/>
6H	21. I can express fractional indices using a root sign. e.g. Write $10^{\frac{1}{3}}$ using a root sign.	Ext	<input type="checkbox"/>
6H	22. I can evaluate numbers with fractional indices. e.g. Evaluate $81^{\frac{1}{2}}$.	Ext	<input type="checkbox"/>
6H	23. I can use index laws with fractional indices. e.g. Simplify $\left(x^{\frac{1}{2}}\right)^3 \times x^{\frac{5}{2}}$.	Ext	<input type="checkbox"/>
6I	24. I can add and subtract like surds. e.g. Simplify $4\sqrt{5} + 3\sqrt{5} - \sqrt{5}$.	Ext	<input type="checkbox"/>
6I	25. I can multiply and divide simple surds. e.g. Simplify $\sqrt{5} \times \sqrt{6}$ and $\sqrt{14} \div \sqrt{7}$.	Ext	<input type="checkbox"/>

Short-answer questions

6A

1 Express each of the following in index form.

a $3 \times 3 \times 3 \times 3$

c $3 \times a \times a \times a \times a \times \frac{b}{a} \times b$

b $2 \times x \times x \times x \times x \times y \times y$

d $\frac{3}{5} \times \frac{3}{5} \times \frac{3}{5} \times \frac{1}{7} \times \frac{1}{7}$

6A

2 Write the following as a product of prime factors in index form.

a 45

b 300

6B

3 Simplify using the index laws for multiplication and division.

a $x^3 \times x^7$

b $2a^3b \times 6a^2b^5c$

c $3m^2n \times 8m^5n^3 \times \frac{1}{2}m^3$

d $a^{12} \div a^3$

e $x^5y^3 \div (x^2y)$

f $\frac{5a^6b^3}{10a^8b}$

6C/D

4 Simplify:

a $(m^2)^3$

b $(3a^4)^2$

c $(-2a^2b)^5$

d $3a^0b$

e $2(3m)^0$

f $\left(\frac{a^2}{3}\right)^3$

6E

5 Express each of the following with positive indices.

a x^{-3}

b $4t^{-3}$

c $(3t)^{-2}$

d $\frac{2}{3}x^2y^{-3}$

e $5\left(\frac{x^2}{y^{-1}}\right)^{-3}$

f $\frac{5}{m^{-3}}$

6E

6 Fully simplify each of the following.

a $\frac{5x^8y^{-12}}{x^{10}} \times \frac{(x^2y^5)^2}{10}$

b $\left(\frac{(3x)^0}{3x^0y^2}\right)^4 \times \frac{9y^{10}}{x^{-3}}$

c $\frac{(4m^2n^3)^2}{2m^5n^4} \div \frac{mn^5}{(m^3n^2)^3}$

6F

7 Arrange the following numbers in ascending order.

2.35, 0.007×10^2 , 0.0012, 3.22×10^{-1} , 0.4, 35.4×10^{-3}

6F

8 Write the following numbers expressed using scientific notation in decimal form.

a 3.24×10^2

b 1.725×10^5

c 2.753×10^{-1}

d 1.49×10^{-3}

6G

9 Write each of the following values using scientific notation with three significant figures.

a The population of the world for 2020 was projected to reach 7 758 156 792.

b The area of the USA is 9 629 091 km².

c The time taken for light to travel 1 metre (in a vacuum) is 0.00000000333564 seconds.

d The wavelength of ultraviolet light from a fluorescent lamp is 0.000000294 m.



6F

- 10 Write each of the following values using scientific notation in the units given in brackets.
- 25 years (hours). Assume 1 year = 365 days.
 - 12 milliseconds (seconds)
 - 432 nanograms (grams)
 - 12.4 gigabytes (bytes)

6G



- 11 Use a calculator to evaluate the following, giving your answer using scientific notation correct to two significant figures.
- $m_s \times m_e$ where m_s (mass of Sun) = 1.989×10^{30} kg and m_e (mass of Earth) = 5.98×10^{24} kg
 - The speed, v , in m/s of an object of mass $m = 2 \times 10^{-3}$ kg and kinetic energy $E = 1.88 \times 10^{-12}$ joules, where $v = \sqrt{\frac{2E}{m}}$

6H

Ext

- 12 Evaluate without using a calculator.

a $\sqrt[4]{16}$	b $\sqrt[3]{125}$
c $49^{\frac{1}{2}}$	d $81^{\frac{1}{4}}$
e $27^{-\frac{1}{3}}$	f $121^{-\frac{1}{2}}$

6H

Ext

- 13 Simplify the following expressing all answers in positive index form.

a $(s^6)^{\frac{1}{3}}$	b $3x^{\frac{1}{2}} \times 5x^2$
c $\left(3m^{\frac{1}{2}}n^2\right)^2 \times m^{-\frac{1}{4}}$	d $\frac{4}{\frac{1}{3}} \times \frac{\left(a^{\frac{1}{2}}\right)^4}{a}$

6I

Ext

- 14 Simplify the following operations with surds.

a $8\sqrt{7} - \sqrt{7} + 2$	b $2\sqrt{3} + 5\sqrt{2} - \sqrt{3} + 4\sqrt{2}$	c $\sqrt{8} \times \sqrt{8}$
d $\sqrt{5} \times \sqrt{3}$	e $\sqrt{7} \times \sqrt{2}$	f $\sqrt{2} \times \sqrt{11} \times \sqrt{2}$
g $\sqrt{42} \div \sqrt{7}$	h $\sqrt{75} \div \sqrt{3}$	i $2\sqrt{50} \div \sqrt{10}$

Multiple-choice questions

6B

- 1 $3x^7 \times 4x^4$ is equivalent to:

A $12x^7$ B $12x^{28}$ C $7x^{11}$ D $12x^{11}$ E $7x^3$

6C

- 2 $3(2y^2)^0$ simplifies to:

A 6 B 3 C $6y^2$ D 3y E 12

6D

- 3 $(2x^2)^3$ expands to:

A $2x^5$ B $2x^6$ C $6x^6$ D $8x^5$ E $8x^6$

6B

- 4 $2x^3y \times \frac{x^5y^2}{4x^2y}$ simplifies to:

A $\frac{x^6y^2}{2}$ B $2x^8y$ C $2x^6y^2$ D $\frac{x^4y^2}{2}$ E $8x^6y$

6D

5 $\left(\frac{-x^2y}{3z^4}\right)^3$ is equal to:

A $\frac{x^6y^3}{3z^{12}}$

B $\frac{-x^5y^4}{9z^7}$

C $\frac{-x^6y^3}{27z^{12}}$

D $\frac{-x^2y^3}{3z^{12}}$

E $\frac{x^6y^3}{9z^{12}}$

6E

6 $2x^{-3}y^4$ expressed with positive indices is:

A $\frac{y^4}{2x^3}$

B $\frac{2y^4}{x^3}$

C $-2x^3y^4$

D $\frac{2}{x^3y^4}$

E $\frac{y^4}{8x^3}$

6E

7 $\frac{3}{(2x)^{-2}}$ is equivalent to:

A $\frac{-3}{(2x)^2}$

B $6x^2$

C $\frac{3x^2}{2}$

D $12x^2$

E $\frac{-3x^2}{4}$

6F

8 The weight of a cargo crate is 2.32×10^4 kg. In expanded form this weight in kilograms is:

A 2320000

B 232

C 23200

D 0.000232

E 2320



6G

9 0.00032761 using scientific notation rounded to three significant figures is:

A 328×10^{-5}

B 3.27×10^{-4}

C 3.28×10^4

D 3.30×10^4

E 3.28×10^{-4}

6H

10 $36^{\frac{1}{2}}$ is equal to:

A 18

B 6

C 1296

D 9

E 81

Ext

6I

11 The simplified form of $2\sqrt{7} - 3 + 4\sqrt{7}$ is:

A $-2\sqrt{7} - 3$

B $3\sqrt{7}$

C $6\sqrt{7} - 3$

D $\sqrt{7}$

E $8\sqrt{7} - 3$

Ext

6I

12 $\sqrt{3} \times \sqrt{7}$ is equivalent to:

A $\sqrt{21}$

B $\sqrt{10}$

C $2\sqrt{10}$

D $10\sqrt{21}$

E $21\sqrt{10}$

Ext

Extended-response questions

- 1 Simplify each of the following, expressing answers with positive indices, using a combination of index laws.

a $\frac{(4x^2y)^3 \times x^2y}{12(xy^2)^2}$

b $\frac{2a^3b^4}{(5a^3)^2} \times \frac{20a}{3b^{-4}}$

c $\frac{(5m^4n^{-3})^2}{m^{-1}n^2} \div \frac{5(m^{-1}n)^{-2}}{mn^{-4}}$

Ext d $\frac{(8x^4)^{\frac{1}{3}}}{2(y^3)^0} \times \frac{(3x^{\frac{1}{3}})^2}{3(x^2)^{\frac{1}{2}}}$



- 2 The law of gravitational force is given by $F = \frac{Gm_1m_2}{d^2}$ where F is the magnitude of the gravitational force (in newtons, N) between two objects of mass m_1 and m_2 (in kilograms) a distance d (metres) apart. G is the universal gravitational constant, which is approximately $6.67 \times 10^{-11} \text{ Nm}^2\text{kg}^{-2}$.

- a If two objects of masses 2 kg and 4 kg are 3 m apart, calculate the gravitational force F between them. Answer using scientific notation correct to three significant figures.
- b The average distance between Earth and the Sun is approximately 149 597 870 700 m.
- Write this distance using scientific notation with three significant figures.
 - Hence, if the mass of Earth is approximately 5.98×10^{24} kg and the mass of the Sun is approximately 1.99×10^{30} kg, calculate the gravitational force between them using scientific notation to two significant figures.
- c The universal gravitational constant, G , is constant throughout the universe. However, acceleration due to gravity (a , units m/s^2) varies according to where you are in the solar system. Using the formula $a = \frac{Gm}{r^2}$ and the following table, work out and compare the acceleration due to gravity on Earth and on Mars. Answer to three significant figures.

Planet	Mass, m	Radius, r
Earth	5.98×10^{24} kg	6.375×10^6 m
Mars	6.42×10^{23} kg	3.37×10^6 m



7

Geometry



Maths in context: Cantilever and truss bridges

Geometric knowledge, including congruent and similar triangles, Trigonometry, and Pythagoras' theorem, are essential skills used by civil engineers for designing and building structures, including bridges, cranes, roads, tunnels, airports, dams, communication towers, electricity pylons, water supply structures and sewage treatment systems.

The Tokyo Gate bridge (pictured) has a suspended central span, 440 m long, supported by two arms, or cantilevers, that reach out from each side of the bay

to hold the central span in place. Each cantilever has vertical support only at one end, the concrete pillars.

Locals nickname it 'Dinosaur bridge', from the 'head' shape of each steel triangular support structure which are called trusses. Each truss weighs 6,000 tonnes, the bridge is 2.618 km long overall, 87.8 m high, and can support 32,000 vehicles/day.

The cantilevers, trusses and central span were built on land, moved onto a barge, then positioned with massive cranes. This style of bridge and its

Chapter contents

- 7A Angles and triangles (CONSOLIDATING)
- 7B Parallel lines (CONSOLIDATING)
- 7C Quadrilaterals and other polygons
- 7D Congruent triangles
- 7E Using congruence in proof (EXTENDING)
- 7F Enlargement and similar figures
- 7G Similar triangles
- 7H Proving and applying similar triangles

Australian Curriculum 9.0

MEASUREMENT

Solve spatial problems, applying angle properties, scale, similarity, Pythagoras' theorem and trigonometry in right-angled triangles (AC9M9M03)

SPACE

Apply the enlargement transformation to shapes and objects using dynamic geometry software as appropriate; identify and explain aspects that remain the same and those that change (AC9M9SP02)

Design, test and refine algorithms involving a sequence of steps and decisions based on geometric constructions and theorems; discuss and evaluate refinements (AC9M9SP03)

© ACARA

Online resources

A host of additional online resources are included as part of your Interactive Textbook, including HOTmaths content, video demonstrations of all worked examples, auto-marked quizzes and much more.

construction process allows shipping to continue without interruption, and with its height below 100 m, incoming aircraft are safe.

Other Cantilever bridges include the Forth bridge, Edinburgh, Scotland, 1890; Brisbane's Story Bridge, 1940; Brisbane's twin Gateway Motorway bridges, completed 2010; and Melbourne's Bolte Bridge, 1999.

7A Angles and triangles CONSOLIDATING

LEARNING INTENTIONS

- To review types of angles and triangles
- To be able to work with complementary and supplementary angles, vertically opposite angles and angles in a revolution
- To be able to use the angle sum and other triangle properties to find unknown angles
- To know and be able to apply the exterior angle theorem

Geometry is all around us. The properties of the shape of a window, doorway or roofline depend on their geometry. When lines meet, angles are formed and it is these angles which help define the shape of an object. Fundamental to geometry are the angles formed at a point and the three angles in a triangle. Lines meeting at a point and triangles have special properties and will be revised in this section.



Lesson starter: Impossible triangles

Triangles are classified either by their side lengths or by their angles.

- First, write the list of three triangles which are classified by their side lengths and the three triangles that are classified by their angles.
- Now try to draw a triangle for the following descriptions. Decide which are possible and which are impossible.
 - Acute scalene triangle
 - Right equilateral triangle
 - Right isosceles triangle
 - Obtuse isosceles triangle
 - Obtuse scalene triangle
 - Acute equilateral triangle

KEY IDEAS

■ When two **rays**, **lines** or **line segments** meet at a point, an **angle** is formed.

- This angle is named $\angle A$ or $\angle BAC$ or $\angle CAB$.
- The size of this angle in degrees is a° .

■ Angle types

- **Acute** between 0° and 90°
- **Obtuse** between 90° and 180°
- **Reflex** between 180° and 360°
- **Right** 90°
- **Straight** 180°
- **Revolution** 360°

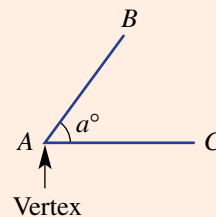

■ Angles at a point

- **Complementary**
(sum to 90°)

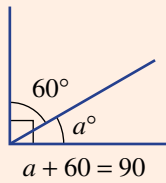

- **Supplementary**
(sum to 180°)

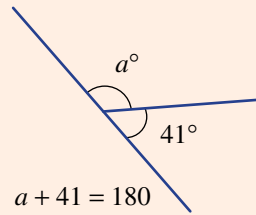

- **Revolution**
(sum to 360°)

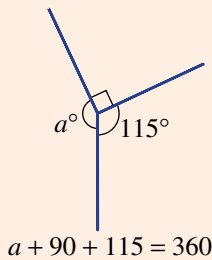

- **Vertically opposite**
(are equal)

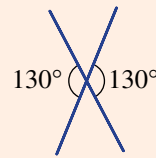

■ Types of triangles

Acute angled (all angles $< 90^\circ$)	Right-angled (includes a 90° angle)	Obtuse angled (one angle $> 90^\circ$)
<p>Scalene (all sides and angles are different sizes)</p>	<p>Scalene</p>	<p>Scalene</p>
<p>Equilateral (all angles 60° and all sides equal)</p> <p>Isosceles (two angles equal and two sides equal)</p>	<p>Isosceles</p>	<p>Isosceles</p>

- The sum of the angles in a triangle is 180° .

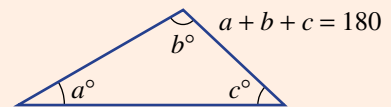

■ An **exterior angle** is formed by extending one side of a shape.

- **Exterior angle theorem of a triangle:** The exterior angle of a triangle is equal to the sum of the two opposite interior angles.

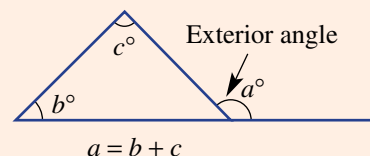

BUILDING UNDERSTANDING

1 Choose a word or number to complete each sentence.

- a A 90° angle is called a ____ angle. b A ____ angle is called a straight angle.
 c A 360° angle is called a _____. d _____ angles are between 90° and 180° .
 e _____ angles are between 0° and 90° . f Reflex angles are between _____ and 360° .
 g Complementary angles sum to _____. h _____ angles sum to 180° .
 i The three angles in a triangle sum to _____. j Vertically opposite angles are _____.

2 Name the type of triangle that has:

- a a pair of equal length sides b one obtuse angle
 c all angles 60° d one pair of equal angles
 e all angles acute f all sides of different length
 g one right angle.

3 Name the type of each angle, then estimate the size of the angle and use your protractor to determine an accurate measurement.

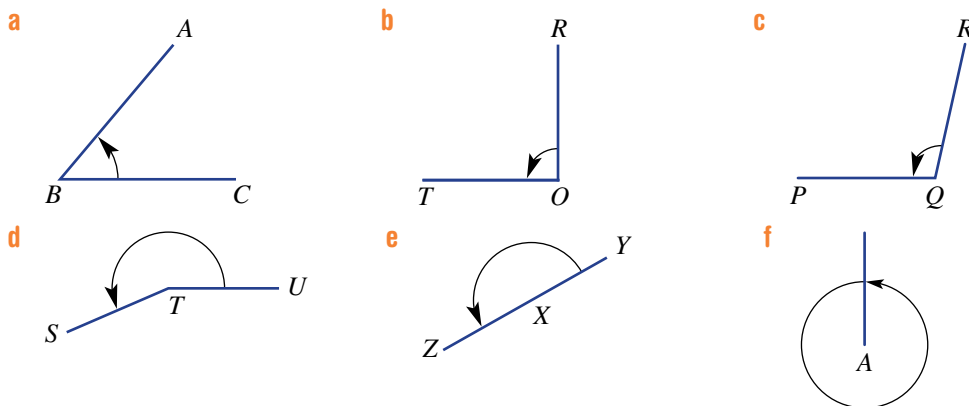

4 State whether each of the following pairs of angles is supplementary (S), complementary (C) or neither (N).

- a $30^\circ, 60^\circ$ b $45^\circ, 135^\circ$ c $100^\circ, 90^\circ$ d $50^\circ, 40^\circ$

Example 1 Finding supplementary and complementary angles

For an angle of size 47° determine the size of its:

- a supplementary angle b complementary angle.

SOLUTION

a $180^\circ - 47^\circ = 133^\circ$

b $90^\circ - 47^\circ = 43^\circ$

EXPLANATION

Supplementary angles sum to 180° .

Complementary angles sum to 90° .

Now you try

For an angle of size 72° determine the size of its:

- a supplementary angle b complementary angle.



Example 2 Finding unknown angles in triangles

Name the types of triangles shown here and determine the values of the pronumerals.

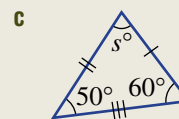
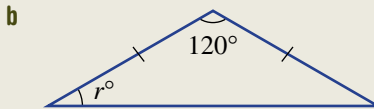
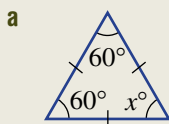

SOLUTION

a Equilateral triangle

$$x = 60$$

b Obtuse isosceles triangle

$$2r + 120 = 180$$

$$2r = 60$$

$$r = 30$$

c Acute scalene triangle

$$s + 50 + 60 = 180$$

$$s + 110 = 180$$

$$s = 70$$

EXPLANATION

All sides are equal, therefore all angles are equal.

One angle is more than 90° and two sides are equal.

Angles in a triangle add to 180° . Since the triangle is isosceles, both base angles are r° . Subtract 120° from both sides and then divide both sides by 2.

All angles are less than 90° and all sides are of different length.

Angles in a triangle add to 180° . Simplify and solve for s .

Now you try

Name the types of triangles shown here and determine the values of the pronumerals.

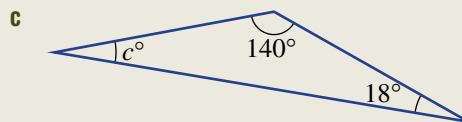
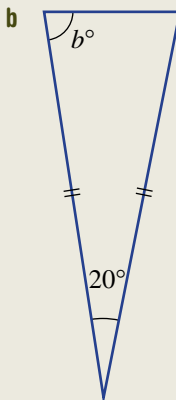
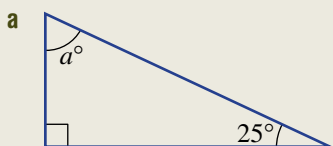



Example 3 Finding exterior and other angles

Find the value of each pronumeral. Give reasons for your answers.

a

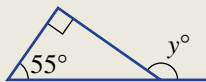

b

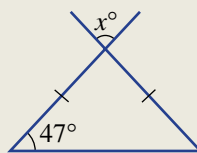

SOLUTION

$$\begin{aligned} \mathbf{a} \quad y &= 90 + 55 \\ &= 145 \end{aligned}$$

Alternative method:

Let a be the unknown angle.

$$a + 90 + 55 = 180 \text{ (angle sum)}$$

$$a = 35$$

$$y + 35 = 180$$

$$y = 145$$

$$\mathbf{b} \quad x + 47 + 47 = 180 \text{ (angle sum)}$$

$$x + 94 = 180$$

$$x = 86$$

EXPLANATION

Use the exterior angle theorem, which states that the exterior angle is equal to the sum of the two opposite interior angles.

Alternatively:

Angles in a triangle sum to 180° .

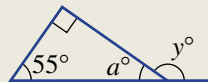

Angles in a straight line are supplementary (sum to 180°).

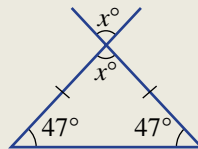

Note the isosceles triangle and vertically opposite angles.

Angles in a triangle add to 180° and vertically opposite angles are equal. Simplify and solve for x .

Now you try

Find the value of each pronumeral. Give reasons for your answers.

a

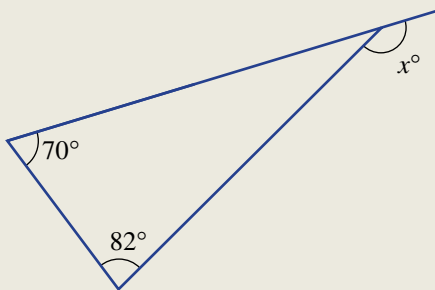

b

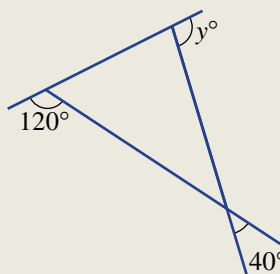

Exercise 7A

FLUENCY

1–3(1/2)

1–4(1/2)

1–4(1/3)

Example 1

- 1 For each of the following angle sizes determine the size of:
- the supplementary angle
 - the complementary angle.
- a 55° b 74° c 89° d 22° e 38° f 47°
- 2 Find the value of a in these diagrams. Each diagram contains complementary or supplementary angles, or angles in a revolution. Refer to 'Angles at a point' in the key ideas on page 463 if needed.

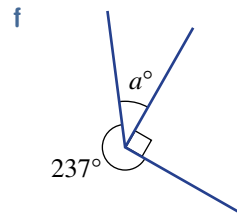
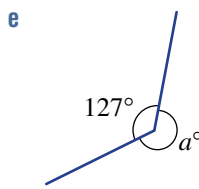
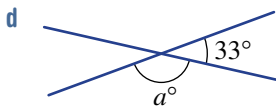
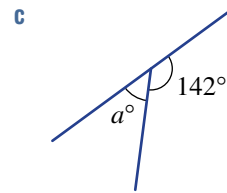
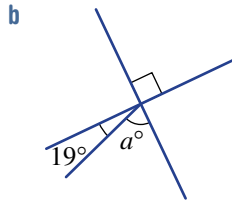
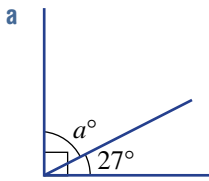

Example 2

- 3 Determine the values of the pronumerals and name the types of triangles shown here.

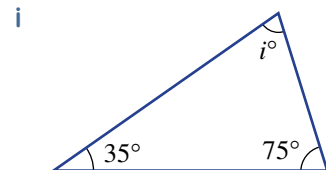
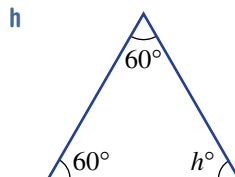
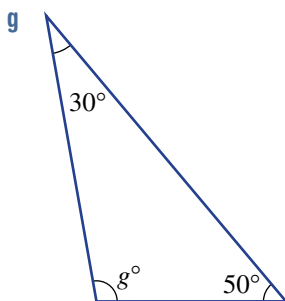
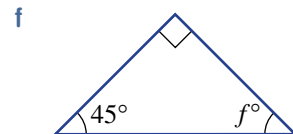
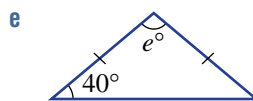
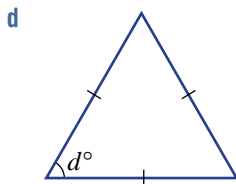
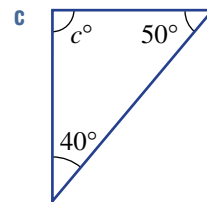
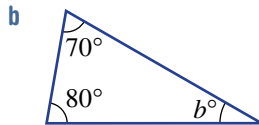
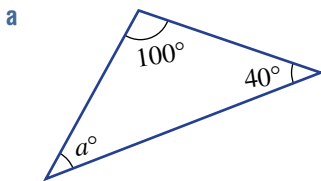

Example 3 4 Find the value of each pronumeral.

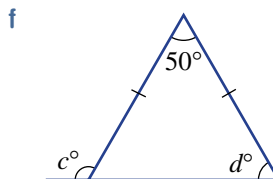
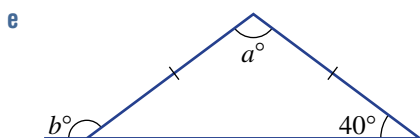
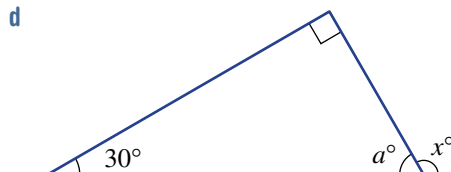
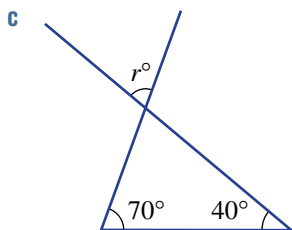
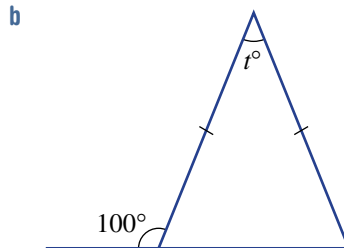
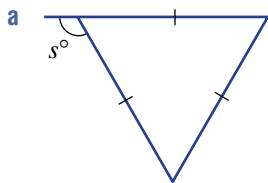

PROBLEM-SOLVING 5, 6 5(1/2), 6, 7(1/2) 6, 7(1/2)

- 5 Calculate how many degrees the minute hand of a clock rotates in:
- a 1 hour
 - b 1/4 of an hour
 - c 10 minutes
 - d 15 minutes
 - e 72 minutes
 - f 1 minute
 - g 2 hours
 - h 1 day

6 Find the value of x in these diagrams.

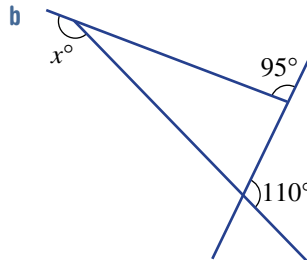
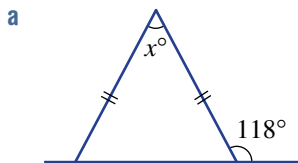

7 Find the acute or obtuse angle between the hour and minute hands at these times. Remember to consider how the hour hand moves between each whole number.

- a 3:00 p.m.
- b 5:00 a.m.
- c 6:30 p.m.
- d 11:30 p.m.
- e 3:45 a.m.
- f 1:20 a.m.
- g 4:55 a.m.
- h 2:42 a.m.
- i 9:27 a.m.



REASONING

8, 9

8, 9

9–11

- 8 A tangent to a circle is 90° to its radius. Explain why $x = 330$ in this diagram.

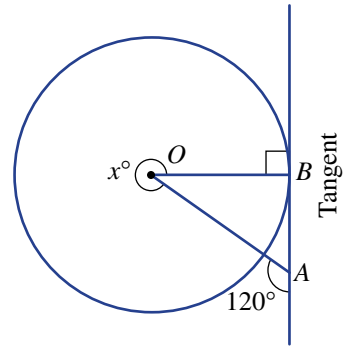

- 9 Explain why $\angle OAB$ is 32° in this circle. O is the centre of the circle.

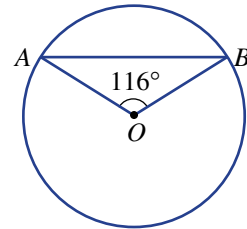

- 10 In this diagram, $\angle XYZ$ is an exterior angle. *Do not* use the exterior angle theorem in the following.
- If $a = 85$ and $b = 75$, find $\angle XYZ$.
 - If $a = 105$ and $b = 60$, find $\angle XYZ$.
 - Now using the pronumerals a and b , prove that $\angle XYZ = a^\circ + b^\circ$.

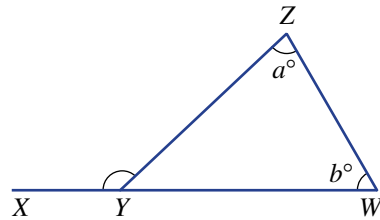

- 11 Prove that the three exterior angles of a triangle sum to 360° . Use the fact that the three interior angles sum to 180° .

ENRICHMENT: Algebra in geometry

–

–

12

- 12 Write an equation for each diagram and solve it to find x .

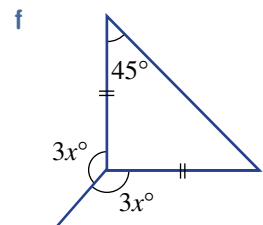
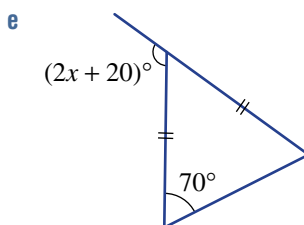
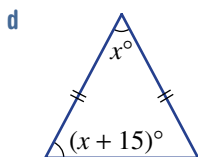
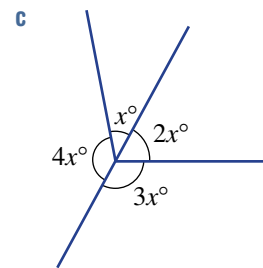
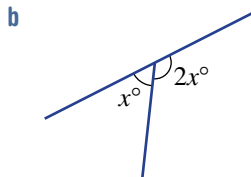
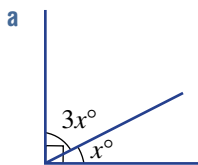

7B Parallel lines CONSOLIDATING

LEARNING INTENTIONS

- To review the types of angles formed by parallel lines and a transversal
- To be able to decide if two lines are parallel based on angle properties
- To be able to find unknown angles in parallel lines, including by adding an extra parallel line

A line crossing two or more other lines (called a transversal) creates a number of special pairs of angles. If the transversal cuts two parallel lines, then these special pairs of angles will be either equal or supplementary.

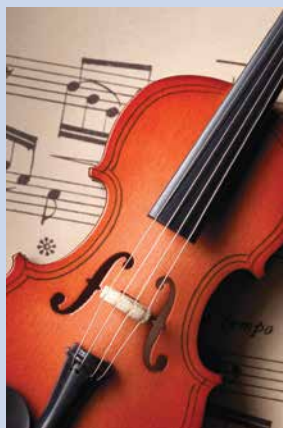
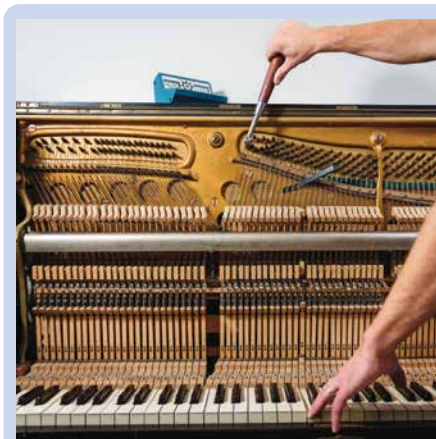

A piano has parallel keys, hammers and strings; however, a violin's strings are not parallel. Musicians write music using two sets of parallel lines: the treble clef (higher notes) and bass clef (lower notes).

Lesson starter: Are they parallel?

Here are three diagrams in which a transversal crosses two other lines.

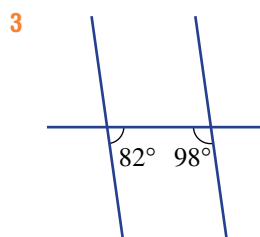
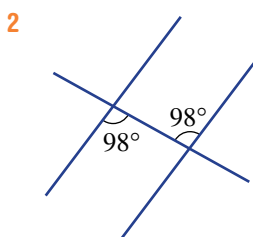
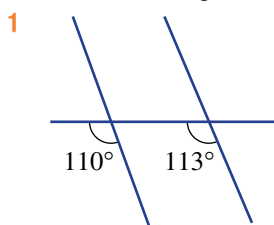

- Decide if each diagram contains a pair of parallel lines. Give reasons for your answer.
- What words do you remember regarding the name given to each pair of angles shown in the diagrams?

KEY IDEAS

- A **transversal** is a line crossing two or more other lines.

Pair of angles	Non-parallel lines	Parallel lines
<p>Corresponding angles If lines are parallel corresponding angles are equal.</p>		

Pair of angles	Non-parallel lines	Parallel lines
Alternate angles If lines are parallel alternate angles are equal.		
Cointerior angles If lines are parallel cointerior angles are supplementary.		

■ If a line AB is parallel to a line CD we write $AB \parallel CD$.

■ A parallel line can be added to a diagram to help find other angles.

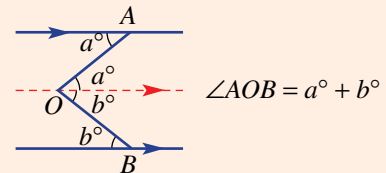

BUILDING UNDERSTANDING

1 Choose the word *equal* or *supplementary* to complete these sentences.

- If two lines are parallel corresponding angles are _____.
- If two lines are parallel alternate angles are _____.
- If two lines are parallel cointerior angles are _____.

2 State the values of the pronumerals in these parallel lines. Give reasons for your answers.

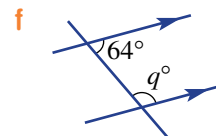
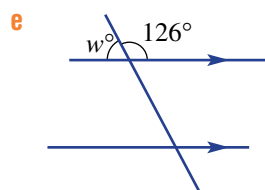
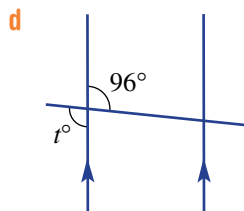
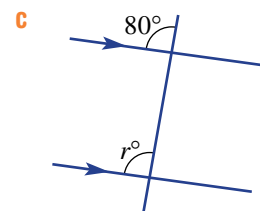
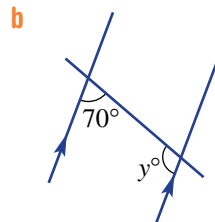
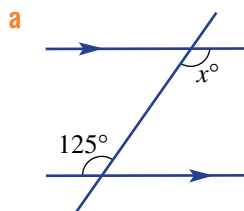



Example 4 Deciding if lines are parallel

Decide if each diagram contains a pair of parallel lines. Give a reason.

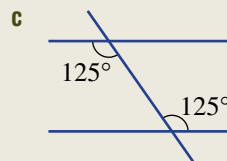
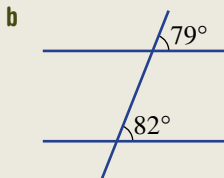
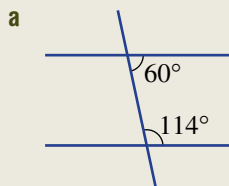

SOLUTION

- a** No. The two cointerior angles are not supplementary.
- b** No. The two corresponding angles are not equal.
- c** Yes. The two alternate angles are equal.

EXPLANATION

$$60^\circ + 114^\circ = 174^\circ \neq 180^\circ$$

$$79^\circ \neq 82^\circ$$

If alternate angles are equal then the lines are parallel.

Now you try

Decide if each diagram contains a pair of parallel lines. Give a reason.

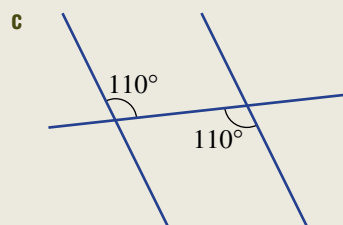
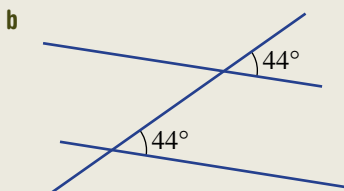
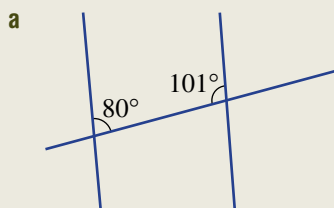



Example 5 Finding angles in parallel lines

Find the value of each of the pronumerals. Give reasons for your answers.

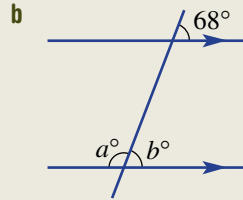
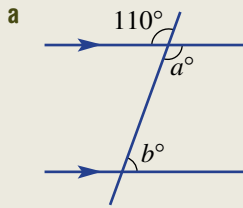

SOLUTION

a $a = 110$ (vertically opposite angles)

$$b + 110 = 180 \text{ (cointerior angles in parallel lines)}$$

$$b = 70$$

b $b = 68$ (corresponding angles in parallel lines)

$$a + 68 = 180 \text{ (supplementary angles)}$$

$$a = 112$$

EXPLANATION

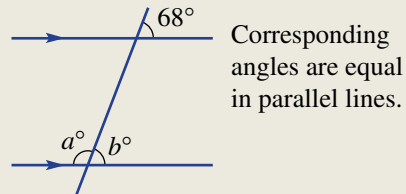
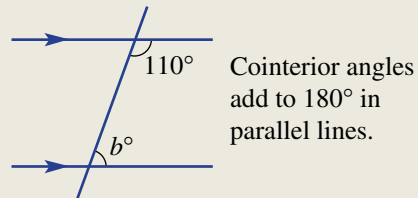
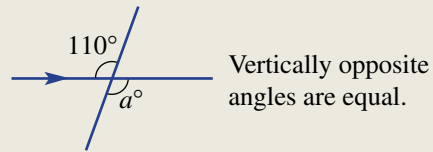

Supplementary angles add to 180° so $a + b = 180$.

Now you try

Find the value of each of the pronumerals. Give reasons for your answers.

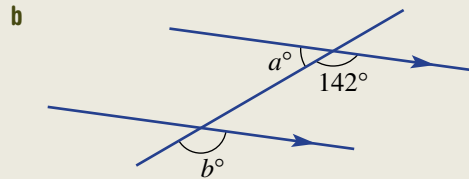
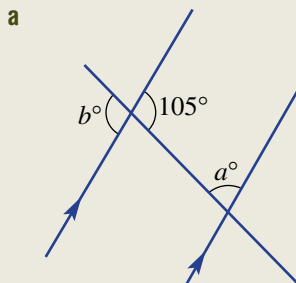



Example 6 Adding a third parallel line

Add a third parallel line to help find $\angle ABC$ in this diagram.

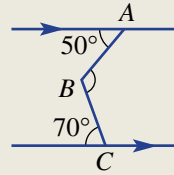

SOLUTION

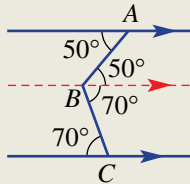

$$\begin{aligned} \angle ABC &= 50^\circ + 70^\circ \\ &= 120^\circ \end{aligned}$$

EXPLANATION

Add a third parallel line through B to create two pairs of equal alternate angles.

Add 50° and 70° to give the size of $\angle ABC$.

Now you try

Add a third parallel line to help find $\angle ABC$ in this diagram.

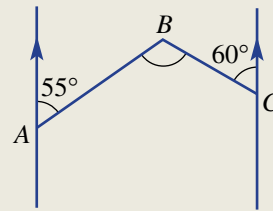

Exercise 7B

FLUENCY

1, 2(1/2)

1-2(1/2)

1-2(1/2)

Example 4

1 Decide if each diagram contains a pair of parallel lines. Give a reason.

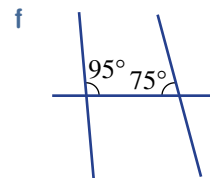
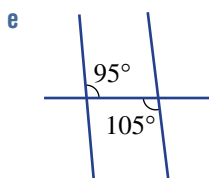
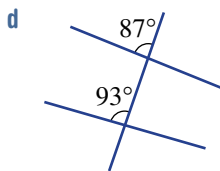
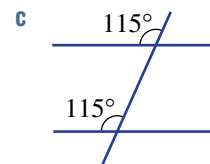
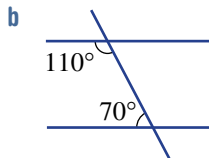
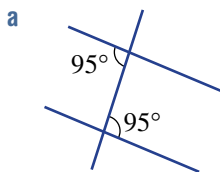

Example 5 2 Find the value of each pronumeral. Give reasons for your answers.

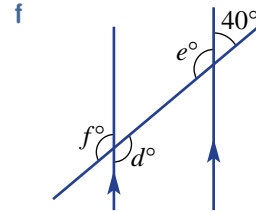
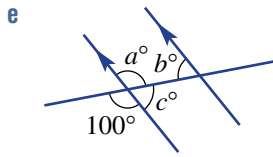
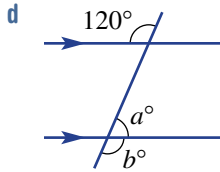
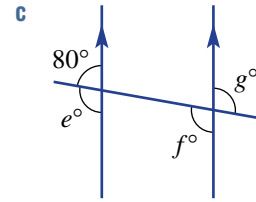
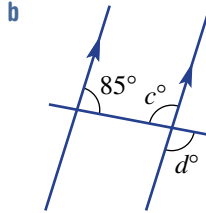
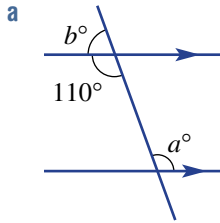

PROBLEM-SOLVING

3

3-4(1/2)

3-4(1/2), 5

3 Find the value of each pronumeral.

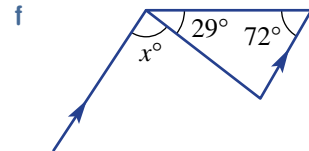
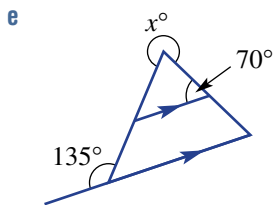
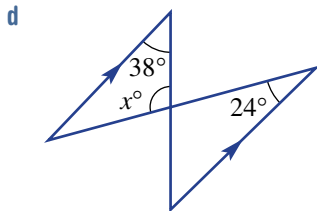
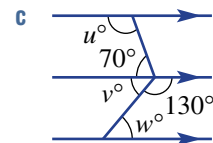
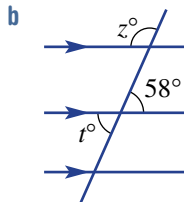
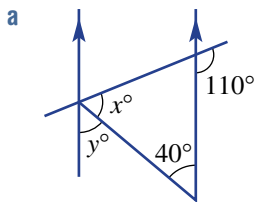

Example 6 4 Add a third parallel line to help find $\angle ABC$ in these diagrams.

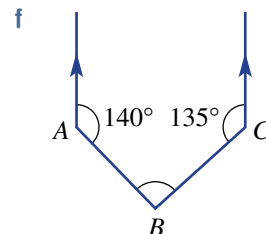
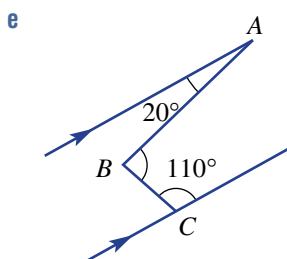
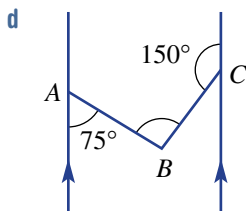
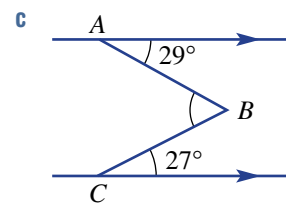
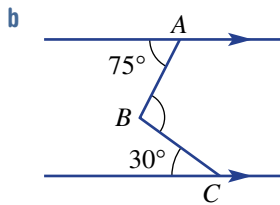
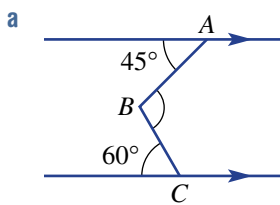

5 Find the value of x .

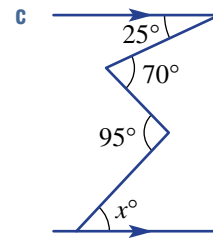
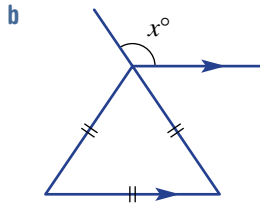
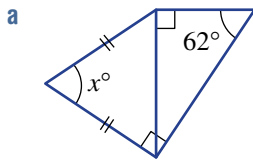

REASONING

6

6(1/2), 7

6(1/2), 7, 8

6 Write an expression (for example, $180^\circ - a^\circ$) for $\angle ABC$ in these diagrams.

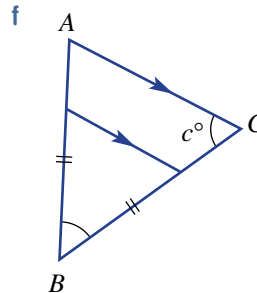
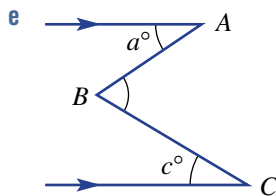
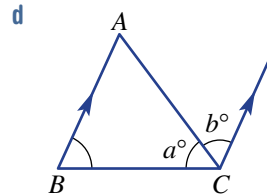
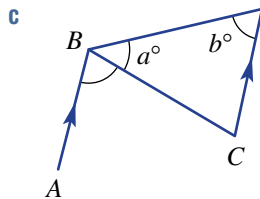
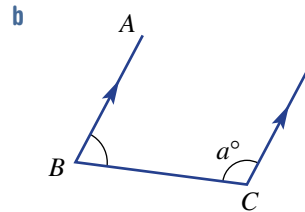
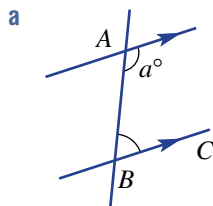

7 Give reasons why $AB \parallel DC$ (AB is parallel to DC) in this diagram.

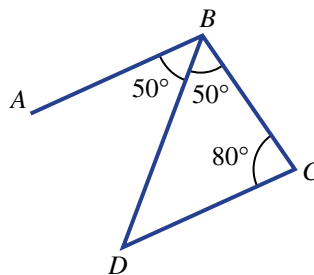

- 8 The diagram below includes a triangle and a pair of parallel lines.
- a Using the parallel lines, explain why $a + b + c = 180$.
 - b Explain why $\angle ACB = c^\circ$.
 - c Explain why this diagram helps to prove that the angle sum of a triangle is 180° .

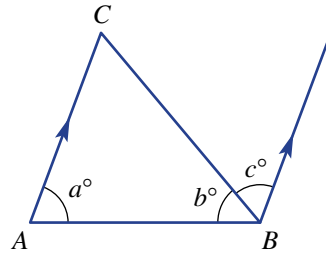

ENRICHMENT: Proof in geometry - - 9

- 9 Here is a written proof showing that $\angle ABC = a^\circ - b^\circ$.

$\angle BED = 180^\circ - a^\circ$ (angle sum of a triangle)
 $\angle BCA = 180^\circ - a^\circ$ (alternate angles and $ED \parallel AC$)
 $\angle ABC = 180^\circ - b^\circ - (180^\circ - a^\circ)$ (supplementary angles)
 $= 180^\circ - b^\circ - 180^\circ + a^\circ$
 $= -b^\circ + a^\circ$
 $= a^\circ - b^\circ$

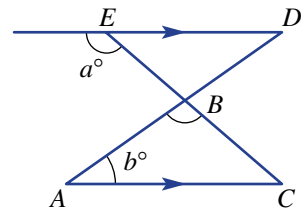

Write a similar proof for each of the following angles.

- a $\angle ABC = a^\circ - c^\circ$

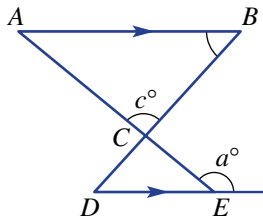

- b $\angle ABC = a^\circ + b^\circ$

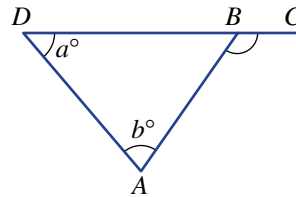

- c $\angle ABC = a^\circ + b^\circ$

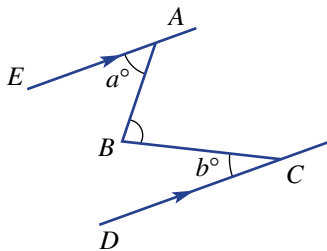

- d $\angle ABC = 180^\circ + b^\circ - a^\circ$

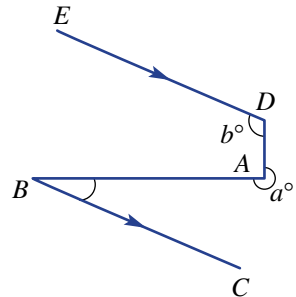

7C Quadrilaterals and other polygons

LEARNING INTENTIONS

- To know how to find the interior angle sum of a polygon
- To know terms related to polygons such as regular, convex and non-convex
- To know the properties of different types of quadrilaterals
- To be able to use the angle sum and polygon properties to find the value of unknown angles

Closed two-dimensional shapes with straight sides are called polygons and are classified by their number of sides. Quadrilaterals have four sides and are classified further by their special properties.

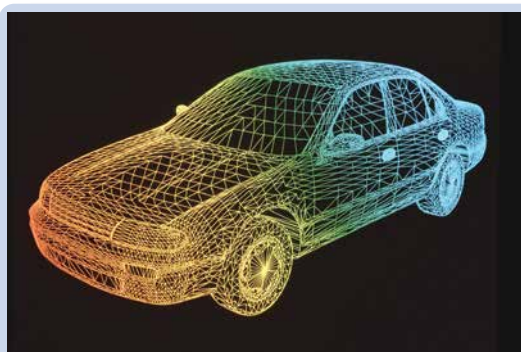

Computer programmers code 3D objects using a polygon mesh of triangles and quadrilaterals. Working with computer-aided design and machine learning, engineers can test and adjust the aerodynamic properties of a new car model before it is built.

Lesson starter: Draw that shape

Use your knowledge of polygons to draw each of the following shapes. Mark any features, including parallel sides and sides of equal length.

- convex quadrilateral
- non-convex pentagon
- regular hexagon
- square, rectangle, rhombus and parallelogram
- kite and trapezium

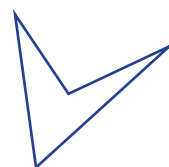

This is a non-convex quadrilateral.

Compare the properties of each shape to ensure you have indicated each property on your drawings.

KEY IDEAS

- **Convex polygons** have all interior angles less than 180° . A **non-convex polygon** has at least one interior angle greater than 180° .

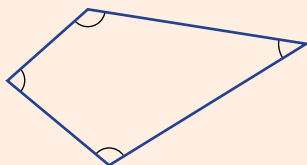

Convex quadrilateral

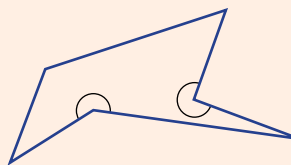

Non-convex hexagon

■ **The sum of the interior angles, S , in a polygon with n sides is given by $S = (n - 2) \times 180^\circ$.**

Polygon	Number of sides (n)	Angle sum (S)
Triangle	3	180°
Quadrilateral	4	360°
Pentagon	5	540°
Hexagon	6	720°
Heptagon	7	900°
Octagon	8	1080°
Nonagon	9	1260°
Decagon	10	1440°
Undecagon	11	1620°
Dodecagon	12	1800°
n-gon	n	$(n - 2) \times 180^\circ$

■ **Regular polygons** have sides of equal length and equal interior angles.

■ The sum of all the exterior angles of every polygon is 360° .

- This example shows a pentagon but the 360° exterior sum is true for all polygons.

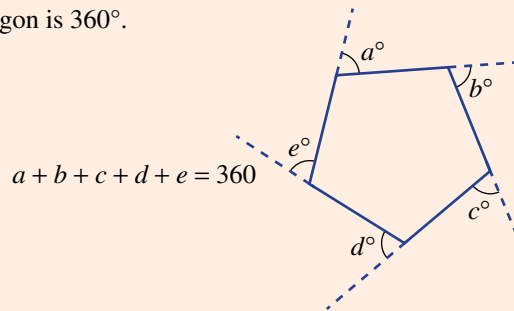

■ **Parallelograms** are **quadrilaterals** with two pairs of parallel sides. They include:

- Parallelogram: a quadrilateral with two pairs of parallel sides
- Rhombus: a parallelogram with all sides equal
- Rectangle: a parallelogram with all angles 90°
- Square: a rhombus with all angles 90° .

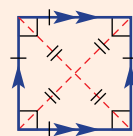
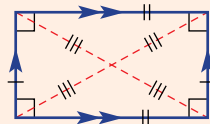
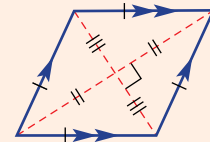
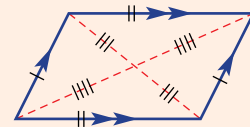

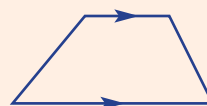
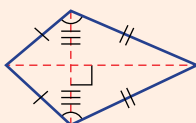

■ The kite and trapezium are also special quadrilaterals.

- Kite
- Trapezium

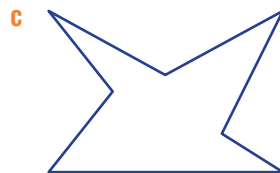
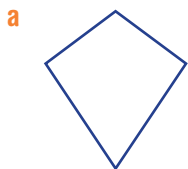

BUILDING UNDERSTANDING

- 1 How many sides do these polygons have?
- a Pentagon b Heptagon c Quadrilateral
d Undecagon e Nonagon f Dodecagon
- 2 Use $S = (n - 2) \times 180^\circ$ to find the angle sum, S , of these polygons, where n is the number of sides.
- a Hexagon b Octagon c Undecagon
- 3 Choose the word to complete these sentences.
- a A parallelogram has two pairs of _____ sides.
b The diagonals in a rhombus intersect at _____ angles.
c A _____ has one pair of parallel sides.
d The diagonals in a rectangle are _____ in length.
- 4 Name each of these shapes and describe them as convex or non convex.

 Example 7 Finding angles in quadrilaterals

Find the value of the pronumeral in each of these quadrilaterals.

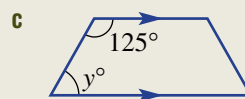
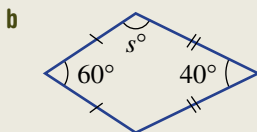
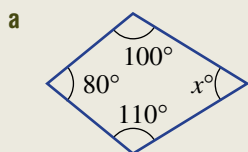

SOLUTION

a $x + 80 + 100 + 110 = 360$
 $x + 290 = 360$
 $x = 70$

b $2s + 60 + 40 = 360$
 $2s + 100 = 360$
 $2s = 260$
 $s = 130$

c $y + 125 = 180$
 $y = 55$

EXPLANATION

The angles in a quadrilateral add to 360° .
Simplify and solve for x .

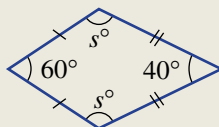

Simplify and solve for s .

Cointerior angles inside parallel lines are supplementary.

The angles in a quadrilateral add to 360° and the opposite angles (s°) are equal in a kite.

Now you try

Find the value of the pronumeral in each of these quadrilaterals.

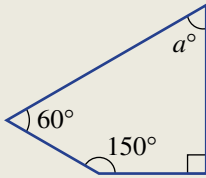
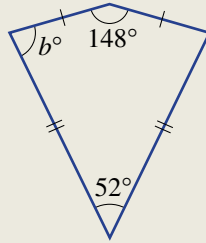
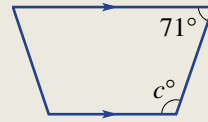
a**b****c****Example 8 Finding angles in polygons**

For each polygon find the angle sum using $S = (n - 2) \times 180^\circ$, then find the value of any pronumerals. The polygon in part **b** is regular.

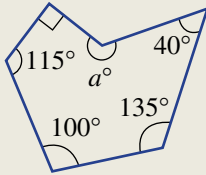
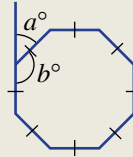
a**b****SOLUTION**

$$\begin{aligned} \mathbf{a} \quad n &= 6 \text{ and } S = (n - 2) \times 180^\circ \\ &= (6 - 2) \times 180^\circ \\ &= 720 \end{aligned}$$

$$\begin{aligned} a + 90 + 115 + 100 + 135 + 40 &= 720 \\ a + 480 &= 720 \\ a &= 240 \end{aligned}$$

$$\begin{aligned} \mathbf{b} \quad n &= 8 \text{ and } S = (n - 2) \times 180^\circ \\ &= (8 - 2) \times 180^\circ \\ &= 1080 \\ 8b &= 1080 \\ b &= 135 \\ a + 135 &= 180 \\ a &= 45 \end{aligned}$$

EXPLANATION

The shape is a hexagon with 6 sides so $n = 6$.

The sum of all angles is 720° . Simplify and solve for a .

The regular octagon has 8 sides, so use $n = 8$.

Each interior angle is equal to b° , so $8b^\circ$ is the angle sum.

a° is an exterior angle and a° and b° are supplementary.

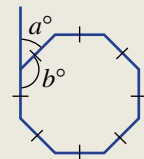
**Now you try**

For each polygon find the angle sum using $S = (n - 2) \times 180^\circ$, then find the value of any pronumerals. The polygon in part **b** is regular.

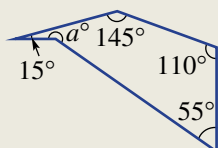
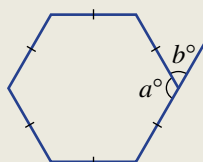
a**b**

Exercise 7C

FLUENCY

1(1/2), 2, 3(1/2)

1-3(1/2)

2-3(1/2)

Example 7a

1 Find the values of the pronumerals in each of these quadrilaterals.

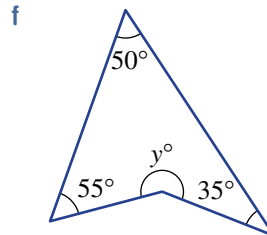
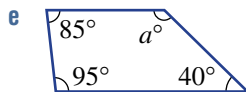
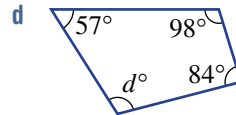
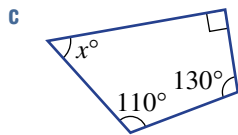
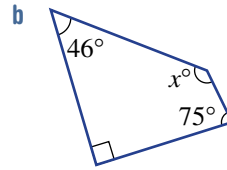
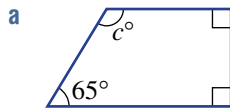

Example 7b,c

2 Find the value of the pronumerals.

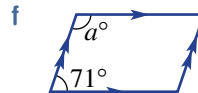
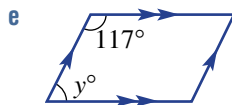
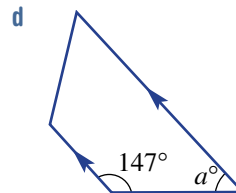
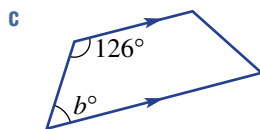
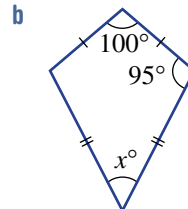
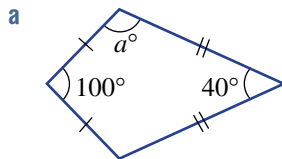

Example 8

3 For each polygon find the angle sum using $S = (n - 2) \times 180^\circ$, then find the value of any pronumerals. The polygons in parts e–i are regular.

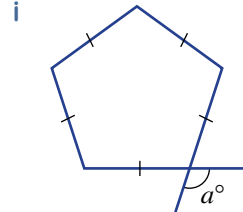
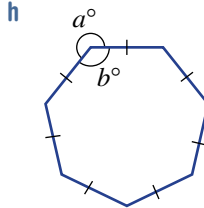
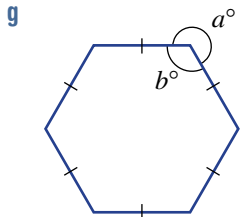
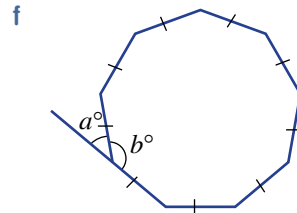
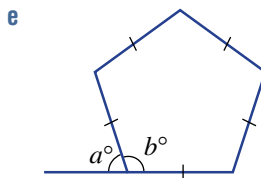
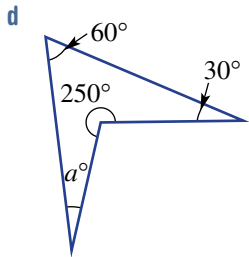
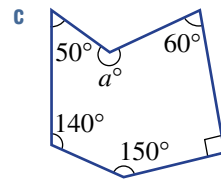
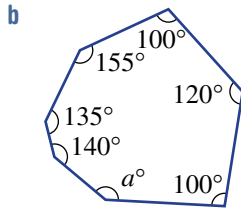
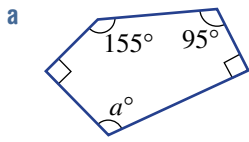

PROBLEM-SOLVING

4

4, 5, 6(1/2)

5, 6

- 4 List all the quadrilaterals which have these properties.
- a 2 pairs of equal length sides
 - b All interior angles 90°
 - c Diagonals of equal length
 - d Diagonals intersecting at right angles



5 Calculate the number of sides of a polygon that has the given angle sum. (*Hint:* Use the rule $S = (n - 2) \times 180^\circ$.)

a 2520°

b 4140°

c 18000°

6 Find the value of x in these diagrams.

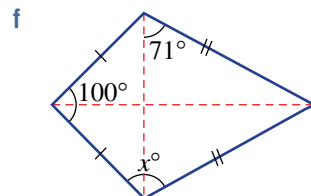
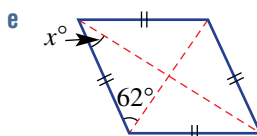
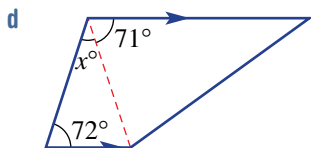
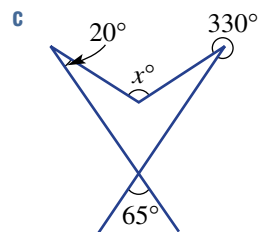
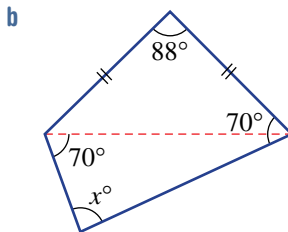
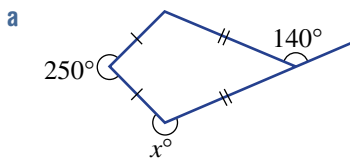

REASONING	7	7, 8	8, 9
------------------	---	------	------

- 7 Explain why a rectangle, a square and a rhombus are all parallelograms.
- 8 Consider a regular polygon with n sides.
- Write the rule for the sum of the interior angles (S°).
 - Write the rule for the size of each interior angle (I°).
 - Write the rule for the size of each exterior angle (E°).
 - Use your rule from part c to find the size of the exterior angle of a regular decagon.

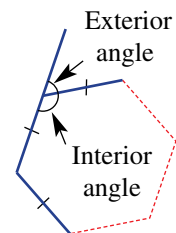

- 9 Recall that a non-convex polygon has at least one reflex interior angle.
- What is the maximum number of interior reflex angles possible for these polygons?
 - quadrilateral
 - pentagon
 - octagon
 - Write an expression for the maximum number of interior reflex angles for a polygon with n sides.

ENRICHMENT: Angle sum proof	-	-	10
------------------------------------	---	---	----

- 10 Note that if you follow the path around this pentagon starting and finishing at point A (provided you finish by pointing in the same direction as you started) you will have turned a total of 360° .

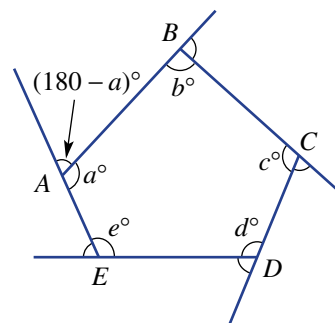

Complete this proof of the angle sum of a pentagon (540°).

$$(180 - a) + (180 - b) + (\quad) + (\quad) + (\quad) = \underline{\hspace{2cm}}$$

(since sum of exterior angles is $\underline{\hspace{2cm}}$)

$$180 + 180 + \underline{\hspace{1cm}} + \underline{\hspace{1cm}} + \underline{\hspace{1cm}} - (a + b + \underline{\hspace{1cm}} + \underline{\hspace{1cm}} + \underline{\hspace{1cm}}) = 360$$

$$\underline{\hspace{1cm}} - (\quad) = 360$$

$$(\quad) = \underline{\hspace{2cm}}$$

Now complete a similar proof for the angle sum of these polygons.

- Hexagon
- Heptagon

(For an additional challenge, try to complete a similar proof for a polygon with n sides.)



7D Congruent triangles

LEARNING INTENTIONS

- To understand the meaning of congruence
- To know the minimal conditions required to prove triangles are congruent
- To be able to identify corresponding pairs of sides or angles in triangles
- To be able to choose which test shows that a pair of triangles are congruent
- To be able to use congruence of triangles to find unknown angles or side lengths

When two objects have the same shape and size we say they are congruent. Matching sides will be the same length and matching angles will be the same size. The areas of congruent shapes will also be equal. However, not every property of a pair of shapes needs to be known in order to determine their congruence. This is highlighted in the study of congruent triangles in which four tests can be used to establish congruence.



Engineers apply congruent triangle geometry in the design and construction of truss bridges, as shown on this railway truss bridge near Mt Fuji, Japan.

Lesson starter: Constructing congruent triangles

To complete this task you will need a ruler, pencil and protractor. (For accurate constructions you may wish to use compasses.) Divide these constructions up equally among the members of the class. Each group is to construct their triangle with the given properties.

- 1 Triangle ABC with $AB = 8$ cm, $AC = 5$ cm and $BC = 4$ cm
- 2 Triangle DEF with $DE = 7$ cm, $DF = 6$ cm and $\angle EDF = 40^\circ$
- 3 Triangle GHI with $GH = 6$ cm, $\angle IGH = 50^\circ$ and $\angle IHG = 50^\circ$
- 4 Triangle JKL with $\angle JKL = 90^\circ$, $JL = 5$ cm and $KL = 4$ cm
 - Now compare all triangles with the vertices ABC . What do you notice? What does this say about two triangles that have three pairs of equal side lengths?
 - Compare all triangles with the vertices DEF . What do you notice? What does this say about two triangles that have two pairs of equal side lengths and the included angles equal?
 - Compare all triangles with the vertices GHI . What do you notice? What does this say about two triangles that have two equal corresponding angles and one corresponding equal length side?
 - Compare all triangles with the vertices JKL . What do you notice? What does this say about two triangles that have one right angle, the hypotenuse and one other pair of corresponding sides equal?

KEY IDEAS

■ **Congruent figures** have the same shape and size.

- If two figures are congruent, one of them can be transformed by using rotation, reflection and/or translation to match the other figure exactly.



■ If triangle ABC ($\triangle ABC$) is congruent to triangle DEF ($\triangle DEF$), we write $\triangle ABC \equiv \triangle DEF$. This is called a **congruence statement**. Letters are usually written in matching order.

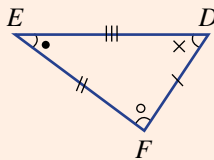
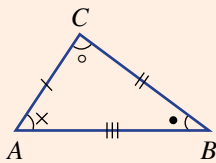

Corresponding sides	Corresponding angles
$AB = DE$	$\angle A = \angle D$
$BC = EF$	$\angle B = \angle E$
$AC = DF$	$\angle C = \angle F$

■ **Corresponding** sides are opposite equal corresponding angles.

■ **Tests for triangle congruence.**

- **Side, Side, Side (SSS)**
Three pairs of corresponding sides are equal.
- **Side, Angle, Side (SAS)**
Two pairs of corresponding sides and the included angle are equal.
- **Angle, Angle, Side (AAS)**
Two angles and any pair of corresponding sides are equal.
- **Right angle, Hypotenuse, Side (RHS)**
A right angle, the hypotenuse and one other pair of corresponding sides are equal.

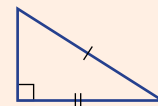
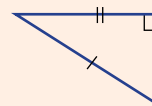
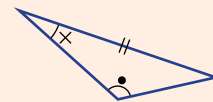
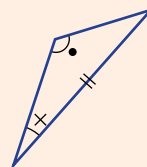
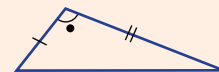
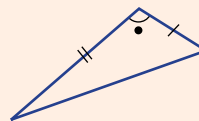
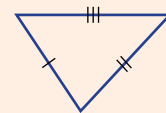
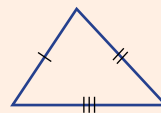

BUILDING UNDERSTANDING

- 1 State the missing terms to complete the sentences below.
- Congruent figures are exactly the same shape and _____.
 - If triangle ABC is congruent to triangle STU then we write $\triangle ABC \equiv$ _____.
 - The abbreviated names of the four congruence tests for triangles are SSS, ____, ____, and ____.
- 2 These two triangles are congruent.
- Name the side on $\triangle XYZ$ which corresponds to (matches):
 - AB
 - AC
 - BC
 - Name the angle in $\triangle ABC$ which corresponds to (matches):
 - $\angle X$
 - $\angle Y$
 - $\angle Z$
- 3 State a congruence statement (e.g. $\triangle ABC \equiv \triangle DEF$) given that:
- triangle ABC is congruent to triangle FGH
 - triangle DEF is congruent to triangle STU .

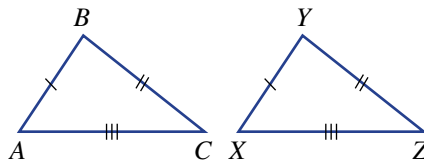

Example 9 Choosing the appropriate congruence test

Which congruence test (SSS, SAS, AAS or RHS) would be used to show that these pairs of triangles are congruent?

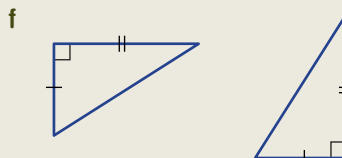
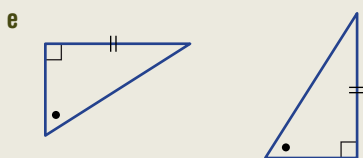
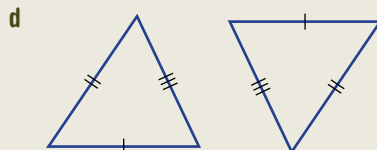
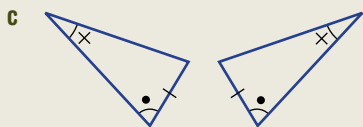
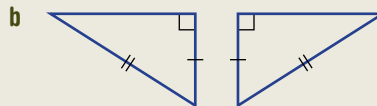
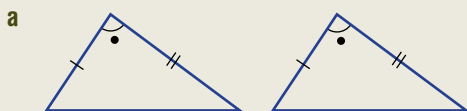
**SOLUTION**

- SAS
- RHS
- AAS
- SSS
- AAS
- SAS

EXPLANATION

- Two pairs of corresponding sides and the included angle are equal.
- A right angle, hypotenuse and one pair of corresponding sides are equal.
- Two pairs of angles and a pair of corresponding sides are equal.
- Three pairs of corresponding sides are equal.
- Two pairs of angles and a pair of matching sides are equal.
- Two pairs of matching sides and the included angles are equal.

Now you try

Which congruence test (SSS, SAS, AAS or RHS) would be used to show that these pairs of triangles are congruent?

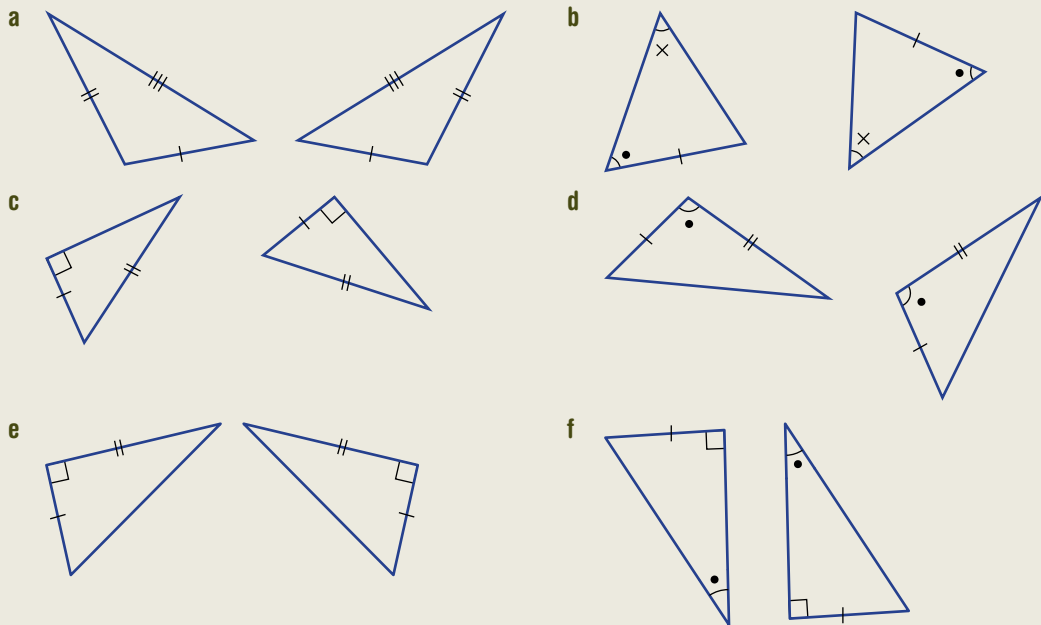

Example 10 Finding missing side lengths and angles using congruence

Find the values of the pronumerals in these pairs of congruent triangles.

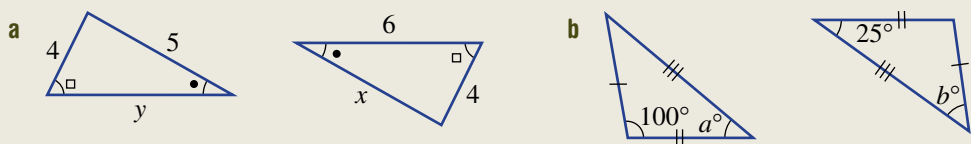

SOLUTION

a $x = 5$

$y = 6$

b $a = 25$

$$\begin{aligned} b &= 180 - 100 - 25 \\ &= 55 \end{aligned}$$

EXPLANATION

The side of length x and the side of length 5 are in corresponding positions (opposite the \square).

The longest sides on the two triangles must be equal. The side of length y and the side of length 6 are corresponding sides.

The angle marked a° corresponds to the 25° angle in the other triangle.

The angle marked b° corresponds to the missing angle in the first triangle.

The sum of three angles in a triangle is 180° .

Now you try

Find the values of the pronumerals in these pairs of congruent triangles.

a

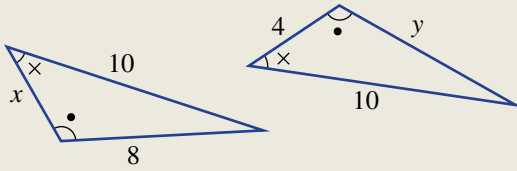

b

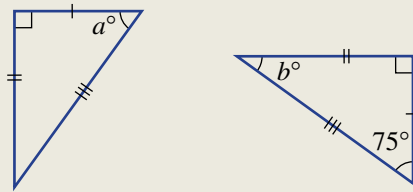

Exercise 7D

FLUENCY

1, 2(1/2)

1, 2(1/2)

1, 2(1/2)

Example 9 1 Which congruence test (SSS, SAS, AAS or RHS) would be used to show that these pairs of triangles are congruent?

a

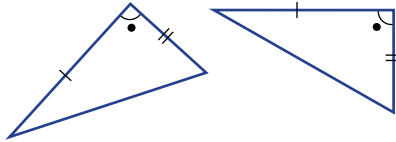

b

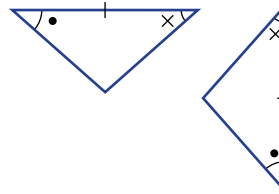

c

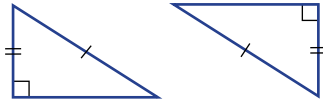

d

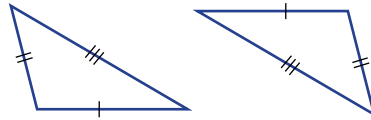

e

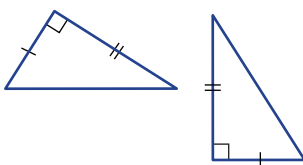

f

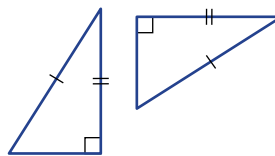

Example 10 2 Find the values of the pronumerals in these pairs of congruent triangles.

a

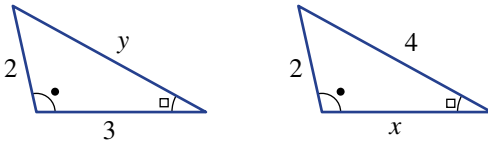

b

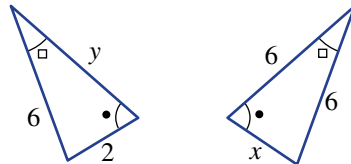

c

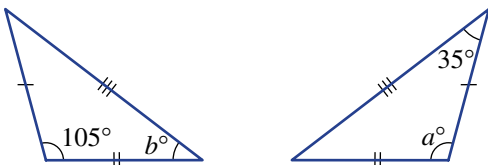

d

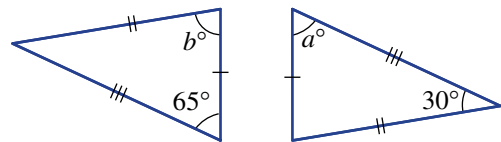

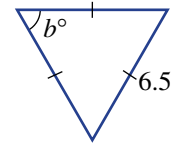
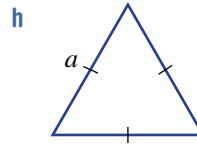
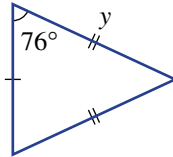
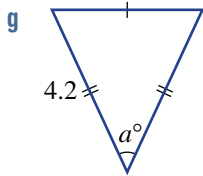
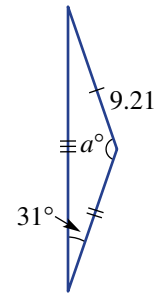
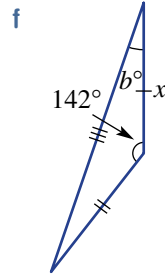
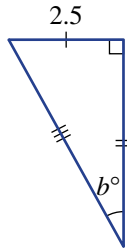
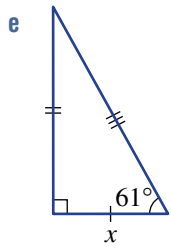

PROBLEM-SOLVING

3, 4

3, 4

4, 5

3 For each set of three triangles choose the two which are congruent. Give a reason (SSS, SAS, AAS or RHS) and write a congruence statement (e.g. $\triangle ABC \equiv \triangle FGH$).

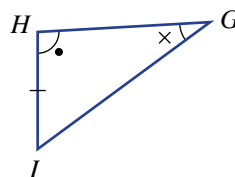
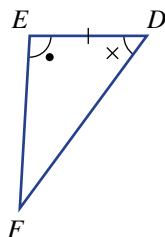
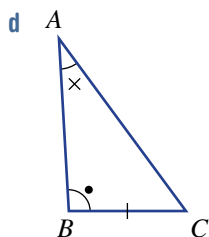
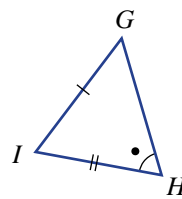
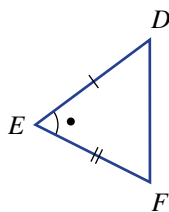
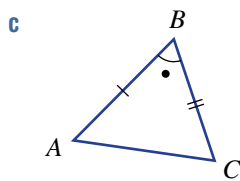
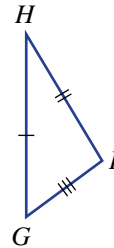
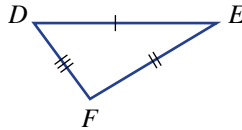
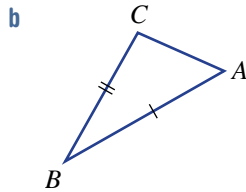
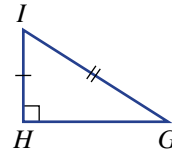
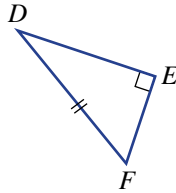
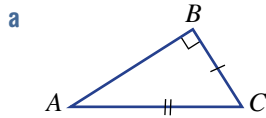

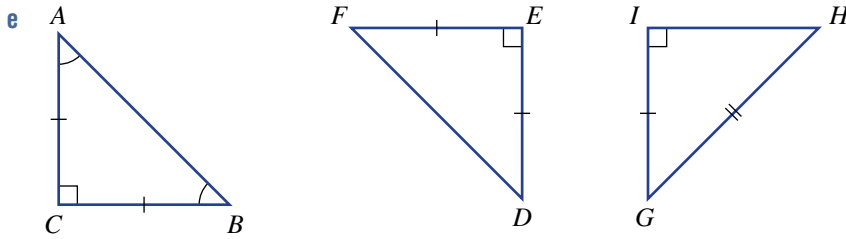

4 Identify all pairs of congruent triangles from those below. Angles with the same mark are equal.

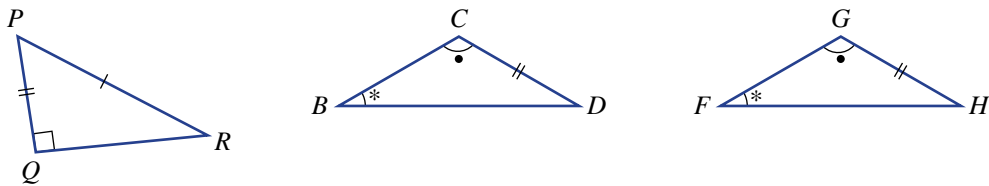
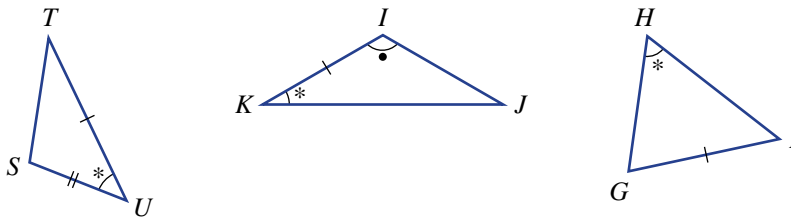
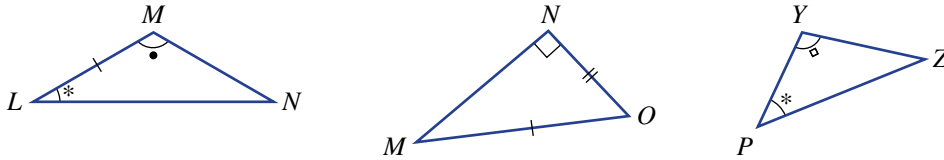
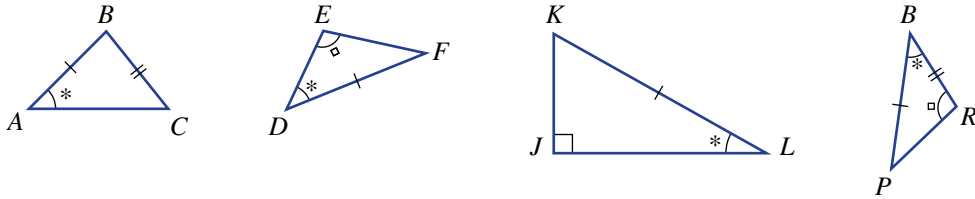

5 Use Pythagoras' theorem to help find the length BC in these pairs of congruent triangles.

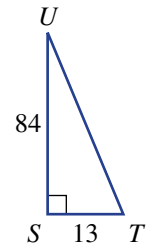
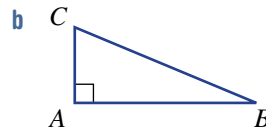
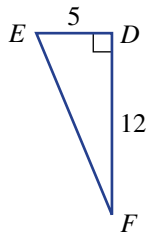
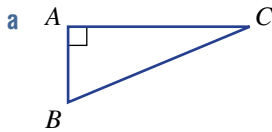

REASONING

6, 7

6–8

7–9

6 Are all triangles with three pairs of equal corresponding angles congruent? Explain why or why not.

7 Consider this diagram of two triangles.

- a Explain why there are two pairs of equal matching angles.
- b Give the reason (SSS, SAS, AAS or RHS) why there are two congruent triangles.

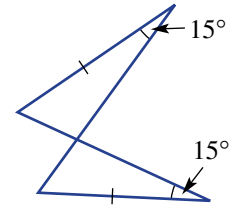

8 $ABCD$ is a parallelogram.

- a Give the reason why $\triangle ABC \equiv \triangle CDA$.
- b What does this say about $\angle B$ and $\angle D$?

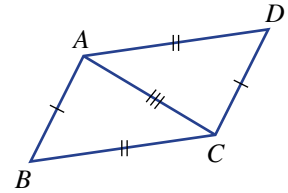

9 Consider the diagram shown at right.

- a Explain why there are two pairs of corresponding sides of equal length for the two triangles.
- b Give the reason (SSS, SAS, AAS or RHS) why there are two congruent triangles.
- c Write a congruence statement.
- d Explain why AC is perpendicular (90°) to DB .

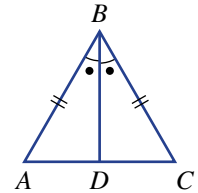

ENRICHMENT: Why not angle, side, side?

–

–

10

10 Angle, Side, Side (ASS) is not a test for congruence of triangles. Complete these tasks to see why.

- a Draw two line segments AB and EF both 5 cm long.
- b Draw two rays AG and EH so that both $\angle A$ and $\angle E$ are 40° .
- c Now place a point C on ray AG so that $BC = 4$ cm.
- d Place a point I on ray EH so that FI is 4 cm but place it in a different position so that $\triangle ABC$ is not congruent to $\triangle EFI$.
- e Show how you could use compasses to find the two different places you could put the points C or I so that BC and FI are 4 cm.

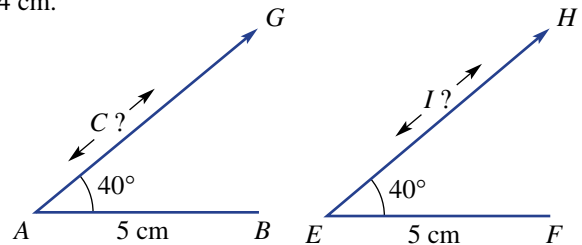

7E Using congruence in proof EXTENDING

LEARNING INTENTIONS

- To know how to layout the steps of a congruence proof with reasons and correct notation
- To be able to use established congruence to prove other geometrical properties

A mathematical proof is a sequence of correct statements that leads to a result. It should not contain any big ‘leaps’ and should provide reasons at each step. The proof that two triangles are congruent should list all the corresponding pairs of sides and angles. Showing that two triangles are congruent in more complex problems can then lead to the proof of other geometrical results.



Surveyors must take enough measurements to enable the calculation of every required length and angle. As polygons can be divided into triangles, surveyors use triangle congruence proofs to prove polygons are congruent.

Lesson starter: Complete the proof

Help complete the proof that $\triangle ABC \equiv \triangle EDC$ for this diagram. Give the missing reasons and congruent triangle in the final statement.

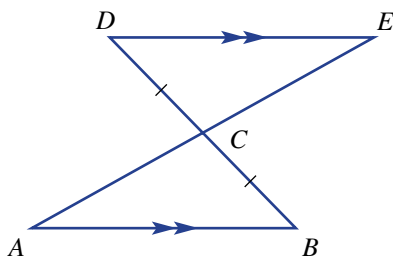

In $\triangle ABC$ and $\triangle EDC$:
 $\angle DCE = \angle BCA$ (_____)
 $\angle ABC = \angle EDC$ (_____)
 $BC = DC$ (given equal sides)
 $\therefore \triangle ABC \equiv$ _____ (AAS)

KEY IDEAS

- Prove that two triangles are congruent by listing all the known corresponding equal angles and sides.
 - Give reasons at each step.
 - Conclude by writing a congruence statement and the abbreviated reason (SSS, SAS, AAS or RHS).
 - Vertex labels are usually written in matching order.
- Other geometrical results can be proved by using the properties of congruent triangles.

BUILDING UNDERSTANDING

1 Name the line segment which is common to both triangles in each diagram.

a

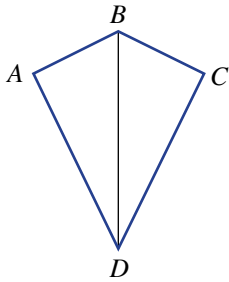

b

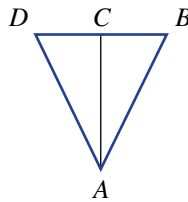

c

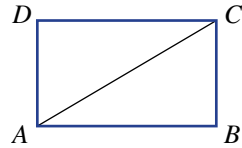

2 Why is $\triangle OAB$ an isosceles triangle in this circle? O is the centre of the circle.

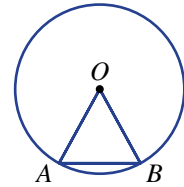

3 For this diagram name the angle which is:

- a vertically opposite to $\angle ACB$
- b alternate to $\angle CDE$
- c alternate to $\angle BAC$.

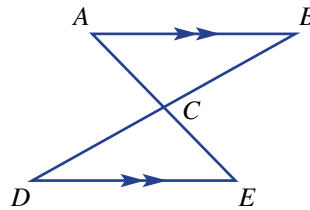

4 For this isosceles triangle, CM is common to $\triangle AMC$ and $\triangle BMC$.

- a Which congruence test would be used to prove that $\triangle AMC \cong \triangle BMC$?
- b Which angle in $\triangle BMC$ corresponds to $\angle AMC$ in $\triangle AMC$?

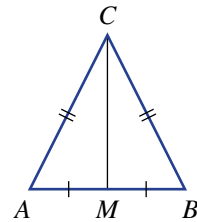

Example 11 Proving that two triangles are congruent

Prove that $\triangle ABC \cong \triangle ADC$.

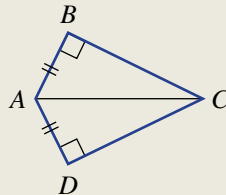

SOLUTION

In $\triangle ABC$ and $\triangle ADC$:

$\angle ABC = \angle ADC = 90^\circ$ (given equal angles) (**R**)

AC is common (**H**)

$AB = AD$ (given equal sides) (**S**)

$\therefore \triangle ABC \cong \triangle ADC$ (RHS)

EXPLANATION

Both triangles have a right angle.

AC is common to both triangles (hypotenuse).

AB and AD are marked as equal.

Write the congruence statement and the abbreviated reason. Write the vertex labels in matching order.

Now you try

Prove that $\triangle ABC \equiv \triangle EDC$.

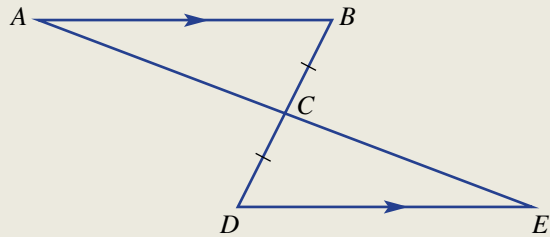
**Example 12 Proving geometrical results using congruence**

- a** Prove that $\triangle ABC \equiv \triangle EDC$.
b Hence prove that $AB \parallel DE$ (AB is parallel to DE).

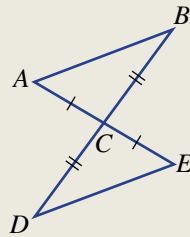
**SOLUTION**

- a** In $\triangle ABC$ and $\triangle EDC$:
 $AC = EC$ (given equal sides) (S)
 $BC = DC$ (given equal sides) (S)
 $\angle ACB = \angle ECD$ (vertically opposite angles) (A)
 $\triangle ABC \equiv \triangle EDC$ (SAS)
- b** $\angle BAC = \angle DEC$ (matching angles in congruent triangles)
 $\therefore AB \parallel DE$ (alternate angles are equal)

EXPLANATION

List the given pairs of equal length sides and the vertically opposite angles. The included angle is between the given sides, hence SAS.

All matching angles are equal.

If alternate angles are equal then AB and DE must be parallel.

Now you try

- a** Prove that $\triangle ABC \equiv \triangle ADC$.
b Hence prove that $\angle ABC = \angle ADE$
 (i.e. that a kite has one pair of opposite equal angles).

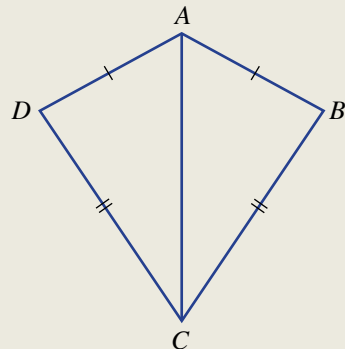

Exercise 7E

FLUENCY

1(1/2)

1(1/2)

1(1/3)

Example 11 1 Prove that each pair of triangles is congruent. List your reasons and give the abbreviated congruence test.

a

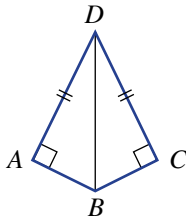

b

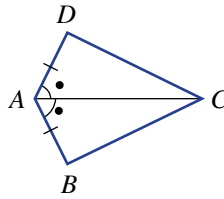

c

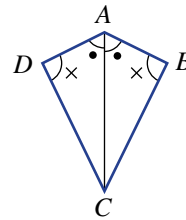

d

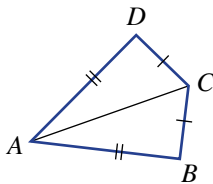

e

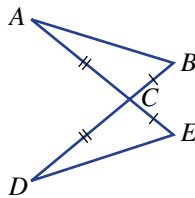

f

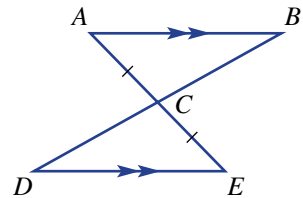

g

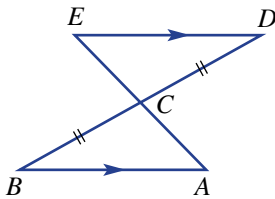

h

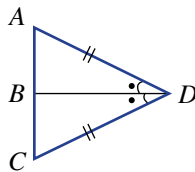

i

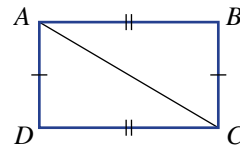

j

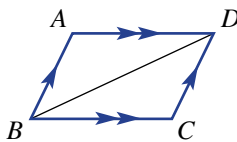

k

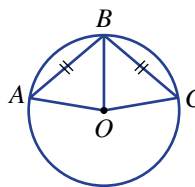

l

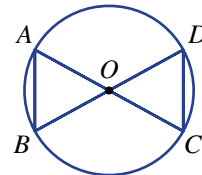

PROBLEM-SOLVING

2, 3

2-5

4-7

Example 12 2 a Prove $\triangle ABC \equiv \triangle EDC$.
b Hence, prove $AB \parallel DE$.

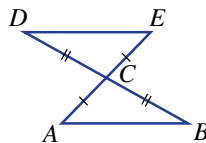

3 a Prove $\triangle ABE \equiv \triangle CBD$.
b Hence, prove $AE \parallel CD$.

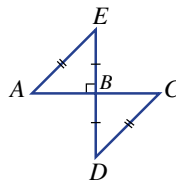

4 a Prove $\triangle ABD \equiv \triangle CDB$.
b Hence, prove $AD \parallel BC$.

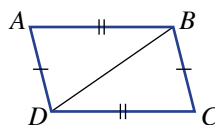

- 5 a Prove that $\triangle AOB \equiv \triangle DOC$. (O is the centre of the circle.)
 b Hence, prove that $AB \parallel CD$.

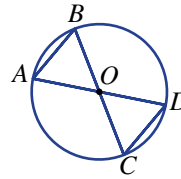

- 6 a Prove that $\triangle ABD \equiv \triangle CBD$.
 b Hence, prove that AC is perpendicular to BD . ($AC \perp BD$)

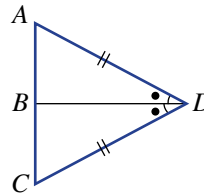

- 7 a Prove that $\triangle ABD \equiv \triangle CBD$.
 b Hence, prove that $\triangle ACD$ is isosceles.

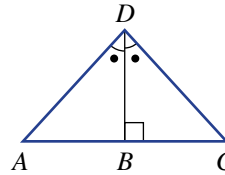

REASONING 8 8, 9 9–11

- 8 Use congruence to explain why $AD = BC$ and $AB = DC$ in this parallelogram.

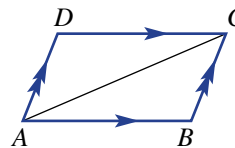

- 9 Use congruence to explain why OC is perpendicular to AB in this diagram. (*Hint*: Form triangles.)

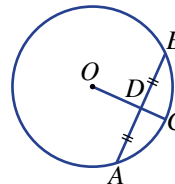

- 10 Use $\triangle ABE$ and $\triangle CDE$ to explain why $AE = CE$ and $BE = DE$ in this parallelogram (i.e. the diagonals bisect each other).

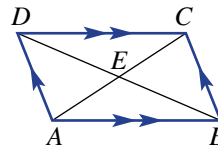

- 11 Use congruence to show that the diagonals of any rectangle are equal in length.

ENRICHMENT: Extended proofs – – 12, 13

- 12 $ABCD$ is a rhombus. To prove that AC bisects BD at 90° , follow these steps.

- a Prove that $\triangle ABE \equiv \triangle CDE$.
 b Hence prove that AC bisects BD at 90° .

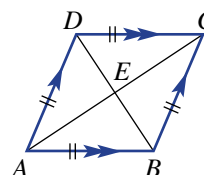

- 13 Use congruence to prove that the three angles in an equilateral triangle (given three equal side lengths) are all 60° .

7A

1 For an angle of size 53° determine the size of the:

- a complementary angle
- b supplementary angle.

7A

2 Find the value of x in each of these triangles.

a

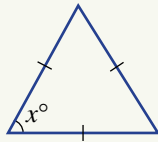

b

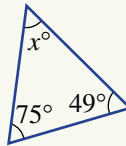

c

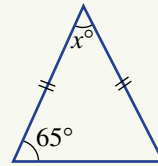

d

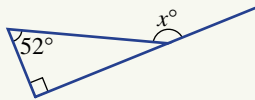

e

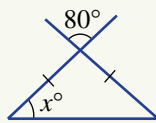

f

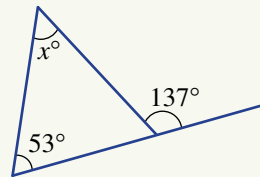

7B

3 Decide if each diagram contains a pair of parallel lines. Give a reason.

a

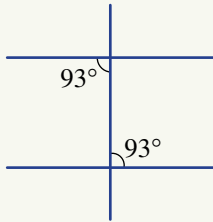

b

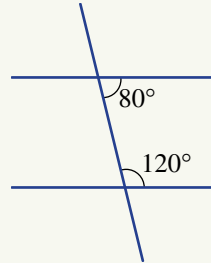

7B

4 Find the value of each pronumeral. Give reasons for your answer.

a

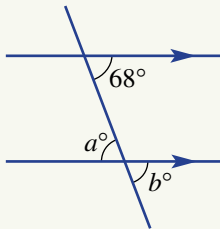

b

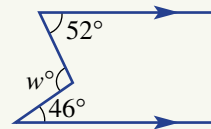

7C

5 Find the value of each pronumeral. Part d is regular.

a

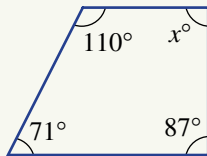

b

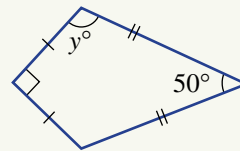

c

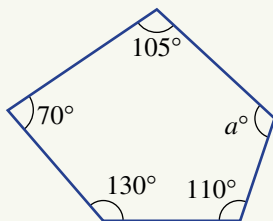

d

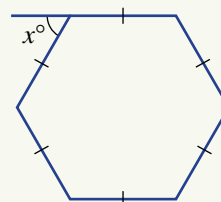

7D

6 Which congruency test could be used to prove these triangles are congruent?

a

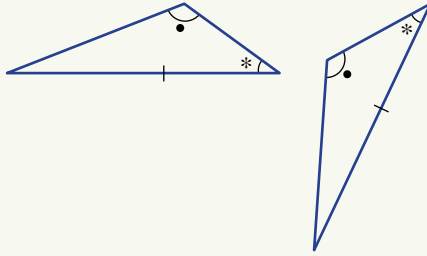

b

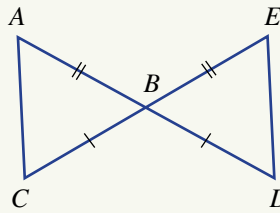

7E

7 Prove that triangle ABC is congruent to triangle ADC , hence prove that triangle ABD is isosceles.

Ext

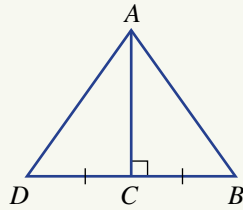

7E

8 Consider the diagram below.

Ext

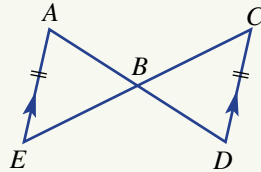

- a Prove that $\triangle ABE \cong \triangle DBC$.
- b If $\angle EAB$ is 62° , what is the size of angle BDC ?
- c If $AE = 7$ cm, find the length of the side CD .
- d If the area of triangle ABE is 21 cm^2 , what is the area of triangle DBC ?

7F Enlargement and similar figures

LEARNING INTENTIONS

- To know how to enlarge a figure using a scale factor and a centre of enlargement
- To understand the effect of applying a scale factor to enlarge a shape
- To know the meaning of the term similar figures
- To be able to find the scale factor between two similar figures
- To be able to use the scale factor to find the value of corresponding side lengths in similar figures

Similar figures have the same shape but not necessarily the same size. If two figures are similar then one of them can be enlarged or reduced so that it is identical (congruent) to the other. If a figure is enlarged by a scale factor greater than 1, the image will be larger than the original. If the scale factor is between 0 and 1, the image will be smaller.



A photo forms a similar image to the original, with all matching angles equal and matching lengths in the same ratio. Such as this photo of the Senanque Abbey, in fields of lavender, in southern France.

Lesson starter: Enlarging a kite

Mandy draws a kite design, then cuts out a larger shape to make the actual kite. The actual kite shape is to be similar to the design drawing. The 10 cm length on the drawing matches a 25 cm length on the kite.

- How should the interior angles compare between the drawing and the actual kite?
- By how much has the drawing been enlarged; that is, what is the scale factor?
Explain your method to calculate the scale factor.
- What length on the kite matches the 15 cm length on the drawing?

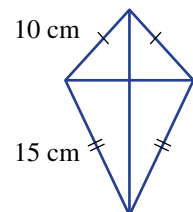

KEY IDEAS

- **Enlargement** is a transformation which involves the increase or decrease in size of an object.
 - The ‘shape’ of the object is unchanged.
 - Enlargement uses a **centre of enlargement** and an **enlargement factor** or **scale factor**.

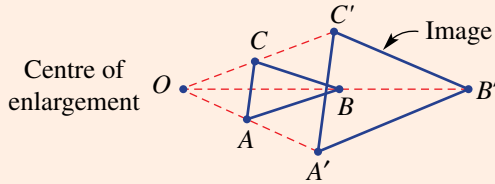

$$\text{Scale factor} \\ \frac{OA'}{OA} = \frac{OB'}{OB} = \frac{OC'}{OC}$$

- Two figures are **similar** if one can be enlarged to be congruent to the other.
 - Corresponding angles are equal.
 - Pairs of corresponding sides are in the same proportion or ratio.
- The **scale factor** = $\frac{\text{image length}}{\text{original length}}$.
 - If the scale factor is between 0 and 1, the image will be smaller than the original.
 - If the scale factor is greater than 1, the image will be larger than the original.
 - If the scale factor is equal to 1, the image will be congruent to the original.
- The symbols \parallel and \sim are used to describe similarity.
 - We can write $ABCD \parallel EFGH$ or $ABCD \sim EFGH$.
 - The letters are usually written in matching order.

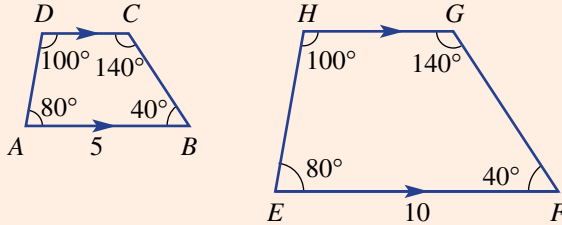

- Scale factor = $\frac{EF}{AB} = \frac{10}{5} = 2$.

BUILDING UNDERSTANDING

1 The two figures below are similar.

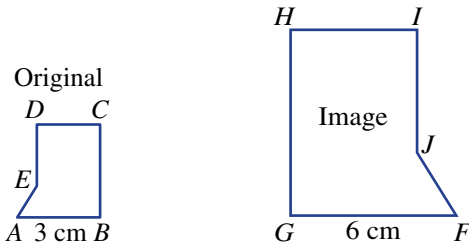

- Name the angle in the larger figure which corresponds to $\angle A$.
- Name the angle in the smaller figure which corresponds to $\angle I$.
- Name the side in the larger figure which corresponds to BC .
- Name the side in the smaller figure which corresponds to FJ .
- Use FG and AB to find the scale factor.

2 This diagram shows $\triangle ABC$ enlarged to give the image $\triangle A'B'C'$.

- Measure the lengths OA and OA' . What do you notice?
- Measure the lengths OB and OB' . What do you notice?
- Measure the lengths OC and OC' . What do you notice?
- What is the scale factor?
- Is $A'B'$ twice the length of AB ? Measure to check.

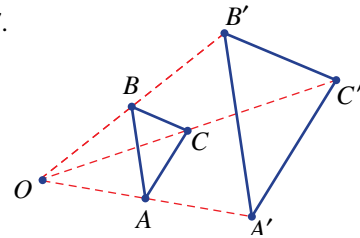

3 This diagram shows rectangle $ABCD$ enlarged (in this case reduced) to rectangle $A'B'C'D'$.

- Measure the lengths OA and OA' . What do you notice?
- Measure the lengths OD and OD' . What do you notice?
- What is the scale factor?
- Compare the lengths AD and $A'D'$. Is $A'D'$ one quarter of the length of AD ?

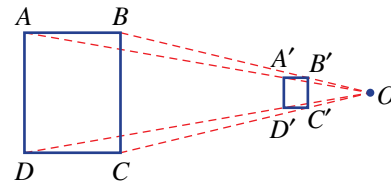

4 A square is enlarged by a scale factor of 4.

- Are the internal angles the same for both the original and the image?
- If the side length of the original square was 2 cm, what would be the side length of the image square?
- If the side length of the image square was 100 m, what would be the side length of the original square?

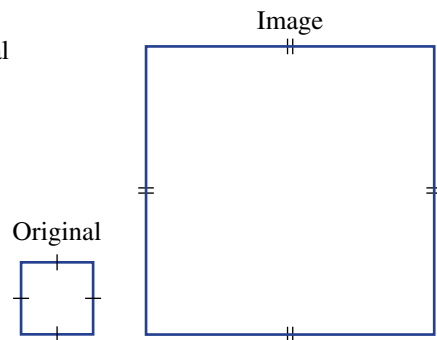



Example 13 Enlarging figures

Copy the given diagram using plenty of space. Use the given centre of enlargement (O) and these scale factors to enlarge $\triangle ABC$.

- Scale factor $\frac{1}{2}$
- Scale factor 3

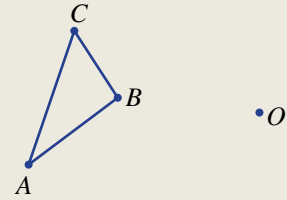

SOLUTION

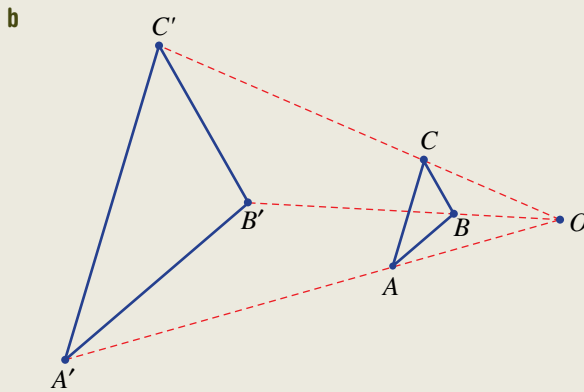
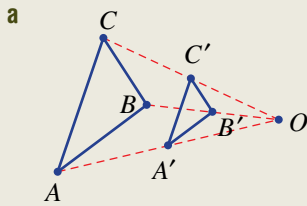

EXPLANATION

Connect dashed lines between O and the vertices A , B and C .

Since the scale factor is $\frac{1}{2}$, place A' so that OA' is half of OA .

Repeat for B' and C' . Join vertices A' , B' and C' .

Draw dashed lines from O through A , B and C . Place A' so that $OA' = 3OA$. Repeat for B' and C' and form $\triangle A'B'C'$.

Now you try

Copy the given diagram using plenty of space. Use the given centre of enlargement (O) and these scale factors to enlarge the shape.

- Scale factor 2
- Scale factor $\frac{2}{3}$

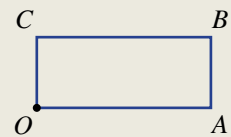



Example 14 Using the scale factor

These figures are similar.

- Find a scale factor.
- Find the value of x .
- Find the value of y .

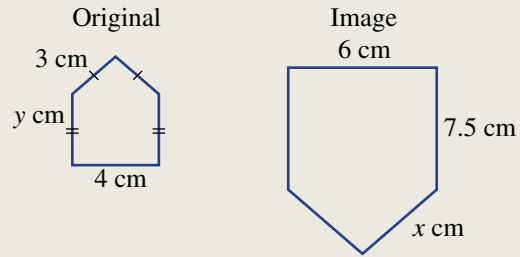

SOLUTION

- Scale factor = $\frac{6}{4} = 1.5$
- $x = 3 \times 1.5$
 $= 4.5$
- $y \times 1.5 = 7.5$
 $y = 7.5 \div 1.5$
 $= 5$

EXPLANATION

Choose two corresponding sides and use

$$\text{scale factor} = \frac{\text{image length}}{\text{original length}}$$

Multiply the side lengths on the original by the scale factor to get the length of the corresponding side on the image.

The corresponding side lengths are y cm and 7.5 cm. Divide the side lengths on the image by the scale factor to get the length of the corresponding side on the original.

Now you try

These figures are similar.

- Find a scale factor.
- Find the value of x .
- Find the value of y .

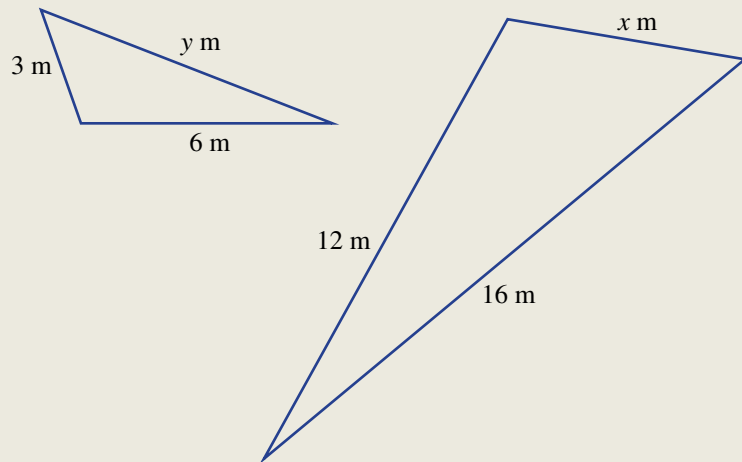

Exercise 7F

FLUENCY

1, 2, 3($\frac{1}{2}$)

1, 3($\frac{1}{2}$)

2, 3($\frac{1}{2}$)

Example 13

- 1 Copy the given diagram leaving plenty of space around it, then use the centre of enlargement (O) and the given scale factors to enlarge $\triangle ABC$.
- a Scale factor $\frac{1}{3}$ b Scale factor 2

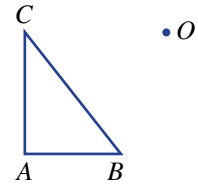

- 2 This diagram includes a square with centre O and vertices $ABCD$. Copy the diagram leaving plenty of space around it.

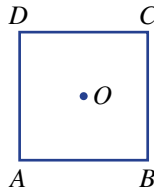

Enlarge square $ABCD$ by these scale factors and draw the image. Use O as the centre of enlargement.

- a $\frac{1}{2}$ b 1.5

Example 14

- 3 Each of the pairs of figures shown here are similar. For each pair, find:
- i a scale factor ii the value of x iii the value of y .

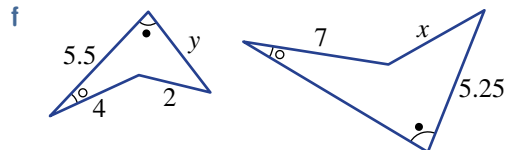
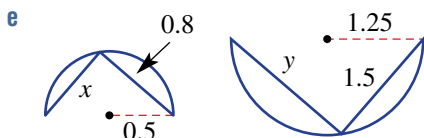
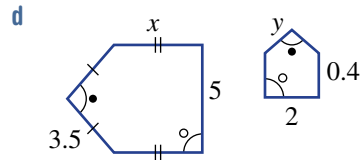
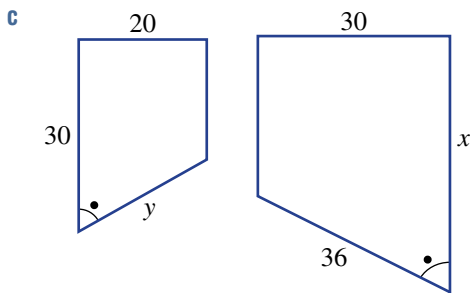
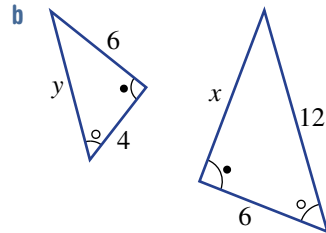
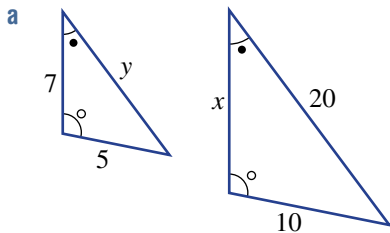

PROBLEM-SOLVING 4, 5 4(1/2), 5 5, 6

- 4 These diagrams show a shape and its image after enlargement. For each part, find:
- i the scale factor
 - ii the coordinates (x, y) of the centre of enlargement.

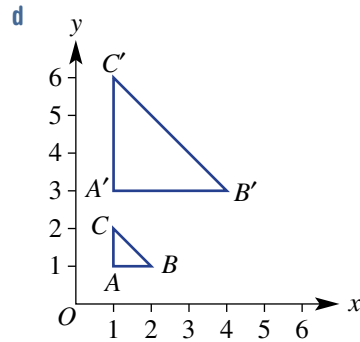
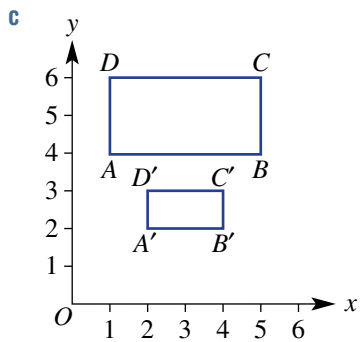
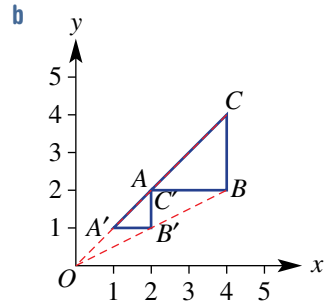
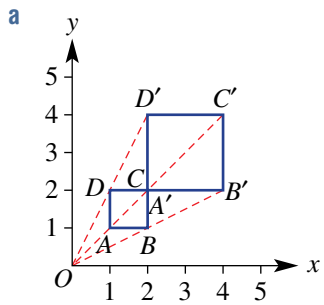

- 5 A person 1.8 m tall stands in front of a light that sits on the floor, and casts a shadow on the wall behind them. Form triangles to assist with the following questions.
- a How tall will the shadow be if the distance between the wall and the light is:
 - i 4 m?
 - ii 10 m?
 - iii 3 m?
 - b How tall will the shadow be if the distance between the wall and the person is:
 - i 4 m?
 - ii 5 m?
 - c Find the distance from the wall to the person if the height of the shadow is:
 - i 7.2 m
 - ii 4.5 m.

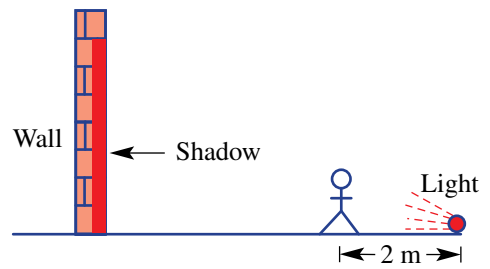

- 6 This truck is 12.7 m long.
- a Measure the length of the truck in the photo.
 - b Measure the height of the truck in the photo.
 - c Estimate the actual height of the truck.



REASONING

7, 8

7–9

8–10

- 7 A figure is enlarged by a scale factor of a where $a > 0$.
- For what values of a will the image be larger than the original figure?
 - For what values of a will the image be smaller than the original figure?
 - For what value of a will the image be congruent to the original figure?
- 8 Explain why:
- any two squares are similar
 - any two equilateral triangles are similar
 - any two rectangles are not necessarily similar
 - any two isosceles triangles are not necessarily similar.
- 9 An object is enlarged by a factor of k . What scale factor should be used to reverse this enlargement?
- 10 A map has a scale ratio of 1:50 000.
- What length on the ground is represented by 2 cm on the map?
 - What length on the map is represented by 12 km on the ground?



Enrichment: The Sierpinski triangle

–

–

11

- 11 The Sierpinski triangle shown is a mathematically generated pattern. It is created by repeatedly enlarging triangles by a factor of $\frac{1}{2}$.

The steps are listed below.

- Start with an equilateral triangle as in Figure 1.
- Enlarge the triangle by a factor $\frac{1}{2}$.
- Arrange three copies of the image as in Figure 2.
- Continue repeating steps 2 and 3 with each triangle.

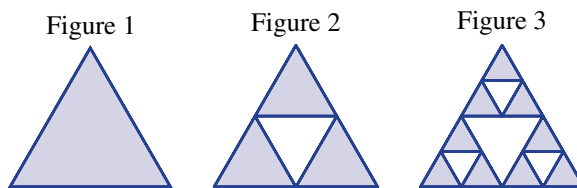
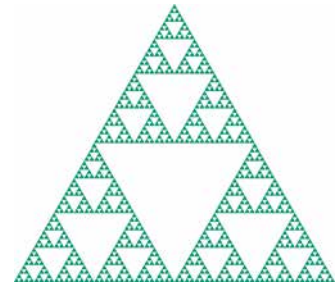

- Make a large copy of Figures 1 to 3 then draw the next two figures in the pattern.
- If the original triangle (Figure 1) had side length l , find the side length of the smallest triangle in:
 - Figure 2
 - Figure 3
 - Figure 8 (assuming Figure 8 is the 8th diagram in the pattern).
- What fraction of the area is shaded in:
 - Figure 2?
 - Figure 3?
 - Figure 6 (assuming Figure 6 is the 6th diagram in the pattern)?
- The Sierpinski triangle is one in which the process of enlargement and copying is continued forever. What is the area of a Sierpinski triangle?

The following problems will investigate practical situations drawing upon knowledge and skills developed throughout the chapter. In attempting to solve these problems, aim to identify the key information, use diagrams, formulate ideas, apply strategies, make calculations and check and communicate your solutions.

Beam support

- 1 An angled beam is supported by three equal length struts (AB , BC and CD) as shown. The left strut is connected at point A such that $OA = AB$.

An engineer is interested in finding the possible position of angled beams, that can be supported by struts positioned in such a way.

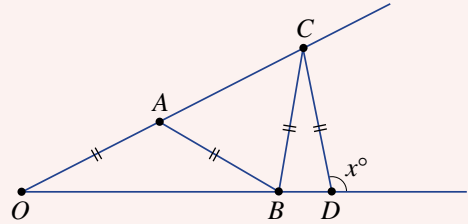

- Giving reasons, find the value of x if $\angle AOB$ is equal to:
 - 10°
 - 20°
- Find an expression for x if $\angle AOB = a^\circ$.
- Try drawing a diagram using $\angle AOB = 40^\circ$, labelling all angles. Describe the problem with the diagram if this angle is used.
- Find the maximum angle of the beam ($\angle AOB$) so that all the struts AB , BC and CD can be positioned in the way illustrated in the original diagram.
- What does your result from part **d** mean for the angle x ?

Track navigation

- 2 A beginner computer programmer is using a simple platform to create a computer game involving different race tracks.

After writing step-by-step commands for polygon-shaped tracks, the programmer wants to be able to write as few commands as possible by using loops to account for commands that are repeated.

The tracks will involve regular polygons in which a car placed on the track has to be programmed to do laps of the track.

- a** Consider the circuit shown, which is a regular triangle of side length 10 units. The car is placed at O facing in the direction of the track.

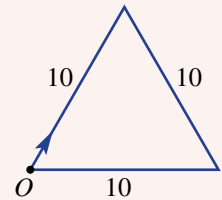

The programmed command that can be used to travel along the track is: 'Move x , y ', where x is the angle the car needs to first rotate in a clockwise direction so that it is facing in the direction of the track and y represents the distance to travel.

The first command is: Move 0, 10

Complete the final three instructions in the form 'Move __, __', so that the car completes one full circuit and finishes facing in the direction which it started.

- b** For the two regular tracks shown, give the set of commands needed to get a car to complete one full lap. Use a side length of 10 units.

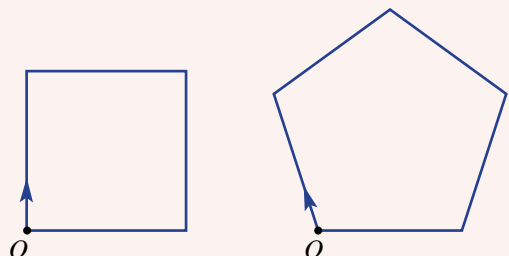

The programmer notices that the set of instructions can be simplified by using a loop of the form ‘Move x, y, z ’ for the repeating instructions, where z represents the number of times the command is repeated.

- c Use the ‘Move x, y, z ’ command to rewrite your commands to draw the square and pentagon above. Your first command needs to be ‘Move 0, 10, 1’.
- d Consider the sum of all the rotations used for each track. What do you notice?
- e Using your result for part d, complete the following set of commands to complete one lap of an n -sided regular polygon of side length 10 units. Check that your commands are correct for $n = 8$.
 Move 0, 10, 1
 Move ____, 10, ____
 Move ____, 10, 1

Truss bridges

- 3 Truss bridges use triangles as supports above or below the deck to increase the amount of weight a bridge can hold. Triangles are used for their strength as, unlike a parallelogram, when compressed they maintain their shape and spread the force evenly.

An engineering student is looking at the geometrical structure of different truss designs before simulating experiments to see how the different arrangements affect the weight the bridge can handle.

The following design is a Warren Truss, with repeating triangular sections across the bridge.

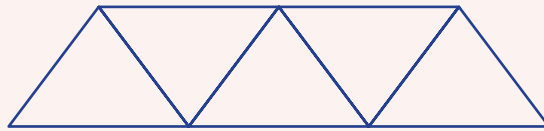

Consider the portion of the design shown at right, in which the four diagonals are of equal length.

- a Classify the type of triangles that have been formed.
- b Which test proves that triangles DAE , BEA and EBC are congruent?
- c Use the congruence of the triangles to prove that $AB \parallel DC$ and $AD \parallel BE$.

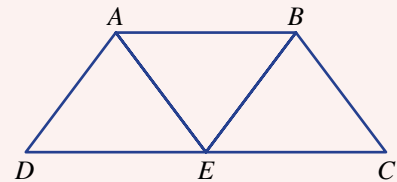

A Pratt Truss bridge involves further strengthening of the design by adding vertical supports from the vertex perpendicular to the base. The drawback of this design is the extra cost in materials.

- d How many congruent triangles have now been formed in this diagram? Give reasons why the smaller triangles formed in this bridge frame are all congruent.

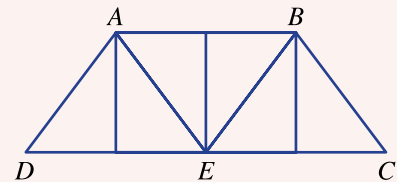

7G Similar triangles

LEARNING INTENTIONS

- To know the tests for similarity of triangles
- To be able to choose the appropriate test that proves two triangles are similar
- To be able to use the scale factor from similar triangles to find an unknown length

Many geometric problems can be solved by using similar triangles. Shadows, for example, can be used to determine the height of a tall mast when the shadows form the base of two similar triangles. Solving such problems first involves the identification of two triangles and an explanation as to why they are similar. As with congruence of triangles, there is a set of minimum conditions to establish similarity in triangles.

Lesson starter: Are they similar?

Each point below describes two triangles. Accurately draw each pair and decide if they are similar (same shape but of different size).

- $\triangle ABC$ with $AB = 2$ cm, $AC = 3$ cm and $BC = 4$ cm
 $\triangle DEF$ with $DE = 4$ cm, $DF = 6$ cm and $EF = 8$ cm
- $\triangle ABC$ with $AB = 3$ cm, $AC = 4$ cm and $\angle A = 40^\circ$
 $\triangle DEF$ with $DE = 6$ cm, $DF = 8$ cm and $\angle D = 50^\circ$
- $\triangle ABC$ with $\angle A = 30^\circ$ and $\angle B = 70^\circ$
 $\triangle DEF$ with $\angle D = 30^\circ$ and $\angle F = 80^\circ$
- $\triangle ABC$ with $\angle A = 90^\circ$, $AB = 3$ cm and $BC = 5$ cm
 $\triangle DEF$ with $\angle D = 90^\circ$, $DE = 6$ cm and $EF = 9$ cm

Which pairs are similar and why? For the pairs that are not similar, what measurements could be changed so that they are similar?



Similar triangle geometry is the basis of trigonometry and both methods are used by astronomers, navigators, builders, architects, engineers and surveyors. Calculating the height of K2 in Pakistan, Earth's second highest mountain, would involve trigonometry.

KEY IDEAS

- Two triangles are **similar** if:
 - corresponding angles are equal
 - corresponding sides are in proportion (the same ratio).
- The **similarity statement** for two similar triangles $\triangle ABC$ and $\triangle DEF$ is:
 - $\triangle ABC \parallel \triangle DEF$ or
 - $\triangle ABC \sim \triangle DEF$

Letters are usually written in matching order so AB corresponds to DE etc.

■ **Tests for similar triangles.** (Not to be confused with the congruence tests for triangles).

• Side, Side, Side (SSS)

All three pairs of corresponding sides are in the same ratio.

$$\frac{12}{6} = \frac{8}{4} = \frac{14}{7}$$

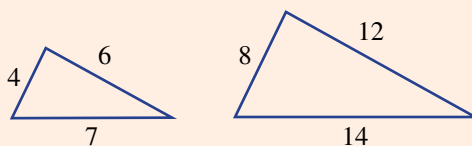

• Side, Angle, Side (SAS)

Two pairs of corresponding sides are in the same ratio and the included angle is equal.

$$\frac{22}{11} = \frac{10}{5}$$

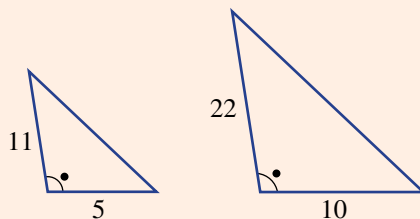

• Angle, Angle, Angle (AAA or AA)

All three corresponding angles are equal. (If there are two equal pairs then the third pair must be equal by the angle sum of a triangle.)

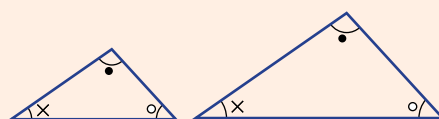

• Right angle, Hypotenuse, Side (RHS)

The hypotenuses of right-angled triangles and another corresponding pair of sides are in the same ratio.

$$\frac{15}{5} = \frac{6}{2}$$

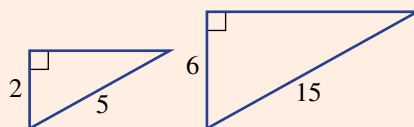

BUILDING UNDERSTANDING

1 These two triangles are similar.

a Which vertex on $\triangle DEF$ corresponds to (matches) vertex B on $\triangle ABC$?

b Which vertex on $\triangle ABC$ corresponds to (matches) vertex F on $\triangle DEF$?

c Which side on $\triangle DEF$ corresponds to (matches) side AC on $\triangle ABC$?

d Which side on $\triangle ABC$ corresponds to (matches) side EF on $\triangle DEF$?

e Which angle on $\triangle ABC$ corresponds to (matches) $\angle D$ on $\triangle DEF$?

f Which angle on $\triangle DEF$ corresponds to (matches) $\angle B$ on $\triangle ABC$?

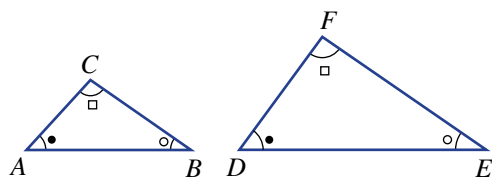

2 What is the scale factor on this pair of similar triangles which enlarges $\triangle ABC$ to $\triangle DEF$?

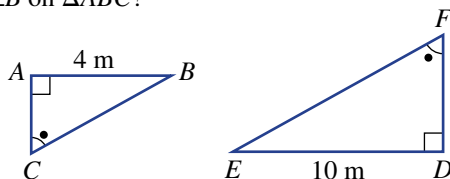

3 State the missing terms to complete the following sentences.

a The abbreviated tests for similar triangles are SSS, _____, _____ and _____.

b Similar figures have the same _____ but are not necessarily the same _____.



Example 15 Choosing a similarity test for triangles

Choose the similarity test which proves that these pairs of triangles are similar.

a

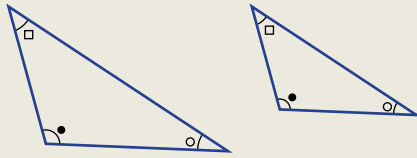

b

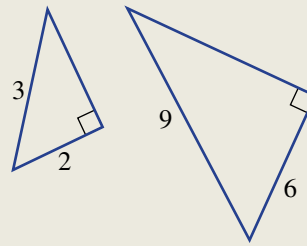

c

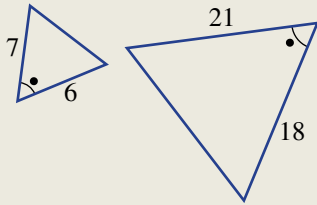

d

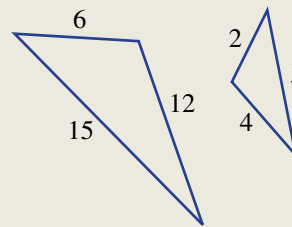

SOLUTION

a AAA

b RHS

c SAS

d SSS

EXPLANATION

Three pairs of angles are equal.

Both are right-angled triangles and the hypotenuses and another pair of sides are in the same ratio ($\frac{9}{3} = \frac{6}{2}$).

Two pairs of corresponding sides are in the same ratio ($\frac{21}{7} = \frac{18}{6}$) and the included angles are equal.

Three pairs of corresponding sides are in the same ratio ($\frac{15}{5} = \frac{12}{4} = \frac{6}{2}$).

Now you try

Choose the similarity test which proves that these pairs of triangles are similar.

a

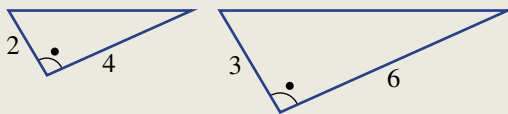

b

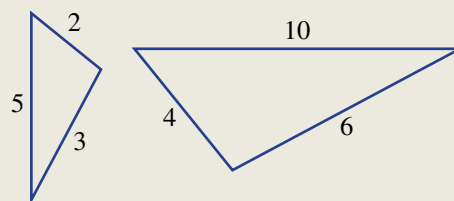

c

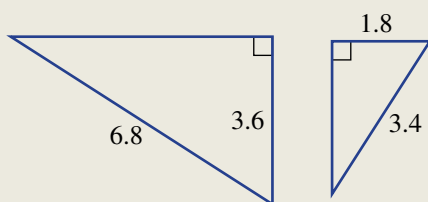

d

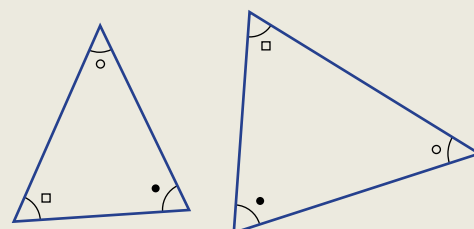



Example 16 Finding a missing length using similarity

For this pair of triangles:

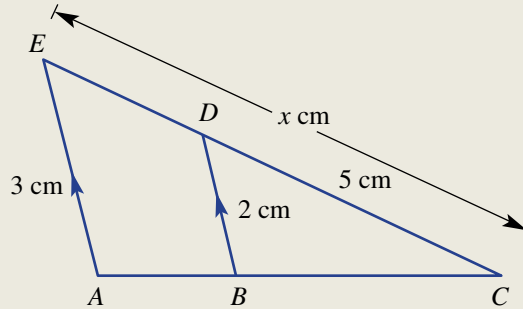

- give a reason (SSS, SAS, AAA or RHS) why the two triangles are similar
- find the value of x .

SOLUTION

- AAA or just AA.

- Scale factor $= \frac{3}{2} = 1.5$
 $\therefore x = 5 \times 1.5$
 $= 7.5$

EXPLANATION

$\angle EAC = \angle DBC$ since EA is parallel to BD and $\angle C$ is common to both triangles. (Also $\angle AEC = \angle BDC$ since EA is parallel to BD).

$$\frac{AE}{BD} = \frac{3}{2}.$$

Multiply CD by the scale factor to find the length of the corresponding side CE .

Now you try

For this pair of triangles:

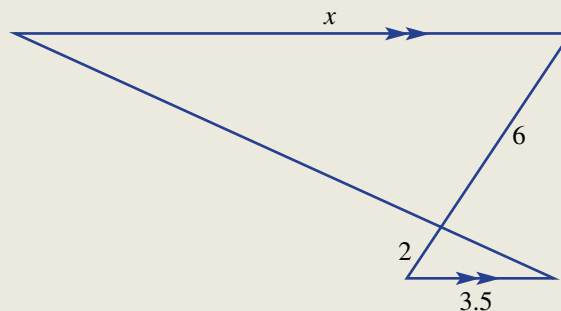

- give a reason (SSS, SAS, AAA or RHS) why the two triangles are similar
- find the value of x .

Exercise 7G

FLUENCY

1–4

1–2($\frac{1}{2}$), 3, 5

1–2($\frac{1}{2}$), 3, 5, 6

Example 15

1 Choose the similarity test which proves that these pairs of triangles are similar.

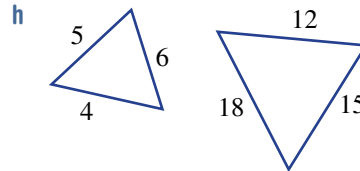
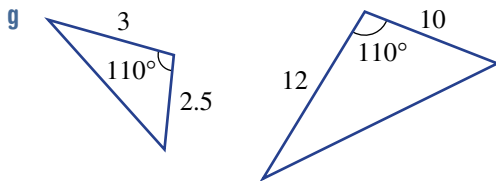
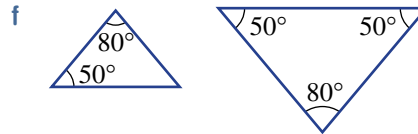
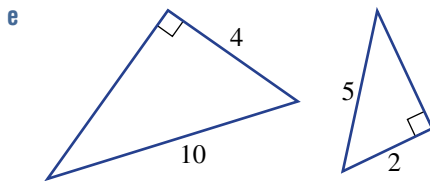
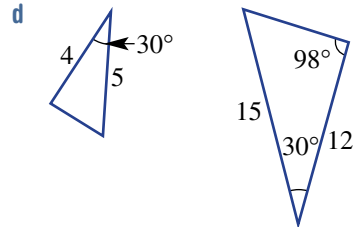
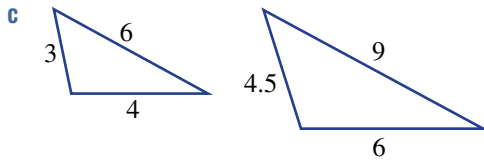
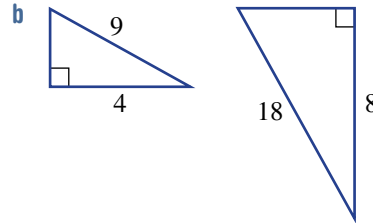
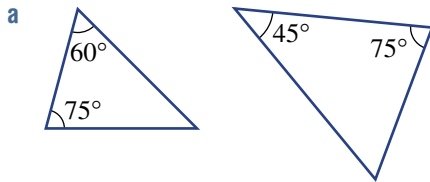

2 Write similarity statements for these pairs of similar triangles. Write letters in matching order.

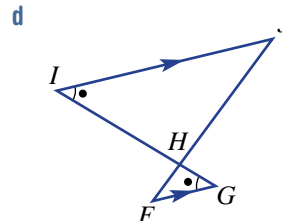
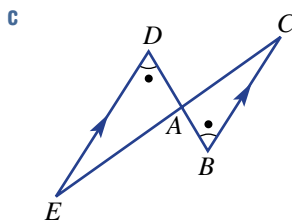
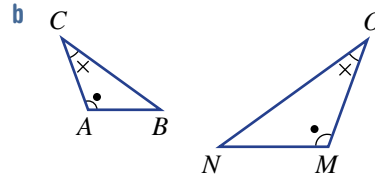
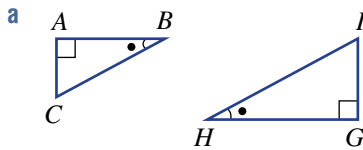

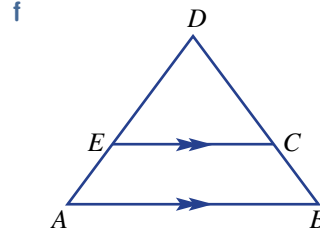
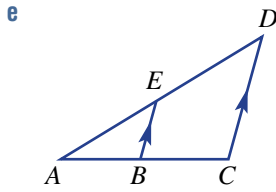

Example 16

3 For this pair of triangles:

- a give a reason (SSS, SAS, AAA or RHS) why the two triangles are similar
- b find the value of x .

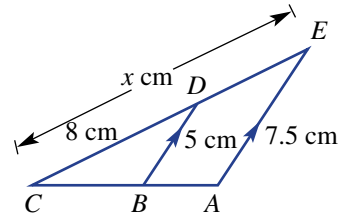

4 For this pair of triangles:

- a give a reason (SSS, SAS, AAA or RHS) why the two triangles are similar
- b find the value of x .

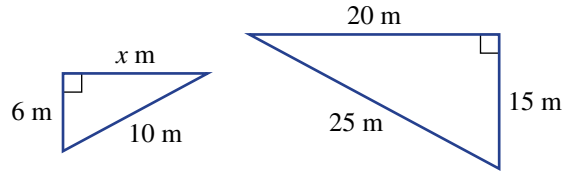

5 These pairs of triangles are similar. For each pair find:

- i the enlargement factor (scale factor) which enlarges the smaller triangle to the larger triangle
- ii the value of x .

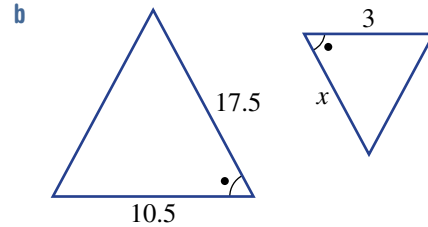
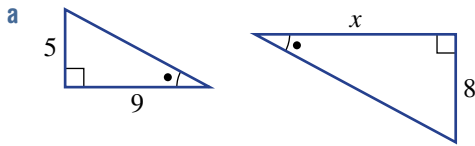

6 For this pair of triangles:

- a give a reason (SSS, SAS, AAA or RHS) why the two triangles are similar
- b find the value of x .

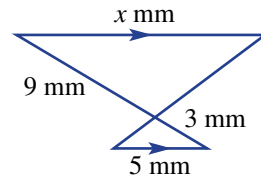

PROBLEM-SOLVING

7

7, 8

7-9

7 For each pair of similar triangles:

- i give a reason (SSS, SAS, AAA or RHS) why the two triangles are similar
- ii find the value of x .

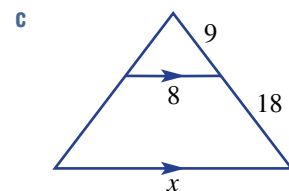
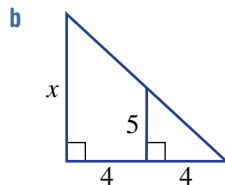
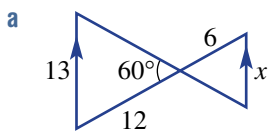

8 Find the value of x in these triangles.

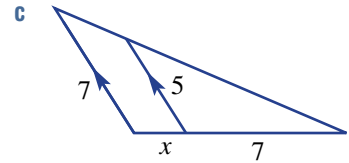
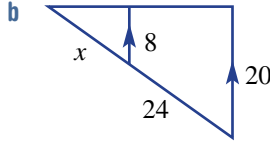
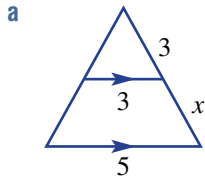

9 Name the triangle which is not similar to the other two in each group of three triangles.

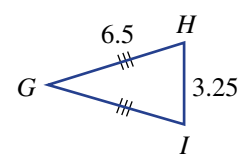
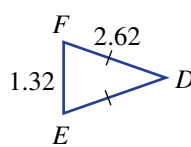
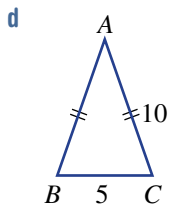
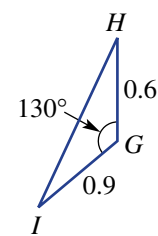
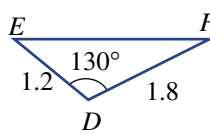
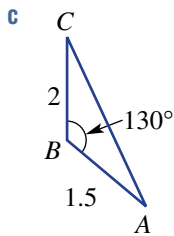
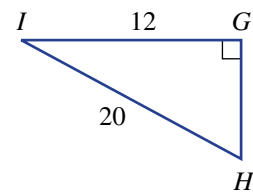
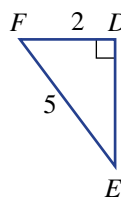
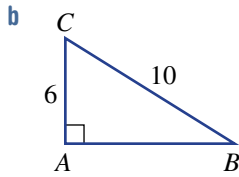
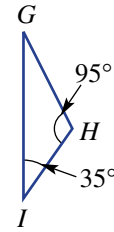
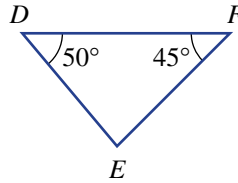
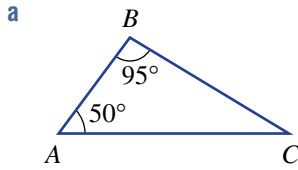

REASONING

10, 11

10-12

11-13

10 Give reasons why these two triangles are similar.

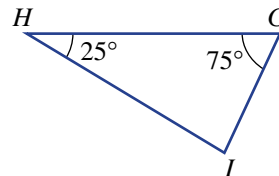
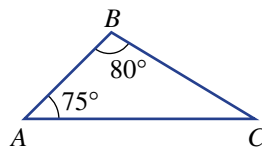

11 Give reasons why the two triangles in these diagrams are not similar.

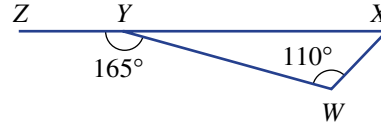
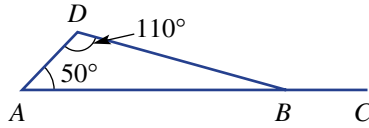

12 When two intersecting transversals join parallel lines, two triangles are formed. Explain why these two triangles are similar.

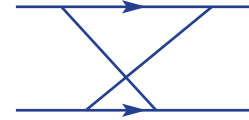

13 The four tests for similarity closely resemble the tests for congruence. Which similarity test closely matches the AAS congruence test? Explain the difference.

ENRICHMENT: Area and volume ratio

14

14 Consider these four similar triangular prisms (not drawn to scale).

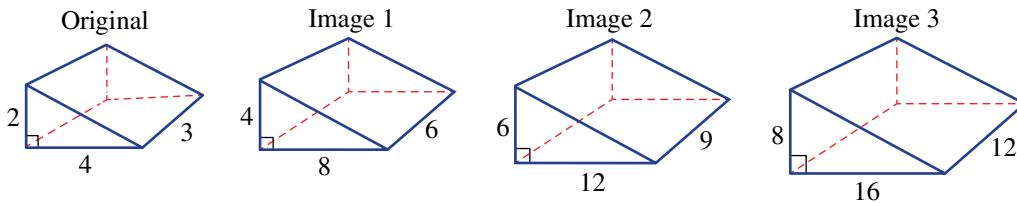

a Complete this table.

Triangle	Original	Image 1	Image 2	Image 3
Length scale factor	1	2		
Area (cross-section)				
Area scale factor	1			
Volume				
Volume scale factor	1			

b What do you notice about the area scale factor compared to the length scale factor?

c What would be the area scale factor if the length scale factor is n ?

d What would be the area scale factor if the length scale factor is:

i 10?

ii 20?

iii 100?

e What would be the area scale factor if the length scale factor is $\frac{1}{2}$?

f What do you notice about the volume scale factor compared to the length scale factor?

g What would be the volume scale factor if the length scale factor is n ?

h What would be the volume scale factor if the length scale factor is:

i 5?

ii 10?

iii $\frac{1}{2}$?

7H Proving and applying similar triangles

LEARNING INTENTIONS

- To be able to prove a pair of triangles is similar giving reasons
- To be able to identify a pair of similar triangles in a practical problem
- To know how to use similarity to solve a problem

Similar triangles can be used in many mathematical and practical problems. If two triangles are proved to be similar, then the properties of similar triangles can be used to find missing lengths or unknown angles. The approximate height of a tall object, or the width of a projected image, for example, can be found using similar triangles.



Similar triangles can be used to verify the height, 828 m, of the world's tallest building, the Burj Khalifa, Dubai. The Jeddah Tower, Saudi Arabia, is expected to be over 1 km tall when constructed.

Lesson starter: How far is the rock?

Ali is at the beach and decides to estimate how far an exposed rock is from seashore. He places four pegs in the sand as shown and measures the distance between them.

- Why do you think Ali has placed the four pegs in the way that is shown in the diagram?
- Why are the two triangles similar? Which test (SSS, SAS, AAA or RHS) could be used and why?
- How would Ali use the similar triangles to find the distance from the beach to peg A to the rock?

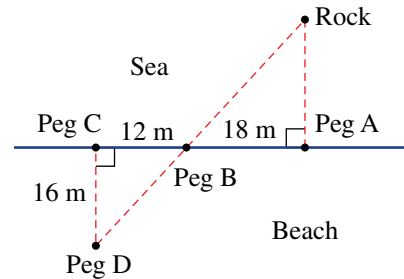

KEY IDEAS

- To prove triangles are similar, list any pairs of corresponding equal angles or pairs of sides in a given ratio.
 - Give reasons at each step.
 - Write a similarity statement, for example, $\triangle ABC \parallel \triangle DEF$ or $\triangle ABC \sim \triangle DEF$.
 - Write the triangle similarity test in abbreviated form (SSS, SAS, AAA or RHS).
- To apply similarity in practical problems, follow these steps.
 - Prove two triangles are similar.
 - Find a scale factor.
 - Use the scale factor to find the value of any unknowns.

BUILDING UNDERSTANDING

- 1 In this diagram, name the angle which is common to both $\triangle ACE$ and $\triangle BCD$.

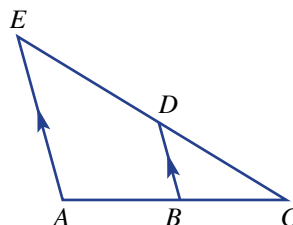

- 2 In this diagram:
 a name the pair of vertically opposite angles
 b name the two pairs of equal alternate angles.

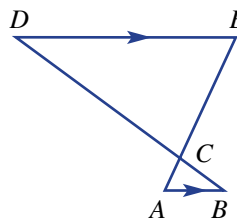

- 3 In this diagram:
 a name the angle which is common for the two triangles
 b name the side that corresponds to side
 i DC ii AE

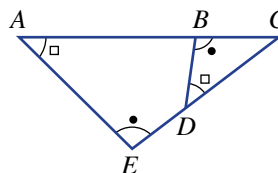

Example 17 Proving two triangles are similar

Prove that each pair of triangles is similar.

a

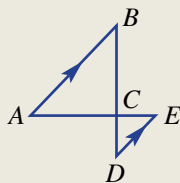

b

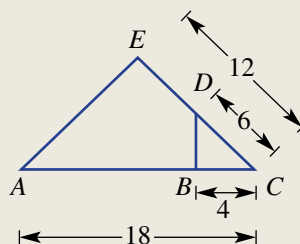

SOLUTION

- a $\angle BAC = \angle DEC$
 (alternate angles and $DE \parallel AB$)
 $\angle ABC = \angle EDC$
 (alternate angles and $DE \parallel AB$)
 $\angle ACB = \angle ECD$
 (vertically opposite angles)
 $\therefore \triangle ABC \sim \triangle DEC$ (AAA)

EXPLANATION

Parallel lines cut by a transversal will create a pair of equal alternate angles.
 Vertically opposite angles are also equal. Write the similarity statement and the abbreviated reason.

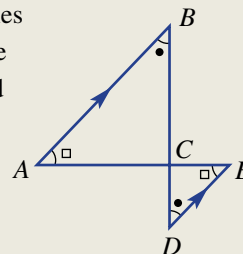

Continued on next page

b $\angle ACE = \angle DCB$ (common)

$$\frac{AC}{DC} = \frac{18}{6} = 3$$

$$\frac{EC}{BC} = \frac{12}{4} = 3 = \frac{AC}{DC}$$

$\therefore \triangle ACE \parallel \triangle DCB$ (SAS)

Redraw triangles to align corresponding sides.

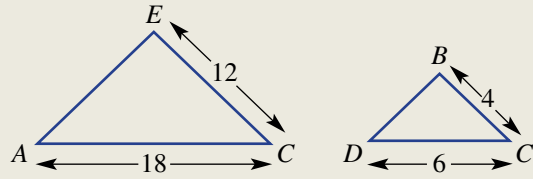

Note that there is a common angle and two pairs of corresponding sides. Find the scale factor for both pairs of sides to see if they are equal. Complete the proof with a similarity statement. The angle is the included angle.

Now you try

Prove that each pair of triangles is similar.

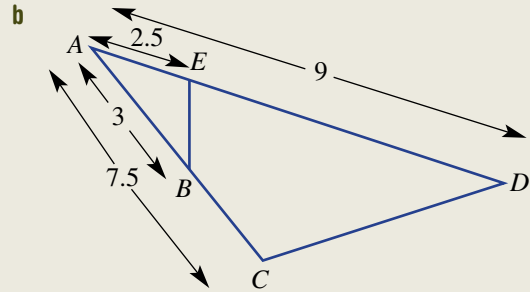
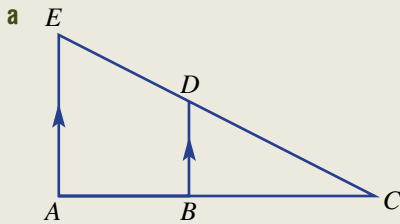

Example 18 Applying similarity

Chris' shadow is 1.2 m long when a 1 m vertical stick has a shadow 0.8 m long.

- a** Give a reason why the two triangles are similar.
b Determine Chris' height.

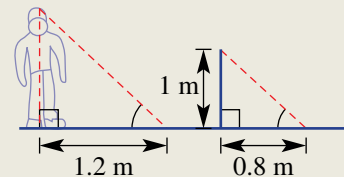

SOLUTION

a All angles are the same (AAA).

b Scale factor = $\frac{1.2}{0.8} = 1.5$
 \therefore Chris' height = 1×1.5
 $= 1.5$ m

EXPLANATION

The sun's rays will pass over Chris and the stick and hit the ground at approximately the same angle.

First find the scale factor.

Multiply the height of the stick by the scale factor to find Chris' height.

Now you try

Four pegs A, B, C and D are placed on one side of a road as shown.

- a Give a reason why the two triangles are similar.
- b Determine the distance across the road, DE .

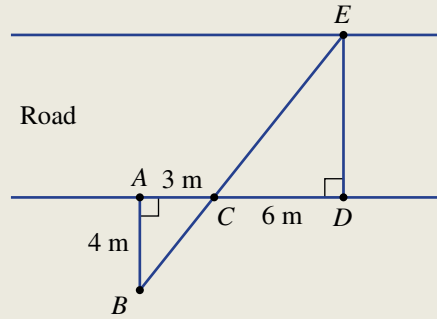

Exercise 7H

FLUENCY

1, 2

1(1/2), 2

1-2(1/2)

Example 17a

- 1 Prove that each pair of triangles is similar.

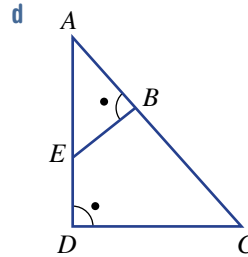
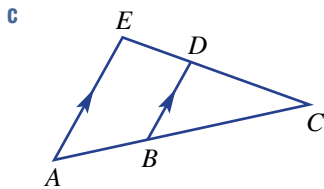
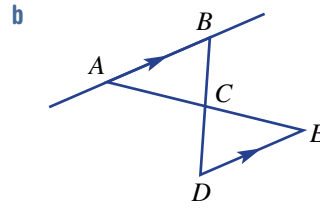
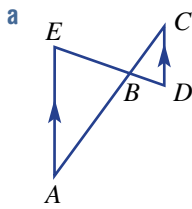

Example 17b

- 2 Prove that each pair of triangles is similar.

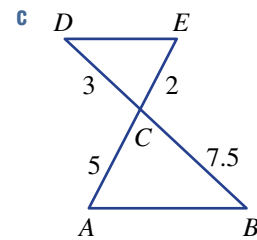
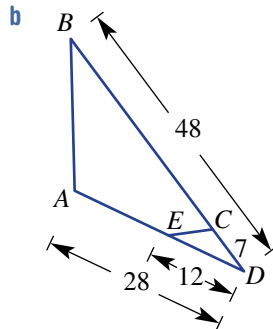
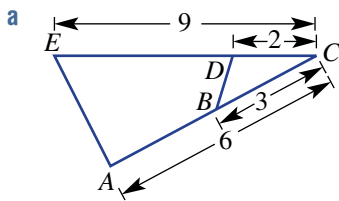

PROBLEM-SOLVING

3, 5, 6

3, 4, 6, 7

5–8

Example 18

- 3 A tree's shadow is 20 m long, while a 2 m vertical stick has a shadow 1 m long.
 a Give a reason why the two triangles formed by the objects and their shadows are similar.
 b Find the height of the tree.

- 4 Two cables support a steel pole at the same angle as shown. The two cables are 4 m and 10 m in length, and the shorter cable reaches 3 m up the pole.
 a Give a reason why the two triangles are similar.
 b Find the height of the pole.

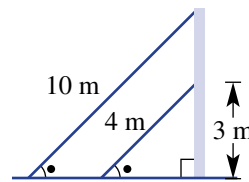

- 5 John stands 6 m from a vertical lamp post and casts a 2 m shadow. The shadow from the lamp post and from John end at the same place. Determine the height of the lamp post if John is 1.5 m tall.

- 6 Joanne wishes to determine the width of a river without crossing it. She places four pegs as shown. Calculate the width of the river.

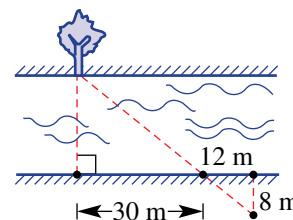

- 7 A deep chasm has a large rock sitting on one side as shown. Find the width of the chasm.

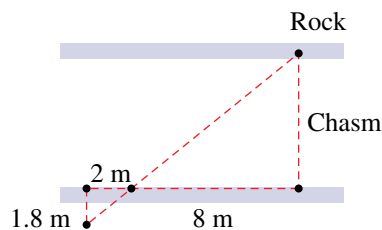

- 8 Find the length AB in this diagram if the two triangles are similar.

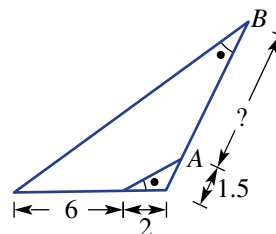

REASONING

9

9

9, 10

- 9 In this diagram, $\triangle ADC$ is isosceles.
 a There are two triangles which are similar. Identify them and complete a proof. You may need to find another angle first.
 b Find the lengths DC and CB expressing your answers as fractions.

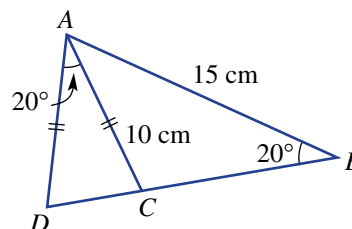

10 In this diagram, AC is perpendicular to BD and $\triangle ABD$ is a right angle.

- a Prove that $\triangle ABD$ is similar to:
- i $\triangle CBA$
 - ii $\triangle CAD$
- b Find these lengths:
- i BD
 - ii AC
 - iii AB

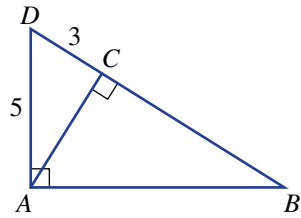

ENRICHMENT: Extended proofs 11

11 a Prove $AE = 4AC$.

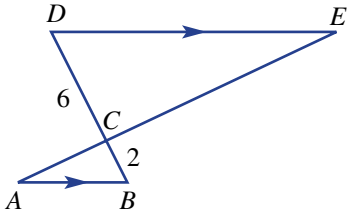

b Prove $BC = \frac{1}{2}CE$.

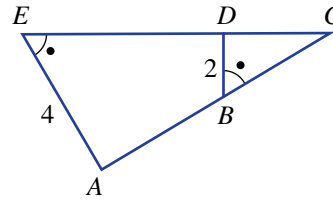

c Prove $CE = \frac{7}{5}CD$.

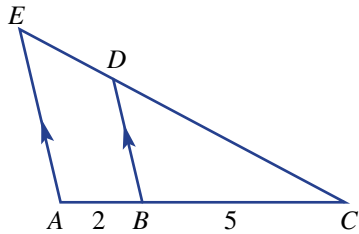

d Prove $AB = 3BC$.

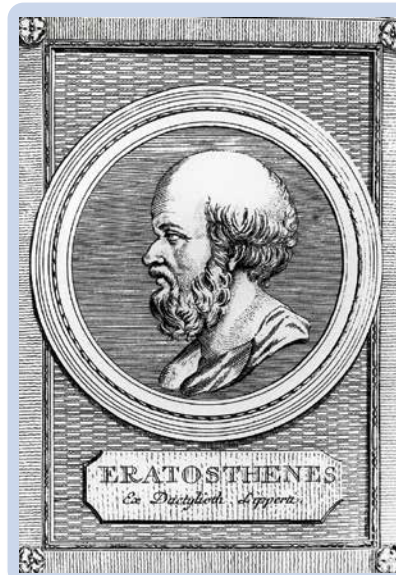
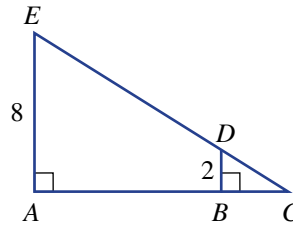

Eratosthenes was a Greek mathematician, geographer and astronomer who, around 240 BCE, used similar triangles to quite accurately calculate Earth's circumference.

Ocean ironman

The organisers of an ironman race want to estimate the distance from the beach to a floating buoy in the sea. Flags are placed on the beach by the organisers in an effort to create similar triangles as shown. The flag positions are at points A , C , D and E and the line segments AB and DE are assumed to be at right angles to the beach.

Present a report for the following tasks and ensure that you show clear mathematical workings and explanations where appropriate.

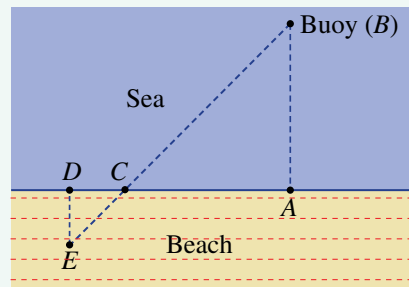

Preliminary task

One of the organisers measures the following:

- $AC = 200$ metres
 - $CD = 5$ metres
 - $DE = 4$ metres.
- a Find the scale factor between the two similar triangles.
 - b Hence, estimate the distance from the beach to the buoy.

Modelling task

- | | |
|---------------------|--|
| Formulate | <ol style="list-style-type: none"> a The problem is to determine the distance between the beach and the buoy using similar triangles. Write down all the relevant information that will help solve this problem with the aid of a diagram. b Explain why the given positions of the flags form a pair of similar triangles. |
| Solve | <ol style="list-style-type: none"> c Two more attempts at positioning flags and measuring distances are undertaken by the organisers. Jimmy's placement: <ul style="list-style-type: none"> • $AC = 360$ metres • $CD = 8$ metres • $DE = 3$ metres. Olivia's placement: <ul style="list-style-type: none"> • $AC = 90$ metres • $CD = 5$ metres • $DE = 8$ metres. <ol style="list-style-type: none"> i Use Jimmy's model to estimate the distance between the beach and the buoy. ii Use Olivia's model to estimate the distance between the beach and the buoy. |
| Evaluate and verify | <ol style="list-style-type: none"> d Another organiser attempts to place the flags such that: <ul style="list-style-type: none"> • $AC = 100$ metres • $CD = 50$ centimetres • $DE = 1.2$ metres. Do you think that arranging the flags in this way is a good idea? Explain why. e If the actual distance from the beach to the buoy is 200 metres, determine an arrangement for the flags that would deliver the correct distance. Illustrate with a diagram including the measurements. |
| Communicate | <ol style="list-style-type: none"> f Summarise your results and describe any key findings. |

Extension questions

- a Another way to arrange the flags is to use the model shown here. Using this model, identify the pair of similar triangles and explain why they are similar.
- b Using the following measurements, estimate the distance from the beach to the buoy.
 - $AC = 100$ metres
 - $AE = 60$ metres
 - $DE = 140$ metres
- c Compare the two models studied in this task using the different diagrams. Do you have a preferred model? Explain why.

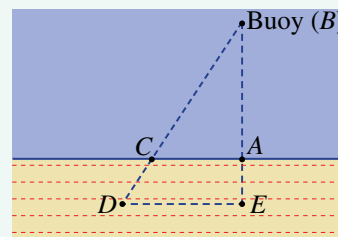

Geometric bisection

Key technology: Dynamic geometry

To generate drawings with a high degree of accuracy it is important not just to rely on guess work or trial and error. Instead, we use construction techniques using the properties of lines and shapes to pinpoint positions accurately. These construction techniques could be achieved using a pair of compasses, pencil and ruler; however, dynamic geometry software could also be used with the added benefit that points in the construction can be dragged to test multiple cases.



1 Getting started

We will start by considering constructing the perpendicular bisector of a line segment. Use dynamic geometry like Desmos to complete the following.

- Construct a line segment AB .
- Construct a circle with centre A and radius AB and a circle with centre B and radius AB .
- Construct points C and D at the intersection of the circles.
- Construct CD , which is the perpendicular bisector of AB , and the point M , which is the midpoint of AB .
- Check that your construction is correct by dragging either of points A or B . The segment CD should move with the construction as the perpendicular bisector of AB .

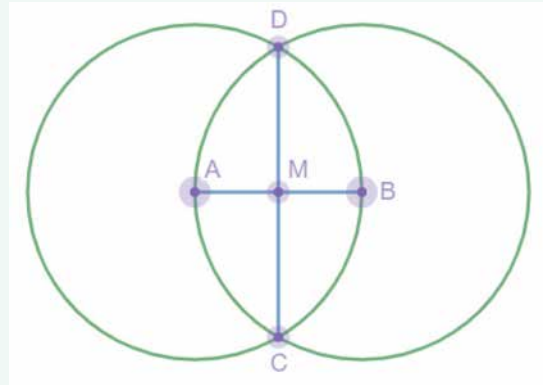

2 Using technology

- Use dynamic geometry to construct the following. The given diagrams will provide clues as to how to complete the construction.
 - Equilateral triangle
 - Isosceles triangle

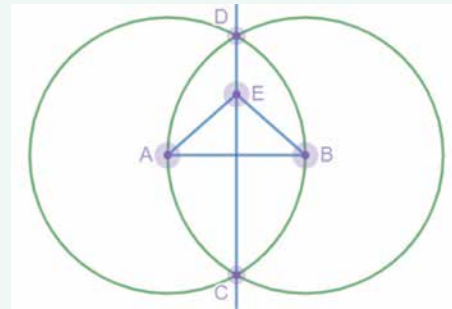
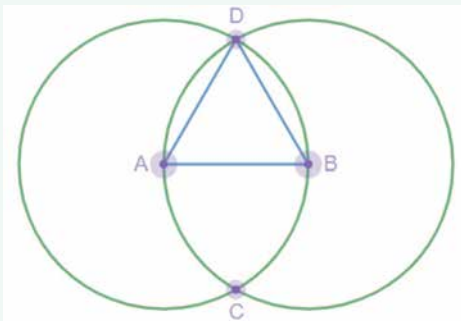

iii Angle bisector

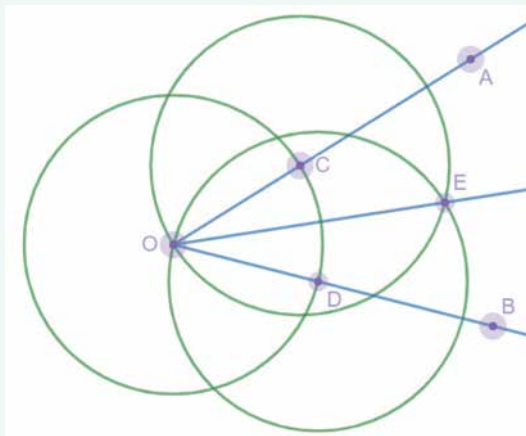

iv Perpendicular line

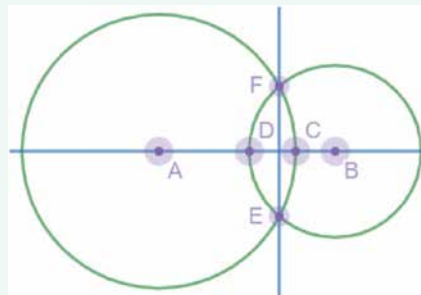

- b** For each of the above constructions, drag one of the initial points to see if the properties of the construction are retained. For the angle bisector, for example, the ray OE should always bisect the angle AOB when point A is dragged.

3 Applying an algorithm

- a** Choose one of the constructions above and write a simple algorithm (sequence of steps) which tells the user how to create the construction in the correct order.
- b** Follow this algorithm to construct a square. The special tool 'Perpendicular line' inside the dynamic geometry software is used.
- Step 1: Construct segment AB.
 - Step 2: Construct lines perpendicular to AB passing through A and perpendicular to AB passing through B.
 - Step 3: Construct the circle with centre A and radius AB.
 - Step 4: Construct point C.
 - Step 5: Construct the line perpendicular to AC passing through C.
 - Step 6: Construct point D.
- c** In your square construction, drag one of points A or B. ABCD should always be a square regardless of the position of A or B.

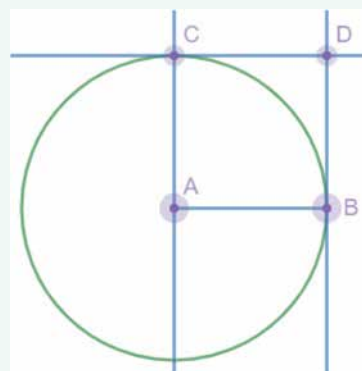

4 Extension

By considering the above algorithm, which describes how to construct a square, write an algorithm which constructs the following quadrilaterals. Use dynamic geometry in each case to test your algorithm.

- a** Rectangle **b** Parallelogram **c** Kite **d** Rhombus

Triangle centres with technology

Use an interactive geometry package such as 'Geometers Sketchpad' or 'Cabri Geometry' to construct the following shapes.

The circumcentre of a triangle

The point at which all perpendicular bisectors of the sides of a triangle meet is called the circumcentre.

- Draw any triangle.
- Label the vertices A , B and C .
- Draw a perpendicular bisector for each side.
- Label the intersection point of the bisectors O .
- Using O as the centre, construct a circle that touches the vertices of the triangle.
- Drag any of the vertices and describe what happens to your construction.

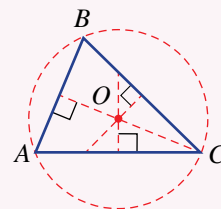

The incentre of a triangle

The point at which all angle bisectors of a triangle meet is called the incentre.

- Draw any triangle.
- Label the vertices A , B and C .
- Draw the three angle bisectors through the vertices.
- Label the intersection point of the bisectors O .
- Using O as your centre, construct a circle that touches the sides of the triangle.
- Drag any of the vertices and describe what happens to your construction.

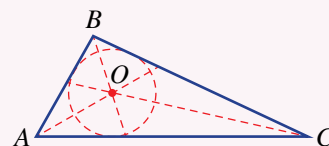

The centroid of a triangle

The point of intersection of the three medians of a triangle is called the centroid. It can also be called the centre of gravity.

- Draw a triangle and label the vertices A , B and C .
- Find the midpoint of each line and draw a line segment from each midpoint to its opposite vertex.
- Label the intersection point of these lines O . This is the centroid of the triangle.
- Show your teacher the final construction and print it. Cut out the triangle and place a sharp pencil under the centroid. The triangle should balance perfectly.

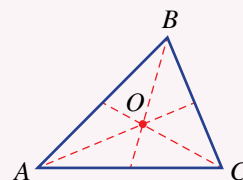

The equilateral triangle: The special triangle

- Construct an equilateral triangle. Determine its incentre, circumcentre and centroid.
- What do you notice?

- Use 12 matchsticks to make 6 equilateral triangles.
- How many acute angles are there in the diagram shown below?

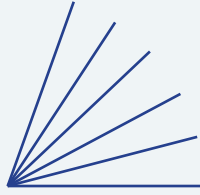

Up for a challenge? If you get stuck on a question, check out the 'Working with unfamiliar problems' poster at the end of the book to help you.



- Find the value of a .

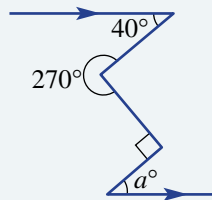

- Explore (using interactive geometry software) where the points A , B and C should be on the sides of $\triangle DEF$ so that the perimeter of $\triangle ABC$ is a minimum.

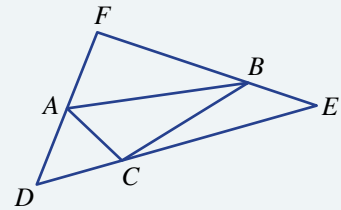

- Find the size of angle UQS given the sides $PQ = PU$ and $QR = RS$. Angle PTR is 90° .

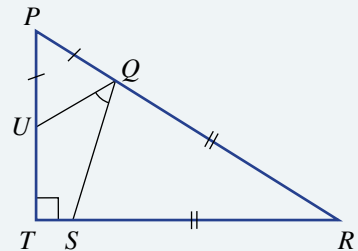

- A circle is divided using chords (one chord is shown here). What is the maximum number of regions that can be formed if the circle is divided with 4 chords?

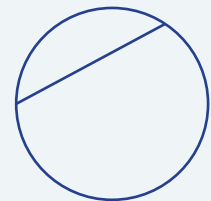

- Two poles are 30 m and 40 m high. Cables connect the top of each vertical pole to the base of the other pole. How high is the intersection point of the cables above the ground?

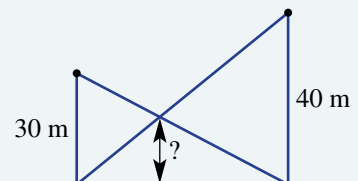

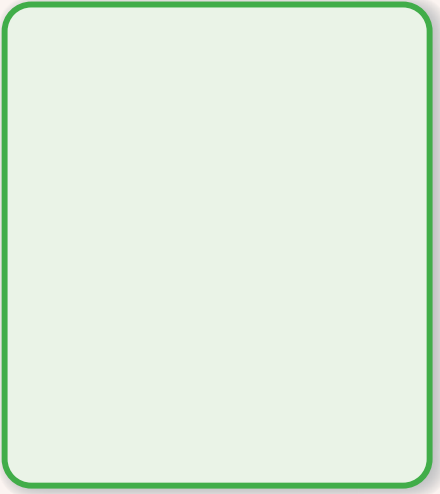

Chapter checklist and success criteria

A printable version of this checklist is available in the Interactive Textbook



7A

1. I can find supplementary and complementary angles.

e.g. For an angle of size 62° determine the size of its supplementary angle and its complementary angle.



7A

2. I can classify triangles and find an unknown angle.

e.g. Name the type of triangle shown and determine the value of the pronumeral.

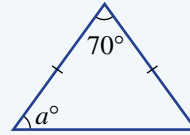

7A

3. I can find exterior angles.

e.g. Find the value of the pronumeral in the diagram giving reasons.

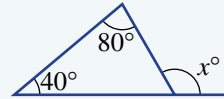

7B

4. I can determine if lines are parallel.

e.g. Decide if the diagram contains a pair of parallel lines, giving a reason.

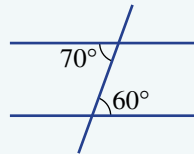

7B

5. I can find angles in parallel lines.

e.g. Find the value of each of the pronumerals giving reasons.

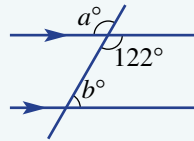

7B

6. I can find angles in parallel lines using a third parallel line.

e.g. Add a third parallel line to the diagram to help find $\angle ABC$.

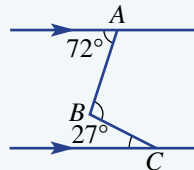

7C

7. I can find angles in quadrilaterals.

e.g. Find the value of the pronumeral in the quadrilateral.

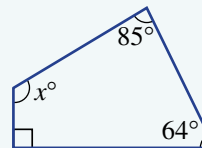



7C

8. I can find angles in polygons.

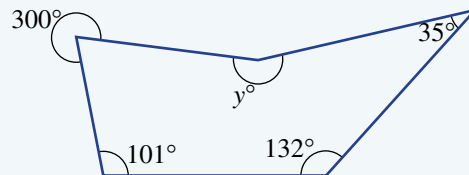
e.g. For the polygon shown, find the angle sum and use this to find the value of the pronumeral.

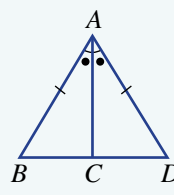
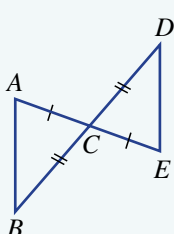
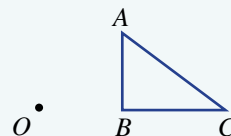
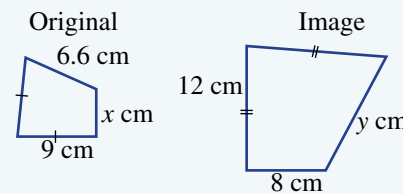

Chapter checklist and success criteria

7D	<p>9. I can use the congruence tests to identify congruent triangles. e.g. Which congruence test (SSS, SAS, AAS or RHS) would be used to show that these pairs of triangles are congruent?</p> 	<p style="text-align: right;">✓</p> <p style="text-align: center;"><input type="checkbox"/></p>
7D	<p>10. I can use congruence to find missing side lengths or angles. e.g. Find the value of the pronumerals in these congruent triangles.</p> 	<p style="text-align: center;"><input type="checkbox"/></p>
7E	<p>11. I can prove that two triangles are congruent. e.g. Prove that $\triangle ABD \equiv \triangle ADC$.</p> 	<p style="text-align: right;">(Ext)</p> <p style="text-align: center;"><input type="checkbox"/></p>
7E	<p>12. I can use congruence to prove geometrical results. e.g. Prove that $\triangle ABD \equiv \triangle EDC$ and hence prove that $AB \parallel DE$.</p> 	<p style="text-align: right;">(Ext)</p> <p style="text-align: center;"><input type="checkbox"/></p>
7F	<p>13. I can enlarge a figure using a scale factor. e.g. Copy the diagram and use the centre of enlargement (O) and each of the scale factors 2 and $\frac{1}{3}$ to enlarge $\triangle ABC$.</p> 	<p style="text-align: center;"><input type="checkbox"/></p>
7F	<p>14. I can find and use the scale factor in similar figures. e.g. For the similar figures shown, find the scale factor and use this to find the value of x and y.</p> 	<p style="text-align: center;"><input type="checkbox"/></p>

Chapter checklist and success criteria

7G

15. I can choose a similarity test for triangles.
e.g. Choose the similarity test which proves that these pairs of triangles are similar.



✓

7G

16. I can use similarity to find a missing length.
e.g. For the pair of triangles shown, give a reason why the two triangles are similar and find the value of x .

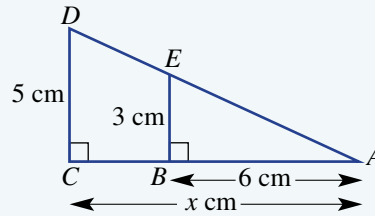

7H

17. I can prove that two triangles are similar.
e.g. Prove that the two triangles are similar.

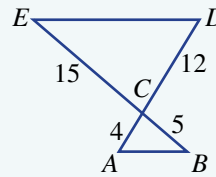

7H

18. I can apply similarity.
e.g. A 1.6 m tall girl has a shadow that is 1.12 m long. A tree's shadow is 21 m long. Give a reason why the two triangles in the diagram are similar and determine the tree's height.

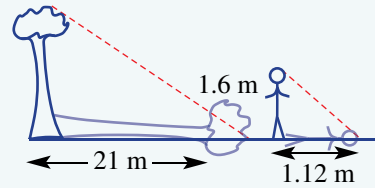

Short-answer questions

7A

- 1 Name the following triangles and find the value of the pronumerals.

a

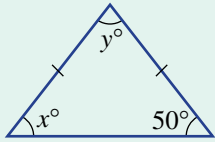

b

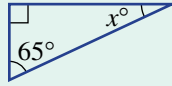

c

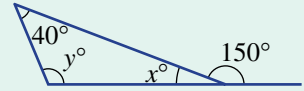

7A/B

- 2 Find the value of each pronumeral in the diagrams. Give reasons for your answers.

a

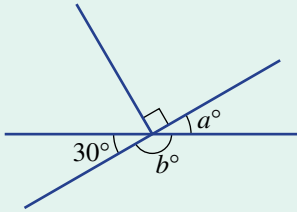

b

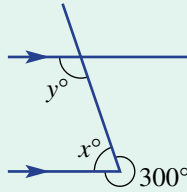

c

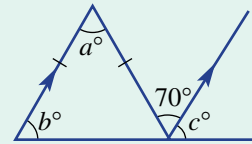

7B

- 3 By adding a third parallel line to the diagram, find
- $\angle ABC$
- .

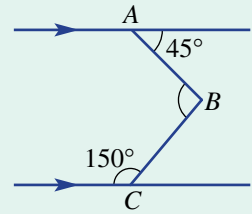

7C

- 4 Find the value of each pronumeral in the following polygons. The polygon in part d is regular.

a

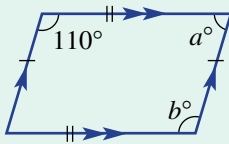

b

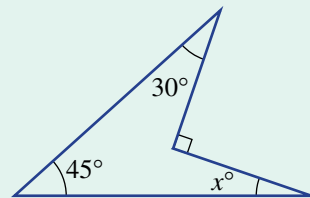

c

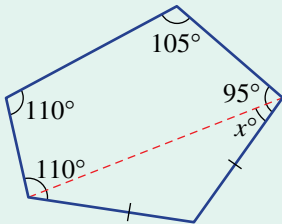

d

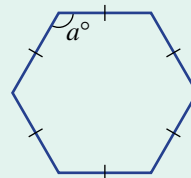

7D

- 5 Determine if the triangles in each pair are congruent. If congruent, give the abbreviated reason and state the value of any pronumerals.

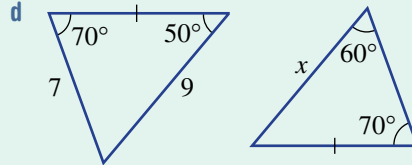
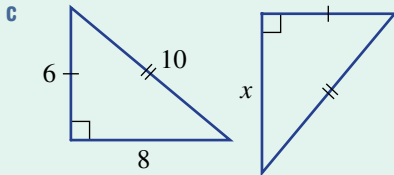
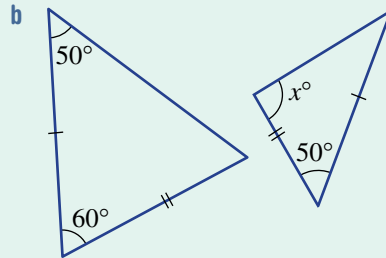
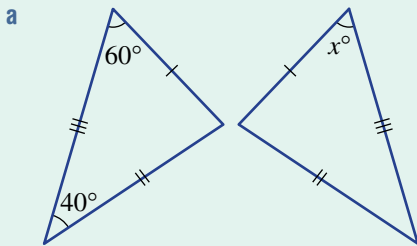

7E

Ext

- 6 a For the diagram at right, prove that $\triangle ADB \equiv \triangle ADC$. List your reasons and give the abbreviated congruence test.

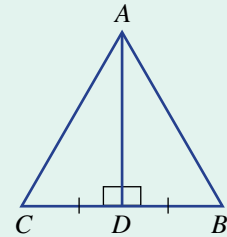

- b i For the diagram at right, prove that $\triangle ACB \equiv \triangle ECD$.
List your reasons and give the abbreviated congruence test.
ii Hence, prove that $AB \parallel DE$.

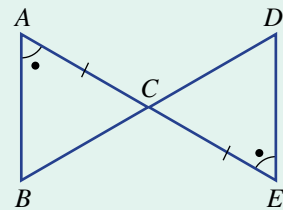

7F

- 7 Copy the given diagram using plenty of space. Using the centre of enlargement (O) and a scale factor of 3, enlarge $\triangle ABC$.

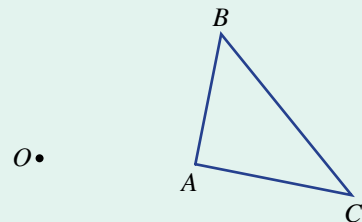

7G 8 Determine if the following pairs of triangles are similar, and state the similarity test which proves this.

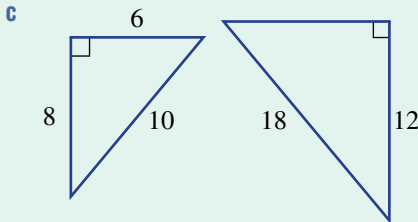
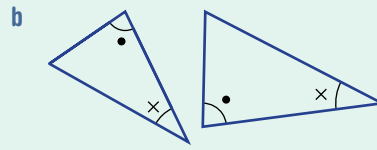
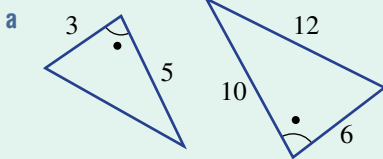

7G 9 For the following pairs of similar triangles, find the value of x .

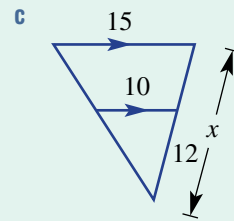
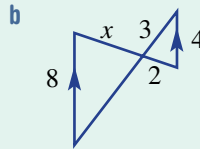
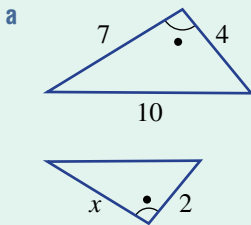

7H 10 A conveyor belt used to load luggage onto a plane is 12.5 m long. A vertical support 1.6 m high is placed under the conveyor belt such that it is 4 m along the conveyor belt as shown.



- a Prove that $\triangle BCD \parallel \triangle ACE$.
 b Find the height (AE) of the luggage door above the ground.

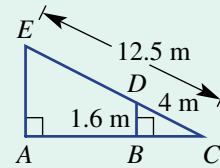

Multiple-choice questions

7A 1 The angle that is supplementary to an angle of 55° is:
 A 35° B 55° C 95°
 D 125° E 305°

7B 2 What is the value of x if AB is parallel to CD ?
 A 110 B 70 C 20
 D 130 E 120

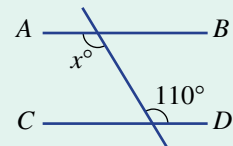

7A 3 If two angles in a triangle are complementary then the third angle is:
 A acute B a right angle
 C obtuse D reflex
 E supplementary

7B 4 The values of x and y in the diagram are:
 A $x = 35, y = 85$
 B $x = 45, y = 45$
 C $x = 55, y = 60$
 D $x = 55, y = 65$
 E $x = 65, y = 55$

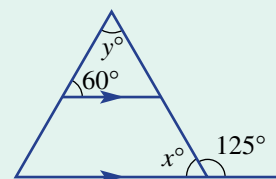

- 7C 5 The sum of the interior angles in a hexagon is:
 A 1078°
 B 360°
 C 720°
 D 900°
 E 540°

- 7C 6 The quadrilateral with all sides equal, two pairs of opposite parallel sides and no right angles is:
 A a kite
 B a trapezium
 C a parallelogram
 D a rhombus
 E a square

- 7C 7 The values of a and b in the diagram are:
 A $a = 85, b = 60$
 B $a = 75, b = 80$
 C $a = 80, b = 55$
 D $a = 70, b = 55$
 E $a = 75, b = 50$

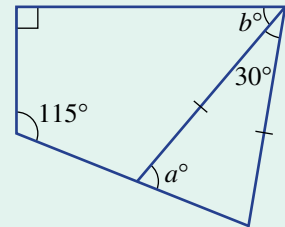

- 7D 8 The abbreviated reason for congruence in the two triangles shown is:
 A AA
 B SAS
 C SSS
 D AAS
 E RHS

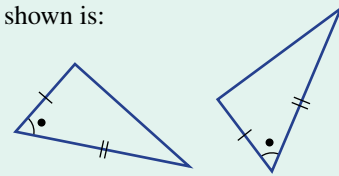

- 7G 9 The scale factor that enlarges the original figure to its image is:
 A $\frac{2}{3}$
 B 2
 C 1.2
 D 1.5
 E 0.5

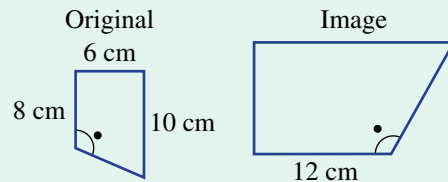

- 7G 10 The value of x in the diagram is:
 A 6
 B 9
 C 10
 D 8
 E 7.5

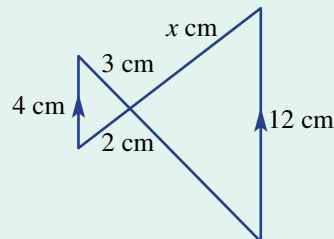

Extended-response questions

1 Complete the following.

a Prove that $DE \parallel CF$.

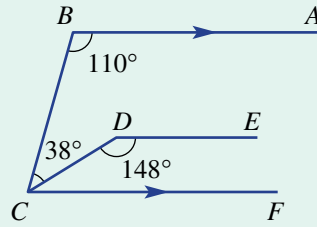

b Show, with reasons, that $a = 20$.

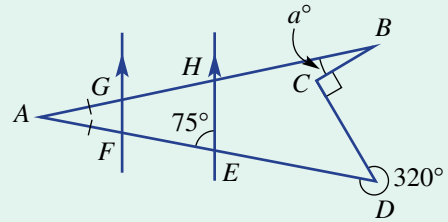

c Use congruence to prove that $AC = BD$ in the diagram, given $AB = CD$ and $\angle ABC = \angle DCB$.

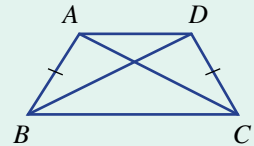

2 A buoy (E) is floating in the sea at some unknown distance from the beach as shown. The points A, B, C and D are measured and marked out on the beach as shown.

- a Name the angle which is vertically opposite to $\angle ACB$.
- b Explain, with reasons, why $\triangle ABC \cong \triangle EDC$.
- c Find the distance from the buoy to the beach (ED), to one decimal place.

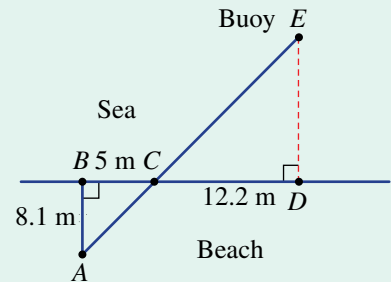

8

Algebraic techniques

Maths in context: The story of algebra

Algebra follows rules of arithmetic, using pronumerals to represent unknown numbers. Algebraic notation is very efficient, but, for over 3500 years, solutions were written explanations of steps.

Babylonians, 2000 BCE, solved algebraic-like problems using complex arithmetic. Egyptians, 1650 BCE, solved questions with guess-and-check numerical solutions. The Greek Euclid, 350 BCE, solved algebra type questions using geometry explanations. Chinese, 250 BCE, made significant progress towards various equation solutions.

The Greek Diophantus, 275 CE, invented a geometric algebra using some symbols. The Indian Brahmagupta, 628 CE, solved linear and quadratic equations, including those with negative

and irrational solutions. The Persian Al-Khwarizmi (shown in this image), 825 CE, wrote 'Al-jabra', introducing techniques of "reducing" and "balancing" to solve linear and quadratic equations. Al-Khwarizmi introduced algebra as a new branch of mathematics. He used the word 'roots' for unknowns, (*like invisible tree roots*), giving us 'equation roots' and 'square root' etc.

Around 1100 CE, European scholars first learned of algebra from the Latin translation of Al-Khwarizmi's Arabic book, now titled 'Algebrae' by 'Algoritmi', giving us 'algebra' and 'algorithm'. The Italian Fibonacci, 1225 CE, recorded many equation solving methods. In the 16th century, Italian mathematicians

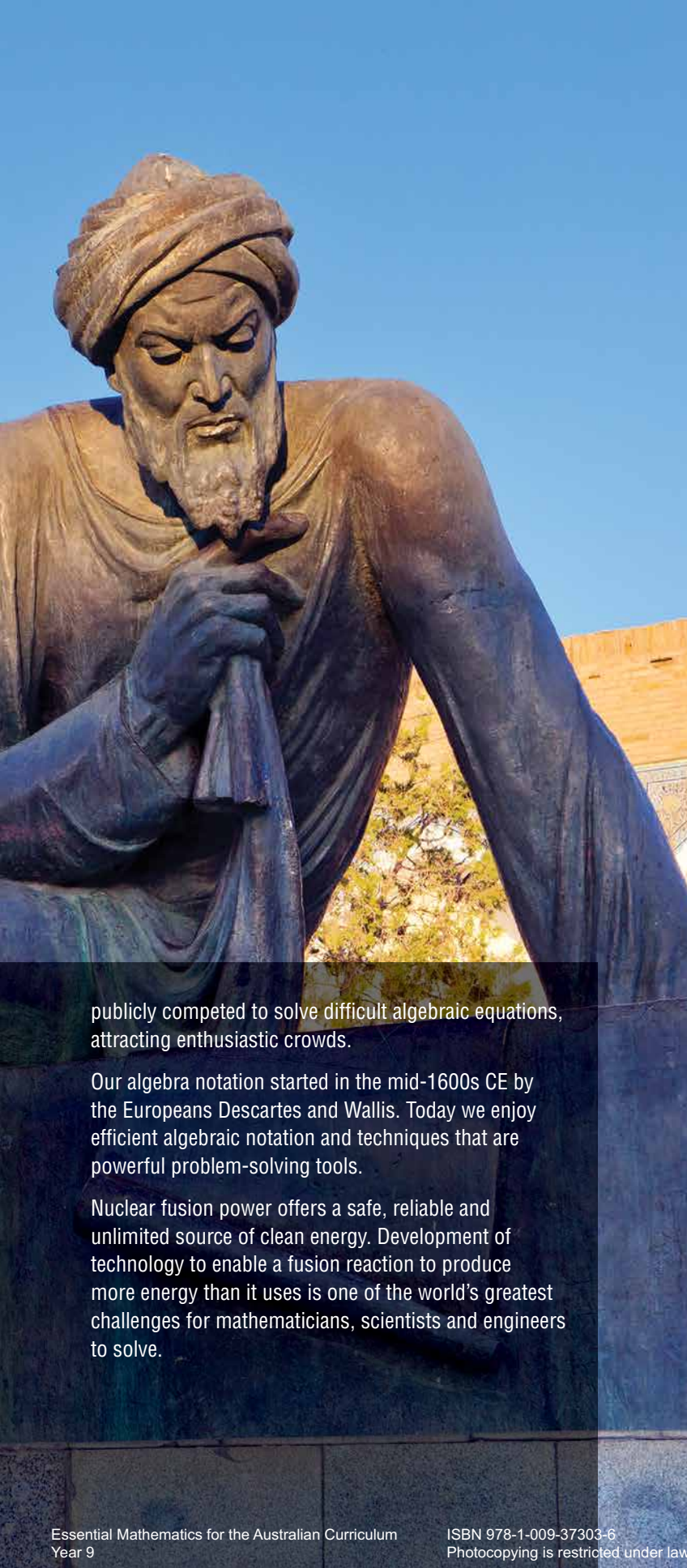

publicly competed to solve difficult algebraic equations, attracting enthusiastic crowds.

Our algebra notation started in the mid-1600s CE by the Europeans Descartes and Wallis. Today we enjoy efficient algebraic notation and techniques that are powerful problem-solving tools.

Nuclear fusion power offers a safe, reliable and unlimited source of clean energy. Development of technology to enable a fusion reaction to produce more energy than it uses is one of the world's greatest challenges for mathematicians, scientists and engineers to solve.

Chapter contents

- 8A Expanding binomial products
- 8B Perfect squares and difference of two squares
- 8C Factorising algebraic expressions
- 8D Factorising the difference of two squares
- 8E Factorising by grouping in pairs
- 8F Factorising monic quadratic trinomials
- 8G Factorising trinomials of the form $ax^2 + bx + c$ (EXTENDING)
- 8H Simplifying algebraic fractions: Multiplication and division
- 8I Simplifying algebraic fractions: Addition and subtraction
- 8J Further simplification of algebraic fractions (EXTENDING)
- 8K Equations with algebraic fractions (EXTENDING)

Australian Curriculum 9.0

ALGEBRA

Apply the exponent laws to numerical expressions with integer exponents and extend to variables (AC9M9A01)

Simplify algebraic expressions, expand binomial products and factorise monic quadratic expressions (AC9M9A02)

Use mathematical modelling to solve applied problems involving change including financial contexts; formulate problems, choosing to use either linear or quadratic functions; interpret solutions in terms of the situation; evaluate the model and report methods and findings (AC9M9A05)

© ACARA

Online resources

A host of additional online resources are included as part of your Interactive Textbook, including HOTmaths content, video demonstrations of all worked examples, auto-marked quizzes and much more.

8A Expanding binomial products

LEARNING INTENTIONS

- To know how to apply the distributive law to binomial products
- To be able to expand and simplify binomial products

A binomial is an expression with two terms such as $x + 5$ or $x^2 + 3$. You will recall from Chapter 2 that we looked at the product of a single term with a binomial expression, e.g. $2(x - 3)$ or $x(3x - 1)$. The product of two binomial expressions can also be expanded using the distributive law. This involves multiplying every term in one expression by every term in the other expression.



Business analysts expand algebraic products to model profit, as sales and profit per item can both depend on the selling price.

E.g. $P = 50(20 - c) \times (c - 4)$ for chocolates selling at \$ c per box.

Lesson starter: Rectangular expansions

If $(x + 1)$ and $(x + 2)$ are the side lengths of a rectangle as shown below, the total area can be found as an expression in two different ways.

- Write an expression for the total area of the rectangle using length = $(x + 2)$ and width = $(x + 1)$.
- Now find the area of each of the four parts of the rectangle and combine to give an expression for the total area.
- Compare your two expressions above and complete this equation:

$$(x + 2)(\quad) = x^2 + \quad + \quad.$$

- Can you explain a method for expanding the left-hand side to give the right-hand side?

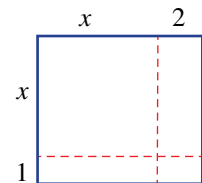

KEY IDEAS

- Expanding **binomial products** uses the **distributive law**.

$$\begin{aligned}(a + b)(c + d) &= a(c + d) + b(c + d) \\ &= ac + ad + bc + bd\end{aligned}$$

- Diagrammatically $(a + b)(c + d) = ac + ad + bc + bd$

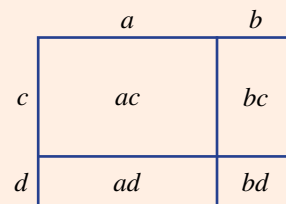

$$\begin{aligned}\text{For example: } (x + 1)(x + 5) &= x^2 + 5x + x + 5 \\ &= x^2 + 6x + 5\end{aligned}$$

BUILDING UNDERSTANDING

1 The diagram on the right shows the area $(x + 2)(x + 3)$.

a State an expression for the area of each of the four regions inside the rectangle.

b State the missing terms.

$$(x + 2)(x + 3) = \underline{\quad} + 3x + \underline{\quad} + 6$$

$$= \underline{\quad} + 5x + \underline{\quad}$$

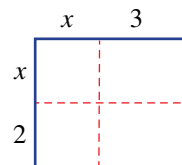

2 The diagram on the right shows the area $(2x + 3)(x + 1)$.

a State an expression for the area of each of the four regions inside the rectangle.

b State the missing terms.

$$(2x + 3)(\underline{\quad}) = 2x^2 + \underline{\quad} + 3x + \underline{\quad}$$

$$= \underline{\quad} + \underline{\quad} + \underline{\quad}$$

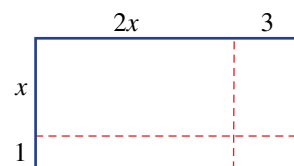

3 State the missing terms in these expansions.

a $(x + 1)(x + 5) = \underline{\quad} + 5x + \underline{\quad} + 5$
 $= \underline{\quad} + 6x + \underline{\quad}$

b $(x - 3)(x + 2) = \underline{\quad} + \underline{\quad} - 3x - \underline{\quad}$
 $= \underline{\quad} - x - \underline{\quad}$

c $(3x - 2)(7x + 2) = \underline{\quad} + 6x - \underline{\quad} - \underline{\quad}$
 $= \underline{\quad} - \underline{\quad} + \underline{\quad}$

d $(4x - 1)(3x - 4) = \underline{\quad} - \underline{\quad} - 3x + \underline{\quad}$
 $= \underline{\quad} - 19x + \underline{\quad}$



Example 1 Expanding binomial products

Expand the following.

a $(x + 3)(x + 5)$

b $(x - 4)(x + 7)$

c $(2x - 1)(x - 6)$

d $(5x - 2)(3x + 7)$

SOLUTION

a $(x + 3)(x + 5) = x^2 + 5x + 3x + 15$
 $= x^2 + 8x + 15$

b $(x - 4)(x + 7) = x^2 + 7x - 4x - 28$
 $= x^2 + 3x - 28$

c $(2x - 1)(x - 6) = 2x^2 - 12x - x + 6$
 $= 2x^2 - 13x + 6$

d $(5x - 2)(3x + 7) = 15x^2 + 35x - 6x - 14$
 $= 15x^2 + 29x - 14$

EXPLANATION

Use the distributive law to expand the brackets and then collect the like terms $5x$ and $3x$.

After expanding to get the four terms, collect the like terms $7x$ and $-4x$.

Remember $2x \times x = 2x^2$ and $-1 \times (-6) = 6$.

Recall $5x \times 3x = 5 \times 3 \times x \times x = 15x^2$.

Now you try

Expand the following.

a $(x + 2)(x + 4)$

b $(x - 3)(x + 5)$

c $(2x - 3)(x - 4)$

d $(3x - 5)(4x + 3)$

Exercise 8A

FLUENCY

1–2($\frac{1}{2}$)1–2($\frac{1}{2}$)1–3($\frac{1}{3}$)

Example 1a,b

1 Expand the following.

a $(x + 2)(x + 5)$

b $(b + 3)(b + 4)$

c $(t + 8)(t + 7)$

d $(a + 1)(a + 7)$

e $(y + 10)(y + 2)$

f $(m + 4)(m + 12)$

g $(x + 3)(x - 4)$

h $(x + 4)(x - 8)$

i $(x - 6)(x + 2)$

j $(x - 1)(x + 10)$

k $(x - 1)(x - 2)$

l $(x - 4)(x - 5)$

Example 1c,d

2 Expand the following.

a $(4x + 3)(2x + 5)$

b $(3x + 2)(2x + 1)$

c $(3x + 1)(5x + 4)$

d $(2x - 3)(3x + 5)$

e $(8x - 3)(3x + 4)$

f $(3x - 2)(2x + 1)$

g $(5x + 2)(2x - 7)$

h $(2x + 3)(3x - 2)$

i $(4x + 1)(4x - 5)$

j $(3x - 2)(6x - 5)$

k $(5x - 2)(3x - 1)$

l $(7x - 3)(3x - 4)$

3 Expand these binomial products.

a $(a + b)(a + c)$

b $(a - b)(a + c)$

c $(y - x)(z - y)$

d $(2x + y)(x - 2y)$

e $(2a + b)(a - b)$

f $(3x - y)(2x + y)$

g $(2a - b)(3a + 2)$

h $(4x - 3y)(3x - 4y)$

i $(xy - yz)(z + 3x)$

PROBLEM-SOLVING

4

4, 5

5, 6

4 A rectangular room with dimensions 4 m by 5 m is to be extended. Both the length and the width are to be increased by x m.

a Find an expanded expression for the area of the new room.

b If $x = 3$:

i find the area of the new room

ii by how much has the area increased?

5 A rectangular picture frame 5 cm wide has a length which is twice the width x cm.

a Find an expression for the total area of the frame and picture.

b Find an expression in expanded form for the area of the picture only.

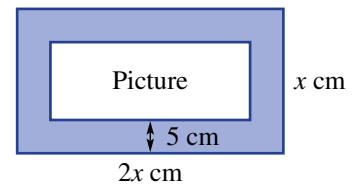

- 6 The outside edge of a path around a swimming pool is 15 m long and 10 m wide. The path is x metres wide.

- a Find an expression for the area of the pool in expanded form.
b Find the area of the pool if $x = 2$.

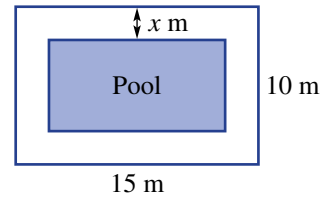

REASONING

 $7(1/2)$ $7-8(1/2)$ $7(1/3), 8(1/2)$

- 7 Write the missing terms in these expansions.

- a $(x + 2)(x + \underline{\quad}) = x^2 + 5x + 6$
b $(x + \underline{\quad})(x + 5) = x^2 + 7x + 10$
c $(x + 1)(x + \underline{\quad}) = x^2 + 7x + \underline{\quad}$
d $(x + \underline{\quad})(x + 9) = x^2 + 11x + \underline{\quad}$
e $(x + 3)(x - \underline{\quad}) = x^2 + x - \underline{\quad}$
f $(x - 5)(x + \underline{\quad}) = x^2 - 2x - \underline{\quad}$
g $(x + 1)(\underline{\quad} + 3) = 2x^2 + \underline{\quad} + \underline{\quad}$
h $(\underline{\quad} - 4)(3x - 1) = 9x^2 - \underline{\quad} + \underline{\quad}$
i $(x + 2)(\underline{\quad} + \underline{\quad}) = 7x^2 + \underline{\quad} + 6$
j $(\underline{\quad} - \underline{\quad})(2x - 1) = 6x^2 - \underline{\quad} + 4$

- 8 Consider the binomial product $(x + a)(x + b)$. Find the possible integer values of a and b if:

- a $(x + a)(x + b) = x^2 + 5x + 6$
b $(x + a)(x + b) = x^2 - 5x + 6$
c $(x + a)(x + b) = x^2 + x - 6$
d $(x + a)(x + b) = x^2 - x - 6$

ENRICHMENT: Trinomial expansions

-

-

 $9(1/2), 10$

- 9 Using the distributive law, $(a + b)(c + d + e) = ac + ad + ae + bc + bd + be$.

Use this knowledge to expand and simplify these products. (Note: $x \times x^2 = x^3$.)

- a $(x + 1)(x^2 + x + 1)$
b $(x - 2)(x^2 - x + 3)$
c $(2x - 1)(2x^2 - x + 4)$
d $(x^2 - x + 1)(x + 3)$
e $(5x^2 - x + 2)(2x - 3)$
f $(2x^2 - x + 7)(4x - 7)$
g $(x + a)(x^2 - ax + a)$
h $(x - a)(x^2 - ax - a^2)$
i $(x + a)(x^2 - ax + a^2)$
j $(x - a)(x^2 + ax + a^2)$

- 10 Now try to expand $(x + 1)(x + 2)(x + 3)$.

8B Perfect squares and difference of two squares

LEARNING INTENTIONS

- To be able to identify a perfect square
- To be able to expand a perfect square
- To understand what type of expansion forms a difference of two squares
- To be able to expand to form a difference of two squares

$2^2 = 4$, $15^2 = 225$, x^2 and $(a + b)^2$ are all examples of perfect squares. To expand $(a + b)^2$ we multiply $(a + b)$ by $(a + b)$ and use the distributive law:

$$\begin{aligned}(a + b)^2 &= (a + b)(a + b) \\ &= a^2 + ab + ba + b^2 \\ &= a^2 + 2ab + b^2\end{aligned}$$

A similar result is obtained for the square of $(a - b)$:

$$\begin{aligned}(a - b)^2 &= (a - b)(a - b) \\ &= a^2 - ab - ba + b^2 \\ &= a^2 - 2ab + b^2\end{aligned}$$

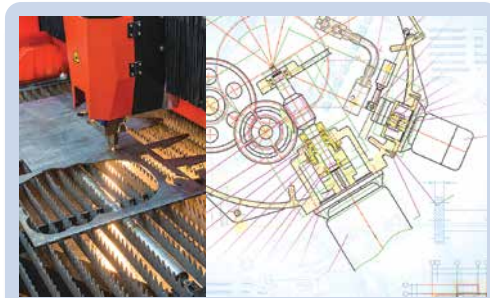

Mechanical engineers design all kinds of equipment to be fabricated from steel sheets. Binomial products can be used when calculating the most efficient way to cut out the required shapes.

Another type of expansion involves the case that deals with the product of the sum and difference of the same two terms. The result is the difference of two squares:

$$\begin{aligned}(a + b)(a - b) &= a^2 - ab + ba - b^2 \\ &= a^2 - b^2 \text{ (since } ab = ba, \text{ the two middle terms cancel each other out)}\end{aligned}$$

Lesson starter: Seeing the pattern

Using $(a + b)(c + d) = ac + ad + bc + bd$, expand and simplify the binomial products in the two sets below.

Set A

$$\begin{aligned}(x + 1)(x + 1) &= x^2 + x + x + 1 \\ &= \\ (x + 3)(x + 3) &= \\ &= \\ (x - 5)(x - 5) &= \\ &= \\ &= \end{aligned}$$

Set B

$$\begin{aligned}(x + 1)(x - 1) &= x^2 - x + x - 1 \\ &= \\ (x - 3)(x + 3) &= \\ &= \\ (x - 5)(x + 5) &= \\ &= \\ &= \end{aligned}$$

- Describe the patterns you see in both sets of expansions above.
- Generalise your observations by completing the following expansions.

$$\begin{aligned}\mathbf{a} \quad (a + b)(a + b) &= a^2 + _ + _ + _ \\ &= a^2 + _ + _ \\ (a - b)(a - b) &= \\ &= \end{aligned}$$

$$\begin{aligned}\mathbf{b} \quad (a + b)(a - b) &= a^2 - _ + _ - _ \\ &= \end{aligned}$$

KEY IDEAS

■ $3^2 = 9$, a^2 , $(2y)^2$, $(x - 1)^2$ and $(3 - 2y)^2$ are all examples of **perfect squares**.

■ Expanding perfect squares

$$\bullet (a + b)^2 = (a + b)(a + b)$$

$$= a^2 + ab + ba + b^2$$

$$= a^2 + 2ab + b^2$$

$$\bullet (a - b)^2 = (a - b)(a - b)$$

$$= a^2 - ab - ba + b^2$$

$$= a^2 - 2ab + b^2$$

■ **Difference of two squares**

$$\bullet (a + b)(a - b) = a^2 - ab + ba - b^2$$

$$= a^2 - b^2$$

$$\bullet (a - b)(a + b) \text{ also expands to } a^2 - b^2$$

• The result is a difference of two squares.

BUILDING UNDERSTANDING

1 State the missing terms in these expansions.

a $(x + 3)(x + 3) = x^2 + 3x + \underline{\quad} + \underline{\quad}$
 $= \underline{\hspace{2cm}}$

b $(x + 5)(x + 5) = x^2 + 5x + \underline{\quad} + \underline{\quad}$
 $= \underline{\hspace{2cm}}$

c $(x - 2)(x - 2) = x^2 - 2x - \underline{\quad} + \underline{\quad}$
 $= \underline{\hspace{2cm}}$

d $(x - 7)(x - 7) = x^2 - 7x - \underline{\quad} + \underline{\quad}$
 $= \underline{\hspace{2cm}}$

2 a Substitute the given value of b into $x^2 + 2bx + b^2$ and simplify.

i $b = 3$

ii $b = 11$

iii $b = 15$

b Substitute the given value of b into $x^2 - 2bx + b^2$ and simplify.

i $b = 2$

ii $b = 9$

iii $b = 30$

3 State the missing terms in these expansions.

a $(x + 4)(x - 4) = x^2 - 4x + \underline{\quad} - \underline{\quad}$
 $= \underline{\hspace{2cm}}$

b $(x - 10)(x + 10) = x^2 - \underline{\quad} - \underline{\quad} - \underline{\quad}$
 $= \underline{\hspace{2cm}}$

c $(2x - 1)(2x + 1) = 4x^2 + \underline{\quad} - \underline{\quad} - \underline{\quad}$
 $= \underline{\hspace{2cm}}$

d $(3x + 4)(3x - 4) = 9x^2 - \underline{\quad} + \underline{\quad} - \underline{\quad}$
 $= \underline{\hspace{2cm}}$

**Example 2 Expanding perfect squares**

Expand each of the following.

a $(x - 4)^2$

b $(2x + 3)^2$

SOLUTION

$$\begin{aligned} \mathbf{a} \quad (x - 4)^2 &= (x - 4)(x - 4) \\ &= x^2 - 4x - 4x + 16 \\ &= x^2 - 8x + 16 \end{aligned}$$

Alternative method:

$$\begin{aligned} (x - 4)^2 &= x^2 - 2 \times x \times 4 + 4^2 \\ &= x^2 - 8x + 16 \end{aligned}$$

$$\begin{aligned} \mathbf{b} \quad (2x + 3)^2 &= (2x + 3)(2x + 3) \\ &= 4x^2 + 6x + 6x + 9 \\ &= 4x^2 + 12x + 9 \end{aligned}$$

Alternative method:

$$\begin{aligned} (2x + 3)^2 &= (2x)^2 + 2 \times 2x \times 3 + 3^2 \\ &= 4x^2 + 12x + 9 \end{aligned}$$

EXPLANATION

Write in expanded form.
Use the distributive law.
Collect like terms.

Expand using $(a - b)^2 = a^2 - 2ab + b^2$ where $a = x$ and $b = 4$.

Write in expanded form.
Use the distributive law.
Collect like terms.

Expand using $(a + b)^2 = a^2 + 2ab + b^2$ where $a = 2x$ and $b = 3$. Recall $(2x)^2 = 2x \times 2x = 4x^2$.

Now you try

Expand each of the following.

a $(x - 3)^2$

b $(3x + 4)^2$

**Example 3 Forming a difference of two squares**

Expand and simplify the following.

a $(x + 2)(x - 2)$

b $(3x - 2y)(3x + 2y)$

SOLUTION

$$\begin{aligned} \mathbf{a} \quad (x + 2)(x - 2) &= x^2 - \cancel{2x} + \cancel{2x} - 4 \\ &= x^2 - 4 \end{aligned}$$

Alternative method:

$$\begin{aligned} (x + 2)(x - 2) &= (x)^2 - (2)^2 \\ &= x^2 - 4 \end{aligned}$$

EXPLANATION

Expand using the distributive law.
 $-2x + 2x = 0$

$(a + b)(a - b) = a^2 - b^2$. Here $a = x$
and $b = 2$.

$$\begin{aligned} \text{b } (3x - 2y)(3x + 2y) &= 9x^2 + \cancel{6xy} - \cancel{6xy} - 4y^2 \\ &= 9x^2 - 4y^2 \end{aligned}$$

Expand using the distributive law.
 $6xy - 6xy = 0$

Alternative method:

$$\begin{aligned} (3x - 2y)(3x + 2y) &= (3x)^2 - (2y)^2 \\ &= 9x^2 - 4y^2 \end{aligned}$$

$(a + b)(a - b) = a^2 - b^2$ with $a = 3x$
 and $b = 2y$ here.

Now you try

Expand and simplify the following.

a $(x + 4)(x - 4)$

b $(5x - 3y)(5x + 3y)$

Exercise 8B

FLUENCY

$1 - 2\left(\frac{1}{2}\right), 4 - 5\left(\frac{1}{2}\right)$

$1 - 5\left(\frac{1}{3}\right)$

$1 - 5\left(\frac{1}{3}\right)$

Example 2a

1 Expand each of the following perfect squares.

a $(x + 1)^2$

b $(x + 3)^2$

c $(x + 2)^2$

d $(x + 5)^2$

e $(x + 4)^2$

f $(x + 9)^2$

g $(x - 2)^2$

h $(x - 6)^2$

i $(x - 1)^2$

j $(x - 3)^2$

k $(x - 9)^2$

l $(x - 7)^2$

Example 2b

2 Expand each of the following perfect squares.

a $(2x + 1)^2$

b $(2x + 5)^2$

c $(3x + 2)^2$

d $(3x + 1)^2$

e $(5x + 2)^2$

f $(4x + 3)^2$

g $(7 + 2x)^2$

h $(5 + 3x)^2$

i $(2x - 3)^2$

j $(3x - 1)^2$

k $(4x - 5)^2$

l $(2x - 9)^2$

m $(3x + 5y)^2$

n $(2x + 4y)^2$

o $(7x + 3y)^2$

p $(6x + 5y)^2$

q $(4x - 9y)^2$

r $(2x - 7y)^2$

s $(3x - 10y)^2$

t $(4x - 6y)^2$

u $(9x - 2y)^2$

3 Expand each of the following perfect squares.

a $(3 - x)^2$

b $(5 - x)^2$

c $(1 - x)^2$

d $(6 - x)^2$

e $(11 - x)^2$

f $(8 - 2x)^2$

g $(2 - 3x)^2$

h $(9 - 2x)^2$

i $(10 - 4x)^2$

Example 3a

4 Expand and simplify the following to form a difference of two squares.

a $(x + 1)(x - 1)$

b $(x + 3)(x - 3)$

c $(x + 8)(x - 8)$

d $(x + 4)(x - 4)$

e $(x + 12)(x - 12)$

f $(x + 11)(x - 11)$

g $(x - 9)(x + 9)$

h $(x - 5)(x + 5)$

i $(x - 6)(x + 6)$

j $(5 - x)(5 + x)$

k $(2 - x)(2 + x)$

l $(7 - x)(7 + x)$

Example 3b

5 Expand and simplify the following.

a $(3x - 2)(3x + 2)$

b $(5x - 4)(5x + 4)$

c $(4x - 3)(4x + 3)$

d $(7x - 3y)(7x + 3y)$

e $(9x - 5y)(9x + 5y)$

f $(11x - y)(11x + y)$

g $(8x + 2y)(8x - 2y)$

h $(10x - 9y)(10x + 9y)$

i $(7x - 5y)(7x + 5y)$

j $(6x - 11y)(6x + 11y)$

k $(8x - 3y)(8x + 3y)$

l $(9x - 4y)(9x + 4y)$

PROBLEM-SOLVING

6

6, 7

6, 7

6 Lara is x years old and her two best friends are $(x - 2)$ and $(x + 2)$ years old.

a Write an expression for:

i the square of Lara's age

ii the product of the ages of Lara's best friends (in expanded form).

b Are the answers from parts a i and ii equal? If not, by how much do they differ?

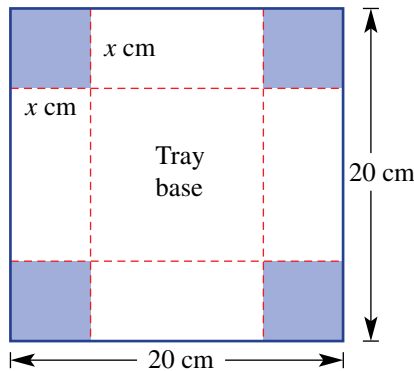
7 A square piece of tin of side length 20 cm has four squares of side length x cm removed from each corner. The sides are folded up to form a tray. The centre square forms the tray base.

a Write an expression for the side length of the base of the tray.

b Write an expression for the area of the base of the tray. Expand your answer.

c Find the area of the tray base if $x = 3$.d Find the volume of the tray if $x = 3$.

REASONING

8

8, 9

9, 10

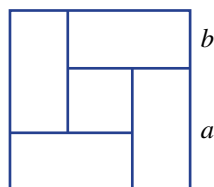
8 Four tennis courts are arranged as shown with a square storage area in the centre. Each court area has the dimensions $a \times b$.

a Write an expression for the side length of the total area.

b Write an expression for the total area.

c Write an expression for the side length of the inside storage area.

d Write an expression for the area of the inside storage area.

e Subtract your answer to part d from your answer to part b to find the area of the four courts.

f Find the area of one court. Does your answer confirm that your answer to part e is correct?

- 9 A square of side length x units has one side reduced by 1 unit and the other increased by 1 unit.
- Find an expanded expression for the area of the resulting rectangle.
 - Is the area of the original square the same as the area of the resulting rectangle?
Explain why/why not.

- 10 A square of side length b is removed from a square of side length a .
- Using subtraction write down an expression for the remaining area.
 - Write expressions for the area of these regions:
 - A
 - B
 - C
 - Add all the expressions from part **b** to see if you get your answer from part **a**.

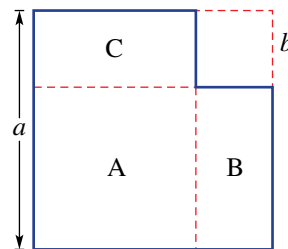

ENRICHMENT: Extended expansions

-

-

11($\frac{1}{2}$)

- 11 Expand and simplify these expressions.

a $(x + 2)^2 - 4$

c $(x + 3)(x - 3) + 6x$

e $x^2 - (x + 1)(x - 1)$

g $(3x - 2)(3x + 2) - (3x + 2)^2$

i $(x + y)^2 - (x - y)^2 + (x + y)(x - y)$

k $(2 - x)^2 - (2 + x)^2$

m $2(3x - 4)^2 - (3x - 4)(3x + 4)$

b $(2x - 1)^2 - 4x^2$

d $1 - (x + 1)^2$

f $(x + 1)^2 - (x - 1)^2$

h $(5x - 1)^2 - (5x + 1)(5x - 1)$

j $(2x - 3)^2 + (2x + 3)^2$

l $(3 - x)^2 + (x - 3)^2$

n $2(x + y)^2 - (x - y)^2$



Engineers work with binomial products. A metal rectangle, with possible dimensions 16 cm by 24 cm, can have square corners removed and be folded to give a height of x cm. The box has base area $A = (16 - 2x)(24 - 2x)$.

8C Factorising algebraic expressions

LEARNING INTENTIONS

- To be able to identify a highest common factor of two or more terms
- To understand what it means to write an expression in factorised form
- To understand the relationship between factorised and expanded form
- To be able to factorise an expression involving a common factor

The process of factorisation is a key step in the simplification of many algebraic expressions and in the solution of equations. It is the reverse process of expansion and involves writing an expression as a product of its factors.

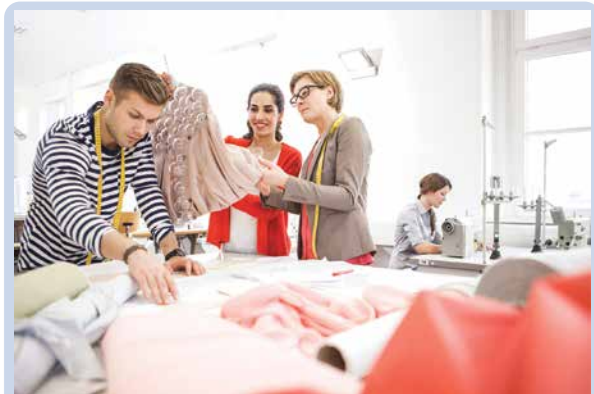
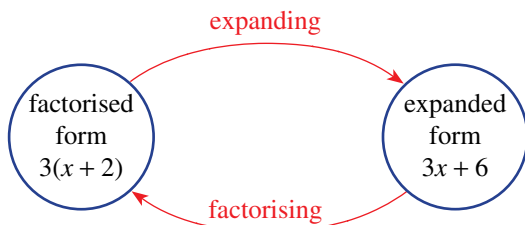

Factorising is a key step when solving many of the equations used in business, engineering, technology and science. Fashion business analysts develop and solve equations to model and predict sales, revenue and profit.

Lesson starter: Which factorised form?

The product $x(4x + 8)$ when expanded gives $4x^2 + 8x$.

- Write down three other products that when expanded give $4x^2 + 8x$. (Do not use fractions.)
- Which of your products uses the highest common factor of $4x^2$ and $8x$? What is this highest common factor?

KEY IDEAS

- When **factorising** expressions with common factors, take out the highest common factor (HCF).

The HCF could be:

- a number
For example: $2x + 10 = 2(x + 5)$
- a pronumeral (or variable)
For example: $x^2 + 5x = x(x + 5)$
- the product of numbers and pronumerals
For example: $2x^2 + 10x = 2x(x + 5)$

- A factorised expression can be checked by using expansion.

For example: $2x(x + 5) = 2x^2 + 10x$.

BUILDING UNDERSTANDING

- 1 State the highest common factor (HCF) of these pairs of numbers.
 a 8, 12 b 24, 30 c 100, 75 d 16, 24
- 2 Give the missing factor.
 a $5 \times \underline{\quad} = 5x$ b $5a \times \underline{\quad} = 10a^2$
 c $\underline{\quad} \times 12x = -36x^2$ d $\underline{\quad} \times -7xy = 14x^2y$
- 3 a State the missing factor in each part.
 i $\underline{\quad}(x^2 + 2x) = 6x^2 + 12x$ ii $\underline{\quad}(2x + 4) = 6x^2 + 12x$
 iii $\underline{\quad}(x + 2) = 6x^2 + 12x$
 b Which equation above uses the HCF of $6x^2$ and $12x$?
 c By looking at the terms left in the brackets, how do you know you have taken out the HCF?



Example 4 Finding the HCF

Determine the highest common factor (HCF) of the following.

- a $6a$ and $8ab$ b $3x^2$ and $6xy$

SOLUTION

a $2a$

b $3x$

EXPLANATION

HCF of 6 and 8 is 2.
 HCF of a and ab is a .

HCF of 3 and 6 is 3.
 HCF of x^2 and xy is x .

Now you try

Determine the highest common factor (HCF) of the following.

- a $4x$ and $10xy$ b $5x^2$ and $15xy$



Example 5 Factorising expressions

Factorise the following.

- a $40 - 16b$ b $-8x^2 - 12x$

SOLUTION

a $40 - 16b = 8(5 - 2b)$

b $-8x^2 - 12x = -4x(2x + 3)$

EXPLANATION

The HCF of 40 and $16b$ is 8. Place 8 in front of the brackets and divide each term by 8.

The HCF of the terms is $-4x$, including the common negative. Place the factor in front of the brackets and divide each term by $-4x$.

Now you try

Factorise the following.

a $28 - 21a$

b $-9x^2 - 15x$

**Example 6 Taking out a binomial factor**

Factorise the following.

a $3(x + y) + x(x + y)$

b $(7 - 2x) - x(7 - 2x)$

SOLUTION

a $3(x + y) + x(x + y)$
 $= (x + y)(3 + x)$

b $(7 - 2x) - x(7 - 2x)$
 $= 1(7 - 2x) - x(7 - 2x)$
 $= (7 - 2x)(1 - x)$

EXPLANATION

HCF = $(x + y)$.

The second pair of brackets contains what remains when $3(x + y)$ and $x(x + y)$ are divided by $(x + y)$.

Insert 1 in front of the first bracket.

HCF = $(7 - 2x)$.

The second bracket must contain $1 - x$ after dividing $(7 - 2x)$ and $x(7 - 2x)$ by $(7 - 2x)$.**Now you try**

Factorise the following.

a $4(a + b) + a(a + b)$

b $(4x + 3) - x(4x + 3)$

Exercise 8C**FLUENCY**

1, 2-5($\frac{1}{2}$)

2-6($\frac{1}{3}$)

2-6($\frac{1}{4}$)

1 Determine the highest common factor (HCF) of the following.

Example 4a

a i $5a$ and $15ab$

ii $9b$ and $12ab$

Example 4b

b i $2x^2$ and $8xy$

ii $5x^2$ and $10x$

Example 4

2 Determine the HCF of the following.

a $6x$ and $14xy$

b $12a$ and $18a$

c $10m$ and 4

d $12y$ and 8

e $15t$ and $6s$

f 15 and p

g $9x$ and $24xy$

h $6n$ and $21mn$

i $10y$ and $2y$

j $8x^2$ and $14x$

k $4x^2y$ and $18xy$

l $5ab^2$ and $15a^2b$

Example 5a

3 Factorise the following.

a $7x + 7$

b $3x + 3$

c $4x - 4$

d $5x - 5$

e $4 + 8y$

f $10 + 5a$

g $3 - 9b$

h $6 - 2x$

i $12a + 3b$

j $6m + 6n$

k $10x - 8y$

l $4a - 20b$

m $x^2 + 2x$

n $a^2 - 4a$

o $y^2 - 7y$

p $x - x^2$

q $3p^2 + 3p$

r $8x - 8x^2$

s $4b^2 + 12b$

t $6y - 10y^2$

u $12a - 15a^2$

v $9m + 18m^2$

w $16xy - 48x^2$

x $7ab - 28ab^2$

Example 5b

4 Factorise the following by factoring out the negative sign as part of the HCF

- | | | | | | | | |
|---|---------------|---|---------------|---|---------------|---|---------------|
| a | $-8x - 4$ | b | $-4x - 2$ | c | $-10x - 5y$ | d | $-7a - 14b$ |
| e | $-9x - 12$ | f | $-6y - 8$ | g | $-10x - 15y$ | h | $-4m - 20n$ |
| i | $-3x^2 - 18x$ | j | $-8x^2 - 12x$ | k | $-16y^2 - 6y$ | l | $-5a^2 - 10a$ |
| m | $-6x - 20x^2$ | n | $-6p - 15p^2$ | o | $-16b - 8b^2$ | p | $-9x - 27x^2$ |

Example 6

5 Factorise the following which involve a binomial common factor.

- | | | | |
|---|-------------------------|---|-------------------------|
| a | $4(x + 3) + x(x + 3)$ | b | $3(x + 1) + x(x + 1)$ |
| c | $7(m - 3) + m(m - 3)$ | d | $x(x - 7) + 2(x - 7)$ |
| e | $8(a + 4) - a(a + 4)$ | f | $5(x + 1) - x(x + 1)$ |
| g | $y(y + 3) - 2(y + 3)$ | h | $a(x + 2) - x(x + 2)$ |
| i | $t(2t + 5) + 3(2t + 5)$ | j | $m(5m - 2) + 4(5m - 2)$ |
| k | $y(4y - 1) - (4y - 1)$ | l | $(7 - 3x) + x(7 - 3x)$ |

6 Factorise these mixed expressions.

- | | | | | | |
|---|-------------------------|---|------------------------|---|------------------------|
| a | $6a + 30$ | b | $5x - 15$ | c | $8b + 18$ |
| d | $x^2 - 4x$ | e | $y^2 + 9y$ | f | $a^2 - 3a$ |
| g | $x^2y - 4xy + xy^2$ | h | $6ab - 10a^2b + 8ab^2$ | i | $m(m + 5) + 2(m + 5)$ |
| j | $x(x + 3) - 2(x + 3)$ | k | $b(b - 2) + (b - 2)$ | l | $x(2x + 1) - (2x + 1)$ |
| m | $y(3 - 2y) - 5(3 - 2y)$ | n | $(x + 4)^2 + 5(x + 4)$ | o | $(y + 1)^2 - 4(y + 1)$ |

PROBLEM-SOLVING

7

$7(\frac{1}{2}), 8$

$7(\frac{1}{3}), 8, 9$

7 Write down the perimeter of these shapes in factorised form.

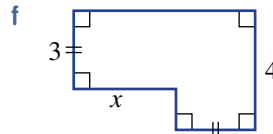
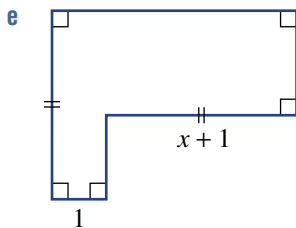
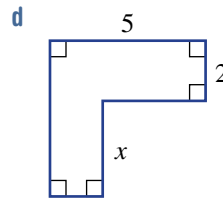
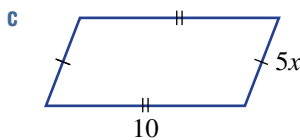
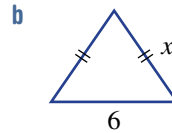
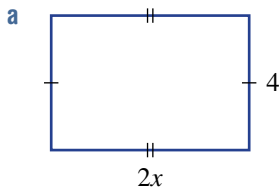

8 The expression for the area of a rectangle is $(4x^2 + 8x)$ square units. Find an expression for the width of the rectangle if its length is $(x + 2)$ units.

- 9 The height, above its starting point in metres, of a ball thrown in the air is given by $5t - t^2$, where t is the time in seconds.
- Write an expression for the ball's height in factorised form.
 - Find the ball's height above its starting point at these times:
 - $t = 0$
 - $t = 4$
 - $t = 2$
 - How long does it take for the ball's height to return to 0 metres (its starting height)? Use trial and error if required.



REASONING

10

10–11($\frac{1}{2}$)11–12($\frac{1}{2}$)

- 10 $7 \times 9 + 7 \times 3$ can be evaluated by first factorising to $7(9 + 3)$. This gives $7 \times 12 = 84$. Use a similar technique to evaluate the following.

a $9 \times 2 + 9 \times 5$

b $6 \times 3 + 6 \times 9$

c $-2 \times 4 - 2 \times 6$

d $-5 \times 8 - 5 \times 6$

e $23 \times 5 - 23 \times 2$

f $63 \times 11 - 63 \times 8$

- 11 Common factors can also be removed from expressions with more than two terms.

For example: $2x^2 + 6x + 10xy = 2x(x + 3 + 5y)$

Factorise these expressions by taking out the HCF.

a $3a^2 + 9a + 12$

b $5z^2 - 10z + zy$

c $x^2 - 2xy + x^2y$

d $4by - 2b + 6b^2$

e $-12xy - 8yz - 20xyz$

f $3ab + 4ab^2 + 6a^2b$

- 12 Sometimes we can choose to factor out a negative HCF or a positive HCF. Both factorisations are correct. For example:

$$\begin{aligned} -13x + 26 &= -13(x - 2) \quad (\text{HCF is } -13) \\ \text{OR } -13x + 26 &= 13(-x + 2) \quad (\text{HCF is } 13) \\ &= 13(2 - x) \end{aligned}$$

Factorise in two different ways: the first by factoring out a negative HCF and the second by factoring out a positive HCF.

a $-4x + 12$

b $-3x + 9$

c $-8n + 8$

d $-3b + 3$

e $-5m + 5m^2$

f $-7x + 7x^2$

g $-5x + 5x^2$

h $-4y + 22y^2$

ENRICHMENT: Factoring out a negative

-

-

13($\frac{1}{2}$)

- 13 Using the fact that $a - b = -(b - a)$, you can factorise $x(x - 2) - 5(2 - x)$ by following these steps.

$$\begin{aligned} x(x - 2) - 5(2 - x) &= x(x - 2) + 5(x - 2) \\ &= (x - 2)(x + 5) \end{aligned}$$

Use this idea to factorise these expressions.

a $x(x - 4) + 3(4 - x)$

b $x(x - 5) - 2(5 - x)$

c $x(x - 3) - 3(3 - x)$

d $3x(x - 4) + 5(4 - x)$

e $3(2x - 5) + x(5 - 2x)$

f $2x(x - 2) + (2 - x)$

g $-4(3 - x) - x(x - 3)$

h $x(x - 5) + (10 - 2x)$

i $x(x - 3) + (6 - 2x)$

8D Factorising the difference of two squares

LEARNING INTENTIONS

- To be able to recognise a difference of two squares
- To be able to express a difference of two squares in factorised form
- To know to check for a common factor first before further factorisation

Recall that a difference of two squares is formed when expanding the product of the sum and difference of two terms. For example, $(x + 2)(x - 2) = x^2 - 4$. Reversing this process means that a difference of two squares can be factorised into two binomial expressions of the form $(a + b)$ and $(a - b)$.



Engineers use algebra when designing products used for bridges, buildings and machinery, such as this steel turbine for a power station. For example, a circle area difference:
 $A = \pi R^2 - \pi r^2 = \pi(R^2 - r^2) = \pi(R - r)(R + r)$.

Lesson starter: Expanding to understand factorising

Complete the steps in these expansions then write the conclusion.

- $(x + 3)(x - 3) = x^2 - 3x + \underline{\quad} - \underline{\quad}$
 $\quad\quad\quad = x^2 - \underline{\quad}$
 $\therefore x^2 - 9 = (\underline{\quad} + \underline{\quad})(\underline{\quad} - \underline{\quad})$
- $(2x - 5)(2x + 5) = 4x^2 + 10x - \underline{\quad} - \underline{\quad}$
 $\quad\quad\quad = \underline{\quad} - \underline{\quad}$
 $\therefore 4x^2 - \underline{\quad} = (\underline{\quad} + \underline{\quad})(\underline{\quad} - \underline{\quad})$
- $(a + b)(a - b) = a^2 - ab + \underline{\quad} - \underline{\quad}$
 $\quad\quad\quad = \underline{\quad} - \underline{\quad}$
 $\therefore a^2 - \underline{\quad} = (\underline{\quad} + \underline{\quad})(\underline{\quad} - \underline{\quad})$

KEY IDEAS

■ Factorising the difference of two squares uses the rule $a^2 - b^2 = (a + b)(a - b)$.

- $x^2 - 16 = x^2 - 4^2$
 $\quad\quad\quad = (x + 4)(x - 4)$
- $9x^2 - 100 = (3x)^2 - 10^2$
 $\quad\quad\quad = (3x + 10)(3x - 10)$
- $25 - 4y^2 = 5^2 - (2y)^2$
 $\quad\quad\quad = (5 + 2y)(5 - 2y)$

■ First take out common factors where possible.

- $2x^2 - 18 = 2(x^2 - 9)$
 $\quad\quad\quad = 2(x + 3)(x - 3)$

BUILDING UNDERSTANDING

1 Expand these binomial products to form a difference of two squares.

a $(x + 2)(x - 2)$

b $(x - 7)(x + 7)$

c $(3x - y)(3x + y)$

2 State the missing term. Assume it is a positive number.

a $(\quad)^2 = 9$

b $(\quad)^2 = 121$

c $(\quad)^2 = 25b^2$

d $(\quad)^2 = 49y^2$

3 State the missing terms to complete these factorisations.

a $x^2 - 16 = x^2 - 4^2$
 $= (x + 4)(\quad - \quad)$

b $x^2 - 144 = x^2 - (\quad)^2$
 $= (\quad + 12)(x - \quad)$

c $16x^2 - 1 = (\quad)^2 - (\quad)^2$
 $= (4x + \quad)(\quad - 1)$

d $9a^2 - 4b^2 = (\quad)^2 - (\quad)^2$
 $= (3a + \quad)(\quad - 2b)$



Example 7 Factorising a difference of two squares

Factorise each of the following.

a $x^2 - 4$

b $9a^2 - 25$

c $81x^2 - y^2$

SOLUTION

a $x^2 - 4 = x^2 - 2^2$
 $= (x + 2)(x - 2)$

b $9a^2 - 25 = (3a)^2 - 5^2$
 $= (3a + 5)(3a - 5)$

c $81x^2 - y^2 = (9x)^2 - y^2$
 $= (9x + y)(9x - y)$

EXPLANATION

Write as a difference of two squares (4 is the same as 2^2).

Write in factorised form:

$$a^2 - b^2 = (a + b)(a - b)$$

Here $a = x$ and $b = 2$.

Write as a difference of two squares. $9a^2$ is the same as $(3a)^2$.

Write in factorised form.

$$81x^2 = (9x)^2$$

Use $a^2 - b^2 = (a + b)(a - b)$.

Now you try

Factorise each of the following.

a $x^2 - 16$

b $4a^2 - 9$

c $25a^2 - b^2$



Example 8 Factorising a more complex difference of two squares

Factorise each of the following.

a $2b^2 - 32$

b $(x + 1)^2 - 4$

SOLUTION

$$\begin{aligned} \text{a } 2b^2 - 32 &= 2(b^2 - 16) \\ &= 2(b^2 - 4^2) \\ &= 2(b + 4)(b - 4) \end{aligned}$$

$$\begin{aligned} \text{b } (x + 1)^2 - 4 &= (x + 1)^2 - 2^2 \\ &= ((x + 1) + 2)((x + 1) - 2) \\ &= (x + 3)(x - 1) \end{aligned}$$

EXPLANATION

First, factor out the common factor of 2.
Write as a difference of two squares and then factorise.

Write as a difference of two squares. In $a^2 - b^2$ here, a is the expression $x + 1$ and $b = 2$.
Write in factorised form and simplify.

Now you try

Factorise each of the following.

a $3a^2 - 27$

b $(x + 2)^2 - 9$

Exercise 8D

FLUENCY

1–3($\frac{1}{2}$)

1–4($\frac{1}{2}$)

1–2($\frac{1}{4}$), 3–4($\frac{1}{2}$)

Example 7a

1 Factorise each of the following.

a $x^2 - 9$

b $y^2 - 25$

c $y^2 - 1$

d $x^2 - 64$

e $x^2 - 16$

f $b^2 - 49$

g $a^2 - 81$

h $x^2 - y^2$

i $a^2 - b^2$

j $16 - a^2$

k $25 - x^2$

l $1 - b^2$

m $36 - y^2$

n $121 - b^2$

o $x^2 - 400$

p $900 - y^2$

Example 7b,c

2 Factorise each of the following.

a $4x^2 - 25$

b $9x^2 - 49$

c $25b^2 - 4$

d $4m^2 - 121$

e $100y^2 - 9$

f $81a^2 - 4$

g $1 - 4x^2$

h $25 - 64b^2$

i $16 - 9y^2$

j $36x^2 - y^2$

k $4x^2 - 25y^2$

l $64a^2 - 49b^2$

m $4p^2 - 25q^2$

n $81m^2 - 4n^2$

o $25a^2 - 49b^2$

p $100a^2 - 9b^2$

Example 8a

3 Factorise each of the following by first taking out the common factor.

a $3x^2 - 108$

b $10a^2 - 10$

c $6x^2 - 24$

d $4y^2 - 64$

e $98 - 2x^2$

f $32 - 8m^2$

g $5x^2y^2 - 5$

h $3 - 3x^2y^2$

i $63 - 7a^2b^2$

Example 8b

4 Factorise each of the following.

a $(x + 5)^2 - 9$

b $(x + 3)^2 - 4$

c $(x + 10)^2 - 16$

d $(x - 3)^2 - 25$

e $(x - 7)^2 - 1$

f $(x - 3)^2 - 36$

g $49 - (x + 3)^2$

h $4 - (x + 2)^2$

i $81 - (x + 8)^2$

PROBLEM-SOLVING

5

5, 6

5, 6

- 5 The height above ground (in metres) of an object thrown off the top of a building is given by $36 - 4t^2$ where t is in seconds.
- Factorise the expression for the height of the object by first taking out the common factor.
 - Find the height of the object:
 - initially ($t = 0$)
 - at 2 seconds ($t = 2$).
 - How long does it take for the object to hit the ground? Use trial and error if you wish.

- 6 This 'multisize' square picture frame has side length 30 cm and can hold a square picture with any side length less than 26 cm.

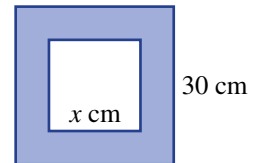

- If the side length of the picture is x cm, write an expression for:
 - the area of the picture
 - the area of the frame (in factorised form).
- Use your result from part a ii to find the area of the frame if:
 - $x = 20$
 - the area of the picture is 225 cm^2 .

REASONING

 $7(\frac{1}{2})$ $7(\frac{1}{2}), 8$ $7(\frac{1}{2}), 8, 9$

- 7 Initially it may not appear that an expression such as $-4 + 9x^2$ is a difference of two squares. However, swapping the position of the two terms makes $-4 + 9x^2 = 9x^2 - 4$, which can be factorised to $(3x + 2)(3x - 2)$. Use this idea to factorise these difference of two squares.
- | | | | |
|-------------------|---------------------|---------------------|-------------------|
| a $-9 + x^2$ | b $-121 + 16x^2$ | c $-25a^2 + 4$ | d $-y^2 + x^2$ |
| e $-25a^2 + 4b^2$ | f $-36a^2b^2 + c^2$ | g $-16x^2 + y^2z^2$ | h $-900a^2 + b^2$ |
- 8 Olivia factorises $16x^2 - 4$ to get $(4x + 2)(4x - 2)$, but the answer says $4(2x + 1)(2x - 1)$.
- What should Olivia do to get from her answer to the actual answer?
 - What should Olivia have done initially to avoid this issue?
- 9 Find and explain the error in this working and correct it.
- $$9 - (x - 1)^2 = (3 + x - 1)(3 - x - 1)$$
- $$= (2 + x)(2 - x)$$

ENRICHMENT: Factorising with fractions and powers of 4

-

-

 $10(\frac{1}{2})$

- 10 Some expressions with fractions or powers of 4 can be factorised in a similar way. Factorise these.

a $x^2 - \frac{1}{4}$

b $x^2 - \frac{4}{25}$

c $25x^2 - \frac{9}{16}$

d $\frac{x^2}{9} - 1$

e $\frac{a^2}{4} - \frac{b^2}{9}$

f $\frac{5x^2}{9} - \frac{5}{4}$

g $\frac{7a^2}{25} - \frac{28b^2}{9}$

h $\frac{a^2}{8} - \frac{b^2}{18}$

i $x^4 - y^4$

j $2a^4 - 2b^4$

k $21a^4 - 21b^4$

l $\frac{x^4}{3} - \frac{y^4}{3}$

8E Factorising by grouping in pairs

LEARNING INTENTIONS

- To know that a common factor can include a binomial term
- To be able to use the grouping method to factorise some four-term expressions
- To know that expressions can be rearranged to find common factors to use in the grouping process

When an expression can be written using four terms, such as $x^2 + 2x - x - 2$, it may be possible to factorise it into a product of two binomial terms such as $(x - 1)(x + 2)$. In such situations the method of grouping in pairs is often used.



Algebra is an essential tool for the engineers who work together making renewable energy possible, including: aerospace, civil, electrical, electronics, environmental, industrial, materials, mechanical and solar engineers.

Lesson starter: Two methods: Same result

The four-term expression $x^2 - 3x - 3 + x$ is written on the board.

Tommy chooses to rearrange the terms to give $x^2 - 3x + x - 3$ then factorises by grouping in pairs.

Sharon chooses to rearrange the terms to give $x^2 + x - 3x - 3$ then also factorises by grouping in pairs.

- Complete Tommy and Sharon's factorisation working.

$$\begin{aligned} \text{Tommy} \\ x^2 - 3x + x - 3 &= x(x - 3) + 1(\underline{\quad}) \\ &= (x - 3)(\underline{\quad}) \end{aligned}$$

$$\begin{aligned} \text{Sharon} \\ x^2 + x - 3x - 3 &= x(\underline{\quad}) - 3(\underline{\quad}) \\ &= (x + 1)(\underline{\quad}) \end{aligned}$$

- Discuss the differences in the methods. Is there any difference in their answers?
- Whose method do you prefer?

KEY IDEAS

■ **Factorisation by grouping in pairs** is a method that is often used to factorise a four-term expression.

- Terms are grouped into pairs and factorised separately.
- The common binomial factor is then taken out to complete the factorisation.
- Terms can be rearranged to assist in the search of a common factor.

$$\begin{aligned} x^2 + 3x - 2x - 6 \\ &= x(x + 3) - 2(x + 3) \\ &= (x + 3)(x - 2) \end{aligned}$$

which could also be written as $(x - 2)(x + 3)$

BUILDING UNDERSTANDING

1 State each expanded expression.

a $2(x - 1)$

c $a(a + 5)$

e $x(a + 1) + 2(a + 1)$

b $-5(1 - a)$

d $y(4 - y)$

f $b(x - 2) - 3(x - 2)$

2 State the missing information.

a $2(x + 1) + x(x + 1) = (x + 1)(\underline{\quad})$

b $5(x + 5) - x(x + 5) = (x + 5)(\underline{\quad})$

c $a(x - 3) + (x - 3) = (x - 3)(\underline{\quad})$

d $(x - 3) - a(x - 3) = (x - 3)(\underline{\quad})$

3 Identify the common binomial term then factorise each expression.

a $x(x - 3) - 2(x - 3)$

c $3(2x + 1) - x(2x + 1)$

e $3x(5 - x) + 2(5 - x)$

b $x(x + 4) + 3(x + 4)$

d $4(3x - 2) - x(3x - 2)$

f $x(x - 2) + (x - 2)$



Example 9 Factorising by grouping in pairs

Use the method of grouping in pairs to factorise these expressions.

a $x^2 + 2x + 3x + 6$

b $x^2 + 3x - 5x - 15$

SOLUTION

$$\begin{aligned} \text{a } x^2 + 2x + 3x + 6 &= (x^2 + 2x) + (3x + 6) \\ &= x(x + 2) + 3(x + 2) \\ &= (x + 2)(x + 3) \end{aligned}$$

$$\begin{aligned} \text{b } x^2 + 3x - 5x - 15 &= (x^2 + 3x) + (-5x - 15) \\ &= x(x + 3) - 5(x + 3) \\ &= (x + 3)(x - 5) \end{aligned}$$

EXPLANATION

Group the first and second pair of terms.
Factorise each group.
Take the common factor $(x + 2)$ out of both groups.

Group the first and second pair of terms.
Factorise each group.
Take out the common factor $(x + 3)$.

Now you try

Use the method of grouping in pairs to factorise these expressions.

a $x^2 + 4x + 2x + 8$

b $x^2 + 2x - 3x - 6$



Example 10 Rearranging an expression to factorise by grouping in pairs

Factorise $2x^2 - 9 - 18x + x$ using grouping in pairs.

SOLUTION

$$\begin{aligned} 2x^2 - 9 - 18x + x &= 2x^2 + x - 18x - 9 \\ &= x(2x + 1) - 9(2x + 1) \\ &= (2x + 1)(x - 9) \end{aligned}$$

Alternative method:

$$\begin{aligned} 2x^2 - 9 - 18x + x &= 2x^2 - 18x + x - 9 \\ &= 2x(x - 9) + 1(x - 9) \\ &= (x - 9)(2x + 1) \end{aligned}$$

EXPLANATION

Rearrange so that each group has a common factor.
Factorise each group then take out $(2x + 1)$.

Alternatively, you can group in another order where each group has a common factor. Then factorise.

The answer will be the same.

Now you try

Factorise $2x^2 - 15 - 10x + 3x$ using grouping in pairs.

Exercise 8E

FLUENCY

1-2($\frac{1}{2}$)1-3($\frac{1}{2}$)1-3($\frac{1}{3}$)

Example 9

- Use the method of grouping in pairs to factorise these expressions.

<p>a $x^2 + 3x + 2x + 6$</p> <p>c $x^2 + 7x + 2x + 14$</p> <p>e $x^2 - 4x + 6x - 24$</p> <p>g $x^2 + 2x - 18x - 36$</p> <p>i $x^2 + 4x - 18x - 72$</p> <p>k $x^2 - 3x - 3xc + 9c$</p>	<p>b $x^2 + 4x + 3x + 12$</p> <p>d $x^2 - 6x + 4x - 24$</p> <p>f $x^2 - 3x + 10x - 30$</p> <p>h $x^2 + 3x - 14x - 42$</p> <p>j $x^2 - 2x - xa + 2a$</p> <p>l $x^2 - 5x - 3xa + 15a$</p>
---	---
- Use the method of grouping in pairs to factorise these expressions. The HCF for each pair includes a pronominal. For example, $2ab - 2ad + bc - cd = 2a(b - d) + c(b - d) = (b - d)(2a + c)$

<p>a $3ab + 5bc + 3ad + 5cd$</p> <p>c $2xy - 8xz + 3wy - 12wz$</p> <p>e $4x^2 + 12xy - 3x - 9y$</p>	<p>b $4ab - 7ac + 4bd - 7cd$</p> <p>d $5rs - 10r + st - 2t$</p> <p>f $2ab - a^2 - 2bc + ac$</p>
---	---
- Factorise these expressions. Remember to use a factor of 1 where necessary, for example, $x^2 - ax + x - a = x(x - a) + 1(x - a)$.

<p>a $x^2 - bx + x - b$</p> <p>c $x^2 + bx + x + b$</p> <p>e $x^2 + ax - x - a$</p>	<p>b $x^2 - cx + x - c$</p> <p>d $x^2 + cx - x - c$</p> <p>f $x^2 - bx - x + b$</p>
---	---

PROBLEM-SOLVING

4(½)

4-5(½)

4-6(½)

Example 10

4 Factorise these expressions by first rearranging the terms.

a $2x^2 - 7 - 14x + x$

b $5x + 2x + x^2 + 10$

c $2x^2 - 3 - x + 6x$

d $3x - 8x - 6x^2 + 4$

e $11x - 5a - 55 + ax$

f $12y + 2x - 8xy - 3$

g $6m - n + 3mn - 2$

h $15p - 8r - 5pr + 24$

i $16x - 3y - 8xy + 6$

5 What expanded expression factorises to the following?

a $(x - a)(x + 4)$

b $(x - c)(x - d)$

c $(x + y)(2 - z)$

d $(x - 1)(a + b)$

e $(3x - b)(c - b)$

f $(2x - y)(y + z)$

g $(3a + b)(2b + 5c)$

h $(m - 2x)(3y + z)$

i $(2p - 3q)(s + 2t)$

6 Note that $x^2 + 5x + 6 = x^2 + 2x + 3x + 6$, which can be factorised by grouping in pairs. Use a similar method to factorise the following.

a $x^2 + 7x + 10$

b $x^2 + 8x + 15$

c $x^2 + 10x + 24$

d $x^2 - x - 6$

e $x^2 + 4x - 12$

f $x^2 - 11x + 18$

REASONING

7

7

7, 8

7 $xa - 21 + 7a - 3x$ could be rearranged in two different ways before factorising.

Method 1

$$xa + 7a - 3x - 21 = a(x + 7) - 3(\underline{\hspace{2cm}})$$

$$= \underline{\hspace{4cm}}$$

Method 2

$$xa - 3x + 7a - 21 = x(a - 3) + 7(\underline{\hspace{2cm}})$$

$$= \underline{\hspace{4cm}}$$

a Copy and complete both methods for the above expression.

b Use different arrangements of the four terms to complete the factorisation of the following in two ways. Show working using both methods.

i $xb - 6 - 3b + 2x$

ii $xy - 8 + 2y - 4x$

iii $4m^2 - 15n + 6m - 10mn$

iv $2m + 3n - mn - 6$

v $4a - 6b^2 + 3b - 8ab$

vi $3ab - 4c - b + 12ac$

8 Make up at least three of your own four-term expressions that factorise to a binomial product. Describe the method that you used to make up each four-term expression.

ENRICHMENT: Grouping with more than four terms

-

-

9(½)

9 Factorise by grouping.

a $2(a - 3) - x(a - 3) - c(a - 3)$

b $b(2a + 1) + 5(2a + 1) - a(2a + 1)$

c $x(a + 1) - 4(a + 1) - ba - b$

d $3(a - b) - b(a - b) - 2a^2 + 2ab$

e $c(1 - a) - x + ax + 2 - 2a$

f $a(x - 2) + 2bx - 4b - x + 2$

g $a^2 - 3ac - 2ab + 6bc + 3abc - 9bc^2$

h $3x - 6xy - 5z + 10yz + y - 2y^2$

i $8z - 4y + 3x^2 + xy - 12x - 2xz$

j $-ab - 4cx + 3aby + 2abx + 2c - 6cy$



Using a CAS calculator 8E: Expanding and factorising

This activity is in the Interactive Textbook in the form of a printable PDF.

8F Factorising monic quadratic trinomials

LEARNING INTENTIONS

- To know the form of a monic quadratic trinomial
- To understand how a quadratic trinomial is formed from a binomial expansion
- To know how to find the numbers required to express a quadratic trinomial in factorised form

An expression that takes the form $x^2 + bx + c$, where b and c are constants, is an example of a monic quadratic trinomial that has the coefficient of x^2 equal to 1. To factorise a quadratic expression, we need to use the distributive law in reverse. Consider the expansion shown below:

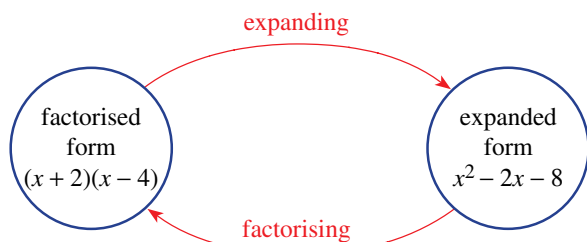

Quadratic equations are widely used in engineering, business and science, and factorisation is a key step when solving such equations. Self-driving cars are programmed to solve equations, including quadratic equations of motion.

If we examine the expansion above we can see how each term of the product is formed.

Product of x and x is x^2

$$(x + 2)(x - 4) = x^2 - 2x - 8$$

Product of 2 and -4 is -8
($2 \times (-4) = -8$, the constant term)

$$x \times (-4) = -4x$$

$$(x + 2)(x - 4) = x^2 - 2x - 8$$

$$2 \times x = 2x$$

Add $-4x$ and $2x$ to give the middle term, $-2x$
($-4 + 2 = -2$, the coefficient of x)

Lesson starter: So many choices

Mia says that as $-2 \times 3 = -6$ then $x^2 + 5x - 6$ must equal $(x - 2)(x + 3)$.

- Expand $(x - 2)(x + 3)$ to see if Mia is correct.
- What other pairs of numbers multiply to give -6 ?
- Which pair of numbers should Mia choose to correctly factorise $x^2 + 5x - 6$?
- What advice can you give Mia when trying to factorise these types of trinomials?

KEY IDEAS

- To factorise a **monic quadratic trinomial** of the form $x^2 + bx + c$, find two numbers that:
 - multiply to give c and
 - add to give b .
- Check factorisation steps by expanding.
- Write the factors in any order.

For example:

$$x^2 - 3x - 10 = (x - 5)(x + 2)$$

choose -5 and $+2$ since $-5 \times 2 = -10$
and $-5 + 2 = -3$

$$\text{check: } (x - 5)(x + 2) = x^2 + 2x - 5x - 10$$

$$= x^2 - 3x - 10$$

write $(x - 5)(x + 2)$ or $(x + 2)(x - 5)$

- If c is a negative number, the signs in the factorised expression will be different from each other.
- If c is a positive number, the signs in the factorised expression will be the same as each other.

BUILDING UNDERSTANDING

1 Give the result of expanding these binomial products.

a $(x + 2)(x + 7)$

b $(x + 3)(x + 11)$

c $(x + 12)(x - 5)$

d $(x - 2)(x - 6)$

2 Decide which two numbers multiply to give the first number and add to give the second number.

a 6, 5

b 12, 13

c 20, 9

d -15, 2

e -30, -1

f 18, -11



Example 11 Factorising monic quadratic trinomials

Factorise each of the following quadratic expressions.

a $x^2 + 7x + 10$

b $x^2 + 2x - 8$

c $x^2 - 7x + 10$

SOLUTION

a $x^2 + 7x + 10 = (x + 5)(x + 2)$

EXPLANATION

Need two numbers that \times to 10 and $+$ to 7. Factors of 10 include (10, 1) and (5, 2). The pair that adds to 7 is (5, 2).

b $x^2 + 2x - 8 = (x + 4)(x - 2)$

Need two numbers that \times to -8 and $+$ to 2. Factors of -8 are (-8, 1) or (8, -1) or (4, -2) or (-4, 2) and $4 + (-2) = 2$, so choose (4, -2).

c $x^2 - 7x + 10 = (x - 2)(x - 5)$

Need two numbers that \times to 10 and $+$ to -7. Factors of 10 are (10, 1) or (-10, -1) or (5, 2) or (-5, -2). To add to a negative (-7), both factors must then be negative: $-5 + (-2) = -7$, so choose (-5, -2).

Now you try

Factorise each of the following quadratic expressions.

a $x^2 + 9x + 14$

b $x^2 + 4x - 12$

c $x^2 - 7x + 12$



Example 12 Factorising with a common factor

Factorise the quadratic expression $2x^2 - 2x - 12$.

SOLUTION

$$\begin{aligned} 2x^2 - 2x - 12 &= 2(x^2 - x - 6) \\ &= 2(x - 3)(x + 2) \end{aligned}$$

EXPLANATION

First take out common factor of 2.

Factors of -6 are $(-6, 1)$ or $(6, -1)$ or $(-3, 2)$ or $(3, -2)$.

$-3 + 2 = -1$ so choose $(-3, 2)$.

Now you try

Factorise the quadratic expression $3x^2 - 6x - 45$.

Exercise 8F

FLUENCY

1-4($\frac{1}{2}$)1-5($\frac{1}{3}$)1-5($\frac{1}{3}$)

Example 11a

1 Factorise each of the following quadratic expressions.

a $x^2 + 8x + 12$

b $x^2 + 10x + 9$

c $x^2 + 8x + 7$

d $x^2 + 15x + 14$

e $x^2 + 7x + 12$

f $x^2 + 10x + 16$

g $x^2 + 8x + 15$

h $x^2 + 9x + 20$

i $x^2 + 11x + 24$

Example 11b

2 Factorise each of the following quadratic expressions.

a $x^2 + 3x - 4$

b $x^2 + x - 2$

c $x^2 + 4x - 5$

d $x^2 + 5x - 14$

e $x^2 + 2x - 15$

f $x^2 + 8x - 20$

g $x^2 + 3x - 18$

h $x^2 + 7x - 18$

i $x^2 + x - 12$

Example 11c

3 Factorise each of the following quadratic expressions.

a $x^2 - 6x + 5$

b $x^2 - 2x + 1$

c $x^2 - 5x + 4$

d $x^2 - 9x + 8$

e $x^2 - 4x + 4$

f $x^2 - 8x + 12$

g $x^2 - 11x + 18$

h $x^2 - 10x + 21$

i $x^2 - 5x + 6$

4 Factorise each of the following quadratic expressions.

a $x^2 - 7x - 8$

b $x^2 - 3x - 4$

c $x^2 - 5x - 6$

d $x^2 - 6x - 16$

e $x^2 - 2x - 24$

f $x^2 - 2x - 15$

g $x^2 - x - 12$

h $x^2 - 11x - 12$

i $x^2 - 4x - 12$

Example 12

5 Factorise each of the following quadratic expressions by first taking out a common factor.

a $2x^2 + 10x + 8$

b $2x^2 + 22x + 20$

c $3x^2 + 18x + 24$

d $2x^2 + 14x - 60$

e $2x^2 - 14x - 36$

f $4x^2 - 8x + 4$

g $2x^2 + 2x - 12$

h $6x^2 - 30x - 36$

i $5x^2 - 30x + 40$

j $3x^2 - 33x + 90$

k $2x^2 - 6x - 20$

l $3x^2 - 3x - 36$

PROBLEM-SOLVING

6

6(1/2), 7

6(1/2), 7

- 6 Find the missing term in these trinomials if they are to factorise using positive integers. For example: the missing term in $x^2 + \square + 10$ could be $7x$ because $x^2 + 7x + 10$ factorises to $(x + 5)(x + 2)$ and 5 and 2 are integers. There may be more than one answer in each case.

a $x^2 + \square + 5$

b $x^2 - \square + 9$

c $x^2 - \square - 12$

d $x^2 + \square - 12$

e $x^2 + \square + 18$

f $x^2 - \square + 18$

g $x^2 - \square - 16$

h $x^2 + \square - 25$

- 7 A rectangular backyard has a length 2 metres more than its width (x metres). Inside the rectangle are three paved squares each of area 5 m^2 as shown. The remaining area is lawn.

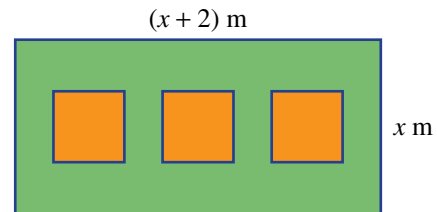

- a Find an expression for:
- the total backyard area
 - the area of lawn in expanded form
 - the area of lawn in factorised form.
- b Find the area of lawn if:
- $x = 10$
 - $x = 7$.

REASONING

8(1/2)

8(1/2)

8(1/2), 9

- 8 The expression $x^2 - 6x + 9$ factorises to $(x - 3)(x - 3) = (x - 3)^2$, which is a perfect square. Factorise these perfect squares. A common factor may also be involved.

a $x^2 + 8x + 16$

b $x^2 + 10x + 25$

c $x^2 + 30x + 225$

d $x^2 - 2x + 1$

e $x^2 - 14x + 49$

f $x^2 - 26x + 169$

g $2x^2 + 4x + 2$

h $5x^2 - 30x + 45$

i $-3x^2 + 36x - 108$

- 9 Sometimes it is not possible to factorise quadratic trinomials using integers. Decide which of the following cannot be factorised using integers.

a $x^2 - x - 56$

b $x^2 + 5x - 4$

c $x^2 + 7x - 6$

d $x^2 + 3x - 108$

e $x^2 + 3x - 1$

f $x^2 + 12x - 53$

ENRICHMENT: Completing the square

-

-

10

- 10 It is useful to be able to write a simple quadratic trinomial in the form $(x + b)^2 + c$. This involves adding (and subtracting) a special number to form the first perfect square. This procedure is called completing the square. Here is an example.

$$\begin{aligned} & \quad \quad \quad \left(-\frac{6}{2}\right)^2 = 9 \\ & \quad \quad \quad \curvearrowright \\ x^2 - 6x - 8 &= x^2 - 6x + 9 - 9 - 8 \\ & \quad \quad \quad \underbrace{\hspace{2cm}} \quad \underbrace{\hspace{2cm}} \\ & \quad \quad \quad = (x - 3)(x - 3) - 17 \\ & \quad \quad \quad = (x - 3)^2 - 17 \end{aligned}$$

Complete the square for these trinomials.

a $x^2 - 2x - 8$

b $x^2 + 4x - 1$

c $x^2 + 10x + 3$

d $x^2 - 16x - 3$

e $x^2 + 18x + 7$

f $x^2 - 32x - 11$

- 8A** 1 Expand the following.
- $(x + 4)(x + 2)$
 - $(a - 5)(a + 8)$
 - $(2x - 3)(x + 6)$
 - $(3a - b)(a - 2b)$
- 8B** 2 Expand each of the following perfect squares.
- $(y + 4)^2$
 - $(x - 3)^2$
 - $(2a - 3)^2$
 - $(7k + 2m)^2$
- 8B** 3 Expand and simplify the following.
- $(x + 5)(x - 5)$
 - $(11x - 9y)(11x + 9y)$
- 8C** 4 Factorise the following.
- $25a - 15$
 - $x^2 - 7x$
 - $-12x^2 - 16x$
 - $2(a + 3) + a(a + 3)$
 - $7(8 + a) - a(8 + a)$
 - $k(k - 4) - (k - 4)$
- 8D** 5 Factorise each of the following.
- $x^2 - 81$
 - $16a^2 - 49$
 - $25x^2 - y^2$
 - $2a^2 - 50$
 - $12x^2y^2 - 12$
 - $(h + 3)^2 - 64$
- 8E** 6 Use the method of grouping in pairs to factorise these expressions.
- $x^2 + 7x + 2x + 14$
 - $a^2 + 5a - 4a - 20$
 - $x^2 - hx + x - h$
- 8E** 7 Use grouping in pairs to factorise these expressions by first rearranging.
- $2x^2 - 9 - 6x + 3x$
 - $3ap - 10 + 2p - 15a$
- 8F** 8 Factorise these quadratic expressions.
- $x^2 + 6x + 8$
 - $a^2 + 2a - 15$
 - $m^2 - 11m + 30$
 - $2k^2 + 2k - 24$

8G Factorising trinomials of the form

$$ax^2 + bx + c \quad \text{EXTENDING}$$

LEARNING INTENTION

- To know the process for factorising a trinomial of the form $ax^2 + bx + c$ where a is not a common factor

So far we have factorised quadratic trinomials in which the coefficient of x^2 is 1, such as $x^2 - 3x - 40$. These are called monic trinomials. We will now consider non-monic trinomials in which the coefficient of x is not equal to 1 and is also not a factor common to all three terms, such as in $6x^2 + x - 15$. The method used in this section uses grouping in pairs, which was discussed in **Section 8E**.



Flight simulators are programmed to replicate an aircraft's response to pilot input and weather conditions. Modelling plane flight includes quadratic equations, as the upward force on a plane's wing is proportional to the square of its airspeed.

Lesson starter: How the grouping in pairs method works

Consider the trinomial $2x^2 + 9x + 10$.

- First write $2x^2 + 9x + 10 = 2x^2 + 4x + 5x + 10$ then factorise by grouping in pairs.
- Note that $9x$ was split to give $4x + 5x$ and the product of $2x^2$ and 10 is $20x^2$. Describe the link between the pair of numbers $\{4, 5\}$ and the pair of numbers $\{2, 10\}$.
- Why was $9x$ split to give $4x + 5x$ and not, say, $3x + 6x$?
- Describe how the $13x$ should be split in $2x^2 + 13x + 15$ so it can be factorised by grouping in pairs.
- Now try your method for $2x^2 - 7x - 15$.

KEY IDEAS

- To factorise a trinomial of the form $ax^2 + bx + c$, there are several different methods which can be used. Three methods are shown in this section.

- Method 1 involves grouping in pairs.

For example:

$$\begin{aligned} & 5x^2 + 13x - 6 \\ & = 5x^2 - 2x + 15x - 6 \\ & = x(5x - 2) + 3(5x - 2) \\ \therefore 5x^2 + 13x - 6 & = (5x - 2)(x + 3) \end{aligned}$$

or

$$5x^2 + 13x - 6 = (x + 3)(5x - 2)$$

This expression has no common factors.

c is negative, so look for two numbers with different signs.

Multiply a and c to give -30 . Factors of -30 are $(-1, 30)$, $(1, -30)$, $(-2, 15)$, $(2, -15)$ etc.

Look for two numbers that multiply to give -30 and add to give $+13$.

Those numbers are $(-2, 15)$.

Split the middle term into two terms.

Factorise the pairs and look for a common factor.

Take out the common factor. Check the answer by expanding.

- Method 2 involves the use of an algebraic fraction. For example:

$$\begin{aligned} & 5x^2 + 13x - 6 \\ & = \frac{(5x - 2)(5x + 15)}{5} \\ & = \frac{(5x - 2)(5^1x + 15^3)}{5^1} \end{aligned}$$

This expression has no common factors.

c is negative, so the factors contain different signs.

Multiply a and c to give -30 . Factors of -30 include $(-1, 30)$, $(1, -30)$, $(-2, 15)$, $(2, -15)$ etc.

Look for two numbers that multiply to give -30 and add to give $+13$.

Those numbers are $(-2, 15)$.

Set up a fraction and use the value of a in three places.

$$\frac{(5x \quad)(5x \quad)}{5}$$

Insert the two numbers, then try to simplify the fraction.

It should always be possible to simplify the denominator to 1.

It might require two steps.

Check the answer by expanding (same as method 1).

$$\begin{aligned} \therefore 5x^2 + 13x - 6 & = (5x - 2)(x + 3) \\ \text{or } 5x^2 + 13x - 6 & = (x + 3)(5x - 2) \end{aligned}$$

- Method 3 is often called the 'cross method'. It is explained in the Enrichment section at the end of Exercise 8G.

BUILDING UNDERSTANDING

- 1 State the two numbers that satisfy the given criteria.
 - a Multiply to give 12 and add to give 8
 - b Multiply to give -24 and add to give 5
 - c Multiply to give 35 and add to give -12
 - d Multiply to give -28 and add to give -3

2 State the missing terms for these factorisations.

$$\begin{array}{ll} \text{a } 2x^2 + 7x + 5 = 2x^2 + 2x + \underline{\quad} + 5 & \text{b } 2x^2 - 7x + 6 = 2x^2 - 3x - \underline{\quad} + 6 \\ & = 2x(\underline{\quad}) + 5(\underline{\quad}) & = x(\underline{\quad}) - 2(\underline{\quad}) \\ & = (\underline{\quad})(\underline{\quad}) & = (\underline{\quad})(\underline{\quad}) \\ \\ \text{c } 5x^2 + 9x - 2 = 5x^2 + 10x - \underline{\quad} - 2 & \text{d } 4x^2 + 11x + 6 = 4x^2 + \underline{\quad} + 3x + 6 \\ & = 5x(\underline{\quad}) - 1(\underline{\quad}) & = (\underline{\quad})(x + 2) + 3(\underline{\quad}) \\ & = (\underline{\quad})(\underline{\quad}) & = (\underline{\quad})(\underline{\quad}) \end{array}$$

Example 13 Factorising trinomials of the form $ax^2 + bx + c$

Factorise $2x^2 + 7x + 3$.

SOLUTION

$$\begin{aligned} 2x^2 + 7x + 3 &= 2x^2 + x + 6x + 3 \\ &= x(2x + 1) + 3(2x + 1) \\ &= (2x + 1)(x + 3) \end{aligned}$$

EXPLANATION

$a \times c = 2 \times 3 = 6$, then ask what factors of this number (6) add to 7. The answer is 1 and 6, so split $7x$ into $x + 6x$ and factorise by grouping in pairs.

Now you try

Factorise $3x^2 + 11x + 6$.

Example 14 Factorising trinomials involving negative numbers

Factorise these quadratic trinomials.

a $4x^2 + 5x - 6$

b $6x^2 - 17x + 12$

SOLUTION

$$\begin{aligned} \text{a } 4x^2 + 5x - 6 &= 4x^2 + 8x - 3x - 6 \\ &= 4x(x + 2) - 3(x + 2) \\ &= (x + 2)(4x - 3) \end{aligned}$$

$$\begin{aligned} \text{b } 6x^2 - 17x + 12 &= 6x^2 - 9x - 8x + 12 \\ &= 3x(2x - 3) - 4(2x - 3) \\ &= (2x - 3)(3x - 4) \end{aligned}$$

EXPLANATION

$4 \times (-6) = -24$, so ask what factors of -24 add to give 5. Choose 8 and -3 . Then complete the factorisation by grouping in pairs.

$6 \times 12 = 72$, so ask what factors of 72 add to give -17 . Choose -9 and -8 .

Complete a mental check.

$$\begin{aligned} &(2x - 3)(3x - 4) \\ &\quad \begin{array}{c} -9x \\ -8x \end{array} \\ &\quad -9x - 8x = -17x \end{aligned}$$

Now you try

Factorise these quadratic trinomials.

a $4x^2 + 4x - 15$

b $8x^2 - 18x + 9$

Exercise 8G

FLUENCY

1–2($\frac{1}{2}$)1–2($\frac{1}{2}$)1–2($\frac{1}{3}$)

Example 13

1 Factorise these quadratic trinomials.

a $2x^2 + 9x + 4$

b $3x^2 + 7x + 2$

c $2x^2 + 7x + 6$

d $3x^2 + 8x + 4$

e $5x^2 + 12x + 4$

f $2x^2 + 11x + 12$

g $6x^2 + 13x + 5$

h $4x^2 + 5x + 1$

i $8x^2 + 14x + 5$

Example 14

2 Factorise these quadratic trinomials.

a $3x^2 + 2x - 5$

b $5x^2 + 6x - 8$

c $8x^2 + 10x - 3$

d $6x^2 - 13x - 8$

e $10x^2 - 3x - 4$

f $5x^2 - 11x - 12$

g $4x^2 - 16x + 15$

h $2x^2 - 15x + 18$

i $6x^2 - 19x + 10$

j $12x^2 - 13x - 4$

k $4x^2 - 12x + 9$

l $7x^2 + 18x - 9$

m $9x^2 + 44x - 5$

n $3x^2 - 14x + 16$

o $4x^2 - 4x - 15$

PROBLEM-SOLVING

3($\frac{1}{2}$)3–4($\frac{1}{2}$)3($\frac{1}{2}$), 4($\frac{1}{3}$), 5($\frac{1}{2}$)

3 Factorise by first taking out a common factor.

a $30x^2 - 14x - 4$

b $12x^2 + 18x - 30$

c $27x^2 - 54x + 15$

d $21x^2 - 77x + 42$

e $36x^2 + 36x - 40$

f $50x^2 - 35x - 60$

4 Factorise these quadratic trinomials.

a $10x^2 + 27x + 11$

b $15x^2 + 14x - 8$

c $20x^2 - 36x + 9$

d $18x^2 - x - 5$

e $25x^2 + 5x - 12$

f $32x^2 - 12x - 5$

g $27x^2 + 6x - 8$

h $33x^2 + 41x + 10$

i $54x^2 - 39x - 5$

j $12x^2 - 32x + 21$

k $75x^2 - 43x + 6$

l $90x^2 + 33x - 8$

5 Factorise these trinomials.

a $-2x^2 + 7x - 6$

b $-5x^2 - 3x + 8$

c $-6x^2 + 13x + 8$

d $18 - 9x - 5x^2$

e $16x - 4x^2 - 15$

f $14x - 8x^2 - 5$

REASONING

6

6

6, 7

6 When splitting the $3x$ in $2x^2 + 3x - 20$, you could write:

A $2x^2 + 8x - 5x - 20$

or

B $2x^2 - 5x + 8x - 20$.

a Complete the factorisation using A.

b Complete the factorisation using B.

c Does the order matter when you split the $3x$?

d Factorise these trinomials twice each. Factorise once by grouping in pairs then repeat but reverse the order of the two middle terms in the first line of working.

i $3x^2 + 5x - 12$

ii $5x^2 - 3x - 14$

iii $6x^2 + 5x - 4$

- 7 Make up five non-monic trinomials in which the coefficient of x^2 is not equal to 1 and which factorise using the above method. Explain your method in finding these trinomials.



The stopping distance of a vehicle depends on its velocity and can be modelled by a quadratic equation.

ENRICHMENT: The cross method

-

-

8(1/3)

- 8 The cross method is another way to factorise trinomials of the form $ax^2 + bx + c$. It involves finding factors of ax^2 and factors of c then choosing pairs of these factors that add to bx .

For example: Factorise $6x^2 - x - 15$.

Factors of $6x^2$ include $(x, 6x)$ and $(2x, 3x)$.

Factors of -15 include $(15, -1)$, $(-15, 1)$, $(5, -3)$ and $(-5, 3)$.

We arrange a chosen pair of factors vertically then cross-multiply and add to get $-1x$.

$\begin{array}{r} x \swarrow 15 \\ 6x \searrow -1 \end{array}$	$\begin{array}{r} x \swarrow 5 \\ 6x \searrow -3 \end{array}$	$\dots\dots\dots$	$\begin{array}{r} 2x \swarrow 3 \\ 3x \searrow -5 \end{array}$	$\longleftarrow (2x + 3)$ $\longleftarrow (3x - 5)$
$x \times (-1) + 6x \times 15$ $= 89x \neq -1x$	$x \times (-3) + 6x \times 5$ $= 27x \neq -1x$		$2x \times (-5) + 3x \times 3$ $= -1x$	

You will need to continue until a particular combination works. The third cross-product gives a sum of $-1x$ so choose the factors $(2x + 3)$ and $(3x - 5)$, therefore:

$$6x^2 - x - 15 = (2x + 3)(3x - 5)$$

Try this method on the trinomials from Questions 2 and 4.



Without air resistance, an object's path, subject to the Moon's gravity, can be modelled accurately using quadratic equations.

8H Simplifying algebraic fractions: Multiplication and division

LEARNING INTENTIONS

- To understand that cancelling in algebraic fractions can only take place using a common factor
- To be able to simplify algebraic fractions by cancelling common factors
- To know to factorise expressions and cancel common factors before multiplying or dividing
- To be able to multiply algebraic fractions by multiplying numerators and denominators
- To be able to divide an algebraic fraction by multiplying by the reciprocal of the fraction after the division sign

With a numerical fraction such as $\frac{6}{9}$, the highest common factor of 6 and 9 is 3, which can be cancelled: $\frac{6}{9} = \frac{\cancel{3} \times 2}{\cancel{3} \times 3} = \frac{2}{3}$. For algebraic fractions the process is the same. If expressions are in a factorised form, common factors can be easily identified and cancelled.

Lesson starter: Correct cancelling

Consider this cancelling attempt:

$$\frac{5x + 10^1}{20_2} = \frac{5x + 1}{2}$$

- Substitute $x = 6$ into the left-hand side to evaluate $\frac{5x + 10}{20}$.
- Substitute $x = 6$ into the right-hand side to evaluate $\frac{5x + 1}{2}$.
- What do you notice about the two answers? How can you explain this?
- Decide how you might correctly cancel the expression on the left-hand side. Show your steps and check by substituting a value for x .

KEY IDEAS

- Simplify **algebraic fractions** by factorising and cancelling only common factors.

Incorrect

$$\frac{2x + 4^2}{2^1} = 2x + 2$$

Correct

$$\begin{aligned} \frac{2x + 4}{2} &= \frac{12(x + 2)}{2^1} \\ &= x + 2 \end{aligned}$$

- To multiply algebraic fractions:
 - factorise expressions where possible
 - cancel if possible
 - multiply the numerators and the denominators.
- To divide algebraic fractions:
 - multiply by the reciprocal of the fraction following the division sign
 - follow the rules for multiplication after converting to the reciprocal.
 - The reciprocal of $\frac{a}{b}$ is $\frac{b}{a}$.

BUILDING UNDERSTANDING

1 State the result after simplifying these fractions using cancelling.

a $\frac{5}{15}$

b $\frac{8x}{12}$

c $\frac{24}{8x}$

d $\frac{3(x+1)}{6}$

2 Factorise by taking out common factors.

a $3x + 6$

b $20 - 40x$

c $x^2 - 7x$

d $6x^2 + 24x$

3 State the missing terms.

$$\begin{aligned} \text{a } \frac{2x - 4}{8} &= \frac{2(\boxed{})}{8} \\ &= \frac{\boxed{}}{4} \end{aligned}$$

$$\begin{aligned} \text{b } \frac{12 - 18x}{2x - 3x^2} &= \frac{6(\boxed{})}{x(\boxed{})} \\ &= \frac{6}{x} \end{aligned}$$

4 Simplify:

a $\frac{6}{7} \times \frac{21}{2}$

b $\frac{5}{8} \div \frac{15}{2}$



Example 15 Simplifying algebraic fractions

Simplify the following by cancelling.

a $\frac{3(x+2)(x-4)}{6(x-4)}$

b $\frac{20-5x}{8-2x}$

c $\frac{x^2-4}{x+2}$

SOLUTION

$$\text{a } \frac{\overset{1}{3}(x+2)(\cancel{x-4})^1}{\overset{2}{6}(\cancel{x-4})^1} = \frac{x+2}{2}$$

$$\begin{aligned} \text{b } \frac{20-5x}{8-2x} &= \frac{5(\cancel{4-x})^1}{2(\cancel{4-x})^1} \\ &= \frac{5}{2} \end{aligned}$$

$$\begin{aligned} \text{c } \frac{x^2-4}{x+2} &= \frac{\overset{1}{(x+2)}(\cancel{x-2})^1}{(\cancel{x+2})^1} \\ &= x-2 \end{aligned}$$

EXPLANATION

Cancel the common factors $(x-4)$ and 3.

Factorise the numerator and denominator then cancel common factor of $(4-x)$.

Factorise the difference of squares in the numerator then cancel the common factor.

Now you try

Simplify the following by cancelling.

a $\frac{4(x+1)(x-3)}{12(x+1)}$

b $\frac{3-6x}{5-10x}$

c $\frac{x^2-9}{x+3}$



Example 16 Multiplying and dividing algebraic fractions

Simplify the following.

$$\text{a } \frac{3(x-1)}{(x+2)} \times \frac{4(x+2)}{9(x-1)(x-7)}$$

$$\text{b } \frac{(x-3)(x+4)}{x(x+7)} \div \frac{3(x+4)}{x+7}$$

$$\text{c } \frac{x^2-4}{25} \times \frac{5x+5}{x^2-x-2}$$

SOLUTION

$$\begin{aligned} \text{a } & \frac{\overset{1}{\cancel{3}}(\cancel{x-1})^1}{(\cancel{x+2})_1} \times \frac{4(\cancel{x+2})^1}{\overset{3}{\cancel{9}}(\cancel{x-1})_1(x-7)} \\ &= \frac{1 \times 4}{1 \times 3(x-7)} \\ &= \frac{4}{3(x-7)} \end{aligned}$$

$$\begin{aligned} \text{b } & \frac{(x-3)(x+4)}{x(x+7)} \div \frac{3(x+4)}{x+7} \\ &= \frac{(x-3)(\cancel{x+4})^1}{x(\cancel{x+7})_1} \times \frac{(\cancel{x+7})^1}{3(\cancel{x+4})^1} \\ &= \frac{x-3}{3x} \end{aligned}$$

$$\begin{aligned} \text{c } & \frac{x^2-4}{25} \times \frac{5x+5}{x^2-x-2} \\ &= \frac{\overset{1}{\cancel{(x-2)}}(\cancel{x+2})^1}{25^5} \times \frac{\overset{5^1}{\cancel{5}}(\cancel{x+1})^1}{(\cancel{x-2})(\cancel{x+1})_1} \\ &= \frac{x+2}{5} \end{aligned}$$

EXPLANATION

First, cancel any factors in the numerators with a common factor in the denominators. Then multiply the numerators and the denominators.

Multiply by the reciprocal of the fraction after the division sign.

Cancel common factors and multiply remaining numerators and denominators.

First factorise all the algebraic expressions. Note that $x^2 - 4$ is a difference of two squares. Then cancel as normal.

Now you try

Simplify the following.

$$\text{a } \frac{2(x+1)}{(x-3)} \times \frac{9(x-3)}{10(x+1)(x-4)}$$

$$\text{b } \frac{4(x-2)(x+2)}{x(x-1)} \div \frac{2(x+2)}{x-1}$$

$$\text{c } \frac{x^2-5x+6}{18} \times \frac{6x+12}{x^2-4}$$

Exercise 8H

FLUENCY

1-3(1/2), 5-6(1/2)

1-6(1/2)

1-6(1/2)

Example 15a

1 Simplify the following by cancelling.

a $\frac{3(x+2)}{4(x+2)}$

b $\frac{x(x-3)}{3x(x-3)}$

c $\frac{20(x+7)}{5(x+7)}$

d $\frac{(x+5)(x-5)}{(x+5)}$

e $\frac{6(x-1)(x+3)}{9(x+3)}$

f $\frac{8(x-2)}{4(x-2)(x+4)}$

Example 15b

2 Simplify the following by factorising and then cancelling.

a $\frac{5x-5}{5}$

b $\frac{4x-12}{10}$

c $\frac{2x-4}{3x-6}$

d $\frac{12-4x}{6-2x}$

e $\frac{x^2-3x}{x}$

f $\frac{4x^2+10x}{5x}$

g $\frac{3x+3y}{2x+2y}$

h $\frac{4x-8y}{3x-6y}$

Example 15c

3 Simplify the following. These expressions involve difference of two squares.

a $\frac{x^2-100}{x+10}$

b $\frac{x^2-49}{x+7}$

c $\frac{x^2-25}{x+5}$

d $\frac{2(x-20)}{x^2-400}$

e $\frac{5(x-6)}{x^2-36}$

f $\frac{3x+27}{x^2-81}$

4 Simplify by first factorising the trinomials.

a $\frac{x^2-x-6}{x-3}$

b $\frac{x^2+8x+16}{x+4}$

c $\frac{x^2-7x+12}{x-4}$

d $\frac{x-2}{x^2+x-6}$

e $\frac{x+7}{x^2+5x-14}$

f $\frac{x-9}{x^2-19x+90}$

Example 16a

5 Simplify the following by cancelling.

a $\frac{2x(x-4)}{4(x+1)} \times \frac{(x+1)}{x}$

b $\frac{(x+2)(x-3)}{x-5} \times \frac{x-5}{x+2}$

c $\frac{x-3}{x+2} \times \frac{3(x+4)(x+2)}{x+4}$

d $\frac{2(x+3)(x+4)}{(x+1)(x-5)} \times \frac{(x+1)}{4(x+3)}$

Example 16b

6 Simplify the following by cancelling.

a $\frac{x(x+1)}{x+3} \div \frac{x+1}{x+3}$

b $\frac{x+3}{x+2} \div \frac{x+3}{2(x-2)}$

c $\frac{x-4}{(x+3)(x+1)} \div \frac{x-4}{4(x+3)}$

d $\frac{4x}{x+2} \div \frac{8x}{x-2}$

e $\frac{3(4x-9)(x+2)}{2(x+6)} \div \frac{9(x+4)(4x-9)}{4(x+2)(x+6)}$

f $\frac{5(2x-3)}{(x+7)} \div \frac{(x+2)(2x-3)}{x+7}$

PROBLEM-SOLVING

7($\frac{1}{2}$)7($\frac{1}{2}$)7($\frac{1}{2}$)

Example 16c

- 7 These expressions involve a combination of trinomials, difference of two squares and simple common factors. Simplify by first factorising where possible.

$$\text{a } \frac{x^2 + 5x + 6}{x + 5} \div \frac{x + 3}{x^2 - 25}$$

$$\text{b } \frac{x^2 + 6x + 8}{x^2 - 9} \div \frac{x + 4}{x - 3}$$

$$\text{c } \frac{x^2 + x - 12}{x^2 + 8x + 16} \times \frac{x^2 - 16}{x^2 - 8x + 16}$$

$$\text{d } \frac{x^2 + 12x + 35}{x^2 - 25} \times \frac{x^2 - 10x + 25}{x^2 + 9x + 14}$$

$$\text{e } \frac{9x^2 - 3x}{6x - 45x^2}$$

$$\text{f } \frac{x^2 - 4x}{3x - x^2}$$

$$\text{g } \frac{3x^2 - 21x + 36}{2x^2 - 32} \times \frac{2x + 10}{6x - 18}$$

$$\text{h } \frac{2x^2 - 18x + 40}{x^2 - x - 12} \times \frac{3x + 15}{4x^2 - 100}$$

REASONING

8

8

8-9($\frac{1}{2}$)

- 8 Just as $\frac{a^2}{2a}$ can be cancelled to $\frac{a}{2}$, $\frac{(a+5)^2}{2(a+5)}$ cancels to $\frac{a+5}{2}$. Use this idea to cancel these fractions.

$$\text{a } \frac{(a+1)^2}{(a+1)}$$

$$\text{b } \frac{5(a-3)^2}{(a-3)}$$

$$\text{c } \frac{7(x+7)^2}{14(x+7)}$$

$$\text{d } \frac{3(x-1)(x+2)^2}{18(x-1)(x+2)}$$

$$\text{e } \frac{x^2 + 6x + 9}{2x + 6}$$

$$\text{f } \frac{11x - 22}{x^2 - 4x + 4}$$

- 9 The expression $\frac{5-2x}{2x-5}$ can be written in the form $\frac{-1(-5+2x)}{2x-5} = \frac{-1(2x-5)}{2x-5}$, which can be cancelled to -1 .

Use this idea to simplify these algebraic fractions.

$$\text{a } \frac{7-3x}{3x-7}$$

$$\text{b } \frac{4x-1}{1-4x}$$

$$\text{c } \frac{8x+16}{-2-x}$$

$$\text{d } \frac{x+3}{-9-3x}$$

$$\text{e } \frac{5-3x}{18x-30}$$

$$\text{f } \frac{x^2-9}{3-x}$$

ENRICHMENT: All in together

-

-

10($\frac{1}{2}$)

- 10 Use your knowledge of factorisation and the ideas in Questions 8 and 9 above to simplify these algebraic fractions.

$$\text{a } \frac{2x^2 - 2x - 24}{16 - 4x}$$

$$\text{b } \frac{x^2 - 14x + 49}{21 - 3x}$$

$$\text{c } \frac{x^2 - 16x + 64}{64 - x^2}$$

$$\text{d } \frac{4 - x^2}{x^2 + x - 6} \times \frac{2x + 6}{x^2 + 4x + 4}$$

$$\text{e } \frac{2x^2 - 18}{x^2 - 6x + 9} \times \frac{6 - 2x}{x^2 + 6x + 9}$$

$$\text{f } \frac{x^2 - 2x + 1}{4 - 4x} \div \frac{1 - x^2}{3x^2 + 6x + 3}$$

$$\text{g } \frac{4x^2 - 9}{x^2 - 5x} \div \frac{6 - 4x}{15 - 3x}$$

$$\text{h } \frac{x^2 - 4x + 4}{8 - 4x} \times \frac{-2}{4 - x^2}$$

$$\text{i } \frac{(x+2)^2 - 4}{(1-x)^2} \times \frac{x^2 - 2x + 1}{3x + 12}$$

$$\text{j } \frac{2(x-3)^2 - 50}{x^2 - 11x + 24} \div \frac{x^2 - 4}{3 - x}$$

81 Simplifying algebraic fractions: Addition and subtraction

LEARNING INTENTIONS

- To be able to find a lowest common denominator involving numbers and pronumerals
- To know to express each fraction as an equivalent fraction with a common denominator before combining under addition or subtraction
- To be able to add or subtract numerators by simplifying

The process required for adding or subtracting algebraic fractions is similar to that used for fractions without pronumerals.

To simplify $\frac{2}{3} + \frac{4}{5}$, for example, you would find the lowest common multiple of the denominators (15) then express each fraction using this denominator. Adding the numerators completes the task. The same process is applied to $\frac{2x}{3} + \frac{4x}{5}$.



Financial analysts and economists use algebraic fractions when finding current amounts, such as a government's future income tax and future spending. Finding \$ P that compounds to \$ A at $r\%$ p.a. in n years, uses

$$A = P \left(1 + \frac{r}{100} \right)^n$$

Lesson starter: Compare the working

Here is the working for the simplification of the sum of a pair of numerical fractions and the sum of a pair of algebraic fractions.

$$\begin{aligned} \frac{2}{5} + \frac{3}{4} &= \frac{8}{20} + \frac{15}{20} \\ &= \frac{23}{20} \end{aligned}$$

$$\begin{aligned} \frac{2x}{5} + \frac{3x}{4} &= \frac{8x}{20} + \frac{15x}{20} \\ &= \frac{23x}{20} \end{aligned}$$

- What type of steps were taken to simplify the algebraic fractions that are the same as for the numerical fractions?
- Write down the steps required to add (or subtract) algebraic fractions.

KEY IDEAS

- To add or subtract algebraic fractions:
 - determine the lowest common denominator (LCD)
 - express each fraction using the LCD
 - add or subtract the numerators.

BUILDING UNDERSTANDING

1 Find the lowest common multiple of these pairs of numbers.

a 6, 8

b 3, 5

c 11, 13

d 12, 18

2 State the missing terms in the following expressions.

a $\frac{7x}{3} = \frac{\square}{9}$

b $\frac{3x+5}{11} = \frac{\square(3x+5)}{22}$

c $\frac{4}{x} = \frac{\square}{2x}$

d $\frac{30}{x+1} = \frac{\square}{3(x+1)}$

3 State the missing terms in these simplifications.

a $\frac{x}{4} + \frac{2x}{3} = \frac{\square}{12} + \frac{\square}{12} = \frac{\square}{12}$

b $\frac{5x}{7} - \frac{2x}{5} = \frac{\square}{35} - \frac{\square}{35} = \frac{\square}{35}$

c $\frac{x+1}{2} + \frac{2x+3}{4} = \frac{\square(x+1)}{4} + \frac{2x+3}{4} = \frac{\square}{4} + \frac{2x+3}{4} = \frac{\square}{4}$

4 State the LCD for these pairs of fractions.

a $\frac{x}{3}, \frac{2x}{5}$

b $\frac{3x}{7}, \frac{x}{2}$

c $\frac{2x}{3}, \frac{-5x}{6}$



Example 17 Adding and subtracting with numerals in the denominators

Simplify:

a $\frac{x}{4} - \frac{2x}{5}$

b $\frac{7x}{3} + \frac{x}{6}$

c $\frac{x+3}{2} + \frac{x-2}{5}$

SOLUTION

$$\begin{aligned} \text{a } \frac{x}{4} - \frac{2x}{5} &= \frac{5x}{20} - \frac{8x}{20} \\ &= -\frac{3x}{20} \end{aligned}$$

$$\begin{aligned} \text{b } \frac{7x}{3} + \frac{x}{6} &= \frac{14x}{6} + \frac{x}{6} \\ &= \frac{15x}{6} \\ &= \frac{5x}{2} \end{aligned}$$

$$\begin{aligned} \text{c } \frac{x+3}{2} + \frac{x-2}{5} &= \frac{5(x+3)}{10} + \frac{2(x-2)}{10} \\ &= \frac{5x+15+2x-4}{10} \\ &= \frac{7x+11}{10} \end{aligned}$$

EXPLANATION

Determine the LCD for 4 and 5, i.e. 20. Express each fraction as an equivalent fraction with a denominator of 20. Then subtract numerators.

Note the LCD for 3 and 6 is 6 not $3 \times 6 = 18$.

Simplify $\frac{15}{6}$ to $\frac{5}{2}$ in the final step, dividing the numerator and denominator by 3.

The LCD for 2 and 5 is 10; write as equivalent fractions with denominator 10.

Expand the brackets and simplify the numerator by adding and collecting like terms.

Now you try

Simplify:

a $\frac{x}{3} - \frac{3x}{4}$

b $\frac{5x}{4} + \frac{x}{8}$

c $\frac{x+2}{3} + \frac{x-4}{2}$



Example 18 Adding and subtracting with algebraic terms in the denominators

Simplify:

a $\frac{2}{x} - \frac{5}{2x}$

b $\frac{2}{x} + \frac{3}{x^2}$

SOLUTION

$$\begin{aligned} \text{a } \frac{2}{x} - \frac{5}{2x} &= \frac{4}{2x} - \frac{5}{2x} \\ &= -\frac{1}{2x} \end{aligned}$$

$$\begin{aligned} \text{b } \frac{2}{x} + \frac{3}{x^2} &= \frac{2x}{x^2} + \frac{3}{x^2} \\ &= \frac{2x+3}{x^2} \end{aligned}$$

EXPLANATION

The LCD for x and $2x$ is $2x$, so rewrite the first fraction in an equivalent form with a denominator also of $2x$.

The LCD for x and x^2 is x^2 , so rewrite the first fraction in an equivalent form so its denominator is also x^2 , then add numerators.

Now you try

Simplify:

a $\frac{3}{x} - \frac{4}{3x}$

b $\frac{4}{x} + \frac{5}{x^2}$

Exercise 8I

FLUENCY

1-4($\frac{1}{2}$)

1-4($\frac{1}{2}$)

1($\frac{1}{4}$), 2($\frac{1}{3}$), 3-4($\frac{1}{2}$)

Example 17a,b

1 Simplify:

a $\frac{x}{7} + \frac{x}{2}$

b $\frac{x}{3} + \frac{x}{15}$

c $\frac{x}{4} - \frac{x}{8}$

d $\frac{x}{9} + \frac{x}{5}$

e $\frac{y}{7} - \frac{y}{8}$

f $\frac{a}{2} + \frac{a}{11}$

g $\frac{b}{3} - \frac{b}{9}$

h $\frac{m}{3} - \frac{m}{6}$

i $\frac{m}{6} + \frac{3m}{4}$

j $\frac{a}{4} + \frac{2a}{7}$

k $\frac{2x}{5} + \frac{x}{10}$

l $\frac{p}{9} - \frac{3p}{7}$

m $\frac{b}{2} - \frac{7b}{9}$

n $\frac{9y}{8} + \frac{2y}{5}$

o $\frac{4x}{7} - \frac{x}{5}$

p $\frac{3x}{4} - \frac{x}{3}$

Example 17c

2 Simplify:

a $\frac{x+1}{2} + \frac{x+3}{5}$

b $\frac{x+3}{3} + \frac{x-4}{4}$

c $\frac{a-2}{7} + \frac{a-5}{8}$

d $\frac{y+4}{5} + \frac{y-3}{6}$

e $\frac{m-4}{8} + \frac{m+6}{5}$

f $\frac{x-2}{12} + \frac{x-3}{8}$

g $\frac{2b-3}{6} + \frac{b+2}{8}$

h $\frac{3x+8}{6} + \frac{2x-4}{3}$

i $\frac{2y-5}{7} + \frac{3y+2}{14}$

j $\frac{2t-1}{8} + \frac{t-2}{16}$

k $\frac{4-x}{3} + \frac{2-x}{7}$

l $\frac{2m-1}{4} + \frac{m-3}{6}$

Example 18a

3 Simplify:

a $\frac{3}{x} + \frac{5}{2x}$

b $\frac{7}{3x} - \frac{2}{x}$

c $\frac{7}{4x} - \frac{5}{2x}$

d $\frac{4}{3x} + \frac{2}{9x}$

e $\frac{3}{4x} - \frac{2}{5x}$

f $\frac{2}{3x} + \frac{1}{5x}$

g $\frac{-3}{4x} - \frac{7}{x}$

h $\frac{-5}{3x} - \frac{3}{4x}$

Example 18b

4 Simplify:

a $\frac{3}{x} + \frac{2}{x^2}$

b $\frac{5}{x^2} + \frac{4}{x}$

c $\frac{7}{x} + \frac{3}{x^2}$

d $\frac{4}{x} - \frac{5}{x^2}$

e $\frac{3}{x^2} - \frac{8}{x}$

f $-\frac{4}{x^2} + \frac{1}{x}$

g $\frac{3}{x} - \frac{7}{2x^2}$

h $-\frac{2}{3x} + \frac{3}{x^2}$

PROBLEM-SOLVING

5

5-6(1/2)

5(1/2), 6, 7

5 Simplify these mixed algebraic fractions.

a $\frac{2}{x} + \frac{x}{4}$

b $\frac{-5}{x} + \frac{x}{2}$

c $\frac{-2}{x} - \frac{4x}{3}$

d $\frac{3}{2x} - \frac{5x}{4}$

e $\frac{3x}{4} - \frac{5}{6x}$

f $\frac{1}{3x} - \frac{x}{9}$

g $\frac{-2}{5x} + \frac{3x}{2}$

h $\frac{-5}{4x} - \frac{3x}{10}$

6 Find the missing algebraic fraction. The fraction should be in simplest form.

a $\frac{x}{2} + \frac{\square}{\square} = \frac{5x}{6}$

b $\frac{\square}{\square} + \frac{x}{4} = \frac{3x}{8}$

c $\frac{2x}{5} + \frac{\square}{\square} = \frac{9x}{10}$

d $\frac{2x}{3} - \frac{\square}{\square} = \frac{7x}{15}$

e $\frac{\square}{\square} - \frac{x}{3} = \frac{5x}{9}$

f $\frac{2x}{3} - \frac{\square}{\square} = \frac{5x}{12}$

7 A hiker walks x metres up a hill at $\frac{6}{5}$ m/s and walks back down the same path to where they started at 2 m/s.

- a Give a simplified expression for the total time in seconds of the walk in terms of x .
- b Use your answer to part a to find the time taken if $x = 150$.



REASONING

8

8, 9

8, 9

8 Find and describe the error in each set of working. Then find the correct answer.

a $\frac{4x}{5} - \frac{x}{3} = \frac{3x}{2}$

b $\frac{x+1}{5} + \frac{x}{2} = \frac{2x+1}{10} + \frac{5x}{10}$
 $= \frac{7x+1}{10}$

c $\frac{5x}{3} + \frac{x-1}{2} = \frac{10x}{6} + \frac{3x-1}{6}$
 $= \frac{13x-1}{6}$

d $\frac{2}{x} - \frac{3}{x^2} = \frac{2}{x^2} - \frac{3}{x^2}$
 $= \frac{-1}{x^2}$

9 A student thinks that the LCD to use when simplifying $\frac{x+1}{2} + \frac{2x-1}{4}$ is 8.

a Complete the simplification using a common denominator of 8.

b Now complete the simplification using the actual LCD of 4.

c How does your working for parts a and b compare? Which method is preferable and why?

ENRICHMENT: More than two fractions!

-

-

10(1/2)

10 Simplify by first finding the LCD.

a $\frac{2x}{5} - \frac{3x}{2} - \frac{x}{3}$

b $\frac{x}{4} - \frac{2x}{3} + \frac{5x}{6}$

c $\frac{5x}{8} - \frac{5x}{6} + \frac{3x}{4}$

d $\frac{x+1}{4} + \frac{2x-1}{3} - \frac{x}{5}$

e $\frac{2x-1}{3} - \frac{2x}{7} + \frac{x-3}{6}$

f $\frac{1-2x}{5} - \frac{3x}{8} + \frac{3x+1}{2}$

g $\frac{2}{3x} + \frac{5}{x} - \frac{1}{x}$

h $-\frac{1}{2x} + \frac{2}{x} - \frac{4}{3x}$

i $-\frac{4}{5x} - \frac{1}{2x} + \frac{3}{4x}$

j $\frac{4}{x^2} + \frac{3}{2x} - \frac{5}{3x}$

k $\frac{5}{x} - \frac{3}{2x^2} - \frac{5}{7x}$

l $\frac{2}{x^2} - \frac{4}{9x} - \frac{5}{3x^2}$

m $\frac{2}{x} + \frac{x}{5} - \frac{x}{3}$

n $\frac{3x}{2} - \frac{1}{2x} + \frac{x}{3}$

o $-\frac{4x}{9} + \frac{2}{5x} + \frac{2x}{5}$

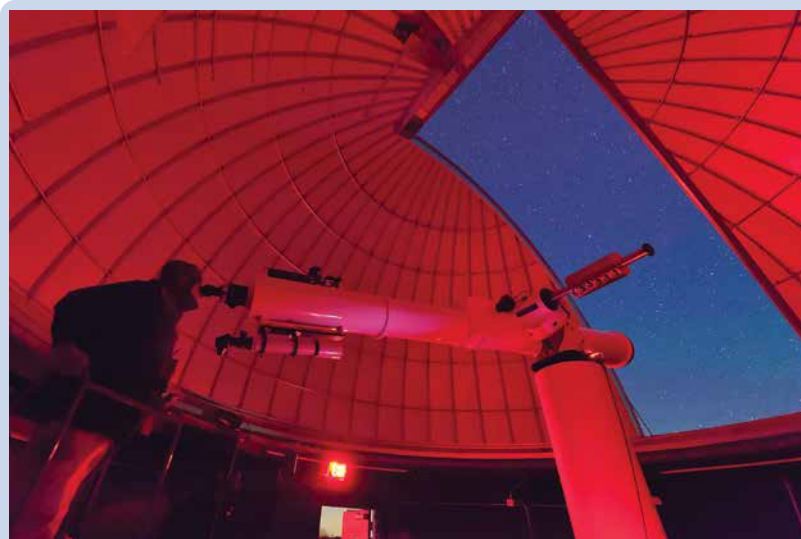

Astronomers and astrophysicists use algebraic fractions when applying equations to calculate the speed of a star or galaxy. As a star moves towards or away from Earth, the wavelength of its light is changed, altering the colour. This is known as the Doppler effect.

The following problems will investigate practical situations drawing upon knowledge and skills developed throughout the chapter. In attempting to solve these problems, aim to identify the key information, use diagrams, formulate ideas, apply strategies, make calculations and check and communicate your solutions.

Ice-cream profit

- 1 An ice-cream vendor has determined the profit equation for his business based on the selling price of his ice-cream cones. The price needs to be set high enough for the associated costs to be covered, but not too high such that sales start to decline.

The profit of the business, \$ P , for an ice-cream selling price of \$ x is given by the equation

$$P = -120x^2 + 840x - 1200.$$

With this knowledge, the vendor wants to analyse the rule to find which selling price leads to a profit and how he can set the selling price to maximise the profit of the business.

- a Interpret the result from the rule for profit if the vendor gave the ice-cream cones away for free.
- b Use the rule to determine the profit when:
- $x = 3$
 - $x = 4.5$
- c Consider the results from part b. Describe what has happened to the company's profit as the ice-cream price increased from \$3 to \$4.50.
- d By considering your results from part b and using increments of 0.5, find the selling price \$ x that gives the greatest profit. What is this profit?
- e The ice-cream prices are variable from day to day and the vendor will adjust to ensure that a profit is made each day.
- Factorise the rule for P by first removing the common factor.
 - Using your result from part i, consider which values of x would lead to a negative profit (i.e. a loss). Hence, between which values should the vendor maintain the ice-cream selling price to make a profit?



Veggie patch fencing

- 2 Farmer Jo is clearing an area of the farm for a new rectangular veggie patch. The area will need to be fenced off to keep some of the animals from trampling on it. Jo has 8 m of leftover chicken wire and some posts to use as fencing. She plans to use an existing fence on one side of the veggie patch as shown at right.

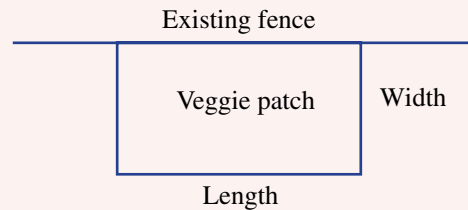

Jo is interested in looking at the different rectangular areas she can make with her 8 m of fencing material. In particular, she wishes to make the area for her veggie patch as large as possible.

- a For a veggie patch of width 1 m:
 - i find the maximum possible length of the veggie patch
 - ii determine the maximum area of the veggie patch.
- b If the width of the veggie patch is 3.2 m, repeat steps **i** and **ii** from part **a**. What do you notice about the area of this veggie patch compared to the one in part **a** for the same 8 m perimeter?
- c Let the width of the veggie patch be x m. Find expressions for the length and area of the veggie patch in terms of x .
- d Use your area expression from part **c** to find the area of the veggie patch if $x = 1.5$.
- e By considering the length and width dimensions of the veggie patch, what are the possible values that the width x m can take?
- f Use a suitable method to predict the maximum possible area of the veggie patch and the dimensions that produce this area.



Tracking running progress

- 3 Oscar is starting a running program and is running for 48 minutes three times a week. In the first week he records that he walks a warm-up lap of a nearby oval at 2 km/h and jogs 6 laps at 4 km/h. Let d km be the distance around the oval.

Oscar is keen to analyse this data so that he can track his progress over time when he runs in different locations, and to set himself goals through the course of the program.

- a Find an expression in terms of d for the time taken in hours to:
 - i walk the warm-up lap
 - ii jog the 6 laps.
- b Hence, find a simplified expression in terms of d for the total time taken.
- c Given the warm-up lap and jog took 48 minutes, use your result from part **b** to help find the distance around the oval in metres.

As the training continues in week 2, Oscar increases his jogging speed to 5 km/h.

- d He goes for a run on a different oval, completing the warm-up lap at 2 km/h and then jogging 8 laps at 5 km/h, all in 48 minutes. Repeat parts **a–c** to find the distance around this oval to the nearest metre.
- e In week 3, Oscar returns to the first oval. The goal for the 48 minutes is to complete the regular warm-up lap and 8 laps jogging. Determine what his jogging speed in km/h will need to be to achieve this.



8J Further simplification of algebraic fractions

EXTENDING

LEARNING INTENTIONS

- To be able to simplify algebraic fractions involving subtraction of binomial numerators
- To know how to find a lowest common denominator of binomial denominators
- To be able to simplify algebraic fractions with more complex numerators and denominators

More complex addition and subtraction of algebraic fractions involves expressions such as the following:

$$\frac{2x-1}{3} - \frac{x+4}{4} \text{ and } \frac{2}{x-3} - \frac{5}{(x-3)^2}$$

In such examples, care needs to be taken at each step in the working to avoid common errors.



Electrical and biomedical engineers use algebraic fractions for many applications, including in the design of microcircuits and sensors for sophisticated medical equipment, such as MRI scanners.

Lesson starter: Three critical errors

The following simplification of algebraic fractions has three critical errors. Can you find them?

$$\begin{aligned} \frac{2x+1}{3} - \frac{x+2}{2} &= \frac{2x+1}{6} - \frac{3(x+2)}{6} \\ &= \frac{2x+1-3x+6}{6} \\ &= \frac{x+7}{6} \end{aligned}$$

The correct answer is $\frac{x-4}{6}$.

Fix the solution to obtain the correct answer.

KEY IDEAS

- When combining algebraic fractions which involve subtraction signs, recall that:
 - the product of two numbers of opposite sign is a negative number
 - the product of two negative numbers is a positive number.

$$\begin{aligned} \text{For example: } \frac{2(x-1)}{6} - \frac{3(x+2)}{6} &= \frac{2(x-1) - 3(x+2)}{6} \\ &= \frac{2x - 2 - 3x - 6}{6} \end{aligned}$$

$$\begin{aligned} \text{and } \frac{5(1-x)}{8} - \frac{2(x-1)}{8} &= \frac{5(1-x) - 2(x-1)}{8} \\ &= \frac{5 - 5x - 2x + 2}{8} \end{aligned}$$

- A common denominator can be a product of two algebraic expressions.

$$\begin{aligned} \text{For example: } \frac{2}{x+3} + \frac{3}{x-1} &= \frac{2(x-1)}{(x+3)(x-1)} + \frac{3(x+3)}{(x+3)(x-1)} \\ &= \frac{2x - 2 + 3x + 9}{(x+3)(x-1)} \\ &= \frac{5x + 7}{(x+3)(x-1)} \end{aligned}$$

BUILDING UNDERSTANDING

- 1 State the result of expanding the following.

a $-2(x+3)$

b $-7(2+3x)$

c $-3(x-1)$

d $-10(3-2x)$

- 2 State the LCD for these pairs of fractions.

a $\frac{1}{3}, \frac{5}{9}$

b $-\frac{5}{2x}, \frac{3}{2}$

c $\frac{3}{x}, \frac{5}{x^2}$

d $\frac{7}{x-2}, \frac{3}{x+3}$

- 3 Simplify:

a $2(x+1) - 3(x+2)$

b $5(x+2) - 2(x-3)$

c $4 - 2(x-1)$



Problems that are solved using code often use formulas with algebraic fractions.



Example 19 Simplifying with more complex numerators

Simplify:

$$\text{a } \frac{x-1}{3} - \frac{x+4}{5}$$

$$\text{b } \frac{2x-3}{6} - \frac{3-x}{5}$$

SOLUTION

$$\begin{aligned} \text{a } \frac{x-1}{3} - \frac{x+4}{5} &= \frac{5(x-1)}{15} - \frac{3(x+4)}{15} \\ &= \frac{5x-5-3x-12}{15} \\ &= \frac{2x-17}{15} \end{aligned}$$

$$\begin{aligned} \text{b } \frac{2x-3}{6} - \frac{3-x}{5} &= \frac{5(2x-3)}{30} - \frac{6(3-x)}{30} \\ &= \frac{10x-15-18+6x}{30} \\ &= \frac{16x-33}{30} \end{aligned}$$

EXPLANATION

The LCD for 3 and 5 is 15. Insert brackets around each numerator when multiplying. (Note: $-3(x+4) = -3x-12$ not $-3x+12$.)

Determine the LCD and express as equivalent fractions. Insert brackets.

Expand the brackets, recalling that $-6 \times (-x) = 6x$, and then simplify the numerator.

Now you try

Simplify:

$$\text{a } \frac{x-4}{2} - \frac{x+2}{3}$$

$$\text{b } \frac{2x+1}{4} - \frac{2-x}{3}$$



Example 20 Simplifying with more complex denominators

Simplify:

$$\text{a } \frac{4}{x+1} + \frac{3}{x-2}$$

$$\text{b } \frac{3}{(x-1)^2} - \frac{2}{x-1}$$

SOLUTION

$$\begin{aligned} \text{a } \frac{4}{x+1} + \frac{3}{x-2} &= \frac{4(x-2)}{(x+1)(x-2)} + \frac{3(x+1)}{(x+1)(x-2)} \\ &= \frac{4x-8+3x+3}{(x+1)(x-2)} \\ &= \frac{7x-5}{(x+1)(x-2)} \end{aligned}$$

$$\begin{aligned} \text{b } \frac{3}{(x-1)^2} - \frac{2}{x-1} &= \frac{3}{(x-1)^2} - \frac{2(x-1)}{(x-1)^2} \\ &= \frac{3-2x+2}{(x-1)^2} \\ &= \frac{5-2x}{(x-1)^2} \end{aligned}$$

EXPLANATION

The LCD for $(x+1)$ and $(x-2)$ is $(x+1)(x-2)$. Rewrite each fraction as an equivalent fraction with this denominator, then add numerators.

Just as the LCD for 3^2 and 3 is 3^2 , the LCD for $(x-1)^2$ and $x-1$ is $(x-1)^2$.

Remember that $-2(x-1) = -2x+2$.

Now you try

Simplify:

a $\frac{3}{x+2} + \frac{2}{x-3}$

b $\frac{5}{(x-2)^2} - \frac{3}{x-2}$

Exercise 8J

FLUENCY

1-4(1/2)

1-4(1/2)

1-4(1/3)

Example 19a

1 Simplify:

a $\frac{x+3}{4} - \frac{x+2}{3}$

b $\frac{x-1}{3} - \frac{x+3}{5}$

c $\frac{x-4}{3} - \frac{x+1}{6}$

d $\frac{3-x}{5} - \frac{x+4}{2}$

e $\frac{5x-1}{4} - \frac{2+x}{8}$

f $\frac{3x+2}{14} - \frac{x+4}{4}$

g $\frac{1+3x}{4} - \frac{2x+3}{6}$

h $\frac{2-x}{5} - \frac{3x+1}{3}$

i $\frac{2x-3}{6} - \frac{4+x}{15}$

Example 19b

2 Simplify:

a $\frac{x+5}{3} - \frac{x-1}{2}$

b $\frac{x-4}{5} - \frac{x-6}{7}$

c $\frac{3x-7}{4} - \frac{x-1}{2}$

d $\frac{5x-9}{7} - \frac{2-x}{3}$

e $\frac{3x+2}{4} - \frac{5-x}{10}$

f $\frac{9-4x}{6} - \frac{2-x}{8}$

g $\frac{4x+3}{3} - \frac{5-2x}{9}$

h $\frac{2x-1}{4} - \frac{1-3x}{14}$

i $\frac{3x-2}{8} - \frac{4x-3}{7}$

Example 20a

3 Simplify:

a $\frac{3}{x-1} + \frac{4}{x+1}$

b $\frac{5}{x+4} + \frac{2}{x-3}$

c $\frac{3}{x-2} + \frac{4}{x+3}$

d $\frac{3}{x-4} + \frac{2}{x+7}$

e $\frac{7}{x+2} - \frac{3}{x+3}$

f $\frac{3}{x+4} - \frac{2}{x-6}$

g $\frac{-1}{x+5} + \frac{2}{x+1}$

h $\frac{-2}{x-3} - \frac{4}{x-2}$

i $\frac{3}{x-5} - \frac{5}{x-6}$

Example 20b

4 Simplify:

a $\frac{4}{(x+1)^2} - \frac{3}{x+1}$

b $\frac{2}{(x+3)^2} - \frac{4}{x+3}$

c $\frac{3}{x-2} + \frac{4}{(x-2)^2}$

d $\frac{-2}{x-5} + \frac{8}{(x-5)^2}$

e $\frac{-1}{x-6} + \frac{3}{(x-6)^2}$

f $\frac{2}{(x-4)^2} - \frac{3}{x-4}$

g $\frac{5}{(2x+1)^2} + \frac{2}{2x+1}$

h $\frac{9}{(3x+2)^2} - \frac{4}{3x+2}$

i $\frac{4}{(1-4x)^2} - \frac{5}{1-4x}$

PROBLEM-SOLVING

5(½)

5-6(½)

5-6(½)

5 Simplify:

a $\frac{3x}{(x-1)^2} + \frac{2}{x-1}$

b $\frac{3x+2}{3x} + \frac{7}{12}$

c $\frac{2x-1}{4} + \frac{2-3x}{10x}$

d $\frac{2x}{x-5} - \frac{x}{x+1}$

e $\frac{3}{4-x} - \frac{2x}{x-1}$

f $\frac{5x+1}{(x-3)^2} + \frac{x}{x-3}$

g $\frac{3x-7}{(x-2)^2} - \frac{5}{x-2}$

h $\frac{-7x}{2x+1} + \frac{3x}{x+2}$

i $\frac{x}{x+1} - \frac{5x+1}{(x+1)^2}$

6 Simplify:

a $\frac{1}{(x+3)(x+4)} + \frac{2}{(x+4)(x+5)}$

b $\frac{3}{(x+1)(x+2)} - \frac{5}{(x+1)(x+4)}$

c $\frac{4}{(x-1)(x-3)} - \frac{6}{(x-1)(2-x)}$

d $\frac{5x}{(x+1)(x-5)} - \frac{2}{x-5}$

e $\frac{3}{x-4} + \frac{8x}{(x-4)(3-2x)}$

f $\frac{3x}{(x+4)(2x-1)} - \frac{x}{(x+4)(3x+2)}$

REASONING

7

7, 8(½)

8(½)

7 One of the most common errors made when subtracting algebraic fractions is hidden in this working shown below.

$$\begin{aligned} \frac{7x}{2} - \frac{x-2}{5} &= \frac{35x}{10} - \frac{2(x-2)}{10} \\ &= \frac{35x-2x-4}{10} \\ &= \frac{33x-4}{10} \end{aligned}$$

a What is the error and in which step is it made?

b By correcting the error how does the answer change?

8 Use the fact that $a - b = -1(b - a)$ to help simplify these.

a $\frac{3}{1-x} - \frac{2}{x-1}$

b $\frac{4x}{5-x} + \frac{3}{x-5}$

c $\frac{2}{7x-3} - \frac{7}{3-7x}$

d $\frac{1}{4-3x} + \frac{2x}{3x-4}$

e $\frac{-3x}{5-3x} - \frac{5}{3x-5}$

f $\frac{4}{x-6} + \frac{4}{6-x}$

ENRICHMENT: Factorise first

-

-

9(½)

9 Factorising a denominator before further simplification is a useful step. Simplify these by first factorising the denominators if possible.

a $\frac{3}{x+2} + \frac{5}{2x+4}$

b $\frac{7}{3x-3} - \frac{2}{x-1}$

c $\frac{3}{8x-4} - \frac{5}{1-2x}$

d $\frac{4}{x^2-9} - \frac{3}{x+3}$

e $\frac{5}{2x+4} + \frac{2}{x^2-4}$

f $\frac{10}{3x-4} - \frac{7}{9x^2-16}$

g $\frac{7}{x^2+7x+12} + \frac{2}{x^2-2x-15}$

h $\frac{3}{(x+1)^2-4} - \frac{2}{x^2+6x+9}$

i $\frac{3}{x^2-7x+10} - \frac{2}{10-5x}$

j $\frac{1}{x^2+x} - \frac{1}{x^2-x}$

8K Equations with algebraic fractions EXTENDING

LEARNING INTENTIONS

- To know how to solve equations with algebraic fractions by multiplying both sides by the lowest common denominator or by expressing the fractions with a common denominator

For equations with more than one fraction, it is often best to try to simplify the equation by dealing with all the denominators at once. This involves finding and multiplying both sides by the lowest common denominator.



The study of optometry includes solving algebraic fractional equations that model the path of light through spectacle lenses.

Lesson starter: Why use the LCD?

For this equation follow each instruction.

$$\frac{x+1}{3} + \frac{x}{4} = 1$$

- Multiply every term in the equation by 3. What effect does this have on the fractions on the left-hand side?
- Starting with the original equation, multiply every term in the equation by 4. What effect does this have on the fractions on the left-hand side?
- Starting with the original equation, multiply every term in the equation by 12 and simplify.

Which instruction above does the best job in simplifying the algebraic fractions? Why?

KEY IDEAS

- For equations with more than one fraction, multiply both sides by the **lowest common denominator (LCD)**.
 - Multiply every term on both sides, not just the fractions.
 - Simplify the fractions and solve the equation using the methods learnt earlier.
- Alternatively, express each fraction using the same denominator then simplify by adding or subtracting.

BUILDING UNDERSTANDING

1 State the lowest common denominator of all the fractions in each equation.

a $\frac{x}{3} - \frac{2x}{5} = 1$

b $\frac{x+1}{3} - \frac{x}{6} = 5$

c $\frac{2x-1}{7} + \frac{5x+2}{4} = 6$

2 Simplify the fractions by cancelling.

a $\frac{12x}{3}$

b $\frac{4(x+3)}{2}$

c $\frac{15x}{5x}$

d $\frac{36(x-7)(x-1)}{9(x-7)}$

3 Describe a method for solving the following equations.

a $\frac{2x+3}{5} = 3$

b $\frac{5}{x} = 2$



Example 21 Solving equations involving algebraic fractions

Solve each of the following equations.

a $\frac{2x}{3} + \frac{x}{2} = 7$

b $\frac{x-2}{5} - \frac{x-1}{3} = 1$

c $\frac{x-1}{3} = \frac{x}{4}$

SOLUTION

a $\frac{2x}{3} + \frac{x}{2} = 7$

$$\frac{2x}{\cancel{3}_1} \times \cancel{6}^2 + \frac{x}{\cancel{2}_1} \times \cancel{6}^3 = 7 \times 6$$

$$4x + 3x = 42$$

$$7x = 42$$

$$x = 6$$

OR $\frac{2x}{3} + \frac{x}{2} = 7$

$$\frac{4x}{6} + \frac{3x}{6} = 7$$

$$\frac{7x}{6} = 7$$

$$7x = 42$$

$$x = 6$$

b $\frac{x-2}{5} - \frac{x-1}{3} = 1$

$$\frac{15^3(x-2)}{\cancel{3}_1} - \frac{15^5(x-1)}{\cancel{3}_1} = 1 \times 15$$

$$3(x-2) - 5(x-1) = 15$$

$$3x - 6 - 5x + 5 = 15$$

$$-2x - 1 = 15$$

$$-2x = 16$$

$$x = -8$$

EXPLANATION

Multiply each term by the LCD (LCD of 3 and 2 is 6) and cancel.

Simplify and solve for x .

Alternatively, write each fraction on the left-hand side using the LCD = 6.

Simplify by adding the numerators and solve the remaining equation.

Multiply each term on both sides by 15 (LCD of 3 and 5 is 15) and cancel.

Expand the brackets and simplify by combining like terms. (Note: $-5(x-1) = -5x + 5$ not $-5x - 5$.)

Alternatively, write each fraction using the LCD = 15 then combine the numerators and

solve $\frac{3(x-2)}{15} - \frac{5(x-1)}{15} = 1$.

Continued on next page

$$\text{c} \quad \frac{x-1}{3} = \frac{x}{4}$$

$$\frac{12^4(x-1)}{3_1} = \frac{12^3x}{4_1}$$

$$4x - 4 = 3x$$

$$x - 4 = 0$$

$$x = 4$$

$$\text{OR} \quad \frac{x-1}{3} = \frac{x}{4}$$

$$4(x-1) = 3x$$

$$4x - 4 = 3x$$

$$x = 4$$

Multiply both sides by 12 (LCD of 3 and 4 is 12) and cancel.

Expand brackets and solve for x .

Alternatively, you can cross multiply since each side is a single fraction: $\frac{x-1}{3} \times \frac{x}{4}$.

Now you try

Solve each of the following equations.

$$\text{a} \quad \frac{x}{4} + \frac{2x}{3} = 11$$

$$\text{b} \quad \frac{x+3}{5} - \frac{x-2}{2} = -2$$

$$\text{c} \quad \frac{x+2}{5} = \frac{x}{3}$$

Example 22 Solving equations that include algebraic denominators

Solve each of the following equations.

$$\text{a} \quad \frac{5}{2x} - \frac{4}{3x} = 2$$

$$\text{b} \quad \frac{3}{x+1} = \frac{2}{x+4}$$

SOLUTION

$$\begin{aligned} \text{a} \quad \frac{5}{2x} - \frac{4}{3x} &= 2 \\ \frac{5}{2x_1} \times 6x^3 - \frac{4}{3x_1} \times 6x^2 &= 2 \times 6x \\ 15 - 8 &= 12x \\ 7 &= 12x \\ x &= \frac{7}{12} \end{aligned}$$

$$\begin{aligned} \text{b} \quad \frac{3}{x+1} &= \frac{2}{x+4} \\ \frac{3(x+1)(x+4)}{(x+1)} &= \frac{2(x+1)(x+4)}{(x+4)} \\ 3(x+4) &= 2(x+1) \\ 3x+12 &= 2x+2 \\ x+12 &= 2 \\ x &= -10 \end{aligned}$$

$$\begin{aligned} \text{OR} \quad \frac{3}{x+1} &= \frac{2}{x+4} \\ 3(x+4) &= 2(x+1) \\ 3x+12 &= 2x+2 \\ x+12 &= 2 \\ x &= -10 \end{aligned}$$

EXPLANATION

LCD of $2x$ and $3x$ is $6x$.

Multiply each term by $6x$. Cancel and simplify. Solve for x , leaving the answer in fraction form.

(Alternative solution: $\frac{15}{6x} - \frac{8}{6x} = 2$)

Multiply each term by the common denominator $(x+1)(x+4)$.

Expand the brackets.

Subtract $2x$ from both sides to gather x terms on one side, then subtract 12 from both sides.

Since each side is a single fraction you can 'cross-multiply': $\frac{3}{x+1} \times \frac{2}{x+4}$

This gives the same result as above.

Now you try

Solve each of the following equations.

a $\frac{3}{4x} - \frac{2}{5x} = 2$

b $\frac{3}{x+2} = \frac{2}{x-1}$

Exercise 8K

FLUENCY

1–3($\frac{1}{2}$)1–4($\frac{1}{3}$), 5($\frac{1}{2}$)1–5($\frac{1}{3}$)

Example 21a

1 Solve each of the following equations.

a $\frac{x}{2} + \frac{x}{5} = 7$

b $\frac{x}{2} + \frac{x}{3} = 10$

c $\frac{y}{3} + \frac{y}{4} = 14$

d $\frac{x}{2} - \frac{3x}{5} = -1$

e $\frac{5m}{3} - \frac{m}{2} = 1$

f $\frac{3a}{5} - \frac{a}{3} = 2$

g $\frac{3x}{4} - \frac{5x}{2} = 14$

h $\frac{8a}{3} - \frac{2a}{5} = 34$

i $\frac{7b}{2} + \frac{b}{4} = 15$

Example 21b

2 Solve each of the following equations.

a $\frac{x-1}{2} + \frac{x+2}{3} = 11$

b $\frac{b+3}{2} + \frac{b-4}{3} = 1$

c $\frac{n+2}{3} + \frac{n-2}{2} = 1$

d $\frac{a+1}{5} - \frac{a+1}{6} = 2$

e $\frac{x+5}{2} - \frac{x-1}{4} = 3$

f $\frac{x+3}{2} - \frac{x+1}{3} = 2$

g $\frac{m+4}{3} - \frac{m-4}{4} = 3$

h $\frac{2a-8}{2} + \frac{a+7}{6} = 1$

i $\frac{2y-1}{4} - \frac{y-2}{6} = -1$

Example 21c

3 Solve each of the following equations.

a $\frac{x+1}{2} = \frac{x}{3}$

b $\frac{x-2}{3} = \frac{x}{2}$

c $\frac{n+3}{4} = \frac{n-1}{2}$

d $\frac{a+2}{3} = \frac{a+1}{2}$

e $\frac{3+y}{2} = \frac{2-y}{3}$

f $\frac{2m+4}{4} = \frac{m+6}{3}$

Example 22a

4 Solve each of the following equations.

a $\frac{3}{4x} - \frac{1}{2x} = 4$

b $\frac{2}{3x} - \frac{1}{2x} = 2$

c $\frac{4}{2m} - \frac{2}{5m} = 3$

d $\frac{1}{2x} - \frac{1}{4x} = 9$

e $\frac{1}{2b} + \frac{1}{b} = 2$

f $\frac{1}{2y} + \frac{1}{3y} = 4$

g $\frac{1}{3x} + \frac{1}{2x} = 2$

h $\frac{3x}{3} - \frac{1}{x} = 2$

i $\frac{7}{2a} - \frac{2}{3a} = 1$

Example 22b

5 Solve each of the following equations.

a $\frac{3}{x+1} = \frac{1}{x+2}$

b $\frac{2}{x+3} = \frac{3}{x+2}$

c $\frac{2}{x+5} = \frac{3}{x-2}$

d $\frac{1}{x-3} = \frac{1}{2x+1}$

e $\frac{2}{x-1} = \frac{1}{2x+1}$

f $\frac{1}{x-2} = \frac{2}{3x+2}$

PROBLEM-SOLVING

6, 7

6, 7, 8($\frac{1}{2}$)7, 8($\frac{1}{2}$), 96 Half of a number (x) plus one-third of twice the same number is equal to 4.

- a Write an equation describing the situation.
b Solve the equation to find the number.

- 7 Molly and Billy each have the same number of computer games (x computer games each). Hazel, who doesn't have any games, takes one-third of Molly's computer games and a quarter of Billy's computer games to give her a total of 77 computer games.



- Write an equation describing the total number of computer games for Hazel.
 - Solve the equation to find how many computer games Molly and Billy each had.
- 8 Use your combined knowledge of all the methods learnt earlier to solve these equations with algebraic fractions.

a $\frac{2x+3}{1-x} = 4$

b $\frac{5x+2}{x+2} = 3$

c $\frac{3x-2}{x-1} = 2$

d $\frac{2x}{3} + \frac{x-1}{4} = 2x-1$

e $\frac{3}{x^2} - \frac{2}{x} = \frac{5}{x}$

f $\frac{1-3x}{x^2} + \frac{3}{2x} = \frac{4}{x}$

g $\frac{x-1}{2} + \frac{3x-2}{4} = \frac{2x}{3}$

h $\frac{4x+1}{3} - \frac{x-3}{6} = \frac{x+5}{6}$

i $\frac{1}{x+2} - \frac{2}{x-3} = \frac{5}{(x+2)(x-3)}$

j $\frac{2}{x+4} - \frac{1}{x-1} = \frac{3}{(x+4)(x-1)}$

- 9 One number is twice another number and the sum of their reciprocals is $\frac{3}{10}$.

- Write an equation describing the situation.
- Solve the equation to find the two numbers.

REASONING

10, 11

10, 11

11, 12($\frac{1}{2}$)

- 10 A common error when solving equations with algebraic fractions is made in this working. Find the error and explain how to avoid it.

$$\frac{3x-1}{4} + 2x = \frac{x}{3} \quad (\text{LCD} = 12)$$

$$\frac{12(3x-1)}{4} + 2x = \frac{12x}{3}$$

$$3(3x-1) + 2x = 4x$$

$$9x-3+2x=4x$$

$$7x=3$$

$$x = \frac{3}{7}$$

- 11 Another common error is made in this working. Find and explain how to avoid this error.

$$\frac{x}{2} - \frac{2x-1}{3} = 1 \quad (\text{LCD} = 6)$$

$$\frac{6x}{2} - \frac{6(2x-1)}{3} = 6$$

$$3x - 2(2x-1) = 6$$

$$3x - 4x - 2 = 6$$

$$-x = 8$$

$$x = -8$$

- 12 Some equations with decimals can be solved by first multiplying by a power of 10. Here is an example.

$$0.8x - 1.2 = 2.5 \text{ (Multiply both sides by 10 to remove all decimals.)}$$

$$8x - 12 = 25$$

$$8x = 37$$

$$x = \frac{37}{8}$$

Solve these decimal equations using the same idea. For parts **d–f** you will need to multiply by 100.

a $0.4x + 1.4 = 3.2$

b $0.3x - 1.3 = 0.4$

c $0.5 - 0.2x = 0.2$

d $1.31x - 1.8 = 2.13$

e $0.24x + 0.1 = 3.7$

f $2 - 3.25x = 8.5$

ENRICHMENT: Literal equations

–

–

13(1/2)

- 13 Solve each of the following equations for x in terms of the other pronumerals.

(Hint: You may need to use factorisation to make x the subject in your working.)

a $\frac{x}{a} - \frac{x}{2a} = b$

b $\frac{ax}{b} - \frac{cx}{2} = d$

c $\frac{x-a}{b} = \frac{x}{c}$

d $\frac{x+a}{b} = \frac{d+e}{c}$

e $\frac{ax+b}{4} = \frac{x+c}{3}$

f $\frac{x+a}{3b} + \frac{x-a}{2b} = 1$

g $\frac{2a-b}{a} + \frac{a}{x} = a$

h $\frac{1}{a} - \frac{1}{x} = \frac{1}{c}$

i $\frac{a}{x} = \frac{b}{c}$

j $\frac{a}{x} + b = \frac{c}{x}$

k $\frac{ax-b}{x-b} = c$

l $\frac{cx+b}{x+a} = d$

m $\frac{2a+x}{a} = b$

n $\frac{1}{x-a} = \frac{1}{ax+b}$

o $\frac{a}{b} - \frac{a}{a+x} = 1$

Square castle moats

Moats were constructed around castles to help protect its occupants from invaders. A square castle of side length 40 metres is to be surrounded by a square moat of a certain width as shown.

Present a report for the following tasks and ensure that you show clear mathematical workings and explanations where appropriate.

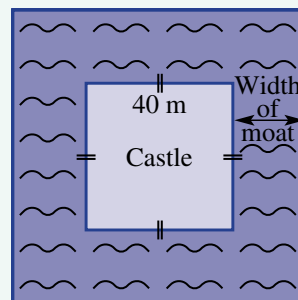

Preliminary task

- Find the area of land occupied by the 40-metre square castle.
- If the width of the moat is 10 metres, find the surface area of the water in the moat.
- Find the outside perimeter of the moat if the width of the moat is 8.5 metres.

Modelling task

- | | |
|---------------------|--|
| Formulate | <ol style="list-style-type: none"> The problem is to determine a width for the moat so that the surface area of water is at least 10 times the area of the castle. Write down all the relevant information that will help solve this problem with the aid of a diagram. If the width of the moat is x metres, find expressions in terms of x for the following: <ol style="list-style-type: none"> the perimeter of the outside of the moat the total area occupied by the moat and the castle. |
| Solve | <ol style="list-style-type: none"> Use your expressions from part b ii to show that the area occupied by the moat, not including the castle, can be written in the form $4x(40 + x)$. Using the expression from part c, find the area occupied by the moat for the following values of x. <ol style="list-style-type: none"> 5 8 12 Determine the smallest integer value of x such that the area of the moat is at least four times the area of the castle. |
| Evaluate and verify | <ol style="list-style-type: none"> Assuming that the lord of the castle wants the area of the moat to be as close as possible to four times the area of the castle, investigate if this is possible using non-integer values of x. Instead, the lord wants to build a square castle of side length x metres inside a square lake of side length 50 metres. <ol style="list-style-type: none"> Show that the remaining lake area forming the moat is given by the expression $(50 + x)(50 - x)$. Use a trial and error approach to determine the width of the castle that delivers a moat area which is four times the area of the castle. Give your answer correct to one decimal place. |
| Communicate | <ol style="list-style-type: none"> Summarise your results and describe any key findings. |

Extension questions

A square castle of width a metres is surrounded by a moat of width x metres as per the castle in the introduction of this task.

- Find an expression for the area of the moat in terms of a and x .
- Find the value of a such that a moat of width 10 metres occupies four times the area of the castle. Give your answer correct to one decimal place. Illustrate the solution with a drawing.



Generating framing pictures

Key technology: Spreadsheets and programming

Area problems can often be solved using quadratic equations because the multiplication of a length and a width, both of which depend on the variable x , will result in an expression including a x^2 term. For example, a painting surrounded by a picture frame of width x cm will have an area which is a quadratic expression in terms of x . The coefficients will depend on the dimensions of the overall framed painting.



1 Getting started

The given diagram shows a picture frame of equal width x cm surrounding a square painting. The total width of the framed painting including the frame is 50 cm.

- Write an expression in terms of x for the side length of the painting inside the frame.
- Give the realistic values of x and give reasons.
- Write an expression for the area of the painting. Expand and simplify your expression.
- Use your expression from part **c** to find the area of the painting for the following values of x .
 - 3
 - 5
 - 10

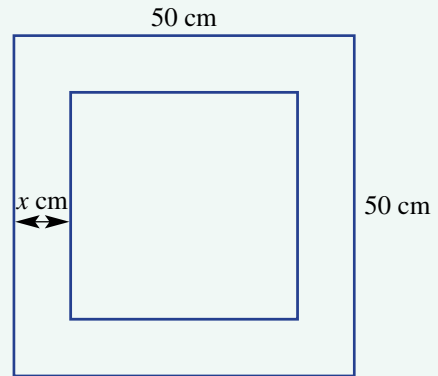

2 Applying an algorithm

Rather than solving for x for a given painting area algebraically, we can search for a solution numerically. Consider an algorithm which searches for a value of x which makes the area of the painting equal to 1000 cm^2 .

This flowchart describes a simple algorithm which asks for a starting value of x . This should be a small integer value for which the area of the painting is greater than 1000 cm^2 . $x = 5$ is chosen.

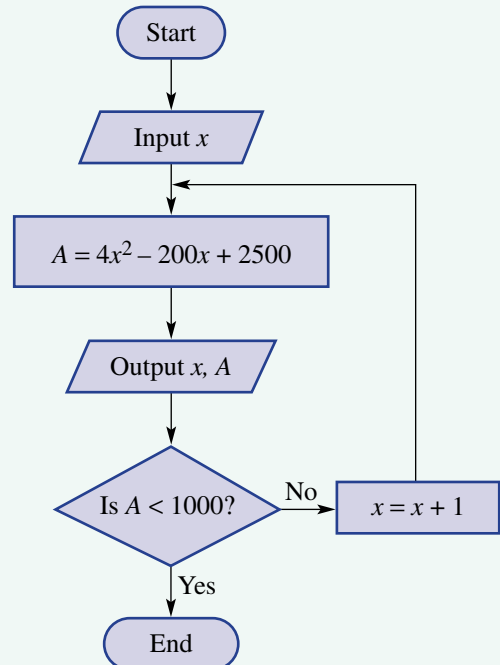

- a** Starting with an x value of 5 run through the algorithm and fill in the table of values for the output of x and A .
- b** Use your result above to decide between which two integers lies the x value that makes the area of the painting equal to 1000 cm^2 .
- c** Modify the algorithm and complete parts **a** and **b** above if the area of the painting is instead 2000 cm^2 .

x	A
5	1600
6	

3 Using technology

- a** Set up a spreadsheet which calculates the area of the painting for a given value of x as shown.
- b** Fill down at cells A7 and B6 and locate the integer value of x which gives the area closest to 1000 cm^2 .
- c** Now try to find a more accurate value of x for which the area is equal to 1000 cm^2 by changing the following. Fill down to locate the value of x .
- Alter the formula in cell A7 to be $= A6 + 0.1$
 - Alter the starting value in cell A6 to 8
- d** Repeat part **c** using a smaller increment until you are satisfied that you have found the correct value of x to one decimal place.

	A	B
1	Picture frames	
2		
3	Painting area	1000
4		
5	x value	Area
6	1	$=4*A6^2-200*A6+2500$
7	$=A6+1$	

4 Extension

- a** Consider a similar problem with a square framed painting but this time with a total side length of 20 cm rather than 50 cm. For this situation complete the following:
- Find an expression for the area of the painting.
 - Construct a flowchart which helps find the closest integer value of x for which the area of the painting is 180 cm^2 .
 - Construct a spreadsheet which helps find the value of x correct to one decimal place for which the area of the painting is 180 cm^2 .
- b** Repeat part **a** above but this time for a rectangular framed painting with side lengths of your choice.



Expanding quadratics using areas

Consider the expansion of the quadratic $(x + 3)(x + 6)$. This can be represented by finding the area of the rectangle shown.

$$\begin{aligned}\text{Total area} &= A_1 + A_2 + A_3 + A_4 \\ &= x^2 + 6x + 3x + 18\end{aligned}$$

Therefore:

$$(x + 3)(x + 6) = x^2 + 9x + 18$$

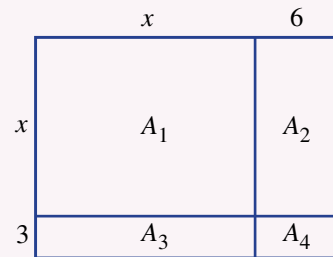

Expanding with positive signs

- a** Draw a diagram and calculate the area to determine the expansion of the following quadratics.
- $(x + 4)(x + 5)$
 - $(x + 7)(x + 8)$
 - $(x + 3)^2$
 - $(x + 5)^2$
- b** Using the same technique establish the rule for expanding $(a + b)^2$.

Expanding with negative signs

Consider the expansion of $(x - 4)(x - 7)$.

$$\begin{aligned}\text{Area required} &= \text{total area} - (A_2 + A_3 + A_4) \\ &= x^2 - [(A_2 + A_4) + (A_3 + A_4) - A_4] \\ &= x^2 - (7x + 4x - 28) \\ &= x^2 - 11x + 28\end{aligned}$$

Therefore:

$$(x - 4)(x - 7) = x^2 - 11x + 28$$

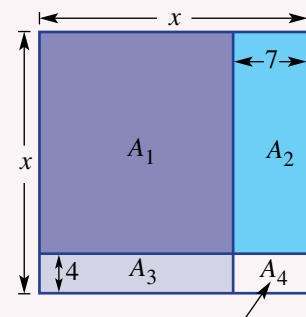

This area is counted twice when we add $7x + 4x$.

- a** Draw a diagram and calculate the area to determine the expansion of the following quadratics.
- $(x - 3)(x - 5)$
 - $(x - 6)(x - 4)$
 - $(x - 4)^2$
 - $(x - 2)^2$
- b** Using the same technique, establish the rule for expanding $(a - b)^2$.

Difference of two squares

Using a diagram to represent $(a - b)(a + b)$, determine the appropriate area and establish a rule for the expansion of $(a - b)(a + b)$.

- 1 a The difference between the squares of two consecutive numbers is 97.
What are the two numbers?
- b The difference between the squares of two consecutive odd numbers is 136.
What are the two numbers?
- c The difference between the squares of two consecutive multiples of 3 is 81.
What are the two numbers?



Up for a challenge? If you get stuck on a question, check out the 'Working with unfamiliar problems' poster at the end of the book to help you.

- 2 a If $x^2 + y^2 = 6$ and $(x + y)^2 = 36$, find the value of xy .
- b If $x + y = 10$ and $xy = 2$, find the value of $\frac{1}{x} + \frac{1}{y}$.
- 3 Find the values of the different digits a, b, c and d if the four-digit number $abcd$ is such that $abcd \times 4 = dcba$.
- 4 a Find the quadratic rule that relates the width, n , to the number of matches in the pattern below.

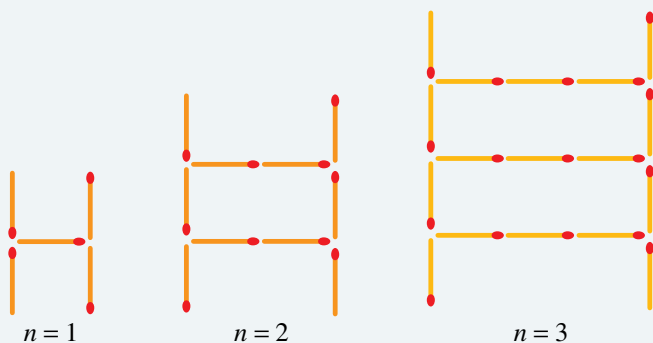

- b Draw a possible pattern for these rules.
- $n^2 + 3$
 - $n(n - 1)$
- 5 Factorise $n^2 - 1$ and use the factorised form to explain why when n is prime and greater than 3, $n^2 - 1$ is:
- divisible by 4
 - divisible by 3
 - thus divisible by 12.

- 6 Prove that this expression is equal to 1.

$$\frac{2x^2 - 8}{5x^2 - 5} \div \frac{x - 2}{5x - 5} \div \frac{2x^2 - 10x - 28}{x^2 - 6x - 7}$$

- 7 Prove that $4x^2 - 4x + 1 \geq 0$ for all x .
- 8 Ryan and Susan competed in a race over 4 km. Ryan ran at a constant speed. Sophie, however, ran the first 2 km at a speed 1 km/h more than Ryan and ran the second 2 km at a speed 1 km/h less than Ryan. Who won the race?

Monic quadratic trinomials

These are of the form:

$$x^2 + bx + c$$

Require two numbers that multiply to c and add to b

e.g. $x^2 - 7x - 18 = (x - 9)(x + 2)$

since $-9 \times 2 = -18$

and $-9 + 2 = -7$

Difference of two squares

$$a^2 - b^2 = (a - b)(a + b)$$

e.g. $x^2 - 16 = x^2 - 4^2$

$$= (x - 4)(x + 4)$$

e.g. $4x^2 - 9 = (2x)^2 - 3^2$

$$= (2x - 3)(2x + 3)$$

Expansion

The process of removing brackets.

e.g. $2(x + 5) = 2x + 10$

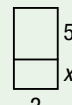

$$\begin{aligned}(x + 3)(2x - 4) &= x(2x - 4) + 3(2x - 4) \\ &= 2x^2 - 4x + 6x - 12 \\ &= 2x^2 + 2x - 12\end{aligned}$$

Factorisation

The reverse process of expansion. Always remove the highest common factor first.

e.g. $2ab + 8b$ HCF = $2b$
 $= 2b(a + 4)$

e.g. $3(x + 2) + y(x + 2)$ HCF = $x + 2$
 $= (x + 2)(3 + y)$

Algebraic techniques**Special cases****Difference of two squares**

$$(a - b)(a + b) = a^2 - b^2$$

e.g. $(x - 5)(x + 5) = x^2 + 5x - 5x - 25$
 $= x^2 - 25$

Perfect squares

$$(a + b)^2 = a^2 + 2ab + b^2$$

$$(a - b)^2 = a^2 - 2ab + b^2$$

e.g. $(2x + 3)^2 = (2x + 3)(2x + 3)$
 $= 4x^2 + 6x + 6x + 9$
 $= 4x^2 + 12x + 9$

Add/subtract

Find the lowest common denominator (LCD) before applying operation.

e.g. $\frac{3x}{4} + \frac{x-1}{3}$

$$= \frac{9x}{12} + \frac{4(x-1)}{12}$$

$$= \frac{9x + 4x - 4}{12}$$

$$= \frac{13x - 4}{12}$$

Algebraic fractions

These involve algebraic expressions in the numerator and/or denominator.

e.g. $\frac{x}{3}, \frac{2x}{x-7}, \frac{3}{5x}, \frac{7}{(x-1)^2}$

Multiply/divide

To divide, multiply by the reciprocal. Factorise all expressions, cancel and then multiply.

e.g. $\frac{3}{x^2 - 9} \div \frac{15}{2x + 6}$

$$\begin{aligned}&= \frac{\cancel{3}^{-1}}{(x-3)(x+3)^1} \times \frac{2(x+3)^1}{\cancel{15}^5} \\ &= \frac{2}{5(x-3)}\end{aligned}$$

By grouping in pairs

If there are four terms, it may be possible to group into two binomial terms.

e.g. $5x + 10 - 3x^2 - 6x$
 $= 5(x + 2) - 3x(x + 2)$
 $= (x + 2)(5 - 3x)$

Trinomials of the form $ax^2 + bx + c$ (Ext)

Can be factorised using grouping also:

e.g. $3x^2 + 7x - 6$ $3 \times (-6) = -18$

$= 3x^2 + 9x - 2x - 6$ Use 9 and -2

$= 3x(x + 3) - 2(x + 3)$ since

$= (x + 3)(3x - 2)$ $9 \times (-2) = -18$

and $9 + (-2) = 7$

Solving equations with algebraic fractions (Ext)

Find the lowest common denominator (LCD) and multiply every term by the LCD or express each fraction using the LCD.

e.g. LCD of $2x$ and $3x$ is $6x$
 LCD of $(x - 1)$ and $(x + 3)$ is $(x - 1)(x + 3)$
 LCD of $2x$ and x^2 is $2x^2$

Chapter checklist and success criteria

A printable version of this checklist is available in the Interactive Textbook



8A	1. I can expand binomial products. e.g. Expand $(2x - 3)(x + 4)$.	<input type="checkbox"/>
8B	2. I can expand a perfect square and form a difference of two squares. e.g. Expand $(x - 6)^2$ and $(4x - 5)(4x + 5)$.	<input type="checkbox"/>
8C	3. I can factorise using the HCF. e.g. Factorise fully $12x^2 - 8x$ and $x(2x + 3) + 5(2x + 3)$.	<input type="checkbox"/>
8D	4. I can factorise a difference of two squares. e.g. Factorise $x^2 - 100$ and $4a^2 - 9$.	<input type="checkbox"/>
8E	5. I can factorise by grouping in pairs. e.g. Use the method of grouping in pairs to factorise $x^2 + 6x - 3x - 18$.	<input type="checkbox"/>
8E	6. I can factorise using grouping in pairs by first rearranging. e.g. Factorise $2x^2 - 9 - 6x + 3x$.	<input type="checkbox"/>
8F	7. I can factorise a quadratic trinomial. e.g. Factorise $x^2 + 4x - 21$.	<input type="checkbox"/>
8D/F	8. I can factorise with trinomials or difference of two squares by first taking out a common factor. e.g. Fully factorise $2x^2 - 18$ and $3x^2 - 21x + 36$.	<input type="checkbox"/>
8G	9. I can factorise trinomials of the form $ax^2 + bx + c$. e.g. Factorise $3x^2 + 10x + 9$ and $4x^2 - 4x - 3$.	Ext <input type="checkbox"/>
8H	10. I can simplify algebraic fractions by factorising and cancelling. e.g. Simplify $\frac{3x + 6}{8x + 16}$.	<input type="checkbox"/>
8H	11. I can multiply and divide algebraic fractions by first cancelling. e.g. Simplify $\frac{2(x + 5)}{x + 4} \times \frac{5(x + 4)(x - 1)}{6(x + 5)}$.	<input type="checkbox"/>
8H	12. I can multiply and divide algebraic fractions by factorising. e.g. Simplify $\frac{x^2 - 16}{x + 4} \div \frac{6x - 24}{3}$.	<input type="checkbox"/>
8I	13. I can add and subtract algebraic fractions with numeric denominators. e.g. Simplify $\frac{x + 4}{2} + \frac{x - 2}{3}$.	<input type="checkbox"/>
8I	14. I can add and subtract algebraic fractions with algebraic terms in the denominator. e.g. Simplify $\frac{4}{x} - \frac{2}{3x}$.	<input type="checkbox"/>
8J	15. I can subtract algebraic fractions. e.g. Simplify $\frac{2x + 2}{3} - \frac{x - 5}{4}$.	Ext <input type="checkbox"/>
8J	16. I can add or subtract algebraic fractions with binomial denominators. e.g. Simplify $\frac{3}{x + 2} + \frac{2}{x - 4}$.	Ext <input type="checkbox"/>
8K	17. I can solve equations involving algebraic fractions. e.g. Solve $\frac{3x}{2} + \frac{x}{5} = 3$ and $\frac{2}{x + 1} = \frac{6}{x - 5}$.	Ext <input type="checkbox"/>

Short-answer questions

8A

1 Expand the following binomial products.

a $(x - 3)(x + 4)$

b $(x - 7)(x - 2)$

c $(2x - 3)(3x + 2)$

d $3(x - 1)(3x + 4)$

8B

2 Expand the following.

a $(x + 3)^2$

b $(x - 4)^2$

c $(3x - 2)^2$

d $(x - 5)(x + 5)$

e $(7 - x)(7 + x)$

f $(11x - 4)(11x + 4)$

8C

3 Write the following in fully factorised form by removing the highest common factor.

a $4a + 12b$

b $6x - 9x^2$

c $-5x^2y - 10xy$

d $3(x - 7) + x(x - 7)$

e $x(2x + 1) - (2x + 1)$

f $(x - 2)^2 - 4(x - 2)$

8D

4 Factorise the following difference of two squares.

a $x^2 - 100$

b $3x^2 - 48$

c $25x^2 - y^2$

d $49 - 9x^2$

e $(x - 3)^2 - 81$

f $1 - x^2$

8E

5 Factorise the following by grouping in pairs.

a $x^2 - 3x + 6x - 18$

b $4x^2 + 10x - 2x - 5$

c $3x - 8b + 2bx - 12$

8F/G

6 Factorise the following trinomials.

a $x^2 + 8x + 15$

b $x^2 - 3x - 18$

c $x^2 - 7x + 6$

d $3x^2 + 15x - 42$

e $2x^2 + 16x + 32$

f $5x^2 + 17x + 6$

Ext g $4x^2 - 4x - 3$

Ext h $6x^2 - 17x + 12$

8H

7 Simplify the following.

a $\frac{3x + 12}{3}$

b $\frac{2x - 16}{3x - 24}$

c $\frac{x^2 - 9}{5(x + 3)}$

8H

8 Simplify the following algebraic fractions by first factorising and cancelling where possible.

a $\frac{3}{2x} \times \frac{x}{6}$

b $\frac{x(x - 4)}{8(x + 1)} \times \frac{4(x + 1)}{x}$

c $\frac{x^2 + 3x}{3x + 6} \times \frac{x + 2}{x + 3}$

d $\frac{2x}{5x + 20} \div \frac{x}{x + 4}$

e $\frac{4x^2 - 9}{10x^2} \div \frac{10x - 15}{x}$

f $\frac{x^2 + 5x + 6}{x + 3} \div \frac{x^2 - 4}{4x - 8}$

8I/J

9 Simplify the following by first finding the lowest common denominator.

a $\frac{x}{4} + \frac{2x}{3}$

b $\frac{3}{4x} + \frac{1}{2x}$

c $\frac{7}{x} - \frac{2}{x^2}$

Ext d $\frac{x - 1}{6} - \frac{x + 3}{8}$

Ext e $\frac{3}{x + 1} + \frac{5}{x + 2}$

Ext f $\frac{7}{(x - 4)^2} - \frac{2}{x - 4}$

8K

10 Solve the following equations involving fractions.

a $\frac{x}{4} + \frac{2x}{5} = 13$

b $\frac{4}{x} - \frac{2}{3x} = 20$

Ext c $\frac{x + 3}{2} + \frac{x - 4}{3} = 6$

d $\frac{4}{1 - x} = \frac{5}{x + 4}$

Multiple-choice questions

- 8A** 1 $(2x - 1)(x + 5)$ in expanded and simplified form is:
A $2x^2 + 9x - 5$ **B** $x^2 + 11x - 5$ **C** $4x^2 - 5$
D $3x^2 - 2x + 5$ **E** $2x^2 + 4x - 5$
- 8B** 2 $(3a + 2b)^2$ is equivalent to:
A $9a^2 + 6ab + 4b^2$ **B** $9a^2 + 4b^2$ **C** $3a^2 + 6ab + 2b^2$
D $3a^2 + 12ab + 2b^2$ **E** $9a^2 + 12ab + 4b^2$
- 8D** 3 $16x^2 - 49$ in factorised form is:
A $(4x - 7)^2$ **B** $(16x - 49)(16x + 49)$ **C** $(2x - 7)(8x + 7)$
D $(4x - 7)(4x + 7)$ **E** $4(4x^2 - 49)$
- 8E** 4 The factorised form of $x^2 + 3x - 2x - 6$ is:
A $(x - 3)(x + 2)$ **B** $x - 2(x + 3)^2$ **C** $(x + 3)(x - 2)$
D $x - 2(x + 3)$ **E** $x(x + 3) - 2$
- 8F** 5 If $(x - 2)$ is a factor of $x^2 + 5x - 14$ the other factor is:
A x **B** $x + 7$ **C** $x - 7$ **D** $x - 16$ **E** $x + 5$
- 8G** 6 The factorised form of $3x^2 + 10x - 8$ is:
A $(3x + 1)(x - 8)$
B $(x - 4)(3x + 2)$
C $(3x + 2)(x + 5)$
D $(3x - 2)(x + 4)$
E $(x + 1)(3x - 8)$
- Ext**
- 8H** 7 The simplified form of $\frac{3x + 6}{(x + 5)(x + 1)} \times \frac{x + 5}{x + 2}$ is:
A $\frac{3}{x + 1}$ **B** $\frac{15}{2x^2 + 5}$ **C** $x + 3$ **D** $\frac{5}{x + 2}$ **E** $3(x + 5)$
- 8I** 8 $\frac{x + 2}{5} + \frac{2x - 1}{3}$ written as a single fraction is:
A $\frac{11x + 1}{15}$ **B** $\frac{11x + 9}{8}$ **C** $\frac{3x + 1}{8}$ **D** $\frac{11x + 7}{15}$ **E** $\frac{13x + 1}{15}$
- 8J** 9 The LCD of $\frac{3x + 1}{2x}$ and $\frac{4}{x + 1}$ is:
A $8x$ **B** $2x(x + 1)$ **C** $(x + 1)(3x + 1)$
D $8x(3x + 1)$ **E** $x(x + 1)$
- Ext**
- 8K** 10 The solution to $\frac{3}{1 - x} = \frac{4}{2x + 3}$ is:
A $x = -\frac{1}{2}$ **B** $x = -\frac{9}{11}$ **C** $x = \frac{1}{7}$ **D** $x = 2$ **E** $x = -\frac{4}{5}$
- Ext**

Extended-response questions

- 1 A pig pen for a small farm is being redesigned. It is originally a square of side length x m.
- In the planning, the length is initially kept as x m and the width altered such that the area of the pen is $(x^2 + 3x)$ square metres. What is the new width?
 - Instead, it is determined that the original length will be increased by 1 metre and the original width will be decreased by 1 metre.
 - What effect does this have on the perimeter of the pig pen compared with the original size?
 - Determine an expression in expanded form for the new area of the pig pen. How does this compare with the original area?
 - The final set of dimensions requires an extra 8 m of fencing to go around the pen compared with the original pen. If the length of the pen has been increased by 7 m, then the width of the pen must decrease. Find:
 - the change that has been made to the width of the pen
 - the new area enclosed by the pen
 - what happens when $x = 3$.



- 2 The security tower for a palace is on a small square piece of land 20 m by 20 m with a moat of width x metres the whole way around it as shown.
- State the area of the piece of land.
 - Give expressions for the length and the width of the combined moat and land.
 - Find an expression, in expanded form, for the entire area occupied by the moat and the land.
 - If the tower occupies an area of $(x + 10)^2$ m², what fraction of the total area in part **b ii** is this?
 - Use your answers to parts **a** and **b** to give an expression for the area occupied by the moat alone, in factorised form.
 - Use trial and error to find the value of x such that the area of the moat alone is 500 m².

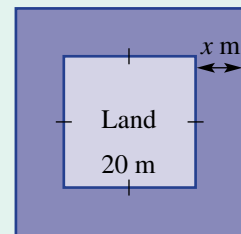

9

Probability and statistics



Maths in context: Data scientists

Mathematical skills in probability and statistics can lead to an interesting career in almost any area that appeals to you. Data scientists are people who use statistics and develop algorithms for collecting, organising, and interpreting data.

Biological data scientists apply advanced statistics in areas such as genetics, medicine, and health, and are called Bioinformaticians. For example, collecting and analysing data about malaria, HIV, tuberculosis; searching for ways to prevent these serious diseases.

Sports data scientists, with university statistics qualifications, are employed by many professional

sporting organizations to provide expert advice to coaches and players.

- Australian football and rugby teams employ sports scientists to analyse match performance data. They help coaches build game plans based on statistical measures from recent matches.
- Tennis Australia employs a sports scientist who writes algorithms that statistically analyse machine tracking data of ball and player. Advice is provided to tennis players for technique improvement and match strategy.

Chapter contents

- | | |
|---|--|
| 9A Review of probability
(CONSOLIDATING) | 9F Using relative frequencies to estimate probabilities |
| 9B Venn diagrams and two-way tables | 9G Data and sampling |
| 9C Using set notation | 9H Mean, median and mode |
| 9D Using arrays for two-step experiments | 9I Stem-and-leaf plots |
| 9E Using tree diagrams | 9J Grouping data into classes |
| | 9K Measures of spread: range and interquartile range |
| | 9L Box plots (EXTENDING) |

Australian Curriculum 9.0

STATISTICS

Analyse reports of surveys in digital media and elsewhere for information on how data was obtained to estimate population means and medians (AC9M9ST01)

Analyse how different sampling methods can affect the results of surveys and how choice of representation can be used to support a particular point of view (AC9M9ST02)

Represent the distribution of multiple data sets for numerical variables using comparative representations; compare data distributions with consideration of centre, spread and shape, and the effect of outliers on these measures (AC9M9ST03)

Choose appropriate forms of display or visualisation for a given type of data; justify selections and interpret displays for a given context (AC9M9ST04)

Plan and conduct statistical investigations involving the collection and analysis of different kinds of data; report findings and discuss the strength of evidence to support any conclusions (AC9M9ST05)

PROBABILITY

List all outcomes for compound events both with and without replacement, using lists, tree diagrams, tables or arrays; assign probabilities to outcomes (AC9M9P01)

Calculate relative frequencies from given or collected data to estimate probabilities of events involving “and”, inclusive “or” and exclusive “or” (AC9M9P02)

Design and conduct repeated chance experiments and simulations, using digital tools to compare probabilities of simple events to related compound events, and describe results (AC9M9P03)

© ACARA

Online resources

A host of additional online resources are included as part of your Interactive Textbook, including HOTmaths content, video demonstrations of all worked examples, auto-marked quizzes and much more.

9A Review of probability CONSOLIDATING

LEARNING INTENTIONS

- To review the key terms of probability
- To understand how a probability can be expressed numerically
- To be able to interpret the chance of an event based on its numerical probability
- To be able to find the probability of events for equally likely outcomes
- To be able to find the probability of the complement of an event

The mathematics associated with describing chance is called probability. We can precisely calculate the chance of some events occurring, such as rolling a sum of 12 from two dice or flipping three heads if a coin is tossed five times. To do this we need to know how many outcomes there are in total and how many of the outcomes are favourable (i.e. which match the result we are interested in). The number of favourable outcomes in comparison to the total number of outcomes will determine how likely it is that the favourable event will occur.



Tennis matches are won or lost on the average probability, p , of a player winning each point. Probability calculations show that the chance of winning a match increases rapidly if p increases slightly. E.g. 50% chance if $p = 0.5$; 75% if $p = 0.52$; and 95% if $p = 0.55$.

Lesson starter: Choose an event

As a class group, write down and discuss at least three events which have the following chance of occurring.

- impossible chance
- even (50–50) chance
- very high chance
- very low chance
- medium to high chance
- certain chance
- medium to low chance

KEY IDEAS

- A **chance** or **random experiment** is an activity that may produce a variety of different results (**outcomes**) which occur randomly. Rolling a die is a random experiment.
- The **sample space** is the list of all possible outcomes from an experiment.
- Set brackets $\{ \dots \}$ are used to list sets of numbers or other objects.
- An **event** is a collection of outcomes resulting from an experiment. For example, rolling a die is a random experiment with six possible outcomes: $\{ 1, 2, 3, 4, 5, 6 \}$. The event ‘rolling a number greater than 4’ includes the outcomes 5 and 6. This is an example of a **compound event** because it contains more than one element from the sample space.

- The probability of an event in which all outcomes are **equally likely** is given by:

$$\Pr(\text{Event}) = \frac{\text{Number of outcomes in which event occurs}}{\text{Total number of outcomes}}$$

- Probabilities are numbers between 0 and 1 inclusive, and can be written as a decimal, fraction or percentage. For example: 0.55 or $\frac{11}{20}$ or 55%

- For all events, $0 \leq \Pr(\text{Event}) \leq 1$.
-

- The **complement** of an event A is the event in which A does not occur.

$$\Pr(\text{not } A) = 1 - \Pr(A)$$

BUILDING UNDERSTANDING

- 1 Jim believes that there is a 1 in 4 chance that the flower on his prized rose will bloom tomorrow.

- a Express the chance '1 in 4' as:
 - i a fraction
 - ii a decimal
 - iii a percentage.
- b Indicate the level of chance described by Jim on this number line.

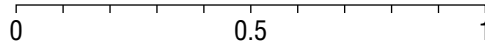

- 2 State the components missing from this table.

	Percentage	Decimal	Fraction	Number line
	50%	0.5	$\frac{1}{2}$	
a	25%			
b				
c		0.6		
d			$\frac{17}{20}$	

- 3 Ten people make the following guesses of the chance that they will get a salary bonus this year.

0.7, $\frac{2}{5}$, 0.9, $\frac{1}{3}$, 2 in 3, $\frac{3}{7}$, 1 in 4, 0.28, $\frac{2}{9}$, 0.15

Can you order their chances from lowest to highest? (*Hint:* Change each into a decimal.)



Example 1 Finding probabilities of events

This spinner has five equally divided sections.

- List the sample space using the given numbers.
- Find $\Pr(3)$.
- Find $\Pr(\text{not a } 3)$.
- Find $\Pr(\text{a } 3 \text{ or a } 7)$.
- Find $\Pr(\text{a number which is at least a } 3)$.

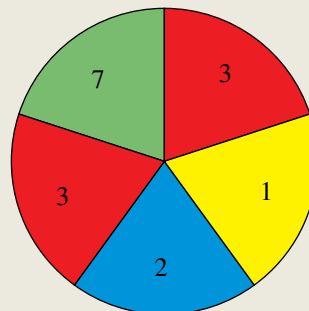

SOLUTION

a $\{1, 2, 3, 7\}$

b $\Pr(3) = \frac{2}{5}$ or 0.4

c $\Pr(\text{not a } 3) = 1 - \Pr(3)$
 $= 1 - \frac{2}{5}$ or $1 - 0.4$
 $= \frac{3}{5}$ or 0.6

d $\Pr(\text{a } 3 \text{ or a } 7) = \frac{2}{5} + \frac{1}{5}$
 $= \frac{3}{5}$

e $\Pr(\text{at least a } 3) = \frac{3}{5}$

EXPLANATION

Use set brackets and list all the possible outcomes in any order.

$$\Pr(3) = \frac{\text{number of sections labelled } 3}{\text{number of equal sections}}$$

'Not a 3' is the complementary event of obtaining a 3. Alternatively, count the number of sectors which are not 3.

There are two 3s and one 7 in the five sections.

Three of the sections have the numbers 3 or 7, which are 3 or more.

Now you try

This spinner has eight equally divided sections.

- List the sample space using the given numbers.
- Find $\Pr(2)$.
- Find $\Pr(\text{not a } 2)$.
- Find $\Pr(\text{a } 2 \text{ or a } 5)$.
- Find $\Pr(\text{a number which is at least a } 2)$.





Example 2 Choosing letters from a word

A letter is randomly chosen from the word PROBABILITY. Find the following probabilities.

- a Pr(L)
- b Pr(not L)
- c Pr(vowel)
- d Pr(consonant)
- e Pr(vowel or a B)
- f Pr(vowel or consonant)

SOLUTION

$$\text{a } \Pr(L) = \frac{1}{11}$$

$$\begin{aligned} \text{b } \Pr(\text{not } L) &= 1 - \frac{1}{11} \\ &= \frac{10}{11} \end{aligned}$$

$$\text{c } \Pr(\text{vowel}) = \frac{4}{11}$$

$$\begin{aligned} \text{d } \Pr(\text{consonant}) &= 1 - \frac{4}{11} \\ &= \frac{7}{11} \end{aligned}$$

$$\text{e } \Pr(\text{vowel or a B}) = \frac{6}{11}$$

$$\text{f } \Pr(\text{vowel or consonant}) = 1$$

EXPLANATION

One of the 11 letters in PROBABILITY is an L.

The event 'not L' is the complement of the event selecting an L. Complementary events sum to 1.

There are 4 vowels: O, A and two letter Is.

The events 'vowel' and 'consonant' are complementary.

There are 4 vowels and 2 letter Bs.

This event includes all possible outcomes.

Now you try

A letter is randomly chosen from the word AEROPLANE. Find the following probabilities.

- a Pr(R)
- b Pr(not R)
- c Pr(vowel)
- d Pr(consonant)
- e Pr(consonant or an A)
- f Pr(vowel or consonant)

Exercise 9A

FLUENCY

1, 2–3 ($\frac{1}{2}$), 5, 61, 2–4 ($\frac{1}{2}$), 5, 62–4 ($\frac{1}{2}$), 5, 6 ($\frac{1}{2}$)

Example 1

- 1 This spinner has seven equally divided sections.
- List the sample space using the given numbers.
 - Find $\text{Pr}(2)$.
 - Find $\text{Pr}(\text{not a } 2)$.
 - Find $\text{Pr}(\text{a } 2 \text{ or a } 3)$.
 - Find $\text{Pr}(\text{a number which is at least a } 2)$.



- 2 The spinners below have equally divided sections. Complete the following for each spinner.
- List the sample space using the given numbers.
 - Find $\text{Pr}(2)$.
 - Find $\text{Pr}(\text{not a } 2)$.
 - Find $\text{Pr}(\text{a } 2 \text{ or a } 3)$.
 - Find $\text{Pr}(\text{a number which is at least a } 2)$.

a

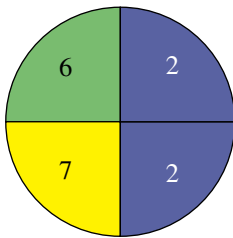

b

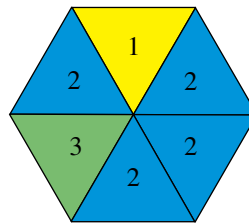

c

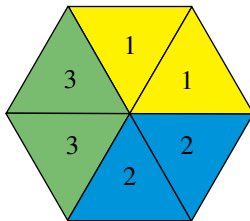

d

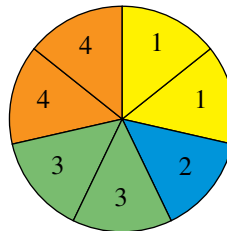

- 3 Find the probability of obtaining a blue ball when a ball is selected at random from a box which contains:
- 4 blue balls and 4 red balls
 - 3 blue balls and 5 red balls
 - 1 blue ball, 3 red balls and 2 white balls
 - 8 blue balls, 15 black balls and 9 green balls
 - 15 blue balls only
 - 5 yellow balls and 2 green balls.
- 4 Find the probability of *not* selecting a blue ball when a ball is selected at random from a box containing the balls described in Question 3 parts a to f above.

- 5 A swimming pool has eight lanes and each of eight swimmers has an equal chance of being placed in lane 1. Find the probability that a particular swimmer:
- a will swim in lane 1
 - b will not swim in lane 1.

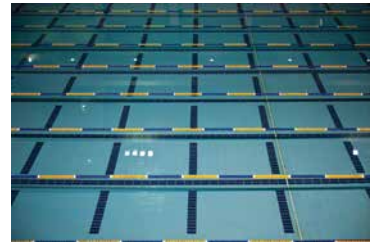

Example 2

- 6 A letter is chosen at random from the word ALPHABET. Find the following probabilities.
- a $\Pr(L)$
 - b $\Pr(A)$
 - c $\Pr(A \text{ or } L)$
 - d $\Pr(\text{vowel})$
 - e $\Pr(\text{consonant})$
 - f $\Pr(\text{vowel or consonant})$
 - g $\Pr(Z)$
 - h $\Pr(A \text{ or } Z)$
 - i $\Pr(\text{not an } A)$
 - j $\Pr(\text{letter from the first half of the alphabet})$

PROBLEM-SOLVING

7, 8

8, 9

8–9($\frac{1}{2}$), 10

- 7 The school captain is to be chosen at random from four candidates. Two are already 18 years old (Hayley and Rocco) and two are 17 years old (Alisa and Stuart).
- a List the sample space.
 - b Find the probability that the school captain will be:
 - i Hayley
 - ii currently 17 years old
 - iii neither Stuart nor Hayley.
- 8 A six-sided die is rolled and the uppermost face is observed and recorded. Find the following probabilities.
- a $\Pr(6)$
 - b $\Pr(3)$
 - c $\Pr(\text{not a } 3)$
 - d $\Pr(1 \text{ or } 2)$
 - e $\Pr(\text{a number less than } 5)$
 - f $\Pr(\text{an even number or odd number})$
 - g $\Pr(\text{a square number})$
 - h $\Pr(\text{not a prime number})$
 - i $\Pr(\text{a number greater than } 1)$

- 9 A card is drawn at random from a deck of 52 playing cards. The deck includes 13 black spades, 13 black clubs, 13 red hearts and 13 red diamonds. This includes four of each of ace, king, queen, jack, 2, 3, 4, 5, 6, 7, 8, 9 and 10. Find the probability that the card will be:
- a the queen of diamonds
 - b an ace
 - c a red king
 - d a red card
 - e a jack or a queen
 - f any card except a 2
 - g any card except a jack or a black queen
 - h not a black ace.

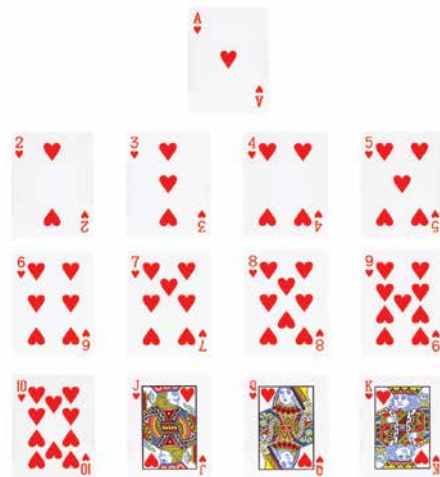

- 10 A letter is chosen at random from the word PROBABILITY. Find the probability that the letter will be:
- a B
 - not a B
 - a letter belonging to one of the first five letters in the alphabet
 - a letter from the word RABBIT
 - a letter that is not in the word RABBIT.

REASONING

11, 12

11, 12

12, 13

- 11 Amanda selects a letter at random from the word SOLO and writes $\Pr(S) = \frac{1}{3}$. Explain her error.
- 12 A six-sided die is rolled. Which of the following events have a probability equal to $\frac{1}{3}$?
- more than 4
 - at least 4
 - less than or equal to 3
 - no more than 2
 - at most 4
 - less than 3
- 13 A number is selected at random from the set $\{1, 2, 3, \dots, 25\}$. Find the probability that the number chosen is:
- | | | |
|------------------------|----------------------------|--------------------------|
| a a multiple of 2 | b a factor of 24 | c a square number |
| d a prime number | e divisible by 3 | f divisible by 3 or 2 |
| g divisible by 3 and 2 | h divisible by 2 or 3 or 7 | i divisible by 13 and 7. |

ENRICHMENT: Faulty iPhone

–

–

14

- 14 Xavier selects his favourite album on his iPhone and taps the shuffle function so songs are randomly played. The time length for each track is as shown in the table on the right.

The shuffle function is faulty and begins playing randomly at an unknown place somewhere on the album, not necessarily at the beginning of a track.

- Find the total number of minutes of music available on this album.
- Find the probability that the iPhone will begin playing on track 1.
- Find the probability that the iPhone will begin on:
 - track 2
 - track 3
 - a track that is 4 minutes long
 - track 4
 - track 7 or 8
 - a track that is not 4 minutes long.

Track	Time (minutes)
1	3
2	4
3	4
4	5
5	4
6	3
7	4
8	4

9B Venn diagrams and two-way tables

LEARNING INTENTIONS

- To understand how Venn diagrams and two-way tables are used to represent information
- To be able to construct a Venn diagram or two-way table based on collected data
- To be able to use a Venn diagram or two-way table to find the probability of events or the number in a particular category

When the results of an experiment involve overlapping categories, it can be very helpful to organise the information into a Venn diagram or two-way table. Probabilities of particular events can easily be calculated from these types of diagrams.

Lesson starter: Mac or PC

Twenty people were surveyed to find out whether they owned a Mac or PC computer at home. The survey revealed that 8 people owned a Mac and 15 people owned a PC. Everyone surveyed owned at least one type of computer.

Venn diagram

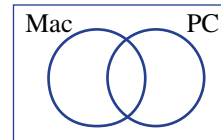

Two-way table

	Mac	No Mac	Total
PC			
No PC			
Total			

- Do you think some people owned both a Mac and PC? Discuss.
- Use these diagrams to help organise the number of people who own Macs and PCs.
- Use your diagrams to describe the proportion (fraction) of people owning Macs and/or PCs for all the different areas in the diagrams.

KEY IDEAS

■ A **Venn diagram** and a **two-way table** help to organise outcomes into different categories. This example shows the type of computers owned by 100 people.

Venn diagram

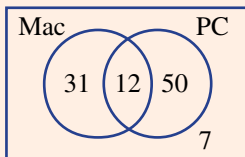

Two-way table

	Mac	No Mac	Total
PC	12	50	62
No PC	31	7	38
Total	43	57	100

These diagrams show, for example, that:

- 12 people own both a Mac and a PC
- 62 people own a PC
- 57 people do not own a Mac
- $\Pr(\text{Mac}) = \frac{43}{100}$
- $\Pr(\text{only Mac}) = \frac{31}{100}$
- $\Pr(\text{Mac or PC}) = \frac{93}{100}$
- $\Pr(\text{Mac and PC}) = \frac{12}{100} = \frac{3}{25}$

BUILDING UNDERSTANDING

1 This Venn diagram shows the number of people who enjoy riding and running.

a How many people in total are represented by this Venn diagram?

b How many people enjoy:

- i only riding?
- ii running (in total)?
- iii both riding and running?
- iv neither riding nor running?
- v riding or running?

c How many people do not enjoy:

- i riding?
- ii running?

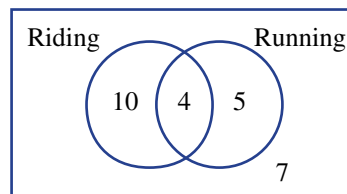

2 Match the diagrams **A**, **B**, **C** or **D** with the given description.

a S

b S only

c S and T

d S or T

A

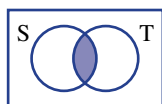

B

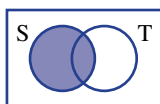

C

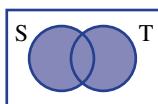

D



3 State the missing numbers in these two-way tables.

a

	A	Not A	Total
B	7	8	
Not B		1	
Total	10		

b

	A	Not A	Total
B	2		7
Not B		4	
Total			20



Example 3 Using a Venn diagram

A survey of 30 people found that 21 like AFL and 12 like soccer. Also, 7 people like both AFL and soccer and 4 like neither AFL nor soccer.

a Construct a Venn diagram for the survey results.

b How many people:

- i like AFL or soccer?
- ii do not like soccer?
- iii like only AFL?

c If one of the 30 people was randomly selected, find:

- i Pr(like AFL and soccer)
- ii Pr(like neither AFL nor soccer)
- iii Pr(like only soccer).

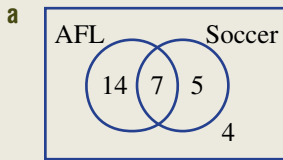
SOLUTION

b i 26

ii $30 - 12 = 18$

iii 14

c i $\Pr(\text{like AFL and soccer}) = \frac{7}{30}$

ii $\Pr(\text{like neither AFL nor soccer}) = \frac{4}{30}$
 $= \frac{2}{15}$

iii $\Pr(\text{like only soccer}) = \frac{5}{30}$
 $= \frac{1}{6}$

EXPLANATION

Place the appropriate number in each category ensuring that:

- the total who like AFL is 21
- the total who like soccer is 12
- there are 30 in total.

The total number of people who like AFL, soccer or both is $14 + 7 + 5 = 26$.

12 like soccer so 18 do not.

21 like AFL, but 7 of these also like soccer.

7 of the 30 people like AFL and soccer.

The 4 people who like neither AFL nor soccer sit outside both categories.

5 people like soccer but not AFL.

Now you try

A survey of 25 people found that 18 people like comedies and 12 like action movies. Also, 8 people like both comedies and action movies and 3 like neither comedies nor action movies.

a Construct a Venn diagram for the survey results.

b How many people:

- like comedies or action movies?
- do not like action movies?
- like only comedies?

c If one of the 25 people was randomly selected, find:

- $\Pr(\text{likes comedies and action movies})$
- $\Pr(\text{likes neither comedies nor action movies})$
- $\Pr(\text{likes only action movies})$.





Example 4 Using a two-way table

At a car yard, 24 cars are tested for fuel used: 18 of the cars run on petrol, 8 cars run on gas and 3 cars can run on both petrol and gas.

- a** Illustrate the situation using a two-way table.
- b** How many of the cars:
- do not run on gas?
 - run on neither petrol nor gas?
- c** Find the probability that a randomly selected car:
- runs on gas
 - runs on only gas
 - runs on gas or petrol.

SOLUTION

a

	Gas	Not gas	Total
Petrol	3	15	18
Not petrol	5	1	6
Total	8	16	24

- b i** 16

- ii** 1

c i $\Pr(\text{gas}) = \frac{8}{24}$
 $= \frac{1}{3}$

ii $\Pr(\text{only gas}) = \frac{5}{24}$

iii $\Pr(\text{gas or petrol}) = \frac{15 + 5 + 3}{24}$
 $= \frac{23}{24}$

EXPLANATION

Set up a table as shown and enter the numbers (in black) from the given information.

Fill in the remaining numbers (in red) ensuring that each column and row adds to the correct total.

The total at the base of the 'Not gas' column is 16.

The number at the intersection of the 'Not gas' column and the 'Not petrol' row is 1.

8 cars in total run on gas out of the 24 cars.

Of the 8 cars that run on gas, 5 of them do not also run on petrol.

Of the 24 cars, some run on petrol only (15), some run on gas only (5) and some run on gas and petrol (3).

Now you try

Thirty people at a gym are asked about their gym usage. Of these, 18 people attend classes, 19 people use the gym equipment and 8 people attend classes and use the equipment.

- a** Illustrate the situation using a two-way table.
- b** How many of the people:
- do not attend classes?
 - neither attend classes nor use the equipment?
- c** Find the probability that a randomly selected person:
- uses the gym equipment
 - only attends classes
 - attends classes or uses the gym equipment.

Exercise 9B

FLUENCY

1–5

1, 3–5

2, 4, 5

Example 3

- 1 In a class of 30 students, 22 carried a phone and 9 carried an iPad, 3 carried both a phone and an iPad and 2 students carried neither.
- Represent the information using a Venn diagram.
 - How many people:
 - carried a phone or an iPad or both?
 - did not carry an iPad?
 - carried only an iPad?
 - If one of the 30 people was selected at random, find the following probabilities.
 - $\Pr(\text{carries a phone and an iPad})$
 - $\Pr(\text{carries neither a phone nor an iPad})$
 - $\Pr(\text{carries only a phone})$



- 2 In a survey of 20 people, it is found that 13 people like toast for breakfast and 10 like cereal. Also 6 people like both toast and cereal and 3 like neither toast nor cereal.
- Represent the information using a Venn diagram.
 - How many people:
 - like toast or cereal for breakfast?
 - do not like toast?
 - like only toast?
 - If one of the 20 people was randomly selected, find:
 - $\Pr(\text{likes toast and cereal})$
 - $\Pr(\text{likes only cereal})$.

- 3 For each Venn diagram, find the following probabilities. You will need to calculate the total number in the sample first.
- $\Pr(A)$
 - $\Pr(A \text{ only})$
 - $\Pr(\text{not } B)$
 - $\Pr(A \text{ and } B)$
 - $\Pr(A \text{ or } B)$
 - $\Pr(\text{neither } A \text{ nor } B)$

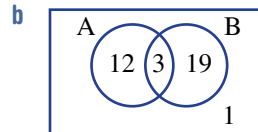
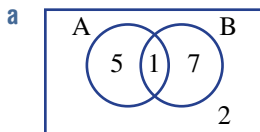

Example 4

- 4 Of the 50 desserts served at a restaurant one evening, 25 were served with ice-cream, 21 were served with cream and 5 were served with both cream and ice-cream.
- Illustrate the situation using a two-way table.
 - How many of the desserts:
 - did not have cream?
 - had neither cream nor ice-cream?
 - Find the probability that a randomly chosen dessert:
 - had cream
 - had only cream
 - had cream or ice-cream.



- 5 Find the following probabilities using each of the given tables. First fill in the missing numbers.
- i Pr(A)
 - ii Pr(not A)
 - iii Pr(A and B)
 - iv Pr(A or B)
 - v Pr(B only)
 - vi Pr(neither A nor B)

a

	A	Not A	Total
B	3	1	
Not B	2		4
Total			

b

	A	Not A	Total
B		4	15
Not B	6		
Total			26

PROBLEM-SOLVING 6–8 6–9 6, 8, 10

- 6 For each two-way table, fill in the missing numbers then transfer the information to a Venn diagram.

a

	A	Not A	Total
B	2		8
Not B			
Total		7	12

b

	A	Not A	Total
B		4	
Not B	9		13
Total	12		

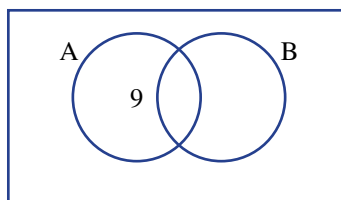
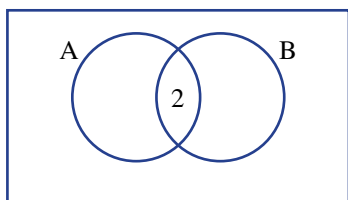

- 7 Of a group of 10 people, 6 rented their house, 4 rented a car and 3 did not rent either a car or their house.

- a Draw a Venn diagram.
- b How many people rented both a car and their house?
- c Find the probability that one person rented only a car.



- 8 One hundred people were surveyed regarding their use of water for their garden. Of that group, 23 said that they used rainwater, 48 said that they used tap water and 41 said that they did not water at all.

- a Represent this information in a two-way table.
- b How many people used both rain and tap water?
- c What is the probability that one person selected at random uses only tap water?
- d What is the probability that one person selected at random uses tap water or rainwater?

- 9 All members of a ski club enjoy skiing and/or snowboarding. Of those members, 7 enjoy only snowboarding, 16 enjoy skiing and 4 enjoy both snowboarding and skiing. How many people are in the ski club?

- 10 Of 30 cats, 24 eat tinned or dry food, 10 like dry food and 5 like both tinned and dry food. Find the probability that a randomly selected cat likes only tinned food.

REASONING 11 11, 12 12–14

11 Complete the two-way table and transfer to a Venn diagram using the pronumerals w , x , y and z .

	A	Not A	Total
B	x	y	
Not B	z	w	
Total			

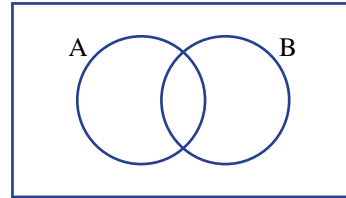
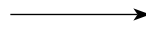

12 The total number of people in a survey is T . The number of Victorians in the survey is x and the number of doctors is y . The number of doctors who are Victorian is z . Write algebraic expressions for the following using any of the variables x , y , z and T .

- a The number who are neither Victorian nor a doctor
- b The number who are not Victorian
- c The number who are not doctors
- d The number who are Victorian but not a doctor
- e The number who are a doctor but not Victorian
- f The number who are not Victorian and a doctor
- g The number who are not Victorian nor a doctor

13 Explain what is wrong with this two-way table. Try to complete it to find out.

	A	Not A	Total
B		12	
Not B			7
Total	11		19

14 What is the minimum number of numbers that need to be given in a two-way table so that all numbers in the table can be calculated?

ENRICHMENT: Finding a rule for A and B – – 15

15 Two overlapping events, A and B, include 20 elements with 0 elements in the ‘neither A nor B’ region.

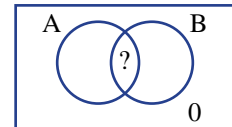

- a Draw a Venn diagram for the following situations.
 - i The number in A is 12 and the number in B is 10.
 - ii The number in A is 15 and the number in B is 11.
 - iii The number in A is 18 and the number in B is 6.
- b If the total number in A or B is now 100 (not 20), complete a Venn diagram for the following situations.
 - i The number in A is 50 and the number in B is 60.
 - ii The number in A is 38 and the number in B is 81.
 - iii The number in A is 83 and the number in B is 94.
- c Now describe a method that finds the number in the common area for A and B. Your method should work for all the above examples.

9C Using set notation

LEARNING INTENTIONS

- To know the symbols and notation used to describe different sets of data
- To be able to list sets from a description or diagram
- To be able to interpret symbols used to represent sets of data and find associated probabilities

Using symbols to describe different sets of objects can make the writing of mathematics more efficient and easier to read. For example, *the probability that a randomly chosen person likes both apples and bananas* could be written $\Pr(A \cap B)$, provided the events A and B are clearly defined.



Set notation is useful when analysing statistical data, such as: police data of car, bike and pedestrian accidents related to alcohol or speed or both; and energy company data of household numbers that use mains power or solar power or both.

Lesson starter: English language meaning to mathematical meaning

The number of elements in two events called A and B are illustrated in this Venn diagram. Use your understanding of the English language meaning of the given words to match with one of the mathematical terms and a number from the Venn diagram. They are in jumbled order.

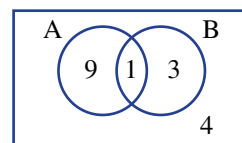

English	Mathematical	Number in Venn diagram
a not A	A A union B	i 1
b A or B	B sample space	ii 7
c A and B	C complement of A	iii 13
d anyone	D A intersection B	iv 17

KEY IDEAS

- The **sample space** (list of all possible outcomes) is sometimes called the universal set and is given the symbol S , Ω , U or ξ .
For example: $\Omega = \{1, 2, 3, 4, 5, 6, 7, 8, 9, 10\}$
- Set A is a particular **subset** (\subset) of the sample space if all the elements in A are contained in the sample space. For example, $\{2, 3, 5, 7\} \subset \{1, 2, 3, 4, 5, 6, 7, 8, 9, 10\}$.
- A' is the complement of A and contains the elements not in A .
- $5 \in A$ means that 5 is **an element of** A .
- \emptyset is the **null** or **empty** set and contains no elements; $\therefore \emptyset = \{ \}$.
- $n(A)$ is the **cardinal number** of A and means the number of elements in A , e.g. $n(A) = 4$.

$$A = \{2, 3, 5, 7\}$$

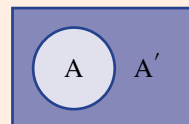

$$A' = \{1, 4, 6, 8, 9, 10\}$$

■ A Venn diagram can be used to illustrate how different subsets in the sample space are grouped.

For example: $A = \{2, 3, 5, 7\}$
 $B = \{1, 3, 5, 7, 9\}$

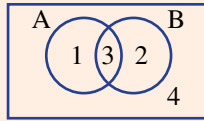

	A	A'	Total
B	3	2	5
B'	1	4	5
Total	4	6	10

- We usually write the cardinal numbers inside a Venn diagram.
- $A \cap B$ means A **and** B, which means the **intersection** of A and B and includes the elements in common with both sets: $\therefore A \cap B = \{3, 5, 7\}$.

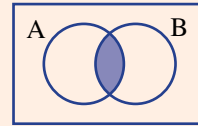

- $A \cup B$ means A **or** B, which means the **union** of A and B and includes the elements in either A or B or both: $\therefore A \cup B = \{1, 2, 3, 5, 7, 9\}$.

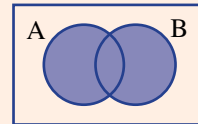

■ A **only** is the elements in A but not in B: $\therefore A \text{ only} = \{2\}$ and $n(A \text{ only}) = 1$.

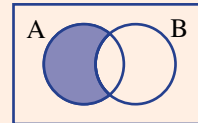

BUILDING UNDERSTANDING

1 Match each of the terms **a–f** with the symbols **A–F**.

- | | | |
|-----------------------|----------------------------|-----------------------------|
| a complement | b union | c element of |
| d intersection | e empty or null set | f number of elements |
| A \cap | B $n(A)$ | C A' |
| | D \cup | E \in |
| | | F \emptyset |

2 Choose a diagram **A–D** that matches each of these sets **a–d**.

- | | | | |
|---------------------|---------------|---------------------|-----------------|
| a $A \cup B$ | b A' | c $A \cap B$ | d B only |
|---------------------|---------------|---------------------|-----------------|

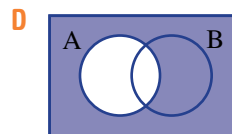
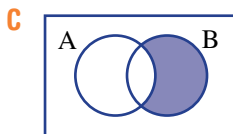
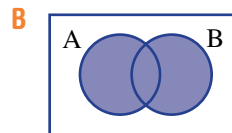
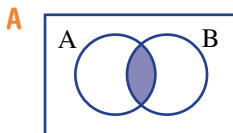

3 Using the given two-way table, state the following.

- a** $n(A \cap B)$
- b** $n(B)$
- c** $n(A)$
- d** $n(A')$

	A	A'	Total
B	2	8	10
B'	5	1	6
Total	7	9	16



Example 5 Using set notation

A number is chosen from the set of positive integers between 1 and 8 inclusive. A is the set of odd numbers between 1 and 8 inclusive and B is the set of prime numbers between 1 and 8 inclusive.

a List these sets.

i the sample space

ii A

iii B

b Draw a Venn diagram using the number of elements in each set.

c List these sets.

i $A \cap B$

ii $A \cup B$

iii A'

iv B only

d Find:

i $n(A)$

ii $\Pr(A)$

iii $n(A \cap B)$

iv $\Pr(A \cap B)$

SOLUTION

a i $\{1, 2, 3, 4, 5, 6, 7, 8\}$

ii $A = \{1, 3, 5, 7\}$

iii $B = \{2, 3, 5, 7\}$

b

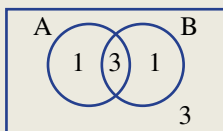

c i $A \cap B = \{3, 5, 7\}$

ii $A \cup B = \{1, 2, 3, 5, 7\}$

iii $A' = \{2, 4, 6, 8\}$

iv B only = $\{2\}$

d i $n(A) = 4$

ii $\Pr(A) = \frac{4}{8} = \frac{1}{2}$

iii $n(A \cap B) = 3$

iv $\Pr(A \cap B) = \frac{3}{8}$

EXPLANATION

List all the numbers, using set brackets.

A includes all the odd numbers.

B includes all the prime numbers. 1 is not prime.

Place each cardinal number into the appropriate region, i.e. there are 3 numbers common to sets A and B so 3 is placed in the overlapping region.

$\{3, 5, 7\}$ are common to both A and B.

$\{1, 2, 3, 5, 7\}$ are in either A or B or both.

A' means the elements not in A.

B only means the elements in B but not in A.

$n(A)$ is the cardinal number of A. There are four elements in A.

$\Pr(A)$ means the chance that the element will belong to A. There are 4 numbers in A compared with 8 in the sample space.

There are three elements in $A \cap B$.

Three of eight elements are in $A \cap B$.

Now you try

A number is chosen from the set of positive integers between 1 and 15 inclusive. A is the set of odd numbers between 1 and 15 inclusive and B is the set of prime numbers between 1 and 15 inclusive.

- a** List these sets.
- | | | |
|--------------------|------|-------|
| i the sample space | ii A | iii B |
|--------------------|------|-------|
- b** Draw a Venn diagram using the number of elements in each set.
- c** List these sets.
- | | | | |
|--------------|---------------|----------|-----------|
| i $A \cap B$ | ii $A \cup B$ | iii A' | iv B only |
|--------------|---------------|----------|-----------|
- d** Find:
- | | | | |
|----------|-------------|-------------------|--------------------|
| i $n(A)$ | ii $\Pr(A)$ | iii $n(A \cap B)$ | iv $\Pr(A \cap B)$ |
|----------|-------------|-------------------|--------------------|

Exercise 9C**FLUENCY**

1–3

1–4

2–4

- Example 5**
- 1** A number is chosen from the set of positive integers between 1 and 10 inclusive. A is the set of odd numbers between 1 and 10 inclusive and B is the set of prime numbers between 1 and 10 inclusive.
- a** List these sets.
- | | | |
|--------------------|------|-------|
| i the sample space | ii A | iii B |
|--------------------|------|-------|
- b** Draw a Venn diagram using the number of elements in each set
- c** List these sets.
- | | | | |
|--------------|---------------|----------|-----------|
| i $A \cap B$ | ii $A \cup B$ | iii A' | iv B only |
|--------------|---------------|----------|-----------|
- d** Find:
- | | | | |
|----------|-------------|-------------------|--------------------|
| i $n(A)$ | ii $\Pr(A)$ | iii $n(A \cap B)$ | iv $\Pr(A \cap B)$ |
|----------|-------------|-------------------|--------------------|
- 2** A number is chosen from the set of positive integers between 1 and 20 inclusive. A is the set of multiples of 3 that are less than 20 and B is the set of factors of 15.
- a** List sets A and B then draw a Venn diagram.
- b** List these sets.
- | | | | |
|--------------|---------------|----------|-----------|
| i $A \cap B$ | ii $A \cup B$ | iii A' | iv B only |
|--------------|---------------|----------|-----------|
- c** Find:
- | | | |
|--------------------|-----------------|--------------------|
| i $n(B)$ | ii $\Pr(B)$ | iii $n(A \cap B)$ |
| iv $\Pr(A \cap B)$ | v $n(A \cup B)$ | vi $\Pr(A \cup B)$ |
- 3** Consider the sample space $\Omega = \{1, 2, 3, 4, 5, 6\}$ and the sets $A = \{1, 4, 6\}$ and $B = \{2, 3, 5\}$.
- a** State whether the following are true (T) or false (F).
- | | |
|----------------------------|-----------------------------|
| i $A \subset \Omega$ | ii $B \subset \Omega$ |
| iii $3 \in A$ | iv $5 \in A$ |
| v $n(B) = 3$ | vi $n(B') = 2$ |
| vii $A \cap B = \emptyset$ | viii $A \cup B = \emptyset$ |
- b** Find these probabilities.
- | | | |
|------------|--------------|---------------------|
| i $\Pr(B)$ | ii $\Pr(B')$ | iii $\Pr(A \cap B)$ |
|------------|--------------|---------------------|

4 For each diagram or table, find the following probabilities.

i $\Pr(A \cap B)$

ii $\Pr(A \cup B)$

iii $\Pr(A')$

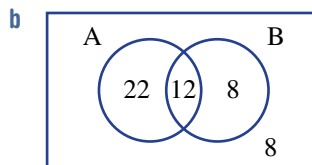
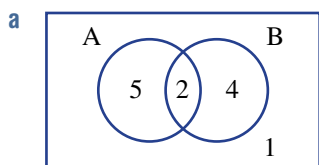

c

	A	A'	Total
B	5	2	
B'			
Total	9		15

d

	A	A'	Total
B		8	13
B'	4		
Total		12	

PROBLEM-SOLVING

5-7

5-7

6, 7

5 Four students have the names FRED, RON, RACHEL and HELEN while the sets A, B and C are defined by:

A = {students with a name including the letter R}

B = {students with a name including the letter E}

C = {students with a name including the letter Z}

a List these sets.

i A

ii B

iii C

iv $A \cap B$

b If a student is chosen at random from the group, find these probabilities.

i $\Pr(A)$

ii $\Pr(A')$

iii $\Pr(C)$

iv $\Pr(C')$

v $\Pr(A \cap B)$

vi $\Pr(A \cup B)$

6 Consider all the letters of the alphabet. Let A = {the set of vowels} and B = {different letters of the word MATHEMATICS}. Find:

a $n(\text{sample space})$

b $n(A)$

c $n(A \cap B)$

d $n(B')$

e $\Pr(A)$

f $\Pr(A')$

g $\Pr(A \cap B)$

h $\Pr(A \cup B)$

7 For 50 people who all have at least a cat or a dog, let A be the set of all pet owners who have a dog and B be the set of all pet owners who have a cat. If $n(A) = 32$ and $n(B) = 29$, find the following.

a $n(A \cap B)$

b $n(A \text{ only})$

c $\Pr(A \cup B)$

d $\Pr(A')$



REASONING 8, 9 8–10 10–12

8 From Question 7, A is the set of dog owners and B is the set of cat owners. Write a brief description of the following groups of people.

- a $A \cap B$ b $A \cup B$ c B' d B only

9 The region ‘A only’ could be thought of as the intersection of A and the complement of B so, $A \text{ only} = A \cap B'$. Use set notation to describe the region ‘B only’.

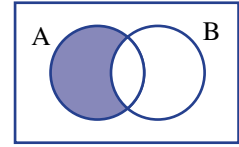

10 a Is $n(A) + n(B)$ ever equal to $n(A \cup B)$? If so, show an example using a Venn diagram.

b Is $n(A) + n(B)$ ever less than $n(A \cup B)$? Explain.

11 The four inner regions of a two-way table can be described using intersections. The A only region is described by $n(A \cap B')$. Describe the other three regions using intersections.

	A	A'	Total
B			$n(B)$
B'	$n(A \cap B')$		$n(B')$
Total	$n(A)$	$n(A')$	$n(\Omega)$

12 Research what it means if we say that two events A and B are **mutually exclusive**. Give a brief description.

ENRICHMENT: How are $A' \cap B'$ and $(A \cup B)'$ related? – – 13

13 Consider the set of integers $\{1, 2, 3, \dots, 20\}$. Let $A = \{\text{prime numbers less than } 20\}$ and $B = \{\text{factors of } 12\}$.

a List these sets.

- | | | |
|-----------------|------------------|-----------------|
| i A | ii B | iii $A \cap B$ |
| iv $A \cup B$ | v $A' \cap B$ | vi $A \cap B'$ |
| vii $A' \cup B$ | viii $A \cup B'$ | ix $A' \cup B'$ |

b Find the following probabilities.

- | | | | |
|--------------------|-----------------------|-----------------------|-------------------------|
| i $\Pr(A \cup B)$ | ii $\Pr(A \cap B)$ | iii $\Pr(A' \cap B)$ | iv $\Pr(A' \cap B')$ |
| v $\Pr(A \cup B')$ | vi $\Pr((A \cap B)')$ | vii $\Pr(A' \cup B')$ | viii $\Pr((A \cup B)')$ |

c Draw Venn diagrams to shade the regions $A' \cap B'$ and $(A \cup B)'$. What do you notice?



9D Using arrays for two-step experiments

LEARNING INTENTIONS

- To understand how an array is used to list the sample space for experiments with two steps
- To understand the difference between experiments that are carried out with replacement and without replacement
- To be able to use an array to find the sample space for experiments carried out with replacement or without replacement and determine the probability of associated events

When an experiment consists of two steps such as rolling two dice or selecting two people from a group, we can use an array (or table) to systematically list the sample space.



Genetic arrays find probabilities of inherited traits, such as for the melanin pigments that control hair, eye and skin colour. Fairer skin has a higher risk of skin cancer: 30% of melanomas arise from moles, 70% from normal skin.

Lesson starter: Is it a 1 in 3 chance?

Billy tosses two coins on the kitchen table at home and asks what the chance is of getting two tails.

- Dad says that there are 3 outcomes: two heads, two tails or one of each, so there is a 1 in 3 chance.
- Mum says that with coins, all outcomes have a 1 in 2 chance of occurring.
- Billy's sister Betty says that there are 4 outcomes so it's a 1 in 4 chance.

Can you explain who is correct and why?

KEY IDEAS

- An **array** or table is often used to list the sample space for experiments with two steps.
- When listing outcomes it is important to be consistent with the order for each outcome. For example: the outcome (heads, tails) should be distinguished from the outcome (tails, heads).
- Some experiments are conducted **without replacement**, which means some outcomes that may be possible **with replacement** are not possible.

For example: Two letters are chosen from the word CAT.

With replacement

		1st		
		C	A	T
2nd	C	(C, C)	(A, C)	(T, C)
	A	(C, A)	(A, A)	(T, A)
	T	(C, T)	(A, T)	(T, T)

9 outcomes

Without replacement

		1st		
		C	A	T
2nd	C	×	(A, C)	(T, C)
	A	(C, A)	×	(T, A)
	T	(C, T)	(A, T)	×

6 outcomes

BUILDING UNDERSTANDING

1 State the missing outcomes, then count the total number of outcomes. Part **a** is *with replacement* and part **b** is *without replacement*.

a

		1st		
		1	2	3
2nd	1	(1, 1)	(2, 1)	
	2			
	3			

b

		1st		
		A	B	C
2nd	A	×	(B, A)	(C, A)
	B		×	
	C			×

2 These two tables list the outcomes for the selection of two letters at random from the word MAT.

Table A

		M	A	T
M	(M, M)	(A, M)	(T, M)	
A	(M, A)	(A, A)	(T, A)	
T	(M, T)	(A, T)	(T, T)	

Table B

		M	A	T
M	×	(A, M)	(T, M)	
A	(M, A)	×	(T, A)	
T	(M, T)	(A, T)	×	

- a** Which table shows selection where replacement is allowed (with replacement)?
b Which table shows selection where replacement is not allowed (without replacement)?
c What is the probability of choosing the outcome (T, M) from:
i Table A? **ii** Table B?
d How many outcomes include the letter A using:
i Table A? **ii** Table B?



Example 6 Finding the sample space for events with replacement

Two coins are tossed.

- a** Draw a table to list the sample space.
b Find the probability of obtaining (H, T).
c Find Pr(1 head).

SOLUTION

a

		Toss 1	
		H	T
Toss 2	H	(H, H)	(T, H)
	T	(H, T)	(T, T)

Sample space =
 {(H, H), (H, T), (T, H), (T, T)}

- b** $\Pr(H, T) = \frac{1}{4}$
c $\Pr(1 \text{ head}) = \frac{2}{4} = \frac{1}{2}$

EXPLANATION

Represent the results of each coin toss.

The table shows four possible outcomes.

One of the four outcomes is (H, T).

Two outcomes have one head: (H, T), (T, H).

Now you try

Two identical counters have a red side (R) and a blue side (B). They are each tossed.

- Draw a table to list the sample space.
- Find the probability of obtaining (B, B).
- Find $\Pr(1 \text{ red side})$.

**Example 7 Finding the sample space for events without replacement**

Two letters are chosen at random from the word TREE without replacement.

- List the outcomes in a table.
- Find the probability that the two letters chosen are both E.
- Find the probability that at least one of the letters is an E.

SOLUTION

a

		1st			
		T	R	E	E
2nd	T	×	(R, T)	(E, T)	(E, T)
	R	(T, R)	×	(E, R)	(E, R)
	E	(T, E)	(R, E)	×	(E, E)
	E	(T, E)	(R, E)	(E, E)	×

b $\Pr(E, E) = \frac{2}{12} = \frac{1}{6}$

c $\Pr(\text{at least one E}) = \frac{10}{12} = \frac{5}{6}$

EXPLANATION

List all the outcomes maintaining a consistent order. Note that the same letter cannot be chosen twice. Both Es need to be listed so that each outcome in the sample space is equally likely.

As there are 2 Es in the word TREE, it is possible to obtain the outcome (E, E) in two ways.

10 of the 12 outcomes contain at least one E.

Now you try

Two letters are chosen at random from the word DATA without replacement.

- List the outcomes in a table.
- Find the probability that the two letters chosen are both A.
- Find the probability that at least one of the letters is an A.

Exercise 9D

FLUENCY

1–3

1–4

1, 3, 4

Example 6

- 1 A six-sided die is rolled twice.
- Complete a table like the one shown.
 - What is the total number of outcomes?
 - Find the probability that the outcome is:
 - (1, 1)
 - a double (two of the same number)
 - (3, 1), (2, 2) or (1, 3)
 - any outcome containing a 1 or a 6.

		1st					
		1	2	3	4	5	6
2nd	1	(1, 1)	(2, 1)				
	2						
	3						
	4						
	5						
	6						

- 2 Two dots are selected, one from each of the sets A and B, where $A = \{\bullet, \circ\}$ and $B = \{\bullet, \circ, \circ\}$.
- Complete a table like this one, showing all the possible outcomes.
 - State the total number of outcomes.
 - Find the probability that the outcome will:
 - be (\bullet, \circ)
 - contain one black dot
 - contain two of the same dots.

		A	
		\bullet	\circ
B	\bullet	(\bullet, \bullet)	(\circ, \bullet)
	\circ		
	\circ		

Example 7

- 3 Two letters are chosen at random from the word DOG *without replacement*.
- Complete a table like the one shown.
 - Find the probability of obtaining the (G, D) outcome.
 - Find the probability of obtaining an outcome with an O in it.
- 4 Two digits are selected at random *without replacement* from the set $\{1, 2, 3, 4\}$.
- Draw a table to show the sample space. Remember doubles such as (1, 1), (2, 2), etc. are not allowed.
 - Find:
 - $\text{Pr}(1, 2)$
 - $\text{Pr}(4, 3)$.
 - Find the probability that:
 - both numbers will be at least 3
 - the outcome will contain a 1 or a 4
 - the outcome will contain a 1 and a 4
 - the outcome will not contain a 3.

		1st		
		D	O	G
2nd	D	×	(O, D)	(G, D)
	O		×	
	G			×

PROBLEM-SOLVING 5, 6 5, 6 6, 7

- 5 The total sum is recorded from rolling two four-sided dice.
- Copy and complete this table, showing all possible totals that can be obtained.
 - Find the probability that the total sum is:
 - 2
 - 2 or 3
 - less than or equal to 4
 - more than 6
 - at most 6.

		Roll 1			
		1	2	3	4
Roll 2	1	2	3		
	2				
	3				
	4				



- 6 Jill guesses the answers to two multiple-choice questions with options A, B, C, D or E.
- Copy and complete this table, showing all possible guesses that can be obtained.

		Guess 1				
		A	B	C	D	E
Guess 2	A	(A, A)	(B, A)			
	B					
	C					
	D					
	E					

- Find the probability that she will guess:
 - (D, A)
 - the same letter
 - different letters.
 - Find the probability that Jill will get:
 - exactly one of her answers correct
 - both of her answers correct.
- 7 Many board games involve the rolling of two six-sided dice.
- Use a table to help find the probability that the sum of the two dice is:
 - 12
 - 2 or 3
 - 11 or 12
 - less than or equal to 7
 - less than 7
 - at least 10
 - at most 4
 - 1.
 - Which total sum has the highest probability and what is the probability of rolling that sum?

REASONING

8, 9

9–11

10–12

- 8 Two letters are chosen at random from the word MATHEMATICIAN.
- How many outcomes sit in the sample space if selections are made:
 - with replacement?
 - without replacement?
 - How many of the outcomes contain the same letter if selection is made:
 - with replacement?
 - without replacement?
- 9 Two letters are chosen from the word WOOD without replacement. Is it possible to obtain the outcome (O, O)? Explain why.
- 10 In a bag are five counters each of a different colour: green (G), yellow (Y), red (R), blue (B) and purple (P).
- A counter is drawn from the bag, replaced and then a second is selected. Find the probability that a green counter then a blue counter are selected; that is, find $\text{Pr}(G, B)$.
 - The counter selected is not replaced before the second is selected. Find the probability that a green counter then a blue counter are selected.
- 11 A six-sided die and a ten-sided die have been rolled simultaneously. What total sum(s) has/have the highest probability?
- 12 A spinner numbered 1 to 50 with equal size sectors is spun twice. Find the probability that the total for the two spins is:
- 100
 - 51
 - 99
 - 52
 - 55

ENRICHMENT: Two cards from the deck

–

–

13

- 13 Two cards are dealt to you from a pack of playing cards that includes four suits (Hearts, Diamonds, Clubs and Spades), with each suit containing {2, 3, 4, 5, 6, 7, 8, 9, 10, J, Q, K, A}. You keep both cards.
- Does this situation involve with replacement or without replacement?
 - How many outcomes would there be in your sample space (all possible selections of two cards)?
 - What is the probability of receiving an ace of diamonds and an ace of hearts?
 - Find the probability of obtaining two cards that:
 - are both twos
 - are both hearts.



9E Using tree diagrams

LEARNING INTENTIONS

- To understand how tree diagrams are used to list the sample space for experiments with two or more steps where each outcome is equally likely
- To be able to construct a tree diagram to show all possible outcomes and find the probability of events

When experiments consist of two or more steps, a tree diagram can be used to list the sample space. Tables are often used for two-step experiments, but a tree diagram can be extended for experiments with any number of steps.



The spread of an infectious disease can be simply modelled with a tree diagram. If each ill person infects 4 other people, after 10 infection 'waves', over 1 million people are infected. Fortunately, vaccination strengthens the immune system, reducing infection rates.

Lesson starter: What's the difference?

You are offered a choice of two pieces of fruit from a banana, an apple and an orange. You choose two at random. This tree diagram shows selection with replacement.

- How many outcomes will there be?
- How many of the outcomes contain two round fruits?
- How would the tree diagram change if the selection was completed without replacement? Would there be any difference in the answers to the above two questions? Discuss.

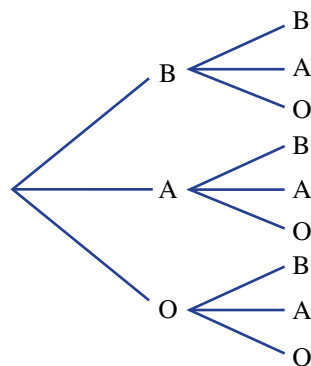

KEY IDEAS

- **Tree diagrams** are used to list the sample space for experiments with two or more steps.
 - The outcomes for each stage of the experiment are listed vertically and each stage is connected with branches.

For example:

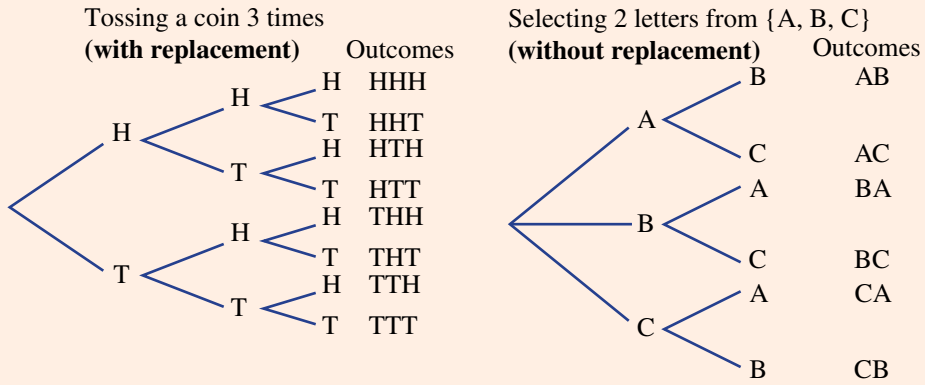

In these examples, each set of branches produces outcomes that are all equally likely.

BUILDING UNDERSTANDING

- 1 State the missing components for this tree diagram for selecting two letters *with replacement* from the word TO and list the outcomes.

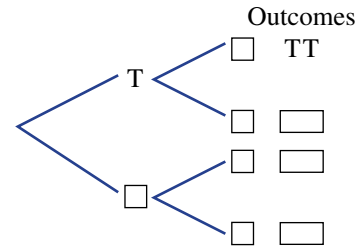

- 2 State the missing components for this tree diagram to find the outcomes of selecting two people from a group of three (A, B and C) *without replacement*.

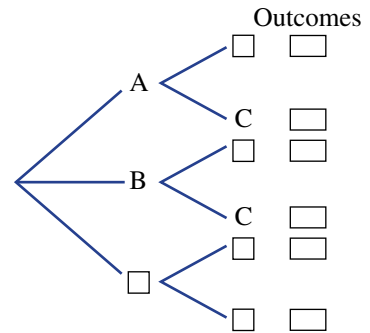



Example 8 Constructing a tree diagram

An experiment involves tossing two coins.

- a Complete a tree diagram to show all possible outcomes.
- b What is the total number of outcomes?
- c Find the probability of tossing:
 - i two tails
 - ii one tail
 - iii at least one head.

SOLUTION

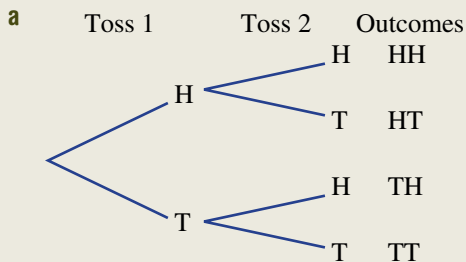

- b The total number of outcomes is 4.
- c
 - i $\Pr(\text{TT}) = \frac{1}{4}$
 - ii $\Pr(\text{1 tail}) = \frac{2}{4} = \frac{1}{2}$
 - iii $\Pr(\geq 1 \text{ head}) = \frac{3}{4}$

EXPLANATION

The tree diagram shows two coin tosses one after the other resulting in $2 \times 2 = 4$ outcomes.

There are four possibilities in the outcomes column.

One of the four outcomes is TT.

Two outcomes have one tail: {HT, TH}.

Three outcomes have at least one head: {HH, HT, TH}.

Now you try

Two regular six-sided die are rolled. It is noted if they show odd (O) or even (E) numbers.

- a Complete a tree diagram to show all possible odd (O) and even (E) outcomes.
- b What is the total number of outcomes?
- c Find the probability of rolling:
 - i two even numbers
 - ii one even number
 - iii at least one odd number.



Example 9 Constructing a tree diagram without replacement

Two people are selected at random without replacement from a group of three: Annabel (A), Brodie (B) and Chris (C).

- a** List all the possible outcomes for the selection using a tree diagram.
- b** Find the probability that the selection will contain:
- i Annabel and Brodie ii Chris iii Chris or Brodie.

SOLUTION

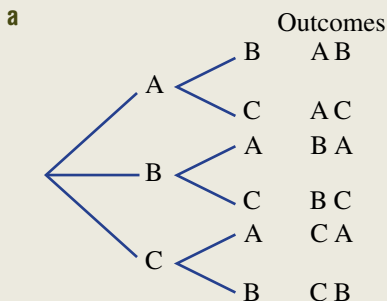

EXPLANATION

On the first choice there are three options (A, B or C), but on the second choice there are only two remaining.

b i $\Pr(\text{Annabel and Brodie}) = \frac{2}{6}$
 $= \frac{1}{3}$

2 of the 6 outcomes contain Annabel and Brodie (A B) and (B A).

ii $\Pr(\text{Chris}) = \frac{4}{6}$
 $= \frac{2}{3}$

4 out of the 6 outcomes contain Chris.

iii $\Pr(\text{Chris or Brodie}) = \frac{6}{6}$
 $= 1$

All of the outcomes contain at least one of Chris or Brodie.

Now you try

Two lollipops are selected at random without replacement from a group of three: strawberry (S), grape (G) and cola (C).

- a** List all the possible outcomes for the selection using a tree diagram.
- b** Find the probability that the selection will contain:
- i strawberry and cola ii grape iii grape or cola.

Exercise 9E

FLUENCY

1–4

1–4

2, 4, 5

Example 8

- 1 A coin is tossed twice.
- Complete this tree diagram to show all the possible outcomes.
 - What is the total number of outcomes?
 - Find the probability of obtaining:
 - two heads
 - one head
 - at least one head
 - at least one tail.

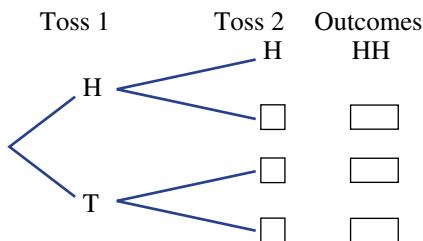

- 2 A spinner with three numbers, 1, 2 and 3, is spun twice.
- List the set of possible outcomes, using a tree diagram.
 - What is the total number of possible outcomes?
 - Find the probability of spinning:
 - two 3s
 - at least one 3
 - no more than one 2
 - two odd numbers.

Example 9

- 3 Two people are selected at random without replacement from a group of three: Donna (D), Elle (E) and Fernando (F).
- List all the possible outcomes for the selection using a tree diagram.
 - Find the probability that the selection will contain:
 - Donna and Elle
 - Fernando
 - Fernando or Elle.

- 4 A drawer contains two red socks (R), one blue sock (B) and one yellow sock (Y). Two socks are selected at random without replacement.
- Copy and complete this tree diagram.
 - Find the probability of obtaining:
 - a red sock and a blue sock
 - two red socks
 - any pair of socks of the same colour
 - any pair of socks of different colour.

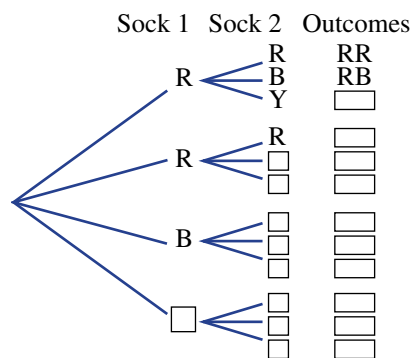

- 5 A student who has not studied for a multiple-choice test decides to guess the answers for every question. There are three questions, and three choices of answer (A, B and C) for each question. Given that only one of the possible choices (A, B or C) is correct for each question, state the probability that the student guesses:
- 1 correct answer
 - 2 correct answers
 - 3 correct answers
 - 0 correct answers.

PROBLEM-SOLVING

6

6, 7

6, 7

- 6 Michael needs to deliver parcels to three places (A, B and C in order) in the city. This diagram shows the different ways in which he can travel.

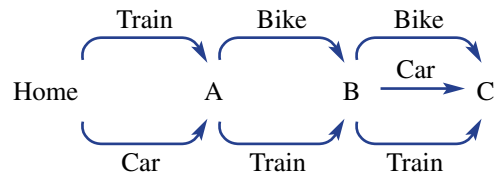

- a Draw a tree diagram showing all the possible outcomes of transportation options.
- b What is the total number of possible outcomes?
- c If Michael randomly chooses one of these outcomes, find the probability that he will use:
- the train all three times
 - the train exactly twice
 - his bike exactly once
 - different transport each time
 - a car at least once.
- 7 A shelf in a discount supermarket contains an equal number of tins of tomatoes and tins of peaches – all mixed together and without labels. You select four tins in a hurry. Use a tree diagram to help find the probability of selecting the correct number of tins of tomatoes and/or peaches for each of these recipe requirements. Assume that the shelves are continually refilled so that probabilities remain constant.
- You need four tins of tomatoes for a stew.
 - You need four tins of peaches for a peach crumble.
 - You need at least three tins of tomatoes for a bolognese.
 - You need at least two tins of peaches for a fruit salad.
 - You need at least one tin of tomatoes for a vegetable soup.

REASONING

8

8, 9

9, 10

- 8 You toss a coin four times. Use a tree diagram to find the probability that you toss:
- 0 tails
 - 1 tail
 - 2 tails
 - 3 tails
 - 4 tails.
- 9 a A coin is tossed 5 times. How many outcomes will there be?
b A coin is tossed n times. Write a rule for the number of outcomes in the sample space.
- 10 Use a tree diagram to investigate the probability of selecting two counters from a bag of three black and two white counters if the selection is drawn:
- with replacement
 - without replacement.

Is there any difference?

ENRICHMENT: Selecting matching clothes

–

–

11

- 11 A man randomly selects a tie from his collection of one green and two red ties, a shirt from a collection of one red and two white shirts, and either a red or a black hat. Use a tree diagram to help find the probability that he selects a tie, shirt and hat according to the following descriptions:
- red tie, red shirt and black hat
 - all three items red
 - one item red
 - two items red
 - at least two items red
 - a green hat
 - a green tie and a black hat
 - a green tie or a black hat
 - not a red item
 - a red tie or white shirt or black hat.

9F Using relative frequencies to estimate probabilities

LEARNING INTENTIONS

- To know how to calculate the experimental probability from an experiment or survey
- To understand the effect on the experimental probability if the number of trials is increased
- To be able to find the expected number of occurrences of an outcome using probability

In some situations it may not be possible to list all the outcomes in the sample space and find theoretical probabilities. If this is the case then an experiment, survey or simulation can be conducted to find experimental probabilities. Provided the experiment includes a sufficient number of trials, these probabilities can be used to estimate the chance of particular events. Experimental probability is frequently used in science experiments and for research in medicine and economics.



An actuary uses past data to calculate the probability of insurance claims for property loss, accidents, sickness or death. Based on these risk probabilities, actuaries determine the insurance premiums for different age groups and various activities.

Lesson starter: Newspaper theories

A tabloid newspaper reports that of 10 people interviewed in the street, five had a dose of the flu. At about the same time a medical student tested 100 people and found that 21 had the flu.

- What is the experimental probability of having the flu, according to the newspaper's survey?
- What is the experimental probability of having the flu, according to the medical student's results?
- Which of the two sets of results would be more reliable and why? Discuss the reasons.
- Using the medical student's results, how many people would you expect to have the flu in a group of 1000 and why?

KEY IDEAS

- **Experimental probability** or **relative frequency** is calculated using the results of an experiment or survey.

$$\text{Experimental probability} = \frac{\text{number of times the outcome occurs}}{\text{total number of trials in the experiment}} = \text{relative frequency}$$

- The **long-run proportion** is the experimental probability for a sufficiently large number of trials.
- The **expected number of occurrences** = probability \times number of trials.

BUILDING UNDERSTANDING

- 1 This table shows the results of three different surveys of how many people in Perth use public transport (PT).

Survey	Number who use PT	Survey size	Experimental probability
A	2	10	$\frac{2}{10} = 0.2$
B	5	20	_____
C	30	100	_____

- a What are the two missing numbers in the experimental probability list?
 b Which survey should be used to estimate the probability that a person uses public transport and why?
- 2 The experimental probability of Jess hitting a bullseye on a dartboard is 0.05 (or $\frac{5}{100}$). How many bullseyes would you expect Jess to get if she threw the following number of darts?
 a 100 darts b 400 darts c 80 darts

**Example 10 Finding the experimental probability**

A box contains an unknown number of coloured balls and a ball is drawn from the box and then replaced. The procedure is repeated 100 times and the colour of the ball drawn is recorded each time. Twenty-five red balls were recorded.

- a Find the experimental probability for selecting a red ball.
 b Find the expected number of red balls drawn if the procedure was repeated 500 times.

SOLUTION

$$\begin{aligned} \text{a } \Pr(\text{red ball}) &= \frac{25}{100} \\ &= 0.25 \end{aligned}$$

$$\begin{aligned} \text{b } \text{Expected number of red balls in 500} \\ &= 0.25 \times 500 \\ &= 125 \end{aligned}$$

EXPLANATION

$$\Pr(\text{red ball}) = \frac{\text{number of red balls drawn}}{\text{total number of balls drawn}}$$

There are 25 red balls drawn and 100 balls in total.

$$\begin{aligned} \text{Expected number of occurrences} \\ &= \text{probability} \times \text{number of trials} \end{aligned}$$

Now you try

A biscuit jar contains an unknown number of biscuits and a biscuit is drawn from the jar and then replaced. The procedure is repeated 50 times and the type of biscuit drawn is recorded each time. Thirty choc-chip biscuits were recorded.

- a Find the experimental probability for selecting a choc-chip biscuit.
 b Find the expected number of choc-chip biscuits drawn if the procedure was repeated 200 times.

Exercise 9F

FLUENCY

1, 2

1–3

2, 3

Example 10

- 1 A bag contains an unknown number of counters, and a counter is selected from the bag and then replaced. The procedure is repeated 100 times and the colour of the counter is recorded each time. Sixty of the counters drawn were blue.
 - a Find the experimental probability for selecting a blue counter.
 - b Find the expected number of blue counters drawn if the procedure was repeated:
 - i 100 times
 - ii 200 times
 - iii 600 times.

- 2 In an experiment involving 200 people chosen at random, 175 people said that they owned a home computer.
 - a Calculate the experimental probability of choosing a person who owns a home computer.
 - b Find the expected number of people who own a home computer from the following group sizes.
 - i 400 people
 - ii 5000 people
 - iii 40 people

- 3 By calculating the experimental probability, estimate the chance that each of the following events will occur.
 - a Nat will walk to work today, given that she walked to work five times in the last 75 working days.
 - b Mike will win the next game of cards, given that of the last 80 games he has won 32.
 - c Brett will hit the bullseye on the dartboard with his next attempt, given that of the last 120 attempts he hit the bullseye 22 times.

PROBLEM-SOLVING

4, 5

4–6

5–7

- 4 The colour of cars along a highway was noted over a short period of time and summarised in this frequency table.

Colour	White	Silver	Blue	Green
Frequency	7	4	5	4

- a How many cars had their colour recorded?
 - b Find the experimental probability that a car's colour is:
 - i blue
 - ii white.
 - c If the colour of 100 cars was recorded, what would be the expected number of:
 - i blue cars?
 - ii green cars?
 - iii blue or green cars?
- 5 A six-sided die is rolled 120 times. How many times would you expect the following events to occur?
 - a a 6
 - b a 1 or a 2
 - c a number less than 4
 - d a number that is at least 5



- 6 The letters from a three-letter word are written separately onto cards. A card is chosen at random and replaced and this is repeated 100 times. The results are shown in the table.

Letter	E	S
Frequency	64	36

- a Find the experimental probability of obtaining an E.
 b Based on these results what is the three-letter word likely to be?
- 7 A spinner is divided into three regions not necessarily of equal size. The regions are numbered 1, 2 and 3 and the spinner is spun 50 times. The table shows the results.

Number	1	2	3
Frequency	26	11	13

- a Find the experimental probability of obtaining:
 i a 1 ii at least a 2 iii a 1 or a 3.
 b Based on these results, how many 3s would you expect if the spinner is spun 300 times?
 c In fact, the spinner is divided up using simple and common fractions. Give a likely example describing how the regions might be divided.

REASONING 8–10 8–11 10–12

- 8 The results of throwing a drawing pin and observing how many times the pin lands with the spike pointing up are shown in the table. Results are recorded at different stages of the experiment.

Number of throws	Frequency (spike up)	Experimental probability
1	1	1.00
5	2	0.40
10	5	0.50
20	9	0.45
50	18	0.36
100	41	0.41



Which experimental probability would you choose to best represent the probability that the pin will land spike up? Why?

- 9 Phil rolled a fair six-sided die 10 times and, incredibly, receives 9 sixes.
 a Find the experimental probability of rolling a six.
 b Is it likely that Phil will receive the same number of sixes if he rolled the die 10 more times? Explain.
- 10 Do you think that a coin is fair or biased given the following experimental results? Give reasons.
 a 47 tails out of 100 tosses
 b 23 heads out of 24 tosses
 c 1 tail out of 1 toss

- 11 Decide if the following statements are true.
- The experimental probability is always equal to the theoretical probability.
 - The experimental probability can be greater than the theoretical probability.
 - If the experimental probability is zero then the theoretical probability is zero.
 - If the theoretical probability is zero then the experimental probability is zero.
- 12 One hundred darts are randomly thrown at the given dartboards. No darts miss the dartboard entirely. How many darts do you expect to hit the blue shaded region? Give reasons.

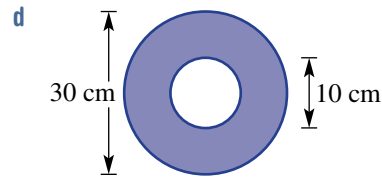
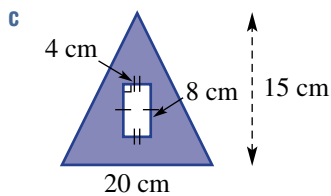
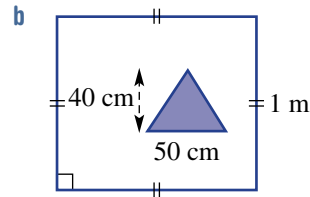
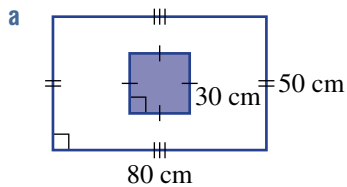

ENRICHMENT: More than a guessing game

-

-

13, 14

- 13 A bag of 10 counters includes counters of four different colours. The results from drawing and replacing one counter at a time for 80 trials are shown in this table. Use the given information to find out how many counters of each colour were likely to be in the bag.
- 14 A box of 12 chocolates of the same size and shape includes five different centres. The results from selecting and replacing one chocolate at a time for 60 trials are shown in this table. Use the given information to find out how many chocolates of each type were likely to be in the box.

Colour	Total
Blue	26
Red	17
Green	29
Yellow	8

Centre	Total
Strawberry	11
Caramel	14
Coconut	9
Nut	19
Mint	7



- 9A 1 List the sample space for:
a rolling a standard die **b** the win/loss result of two matches for a team.

- 9A 2 Find the probability of choosing a vowel when choosing one letter at random from the word MATHEMATICS.

- 9B 3 A survey of 40 sporty people found that 28 liked tennis, 25 liked squash and 13 liked both.
a Construct a Venn diagram for these results.
b How many people liked both tennis and squash?
c If one of the 40 people is chosen at random, what is the probability that they like only one sport?

- 9B 4 Use this two-way table to find the probability that a randomly selected car has both a sunroof and air-conditioning.

	Aircon	No aircon	Total
Sunroof		9	
No sunroof	55	6	61
Total		15	100

- 9C 5 A number is chosen from the set of positive integers between 10 and 20, inclusive. A is the set of even numbers between 10 and 20, inclusive, and B is the set of numbers divisible by 3 between 10 and 20, inclusive.

- a** List these sets.
i the sample space **ii** A
iii B **iv** $A \cap B$
- b** Find:
i $n(A \cap B)$ **ii** $\Pr(A \cap B)$ **iii** $\Pr(A')$.

- 9D 6 Find the probability of:
a obtaining a head and a tail if two coins are tossed
b choosing two vowels from the word MATE if two letters are chosen at random, without replacement
c rolling a double 6 or a double 3 if two standard dice are rolled.

- 9E 7 Two letters are chosen, without replacement, from the letters of the word WAY.
a Use a tree diagram to list all the possible combinations for the selection.
b Find the probability that the selection will contain:
i the letter A **ii** a W or a Y
iii not a Y **iv** a W as the first letter.

- 9F 8 A drawer contains an unknown number of blue, black and white single socks. One sock is chosen at random from the drawer and its colour noted before the sock is returned to the drawer. The outcomes of this experiment are recorded in the table below.

Colour	Blue	Black	White
Frequency	16	44	40

Find the experimental probability of choosing:

- a** a white sock **b** a blue or a white sock.

- 9F 9 If a regular six-sided die is rolled 420 times, how many times would you expect a 1 or a 2 to appear?

9G Data and sampling

LEARNING INTENTIONS

- To know the key words associated with data and sampling and what they mean
- To be able to classify the different types of data
- To know the common types of sampling methods
- To be able to recognise when bias may exist when collecting data

Statistics is an essential part of how science collects, analyses and interprets data. We use data to support ideas and uncover new theories. We also use data using tables and graphs to help display information in an organised and understandable way. Data can also be used to influence decision making and help sell products, which is why it is very important to think about how data is collected, how it is analysed and the conclusions that might be communicated.



We use technology to help collect and analyse large data samples.

Lesson starter: Is there bias?

A data collection company has designed a survey to collect information about people's preferences regarding how they communicate with friends and family. The company is interested in feedback from the entire population of a town. Three employees, Jemma, Karri and Moshi, are asked to survey a range of individuals and report back with their data samples.

- Jemma's method involves messaging all her friends on her contact list.
- Karri surveys people in-person in a busy street at around 3:30 p.m. once school is finished for the day.
- Moshi uses a list of mobile phone numbers which belong to people who have agreed to complete surveys for a small fee.
- Discuss each of the methods employed by Jemma, Karri and Moshi. Do you think any of the survey methods would lead to bias? Give reasons.
- Discuss alternative methods to collect the data that might be less biased.

KEY IDEAS

■ Key words associated with statistics

- **Population** is a complete group with at least one characteristic in common. This group could be people, animals, objects or any event.
- **Sample** is a selection or subset of the population.
- **Survey** is an investigation or tool to collect information about a given sample or population.
 - A survey of the entire population is called a **census**.
- **Bias** is a tendency which causes a difference in the results of a survey and the true facts.

■ Types of data

- **Categorical** (or qualitative) data can be sorted into groups or categories. For example: people's favourite types of animals.
- **Numerical** (or quantitative) data are expressed as numbers. For example: the heights of twenty 15-year-old students.

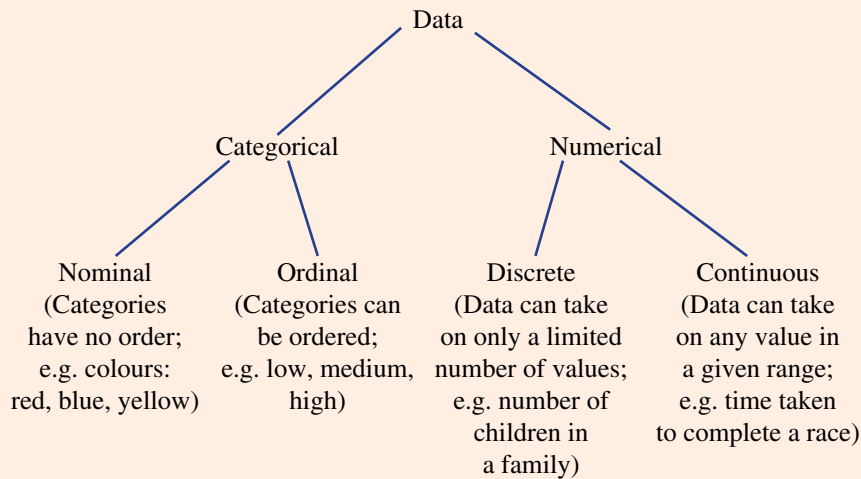

■ Types of sampling methods

- **Simple random sampling:** Each individual in the population has an equal chance of being chosen. For example, each individual is assigned a number and a random number generator selects a number.
- **Systematic sampling:** Individuals are selected at regular intervals. For example, every 20th car is stopped on a highway and the driver is surveyed regarding alcohol consumption.
- **Stratified sampling:** The population is divided into subgroups and individuals are surveyed within that group. For example, a population is surveyed regarding their heart health but are first divided into age groups.

■ Errors may occur in sampling. Examples include:

- Sample size is too small.
- The sample does not represent the entire population.
- Poor or inaccurate measurements are recorded.
- An inappropriate sampling method is chosen.

BUILDING UNDERSTANDING

- 1 Give the key statistical word which matches each definition,
 - a An investigation or tool to collect information about a given sample or population.
 - b A tendency which causes a difference in the results of a survey and the true facts.
 - c A complete group with at least one characteristic in common.
 - d A selection or subset of the population.

- 2 Give the name of the type of data matching the description.
 - a Data that can be sorted into groups or categories.
 - b Data which can be expressed as numbers.

- 3 Give the name of the type of sampling method matching the description.
 - a The population is divided into subgroups and individuals are surveyed within that group.
 - b Each individual in the population has an equal chance of being chosen.
 - c Individuals are selected at regular intervals.

**Example 11 Classifying data**

Classify the data obtained from the following survey as either numerical discrete, numerical continuous, categorical ordinal or categorical nominal.

- a The mass of each shell in a collection of sea shells
- b The results of a survey asking people to rate a TV program as good, satisfactory or poor
- c The colours of the next 10 cars that pass on a busy road
- d The number of computers in a household

SOLUTION

- a Numerical continuous

- b Categorical ordinal

- c Categorical nominal

- d Numerical discrete

EXPLANATION

The data includes numbers which could take on any number within a given range. The recordings may depend on the accuracy of the measuring instrument.

The data includes words which are categories and have a clear order.

The data includes colours which are categories with no particular order.

The data includes numbers from a limited range of values, in this case, the natural numbers 1, 2, 3, ...

Now you try

Classify the data obtained from the following survey as either numerical discrete, numerical continuous, categorical ordinal or categorical nominal.

- a The number of students in all the academic classes in a school
- b The type of caterpillar found in a number of vegetable garden beds
- c The time taken to complete a task
- d The type of safety vest used with one of three sizes available including large, medium or small

**Example 12 Choosing a sampling method**

- a Identify the sampling method used in each of these surveys.
 - i A car factory assembly line chooses every fifth car to check the quality of paint.
 - ii One hundred email addresses are randomly selected from a list of all email addresses in a workplace.
 - iii Fifty dogs are first grouped into breed type then tested for fleas.
- b Eighty people on the street at 7 p.m. are surveyed about how often they go out for dinner. This data is then used to make conclusions about the population of that suburb and how often they go out to dinner. Do you think the sample will contain bias? If so, explain why.

SOLUTION

a i Systematic

ii Simple random

iii Stratified

b Yes, it is perhaps more likely that the people surveyed tend to go out for dinner more often.

EXPLANATION

Individual cars are selected at regular intervals.

Each individual in the workplace has an equal chance of being chosen.

The dogs are divided into subgroups (breeds) and then dogs are tested for fleas within that breed.

People who are already out in the street at 7 p.m. are perhaps more likely to go out to dinner on any night of the week.

Now you try

- a Identify the sampling method used in each of these surveys.
 - i Athletes are divided into sport type then tested for heart fitness.
 - ii Every fifth competition paper ordered by surnames is selected for analysis regarding the working shown.
 - iii Every family in an apartment block is assigned a number and then five random numbers are chosen so that families can be surveyed regarding their thoughts on the standard of the cleaning in the block.
- b Wasram is to seek opinions about what people in the community think of the most recent Soccer World Cup. He surveys his team-mates at the soccer club using a questionnaire. Do you think the sample will contain bias? If so, explain why.

Exercise 9G

FLUENCY

1–5

1, 3–5

3, 5

Example 11

- 1 Classify the following as numerical or categorical data.
- The number of pets in a household
 - The colour of hair on the heads of 13 models
 - The type of mark on a test as either answer, method or consequential
 - The number of litres of drink in 10 bottles



- 2 Classify the data obtained from the following survey as either numerical discrete, numerical continuous, categorical ordinal or categorical nominal.
- The style of jacket on a wall in a shop
 - The level of firmness of a bed described as hard, medium or soft
 - The weight of 25 packets of chips delivered to a shop
 - The shirt size of a range of clothing using the integers 36, 37, 38, ...
- 3 Classify the data obtained from the following survey as either numerical discrete, numerical continuous, categorical ordinal or categorical nominal.
- The type of food purchased at a supermarket
 - The time taken to complete a 100 m sprint
 - The rating of a guides use of the English language with the options: excellent, good, fair and poor
 - The scores out of 20 using whole numbers only for an assignment

Example 12

- 4 a Identify the sampling method used in each of these surveys.
- A random selection of passport numbers are selected from a government list then checked for people who travelled to the United States.
 - People at a hospital are sorted into age groups then tested for their reaction to a particular type of medicine.
 - Every tenth person in the queue at a football match is surveyed regarding their thoughts about who will win the match.
- b A lecturer wants to learn about the opinions of his students and asks them in a lecture to put their hand up and respond verbally to a couple of questions. Do you think the sample will contain bias? If so, explain why.
- 5 a Identify the sampling method used in each of these surveys.
- Every eighth Christmas tree sold at a shop is tested for bugs.
 - A school surveys students about the new uniform and selects a random sample of 20 students from each year level.
 - A random selection of people chosen from the electoral role are surveyed regarding their opinion on how the election was conducted.
- b Matty records information about the bird population on her farm and sits by the lake to wait for the birds to come along before recording the bird type and colour. Do you think the sample will contain bias? If so, explain why.



PROBLEM—SOLVING

6, 7

6–9

7–9

6 In a survey involving stratified sampling, 10 people are to be selected from a company including 30 people working in the sales department and 70 people working in administration department. How many people should be selected from each department?

7 The following statistics were collected about Wally's pet cat.

- Length: 81.45 cm
- Weight: 14.72 kg
- Favourite food: Dine
- Number of toys: 8
- Type of scratching post: short, standard and tall

Describe the type of data for each of the five characteristics.



8 What advice would you give to the following people who are trying to generate unbiased data?

- a Hudson wants to form a view as to the difficulty of a test and talks to his five closest friends.
- b Molly, a vet, wants to review the time that it takes to serve customers and looks at the data for her most experienced vet in the practice.
- c Prabhdeep is researching the cost of bread in a town and records the cost of all the types of bread in a supermarket.
- d Zach wants to assess the amount of study students put into their mathematics. He surveys students exiting the Extension maths exam for the Accelerated students.

9 A school has 50 junior school staff and 70 senior school staff. Of the staff, 24 are to be selected to gauge staff opinions regarding the sport program. How many staff from the junior school should they select?

REASONING

10

10, 11

11, 12

10 Shoe sizes are usually recorded with only whole numbers and sometimes halves. Describe the type of data produced after surveying people's shoe size.

11 Explain why stratified sampling might be used to explore people's resting heart rates.

12 A special type of sampling is called voluntary response sampling. This involves members of the population who have volunteered to participate in a research study. Explain why such a method could lead to bias.

ENRICHMENT: The Challenger disaster

–

–

13

13 In 1985 the Challenger space shuttle disintegrated soon after launch and killed all seven crew members. The cause of the disaster was an O-ring which failed and allowed pressurised gasses to escape and cause a chain reaction.

Statistics had been collected and analysed before the launch which collected data regarding the variables *temperature* and *the number of times the O-ring had failed*. The conclusion was that there was no correlation between the two variables. Unfortunately, they did not look at the data collected from when the O-rings had not failed and after including this data there proved to be a more significant correlation between the variables and if discovered earlier, may have stopped the launch.

Use the internet to research a different statistical error which led to a disaster or embarrassing mistake made by a company or researcher. Comment on the following:

- a The statistical error made
- b The consequences of the error
- c Suggestions regarding what could have been done to avoid the error.

9H Mean, median and mode

LEARNING INTENTIONS

- To know the meaning of the terms mean, median, mode and outlier
- To be able to find the mean, median and mode of a data set

The discipline of statistics involves collecting and summarising data. It also involves drawing conclusions and making predictions, which is why many of the decisions we make today are based on statistical analysis. The type and amount of product stocked on supermarket shelves, for example, is determined by the sales statistics and other measures such as average cost and price range.

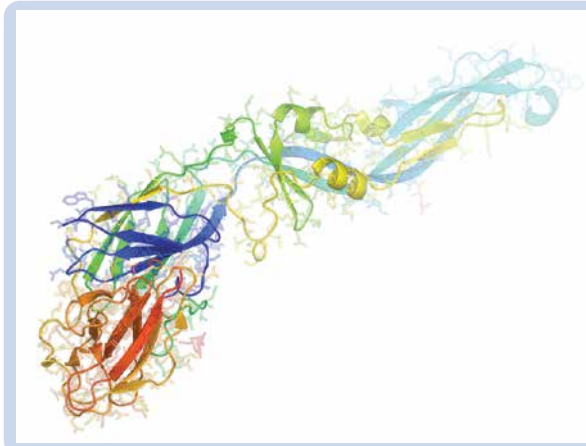

The Dengue fever virus (pictured) infects an average of 390 million people per year. Control of viral diseases improves when the molecular structures are known. Bioinformatics combines statistics, biology and information technology and analyses molecular biological data.

Lesson starter: Game purchase

Arathi purchases 7 computer games at a sale: 3 games cost \$20 each, 2 games cost \$30, 1 game costs \$50 and the last game costs \$200.

- Recall and discuss the meaning of the words mean, median and mode.
- Can you work out the mean, median or mode for the cost of Arathi's games?
- Which of the mean, median or mode gives the best 'average' for the cost of Arathi's games?
- Why is the mean greater than the median in this case?



KEY IDEAS

- The **mean** and **median** are called **measures of centre** because they give some idea of the 'average' or middle of the data set. They are also called **measures of location** or **measures of central tendency**.

- **Mean** (\bar{x})

The mean is sometimes called the **arithmetic mean** or the **average**.

- If there are n values, $x_1, x_2, x_3, \dots, x_n$, then the mean is calculated as follows:

$$\begin{aligned}\bar{x} &= \frac{\text{sum of all data values}}{\text{number of data values}} \\ &= \frac{x_1 + x_2 + x_3 + \dots + x_n}{n}\end{aligned}$$

- **Median**

The median is the middle value if the data values are placed in order.

- If there are two middle values, the median is calculated as the mean of these two values.

Odd number of values

1 3 5 5 6 7 10
 median

Even number of values

13 17 17 20 21 27 27 28
 median

- **Mode**

The mode is the most common or frequently occurring data value.

- There can be more than one mode.
- If there are two modes, we say that the data set is **bi-modal**.
- If each data value occurs just once, there is no mode.

- An **outlier** is a data value that is much larger or smaller than the rest of the data.

- The inclusion of an outlier in a data set can inflate or deflate the mean and give a false impression of the 'average'. In such situations the median is a better measure of centre.

BUILDING UNDERSTANDING

- 1 State the missing word.
 - a The mode is the most _____ value.
 - b The median is the _____ value.
 - c To calculate the _____, you add up all the values and divide by the number of values.
- 2 State the mean, median and mode for these simple ordered data sets.
 - a 1 2 2 2 4 4 6
 - b 7 11 14 18 20 20

**Example 13 Finding measures of centre**

For the given data sets, find the following:

- i the mean ii the median iii the mode.
- a** 5 2 4 10 6 1 2 9 6
- b** 17 13 26 15 9 10

SOLUTION

a i Mean = $\frac{5 + 2 + 4 + 10 + 6 + 1 + 2 + 9 + 6}{9}$
= 5

ii 1 2 2 4 5 6 6 9 10
Median = 5

iii Mode = 2 and 6

b i Mean = $\frac{17 + 13 + 26 + 15 + 9 + 10}{6}$
= 15

ii 9 10 13 15 17 26

14
 Median = $\frac{13 + 15}{2}$
= 14

iii No mode

EXPLANATION

Find the sum of all the numbers and divide by the number of values.

First, order the data.
The median is the middle value.

The data set is bi-modal as there are two numbers with the highest frequency.

The sum is 90 and there are 6 values.

First, order the data.

Since there are two values in the middle find the mean of them.

None of the values are repeated so there is no mode.

Now you try

For the given data sets, find the following:

- i the mean ii the median iii the mode.
- a** 4 8 10 2 3 6 2
- b** 12 15 21 24 18 16 17 13



Example 14 Finding a data value for a required mean

The hours a shop assistant spends cleaning the store in eight successive weeks are:

8, 9, 12, 10, 10, 8, 5, 10.

- Calculate the mean for this set of data.
- How many hours would the shop assistant need to clean in the ninth week for the mean to equal 10?

SOLUTION

$$\begin{aligned} \text{a Mean} &= \frac{8 + 9 + 12 + 10 + 10 + 8 + 5 + 10}{8} \\ &= 9 \end{aligned}$$

- Let a be the number of hours in the ninth week.

$$\text{Require } \frac{72 + a}{8 + 1} = 10$$

$$\frac{72 + a}{9} = 10$$

$$72 + a = 90$$

$$a = 18$$

The number of hours would need to be 18.

EXPLANATION

Sum of the 8 data values is 72.

$72 + a$ is the total of the new data and $8 + 1$ is the new total number of data values. Set this equal to the required mean of 10.

Solve for a .

Write the answer.

Now you try

The amount of money a teenager earned in her last six babysitting appointments is:

\$15, \$25, \$35, \$18, \$20, \$25.

- Calculate the mean for this set of data.
- How much would the teenager need to earn on the next babysitting appointment for the mean to equal \$25?

Exercise 9H

FLUENCY

1, 2, $3\frac{1}{2}$, 4

$1-3\frac{1}{2}$, 4

$1-3\frac{1}{2}$, 4

Example 13

- For the given data sets, find:

i the mean

ii the median

iii the mode.

a 6 13 5 4 16 10 3 5 10

b 10 17 5 16 4 14

c 3.5 2.1 4.0 8.3 2.1

d 0.7 3 2.9 10.4 6 7.2 1.3 8.5

e 6 0 -3 8 2 -3 9 5

f 3 -7 2 3 -2 -3 4

- Decide if the following data sets are bi-modal.

a 2 7 9 5 6 2 8 7 4

b 1 6 2 3 3 1 5 4 1 9

c 10 15 12 11 18 13 9 16 17

d 23 25 26 23 19 24 28 26 27

- These data sets include an outlier (an extreme value compared to the rest of the data). State the outlier, then calculate the mean and the median. Include the outlier in your calculations.

a 5 7 7 8 12 33

b 1.3 1.1 1.0 1.7 1.5 1.6 -1.1 1.5

c -58 -60 -59 -4 -64

d -7.5 -2.4 -5.6 -1.2 10

- 4 In three races Paula recorded the times 25.1 seconds, 24.8 seconds and 24.1 seconds.
- What is the mean time of the races? Round to two decimal places.
 - Find the median time.

PROBLEM–SOLVING

5, 6

5, 6, 8($\frac{1}{2}$)

5, 7, 8

Example 14

- 5 A netball player scored the following number of goals in her 10 most recent games:
15 14 16 14 15 12 16 17 16 15
- What is her mean score?
 - What number of goals does she need to score in the next game for the mean of her scores to be 16?
- 6 Stevie obtained the following scores on her first five Mathematics tests:
92 89 94 82 93
- What is her mean test score?
 - If there is one more test left to complete, and she wants to achieve an average of at least 85, what is the lowest score Stevie can obtain for her final test?
- 7 Seven numbers have a mean of 8. Six of the numbers are 9, 7, 6, 4, 11 and 10. Find the seventh number.
- 8 Write down a set of 5 numbers which has the following values:
- | | |
|--|--|
| a a mean of 5, median of 6 and mode of 7 | b a mean of 5, median of 4 and mode of 8 |
| c a mean of 4, median of 4 and mode of 4 | d a mean of 4.5, median of 3 and mode of 2.5 |
| e a mean of 1, median of 0 and mode of 5 | f a mean of 1, median of $1\frac{1}{4}$ and mode of $1\frac{1}{4}$. |

REASONING

9, 10

9–11

10–12



- 9 The prices of six houses in Darwin are listed.
\$324 000 \$289 000 \$431 000 \$295 000 \$385 000 \$1 700 000
- What is the median house price?
 - The data set includes an outlier. Which price would be considered the outlier?
 - If the outlier was removed from the data set, by how much would the median change?
 - Find the mean house price to the nearest dollar.
 - If the outlier was removed from the data set, by how much would the mean change, to the nearest dollar?



10 Explain why outliers significantly affect the mean but not the median.

11 This dot plot shows the frequency of households with 0, 1, 2 or 3 pets.

- a How many households were surveyed?
- b Find the mean number of pets.
- c Find the median number of pets.
- d Find the mode.
- e Another household with 7 pets is added to the list. Does this change the median? Explain.

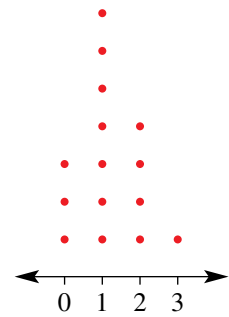

12 This simple data set contains nine numbers: 1 2 2 2 2 3 4 5

- a Find the median.
- b How many numbers greater than 5 need to be added to the list to change the median? (Give the least number.)
- c How many numbers less than 1 need to be added to the list to change the median? (Give the least number.)

ENRICHMENT: Formula to get an A — — 13

13 A school awards grades in Mathematics each semester according to this table.

Ryan has scored the following results for four topics this semester and has one topic to go: 75 68 85 79

- a What is Ryan’s mean score so far?
- b What grade will Ryan get for the semester if his fifth score is:
 - i 50? ii 68? iii 94?
- c Find the maximum average score Ryan can receive for the semester. Is it possible for him to get an A⁺?
- d Find the least score that Ryan needs in his fifth topic for him to receive an average of:
 - i B⁺ ii A.
- e Write a rule for the mean score M for the semester if Ryan receives a mark of m in the fifth topic.
- f Write a rule for the mark m in the fifth topic if Ryan scores an average of M for the semester.

Average score	Grade
90–100	A ⁺
80–	A
70–	B ⁺
60–	B
50–	C ⁺
0–	C



Using a CAS calculator 9H: Finding measures of centre
 The activity is in the Interactive Textbook in the form of a printable PDF.

9 | Stem-and-leaf plots

LEARNING INTENTIONS

- To know how a stem-and-leaf plot is used to display values in a data set
- To be able to display data in a stem-and-leaf plot and use it to find summary statistics and describe the data set
- To be able to construct and use back-to-back stem-and-leaf plots to compare data sets

Stem-and-leaf plots (or stem plots) are commonly used to display a single data set or two related data sets. They help to show how the data is distributed, as in a histogram, but retain all the individual data elements so no detail is lost. The median and mode can be easily read from a stem-and-leaf plot because all the data values sit in order.



Japanese train timetables use a stem-and-leaf plot to display departure times. The 'stems' are hours, and each 'leaf' represents a train's departure time in minutes past the hour.

Lesson starter: Ships vs Chops

At a school, Ms Ships' class and Mr Chops' class sit the same exam. The scores are displayed using this back-to-back stem-and-leaf plot. Discuss the questions that follow.

Ms Ships' class		Mr Chops' class
3 1	5	0 1 1 3 5 7
8 8 7 5	6	2 3 5 5 7 9 9
6 4 4 2 1	7	8 9 9
7 4 3	8	0 3
6	9	1

7 | 8 means 78

- Which class had the greater number of students?
- What were the lowest and highest scores for each class?
- What were the median scores for each class?
- The results of which class could be described as symmetrical and which as skewed?
- Which class had the better results?

KEY IDEAS

- Stem-and-leaf plots are graphs used to display data involving a varying number of digits such as ages or test results.
- A **stem-and-leaf plot** uses a stem number and a leaf number to represent data.
 - The data is shown in two parts: a stem and a leaf.
 - The 'key' tells you how the plot is to be read.

- The graph is similar to a histogram on its side or a bar graph with class intervals, but there is no loss of detail of the original data.

Ordered stem-and-leaf plot

Stem	Leaf
1	2 6
2	2 3 4 7
3	1 2 4 7 8 9
4	2 3 4 5 8
5	7 9

2 | 4 represents 24 people

A key is added to show the place value of the stems and leaves.

- Back-to-back stem-and-leaf plots** can be used to compare two sets of data. The stem is drawn in the middle with the leaves on either side.

Scores for the last 30 AFL games

	Winning scores		Losing scores	
		7	4 5 8 8 9	} Positively Skewed
81 lowest winning score	1	8	0 0 3 3 6 7	
	9 7 5	9	1 2 3 6	
Symmetrical	8 4 4 1	10	3 9	
	9 5 0	11	1	
	1	12		111 highest losing score

10 | 9 represents 109

- A **cluster** is a set of data values that are similar to each other. They form the peak of the distribution. In the data sets above, the losing scores are clustered around the high 70s and low 80s.
- Symmetrical data** will produce a graph that is evenly distributed above and below the central cluster.
- Skewed data** will produce a graph which includes data bunched to one side of the centre.
 - Positively skewed data is bunched left of the centre
 - Negatively skewed data is bunched right of the centre.

BUILDING UNDERSTANDING

- This stem-and-leaf plot shows the length of time, in minutes, Alexis spoke on her phone for a number of calls.
 - How many calls are represented by the stem-and-leaf plot?
 - What is the length of the:
 - shortest phone call?
 - longest phone call?
 - What is the mode (the most common call time)?

Stem	Leaf
0	8
1	5 9
2	1 1 3 7
3	4 5

2 | 1 means 21 minutes

- 2 This back-to-back stem-and-leaf plot shows the thickness of tyre tread on a selection of cars from the city and the country.

- a How many car tyres were tested altogether?
 b Is the distribution of tread thickness for city cars more symmetrical or skewed?
 c Is the distribution of tread thickness for country cars more symmetrical or skewed?

City		Country
8 7 3 1 0 0 0	0	6 8 8 9
8 6 3 1 1 0	1	4 5 5 6 9
	1 2	3 4 4
1 3 means 13 mm		



Example 15 Constructing and using a stem-and-leaf plot

Consider this set of data.

0.3 2.5 4.1 3.7 2.0 3.3 4.8 3.3 4.6 0.1 4.1 7.5 1.4 2.4
 5.7 2.3 3.4 3.0 2.3 4.1 6.3 1.0 5.8 4.4 0.1 6.8 5.2 1.0

- a Organise the data into an ordered stem-and-leaf plot.
 b Find the median.
 c Find the mode.
 d Describe the data as symmetrical or skewed.

SOLUTION

a

Stem	Leaf
0	1 1 3
1	0 0 4
2	0 3 3 4 5
3	0 3 3 4 7
4	1 1 1 4 6 8
5	2 7 8
6	3 8
7	5

3 | 4 means 3.4

- b Median = $\frac{3.3 + 3.4}{2}$
 $= 3.35$
- c Mode is 4.1.
- d Data is approximately symmetrical.

EXPLANATION

The minimum is 0.1 and the maximum is 7.5 so stems range from 0 to 7.

Place leaves in order from smallest to largest. As some numbers appear more than once, e.g. 0.1, their leaf (1) appears the same number of times.

There are 28 data values. The median is the average of the two middle values (the 14th and 15th values).

The most common value is 4.1.

The distribution of numbers is approximately symmetrical about the stem containing the median.

Now you try

Consider this set of data.

1.4 2.0 6.4 0.2 3.5 2.3 4.7 3.1 5.6 4.8
5.1 0.3 4.3 3.4 1.4 2.5 3.8 4.4 3.9 5.7

- Organise the data into an ordered stem-and-leaf plot.
- Find the median.
- Find the mode.
- Describe the data as symmetrical or skewed.

**Example 16 Constructing back-to-back stem-and-leaf plots**

A shop owner has two jeans shops. The daily sales in each shop over a 16-day period are monitored and recorded as follows.

Shop A: 3 12 12 13 14 14 15 15 21 22 24 24 24 26 27 28

Shop B: 4 6 6 7 7 8 9 9 10 12 13 14 14 16 17 27

- Draw a back-to-back stem-and-leaf plot with an interval of 10.
- Compare and comment on differences between the sales made by the two shops.

SOLUTION

	Shop A		Shop B
a	3	0	4 6 6 7 7 8 9 9
	5 5 4 4 3 2 2	1	0 2 3 4 4 6 7
	8 7 6 4 4 4 2 1	2	7

1 | 3 means 13 sales

- Shop A has the highest number of daily sales. Its sales are generally between 12 and 28, with one day of very low sales of 3.
Shop B sales are generally between 4 and 17 with only one high sale day of 27.

EXPLANATION

The data for each shop is already ordered. Stems are in intervals of 10. Record leaf digits for Shop A on the left and Shop B on the right.

Look at both sides of the plot for the similarities and differences.

Now you try

Two basketball teams scored the following points in their 10-game season:

Taipans: 71 62 75 88 73 67 64 72 68 78

JackJumpers: 87 76 82 94 88 75 81 76 97 89

- Draw a back to back stem-and-leaf plot with an interval of 10.
- Compare and comment on differences between the scores of the two teams.

Exercise 9I

FLUENCY

1($\frac{1}{2}$), 2–41($\frac{1}{2}$), 2–41($\frac{1}{2}$), 3–5

Example 15

- 1 For each of the following data sets:
- i organise the data into an ordered stem-and-leaf plot
 - ii find the median
 - iii find the mode
 - iv describe the data as symmetrical or positively or negatively skewed.
- a 2.3 4.5 6.2 2.4 4.1 3.8 3.2 2.3 5.5 5.9 1.8 3.6 4.8 3.7
- b 41 33 28 24 19 32 54 35 26 28 19 23 32 26 28
- c 31 33 23 35 15 23 48 50 35 42 15 21
51 31 34 23 42 50 26 30 45 37 39 45 45
- d 34.5 34.9 33.7 34.5 35.8 33.8 34.3 35.2 37.0 34.7
35.2 34.4 35.5 36.5 36.1 33.3 35.4 32.0 36.3 34.8
- e 167 159 159 193 161 164 167 157 158 175 177 185
177 202 185 187 159 189 167 159 173 198 200

- 2 The number of vacant rooms in a motel each week over a 20-week period is shown below.

12 8 11 10 21 12 6 11 12 16 14 22 5 15 20 6 17 8 14 9

- a Draw a stem-and-leaf plot of this data.
- b In how many weeks were there fewer than 12 vacant rooms?
- c Find the median number of vacant rooms.



Example 16

- 3 For each of the following sets of data:
- i draw a back-to-back stem-and-leaf plot.
 - ii compare and comment on the difference between the two data sets.
- a **Set A:** 46 32 40 43 45 47 53 54 40 54 33 48 39 43
Set B: 48 49 31 40 43 47 48 41 49 51 44 46 53 44
- b **Set A:** 0.7 0.8 1.4 8.8 9.1 2.6 3.2 0.3 1.7 1.9 2.5 4.1 4.3 3.3 3.4
3.6 3.9 3.9 4.7 1.6 0.4 5.3 5.7 2.1 2.3 1.9 5.2 6.1 6.2 8.3
Set B: 0.1 0.9 0.6 1.3 0.9 0.1 0.3 2.5 0.6 3.4 4.8 5.2 8.8 4.7 5.3
2.6 1.5 1.8 3.9 1.9 0.1 0.2 1.2 3.3 2.1 4.3 5.7 6.1 6.2 8.3

- 4 a Draw back-to-back stem-and-leaf plots for the final scores of St Kilda and Collingwood in the 24 games given here.

St Kilda:126 68 78 90 87 118 88 125 111 117 82 82
80 66 84 138 109 113 122 80 94 83 106 68**Collingwood:**104 80 127 88 103 95 78 118 89 82 103 115
98 77 119 91 71 70 63 89 103 97 72 68

- b In what percentage of games did each team score more than 100 points?
- c Comment on the distribution of the scores for each team.



- 5 The data below gives the maximum temperature each day for a three-week period in spring.

18 18 15 17 19 17 21
 20 15 17 15 18 19 19
 20 22 19 17 19 15 17

Use a stem-and-leaf plot to determine:

- a the number of days on which the temperature was higher than 18°C
- b the median temperature
- c the difference between the minimum and maximum temperatures.



PROBLEM-SOLVING 6 6 6, 7

- 6 This stem-and-leaf plot shows the time taken, in seconds, by Helena to run 100 m in her last 25 races.

Stem	Leaf
14	9
15	4 5 6 6 7 7 7 8 9
16	0 0 1 1 2 2 3 4 4 5 5 7 7
17	2

14 | 9 represents 14.9 seconds

- a Find Helena’s median time.
- b What is the difference between the slowest and fastest times?
- c In her 26th race her time was 14.8 seconds. If this was added to the stem-and-leaf plot, would her median time change? If so, by how much?

- 7 Two brands of batteries were tested to determine their lifetimes in hours. The data below shows the lifetimes of 20 batteries of each brand.

Brand A: 7.3 8.2 8.4 8.5 8.7 8.8 8.9 9.0 9.1 9.2
 9.3 9.4 9.4 9.5 9.5 9.6 9.7 9.8 9.9 9.9
Brand B: 7.2 7.3 7.4 7.5 7.6 7.8 7.9 7.9 8.0 8.1
 8.3 9.0 9.1 9.2 9.3 9.4 9.5 9.6 9.8 9.8

- a Draw a back-to-back stem-and-leaf plot for this data.
- b How many batteries of each brand lasted more than 9 hours?
- c Compare the two sets of data and comment on any similarities or differences.

REASONING 8, 9 8–10 8, 10, 11

- 8 This ordered stem-and-leaf plot has some unknown digits.

Stem	Leaf
0	2 3 8
1	1 5 <i>a</i> 8
<i>c</i>	0 <i>b</i> 6 6 2
3	2 5 9

3 | 5 means 0.35

- a What is the value of *c*?
- b What is the smallest number in the data set?
- c What values could the following pronumerals take?

i *a* ii *b*

- 9 The back-to-back stem-and-leaf plot below shows the birth weight in kilograms of babies born to mothers who do or don't smoke.

Birth weight of babies

Smoking mothers		Non-smoking mothers
4 3 2 2	2	4
9 9 8 7 6 6 5 5	2*	8 9
4 3 2 1 1 1 0 0 0	3	0 0 1 2 2 3
6 5 5	3*	5 5 5 6 6 7 7 8
1	4	
	4*	5 5 6



2 | 4 means 2.4 kg

2* | 5 means 2.5 kg

- a What percentage of babies born to smoking mothers have a birth weight of less than 3 kg?
- b What percentage of babies born to non-smoking mothers have a birth weight of less than 3 kg?
- c Compare and comment on the differences between the birth weights of babies born to mothers who smoke and those born to mothers who don't smoke.
- 10 Explain why in a symmetrical distribution the mean is close to the median.
- 11 Find the median if all the data in each back-to-back stem-and-leaf plot was combined.

a

5	3	8 9
9 7 7 1	4	0 2 2 3 6 8
8 6 5 2 2	5	3 3 7 9
7 4 0	6	1 4

4 | 2 means 42

b

3	16	0 3 3 6 7 9
9 6 6 1	17	0 1 1 4 8 8
8 7 5 5 4 0	18	2 2 6 7
2	19	0 1

16 | 3 means 16.3

ENRICHMENT: How skewed?

–

–

12

- 12 As seen skewness can be positive or negative. If the tail of the distribution is pointing up in a stem-and-leaf plot (towards the smaller numbers) then we say the data is negatively skewed.

Stem	Leaf
1	3
2	1 4
3	0 2 7
4	1 1 3 8 9 9
5	0 4 4 5 7

Negatively
skewed data

3 | 2 means 32

If the tail is pointing in the reverse direction then the data is positively skewed.

- a Find the mean (correct to two decimal places) and the median for the above data.
- b Which of the mean or median is higher for the given data? Can you explain why?
- c Which of the mean or median would be higher for a set of positively skewed data? Why?
- d What type of distribution would lead to the median and mean being quite close?

The following problems will investigate practical situations drawing upon knowledge and skills developed throughout the chapter. In attempting to solve these problems, aim to identify the key information, use diagrams, formulate ideas, apply strategies, make calculations and check and communicate your solutions.

Medical trials

- 1 A team of medical researchers is involved in two trials. One trial will record the effect of a new drug on a group of patients with a certain condition and the second trial involves testing for a particular condition in its early stages.

The researchers need to be able to approach pharmaceutical companies to fund their drug trials and testing. To do so they need to be able to show some evidence of the impact of each of trial to show that it is worth pursuing.

- a For the first phase of the trial, 60 patients with the condition were involved in a drug trial. Half were given the new drug and half were given a placebo. The result recorded indicated whether or not a patient was still showing symptoms after one week.

After one week it was found that 32 patients showed no symptoms, with 10 of those on the placebo.

- i Use this Venn diagram to summarise the results. D represents the set of patients taking the drug and N represents the set of patients with no symptoms after a week.

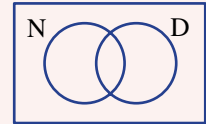

- ii Find the probability that a randomly selected patient took the drug and had no symptoms after one week.
- iii Find the probability that a randomly selected patient did not take the drug and had no symptoms after one week.
- iv Based on your results to parts ii and iii, can you hypothesise whether you think the drug had an impact?
- v If this drug was used to treat all patients who have the condition, based on the data what percentage could be expected to show no symptoms within a week? Round to the nearest per cent.
- vi If you had to promote this drug to a pharmaceutical company or in an advertising campaign, which two statistics would you use based on the data?

The drug was also trialled on a group of patients who did not have the condition and some side effects were noted. The researchers determine that to be prescribed the drug, a test must be used in the early stages to try to determine if a patient's symptoms indicate they have the condition.

The researchers must first consider the accuracy of the test.

- b The test was carried out on a group of 40 patients – some who went on to develop the condition and some who did not. The results of the test were that 29 people tested positive, and of those 27 people had the condition. In total, 30 people had the condition.

- i Summarise these findings in a two-way table where C is the set of patients who did have the condition and T is the set of patients who tested positive to the condition.

	T	T'	Total
C			
C'			
Total			

- ii Based on the results, determine the probability of 'C and T' and the probability of 'C or T' and interpret these sets of patients.
- iii A 'false positive' is a result in which a person tests positive but does not have the condition. From this data, what percentage of tests resulted in a false positive?

- iv Based on this data, in what percentage of patients did the test not detect the condition when it was actually present?
- v The researchers will receive extra funding to refine the test if fewer than 10% of patients get an incorrect result. Will the researchers get the extra funding?

Raising the average

- 2 Statisticians are now commonly connected to both sporting and commentary teams. Statistics are used to compare performances and to analyse opposition players and teams.

For batsmen in cricket, averages are particularly important. In cricket, if you finish an innings 'not out', the runs are added to your total runs but the average is calculated by dividing by the number of 'outs', not innings. For example, for the scores 30, 26 and 10 the average is 22, but for scores of 30, 26 and 10 not out the average is 33.

In a season of cricket in Australia, sports journalists spend time analysing statistics to highlight under-performing players and discuss possible selection issues by looking at scores achieved and averages, and by comparing players.

- a A batsman is under pressure heading into the final Test match. He only gets to bat once in the match and he is keen to raise his average above 30. From the six previous completed innings he has played, he has averaged 26.5. What is the lowest score he can get to achieve this average if:
- i he gets out in the innings?
 - ii he is not out at the end of the innings?
- b Give a possible set of scores the batsman in part a had for his 7 innings if his mode score was 22, his median was 25, he achieved his average of at least 30 and he was out in each innings.

The opening batsman combination is considered not to have worked throughout the series. The team batted 10 times, but one of the batsman was injured in one game and only batted in 9 innings. Both openers were out each time they batted. Their scores are shown below.

Opener 1: 18 6 21 18 31 42 23 25 31

Opener 2: 4 4 11 24 107 52 13 27 8 6

- c
- i Display the data using a back-to-back stem-and-leaf plot and compare/comment on their performances.
 - ii The commentators are calling for opener 1 to be left out of the team. Do you think this is reasonable? What statistic might they be basing this on?
 - iii The data for opener 1 was incorrectly entered. The score of 21 is incorrect. Once the new score is entered, the median changes to 25 but the range is unchanged. What are the possible scores that opener 1 obtained in this innings?
- d After the next three Test match series, a batsman is dropped from the team. In the two series this batsman had averaged 23 from 8 completed innings in the first series and 18.2 from 5 completed innings in the second series. What was the combined average for the two series, correct to one decimal place?



Winning odds

- 3 A betting agency sets odds on a range of sports around the world. They do so by analysing past performances and then setting the odds – trying to keep them in their favour!

A particular up-and-coming betting agency is analysing the previous head-to-head performances of tennis players, in order to set the odds for the winner of the match, as well as updating the odds throughout a match. They use various simulations to predict the chances of different outcomes.

Two particular players have split the sets they have played against each other in the past 50–50. The match can be simulated with a coin, as each player is equally likely to win a set.

In women's matches, the winner is the first to win two sets.

- a Complete the tree diagram of a coin toss simulating the three possible sets. Player 1 wins the set if heads and player 2 wins if tails.

Use the tree diagram to find:

- the probability that the match is completed in two sets
- the probability the winner of the match lost the first set.

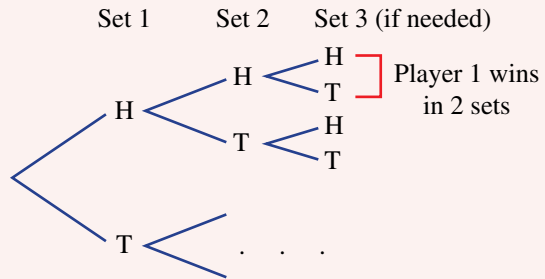

In the next round, the head-to-head battle shows that one player has won two-thirds of the sets she has played against her opponent. This can be simulated with a spinner which has three equal regions, two coloured red and one coloured blue.

The spinner is spun to determine the winner of each set. The third set will not be played if a winner has been determined.

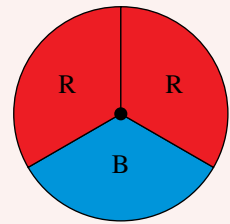

- b Complete a tree diagram to find the probability that:
- the match lasted three sets
 - the non-favourite wins at least one set.
- c At tournaments around the world, the scoring system in the final set and the tiebreaker is being altered. At a particular tournament the women's game is trialling a first to 7 tiebreaker that doesn't require a two-point advantage. Two close rivals are considered equally likely to win a point in a tiebreaker whether they are serving or not. Calculate the percentage chance of each player winning from the following positions:

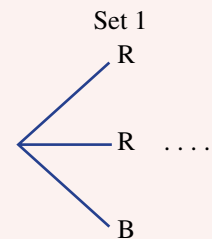

- 6 points to 5 (*Hint*: At most two points will need to be played.)
- 6 points to 4 (*Hint*: Consider how many points might be needed and how to simulate this.)

9J Grouping data into classes

LEARNING INTENTIONS

- To know how to use a frequency table to record data in class intervals
- To be able to calculate the percentage frequency of an interval in a frequency table
- To know the types of data that can be displayed in a histogram
- To be able to display grouped numerical data in a histogram and interpret the graph

For some data, especially large sets, it makes sense to group the data and then record the frequency for each group to produce a frequency table. For numerical data, a graph generated from a frequency table gives a histogram. Like a stem-and-leaf plot, a histogram shows how the data is distributed across the full range of values. A histogram, for example, is used to display the level of exposure of the pixels in an image in digital photography. It uses many narrow columns to show how the luminance values are distributed across the scale from black to white.

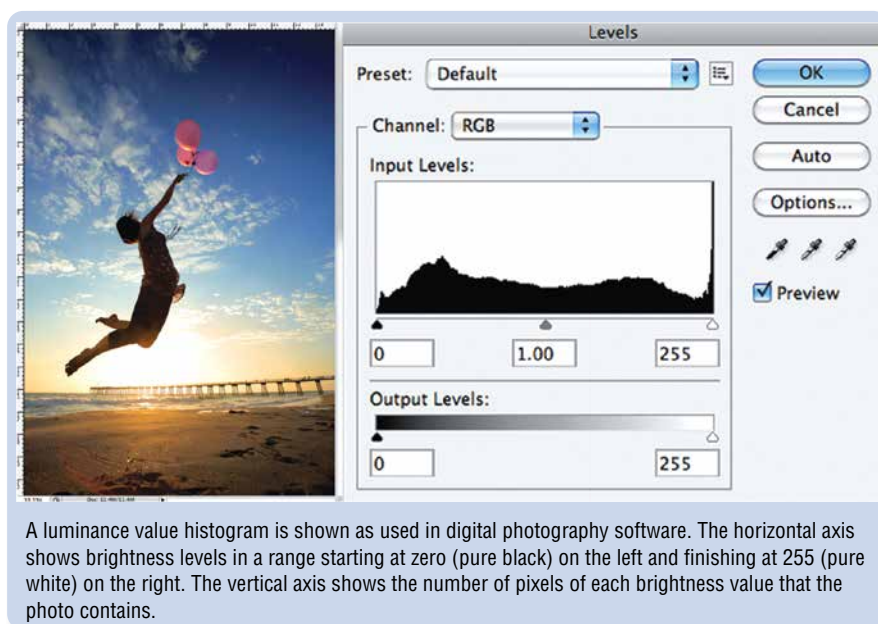

Lesson starter: Baggage check

The histogram shows the distribution of the weight of a number of bags checked at the airport.

- How many bags had a weight in the range 10 to 15 kg?
- How many bags were checked in total?
- Is it possible to determine the exact mean, median or mode of the weight of the bags by looking at the histogram? Discuss.
- Describe the distribution of checked bag weights for the given graph.

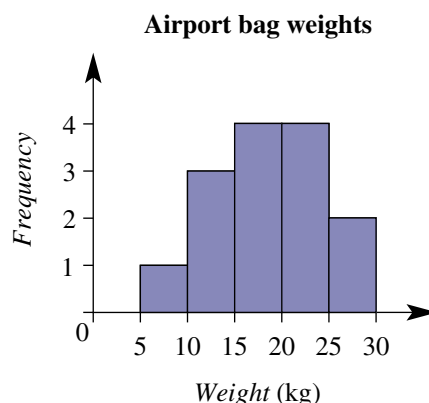

KEY IDEAS

- A **frequency table** shows the number of values within a set of categories or **class intervals**.
- Grouped numerical data can be illustrated using a **histogram**.
 - The height of a column corresponds to the frequency of values in that class interval.
 - There are usually no gaps between columns.
 - The scales are evenly spread with each bar spreading across the boundaries of the class interval.
 - A **percentage frequency histogram** shows the frequencies as percentages of the total.
- Like a stem-and-leaf plot, a histogram can show if the data is **skewed** or **symmetrical**.

Frequency table		
Class interval	Frequency	Percentage frequency
60–	3	12
65–	4	16
70–	6	24
75–	8	32
80–85	4	16
Total	25	100

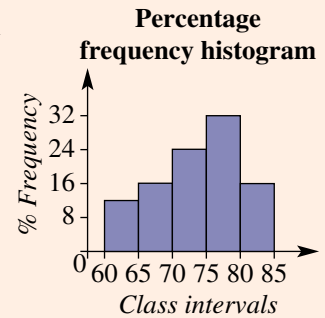
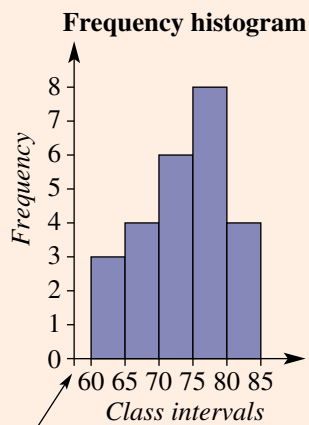

This gap may be used when our intervals do not start at zero.

- In this frequency table, 70– includes numbers from 70 to less than 75.



BUILDING UNDERSTANDING

- 1 State the missing numbers in this frequency table, i.e. find the values of the pronumerals.

Class interval	Frequency	Percentage frequency
0–4	1	10
5–9	3	c
10–14	4	d
a –19	b	e
Total	10	f

- 2 This frequency histogram shows the number of books in which the number of pages is within a given interval for some textbooks selected from a school library.
- How many textbooks had between 100 and 200 pages?
 - How many textbooks were selected from the library?
 - What percentage of textbooks had between:
 - 200 and 300 pages?
 - 200 and 400 pages?

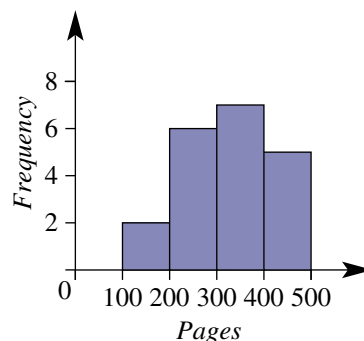

Example 17 Constructing frequency tables and histograms

The data below shows the number of hamburgers sold each hour by a 24-hour fast-food store during a 50-hour period.

1 10 18 14 20 11 19 10 17 21
 5 16 7 15 21 15 10 22 11 18
 12 12 3 12 8 12 6 5 14 14
 14 4 9 15 17 19 6 24 16 17
 14 11 17 18 19 19 19 18 18 20

- Set up and complete a grouped frequency table, using class intervals 0–, 5–, 10–, etc. Include a percentage frequency column.
- Construct a frequency histogram.
- In how many hours did the fast-food store sell:
 - fewer than 10 hamburgers?
 - at least 15 hamburgers?

SOLUTION

a

Class interval	Frequency	Percentage frequency
0–	3	6%
5–	7	14%
10–	15	30%
15–	19	38%
20–25	6	12%
Total	50	100%

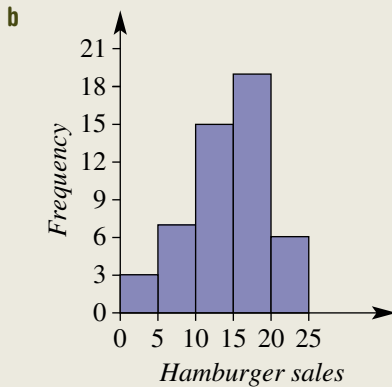

c i $3 + 7 = 10$ hours

ii $19 + 6 = 25$ hours

EXPLANATION

Create class intervals of 5 from 0 up to 25, since 24 is the maximum number. Record the number of data values in each interval in the frequency column. Convert to a percentage by dividing by the total (50) and multiplying by 100.

Create a frequency histogram with frequency on the vertical axis and the class intervals on the horizontal axis. The height of the column shows the frequency of that interval.

Fewer than 10 hamburgers covers the 0–4 and 5–9 intervals.

At least 15 hamburgers covers the 15–19 and 20–24 intervals.

Now you try

The heights of 40 students were measured to the nearest centimetre and recorded.

160 149 153 143 179 159 152 161 169 157
 167 163 148 175 173 150 175 160 170 162
 145 158 163 164 172 178 169 171 153 165
 152 161 170 174 166 165 158 157 152 148

a Set up and complete a grouped frequency table, using class intervals 140–, 145–, 150– etc. Include a percentage frequency column.

b Construct a frequency histogram.

c How many students are:

i shorter than 150 cm?

ii at least 170 cm tall?

Exercise 9J

FLUENCY

1, 2, 4

1, 3, 4

1, 3, 4

Example 17

- 1 The data below shows the number of ice-creams sold from an ice-cream van over a 50-day period.

0	5	0	35	14	15	18	21	21	36
45	2	8	2	2	3	17	3	7	28
35	7	21	3	46	47	1	1	3	9
35	22	7	18	36	3	9	2	2	11
37	37	45	11	12	14	17	22	1	2

- a Set up and complete a grouped frequency table using class intervals 0–, 10–, 20–, etc. Include a percentage frequency column.
- b Construct a frequency histogram.
- c On how many days did the ice-cream van sell:
- i fewer than 20 ice-creams?
 - ii at least 30 ice-creams?



- 2 The data below shows the mark out of 100 on the Science exam for 60 Year 9 students.

50	67	68	89	82	81	50	50	89	52	60	82	52	60	87	89	71	73	75	83
86	50	52	71	80	95	87	87	87	74	60	60	61	63	63	65	82	86	96	88
50	94	87	64	64	72	71	72	88	86	89	69	71	80	89	92	89	89	60	83

- a Set up and complete a grouped frequency table, using class intervals 50–, 60–, 70–, etc. Include a percentage frequency column, rounding to two decimal places where necessary.
- b Construct a frequency histogram.
- c i How many marks were less than 70 out of 100?
ii What percentage of marks were at least 80 out of 100? Answer correct to one decimal place.
- 3 The number of goals kicked by a country footballer in each of his last 30 football matches is given below.
- | | | | | | | | | | | | | | | |
|---|---|----|----|----|----|----|----|---|---|----|----|----|---|----|
| 8 | 9 | 3 | 6 | 12 | 14 | 8 | 3 | 4 | 5 | 2 | 5 | 6 | 4 | 13 |
| 8 | 9 | 12 | 11 | 7 | 12 | 14 | 10 | 9 | 8 | 12 | 10 | 11 | 4 | 5 |
- a Organise the data into a grouped frequency table using a class interval width of 3 starting at 0.
- b Draw a frequency histogram for the data.
- c In how many games did the player kick fewer than six goals?
- d In how many games did he kick more than 11 goals?
- 4 Which one of these histograms illustrates a symmetrical data set and which one shows a skewed data set?

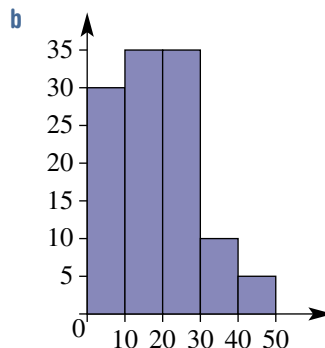
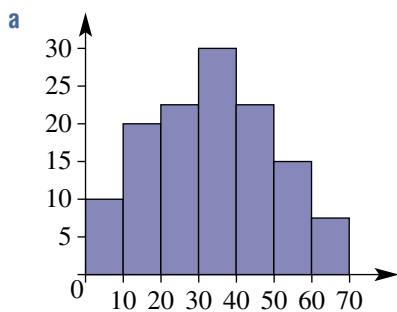

PROBLEM-SOLVING

5, 6

5, 6

5–7

5 Find the unknown numbers (pronumerals) in these frequency tables.

a

Class interval	Frequency	Percentage frequency
10–	a	15
15–	11	b
20–	7	c
25–	d	10
30–34	e	f
Total	40	g

b

Class interval	Frequency	Percentage frequency
0–	a	2
3–	9	b
6–	c	16
9–	12	d
12–14	e	f
Total	50	g

6 This percentage frequency histogram shows the heights of office towers in a city.

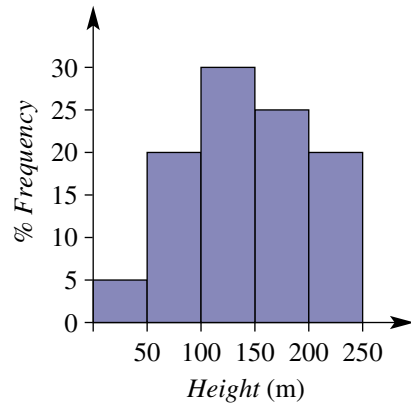

a What percentage of office towers have heights of:

- i between 50 m and 100 m?
- ii less than 150 m?
- iii no more than 200 m?
- iv at least 100 m?
- v between 100 m and 150 m or greater than 200 m?

b If there are 100 office towers in the city, how many have a height of:

- i between 100 m and 150 m?
- ii at least 150 m?

c If the city had 40 office towers, how many have a height of:

- i between 0 m and 50 m?
- ii no more than 150 m?

 7 The data below shows the length of overseas phone calls (in minutes) made by a particular household over a six-week period.

1.5	1	1.5	1.4	8	4	4	10.1	9.5	1	3
8	5.9	6	6.4	7	3.5	3.1	3.6	3	4.2	4.3
4	12.5	10.2	10.3	4.5	4.5	3.4	3.5	3.5	5	3.5
3.6	4.5	4.5	12	11	12	14	14	12	13	10.8
12.1	2.4	3.8	4.2	5.6	10.8	11.2	9.3	9.2	8.7	8.5

What percentage of phone calls were more than 3 minutes in length? Answer to one decimal place.



REASONING

8

8, 9

8, 10

- 8 Explain why you cannot work out the exact value for the mean, median and mode for a set of data presented in a histogram.
- 9 What can you work out from a frequency histogram that you cannot work out from a percentage frequency histogram? Completing Question 6 will provide a clue.
- 10 Two students show different histograms for the same set of data.

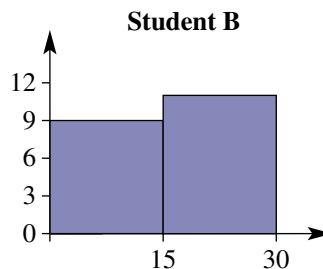
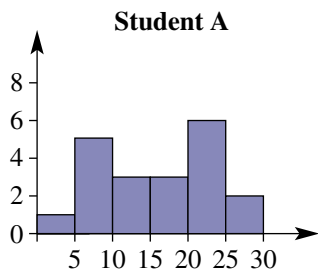

- a Which histogram is more useful in helping to analyse the data?
- b What would you advise student B to do differently when constructing the histogram?

ENRICHMENT: The distribution of weekly wages

-

-

11

- 11 The data below shows the weekly wages of 50 people in dollars.

400 500 552 455 420 424 325 204 860 894 464 379 563
 940 384 370 356 345 380 720 540 654 678 628 656 670
 740 750 730 766 760 700 700 768 608 576 890 920 874
 450 674 725 612 605 600 548 670 230 725 860

- a What is the minimum weekly wage and the maximum weekly wage?
- b i Organise the data into up to 10 class intervals.
 ii Draw a frequency histogram for the data.
- c i Organise the data into up to 5 class intervals.
 ii Draw a frequency histogram for the data.
- d Discuss the shapes of the two graphs. Which graph better represents the data and why?



Using a CAS calculator 9J: Graphing grouped data

The activity is in the Interactive Textbook in the form of a printable PDF.

9K Measures of spread: range and interquartile range

LEARNING INTENTIONS

- To know how the range and interquartile range describe the spread of a data set
- To be able to find the quartiles of a data set with an odd or even number of data values
- To be able to find the range and interquartile range of a set of data

The mean, median and mode are three numbers that help define the centre of a data set; however, it is also important to describe the spread. Two teams of swimmers from different countries, for example, might have similar mean race times but the spread of race times for each team could be very different.



Planning future food supply requires statistics. Weather statisticians analyse rainfall and temperatures, providing measures of centre and spread, and climate trends. Agricultural statisticians analyse land use data, such as these irrigated vineyards near Mildura, Victoria.

Lesson starter: Swim times

Two Olympic swimming teams are competing in the 4×100 m relay. The 100 m personal best times, in seconds, for the four members of each team are given.

Team A: 48.3 48.5 48.9 49.2

Team B: 47.4 48.2 49.0 51.2

- Find the mean time for each team.
- Which team's times are more spread out?
- What does the difference in the range of values for each team tell you about the spread?

KEY IDEAS

- Two measures that help to describe how data is spread are the **range** and **interquartile range**. These are called measures of spread.
- The **range** is the difference between the maximum and minimum values.
 - $\text{Range} = \text{maximum value} - \text{minimum value}$
- If a set of numerical data is placed in order from smallest to largest, then:
 - the middle number of the lower half is called the **lower quartile** (Q_1)
 - the middle number of the data is called the **median** (Q_2)
 - the middle number of the upper half is called the **upper quartile** (Q_3)
 - the difference between the upper quartile and lower quartile is called the **interquartile range** (IQR).

$$\text{IQR} = Q_3 - Q_1$$

- If there is an odd number of values, remove the middle value (the median) before calculating Q_1 and Q_3 .
- An **outlier** is a value that is not in the vicinity of the rest of the data.

BUILDING UNDERSTANDING

- 1 State the missing words.
- To find the range, you subtract the _____ from the _____.
 - To find the interquartile range, you subtract the _____ from the _____.
- 2 This ordered data set shows the number of hours of sleep 11 people had the night before.
3 5 5 6 7 7 7 8 8 8 9
- State the range (the difference between the maximum and minimum values).
 - State the median (Q_2 , the middle number).
 - Remove the middle number then find:
 - the lower quartile (Q_1 , the middle of the lower half)
 - the upper quartile (Q_3 , the middle of the upper half).
 - Find the interquartile range (IQR, the difference between the upper quartile and lower quartile).
- 3 This ordered data set shows the number of fish Daniel caught in the 12 weekends that he went fishing during the year.
1 2 3 3 4 4 4 6 7 7 9 11 13
- Find the range (the difference between the maximum and minimum values).
 - Find the median (Q_2 , the middle number).
 - Split the data in half then find:
 - the lower quartile (Q_1 , the middle of the lower half)
 - the upper quartile (Q_3 , the middle of the upper half).
 - Find the interquartile range (IQR, the difference between the upper quartile and lower quartile).





Example 18 Finding the range and quartiles for an odd number of data values

The following data values are the results for a school Mathematics test.

67 96 62 85 73 56 79 19 76 23 68 89 81

- a** List the data in order from smallest to largest.
b Find the range.
c Find:
- | | |
|---|--|
| i the median (Q_2) | ii the lower quartile (Q_1) |
| iii the upper quartile (Q_3) | iv the interquartile range (IQR). |

SOLUTION

a 19 23 $\underbrace{56}_{Q_1}$ $\underbrace{62}_{Q_2}$ 67 68 $\underbrace{73}_{Q_2}$ 76 79 $\underbrace{81}_{Q_3}$ $\underbrace{85}_{Q_3}$ 89 96

b Range = $96 - 19$
 $= 77$

c i $Q_2 = 73$

ii $Q_1 = \frac{56 + 62}{2}$
 $= 59$

iii $Q_3 = \frac{81 + 85}{2}$
 $= 83$

iv IQR = $83 - 59$
 $= 24$

EXPLANATION

Order the data.

Range = maximum value – minimum value.

The middle number is 73.

Q_1 (the middle value of the lower half) is halfway between 56 and 62. As there is an odd number of values, exclude the number 73 before finding Q_1 and Q_3 .

Q_3 (the middle value of the upper half) is halfway between 81 and 85.

$$\text{IQR} = Q_3 - Q_1$$

Now you try

The following data values are the percentage results for a student's spelling tests over a 9-week term.

83 90 76 81 72 84 92 78 86

- a** List the data in order from smallest to largest.
b Find the range.
c Find:
- | | |
|---|--|
| i the median (Q_2) | ii the lower quartile (Q_1) |
| iii the upper quartile (Q_3) | iv the interquartile range (IQR). |

Example 19 Finding quartiles for an even number of data values

Here is a set of measurements collected by measuring the lengths, in metres, of 10 long-jump attempts.

6.7 9.2 8.3 5.1 7.9 8.4 9.0 8.2 8.8 7.1

- a List the data in order from smallest to largest.
- b Find the range.
- c Find:
 - i the median (Q_2)
 - ii the lower quartile (Q_1)
 - iii the upper quartile (Q_3)
 - iv the interquartile range (IQR).
- d Interpret the IQR.

SOLUTION

a 5.1 6.7 $\boxed{7.1}$ 7.9 $\boxed{8.2}$ $\boxed{8.3}$ 8.4 $\boxed{8.8}$ 9.0 9.2
 Q_1 Q_2 Q_3

b Range = $9.2 - 5.1$
 $= 4.1$ m

c i $Q_2 = \frac{8.2 + 8.3}{2}$
 $= 8.25$ m

ii $Q_1 = 7.1$ m

iii $Q_3 = 8.8$ m

iv IQR = $8.8 - 7.1$
 $= 1.7$ m

d The middle 50% of jumps differed by less than 1.7 m.

EXPLANATION

Order the data to locate Q_1 , Q_2 and Q_3 .

Range = maximum value – minimum value.

Q_2 is halfway between 8.2 and 8.3.

The middle value of the lower half is 7.1.

The middle value of the upper half is 8.8.

IQR is the difference between Q_1 and Q_3 .

The IQR is the range of the middle 50% of the data.

Now you try

The weights, in kg, of 14 parcels lodged at the post office an hour before closing are listed:

1.6 0.8 2.3 2.6 3.1 1.2 1.8 2.0 2.3 3.5 1.7 1.1 0.4 2.8

- a List the data in order from smallest to largest.
- b Find the range.
- c Find:
 - i the median (Q_2)
 - ii the lower quartile (Q_1)
 - iii the upper quartile (Q_3)
 - iv the interquartile range (IQR).
- d Interpret the IQR.

Exercise 9K

FLUENCY

1(1/2), 2, 3

1(1/2), 2, 3

1(1/3), 3

Example 18

- 1 Consider the sets of data given below.
- i List the set of data in order from smallest to largest.
 - ii Find the range.
 - iii Find the median (Q_2).
 - iv Find the lower quartile (Q_1).
 - v Find the upper quartile (Q_3).
 - vi Find the interquartile range (IQR).
- a 5 7 3 6 2 1 9 7 11 9 0 8 5
- b 38 36 21 18 27 41 29 35 37 30 30 21 26
- c 180 316 197 176 346 219 183 253 228
- d 256 163 28 520 854 23 367 64 43 787 12 343 76 3 28
- e 1.8 1.9 1.3 1.2 2.1 1.2 0.9 1.7 0.8
- f 10 35 0.1 2.3 23 12 0.02

Example 19

- 2 The top 10 highest box office takings for films, in millions of dollars, are given:
1405 1519 1672 2049 2187 2788 2068 1342 1516 1347
- a Find the range.
 - b Find:
 - i the median (Q_2)
 - ii the lower quartile (Q_1)
 - iii the upper quartile (Q_3)
 - iv the interquartile range (IQR).
 - c Interpret the IQR.
- 3 The running time, in minutes, of 16 movies at the cinema were as follows:
123 110 98 120 102 132 112 140 120 139 42 96 152 115 119 128
- a Find the range.
 - b Find:
 - i the median (Q_2)
 - ii the lower quartile (Q_1)
 - iii the upper quartile (Q_3)
 - iv the interquartile range (IQR).
 - c Interpret the IQR.

PROBLEM-SOLVING

4, 5

4–6

5, 6

- 4 The following set of data represents the sale price, in thousands of dollars, of 14 vintage cars.
89 46 76 41 12 52 76 97 547 59 67 76 78 30
- a For the 14 vintage cars, find:
 - i the lowest price paid
 - ii the highest price paid
 - iii the median price
 - iv the lower quartile of the data
 - v the upper quartile of the data
 - vi the IQR.
 - b Interpret the IQR for the price of the vintage cars.
 - c If the price of the most expensive vintage car increased, what effect would this have on Q_1 , Q_2 and Q_3 ? What effect would it have on the mean price?

- 5 Find the interquartile range for the data in these stem-and-leaf plots.

a

Stem	Leaf
3	4 8 9
4	1 4 8 8
5	0 3 6 9
6	2 6

5 | 2 means 52

b

Stem	Leaf
17	5 8
18	0 4 6 7
19	1 1 2 9 9
20	4 4 7 8
21	2 6 8

21 | 3 means 21.3

- 6 Over a period of 30 days, Lara records how many fairies she sees in the garden each day. The data is organised into this frequency table.

Number of fairies each day	0	1	2	3	4	5
Frequency	7	4	8	4	6	1

- a** Find the median number of fairies seen in the 30 days.
b Find the interquartile range.
c If Lara changes her mind about the day she saw 5 fairies and now says that she saw 10 fairies, would this change the IQR? Explain.

REASONING

7

7, 8

8, 9

- 7 Two data sets have the same range. Does this mean they have the same lowest and highest values? Explain.
- 8 A car yard has more than 10 cars listed for sale. One expensive car is priced at \$600 000 while the remaining cars are all priced near \$40 000. The salesperson realises that there is an error in the price for the expensive car – there is one too many zeros printed on the price.
- a** Does the change in price for the expensive car change the value of the range? Give reasons.
b Does the change in price for the expensive car change the value of the median? Give reasons.
c Does the change in price for the expensive car change the value of the IQR? Give reasons.
- 9 **a** Is it possible for the range to equal the IQR? If so, give an example.
b Is it possible for the IQR to equal zero? If so, give an example.

ENRICHMENT: How many lollies in the jar?

–

–

10

- 10 The following two sets of data represent the number of jelly beans found in 10 jars purchased from two different confectionery stores, A and B.

Shop A: 25 26 24 24 28 26 27 25 26 28

Shop B: 22 26 21 24 29 19 25 27 31 22

- a** Find Q_1 , Q_2 and Q_3 for:
i shop A **ii** shop B.
- b** The top 25% of the data is above which value for shop A?
c The lowest 25% of the data is below which value for shop B?
d Find the interquartile range (IQR) for the number of jelly beans in the 10 jars from:
i shop A **ii** shop B.
- e** By looking at the given sets of data, why should you expect there to be a significant difference between the IQR of shop A and the IQR of shop B?
f Which shop offers greater consistency in the number of jelly beans in each jar it sells?



9L Box plots EXTENDING

LEARNING INTENTIONS

- To understand how a box plot is used to display key values of a data set
- To be able to read summary statistics from a box plot and interpret quartiles
- To be able to construct a box plot for a data set

A box plot is a commonly used graph for a data set showing the maximum and minimum values, the median and the upper and lower quartiles. Box plots are often used to show how a data set is distributed and how two sets compare. Box plots are used, for example, to compare a school's examination performance against the performance of all schools in a state.



Every business seeks a competitive advantage from the statistical analysis of its data, including marketing, production, sales and profit. Data scientists who have computer algorithm skills in statistics and analytics are in high demand.

Lesson starter: School performance

These two box plots show the performance of two schools on their English exams.

Box High School

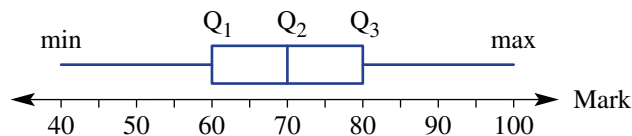

Plot Secondary College

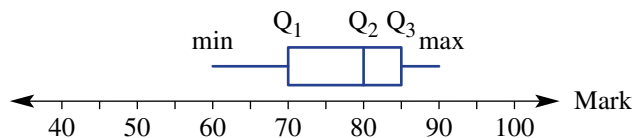

- Which school produced the highest mark?
- Which school produced the highest median (Q_2)?
- Which school produced the highest IQR?
- Which school produced the highest range?
- Describe the performance of Box High School against Plot Secondary College. Which school has better overall results and why?

KEY IDEAS

- A **box plot** (also called a box-and-whisker plot) is a graph which shows:
 - maximum and minimum values
 - median (Q_2)
 - lower and upper quartiles (Q_1 and Q_3).
- A quarter (25%) of the data is spread across each of the four sections of the graph.

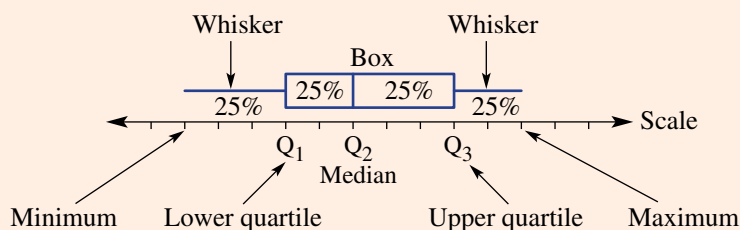

BUILDING UNDERSTANDING

- 1 State the names of the features labelled **a** to **h** on this box plot.

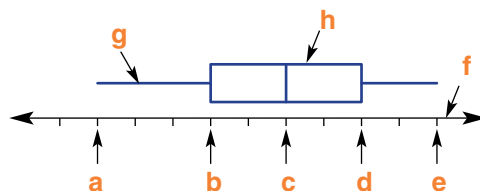

- 2 Choose the correct box plot for a data set which has all these measures:

- minimum = 3
- maximum = 12
- median = 9
- lower quartile = 5
- upper quartile = 11

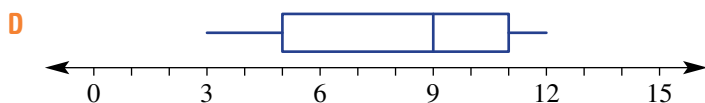
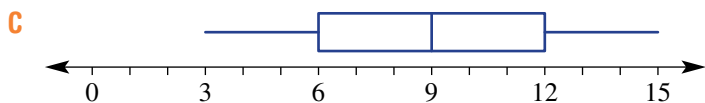
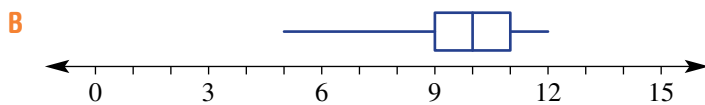
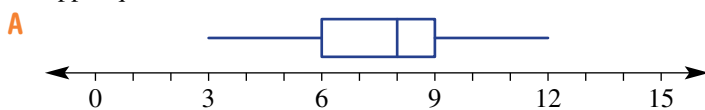



Example 20 Interpreting a box plot

This box plot summarises the price of all the books in a book shop.

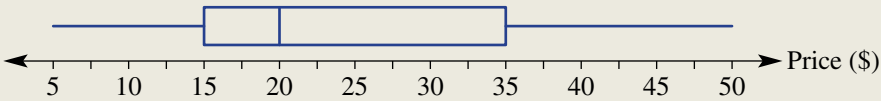

- State the minimum and maximum book prices.
- Find the range of the book prices.
- State the median book price.
- Find the interquartile range.
- Fifty per cent of the books are priced below what amount?
- Twenty-five per cent of the books are priced above what amount?
- If there were 1000 books in the store, how many would be priced below \$15?

SOLUTION

- Minimum book price = \$5
Maximum book price = \$50

- Range = $\$50 - \5
= \$45

- Median book price = \$20

- Interquartile range = $\$35 - \15
= \$20

- \$20

- \$35

- $0.25 \times 1000 = 250$
250 books would be below \$15.

EXPLANATION

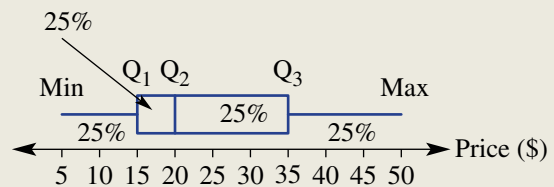

$$\text{Range} = \text{maximum price} - \text{minimum price}$$

The median is Q_2 .

$$\text{Interquartile range} = Q_3 - Q_1$$

50% of books are below Q_2 .

The top 25% of books are above Q_3 .

25% of books are priced below \$15.



Now you try

This box plot summarises the number of air-conditioning units sold at an electrical store each day in summer.

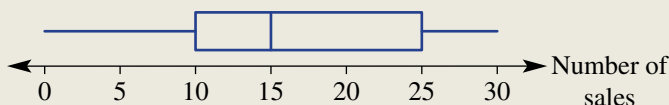

- State the minimum and maximum number of units sold in a day.
- Find the range of the number of sales.
- State the median number of sales.
- Find the interquartile range.
- Fifty per cent of days had sales below what number?
- Twenty-five per cent of days had sales above what number?
- If there were 80 days of sales, on how many days were there fewer than 10 sales?

**Example 21 Constructing a box plot**

The following set of data represents the 11 scores resulting from throwing two dice and adding their scores.

7 10 7 12 8 9 6 6 5 4 8

- Find:
 - the minimum value
 - the maximum value
 - the median
 - the lower quartile
 - the upper quartile.
- Draw a box plot to represent the data.

SOLUTION

a

	Q_1	Q_2	Q_3	
4	5	6	7	8
				8
				9
				10
				12

- Min. value = 4
- Max. value = 12
- $Q_2 = 7$
- $Q_1 = 6$
- $Q_3 = 9$

- b** Box plot: Throwing two dice

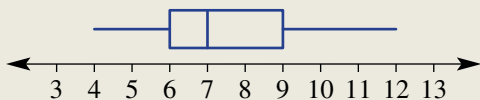
**EXPLANATION**

Order the data.

Determine the minimum and maximum value.

The median is the middle value.

Remove the middle value then locate the lower quartile and upper quartile.

Draw a scaled horizontal axis.

Place the box plot above the axis marking in the five key statistics from part **a**.

Now you try

The following set of data represents the hours worked by a shift worker in their last 15 shifts.

6 8 4 2 6 6 7 3 5 5 6 8 7 3 5

a Find:

- i** the minimum value **ii** the maximum value **iii** the median
iv the lower quartile **v** the upper quartile.

b Draw a box plot to represent the data.

Exercise 9L**FLUENCY**1, 2, 3($\frac{1}{2}$)1, 3($\frac{1}{2}$)2, 3($\frac{1}{2}$)

Example 20

- 1** This box plot summarises the lengths of babies born in a particular week in a hospital.

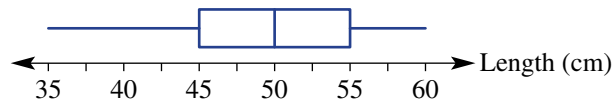

- a** State the minimum and maximum lengths of babies.
b Find the range of the length of the babies.
c State the median baby length.
d Find the interquartile range.
e Fifty per cent of the babies were born shorter than what length?
f Twenty-five per cent of the babies were born longer than what length?
g If there were 80 babies born in the week, how many would be expected to be less than 45 cm in length?
- 2** This box plot summarises the number of rabbits spotted per day in a paddock over a 100-day period.

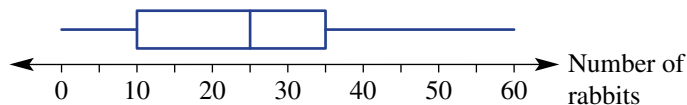

- a** State the minimum and maximum number of rabbits spotted.
b Find the range of the number of rabbits spotted.
c State the median number of rabbits spotted.
d Find the interquartile range.
e On 75% of the days, the number of rabbits spotted is below what number?
f On 50% of the days, the number of rabbits spotted is more than what number?
g On how many days was the number of rabbits spotted less than 10?



Example 21

3 Consider the sets of data below.

- i State the minimum value.
 - ii State the maximum value.
 - iii Find the median (Q_2).
 - iv Find the lower quartile (Q_1).
 - v Find the upper quartile (Q_3).
 - vi Draw a box plot to represent the data.
- a 2 2 3 3 4 6 7 7 7 8 8 8 8 9 11 11 13 13 13
- b 43 21 65 45 34 42 40 28 56 50 10 43 70 37 61 54 88 19
- c 435 353 643 244 674 364 249 933 523 255 734
- d 0.5 0.7 0.1 0.2 0.9 0.5 1.0 0.6 0.3 0.4 0.8 1.1 1.2 0.8 1.3 0.4 0.5

PROBLEM-SOLVING

4, 5

4, 5

5, 6

4 The following set of data describes the number of cars parked in a street on 18 given days.

14 26 39 46 13 30 5 46 37 26 39 8 8 9 17 48 29 27

- a Represent the data as a box plot.
- b State the percentage of days on which the number of cars parked on the street was between:
- i 4 and 48
 - ii 13 and 39
 - iii 5 and 39
 - iv 39 and 48.

5 The weights of a sample of adult leopards from Africa and Asia are summarised in these box plots.

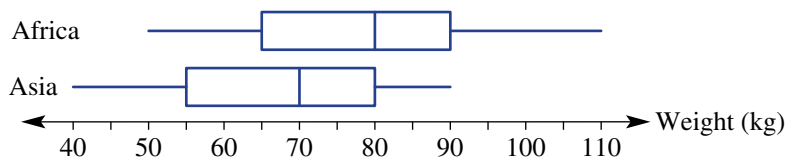

- a Which leopard population sample has the highest minimum weight?
 - b What is the difference between the ranges for the two population samples?
 - c Is the IQR the same for both leopard samples? If so, what is it?
 - d i What percentage of African leopards have a weight less than 80 kg?
ii What percentage of Asian leopards have a weight less than 80 kg?
 - e A leopard has a weight of 90 kg. Is it likely to be an Asian or African leopard?
- 6 The time that it takes for a sample of computers to start up is summarised in these box plots.

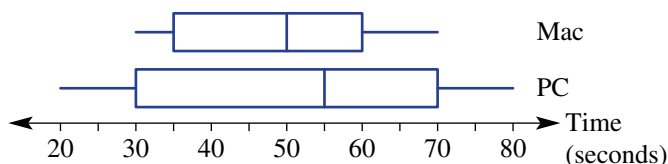

- a What type of computer has the lowest median?
- b What percentage of Mac computers started up in less than 1 minute?
- c What percentage of PC computers took longer than 55 seconds to start up?
- d What do you notice about the range for Mac computers and the IQR for PC computers?
What does this mean?

REASONING

7

7–9

8–10

- 7 The number of points per game for two basketball players over a season is summarised in these box plots.

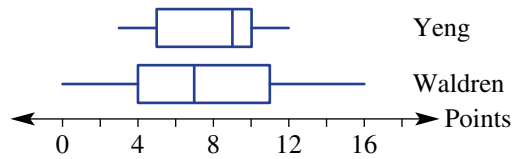

- Which player has the highest maximum?
 - Which player has the highest median?
 - Which player has the smallest IQR?
 - Which player is a more consistent basketball scorer? Give reasons.
 - Which player is more likely to have scored the greatest number of points? Give reasons.
- 8 Give an example of a small data set which has the following.
- Maximum = upper quartile
 - Median = lower quartile
- 9 Does the median always sit exactly in the middle of a box on a box plot? Explain.
- 10 Could the mean of a data set be greater than Q_3 ? Explain.

ENRICHMENT: Outliers and battery life

–

–

11

- 11 Outliers on box plots are shown as separate points.

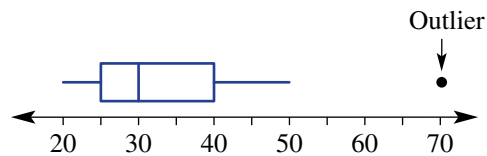

The life, in months, of a particular battery used in a high-powered calculator is shown in this data set.

3 3 3 4 4 5 6 6 6 7 8 8 9 17

- Use all the values to calculate Q_1 , Q_2 and Q_3 for the data set.
- Do any of the values appear to be outliers?
- Not including the outlier, what is the next highest value?
- Draw a box plot for the data using a dot (●) to show the outlier.
- Can you give a logical reason for the outlier?



Using a CAS calculator 9L: Finding measures of spread and drawing box plots

The activity is in the Interactive Textbook in the form of a printable PDF.

The missing data

Gregory is a marine biologist and is collecting and analysing data regarding shark and dolphin numbers in a particular area of the Great Barrier Reef.

He collects data each day for 14 days, but unfortunately two pieces of data are lost due to a computer glitch as shown.

Day	1	2	3	4	5	6	7	8	9	10	11	12	13	14
Sharks	15	12	4	? ₁	15	11	19	5	1	10	12	6	24	11
Dolphins	4	7	2	3	2	6	4	2	? ₂	4	7	2	4	6

Present a report for the following tasks and ensure that you show clear mathematical workings and explanations where appropriate.

Preliminary task

- If Gregory assumes that $?_1 = 10$, find the following correct to one decimal place.
 - The mean and the median number of sharks recorded.
 - The range and interquartile range for the number of sharks recorded.
- If Gregory assumes that $?_2 = 5$, find the following correct to one decimal place.
 - The mean and the median number of dolphins recorded.
 - The range and interquartile range for the number of dolphins recorded.
- Which set of data (dolphin or shark) appears to be more inconsistent and spread out?

Modelling task

- | | |
|----------------------------|---|
| Formulate | a The problem is to determine the possible values of $?_1$ and $?_2$ so that Gregory can complete his report based on some statistics that he can remember. Write down all the relevant information that will help solve this problem. |
| Solve | b Gregory seems to remember that the range for the number of dolphins was 7. Determine the value of $?_2$ if Gregory's memory is correct. |
| | c From memory, Gregory thought that the mean number of sharks over the 14 days was approximately 12. Determine the likely value for $?_1$. |
| | d From memory, Gregory thought that the mean number of dolphins over the 14 days was approximately 5. Determine the likely value for $?_2$. |
| | e If the median for the number of sharks was equal to 11, find the possible values of $?_1$. |
| | f If the interquartile range of the number of dolphins is 4, determine the possible values of $?_2$. |
| Evaluate and verify | g If in fact the mean number of dolphins over the 14-day period was 4 after rounding to the nearest integer, find all the possible values of $?_2$. |
| | h If in fact the interquartile range for the number of sharks was 9, find all the possible values of $?_1$. |
| Communicate | i Summarise your results and describe any key findings. |

Extension questions

- Decide if it is possible for the median of either set of data to be anything other than an integer. If so, determine what values of $?_1$ and $?_2$ allow this to happen.
- Is it possible to choose values for $?_1$ and $?_2$ so that the interquartile range for sharks is exactly double that for dolphins? If so, explain how this is possible.

Simulating candidates

Key technology: Spreadsheets and programming

When selecting more than one item from a group, we are working with compound or multiple events for which tables and tree diagrams could be used to list possible outcomes and their associated probabilities. For more complex problems it may become too cumbersome to use such techniques to calculate probabilities. Hence, computer simulations are used to find suitable approximations.



1 Getting started

Consider a simple selection of two people from a group of five of which two support the Red (R) political party and three support the Blue (B) political party. The two selections are made to fill two key roles on a committee. Assume at this stage that the same person can hold both positions and so the experiment is to be run with replacement.

R/B	R	R	B	B	B
R	(R, R)	(R, R)	(B, R)		
R					
B					
B					
B					

- a Complete this table to show all the outcomes for the two committee positions.
- b Use your table results to find the following probability of obtaining:
 - i 2 Reds ii 2 Blues
 - iii 1 Red and 1 Blue in any order.

2 Applying an algorithm

The given flowchart simulates the selection of two people from a group of 5 of which two support the Red (R) political party and three support the Blue (B) political party. Two random integers from 1 to 5 are generated with the numbers 1 and 2 meaning that a Red is chosen. The number of times two reds are chosen is represented by i and the number of trials is represented by n .

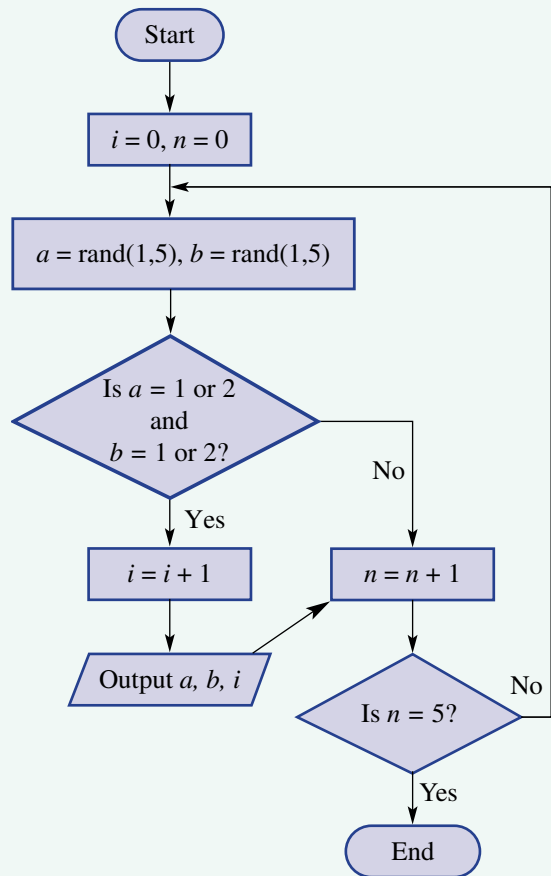

- a** Run through the algorithm using a random number generator to generate the values of a and b . Suggestions include Excel: = Rand(1,5) or CAS: RandInt(1,5). Complete the following table for the different n values.
- b** Why does the algorithm stop after 5 trials?
- c** Which variable counts how many times there are two Reds? How many times were two Red candidates selected in your simulation using the algorithm?

n	a	b	i
1			
2			
3			
4			
5			

3 Using technology

We will use a spreadsheet to apply the above algorithm simulating the selection of two Red or Blue candidates with replacement.

- a** Enter the following formulas into a spreadsheet as shown.

	A	B	C	D	E
1	Two-step simulation with replacement			Frequency	=COUNTIF(E5:E24,"YES")
2				Probability	=E1/20
3					
4	Outcome 1	Red or Blue?	Outcome 2	Red or Blue?	Two red?
5	=RANDBETWEEN(1,5)	=IF(OR(A5=1,A5=2),"Red","Blue")	=RANDBETWEEN(1,5)	=IF(OR(A5=1,A5=2),"Red","Blue")	=IF(AND(B5="Red",D5="Red"),"YES","NO")

- b** Explain what the formulas in row 5 do.
- c** Fill down at cells A5, B5, C5, D5 and E5 to row 24. This should generate results for 20 trials.
- d** Now fill in the formulas at cells E1 and E2. Explain what you think these formulas do.
- e** Press Shift F9 to rerun the simulation and note the results in E1 and E2. Keep a record of the probability of obtaining two Reds (cell E2) for 10 reruns of the simulation and find the average of these results. Compare this with the theoretical result obtained in part 1 b i.

The following spreadsheet is similar to the one above, but this time assumes that selections are made without replacement. This means that a person from the group of five cannot be chosen for both positions on the committee.

	A	B	C	D	E	F
1	Two-step simulation without replacement			Frequency	=COUNTIF(F5:F24,"YES")	
2				Probability	=E1/20	
3						
4	Outcome 1	Red or Blue?	Outcome 2	Red or Blue?	Allowed?	Two red?
5	=RANDBETWEEN(1,5)	=IF(OR(A5=1,A5=2),"Red","Blue")	=RANDBETWEEN(1,5)	=IF(OR(A5=1,A5=2),"Red","Blue")	=IF(A5=C5,"NO","YES")	=IF(AND(B5="Red",D5="Red",E5="YES"),"YES","NO")

- f** Enter this information into a new sheet and fill down the cells A5, B5, C5, D5 and E5 to row 24.
- g** Compare the probability result (cell E2) in this new spreadsheet with the same result from the previous spreadsheet. What does this tell you about the probability of obtaining two Reds by making selections with replacement compared to making selections without replacement?

4 Extension

- a** Use a tree diagram or table to calculate the theoretical probability of obtaining two Reds if selections are chosen without replacement. Compare this with your results from part 3 g above.
- b** Modify your spreadsheet so that the number of trials is 100 instead of 20 for both spreadsheets above. Also alter the formulas for the frequency and the probability.
- c** Use Shift F9 to rerun your simulation with 100 trials. What do you notice about your probability compared to the results obtained from using 20 trials?

How many in the bag?

For this activity you will need:

- a bag or large pocket
- different-coloured counters
- paper and pen.

Five counters

- Form pairs and then, without watching, have a third person (e.g. a teacher) place five counters of two different colours into the bag or pocket. An example of five counters could be two red and three blue, but at this point in the activity you will not know this.
- Without looking, one person selects a counter from the bag while the other person records its colour. Replace the counter in the bag.
- Repeat part **b** for a total of 100 trials. Record the results in a table similar to this one.

Colour	Tally	Frequency
Red	III III
Blue	III III II
Blue	100	100

- Find the experimental probability for each colour. For example, if 42 red counters were recorded, then the experimental probability = $\frac{42}{100} = 0.42$.
- Use these experimental probabilities to help estimate how many of each colour of counter are in the bag. For example, 0.42 is close to $0.4 = \frac{2}{5}$, therefore guess two red and three blue counters. Use this table to help.

Colour	Frequency	Experimental probability	Closest multiple of 0.2, e.g. 0.2, 0.2, ...	Guess of how many counters of this colour
Total	100	1	1	5

- Now take the counters out of the bag to see if your estimate is correct.

More colours and counters

- Repeat the steps above but this time use three colours and 8 counters.
- Repeat the steps above but this time use four colours and 12 counters.



- 1 A fair coin is tossed 5 times.
 - a How many outcomes are there?
 - b Find the probability of obtaining at least 4 tails.
 - c Find the probability of obtaining at least 1 tail.
- 2 Three cards, A, B and C, are randomly arranged in a row.
 - a Find the probability that the cards will be arranged in the order A B C from left to right.
 - b Find the probability that the B card will take the right-hand position.
- 3 Four students, Rick, Belinda, Katie and Chris, are the final candidates for the selection of school captain and vice-captain. Two of the four students will be chosen at random to fill the positions.
 - a Find the probability that Rick will be chosen for:
 - i captain
 - ii captain or vice-captain.
 - b Find the probability that Rick and Belinda will be chosen for the two positions.
 - c Find the probability that Rick will be chosen for captain and Belinda will be chosen for vice-captain.
 - d Find the probability that the two positions will be filled by Rick and Chris or Belinda and Katie.
- 4 State what would happen to the mean, median and range of a data set in these situations.
 - a Five is added to each value in the data set.
 - b Each value in the data set is doubled.
 - c Each value in the data set is doubled and then decreased by 1.
- 5 Three pieces of fruit have an average weight of m grams. After another piece of fruit is added, the average weight doubles. Find the weight of the extra piece of fruit in terms of m .
- 6
 - a Five different data values have a range and median equal to 7. If two of the values are 3 and 5, what are the possible combinations of values?
 - b Four data values have a range of 10, a mode of 2 and a median of 5. What are the four values?
- 7 Five integer scores out of 10 are all greater than 0. If the median is x , the mode is one more than the median and the mean is one less than the median, find all the possible sets of values if $x < 7$.
- 8 Thomas works in the school office for work experience. He is given four letters and four addressed envelopes. What is the probability that Thomas, who is not very good at his job, places none of the four letters into its correct envelope?



Up for a challenge? If you get stuck on a question, check out the 'Working with unfamiliar problems' poster at the end of the book to help you.

Chapter checklist with success criteria

A printable version of this checklist is available in the Interactive Textbook



9A

1. I can find probabilities of events.

e.g. This spinner has six equally divided sections. List the sample space from a spin and find both $\Pr(\text{not a 2})$ and $\Pr(\text{a 1 or a 2})$.

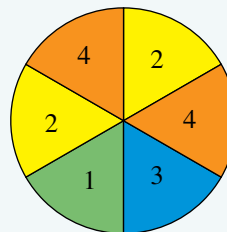

9B

2. I can use a Venn diagram.

e.g. A survey of 30 people in 2019 found that 12 thought Nick Kyrgios would win a grand slam tennis event in his career and 16 thought Alex de Minaur would win a grand slam tennis event in his career. Of those, 6 thought both would win a grand slam event while 8 thought neither would win one. Construct a Venn diagram. Use this to state how many people do not think Nick Kyrgios will win one as well as the probability that a randomly chosen person thinks only Alex de Minaur will win one.

9B

3. I can use a two-way table.

e.g. On a particular day at a car service station, 20 cars are serviced: 12 cars need a wheel alignment, 10 cars need their brake fluid replaced and 4 require both. Illustrate the situation using a two-way table. Use the table to find how many cars require neither, and the probability that a randomly selected car needs only a wheel alignment.

9C

4. I can use set notation.

e.g. A number is chosen from the set of integers between 1 and 10 inclusive. Let A be the set of even numbers between 1 and 10 inclusive and B the set of factors of 24 between 1 and 10 inclusive. Draw a Venn diagram showing the number of elements in sets A and B .

- List the sets $A \cup B$ and B only.
- Find $n(A')$ and $\Pr(A \cap B)$.

9D

5. I can use an array to find the sample space for events with replacement.

e.g. Two four-sided dice numbered 1, 2, 3, 4 are rolled. Draw a table to list the sample space and find the probability of obtaining two even numbers.

9D

6. I can use an array to find the sample space for events without replacement.

e.g. Two letters are chosen at random from the word GREEN without replacement. List the outcomes in a table and find the probability that at least one of the letters is an E.

9E

7. I can construct a tree diagram.

e.g. A game involves tossing three coins. Complete a tree diagram to show all possible outcomes and find the probability of tossing exactly 2 heads.

9E

8. I can construct a tree diagram involving without replacement.

e.g. Two donuts are selected from a box containing three donuts with strawberry (S), chocolate (C) and banana (B) icing. List all the possible outcomes for the selection in a tree diagram and find the probability that the selection will contain the chocolate iced donut.

9F

9. I can find the experimental probability.

e.g. A container contains an unknown number of coloured counters. A counter is drawn from the container and then replaced. This is repeated 50 times and the colour of the counter is recorded each time. Given that 20 green counters were recorded, find the experimental probability for selecting a green counter, and find the expected number of green counters if there were 300 counters in total in the container.

Chapter checklist with success criteria

		✓
9G	<p>10. I can classify data. e.g. Classify the data type from the following surveys. i. The number of Christmas presents received ii. The breakfast buffet at a hotel: poor, average, good, excellent</p>	<input type="checkbox"/>
9E	<p>11. I can choose a sampling method. e.g. Identify the sampling method used in each of these surveys. i. An airline chooses every sixth passenger on a flight ii. One hundred students are grouped into year level and then tested on spelling words</p>	<input type="checkbox"/>
9G	<p>12. I can identify bias in a data collection method. e.g. One hundred people at the airport are surveyed about how often they travel. This data is used to make conclusions about that city and how often people travel. Do you think this survey will contain bias? If so, explain why.</p>	<input type="checkbox"/>
9H	<p>13. I can find the mean, median and mode. e.g. Find the mean, median and mode for this data set: 8 8 3 6 4 4.</p>	<input type="checkbox"/>
9H	<p>14. I can find a data value for a required mean. e.g. A student's quiz marks for the first 7 weeks of term were: 4, 8, 6, 5, 6, 7, 6. Calculate the mean of these marks and find the score needed in the 8th week for the mean to equal 6.5.</p>	<input type="checkbox"/>
9I	<p>15. I can construct and use a stem-and-leaf plot. e.g. Organise the data below into an ordered stem-and-leaf plot and find the median and mode. State whether the data is symmetrical or skewed. 0.4 3.2 2.4 1.7 4.4 2.1 4.1 2.7 3.2</p>	<input type="checkbox"/>
9I	<p>16. I can construct a back to back stem-and-leaf plot. e.g. The maximum daily temperatures for two world cities over a two-week period are recorded as: City A: 21 18 24 26 30 26 22 19 18 24 19 28 27 32 City B: 12 12 9 15 10 13 20 21 21 17 22 18 17 9 Draw a back-to-back stem-and-leaf plot with an interval of 10 and compare and comment on the differences between the maximum temperatures for the two cities.</p>	<input type="checkbox"/>
9J	<p>17. I can construct frequency tables and histograms. e.g. For the data below showing the ice-cream sales each hour of operation over a week, set up and complete a grouped frequency table using class intervals 0–4, 5–9, etc. 15 22 1 0 20 3 10 2 23 3 11 14 19 3 16 14 24 7 1 15 5 7 2 29 28 3 2 13 26 20 22 25 6 7 12 6 13 7 7 20 11 11 From the table, construct a frequency histogram and state for how many hours there were sales of 15 or more ice-creams.</p>	<input type="checkbox"/>
9K	<p>18. I can find the range. e.g. Find the range for this data set: 7 17 21 34 22 18 8 3 16</p>	<input type="checkbox"/>
9K	<p>19. I can find the quartiles for an odd number of data values. e.g. List the data below in order from smallest to largest and find the median (Q_2), the lower quartile (Q_1), the upper quartile (Q_3) and the interquartile range (IQR). 7 17 21 34 22 18 8 3 16</p>	<input type="checkbox"/>

Chapter checklist with success criteria

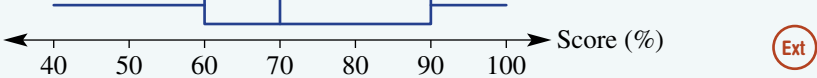
		✓
9K	<p>20. I can find the quartiles for an even number of data values. e.g. List the data below in order from smallest to largest and find the median (Q_2), the lower quartile (Q_1), the upper quartile (Q_3) and the interquartile range (IQR). Interpret the IQR. 12 21 18 8 4 16 24 11 27 10</p>	<input type="checkbox"/>
9L	<p>21. I can interpret a box plot. e.g. This box plot summarises the test results (%) of a class of students.</p>  <p>i. Find the range and interquartile range of the results. ii. Twenty-five per cent of results were above what number? iii. If there were 24 students in the class, how many scored above 70%?</p>	<input type="checkbox"/>
9L	<p>22. I can construct a box plot. e.g. For the data shown below, find the minimum and maximum values, the median and lower and upper quartiles and draw a box plot to represent the data. 18 15 13 14 21 25 17 11 15 16 18 20 24 19</p>	<input type="checkbox"/>

Short-answer questions

9A

- 1 Determine the probability of each of the following.
- Rolling more than 2 on a normal six-sided die
 - Selecting a vowel from the word EDUCATION
 - Selecting a pink or white jelly bean from a packet containing 4 pink, 2 white and 4 black jelly beans

9B

- 2 From a survey of 50 people, 30 have the newspaper delivered, 25 read it online, 10 do both and 5 do neither.
- Construct a Venn diagram for the survey results.
 - How many people only read the newspaper online?
 - If one of the 50 people was randomly selected, find:
 - Pr(have paper delivered and read it online)
 - Pr(don't have it delivered)
 - Pr(only read it online).

9B/C

- 3 a Copy and complete this two-way table.
 b Convert the information into a Venn diagram like that shown.

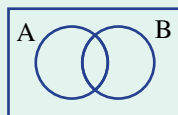

	A	A'	Total
B		16	
B'	8		20
Total	17		

- c Find the following probabilities.
- Pr(B')
 - Pr(A ∩ B)
 - n(A only)
 - n(A ∪ B)

9D

- 4 A spinner with equal areas of red, green and blue is spun and a four-sided die numbered 1 to 4 is rolled.
- Complete a table like the one shown and state the number of outcomes in the sample space.
 - Find the probability that the outcome:
 - is red and an even number
 - is blue or green and a 4
 - does not involve blue.

		Die			
		1	2	3	4
Spinner	red	(red, 1)	(red, 2)		
	green				
	blue				

9E

- 5 Libby randomly selects two coins from her pocket *without replacement*. Her pocket contains a \$1 coin, and two 10-cent coins.
- List all the possible combinations using a tree diagram.
 - If a chocolate bar costs \$1.10, find the probability that she can hand over the two coins to pay for it.

9F

- 6 A quality controller records the frequency of the types of chocolates from a sample of 120 from its production line.

Centre	Soft	Hard	Nut
Frequency	50	22	48

- a What is the experimental probability of randomly selecting a nut centre?
 b In a box of 24 chocolates, how many would be expected to have a non-soft centre?

9G

- 7 Jody is planning to run a survey asking people in her year about their current favourite Netflix show.

- a Classify the type of data to be collected.
 b Identify the sampling method in each of the following survey methods she is considering.
 i Assigning each student a number and generating some random numbers
 ii Surveying every fifth person in the school canteen queue.
 c After planning, Jody surveys everyone in her extension science class, and then will use the data to make conclusions about her year level. Do you think this survey will contain bias? If so, explain why.

9H

- 8 Claudia records the number of emails she receives each weekday for two weeks as follows.
 30 31 33 23 29 31 21 15 24 23

Find:

- a the mean
 b the median
 c the mode.

9H

- 9 Jacob achieved scores of 12, 9, 7 and 12 on his last four language vocabulary tests. What score must he get on the fifth test to have a mean of 11?

9I

- 10 Two mobile phone salespeople are both aiming for a promotion to be the new assistant store manager. The best salesperson over a 15-week period will get the promotion. The number of mobile phones they sold each week is recorded below.

Employee 1: 21 34 40 38 46 36 23 51 35 25 39 19 35 53 45

Employee 2: 37 32 29 41 24 17 28 20 37 48 42 38 17 40 45

- a Draw an ordered back-to-back stem-and-leaf plot for the data.
 b For each employee, find:
 i the median number of sales
 ii the mean number of sales.
 c By comparing the two sets of data, state, with reasons, who you think would get the promotion.
 d Describe each employee's data as approximately symmetrical or skewed.

9J

- 11 The data below represents the finish times, in minutes, of 25 competitors in a local car rally.

134 147 162 164 145 159 151 143 136 155 163 157 168

128 144 161 158 136 178 152 167 154 161 152 171

- a Record the data in a frequency table in class intervals of 10 minutes. Include a percentage frequency column.
 b Construct a frequency histogram.
 c Determine:
 i the number of competitors who finished in less than 140 minutes
 ii the percentage of competitors who finished with times of between 130 and 160 minutes.

9K/L

12 Scott scores the following runs in each of his innings across the course of a cricket season:
20 5 34 42 10 3 29 55 25 37 51 12 34 22

Ext

- a Find the range.
- b Construct a box plot to represent the data by first finding the quartiles.
- c From the box plot, 25% of his innings were above what number of runs?

Multiple-choice questions

9A

1 A letter is randomly chosen from the word XYLOPHONE. The probability that it is an O is:

- A $\frac{1}{8}$
- B $\frac{2}{9}$
- C $\frac{1}{4}$
- D $\frac{1}{9}$
- E $\frac{1}{3}$

9B

2 The values of x and y in the two-way table are:

- A $x = 12, y = 8$
- B $x = 12, y = 11$
- C $x = 16, y = 4$
- D $x = 10, y = 1$
- E $x = 14, y = 6$

	A	not A	Total
B		5	9
not B	8	y	
Total	x		25

9C

3 Which shaded region represents $A \cup B$?

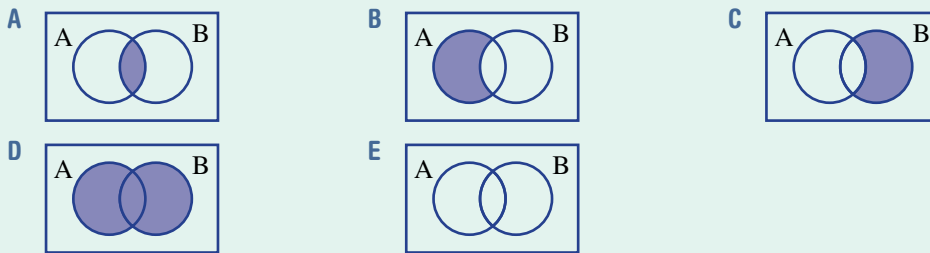

9D/E

4 A bag contains 2 green balls and 1 red ball. Two balls are randomly selected *without replacement*. The probability of selecting one of each colour is:

- A $\frac{1}{2}$
- B $\frac{2}{3}$
- C $\frac{5}{6}$
- D $\frac{1}{3}$
- E $\frac{3}{4}$

9F

5 Students roll a biased die and find that the experimental probability of rolling a 5 is 0.3. From 500 rolls of the die, the expected number of 5s would be:

- A 300
- B 167
- C 180
- D 150
- E 210

9I

6 The median of the data in this stem-and-leaf plot is:

- A 74
- B 71
- C 86
- D 65
- E 70

Stem	Leaf
5	3 5 8
6	1 4 7
7	0 2 4 7 9
8	2 6 6

7 | 4 means 74

9G

7 The type of data generated by the survey question ‘How long is your arm length?’ is:

- A a random number
- B categorical ordinal
- C categorical nominal
- D numerical discrete
- E numerical continuous

9J

- 8 This frequency histogram shows the times of competitors in a fun run. The percentage of competitors who finished in better than 40 minutes was:

A 55% B 85% C 50%
 D 62.5% E 60%

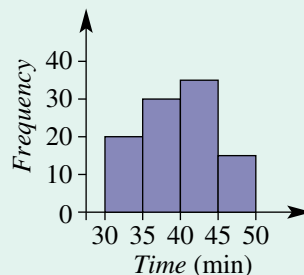

9K

- 9 Consider the set of ordered data below.

1.1 2.3 2.4 2.8 3.1 3.4 3.6 3.8 3.8 4.1 4.5 4.7 4.9

The interquartile range is:

A 2–5 B 1.7 C 3.8 D 1.3 E 2.1

9L

Ext

- 10 Choose the incorrect statement about the box plot below.

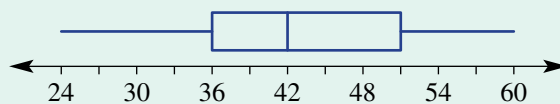

- A The range is 36.
 B Fifty per cent of values are between 36 and 51.
 C The median is 42.
 D Twenty-five per cent of values are below 36.
 E The interquartile range is 20.

Extended-response questions

- 1 The local Sunday market has a number of fundraising activities.

- a For \$1 you can spin a spinner numbered 1–5 twice. If you spin two even numbers you receive \$2 (your dollar back plus an extra dollar), if you spin two odd numbers you get your dollar back and otherwise you lose your dollar.

		First spin				
		1	2	3	4	5
Second spin	1	(1, 1)	(2, 1)			
	2					
	3					
	4					
	5					

- i Complete the table shown to list the sample space.
 ii What is the probability of losing your dollar?
 iii What is the probability of making a dollar profit?
 iv In 50 attempts, how many times would you expect to lose your dollar?
 v If you start with \$100 and have 100 attempts, how much money would you expect to end up with?

- b Forty-five people were surveyed as they walked through the market as to whether they bought a sausage and/or a drink from the sausage sizzle. Twenty-five people bought a sausage, 30 people bought a drink, with 15 buying both. Let S be the set of people who bought a sausage and D the set of people who bought a drink.
- Construct a Venn diagram to represent this information.
 - How many people did not buy either a drink or a sausage?
 - How many people bought a sausage only?
 - If a person was randomly selected from the 45 people surveyed, what is the probability they bought a drink but not a sausage?
 - Find $\Pr(S')$.
 - Find $\Pr(S' \cup D)$ and state what this probability represents.

- 2 The data below represents the data collected over a month of 30 consecutive days of the delay time (in minutes) of the flight departures of the same evening flight for two rival airlines.

Airline A

2	11	6	14	18	1	7	4	12	14	9	2	13	4	19
13	17	3	52	24	19	12	14	0	7	13	18	1	23	8

Airline B

6	12	9	22	2	15	10	5	10	19	5	12	7	11	18
21	15	10	4	10	7	18	1	18	8	25	4	22	19	26

- Does the data for airline A appear to have any outliers (numbers not near the majority of data elements)?
 - Remove any outliers listed in part a, and find the following values for airline A:
 - median (Q_2)
 - lower quartile (Q_1)
 - upper quartile (Q_3).
- Ext** c Hence, complete a box plot of the delay times for airline A.
- d Airline A reports that half its flights for that month had a delay time of less than 10 minutes. Is this claim correct? Explain.
- Ext** e On the same axis as in part c, construct a box plot for the delay times for airline B.
- f Find the range and interquartile range of the data for the two airlines and comment on the spread of the delay times for each company.
- g Use your answers to the previous question parts to explain which airline you would choose on the basis of their delay times and why.



10

Introduction to quadratic equations and graphs

Maths in context: Projectiles, parabolas, and price point for maximum revenue

Galileo (17th century) discovered that under the influence of gravity the trajectory (flight path) of a projectile (a launched object) follows a parabola shaped curve modelled by a quadratic equation.

In many sports, projectiles follow parabolic trajectories, including in basketball, volleyball, soccer, cricket, golf, shotput, discus, javelin, ski jumping, long and high jumping, and horse jumping. The launching angle influences the trajectory's maximum height and range. Generally, a launch angle of 45° will give maximum range, with steeper angles resulting in a greater maximum height but shorter range. Sports Scientists can use quadratic equations to analyse an athlete's performance trajectories, studying details for possible technique improvement.

Quadratic equations are formed when two linear expressions are multiplied. Financial analysts use quadratic equations to model sales and price. If selling n items, each priced at p dollars, a linear formula for n using p is developed.

Revenue = unit price (p) \times n (number sold)

Revenue = $p \times$ (formula for n using p)

E.g., $R = p \times (60 - 0.1p) = 60p - 0.1p^2$

The revenue equation is a quadratic, and the graph of 'Revenue' (y -axis) vs 'Price' (x -axis) is an inverted parabola. As the price p increases, revenue initially increases to a maximum, then it decreases with continuing decline in sales. The parabola's turning point locates the item's price point for maximum revenue.



Chapter contents

- 10A** Quadratic equations
- 10B** Solving $ax^2 + bx = 0$ and $x^2 = d$
- 10C** Solving $x^2 + bx + c = 0$
- 10D** Using quadratic equations to solve problems
- 10E** The parabola
- 10F** Sketching $y = ax^2$ with dilations and reflections
- 10G** Sketching translations of $y = x^2$
- 10H** Sketching parabolas using intercept form

Australian Curriculum 9.0

ALGEBRA

Simplify algebraic expressions, expand binomial products and factorise monic quadratic expressions (AC9M9A02)

Identify and graph quadratic functions, solve quadratic equations graphically and numerically, and solve monic quadratic equations with integer roots algebraically, using graphing software and digital tools as appropriate (AC9M9A04)

Use mathematical modelling to solve applied problems involving change including financial contexts; formulate problems, choosing to use either linear or quadratic functions; interpret solutions in terms of the situation; evaluate the model and report methods and findings (AC9M9A05)

Experiment with the effects of the variation of parameters on graphs of related functions, using digital tools, making connections between graphical and algebraic representations, and generalising emerging patterns (AC9M9A06)

© ACARA

Online resources

A host of additional online resources are included as part of your Interactive Textbook, including HOTmaths content, video demonstrations of all worked examples, auto-marked quizzes and much more.

10A Quadratic equations

LEARNING INTENTIONS

- To be able to identify a quadratic equation
- To know how to write a quadratic equation in standard form
- To understand the Null Factor Law
- To be able to apply the Null Factor Law to solve an equation in factorised form

Quadratic equations are commonplace in theoretical and practical applications of mathematics. They are used to solve problems in geometry and measurement as well as in number theory and physics. The path that a projectile takes while flying through the air, for example, can be analysed using quadratic equations.

A quadratic equation can be written in the form

$ax^2 + bx + c = 0$ where a , b and c are constants and $a \neq 0$.

Examples include $x^2 - 2x + 1 = 0$, $5x^2 - 3 = 0$ and $-0.2x^2 + 4x = 0$. Unlike linear equations which have a single solution, quadratic equations can have zero, one or two solutions. For example, $x = 2$ and $x = -1$ are solutions to the quadratic equation $x^2 - x - 2 = 0$ since $2^2 - 2 - 2 = 0$ and $(-1)^2 - (-1) - 2 = 0$. One method for finding the solutions to quadratic equations involves the use of the Null Factor Law where each factor of a factorised quadratic expression is equated to zero.



Quadratic equations are widely used in many areas of work including: sports scientists analysing the trajectory of a javelin or discus, electronic engineers finding currents and voltages, and financial analysts modelling future revenue and profit.

Lesson starter: Exploring the Null Factor Law

$x = 1$ is not a solution to the quadratic equation $x^2 - x - 12 = 0$ since $1^2 - 1 - 12 \neq 0$.

- Use trial and error to find at least one of the two numbers that are solutions to $x^2 - x - 12 = 0$.
- Rewrite the equation in factorised form.

$$x^2 - x - 12 = 0 \text{ becomes } (\quad)(\quad) = 0$$

- Now repeat the first task above to find solutions to the equation using the factorised form.
- Was the factorised form easier to work with? Discuss.

KEY IDEAS

- A **quadratic equation** can be written in the form $ax^2 + bx + c = 0$.
 - This is called **standard form**.
 - a , b and c are constants and $a \neq 0$.
- The **Null Factor Law** states that if the product of two numbers is zero, then either or both of the two numbers is zero.
 - If $p \times q = 0$ then $p = 0$ or $q = 0$.
 - If $(x + 1)(x - 3) = 0$ then $x + 1 = 0$ (so $x = -1$) or $x - 3 = 0$ (so $x = 3$).
 - $x + 1$ and $x - 3$ are the linear factors of $x^2 - 2x - 3$, which factorises to $(x + 1)(x - 3)$.

BUILDING UNDERSTANDING

- 1 Evaluate these quadratic expressions by substituting the x -value given in the brackets.
- a $x^2 - 5$ ($x = 1$) b $x^2 + 2x$ ($x = -1$) c $3x^2 - x + 2$ ($x = 5$)
- 2 Decide if the following equations are quadratics (yes or no).
- a $1 - 2x = 0$ b $x^2 + 3x + 1 = 0$ c $x^2 - 1 = 0$
 d $x^3 + x^2 - 2 = 0$ e $x^5 + 1 - x = 0$ f $x + 2 = 4x^2$
- 3 Solve these linear equations.
- a $x - 1 = 0$ b $x + 3 = 0$ c $2x + 4 = 0$
- 4 State the missing components to complete the following working, which uses the Null Factor Law.
- a $x(x - 5) = 0$ b $(2x + 1)(x - 3) = 0$
 $x = 0$ or $\underline{\hspace{2cm}} = 0$ $\underline{\hspace{2cm}} = 0$ or $x - 3 = 0$
 $x = 0$ or $x = \underline{\hspace{2cm}}$ $2x = \underline{\hspace{2cm}}$ or $x = \underline{\hspace{2cm}}$
 $x = \underline{\hspace{2cm}}$ or $x = 3$



Example 1 Writing in standard form

Write these quadratic equations in standard form: $ax^2 + bx + c = 0$, $a > 0$.

a $x^2 = 2x + 7$ b $2(x^2 - 3x) = 5$ c $2x - 7 = -3x^2$

SOLUTION

a $x^2 = 2x + 7$
 $x^2 - 2x - 7 = 0$

b $2(x^2 - 3x) = 5$
 $2x^2 - 6x = 5$
 $2x^2 - 6x - 5 = 0$

c $2x - 7 = -3x^2$
 $3x^2 + 2x - 7 = 0$

EXPLANATION

We require the form $ax^2 + bx + c = 0$.
 Subtract $2x$ and 7 from both sides to move all terms to the left-hand side.

First expand brackets then subtract 5 from both sides.

Add $3x^2$ to both sides, to make the x^2 coefficient positive.

Now you try

Write these quadratic equations in standard form: $ax^2 + bx + c = 0$, $a > 0$.

a $x^2 = 3x + 5$ b $2(x^2 + 4x) = 7$ c $3x - 4 = -2x^2$

**Example 2 Testing for a solution**

Substitute the given x -value into the equation and say whether or not it is a solution.

a $x^2 + x - 6 = 0$ ($x = 2$)

b $2x^2 + 5x - 3 = 0$ ($x = -4$)

SOLUTION

a $x^2 + x - 6 = 2^2 + 2 - 6$
 $= 6 - 6$
 $= 0$
 $\therefore x = 2$ is a solution

b $2x^2 + 5x - 3 = 2(-4)^2 + 5(-4) - 3$
 $= 2 \times 16 + (-20) - 3$
 $= 32 - 20 - 3$
 $= 9$
 $\therefore x = -4$ is not a solution

EXPLANATION

Substitute $x = 2$ into the equation to see if the left-hand side equals zero.
 $x = 2$ satisfies the equation, so $x = 2$ is a solution.

Substitute $x = -4$. Recall that $(-4)^2 = 16$ and $5 \times (-4) = -20$.
 The equation is not satisfied so $x = -4$ is not a solution.

Now you try

Substitute the given x -value into the equation and say whether or not it is a solution.

a $x^2 + x - 3 = 0$ ($x = 1$)

b $3x^2 + 4x - 15 = 0$ ($x = -3$)

**Example 3 Using the Null Factor Law**

Use the Null Factor Law to solve these equations.

a $x(x + 2) = 0$

b $(x - 1)(x + 5) = 0$

c $(2x - 1)(5x + 3) = 0$

SOLUTION

a $x(x + 2) = 0$
 $x = 0$ or $x + 2 = 0$
 $x = 0$ or $x = -2$

b $(x - 1)(x + 5) = 0$
 $x - 1 = 0$ or $x + 5 = 0$
 $x = 1$ or $x = -5$

c $(2x - 1)(5x + 3) = 0$
 $2x - 1 = 0$ or $5x + 3 = 0$
 $2x = 1$ or $5x = -3$
 $x = \frac{1}{2}$ or $x = -\frac{3}{5}$

EXPLANATION

The factors are x and $(x + 2)$. Solve each linear factor equal to zero.

Check each solution by substituting into the original equation.

Solve each factor $(x - 1)$ and $(x + 5)$ equal to zero.

Check your solutions using substitution.

The two factors are $(2x - 1)$ and $(5x + 3)$.

Each one results in a two-step linear equation.

Check your solutions using substitution.

Now you try

Use the Null Factor Law to solve these equations.

a $x(x + 5) = 0$

b $(x + 2)(x - 3) = 0$

c $(3x - 2)(2x + 5) = 0$

Exercise 10A

FLUENCY

1–2(1/2), 3, 5(1/2)

1–2(1/2), 4, 5–6(1/2)

1(1/2), 2(1/3), 4, 5–6(1/3)

Example 1

1 Write these quadratic equations in standard form: $ax^2 + bx + c = 0$, $a > 0$.

a $x^2 = 7x + 2$

b $x^2 - 5x = -2$

c $x^2 = 4x - 1$

d $3(x^2 - 2x) = 4$

e $2(x^2 + x) + 1 = 0$

f $3(x^2 - x) = -4$

g $4 = -3x^2$

h $3x = x^2 - 1$

i $5x = 2(-x^2 + 5)$

Example 2

2 Substitute the given x -value into the quadratic equation and say whether or not it is a solution.

a $x^2 - 1 = 0$ ($x = 1$)

b $x^2 - 25 = 0$ ($x = 5$)

c $x^2 - 4 = 0$ ($x = 1$)

d $2x^2 + 1 = 0$ ($x = 0$)

e $x^2 - 9 = 0$ ($x = -3$)

f $x^2 - x - 12 = 0$ ($x = 5$)

g $x^2 + 2x + 1 = 0$ ($x = -1$)

h $2x^2 - x + 3 = 0$ ($x = -1$)

i $5 - 2x + x^2 = 0$ ($x = -2$)

3 Substitute $x = -2$ and $x = 5$ into the equation $x^2 - 3x - 10 = 0$. What do you notice?4 Substitute $x = -3$ and $x = 4$ into the equation $x^2 - x - 12 = 0$. What do you notice?

Example 3a,b

5 Use the Null Factor Law to solve these equations.

a $x(x + 1) = 0$

b $x(x + 5) = 0$

c $x(x - 2) = 0$

d $x(x - 7) = 0$

e $(x + 1)(x - 3) = 0$

f $(x - 4)(x + 2) = 0$

g $(x + 7)(x - 3) = 0$

h $\left(x + \frac{1}{2}\right)\left(x - \frac{1}{2}\right) = 0$

i $2x(x + 5) = 0$

j $5x\left(x - \frac{2}{3}\right) = 0$

k $\frac{x}{3}\left(x + \frac{2}{3}\right) = 0$

l $\frac{2x}{5}(x + 2) = 0$

Example 3c

6 Use the Null Factor Law to solve these equations.

a $(2x - 1)(x + 2) = 0$

b $(x + 2)(3x - 1) = 0$

c $(5x + 2)(x + 4) = 0$

d $(x - 1)(3x - 1) = 0$

e $(x + 5)(7x + 2) = 0$

f $(3x - 2)(5x + 1) = 0$

g $(11x - 7)(2x - 13) = 0$

h $(4x + 9)(2x - 7) = 0$

i $(3x - 4)(7x + 1) = 0$

PROBLEM-SOLVING

7

7–8(1/2)

8–9(1/2)

7 Find the numbers which satisfy the given condition.

a The product of x and a number 3 more than x is zero.b The product of x and a number 7 less than x is zero.c The product of a number 1 less than x and a number 4 more than x is zero.d The product of a number 1 less than twice x and 6 more than x is zero.e The product of a number 3 more than twice x and 1 less than twice x is zero.

8 Write these equations as quadratics in standard form. Remove any brackets and fractions.

a $5x^2 + x = x^2 - 1$

b $2x = 3x^2 - x$

c $3(x^2 - 1) = 1 + x$

d $2(1 - 3x^2) = x(1 - x)$

e $\frac{x}{2} = x^2 - \frac{3}{2}$

f $\frac{4x}{3} - x^2 = 2(1 - x)$

g $\frac{5}{x} + 1 = x$

h $\frac{3}{x} + \frac{5}{2} = 2x$

9 These quadratic equations have two integer solutions between -5 and 5 . Use trial and error to find them.

a $x^2 - x - 2 = 0$

b $x^2 - 4x + 3 = 0$

c $x^2 - 4x = 0$

d $x^2 + 3x = 0$

e $x^2 + 3x - 4 = 0$

f $x^2 - 16 = 0$

REASONING

10

10, 11

11, 12

- 10 Consider the quadratic equation $(x + 2)^2 = 0$.
- Write the equation in the form $(\quad)(\quad) = 0$.
 - Use the Null Factor Law to find the solutions to the equation. What do you notice?
 - Now solve these quadratic equations.
 - $(x + 3)^2 = 0$
 - $(x - 5)^2 = 0$
 - $(2x - 1)^2 = 0$
 - $(5x - 7)^2 = 0$
- 11 Consider the equation $3(x - 1)(x + 2) = 0$.
- First divide both sides of the equation by 3. Write down the new equation.
 - Solve the equation using the Null Factor Law.
 - Compare the given original equation with the equation found in part **a**. Explain why the solutions are the same.
 - Solve these equations.
 - $7(x + 2)(x - 3) = 0$
 - $11x(x + 2) = 0$
 - $\frac{(x + 1)(x - 3)}{4} = 0$
 - $-2(x + 2)(x - 5) = 0$
- 12 Consider the equation $(x - 3)^2 + 1 = 0$.
- Substitute these x -values to decide if they are solutions to the equation.
 - $x = 3$
 - $x = 4$
 - $x = 0$
 - $x = -2$
 - Do you think the equation will have a solution? Explain why.

ENRICHMENT: Polynomials

-

-

13, 14

- 13 Polynomials are sums of integer powers of x . They are given names according to the highest power of x in the polynomial expression.

Example	Polynomial name
2	Constant
$2x + 1$	Linear
$x^2 - 2x + 5$	Quadratic
$x^3 - x^2 + 6x - 1$	Cubic
$7x^4 + x^3 + 2x - x + 4$	Quartic
$4x^5 - x + 1$	Quintic

Name these polynomial equations.

- $3x - 1 = 0$
 - $x^2 + 2 = 0$
 - $x^5 - x^4 + 3 = 0$
 - $5 - 2x + x^3 = 0$
 - $3x - 2x^4 + x^2 = 0$
 - $5 - x^5 = x^4 + x$
- 14 Solve these polynomial equations using the Null Factor Law.
- $(x + 1)(x - 3)(x + 2) = 0$
 - $(x - 2)(x - 5)(x + 11) = 0$
 - $(2x - 1)(3x + 2)(5x - 1) = 0$
 - $(3x + 2)(5x + 4)(7x + 10)(2x - 13) = 0$

10B Solving $ax^2 + bx = 0$ and $x^2 = d$

LEARNING INTENTIONS

- To know the steps required to solve a quadratic equation
- To be able to factorise a quadratic equation in order to apply the Null Factor Law
- To be able to find the solutions of quadratic equations involving common factors or perfect squares

When using the Null Factor Law, we notice that equations must first be expressed as a product of two factors. Hence, any equation not in this form must first be factorised. Two types of quadratic equations are studied here. The first is of the form $ax^2 + bx = 0$, where x is a common factor, and the second is of the form $x^2 = d$.



Aerospace engineers use quadratic equations, such as for the trajectory of a rocket launching a communications satellite. An object launched vertically with velocity, u , moving under gravity, with acceleration, g , reaches a maximum height, h , where $u^2 = 2gh$.

Lesson starter: Which factorisation technique?

These two equations may look similar but they are not the same: $x^2 - 9x = 0$ and $x^2 - 9 = 0$.

- Discuss how you could factorise each expression on the left-hand side of the equations.
- How does the factorised form help to solve the equations? What are the solutions? Are the solutions the same for both equations?
- By rearranging $x^2 - 9 = 0$ into $x^2 = 9$, can you explain how to find the two solutions you found above?

KEY IDEAS

- When solving an equation of the form $ax^2 + bx = 0$, factorise by taking out common factors including x .

$$\begin{aligned} 2x^2 - 8x &= 0 \\ 2x(x - 4) &= 0 \\ 2x = 0 \text{ or } x - 4 = 0 \\ x = 0 \text{ or } x &= 4 \end{aligned}$$

- When solving an equation of the form $ax^2 = d$, divide both sides by a and then take the square root of each side.

$$\begin{aligned} 5x^2 &= 20 \\ x^2 &= 4 \\ x = 2 \text{ or } x &= -2 \end{aligned}$$

- $x^2 = d^2$ could also be rearranged to $x^2 - d^2 = 0$ and then factorised as a difference of two squares.

$$\begin{aligned} x^2 - 4 &= 0 \\ (x + 2)(x - 2) &= 0 \\ x = -2 \text{ or } x &= 2 \end{aligned}$$

BUILDING UNDERSTANDING

- 1 State the highest common factor of these pairs of terms.
 - a $16x$ and 24
 - b x^2 and $2x$
 - c $3x^2$ and $6x$
- 2 Factorise these expressions fully by first taking out the highest common factor.
 - a $x^2 - 3x$
 - b $6x^2 + 4x$
 - c $4x - 16x^2$
 - d $2x^2 - 8$
- 3 Use the Null Factor Law to state the solutions to these equations.
 - a $x(x - 3) = 0$
 - b $4x(x + 1) = 0$
- 4 Explain why $x = 3$ and $x = -3$ are solutions to $x^2 = 9$.

**Example 4 Solving quadratic equations of the form $ax^2 + bx = 0$**

Solve each of the following equations.

a $x^2 + 4x = 0$

b $2x^2 = 8x$

SOLUTION

$$\begin{aligned} \text{a } x^2 + 4x &= 0 \\ x(x + 4) &= 0 \\ x = 0 \text{ or } x + 4 &= 0 \\ x = 0 \text{ or } x &= -4 \end{aligned}$$

$$\begin{aligned} \text{b } 2x^2 &= 8x \\ 2x^2 - 8x &= 0 \\ 2x(x - 4) &= 0 \\ 2x = 0 \text{ or } x - 4 &= 0 \\ x = 0 \text{ or } x &= 4 \end{aligned}$$

EXPLANATION

Factorise by taking out the common factor x . Using the Null Factor Law, set each factor, x and $(x + 4)$, equal to 0. Solve for x . Check your solutions using substitution.

Make the right-hand side equal to zero by subtracting $8x$ from both sides. Factorise by taking out the common factor of $2x$ and apply the Null Factor Law to solve. For $2 \times x = 0$, x must equal 0.

Now you try

Solve each of the following equations.

a $x^2 + 6x = 0$

b $3x^2 = 15x$

**Example 5 Solving equations of the form $ax^2 = d$**

Solve these equations.

a $x^2 = 16$

b $3x^2 = 18$

SOLUTION

$$\begin{aligned} \text{a } x^2 &= 16 \\ x = 4 \text{ or } x &= -4 \end{aligned}$$

EXPLANATION

As this is a perfect square, take the square root of both sides.
 $x = 4$ or -4 since $4^2 = 16$ and $(-4)^2 = 16$.

Alternative method:

$$\begin{aligned}x^2 &= 16 \\x^2 - 16 &= 0 \\(x + 4)(x - 4) &= 0 \\x + 4 = 0 \text{ or } x - 4 = 0 \\x &= -4 \text{ or } x = 4\end{aligned}$$

b $3x^2 = 18$
 $x^2 = 6$
 $x = \sqrt{6}$ or $x = -\sqrt{6}$

Alternative method:

$$\begin{aligned}3x^2 &= 18 \\3x^2 - 18 &= 0 \\3(x^2 - 6) &= 0 \\3(x + \sqrt{6})(x - \sqrt{6}) &= 0 \\x + \sqrt{6} = 0 \text{ or } x - \sqrt{6} = 0 \\x &= -\sqrt{6} \text{ or } x = \sqrt{6}\end{aligned}$$

Rearrange into standard form.

Factorise using $a^2 - b^2 = (a + b)(a - b)$ then use the Null Factor Law to find the solutions.

Divide both sides by 3 and then take the square root of each side.

As 6 is not a square number leave answers in exact form as $\sqrt{6}$ and $-\sqrt{6}$.

Alternatively, express in standard form and then note the common factor of 3.

Treat $x^2 - 6 = x^2 - (\sqrt{6})^2$ as a difference of squares.Apply the Null Factor Law and solve for x .**Now you try**

Solve these equations.

a $x^2 = 49$

b $2x^2 = 14$

Exercise 10B**FLUENCY**1-4($\frac{1}{2}$)1-5($\frac{1}{2}$)1-5($\frac{1}{2}$)

Example 4a

1 Solve these equations.

a $x^2 + 3x = 0$

b $x^2 + 7x = 0$

c $x^2 + 4x = 0$

d $x^2 - 5x = 0$

e $x^2 - 8x = 0$

f $x^2 - 2x = 0$

g $x^2 + \frac{1}{3}x = 0$

h $x^2 - \frac{1}{2}x = 0$

2 Solve these equations by first taking out the highest common factor.

a $2x^2 - 6x = 0$

b $3x^2 - 12x = 0$

c $4x^2 + 20x = 0$

d $6x^2 - 18x = 0$

e $-5x^2 + 15x = 0$

f $-2x^2 - 8x = 0$

Example 4b

3 Solve the following equations by first rearranging into standard form.

a $x^2 = 3x$

b $5x^2 = 10x$

c $4x^2 = 16x$

d $3x^2 = -9x$

e $2x^2 = -8x$

f $7x^2 = -21x$

Example 5a

4 Solve the following equations.

a $x^2 = 9$

b $x^2 = 36$

c $x^2 = 25$

d $x^2 - 144 = 0$

e $x^2 - 81 = 0$

f $x^2 - 400 = 0$

Example 5b

5 Solve each of the following equations by first noting the common factor.

a $7x^2 = 28$

b $5x^2 = 45$

c $2x^2 = 50$

d $6x^2 = 24$

e $2x^2 = 12$

f $3x^2 = 15$

g $5x^2 - 35 = 0$

h $8x^2 - 24 = 0$

PROBLEM-SOLVING

6($\frac{1}{2}$)6($\frac{1}{2}$), 7

7, 8

6 Solve these equations by first rearranging where necessary.

a $4 = x^2$

b $-x^2 + 25 = 0$

c $-x^2 = -100$

d $-3x^2 = 21x$

e $-5x^2 + 35x = 0$

f $1 - x^2 = 0$

g $12x = 18x^2$

h $2x^2 + x = 7x^2 - 2x$

i $9 - 2x^2 = x^2$

7 Write an equation and solve it to find the number.

a The square of the number is 7 times the same number.

b The difference between the square of a number and 64 is zero.

c 3 times the square of a number is equal to -12 times the number.

8 Remove brackets or fractions to help solve these equations.

a $x - \frac{4}{x} = 0$

b $\frac{36}{x} - x = 0$

c $\frac{3}{x^2} = 3$

d $5(x^2 + 1) = 3x^2 + 7$

e $x(x - 3) = 2x^2 + 4x$

f $3x(5 - x) = x(7 - x)$

REASONING

9

9

9, 10

9 Consider the equation $x^2 + 4 = 0$.a Explain why it cannot be written in the form $(x + 2)(x - 2) = 0$.b Are there any solutions to the equation $x^2 + 4 = 0$? Why/Why not?10 An equation of the form $ax^2 + bx = 0$ will always have two solutions if a and b are not zero.a Explain why one of the solutions will always be $x = 0$.b Write the rule for the second solution in terms of a and b .

ENRICHMENT: More quadratic equation forms

-

-

11-12($\frac{1}{2}$)11 Note, for example, that $4x^2 = 9$ becomes $x^2 = \frac{9}{4}$ and then $x = \frac{3}{2}$ or $x = -\frac{3}{2}$, since $\sqrt{\frac{9}{4}} = \frac{3}{2}$.

Now solve these equations.

a $9x^2 = 16$

b $25x^2 = 36$

c $4 = 100x^2$

d $81 - 25x^2 = 0$

e $64 - 121x^2 = 0$

f $-49x^2 + 144 = 0$

12 Note, for example, that $(x - 1)^2 - 4 = 0$ becomes $(x - 1)^2 = 4$ with $x - 1 = 2$ or $x - 1 = -2$, giving $x = 3$ and $x = -1$. Now solve these equations.

a $(x - 2)^2 = 9$

b $(x + 5)^2 = 16$

c $(2x + 1)^2 = 1$

d $(5x - 3)^2 - 25 = 0$

e $(4 - x)^2 - 9 = 0$

f $(3 - 7x)^2 - 100 = 0$



Using a CAS calculator 10B: Solving quadratic equations

This activity is in the Interactive Textbook in the form of a printable PDF.

10C Solving $x^2 + bx + c = 0$

LEARNING INTENTIONS

- To be able to solve quadratic equations involving monic trinomials
- To understand that trinomials that factorise to perfect squares will have only one solution

Earlier in Chapter 8 we learnt to factorise quadratic trinomials with three terms. For example, $x^2 + 5x + 6$ factorises to $(x + 2)(x + 3)$. This means that the Null Factor Law can be used to solve equations of the form $x^2 + bx + c = 0$.



Mechanical engineers design industrial ventilation systems and can solve quadratic equations to calculate dimensions. For a duct with a rectangular cross-section area 1500 cm^2 , a possible equation is: $x(x - 20) = 1500$, i.e. $x^2 - 20x - 1500 = 0$.

Lesson starter: Remembering how to factorise quadratic trinomials

First expand these quadratics using the distributive law.

Distributive law: $(a + b)(c + d) = ac + ad + bc + bd$

- $(x + 1)(x + 2)$
- $(x - 3)(x + 4)$
- $(x - 5)(x - 2)$

Now factorise these expressions.

- $x^2 + 5x + 6$
- $x^2 - x - 12$
- $x^2 - 8x + 7$

Discuss your method for finding the factors of each quadratic above.

KEY IDEAS

- Solve quadratics of the form $x^2 + bx + c = 0$ by factorising the quadratic trinomial.

- Ask 'What factors of c add to give b '?
- Then use the Null Factor Law.

- Equations involving perfect squares will give only one solution.

- $x^2 + bx + c$ is called a **monic** quadratic since the coefficient of x^2 is 1.

$$\begin{aligned} x^2 - 3x - 28 &= 0 & \text{and} & \quad -7 \times 4 = -28 \\ (x - 7)(x + 4) &= 0 & & \quad -7 + 4 = -3 \\ x - 7 = 0 \text{ or } x + 4 = 0 & & & \\ x = 7 \text{ or } x = -4 & & & \end{aligned}$$

$$\begin{aligned} x^2 - 6x + 9 &= 0 \\ (x - 3)(x - 3) &= 0 \\ x - 3 &= 0 \\ x &= 3 \end{aligned}$$

BUILDING UNDERSTANDING

- 1 Decide which two factors of the first number add to give the second number.
 a 6, 5 b 10, -7 c -5, 4 d -12, -1
- 2 Factorise each of the following.
 a $x^2 + 12x + 35$ b $x^2 + 4x - 45$ c $x^2 - 10x + 16$
- 3 State the missing components to complete the working to solve each equation.
 a $x^2 + 9x + 20 = 0$ b $x^2 - 2x - 24 = 0$
 $(x + 5)(\underline{\quad}) = 0$ $(x - 6)(\underline{\quad}) = 0$
 $x + 5 = 0$ or $\underline{\quad} = 0$ $x - 6 = 0$ or $\underline{\quad} = 0$
 $x = \underline{\quad}$ or $x = \underline{\quad}$ $x = \underline{\quad}$ or $x = \underline{\quad}$



Example 6 Solving equations with quadratic trinomials

Solve these quadratic equations.

- a $x^2 + 7x + 12 = 0$
 b $x^2 - 2x - 8 = 0$
 c $x^2 - 8x + 15 = 0$

SOLUTION

a $x^2 + 7x + 12 = 0$
 $(x + 3)(x + 4) = 0$
 $x + 3 = 0$ or $x + 4 = 0$
 $x = -3$ or $x = -4$

b $x^2 - 2x - 8 = 0$
 $(x - 4)(x + 2) = 0$
 $x - 4 = 0$ or $x + 2 = 0$
 $x = 4$ or $x = -2$

c $x^2 - 8x + 15 = 0$
 $(x - 5)(x - 3) = 0$
 $x - 5 = 0$ or $x - 3 = 0$
 $x = 5$ or $x = 3$

EXPLANATION

Factors of 12 which add to 7 are 3 and 4.
 $3 \times 4 = 12$, $3 + 4 = 7$
 Use the Null Factor Law to solve the equation.

Factors of -8 which add to -2 are -4 and 2.
 $-4 \times 2 = -8$, $-4 + 2 = -2$
 Solve using the Null Factor Law.

The factors of 15 must add to give -8.
 $-5 \times (-3) = 15$ and $-5 + (-3) = -8$, so -5
 and -3 are the two numbers.

Now you try

Solve these quadratic equations.

- a $x^2 + 6x + 8 = 0$
 b $x^2 - 3x - 10 = 0$
 c $x^2 - 8x + 12 = 0$

**Example 7 Solving with perfect squares and trinomials not in standard form**

Solve these quadratic equations.

a $x^2 - 8x + 16 = 0$

b $x^2 = x + 6$

SOLUTION

a $x^2 - 8x + 16 = 0$

$(x - 4)(x - 4) = 0$

$x - 4 = 0$

$x = 4$

b $x^2 = x + 6$

$x^2 - x - 6 = 0$

$(x - 3)(x + 2) = 0$

$x - 3 = 0$ or $x + 2 = 0$

$x = 3$ or $x = -2$

EXPLANATIONFactors of 16 which add to -8 are -4 and -4 . $(x - 4)(x - 4) = (x - 4)^2$ is a perfect square so there is only one solution.First make the right-hand side equal zero by subtracting x and 6 from both sides. This is now in standard form. (When rearranging to standard form, keep the x^2 term positive.)Factors of -6 which add to -1 are -3 and 2 .**Now you try**

Solve these quadratic equations.

a $x^2 - 10x + 25 = 0$

b $x^2 = 3x + 40$

Exercise 10C**FLUENCY**1, 2-3($\frac{1}{2}$)2-4($\frac{1}{3}$)2-4($\frac{1}{3}$)

Example 6a

1 Solve these quadratic equations.

a $x^2 + 8x + 12 = 0$

b $x^2 + 11x + 24 = 0$

c $x^2 + 7x + 10 = 0$

Example 6

2 Solve these quadratic equations.

a $x^2 + 10x + 24 = 0$

b $x^2 + 9x + 18 = 0$

c $x^2 + 4x + 3 = 0$

d $x^2 - 12x + 32 = 0$

e $x^2 - 9x + 18 = 0$

f $x^2 - 10x + 21 = 0$

g $x^2 - 2x - 15 = 0$

h $x^2 - 6x - 16 = 0$

i $x^2 - 4x - 45 = 0$

j $x^2 - 10x + 24 = 0$

k $x^2 - x - 42 = 0$

l $x^2 + 5x - 84 = 0$

Example 7a

3 Solve these quadratic equations which include perfect squares.

a $x^2 + 6x + 9 = 0$

b $x^2 + 4x + 4 = 0$

c $x^2 + 14x + 49 = 0$

d $x^2 + 24x + 144 = 0$

e $x^2 - 10x + 25 = 0$

f $x^2 - 16x + 64 = 0$

g $x^2 - 12x + 36 = 0$

h $x^2 - 18x + 81 = 0$

i $x^2 - 20x + 100 = 0$

Example 7b

4 Solve these quadratic equations by first rearranging to standard form.

a $x^2 = 3x + 10$

b $x^2 = 7x - 10$

c $x^2 = 6x - 9$

d $x^2 = 4 - 3x$

e $14 - 5x = x^2$

f $x^2 + 16 = 8x$

g $x^2 - 12 = -4x$

h $6 - x^2 = 5x$

i $15 = 8x - x^2$

j $16 - 6x = x^2$

k $-6x = x^2 + 8$

l $-x^2 - 7x = -18$

PROBLEM—SOLVING5($\frac{1}{2}$), 65($\frac{1}{2}$), 6, 7($\frac{1}{2}$)5($\frac{1}{3}$), 6, 7–8($\frac{1}{2}$)

- 5 Solve these equations by taking out a common factor as the first factorising step.

a $2x^2 - 2x - 12 = 0$

b $3x^2 + 24x + 45 = 0$

c $4x^2 - 24x - 64 = 0$

d $4x^2 - 20x + 24 = 0$

e $2x^2 - 8x + 8 = 0$

f $3x^2 + 6x + 3 = 0$

g $7x^2 - 70x + 175 = 0$

h $2x^2 + 12x = -18$

i $5x^2 = 35 - 30x$

- 6 The temperature in $^{\circ}\text{C}$ inside a room at a scientific base in Antarctica after 10 a.m. is given by the expression $t^2 - 9t + 8$ where t is in hours. Find the times in the day when the temperature is 0°C .



- 7 Write down a quadratic equation in standard form which has the following solutions.

a $x = 1$ and $x = 2$

b $x = 3$ and $x = -2$

c $x = -4$ and $x = 1$

d $x = -3$ and $x = 10$

e $x = 5$ only

f $x = -11$ only

- 8 Remove brackets, decimals or fractions and write in standard form to help solve these equations.

a $x^2 = 5(x - 1.2)$

b $2x(x - 3) = x^2 - 9$

c $3(x^2 + x - 10) = 2x^2 - 5(x + 2)$

d $x - 2 = \frac{35}{x}$

e $2 + \frac{1}{x} = -x$

f $\frac{x}{4} = 1 - \frac{1}{x}$

REASONING

9

9, 10

10, 11

- 9 Consider this equation and solution.

a Explain what is wrong with the solution.

b Find the correct solutions to the equation.

$x^2 - x - 12 = -6$

$(x - 4)(x + 3) = -6$

$x - 4 = -6$ or $x + 3 = -6$

$x = -2$ or $x = -9$

- 10 Explain why $x^2 - 2x + 1 = 0$ only has one solution.

- 11 Write down a quadratic equation that has these solutions. Write in factorised form.

a $x = a$ only

b $x = a$ and $x = b$

ENRICHMENT: Solving non-monics

-

-

12($\frac{1}{2}$)

- 12 Many quadratic equations have a coefficient of x^2 not equal to 1. These are called non-monic quadratics. Factorisation can be trickier but is still possible. You may have covered this in Chapter 8. Here is an example.

$2x^2 + 5x - 3 = 0$

(Factors of $2 \times (-3) = -6$ that add to give 5 are -1 and 6 .)

$2x^2 - x + 6x - 3 = 0$

 $(6x - 1x = 5x)$

$x(2x - 1) + 3(2x - 1) = 0$

Group in pairs.

$(2x - 1)(x + 3) = 0$

$2x - 1 = 0$ or $x + 3 = 0$

$x = \frac{1}{2}$ or $x = -3$

Solve these quadratic equations.

a $5x^2 + 16x + 3 = 0$

b $3x^2 + 4x - 4 = 0$

c $6x^2 + x - 1 = 0$

d $10x^2 + 5x - 5 = 0$

e $2x^2 = 15 - 7x$

f $4x^2 = 12x - 9$

g $x = 3x^2 - 14$

h $17x = 12 - 5x^2$

i $25 = -9x^2 - 30x$

10D Using quadratic equations to solve problems

LEARNING INTENTIONS

- To be able to form an equation from a word problem using a variable for the unknown
- To be able to recognise a quadratic equation and apply the appropriate steps to solve
- To understand that solutions will need to be checked for validity in the context of the problem

When using mathematics to solve problems, we often arrive at a quadratic equation. In solving the quadratic equation we obtain the solutions to the problem. Setting up an equation and then interpreting the solution are important parts of the problem-solving process.



When dividing up land for new suburbs, surveyors apply area formulas which form quadratic equations when dimensions are expressed using the same variable. Surveyors re-arrange the quadratic to equal zero and solve it for the unknown variable.

Lesson starter: Solving for the unknown number

The product of a positive number and 6 more than the same number is 16.

- Using x as the unknown number, write an equation describing the given condition.
- Solve your equation for x .
- Are both solutions feasible (allowed)?
- Discuss how this method compares with the method of trial and error.

KEY IDEAS

- When using quadratic equations to solve problems, follow these steps.
 - Define your variable.
 - Write ‘Let x be ...’ e.g. Let x be the width in cm.
 - Use your variable to define any other quantity, e.g. length = $x + 7$.
 - Write an equation relating the facts given in the question.
 - Solve your equation using the Null Factor Law.
 - Check that your solutions are feasible.
 - Some problems may not allow solutions that are negative numbers or fractions.
 - Answer the original question in words and check that your answer seems reasonable.

BUILDING UNDERSTANDING

1 Solve these equations for x by first expanding and producing a zero on the right-hand side.

a $x(x + 3) = 18$

b $x(x - 1) = 20$

c $(x - 1)(x + 4) = 6$

2 This rectangle has an area of 8 cm^2 and a length that is 2 cm more than its width.

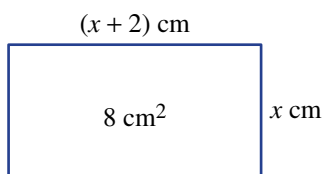

a Using length \times width = area, give an equation.

b Solve your equation by expanding and subtracting 8 from both sides. Then use the Null Factor Law.

c Which of your two solutions is feasible for the width of the rectangle?

d State the dimensions (width and length) of the rectangle.

**Example 8 Solving area problems with quadratic equations**

The length of a book is 4 cm more than its width and the area of the face of the book is 320 cm^2 . Find the dimensions of the face of the book.

SOLUTION

Let x cm be the width of the book face.

Length = $(x + 4)$ cm

Area:

$$x(x + 4) = 320$$

$$x^2 + 4x - 320 = 0$$

$$(x + 20)(x - 16) = 0$$

$$x + 20 = 0 \text{ or } x - 16 = 0$$

$$x = -20 \text{ or } x = 16$$

$$\therefore x = 16 \text{ since } x > 0$$

$$\therefore \text{width} = 16 \text{ cm and length} = 20 \text{ cm}$$

EXPLANATION

Define a variable for width then write the length in terms of the width.

Write an equation to suit the given situation.

Expand, then subtract 320 from both sides.

Solve using the Null Factor Law, but note that a width of -20 cm is not feasible.

Finish by writing the dimensions – width and length – as required.

$$\text{Length} = x + 4 = 16 + 4 = 20 \text{ cm}$$

Now you try

The length of a rectangular jigsaw puzzle is 12 cm more than its width and the area of the jigsaw is 640 cm^2 . Find the dimensions of the jigsaw puzzle.

Exercise 10D

FLUENCY

1–4, 6

1, 3, 5, 6

2, 4–6

Example 8

- 1 The length of a rectangular magazine is 8 cm more than its width and the area of the magazine is 240 cm^2 . Find the dimensions of the magazine.
- 2 The length of a rectangular brochure is 5 cm more than its width and the area of the face of the brochure is 36 cm^2 . Find the dimensions of the face of the brochure.
- 3 The product of a number and 2 more than the same number is 48. Write an equation and solve to find the two possible solutions.
- 4 The product of a number and 7 less than the same number is 60. Write an equation and solve to find the two possible solutions.
- 5 The product of a number and 13 less than the same number is 30. Write an equation and solve to find the two possible solutions.
- 6 The length of a small kindergarten play area is 20 metres less than its width and the area is 69 m^2 . Find the dimensions of the play area.

PROBLEM–SOLVING

7, 8

7–9

8–10

- 7 A square of side length 10 metres has a square of side length x metres removed from one corner.

- a Write an expression for the area remaining after the square of side length x metres is removed. (*Hint: Use subtraction.*)
- b Find the value of x if the area remaining is 64 m^2 .

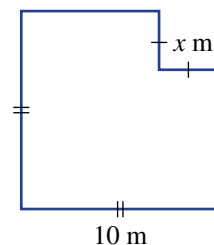

- 8 An isosceles triangle has height (h) equal to half its base length. Find the value of h if the area is 25 square units.

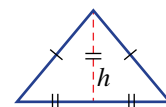

- 9 A rectangular farm shed (3 m by 5 m) is to be extended to form an 'L' shape as shown.

- a Write an expression for the total area of the extended farm shed.
- b Find the value of x if the total area is to be 99 m^2 .

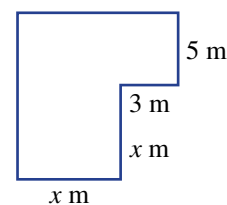

- 10 Use Pythagoras' theorem to find the value of x in these right-angled triangles.

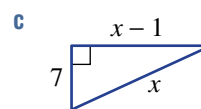
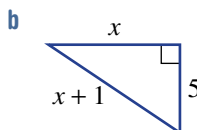
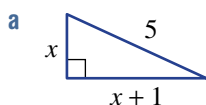

REASONING 11, 12 12, 13 12–14

11 The equation for the area of this rectangle is $x^2 + 2x - 48 = 0$, which has solutions $x = -8$ and $x = 6$. Which solution do you ignore and why?

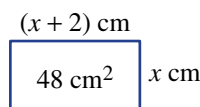

12 The product of an integer and one less than the same integer is 6. The equation for this is $x^2 - x - 6 = 0$. How many different solutions are possible and why?

13 This table shows the sum of the first n positive integers.

If $n = 3$ then the sum is $1 + 2 + 3 = 6$.

n	1	2	3	4	5	6
Sum	1	3	6			

a Write the sum for $n = 4$, $n = 5$ and $n = 6$.

b The expression for the sum is given by $\frac{n(n+1)}{2}$. Use this expression to find the sum if:

i $n = 7$

ii $n = 20$

c Use the expression to find n for these sums. Write an equation and solve it.

i sum = 45

ii sum = 120

14 The number of diagonals in a polygon with n sides is given by $\frac{n(n-3)}{2}$. Shown here are the diagonals for a quadrilateral and a pentagon.

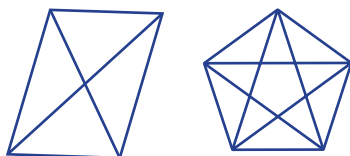

n	4	5	6	7
Diagonals	2	5		

a Use the given expression to find the two missing numbers in the table.

b Find the value of n if the number of diagonals is:

i 20

ii 54

ENRICHMENT: Picture frames – – 15, 16

15 A square picture is to be edged with a border of width x cm. The inside picture has side length of 20 cm.

a Write an expression for the total area.

b Find the width of the frame if the total area of picture and frame is to be 1600 cm^2 .

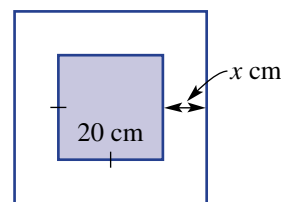

16 A square picture is surrounded by a rectangular frame as shown. The total area is to be 320 cm^2 . Find the side length of the picture.

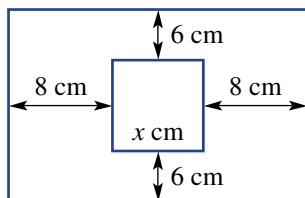

10E The parabola

LEARNING INTENTIONS

- To know that a quadratic relation produces a graph called a parabola
- To know the key features of a parabola including symmetry and the turning point
- To understand that a parabola can have a minimum or maximum turning point
- To be able to identify the key features of a parabola from a graph
- To be able to plot a parabola from a rule by creating a table of values and plotting points

Relations that have rules in which the highest power of x is 2, such as $y = x^2$, $y = 2x^2 - 3$ and $y = 3x^2 + 2x - 4$, are called quadratics and their graphs are called parabolas. Parabolic shapes can be seen in many modern-day objects or situations such as the arches of bridges, the paths of projectiles and the surfaces of reflectors.



When hitting a ball, tennis players, cricketers and golfers can vary the force and launching angle, hence modifying the direction, maximum height and range of the ball's parabolic flight path.

Lesson starter: Finding features

A quadratic is given by the equation $y = x^2 - 2x - 3$. Complete these tasks to discover its graphical features.

- Use the rule to complete this table of values.

x	-2	-1	0	1	2	3	4
y							

- Plot your points on a copy of the axes shown at right and join them to form a smooth curve.
- Describe these features:
 - minimum turning point
 - axis of symmetry
 - coordinates of the y -intercept
 - coordinates of the x -intercepts

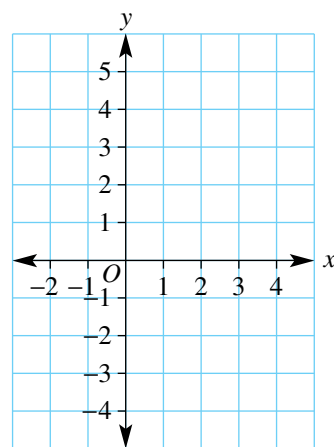



Example 9 Identifying the features of a parabola

For this graph state the:

- equation of the axis of symmetry
- type of turning point
- coordinates of the turning point
- coordinates of the x -intercepts
- coordinates of the y -intercept.

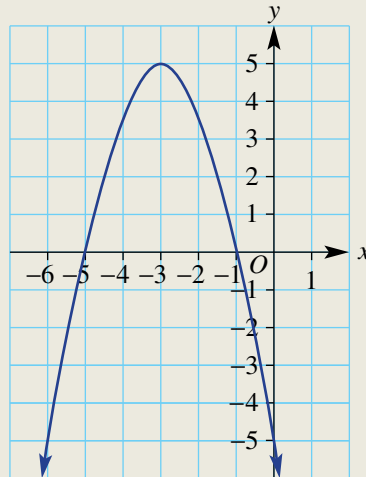

SOLUTION

- $x = -3$
- Maximum turning point
- Turning point is $(-3, 5)$
- x -intercepts: $(-5, 0)$ and $(-1, 0)$
- y -intercept: $(0, -5)$

EXPLANATION

Graph is symmetrical about the vertical line $x = -3$. Graph has its highest y -coordinate at the turning point, so it is a maximum point.

Highest point: turning point = $(-3, 5)$

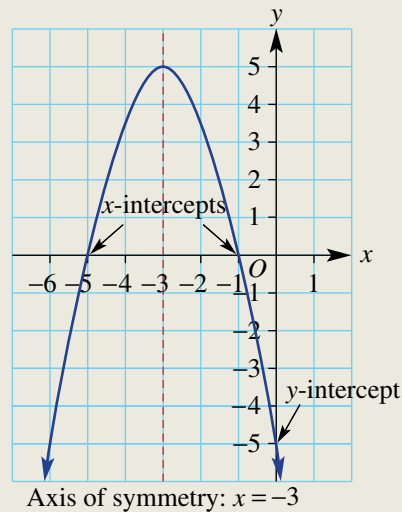

Now you try

For this graph state the:

- a** equation of the axis of symmetry
- b** type of turning point
- c** coordinates of the turning point
- d** coordinates of the x -intercepts
- e** coordinates of the y -intercept.

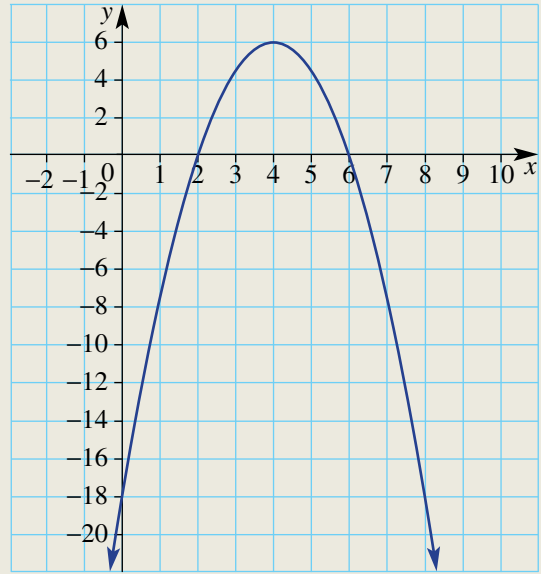

The cross-section of a satellite dish is parabolic.



Example 10 Plotting a parabola

Use the quadratic rule $y = x^2 - 4$ to complete these tasks.

a Complete this table of values.

x	-3	-2	-1	0	1	2	3
y							

b Draw a set of axes using a scale that suits the numbers in your table. Then plot the points to form a parabola.

c State these features.

- | | |
|--|---|
| i Type of turning point | ii Axis of symmetry |
| iii Coordinates of the turning point | iv The coordinates of the y -intercept |
| v The coordinates of the x -intercepts. | |

SOLUTION

a

x	-3	-2	-1	0	1	2	3
y	5	0	-3	-4	-3	0	5

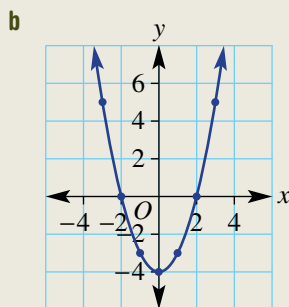

- c**
- i** Minimum turning point
 - ii** $x = 0$ is the axis of symmetry
 - iii** Turning point $(0, -4)$
 - iv** y -intercept: $(0, -4)$
 - v** x -intercepts: $(-2, 0)$ and $(2, 0)$

EXPLANATION

Substitute each x -value into the rule to find each y -value: e.g. $x = -3$, $y = (-3)^2 - 4$
 $= 9 - 4$
 $= 5$

Plot each coordinate pair and join to form a smooth curve.

The turning point at $(0, -4)$ has the lowest y -coordinate for the entire graph.
 The vertical line $x = 0$ divides the graph like a mirror line. The y -intercept is at $x = 0$.
 The x -intercepts are at $y = 0$ on the x -axis.

Now you try

Use the quadratic rule $y = x^2 - 9$ to complete these tasks.

a Complete this table of values.

x	-3	-2	-1	0	1	2	3
y							

b Draw a set of axes using a scale that suits the numbers in your table. Then plot the points to form a parabola.

c State these features.

- | | |
|--|---|
| i Type of turning point | ii Axis of symmetry |
| iii Coordinates of the turning point | iv The coordinates of the y -intercept |
| v The coordinates of the x -intercepts. | |

Exercise 10E

FLUENCY

1(1/2), 2, 3

1(1/2), 2-4

1(1/3), 2, 3, 5

Example 9

- 1 For each of the following graphs, state:
- i the equation of the axis of symmetry
 - ii the type of turning point (maximum or minimum)
 - iii the coordinates of the turning point
 - iv the coordinates of the x -intercepts
 - v the coordinates of the y -intercept.

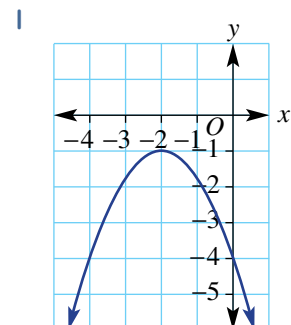
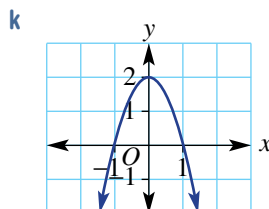
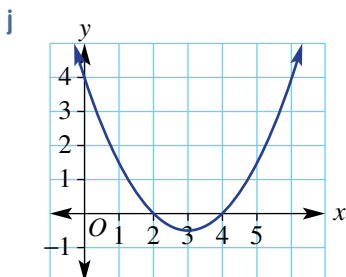
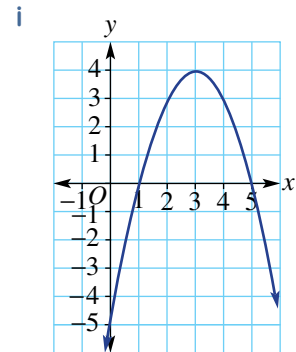
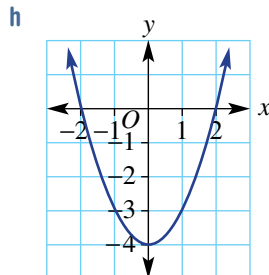
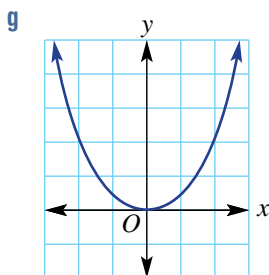
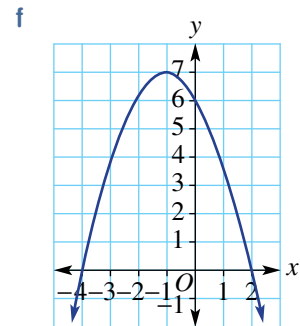
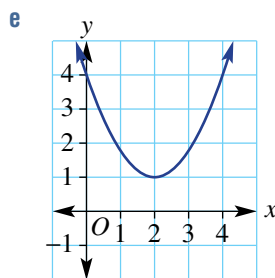
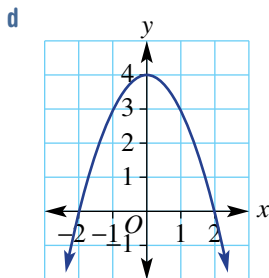
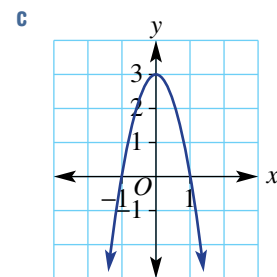
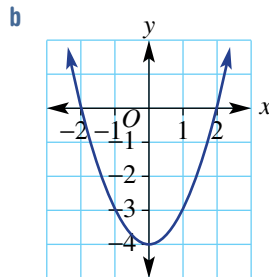
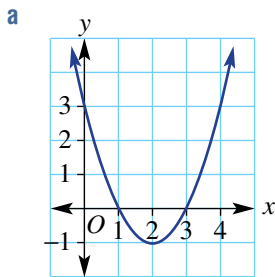

Example 10

2 Use the quadratic rule $y = x^2 - 1$ to complete these tasks.

a Complete the table of values.

x	-2	-1	0	1	2
y					

b Draw a set of axes using a scale that suits the numbers in your table. Then plot the points to form a parabola.

c State these features.

- i Type of turning point
- ii Axis of symmetry
- iii Coordinates of the turning point
- iv The coordinates of the y -intercept
- v The coordinates of the x -intercepts

3 Use the quadratic rule $y = x^2 + 2x - 3$ to complete these tasks.

a Complete the table of values.

x	-4	-3	-2	-1	0	1	2
y							

b Draw a set of axes using a scale that suits the numbers in your table. Then plot the points to form a parabola.

c State these features.

- i Type of turning point
- ii Axis of symmetry
- iii Coordinates of the turning point
- iv The coordinates of the y -intercept
- v The coordinates of the x -intercepts

4 Use the quadratic rule $y = 9 - x^2$ to complete these tasks.

a Complete the table of values.

x	-3	-2	-1	0	1	2	3
y							

b Draw a set of axes using a scale that suits the numbers in your table. Then plot the points to form a parabola.

c State these features.

- i Type of turning point
- ii Axis of symmetry
- iii Coordinates of the turning point
- iv The coordinates of the y -intercept
- v The coordinates of the x -intercepts

5 Use the quadratic rule $y = -x^2 + x + 2$ to complete these tasks. Recall that $-x^2 = -1 \times x^2$.

a Complete the table of values.

x	-2	-1	0	1	2	3
y						

b Draw a set of axes using a scale that suits the numbers in your table. Then plot the points to form a parabola.

c State these features.

- i Type of turning point
- ii Axis of symmetry
- iii Coordinates of the turning point
- iv The coordinates of the y -intercept
- v The coordinates of the x -intercepts

PROBLEM-SOLVING

6, 7

6, 8, 9

7, 9, 10

- 6 This graph shows the height of a cricket ball, y metres, as a function of time t seconds.
- At what times is the ball at a height of 9 m?
 - Why are there two different times?
 - At what time is the ball at its greatest height?
 - What is the greatest height the ball reaches?
 - After how many seconds does it hit the ground?

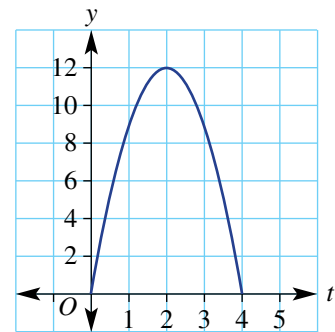

- 7 The graph gives the height, h m, at time t seconds, of a rocket which is fired up in the air.
- From what height is the rocket launched?
 - What is the approximate maximum height that the rocket reaches?
 - For how long is the rocket in the air?
 - What is the difference in time for when the rocket is going up and when it is going down?

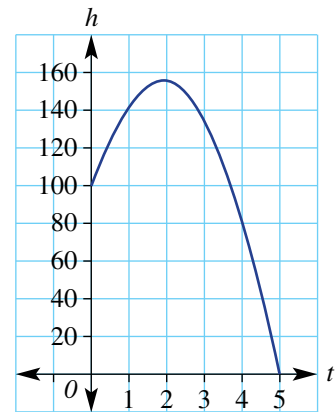

- 8 A parabola has x -intercepts at $(-2, 0)$ and $(4, 0)$. The y -coordinate of the turning point is -3 .
- What is the equation of its axis of symmetry?
 - What are the coordinates of the turning point?
- 9 A parabola has a turning point at $(1, 3)$ and one of its x -intercepts at $(0, 0)$.
- What is the equation of its axis of symmetry?
 - What are the coordinates of the other x -intercept?

10 Write the rule for these parabolas. Use trial and error to help and check your rule by substituting a known point.

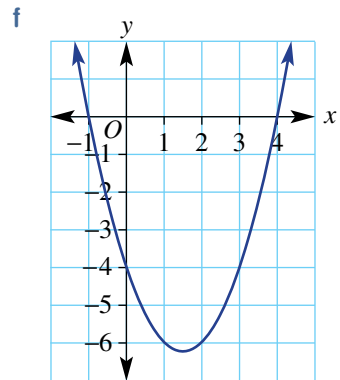
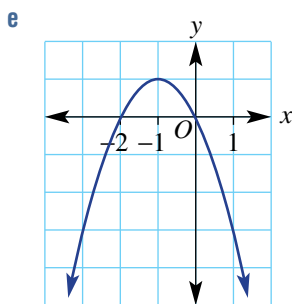
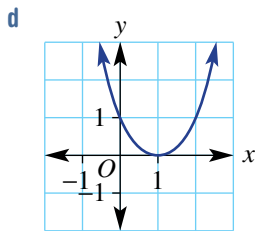
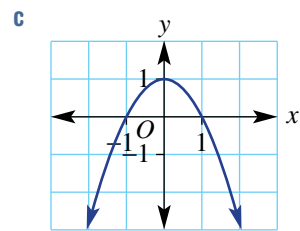
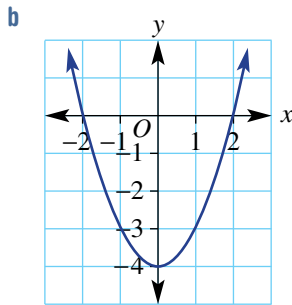
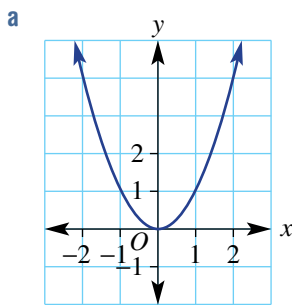

REASONING 11, 12 11–13 11, 13, 14

11 Is it possible to draw a parabola with the following properties? If yes, draw an example.

- a Two x -intercepts
- b One x -intercept
- c No x -intercepts
- d No y -intercept

12 a Mal calculates the y -value for $x = 2$ using $y = -x^2 + 2x$ and gets $y = 8$. Explain his error.
 b Mai calculates the y -value for $x = -3$ using $y = x - x^2$ and gets $y = 6$. Explain her error.

13 This graph shows the parabola for $y = x^2 - 4$.

- a For what values of x is $y = 0$?
- b For what value of x is $y = -4$?
- c How many values of x give a y -value which is:
 - i greater than -4 ?
 - ii equal to -4 ?
 - iii less than -4 ?

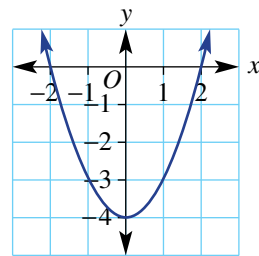

14 This table corresponds to the rule $y = x^2 - 2x$.

x	-1	0	1	2	3	4
y	3	0	-1	0	3	8

- a Use this table to solve these equations
 - i $0 = x^2 - 2x$
 - ii $3 = x^2 - 2x$
- b How many solutions would there be to the equation $8 = x^2 - 2x$? Why?
- c How many solutions would there be to the equation $-1 = x^2 - 2x$? Why?
- d How many solutions would there be to the equation $-2 = x^2 - 2x$? Why?

ENRICHMENT: Using software to construct a parabola

15

15 Follow the steps below to construct a parabola using an **interactive geometry package**.

Step 1. Show the coordinate axes system by selecting **Show Axes** from the **Draw** toolbox.

Step 2. Construct a line which is parallel to the x -axis and passes through a point F on the y -axis near the point $(0, -1)$.

Step 3. Construct a line segment AB on this line as shown in the diagram.

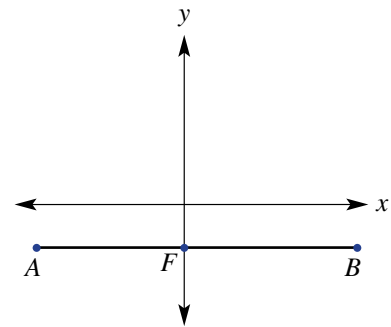

Step 4. Hide the line AB and then construct:

- a point C on the line segment AB
- a point P on the y -axis near the point $(0, 1)$.

Step 5. Construct a line which passes through the point C and is perpendicular to AB .

Step 6. Construct the point D which is equidistant from point P and segment AB . (*Hint:* Use the perpendicular bisector of PC .)

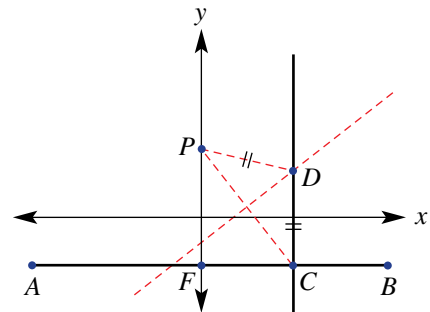

Step 7. Select **Trace** from the **Display** toolbox and click on the point D .

Step 8. Animate point C and observe what happens.

Step 9. Select **Locus** from the **Construct** toolbox and click at D and then at C .

Step 10. Drag point P and/or segment AB (by dragging F). (Clear the trace points by selecting **Refresh** drawing from the **Edit** menu.) What do you notice?

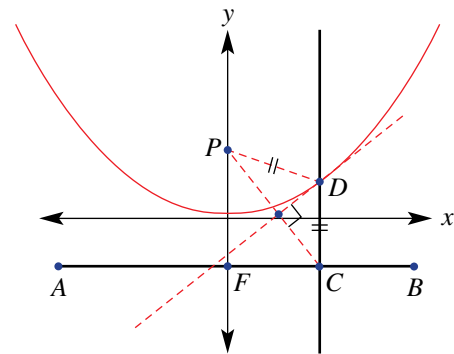

Using a CAS calculator 10E: Sketching parabolas

This activity is in the Interactive Textbook in the form of a printable PDF.



10F Sketching $y = ax^2$ with dilations and reflections

LEARNING INTENTIONS

- To understand the effect of the value and sign of a in the rule $y = ax^2$ on the shape of the graph and key features
- To know which values of a make the parabola appear narrower or wider than $y = x^2$
- To know which values of a cause the parabola to be upright or inverted

In geometry we know that shapes can be transformed by applying reflections, rotations, translations and dilations (enlargement). The same types of transformations can also be applied to graphs, including parabolas. Altering the value of a in $y = ax^2$ causes both dilations and reflections.



Suspension bridges have supporting cables that form parabolic curves, such as those on this New York bridge. Engineers model such parabolas with quadratic equations that are then used to calculate the vertical support heights.

Lesson starter: What is the effect of a ?

This table and graph show a number of examples of $y = ax^2$ with varying values of a . They could also be produced using technology.

x	-2	-1	0	1	2
$y = x^2$	4	1	0	1	4
$y = 2x^2$	8	2	0	2	8
$y = \frac{1}{2}x^2$	2	$\frac{1}{2}$	0	$\frac{1}{2}$	2
$y = -x^2$	-4	-1	0	-1	-4

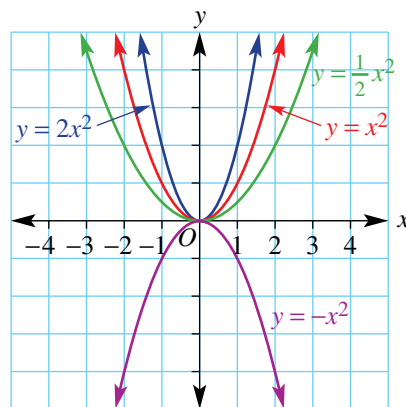

- Discuss how the different values of a affect the y -values in the table.
- Discuss how the different values of a affect the shape of the graph.
- How would the graphs of the following rules compare to the graphs shown above?

a $y = 3x^2$

b $y = \frac{1}{4}x^2$

c $y = -\frac{1}{2}x^2$

KEY IDEAS

- The most basic parabola is the graph of $y = x^2$. It can be graphed quickly using the five key points below.

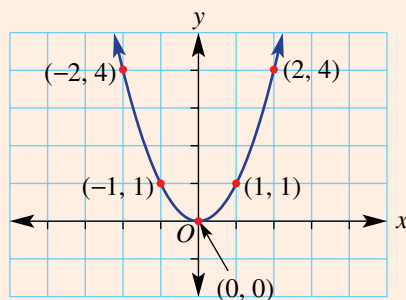

If you know these five points, you can use them to draw many other parabolas.

- The equation $y = ax^2$ describes a family of parabolas including $y = x^2$, $y = -x^2$, $y = 2x^2$, $y = -2x^2$ etc. They contain the following features:
 - the vertex (or turning point) is $(0, 0)$
 - the axis of symmetry is $x = 0$
 - if $a > 0$ the graph is **upright** (or **concave up**) and has a minimum turning point
 - if $a < 0$ the graph is **inverted** (or **concave down**) and has a maximum turning point.

- For $y = ax^2$, if $a > 1$ or $a < -1$:
the graph appears narrower than the graph of either $y = x^2$ or $y = -x^2$. For example: $y = 2x^2$ or $y = -2x^2$

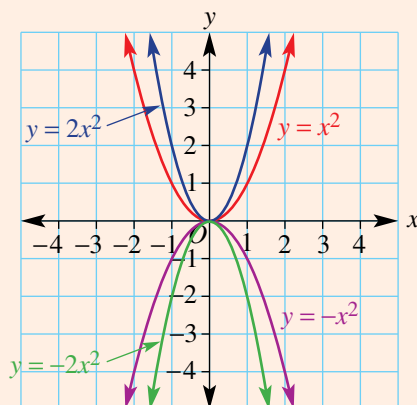

- For $y = ax^2$, if $-1 < a < 1$:
the graph appears wider than the graph of either $y = x^2$ or $y = -x^2$. For example: $y = \frac{1}{2}x^2$ or $y = -\frac{1}{2}x^2$

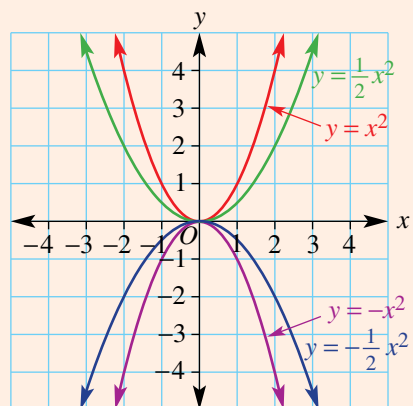

- For $y = 2x^2$ we say that the graph of $y = x^2$ is **dilated** from the x -axis by a factor of 2.
- For $y = -x^2$ we say that the graph of $y = x^2$ is **reflected** in the x -axis.

BUILDING UNDERSTANDING

- 1 Shown here are the graphs of $y = x^2$, $y = 3x^2$, $y = \frac{1}{2}x^2$, $y = -x^2$, $y = -3x^2$ and $y = -\frac{1}{2}x^2$.

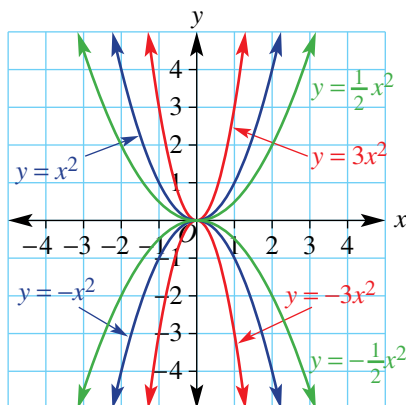

- a State the rules of the three graphs which have a minimum turning point.
- b State the rules of the three graphs which have a maximum turning point.
- c What are the coordinates of the turning point for all the graphs?
- d What is the equation of the axis of symmetry for all the graphs?
- e State the rule of the graph which is:
- upright (concave up) and narrower than $y = x^2$
 - upright (concave up) and wider than $y = x^2$
 - inverted (concave down) and narrower than $y = -x^2$
 - inverted (concave down) and wider than $y = -x^2$.
- f State the rule of the graph which is:
- a reflection of $y = x^2$ in the x -axis
 - a reflection of $y = 3x^2$ in the x -axis
 - a reflection of $y = -\frac{1}{2}x^2$ in the x -axis.
- 2 Select the word *positive* or *negative* to suit each sentence.
- a The graph of $y = ax^2$ will be upright (concave up) with a minimum turning point if a is _____.
- b The graph of $y = ax^2$ will be inverted (concave down) with a maximum turning point if a is _____.

Example 11 Comparing graphs of $y = ax^2$, $a > 0$

Complete the following for $y = x^2$, $y = 2x^2$ and $y = \frac{1}{2}x^2$.

- a Draw up and complete a table of values for $-2 \leq x \leq 2$.
- b Plot their graphs on the same set of axes.
- c Write down the equation of the axis of symmetry and the coordinates of the turning point.
- d
- Does the graph of $y = 2x^2$ appear wider or narrower than the graph of $y = x^2$?
 - Does the graph of $y = \frac{1}{2}x^2$ appear wider or narrower than the graph of $y = x^2$?

SOLUTION

a $y = x^2$

x	-2	-1	0	1	2
y	4	1	0	1	4

$y = 2x^2$

x	-2	-1	0	1	2
y	8	2	0	2	8

$y = \frac{1}{2}x^2$

x	-2	-1	0	1	2
y	2	$\frac{1}{2}$	0	$\frac{1}{2}$	2

b

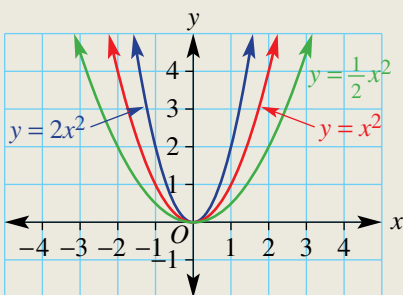

c Axis of symmetry: y -axis ($x = 0$)
Turning point: minimum at $(0, 0)$

d i The graph of $y = 2x^2$ appears narrower than the graph of $y = x^2$.

ii The graph of $y = \frac{1}{2}x^2$ appears wider than the graph of $y = x^2$.

EXPLANATION

Substitute each x -value into $y = x^2$, $y = 2x^2$ and $y = \frac{1}{2}x^2$.

e.g. for $y = 2x^2$, if $x = 2$,

$$\begin{aligned} y &= 2(2)^2 \\ &= 2(4) \\ &= 8 \end{aligned}$$

$$\begin{aligned} \text{If } x = -1, y &= 2(-1)^2 \\ &= 2(1) \\ &= 2 \end{aligned}$$

Plot the points for each graph using the coordinates from the tables and join them with a smooth curve.

Look at graphs to see symmetry about the y -axis and a minimum turning point at the origin.

For each value of x , $2x^2$ is twice that of x^2 ; hence, the graph (y -values) of $y = 2x^2$ rises more quickly.

For each value of x , $\frac{1}{2}x^2$ is half that of x^2 ; hence, the graph of $y = \frac{1}{2}x^2$ rises more slowly.

Now you try

Complete the following for $y = x^2$, $y = 4x^2$ and $y = \frac{1}{4}x^2$.

- Draw up and complete a table of values for $-2 \leq x \leq 2$.
- Plot their graphs on the same set of axes.
- Write down the equation of the axis of symmetry and the coordinates of the turning point.
- Does the graph of $y = 4x^2$ appear wider or narrower than the graph of $y = x^2$?
 - Does the graph of $y = \frac{1}{4}x^2$ appear wider or narrower than the graph of $y = x^2$?



Example 12 Comparing graphs of $y = ax^2$, $a < 0$

Complete the following for $y = -x^2$, $y = -3x^2$ and $y = -\frac{1}{2}x^2$.

- Draw up and complete a table of values for $-2 \leq x \leq 2$.
- Plot their graphs on the same set of axes.
- Write down the equation of the axis of symmetry and the coordinates of the turning point.
 - Does the graph of $y = -3x^2$ appear wider or narrower than the graph of $y = -x^2$?
 - Does the graph of $y = -\frac{1}{2}x^2$ appear wider or narrower than the graph of $y = -x^2$?

SOLUTION

a $y = -x^2$

x	-2	-1	0	1	2
y	-4	-1	0	-1	-4

$y = -3x^2$

x	-2	-1	0	1	2
y	-12	-3	0	-3	-12

$y = -\frac{1}{2}x^2$

x	-2	-1	0	1	2
y	-2	$-\frac{1}{2}$	0	$-\frac{1}{2}$	-2

b

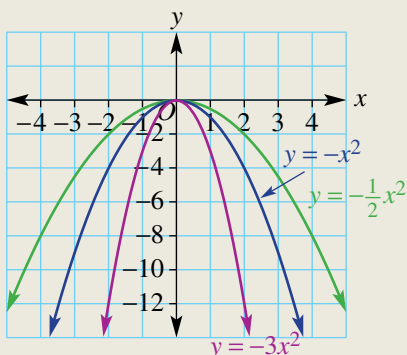

- Axis of symmetry: y -axis ($x = 0$)
Turning point: maximum at $(0, 0)$
- The graph of $y = -3x^2$ appears narrower than the graph of $y = -x^2$.
 - The graph of $y = -\frac{1}{2}x^2$ appears wider than the graph of $y = -x^2$.

EXPLANATION

Substitute each x -value into $y = -x^2$, $y = -3x^2$ and $y = -\frac{1}{2}x^2$.

e.g. for $y = -3x^2$, if $x = 2$,

$$\begin{aligned} y &= -3(2)^2 \\ &= -3(4) \\ &= -12 \end{aligned}$$

$$\begin{aligned} \text{If } x = -1, y &= -3(-1)^2 \\ &= -3(1) \\ &= -3 \end{aligned}$$

Plot the coordinates for each graph from the tables and join them with a smooth curve.

Graphs are symmetrical about the y -axis with a maximum turning point at the origin.

For each value of x , $-3x^2$ is three times that of $-x^2$; hence, the graph of $y = -3x^2$ gets larger in the negative direction more quickly.

For each value of x , $-\frac{1}{2}x^2$ is half that of $-x^2$.

Now you try

Complete the following for $y = -x^2$, $y = -4x^2$ and $y = -\frac{1}{4}x^2$.

- Draw up and complete a table of values for $-2 \leq x \leq 2$.
- Plot their graphs on the same set of axes.
- Write down the equation of the axis of symmetry and the coordinates of the turning point.
- Does the graph of $y = -4x^2$ appear wider or narrower than the graph of $y = -x^2$?
 - Does the graph of $y = -\frac{1}{4}x^2$ appear wider or narrower than the graph of $y = -x^2$?

Exercise 10F**FLUENCY**1, 2–3($\frac{1}{2}$)1, 2–3($\frac{1}{2}$)2–3($\frac{1}{2}$)

Example 11

- Complete the following for $y = x^2$, $y = 3x^2$ and $y = \frac{1}{3}x^2$.
 - Draw up and complete a table of values for $-2 \leq x \leq 2$.
 - Plot their graphs on the same set of axes.
 - Write down the equation of the axis of symmetry and the coordinates of the turning point.
 - Does the graph of $y = 3x^2$ appear wider or narrower than the graph of $y = x^2$?
 - Does the graph of $y = \frac{1}{3}x^2$ appear wider or narrower than the graph of $y = x^2$?
- For the equations given below, complete these tasks.
 - Draw up and complete a table of values for $-2 \leq x \leq 2$.
 - Plot the graphs of the equations on the same set of axes.
 - Write down the coordinates of the turning point and the equation of the axis of symmetry.
 - Determine whether the graphs of the equations each appear wider or narrower than the graph of $y = x^2$.
 - $y = 6x^2$
 - $y = 5x^2$
 - $y = \frac{1}{6}x^2$
 - $y = \frac{1}{5}x^2$

Example 12

- For the equations given below, complete these tasks.
 - Draw up and complete a table of values for $-2 \leq x \leq 2$.
 - Plot the graphs of the equations on the same set of axes.
 - List the key features for each graph, such as the axis of symmetry, turning point, x -intercept and y -intercept.
 - Determine whether the graphs of the equations each appear wider or narrower than the graph of $y = -x^2$.
 - $y = -2x^2$
 - $y = -3x^2$
 - $y = -\frac{1}{2}x^2$
 - $y = -\frac{1}{3}x^2$



PROBLEM-SOLVING

4

4, 5

5

4 Here are eight quadratics of the form $y = ax^2$.

A $y = 6x^2$

B $y = -7x^2$

C $y = 4x^2$

D $y = \frac{1}{9}x^2$

E $y = \frac{x^2}{7}$

F $y = 0.3x^2$

G $y = -4.8x^2$

H $y = -0.5x^2$

a Which rule would give a graph which is upright (concave up) and the narrowest?

b Which rule would give a graph which is inverted (concave down) and the widest?

5 Match each of the following parabolas with the appropriate equation from the list below. Do a mental check by substituting the coordinates of a known point.

a $y = 3x^2$

b $y = -x^2$

c $y = 5x^2$

d $y = \frac{1}{2}x^2$

e $y = -5x^2$

f $y = 2x^2$

A

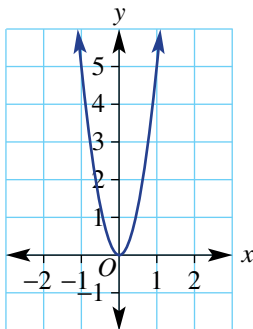

B

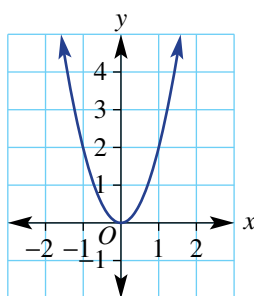

C

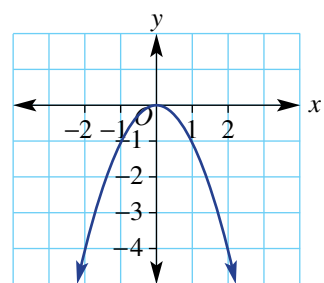

D

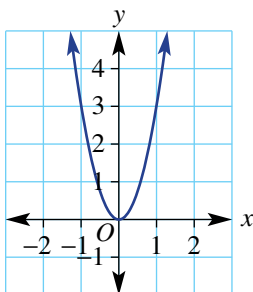

E

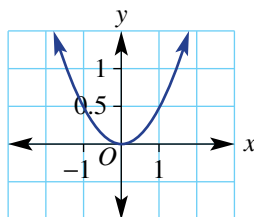

F

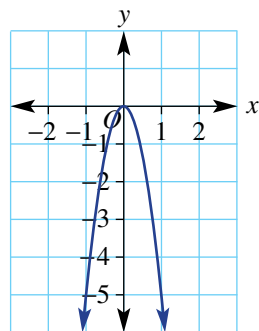

REASONING

6

6, 7

6(1/2), 7-9

6 The graph of $y = -2x^2$ can be obtained from $y = x^2$ by conducting these transformations:

- reflection in the x -axis
- dilation by a factor of 2 from the x -axis.

In the same way as above, describe the two transformations which take:

a $y = x^2$ to $y = -3x^2$

b $y = x^2$ to $y = -6x^2$

c $y = x^2$ to $y = -\frac{1}{2}x^2$

d $y = -x^2$ to $y = 2x^2$

e $y = -x^2$ to $y = 3x^2$

f $y = -x^2$ to $y = \frac{1}{3}x^2$

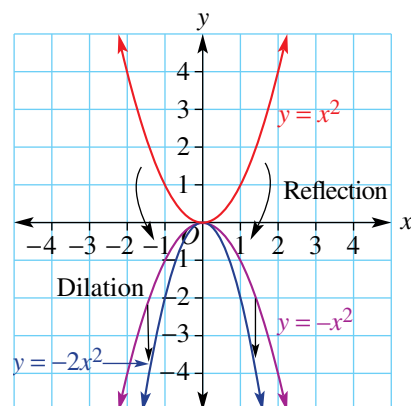

- 7 Write the rule for the graph after each set of transformations.
- The graph of $y = x^2$ is reflected in the x -axis then dilated by a factor of 4 from the x -axis.
 - The graph of $y = -x^2$ is reflected in the x -axis then dilated by a factor of $\frac{1}{3}$ from the x -axis.
 - The graph of $y = 2x^2$ is reflected in the x -axis then dilated by a factor of 2 from the x -axis.
 - The graph of $y = \frac{1}{3}x^2$ is reflected in the x -axis then dilated by a factor of 4 from the x -axis.
- 8 The graph of $y = ax^2$ is reflected in the x -axis and dilated from the x -axis by a given factor. Does it matter which transformation is completed first? Explain.
- 9 The graph of the rule $y = ax^2$ is reflected in the y -axis. What is the new rule of the graph?

ENRICHMENT: Substitute to find the rule

-

-

 $10(1/2), 11$

- 10 If a rule is of the form $y = ax^2$ and it passes through a point, say $(1, 4)$, we can substitute this point to find the value of a .

$$y = ax^2$$

$$4 = a \times (1)^2$$

$$\therefore a = 4 \text{ and } y = 4x^2$$

Use this method to determine the equation of a quadratic relation that has an equation of the form $y = ax^2$ and passes through:

- | | |
|---------------------|----------------------|
| a $(1, 5)$ | b $(1, 7)$ |
| c $(-1, -1)$ | d $(-2, 7)$ |
| e $(-5, 4)$ | f $(3, 26)$ |
| g $(4, 80)$ | h $(-1, -52)$ |
- 11 The rule of the form $y = ax^2$ models the shape of the parabolic cables of the Golden Gate Bridge. If the cable is centred at $(0, 0)$ and the top of the right pylon has the coordinates $(492, 67)$, find a possible equation that describes this shape. The numbers given are in metres.

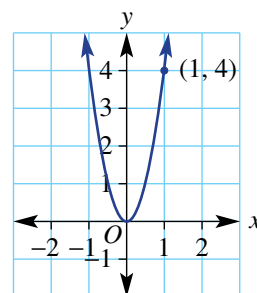

The following problems will investigate practical situations drawing upon knowledge and skills developed throughout the chapter. In attempting to solve these problems, aim to identify the key information, use diagrams, formulate ideas, apply strategies, make calculations and check and communicate your solutions.

Backyard blitz

- 1 Jamie is planning to renovate his rectangular backyard. He wishes to have a rectangular deck that is positioned against the house and a fence and has synthetic grass of width x m, on the other sides as shown. The backyard has dimensions 10 m by 8 m.

The synthetic grass he has chosen costs \$35 per square metre, and the timber for the deck is \$200 per square metre. Jamie's budget is \$4000.

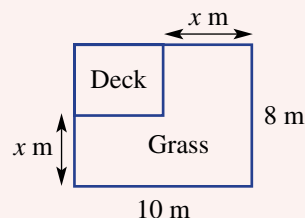

Jamie is investigating possible designs for his backyard by varying the width of the grassed area to suit his budget of \$4000 for the grass and timber materials.

- a Give expressions in metres in terms of x for:
 - i the length (longer side) of the deck
 - ii the width of the deck.
- b Give an expression for the area in expanded and simplified form of:
 - i the deck
 - ii the grassed area.
- c One design Jamie is considering is such that the area of the deck occupies one-tenth of the backyard area.
 - i By solving an appropriate equation, determine the value of x that satisfies this design.
 - ii What is the cost of the synthetic grass for this value of x ?
 - iii Will Jamie come in under budget using this model?
- d Give a rule in terms of x for the cost, $\$C$, of renovating the backyard. Expand and simplify your rule and use it to verify your answer to part c iii.
- e If one quote for the cost of materials is \$5275, use your rule in part d to solve an equation to find the value of x and hence the deck area that gives this quote. (*Hint:* Remove the coefficient of x^2 as the common factor when factorising.)



Computer golf

- 2 A computer game designer is using quadratic rules to model the path of a golf ball for a variety of shot types in a new golf game. Based on the user's selection of club and other parameters, including distance from the hole, a quadratic rule is assigned to simulate their shot. The rule models the ball's path from when it is struck until when it first bounces.

The game designer is in the testing phase and is checking some of the rules for accuracy and to see how they can be manipulated to create other scenarios in the game.

On the easy level of the game, the rules used give the ball a direct path in line with the hole.

One such rule used to model certain pitch shots from the fairway onto the putting green is given by

$y = -\frac{1}{75}x(x - 60)$, where x is the horizontal distance in metres from where the ball was hit and y is the vertical height of the ball above ground in metres.

A pitch shot using this model is taken 80 m from the hole.

- a Use the rule to find:
 - i the height above ground of the ball after it has travelled 15 m horizontally
 - ii the height above ground from which the ball is struck.
- b Use an equation to determine how far from the hole the ball first bounces.
- c Using some of the key points found in parts a and b:
 - i plot a graph showing the path of the ball until it first bounces
 - ii use the graph and symmetry of the flight path to determine how far the ball has travelled horizontally when it reaches its maximum height
 - iii hence use the rule to find the maximum height reached by the ball.

The game designer adds some trees to the golf course for added difficulty. From where the above shot is taken, one particular tree is placed in line with the hole 18 m from where the shot is taken. The tree is 10.8 m high.

- d Using the given rule for the shot simulation, determine if the ball will clear the tree.
- e Different flight paths are obtained by adjusting the rule for the shot.
 - i Adjust the given rule so that the ball is still hit from ground level but first bounces 12 m from the hole.
 - ii Check algebraically whether or not this shot will clear the tree.
- f A water hazard is also placed on the course in line with the ball and the hole. The hazard covers a distance of between 48 m and 55 m from where the shot is being taken. Write a rule that the programmer could use such that the shot lands in the water before it bounces and reaches a maximum height of at least 13 m.



Bridges and barges

- 3 A pre-existing bridge across a river is to be replaced by a new bridge further downstream. The new bridge will be wider to ease traffic congestion. Barges are moved by tugboats under this bridge to deliver cargo to the port. The design of new barges which are being built cannot fit under the current bridge. The new barge is rectangular and has a width of 6 m and a height, including cargo, of 5 m. The current bridge is supported by a parabolic arch and the design is modelled on a Cartesian plane with rule $y = -\frac{1}{2}x^2 + 8$, as shown below. The y -axis indicates the middle of the bridge and the x -axis represents water level. The parabolic arch is at water level at the edges of the river.

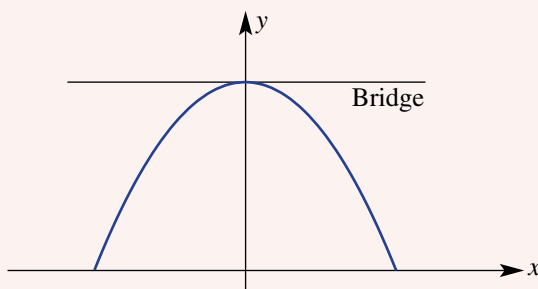

The designer's aim is to keep the current features of the bridge and parabolic arch design, but to ensure that the new barges fit under the bridge.

- a Use the model of the current bridge to determine the height of the bridge above water in the middle of the bridge.
- b By solving an appropriate equation, determine the width of the river.
- c Verify that the new barge design will not be able to pass under the arch of the bridge.

The specifications for the parabolic arch of the new bridge are a maximum height of 8 m and a width of 6 m at a height of 5 m above water level.

- i Draw a model of the new bridge on a set of axes with the y -axis indicating the centre of the bridge and the x -axis at water level.
- ii Find a quadratic rule in the form $y = ax^2 + c$ that fits the arch specifications.

This bridge is placed further down the river where the river is wider.

- iii Using your rule, find the width of this bridge. Answer correct to one decimal place.
- e The bridge designers are looking to the future and decide they should leave more room for extra cargo to fit under the bridge. Find a rule for a parabolic arch under the bridge that will be 10 m high and that will allow the total height above water of the barge to be at least 8 m on a 6 m wide barge.



10G Sketching translations of $y = x^2$

LEARNING INTENTIONS

- To understand what it means for a graph to be translated
- To know what causes a graph to be translated vertically and horizontally
- To understand the turning point form of a quadratic equation
- To be able to sketch a graph of a quadratic equation expressed in turning point form, labelling the turning point and y -intercept

As well as reflection and dilation, there is a third type of transformation called translation. Translation involves a shift of every point on the graph horizontally and/or vertically. Unlike reflections and dilations, a translation alters the coordinates of the turning point. The shape of the curve is unchanged, but its position in relation to the origin is altered.



Manufacturers employ mathematicians to develop profit equations, which are quadratics when sales and profit per item are linear relations of the selling price. As the selling price increases, profit increases to the parabola's maximum point and then decreases.

Lesson starter: Which way: Left, right, up or down?

This table and graph shows the quadratics $y = x^2$, $y = (x - 2)^2$, $y = (x + 1)^2$, $y = x^2 - 4$ and $y = x^2 + 2$. The table could also be produced using technology.

x	-3	-2	-1	0	1	2	3
$y = x^2$	9	4	1	0	1	4	9
$y = (x - 2)^2$	25	16	9	4	1	0	1
$y = (x + 1)^2$	4	1	0	1	4	9	16
$y = x^2 - 4$	5	0	-3	-4	-3	0	5
$y = x^2 + 2$	11	6	3	2	3	6	11

- Discuss what effect the different numbers in the rules had on the y -values in the table.
- Also discuss what effect the numbers in the rules have on each graph. How are the coordinates of the turning point changed?
- What conclusions could you draw on the effect of h in the rule $y = (x - h)^2$?
- What conclusions could you draw on the effect of k in the rule $y = x^2 + k$?
- What if the rule was $y = -x^2 + 2$ or $y = -(x + 1)^2$? Describe how the graphs would look.

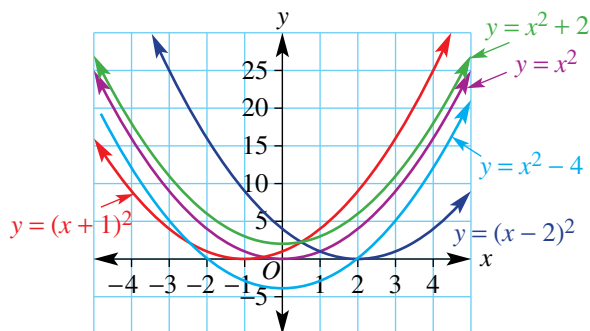

KEY IDEAS

■ A **translation** of a graph involves a shift of every point horizontally and/or vertically.

■ Vertical translations: $y = x^2 + k$

- If $k > 0$, the graph is translated k units up (red curve).
- If $k < 0$, the graph is translated k units down (green curve).
- The turning point is $(0, k)$ for all curves.
- The axis of symmetry is the line $x = 0$ for all curves.
- The y -intercept is $(0, k)$ for all curves.

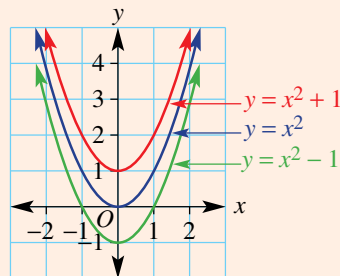

■ Horizontal translations: $y = (x - h)^2$

If $h > 0$, the graph is translated h units to the right.

If $h < 0$, the graph is translated h units to the left.

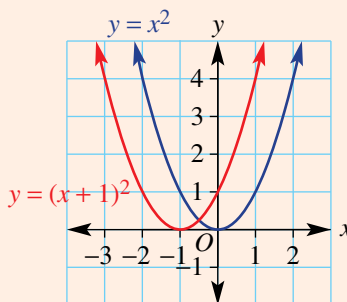
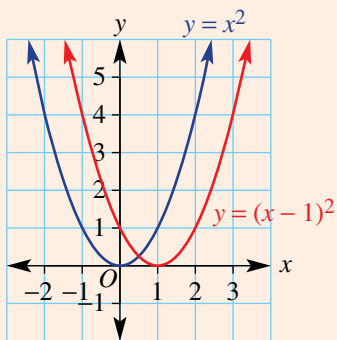

- The turning point is $(h, 0)$ in both cases.
- The axis of symmetry is the line $x = h$ in both cases.
- The y -intercept is $(0, h^2)$ in both cases.

■ The **turning point form** of a quadratic is given by:

$y = a(x - h)^2 + k$

$a > 0$ upright (concave up) graph \cup

$a < 0$ graph inverted (concave down) \cap

Translates the graph left or right:
 $h > 0 \rightarrow$
 $h < 0 \leftarrow$

Translates the graph up or down:
 $k > 0 \uparrow$ $k < 0 \downarrow$

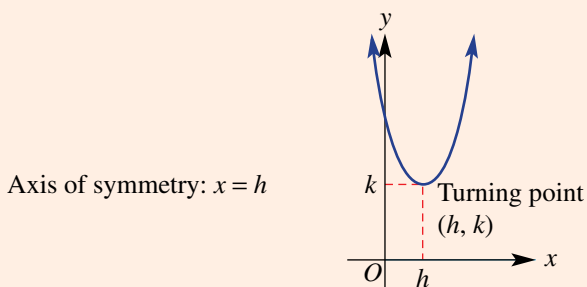

- To sketch a graph of a quadratic equation in turning point form, follow these steps.

- Draw and label a set of axes.
- Identify important points including the turning point and y-intercept.
- Sketch the curve connecting the key points and making the curve symmetrical.

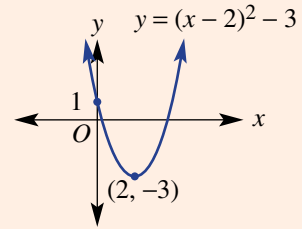

BUILDING UNDERSTANDING

- 1 This diagram shows the graphs of $y = x^2$, $y = -x^2$, $y = (x + 2)^2$ and $y = -(x - 3)^2$.

- a State the coordinates of the turning point of the graph of:

i $y = (x + 2)^2$

ii $y = -(x - 3)^2$

- b Compared to the graph of $y = x^2$, which way has the graph of $y = (x + 2)^2$ been translated (left or right)?

- c Compared to the graph of $y = -x^2$ which way has the graph of $y = -(x - 3)^2$ been translated (left or right)?

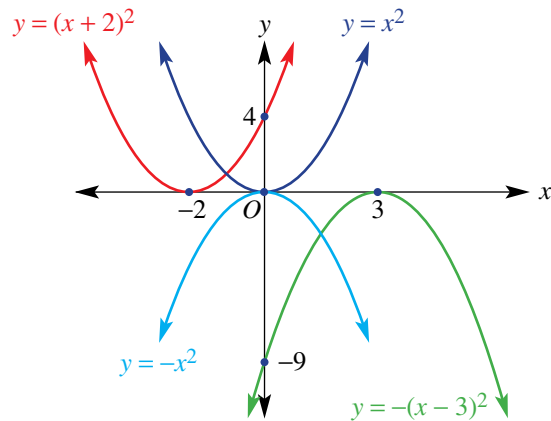

- 2 This diagram shows the graphs of $y = x^2$, $y = -x^2$, $y = x^2 - 3$ and $y = -x^2 + 2$.

- a State the coordinates of the turning point of the graph of:

i $y = x^2 - 3$

ii $y = -x^2 + 2$

- b Compared to the graph of $y = x^2$, which way has the graph of $y = x^2 - 3$ been translated (up or down)?
- c Compared to the graph of $y = -x^2$, which way has the graph of $y = -x^2 + 2$ been translated (up or down)?

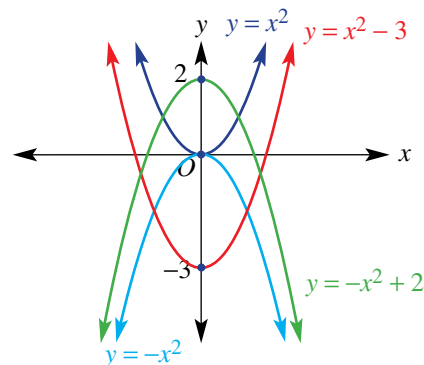

- 3 Substitute $x = 0$ to find the coordinates of the y-intercept for these rules.

a $y = x^2 + 3$

b $y = -x^2 - 4$

c $y = -(x - 2)^2$

d $y = (x + 5)^2$

Example 13 Sketching with horizontal and vertical translations

Sketch the graphs of these rules showing the y -intercept and the coordinates of the turning point.

a $y = x^2 + 2$

b $y = -x^2 - 1$

c $y = (x - 3)^2$

d $y = -(x + 2)^2$

SOLUTION

a $y = x^2 + 2$

Turning point is $(0, 2)$.

y -intercept ($x = 0$): $y = (0)^2 + 2 = 2$

$\therefore (0, 2)$

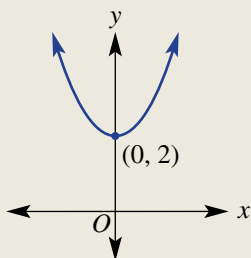

b $y = -x^2 - 1$

Turning point is $(0, -1)$.

y -intercept ($x = 0$): $y = -(0)^2 - 1 = -1$

$\therefore (0, -1)$

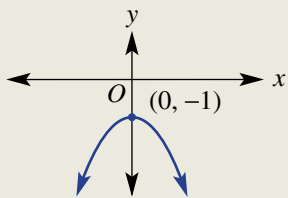

c $y = (x - 3)^2$

Turning point is $(3, 0)$.

y -intercept ($x = 0$): $y = (0 - 3)^2$

$= (-3)^2$

$= 9$

$\therefore (0, 9)$

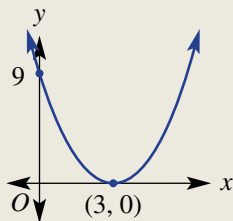

EXPLANATION

For $y = x^2 + k$, $k = 2$, so the graph of $y = x^2$ is translated 2 units up.

The point $(0, 0)$ shifts to $(0, 2)$.

The graph of $y = -x^2$ is a reflection of the graph of $y = x^2$ in the x -axis.

For $y = -x^2 + k$, $k = -1$ so the graph of $y = -x^2$ is translated down 1 unit.

For $y = (x - h)^2$, $h = 3$, so the graph of $y = x^2$ is translated 3 units to the right.

The y -intercept is found by substituting $x = 0$ into the rule.

d $y = -(x + 2)^2$
 Turning point is $(-2, 0)$.
 y-intercept ($x = 0$): $y = -(0 + 2)^2$
 $= -(2)^2$
 $= -4$
 $\therefore (0, -4)$

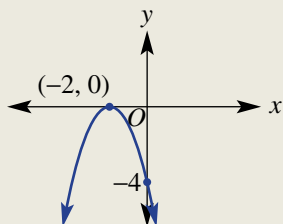

For $y = -(x - h)^2$, $h = -2$ since
 $-(x - (-2))^2 = -(x + 2)^2$. So the graph of
 $y = -x^2$ is translated 2 units to the left.
 The y-intercept is found by substituting $x = 0$.

The negative sign in front means the graph is inverted.

Now you try

Sketch the graphs of these rules showing the y-intercept and the coordinates of the turning point.

a $y = x^2 + 4$

b $y = -x^2 - 2$

c $y = (x - 1)^2$

d $y = -(x + 3)^2$



Example 14 Sketching with combined translations

Sketch these graphs showing the y-intercept and the coordinates of the turning point.

a $y = (x - 2)^2 - 1$

b $y = -(x + 3)^2 + 2$

SOLUTION

a $y = (x - 2)^2 - 1$

Turning point is $(2, -1)$.

y-intercept ($x = 0$): $y = (0 - 2)^2 - 1$
 $= 4 - 1$
 $= 3$
 $\therefore (0, 3)$

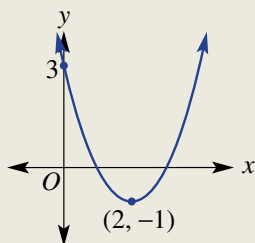

EXPLANATION

For $y = (x - h)^2 + k$, $h = 2$ and $k = -1$, so the graph of $y = x^2$ is shifted 2 to the right and 1 down.

Substitute $x = 0$ for the y-intercept.

First, position the coordinates of the turning point and y-intercept, then join to form the curve.

Continued on next page

b $y = -(x + 3)^2 + 2$

Turning point is $(-3, 2)$.

y-intercept ($x = 0$): $y = -(0 + 3)^2 + 2$

$$= -9 + 2$$

$$= -7$$

$$\therefore (0, -7)$$

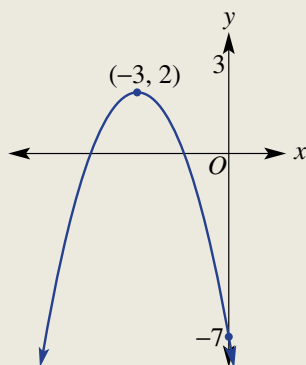

For $y = -(x - h)^2 + k$, $h = -3$ and $k = 2$, so the graph of $y = x^2$ is shifted 3 to the left and 2 up.

First, position the coordinates of the turning point and y-intercept then join to form the curve.

Now you try

Sketch these graphs showing the y-intercept and the coordinates of the turning point.

a $y = (x - 3)^2 - 2$

b $y = -(x + 2)^2 + 1$

Exercise 10G

FLUENCY

$1-3, 4(\frac{1}{2})$

$1-2(\frac{1}{2}), 3, 4(\frac{1}{2})$

$1-2(\frac{1}{2}), 4(\frac{1}{2})$

- 1 Sketch the graphs of these rules showing the y-intercept and the coordinates of the turning point.

Example 13a

a $y = x^2 + 1$

b $y = x^2 + 3$

c $y = x^2 - 2$

Example 13b

d $y = -x^2 + 4$

e $y = -x^2 + 1$

f $y = -x^2 - 5$

- 2 Sketch the graphs of these rules showing the y-intercept and the coordinates of the turning point.

Example 13c

a $y = (x - 2)^2$

b $y = (x - 4)^2$

c $y = (x + 3)^2$

Example 13d

d $y = -(x - 3)^2$

e $y = -(x + 6)^2$

f $y = -(x + 2)^2$

- 3 The below diagram shows the graphs of $y = x^2$, $y = -x^2$, $y = -(x - 2)^2 + 3$ and $y = (x + 1)^2 - 1$.

- a** State the coordinates of the turning point of the graph of:

i $y = -(x - 2)^2 + 3$

ii $y = (x + 1)^2 - 1$

- b** State the missing words and numbers.

- i** Compared to the graph of $y = x^2$, the graph of $y = (x + 1)^2 - 1$ has to be translated _____ unit to the _____ and _____ unit _____.

- ii** Compared to the graph of $y = -x^2$, the graph of $y = -(x - 2)^2 + 3$ has to be translated _____ units to the _____ and _____ units _____.

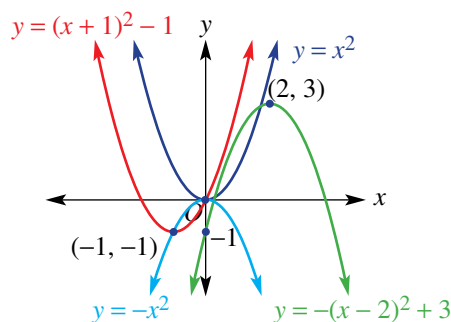

Example 14

4 Sketch each graph showing the y-intercept and the coordinates of the turning point.

a $y = (x - 3)^2 + 2$

b $y = (x - 1)^2 - 1$

c $y = (x + 2)^2 - 3$

d $y = (x + 1)^2 + 7$

e $y = -(x - 2)^2 + 1$

f $y = -(x - 5)^2 + 3$

g $y = -(x + 3)^2 - 4$

h $y = -(x + 1)^2 - 5$

i $y = -(x - 3)^2 - 6$

PROBLEM-SOLVING

5

5, 6

5, 6(1/2), 7

5 Match each parabola with the appropriate equation from the list below.

a $y = x^2$

b $y = (x + 2)^2$

c $y = x^2 - 4$

d $y = -x^2 - 3$

e $y = (x - 2)^2$

f $y = x^2 + 4$

g $y = 4 - x^2$

h $y = (x + 3)^2$

i $y = (x - 5)^2$

j $y = x^2 + 3$

k $y = -(x + 3)^2$

l $y = -x^2 + 3$

A

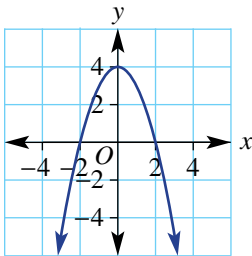

B

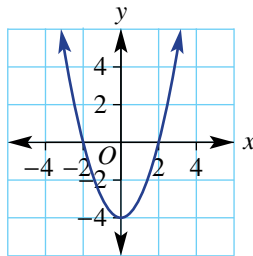

C

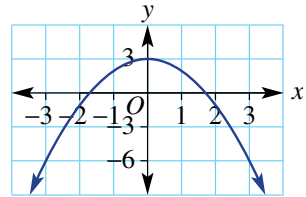

D

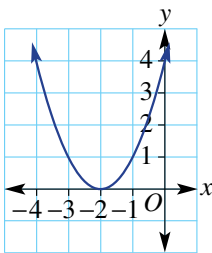

E

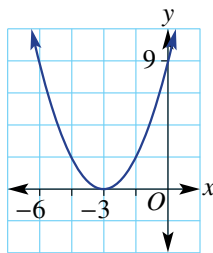

F

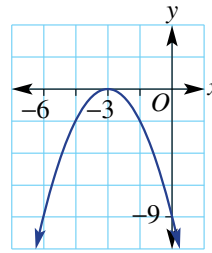

G

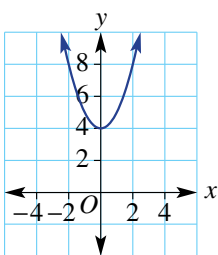

H

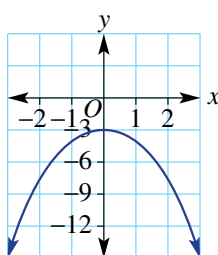

I

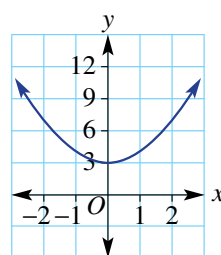

J

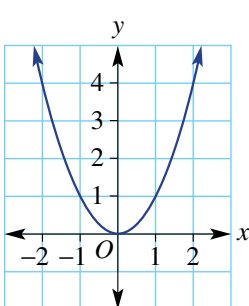

K

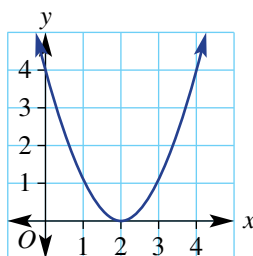

L

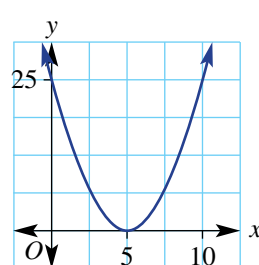

6 Write the rule for each graph in the turning point form: $y = (x - h)^2 + k$.

a

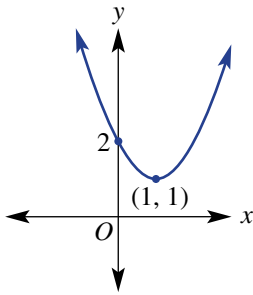

b

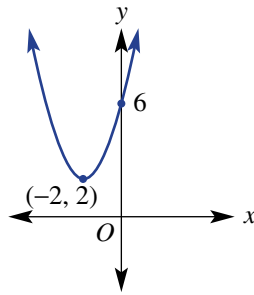

c

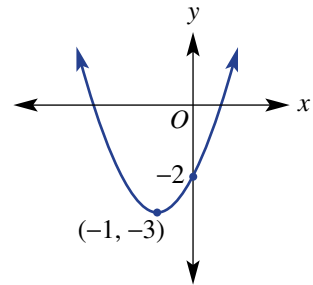

d

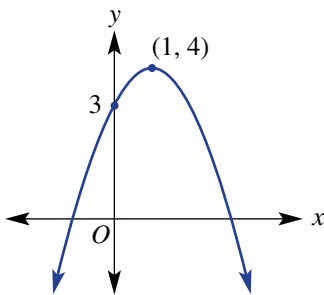

e

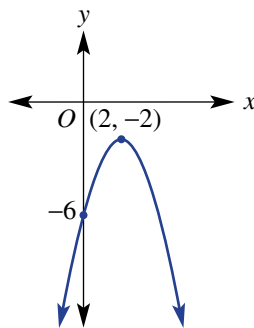

f

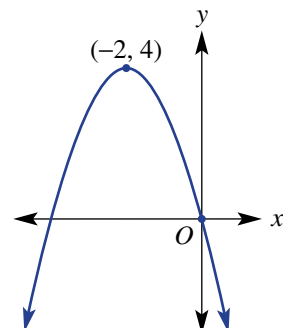

7 A bike track can be modelled approximately by combining two different quadratic equations.

The first part of the bike path can be modelled by the equation $y = -(x - 2)^2 + 9$ for $-2 \leq x \leq 5$.

The second part of the bike track can be modelled by the equation $y = (x - 7)^2 - 4$ for $5 \leq x \leq 10$.

a Find the turning point of the graph of each quadratic equation.

b Sketch each graph on the same set of axes. On your sketch of the bike path you need to show the coordinates of the start and finish of the track and where it crosses the x -axis.



REASONING

8

8, 9

9, 10

- 8 Written in the form $y = a(x - h)^2 + k$, the rule $y = 4 - (x + 2)^2$ could be rearranged to give $y = -(x + 2)^2 + 4$.
- a Rearrange these rules and write in the form $y = a(x - h)^2 + k$.
- $y = 3 - (x + 1)^2$
 - $y = 4 + (x + 3)^2$
 - $y = -3 + (x - 1)^2$
 - $y = -7 - (x - 5)^2$
 - $y = -2 - x^2$
 - $y = -6 + x^2$
- b Write down the coordinates of the turning point for each of the above quadratics.
- 9 A quadratic has the rule $y = a(x - h)^2 + k$.
- What are the coordinates of the turning point?
 - Write an expression for the y -coordinate of the y -intercept.
- 10 Investigate and explain how the graph of:
- $y = (2 - x)^2$ compares to the graph of $y = (x - 2)^2$
 - $y = (1 - x)^2$ compares to the graph of $y = (x - 1)^2$.

ENRICHMENT: Finding rules

-

-

11-14($\frac{1}{2}$)

- 11 Find the equation of the quadratic relation which is of the form $y = x^2 + c$ and passes through:
- (1, 4)
 - (3, 5)
 - (2, 1)
 - (2, -1)
- 12 Find the equation of the quadratic relation which is of the form $y = -x^2 + c$ and passes through:
- (1, 3)
 - (-1, 3)
 - (3, 15)
 - (-2, 6)
- 13 Find the possible equations of each of the following quadratics if their equation is of the form $y = (x - h)^2$ and their graph passes through the point:
- (1, 16)
 - (3, 1)
 - (-1, 9)
 - (3, 9)
- 14 Find the rule for each of these graphs with the given turning point (TP) and y -intercept.
- TP = (1, 1), y -intercept = (0, 0)
 - TP = (-2, 0), y -intercept = (0, 4)
 - TP = (3, 0), y -intercept = (0, -9)
 - TP = (-3, 2), y -intercept = (0, -7)
 - TP = (-1, 4), y -intercept = (0, 5)
 - TP = (3, -9), y -intercept = (0, 0)

10H Sketching parabolas using intercept form

LEARNING INTENTIONS

- To understand how a parabola can have 0, 1 or 2 x -intercepts
- To be able to find the x -intercepts of a quadratic graph by solving an equation using the Null Factor Law
- To know how to use symmetry and the x -intercepts to help locate the turning point
- To be able to sketch a quadratic graph in expanded form using factorisation

So far we have sketched parabolas using rules of the form $y = a(x - h)^2 + k$ where the coordinates of the turning point can be determined directly from the rule. An alternative method for sketching parabolas uses the factorised form of the quadratic rule and the Null Factor Law to find the x -intercepts. The turning point can be found by considering the axis of symmetry, which sits halfway between the two x -intercepts.



Parallel lines reflected from a parabola, and parallel light or radio waves reflected from a parabolic dish, meet at a focal point above the vertex. Scientists use CSIRO's six radio telescopes, with parabolic dishes, to research objects in outer space.

Lesson starter: From x -intercepts to turning point

This graph has the rule $y = x^2 - 2x - 3$ but all its important features are not shown.

Find the features by discussing these questions.

- Can the quadratic rule be factorised?
- What is the value of y at the x -intercepts?
- How can the factorised form of the rule help to find the x -intercepts?
- How does the x -coordinate of the turning point relate to the x -intercepts?
- Discuss how the y -coordinate of the turning point can be found.
- Finish by finding the y -intercept.

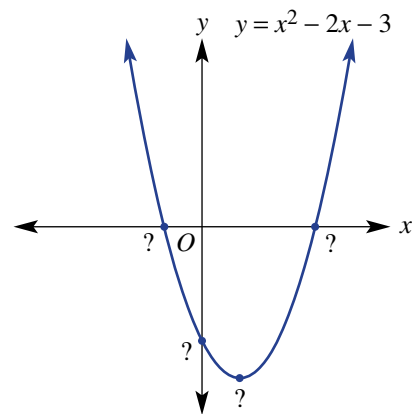

KEY IDEAS

- All parabolas have one y -intercept and can have zero, one or two x -intercepts.

Zero x -intercepts

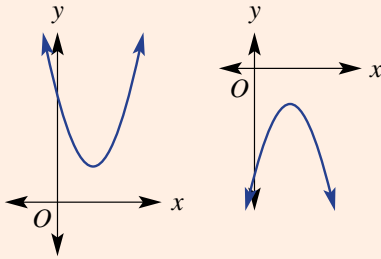

One x -intercept

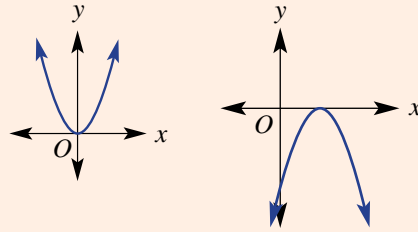

Two x -intercepts

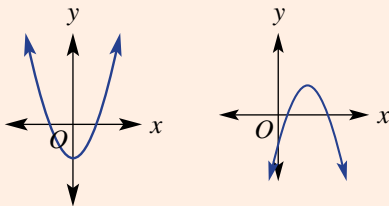

- x -intercepts can be found by substituting $y = 0$ and using the Null Factor Law.
- If the graph has two x -intercepts (at $x = a$ and $x = b$), the turning point can be found by:
 - calculating the x -coordinate of the turning point, which is the midpoint of a and b ; that is, $x = \frac{a+b}{2}$
 - calculating the y -coordinate of the turning point by substituting the x -coordinate into the rule for the quadratic.

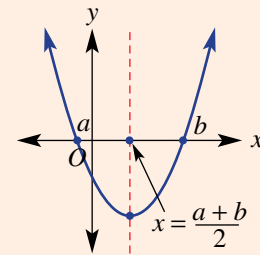

$$y = (x - a)(x - b)$$

x -intercepts: $0 = (x - a)(x - b)$
 $x - a = 0$ or $x - b = 0$
 $x = a$ or $x = b$

BUILDING UNDERSTANDING

- 1 Factorise these quadratics.

a $x^2 + 2x$

b $x^2 - 3x$

c $x^2 - 9$

d $x^2 - 49$

e $x^2 - x - 12$

f $x^2 - 4x + 4$

- 2 For these factorised quadratics, use the Null Factor Law to solve for x , then find the x -value halfway between the two values.

a $0 = (x - 2)(x + 2)$

b $0 = (x + 1)(x + 5)$

c $0 = (x - 1)(x + 3)$

d $0 = (x - 2)(x + 3)$

- 3 Use substitution to find the y -coordinate of the turning point of these quadratics. The x -coordinate of the turning point is given.

a $y = x^2 - 4, x = 0$

b $y = x^2 - 6x, x = 3$

c $y = x^2 + 4x + 3, x = -2$



Example 15 Finding intercepts of quadratic graphs

For each of the following quadratic relations, find:

- i the coordinates of the x -intercepts
 - ii the coordinates of the y -intercept.
- a** $y = x(x + 1)$
- b** $y = 2(x + 2)(x - 3)$

SOLUTION

- a i** x -intercepts (let $y = 0$):

$$x(x + 1) = 0$$

$$x = 0 \text{ or } x + 1 = 0$$

$$x = 0 \text{ or } x = -1$$

$$\therefore (0, 0) \text{ and } (-1, 0)$$

- ii** y -intercept (let $x = 0$):

$$y = 0(0 + 1)$$

$$y = 0$$

$$\therefore (0, 0)$$

- b i** $y = 2(x + 2)(x - 3)$ has two x -intercepts.

x -intercepts (let $y = 0$):

$$2(x + 2)(x - 3) = 0$$

$$x + 2 = 0 \text{ or } x - 3 = 0$$

$$x = -2 \text{ or } x = 3$$

$$\therefore (-2, 0) \text{ and } (3, 0)$$

- ii** y -intercept (let $x = 0$):

$$y = 2(0 + 2)(0 - 3)$$

$$y = 2(2)(-3)$$

$$y = -12$$

$$\therefore (0, -12)$$

EXPLANATION

Let $y = 0$ to find the x -intercepts.

Apply the Null Factor Law to set each factor equal to 0 and solve.

Let $x = 0$ to find the y -intercept.

There are two different factors.

Let $y = 0$ to find the x -intercepts. Set each factor equal to 0 and solve.

Let $x = 0$ to find the y -intercept.

Now you try

For each of the following quadratic relations, find:

- i the coordinates of the x -intercepts
 - ii the coordinates of the y -intercept.
- a** $y = x(x + 5)$
- b** $y = 3(x + 1)(x - 4)$



Example 16 Sketching using intercept form

Consider the quadratic relation $y = x^2 - 2x$.

- | | |
|---|---|
| a Find the coordinates of the y -intercept. | b Factorise the relation. |
| c Find the coordinates of the x -intercepts. | d Find the axis of symmetry. |
| e Find the turning point. | f Sketch the graph clearly showing all the key features. |

SOLUTION

a y -intercept (let $x = 0$): $y = 0$

$$\therefore (0, 0)$$

b $y = x^2 - 2x$
 $= x(x - 2)$

c x -intercepts (let $y = 0$):

$$0 = x(x - 2)$$

$$x = 0 \text{ or } x - 2 = 0$$

$$x = 0 \text{ or } x = 2$$

$$\therefore (0, 0) \text{ and } (2, 0)$$

d Axis of symmetry: $x = \frac{0+2}{2}$
 $\therefore x = 1$

e Turning point occurs when $x = 1$.

$$\text{When } x = 1, y = (1)^2 - 2(1)$$

$$y = -1$$

\therefore there is a minimum turning point at $(1, -1)$.

f

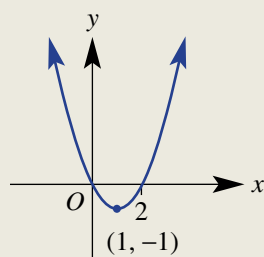

EXPLANATION

Let $x = 0$ to find the y -intercept.

Take out the common factor of x .

Let $y = 0$ to find the x -intercepts. Set each factor equal to 0 and solve.

The axis of symmetry is halfway between the x -intercepts.

Substitute $x = 1$ into $y = x^2 - 2x$ to find the y -coordinate.

$$x = 1 \text{ and } y = -1$$

The coefficient of x^2 is positive, therefore the basic shape is .

Sketch the graph, labelling the key features found above.

Now you try

Consider the quadratic relation $y = x^2 - 4x$.

- | | |
|---|---|
| a Find the coordinates of the y -intercept. | b Factorise the relation. |
| c Find the coordinates of the x -intercepts. | d Find the axis of symmetry. |
| e Find the turning point. | f Sketch the graph clearly showing all the key features. |



Example 17 Sketching a quadratic trinomial

Consider the quadratic relation $y = x^2 + 2x - 8$.

- | | |
|---|---|
| a Find the coordinates of the y -intercept. | b Factorise the relation. |
| c Find the coordinates of the x -intercepts. | d Find the axis of symmetry. |
| e Find the turning point. | f Sketch the graph clearly showing all the key features. |

SOLUTION

a y -intercept (let $x = 0$): $y = -8$

$$\therefore (0, -8)$$

b $y = x^2 + 2x - 8$

$$= (x + 4)(x - 2)$$

c x -intercepts (let $y = 0$):

$$0 = (x + 4)(x - 2)$$

$$x + 4 = 0 \text{ or } x - 2 = 0$$

$$x = -4 \text{ or } x = 2$$

$$\therefore (-4, 0) \text{ and } (2, 0)$$

d Axis of symmetry: $x = \frac{-4 + 2}{2}$

$$\therefore x = -1$$

e Turning point occurs when $x = -1$.

$$\text{When } x = -1, y = (-1)^2 + 2(-1) - 8$$

$$y = -9$$

\therefore there is a minimum turning point at $(-1, -9)$.

f

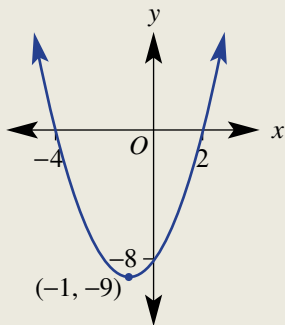

EXPLANATION

Let $x = 0$ to find the y -intercept.

Factorise the quadratic trinomial:

$$4 \times (-2) = -8 \text{ and } 4 + (-2) = 2.$$

Let $y = 0$ to find the x -intercepts.

The axis of symmetry is halfway between the x -intercepts.

Substitute $x = -1$ into $y = x^2 + 2x - 8$ to find the

$$y\text{-coordinate. } y = 1 - 2 - 8$$

$$x = -1 \text{ and } y = -9$$

The coefficient of x^2 is positive, therefore the basic shape is

Sketch the graph showing the key features.

Now you try

Consider the quadratic relation $y = x^2 - 4x - 12$.

- | | |
|---|---|
| a Find the coordinates of the y -intercept. | b Factorise the relation. |
| c Find the coordinates of the x -intercepts. | d Find the axis of symmetry. |
| e Find the turning point. | f Sketch the graph clearly showing all the key features. |

Exercise 10H

FLUENCY

1–3(1/2)

1–4(1/2)

1–4(1/3)

Example 15

- 1 For each of the following quadratic relations, find:
- | | | |
|--|---|------------------------|
| i the coordinates of the x -intercepts | ii the coordinates of the y -intercept. | |
| a $y = x(x + 7)$ | b $y = x(x + 3)$ | c $y = x(x + 4)$ |
| d $y = (x - 4)(x + 2)$ | e $y = (x + 2)(x - 5)$ | f $y = (x - 7)(x + 3)$ |
| g $y = 2(x + 3)(x - 1)$ | h $y = 3(x + 4)(x + 1)$ | i $y = (2 - x)(3 - x)$ |

Example 16

- 2 Consider each of the following quadratic relations.
- | | | |
|--|---|--|
| i Find the coordinates of the y -intercept. | ii Factorise the relation. | |
| iii Find the coordinates of the x -intercepts. | iv Find the axis of symmetry. | |
| v Find the turning point. | vi Sketch the graph clearly showing all the key features. | |
- | | | |
|-------------------|-------------------|------------------|
| a $y = x^2 - 5x$ | b $y = x^2 + x$ | c $y = x^2 - 3x$ |
| d $y = 2x + x^2$ | e $y = 5x + x^2$ | f $y = 3x - x^2$ |
| g $y = -x^2 - 8x$ | h $y = -2x - x^2$ | i $y = -x^2 + x$ |

Example 17

- 3 Consider each of the following quadratic relations.
- | | | |
|--|--|--|
| i Find the coordinates of the y -intercept. | ii Factorise the relation. | |
| iii Find the coordinates of the x -intercepts. | iv Find the axis of symmetry. | |
| v Find the turning point. | vi Sketch each graph clearly showing all the key features. | |
- | | | |
|----------------------|----------------------|----------------------|
| a $y = x^2 - 3x + 2$ | b $y = x^2 - 4x + 3$ | c $y = x^2 + 2x - 3$ |
| d $y = x^2 + 4x + 4$ | e $y = x^2 + 2x + 1$ | f $y = x^2 + 2x - 8$ |
- 4 For each of the following relations, sketch the graph, clearly showing the x - and y -intercepts and the turning point.
- | | | |
|----------------------|----------------------|----------------------|
| a $y = x^2 - 1$ | b $y = 9 - x^2$ | c $y = x^2 + 5x$ |
| d $y = 2x^2 - 6x$ | e $y = 4x^2 - 8x$ | f $y = x^2 - 3x - 4$ |
| g $y = x^2 + x - 12$ | h $y = x^2 + 2x + 1$ | i $y = x^2 - 6x + 9$ |

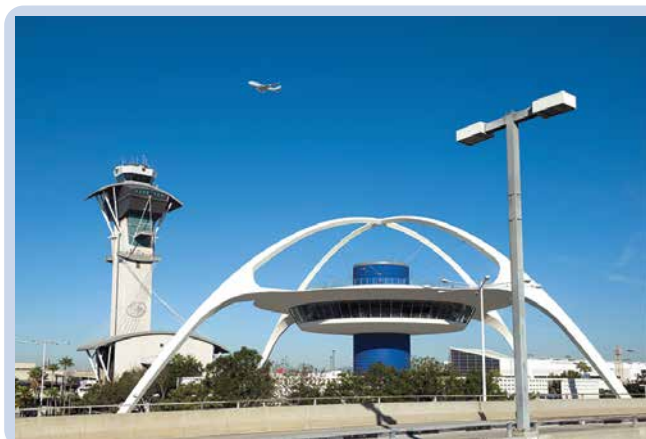

Design structures, such as this building at LAX airport, can be modelled on a set of axes.

PROBLEM-SOLVING

5

5, 6

5($\frac{1}{2}$), 6, 7

5 State the missing number (?) in these quadratic graphs.

a

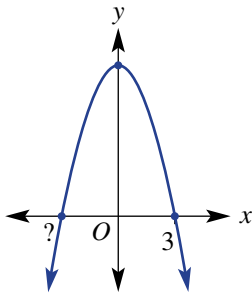

b

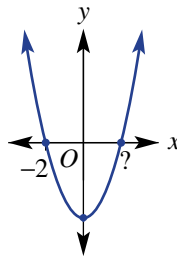

c

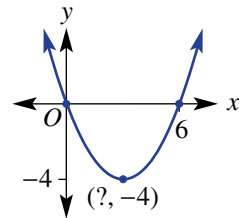

d

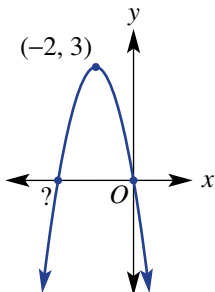

e

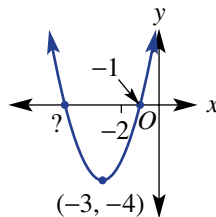

f

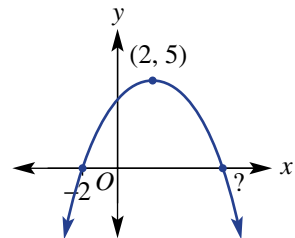

6 The path of a golf ball is given by the rule $y = 30x - x^2$, where y is the height in metres above the ground and x is the horizontal distance in metres. Find:

- a how far the ball travels horizontally
b how high the ball reaches mid-flight.

7 A test rocket is fired and follows a path described by $y = 0.1x(200 - x)$. The height is y metres above ground and x is the horizontal distance in metres.

- a How far does the rocket travel horizontally?
b How high does the rocket reach mid-flight?



REASONING

8

8, 9

9, 10

8 Explain why the coordinates of the x -intercept and the turning point for $y = (x - 2)^2$ are the same.

9 Write down an expression for the y -coordinate of the y -intercept for these quadratics.

a $y = ax^2 + bx + c$

b $y = (x - a)(x - b)$

10 $y = x^2 - 2x - 15$ can also be written in the form $y = (x - 1)^2 - 16$.

- a Use the second rule to state the coordinates of the turning point.
b Use the first rule to find the x -intercepts then the turning point. Check you get the same result.
c $y = x^2 - 4x - 45$ can be written in the form $y = (x - h)^2 + k$. Find the value of h and k .

ENRICHMENT: Rule finding using x -intercepts - - 11($\frac{1}{2}$)

11 Find the rule for these graphs using intercept form. The first one is done for you.

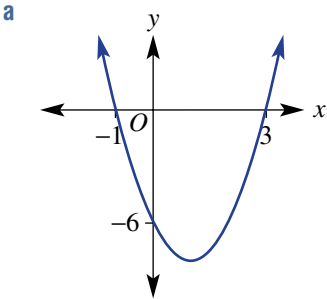

$$y = a(x + 1)(x - 3)$$

Substitute (0, -6) $-6 = a(0 + 1)(0 - 3)$

$$-6 = a(1) \times (-3)$$

$$-6 = -3a$$

$$a = 2$$

$$\therefore y = 2(x + 1)(x - 3)$$

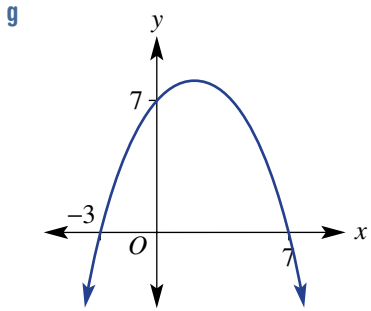
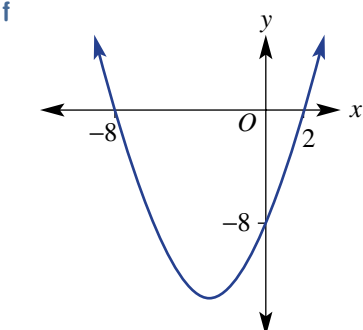
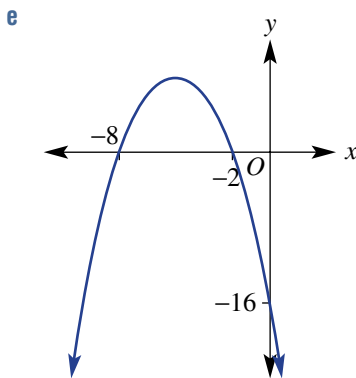
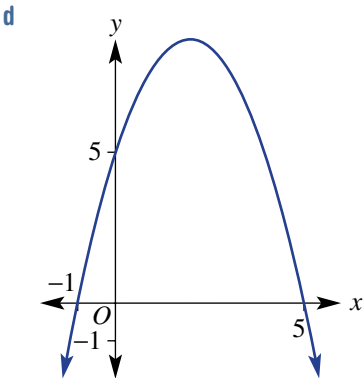
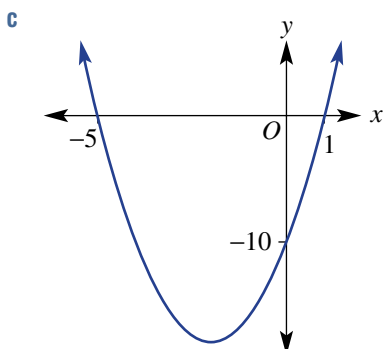
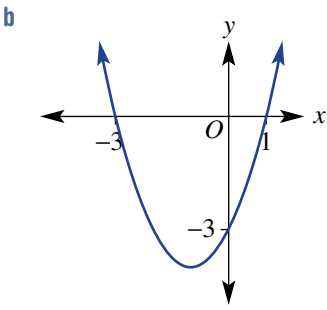

Bridge support arch

Parabolic shapes are often used as bridge arches due to their self-supporting properties. Using the coordinates $(0, 0)$ for one side of a bridge arch, a model for a bridge parabolic curve is given by $y = kx(a - x)$ where:

- y metres is the vertical distance above water level
- x metres is the horizontal distance from the left-hand side
- a and k are positive numbers.



Present a report for the following tasks and ensure that you show clear mathematical workings and explanations where appropriate.

Preliminary task

- If $k = 0.5$ and $a = 30$:
 - construct the rule connecting y and x
 - sketch a graph representing the bridge arch by firstly finding the x -intercepts
 - determine the maximum height of the arch.
- Repeat part **a** for $k = 0.2$ and $a = 50$.

Modelling task

- | | | | | | |
|----------------------------|--|--------------------------|----------------------------|-------------------|-------------------|
| Formulate | <ol style="list-style-type: none"> The problem is to determine a rule of a new bridge design which clears a river of a certain width and has a maximum arch height of less than or equal to 40 metres. Write down all the relevant information that will help solve this problem with the aid of a rough sketch. Construct the rule connecting y and x using the following values for a and k. <table border="0" style="width: 100%;"> <tr> <td style="width: 50%;">i $a = 50$ and $k = 0.1$</td> <td style="width: 50%;">ii $a = 70$ and $k = 0.02$</td> </tr> </table> | i $a = 50$ and $k = 0.1$ | ii $a = 70$ and $k = 0.02$ | | |
| i $a = 50$ and $k = 0.1$ | ii $a = 70$ and $k = 0.02$ | | | | |
| Solve | <ol style="list-style-type: none"> If $a = 50$ and $k = 0.1$, sketch a graph of the bridge arch by locating and labelling the following: <table border="0" style="width: 100%;"> <tr> <td style="width: 50%;">i x-intercepts</td> <td style="width: 50%;">ii turning point.</td> </tr> </table> Decide if an arch that is designed using $a = 50$ and $k = 0.1$ meets the requirement that the maximum height is to be less than or equal to 40 metres. If $a = 70$ and $k = 0.02$, sketch a graph of the bridge arch by locating and labelling the following: <table border="0" style="width: 100%;"> <tr> <td style="width: 50%;">i x-intercepts</td> <td style="width: 50%;">ii turning point.</td> </tr> </table> Decide if an arch that is designed using $a = 70$ and $k = 0.02$ meets the requirement that the maximum height is to be less than or equal to 40 metres. | i x -intercepts | ii turning point. | i x -intercepts | ii turning point. |
| i x -intercepts | ii turning point. | | | | |
| i x -intercepts | ii turning point. | | | | |
| Evaluate and verify | <ol style="list-style-type: none"> Choose your own values of a and k so that a bridge that spans a 60 metre-wide river has a maximum arch height of less than 40 metres. Justify your choice by showing your calculations and a graph. Choose your own values of a and k so that a bridge that spans a 60 metre-wide river has a maximum arch height of exactly 40 metres. Justify your choice by showing your calculations and a graph. | | | | |
| Communicate | <ol style="list-style-type: none"> Summarise your results and describe any key findings. | | | | |

Extension questions

- Show that the rule for k in terms of a is $k = \frac{160}{a^2}$ if the maximum height of the arch is to be 40 metres.
- Use the rule for k in part **a** to determine the value of k if the width of the river is 100 m.
- Use the rule for k in part **a** to determine the width of the river, correct to one decimal place, if $k = 0.3$.

Modelling the bridge

Key technology: Graphing

A parabola is a graph of a quadratic relation and is a shape that appears in many natural settings but also in building and design. For example, the path of an object through the air can be modelled using a parabola. They can also be seen in complex engineering structures including self-supporting arches and bridges.

1 Getting started

We will start by considering the key features of the graphs of the following parabolas.

i $y = x^2$

ii $y = -2x^2$

iii $y = (x + 2)^2 - 4$

iv $y = -\frac{1}{2}(x - 1)^2 + 3$

For each parabola state the:

- coordinates of the turning point
- equation of the axis of symmetry
- coordinates of the y-intercept.

2 Using technology

We will explore the effect of the pronumerals a , h and k in $y = a(x - h)^2 + k$ by using a graphing package like Desmos.

- Set up a page using the four rules $y = ax^2$, $y = x^2 + k$, $y = (x - h)^2$ and $y = a(x - h)^2 + k$ adding sliders for a , h and k .
- Drag the sliders for the three pronumerals and describe the effect of changing each value on the graph.
- Drag the sliders to find a parabola which has a maximum turning point at $(2, 4)$ and a y-intercept of $(0, -2)$.

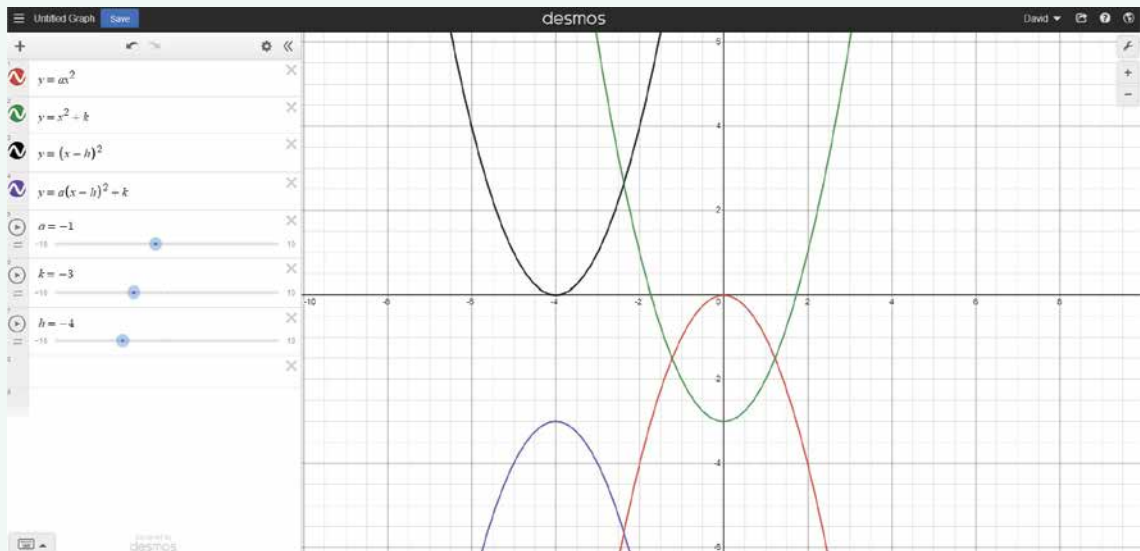

3 Applying an algorithm

The Sydney Harbour Bridge contains two key arches which are central to its design and construction with the lower arch being the one considered here.

For the lower arch use the following approximate measurements.

- Total arch width from ground to ground, 500 m
- Maximum height above ground level, 110 m
 - a By taking the left point of the arch as $(0, 0)$, state the coordinates of the:
 - i turning point
 - ii x -intercepts.
 - b Using your graphing package with the sliders, find a parabola which passes through the points found in part **a** above. Follow these steps.
 - Step 1: Choose values for h and k to ensure the graph passes through the correct turning point.
 - Step 2: Adjust the scale for the slider for a using a smaller increment.
 - Step 3: Drag the slider so that the graph passes near the correct x -intercepts
 - Step 4: If required repeat from Step 2 until the graph passes through the correct intercepts with a high degree of accuracy.
 - c Write down your rule which models the lower arch of the Sydney Harbour Bridge.

4 Extension

- a By using the rule $y = a(x - h)^2 + k$ substitute the values of h and k then solve for a by substituting one of the x -intercepts. Compare this value of a with your value found in part **3 b** above.
- b By researching some other key facts about the Sydney Harbour Bridge, find a parabolic model for the upper arch.
- c Use a similar technique to model other parabolic arches in bridges or other structures that you find on the internet.



Grazing Crown land

Land along the side of rivers is usually owned by the government and is sometimes called Crown land. Farmers can often lease this land to graze their sheep or cattle.

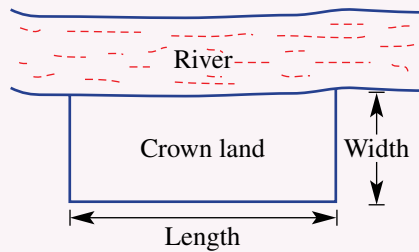

A farmer has a permit to fence off a rectangular area of land alongside the river. She has 400 m of fencing available and does not need to fence along the river.

A given width

- a** Find the length of the rectangular area when the width is:
- i** 50 m
 - ii** 120 m
 - iii** 180 m
- b** Find the area of the land when the width is:
- i** 50 m
 - ii** 120 m
 - iii** 180 m
- c** Which width from part **b** above gave the largest area? Explain why the area decreases for small and large values for the width.

The variable width

- a** Using x metres to represent the width, write an expression for the length showing working.
- b** Write an expression for the area of the land in terms of x .
- c** Use your area expression from part **b** to find the area of the land when x is:
- i** 20
 - ii** 80
 - iii** 160

The graph

- a** Using your expression from part **b** above, sketch a graph of Area (A) versus x . You should find the following to help complete the graph.
- i** y -intercept
 - ii** x -intercepts
 - iii** axis of symmetry
 - iv** turning point
- b** What value of x gives the maximum area of land for grazing? Explain your choice and give the dimensions of the rectangular area of land.

General observations

- a** What do you notice about the width and the length when the area is a maximum?
- b** See if the same is true if the farmer had 600 m of fencing instead. Show your expressions and graph.
- c** Prove your observation to parts **a** and **b** above by finding the x -value that gives a maximum area using k metres of fencing. (*Hint*: Use $A = x(k - 2x)$.)

- 1 a What do you notice about the sum of these numbers?

i $1 + 3$

ii $1 + 3 + 5$

iii $1 + 3 + 5 + 7$

iv $1 + 3 + 5 + 7 + 9$

- b Find the sum of the first 100 odd integers.

- 2 Solve these equations.

a $6x^2 = 35 - 11x$

b $\frac{2}{x^2} = 1 - \frac{1}{x}$

c $\sqrt{x-1} = \frac{2}{x-1}$



Up for a challenge? If you get stuck on a question, check out the 'Working with unfamiliar problems' poster at the end of the book to help you.

- 3 The height of a projectile (in metres) above the ground is given by the expression $t(14 - t)$ where time t is in seconds. For how long is the projectile at a height of above 40 m?

- 4 Find the quadratic rule that relates the number of balls to the term number (n) in the pattern below.

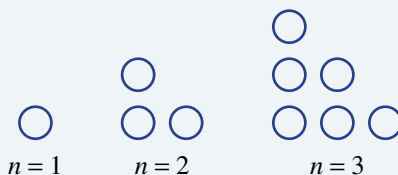

If there are 66 balls in the pattern, what term number is it?

- 5 Find the value of x in this diagram.

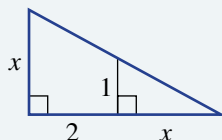

- 6 a A right-angled triangle's shortest side is of length x , the hypotenuse is 9 units longer than the shortest side and the other side is 1 unit longer than the shortest side. Find the side lengths of the triangle.

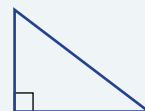

- b The area of a right-angled triangle is 60 square units and the lengths of the two shorter sides differ by 7 units. Find the length of the hypotenuse.

- 7 Given $a > 0$, for what values of k does $y = a(x - h)^2 + k$ have:

a two x -intercepts?

b one x -intercept?

c no x -intercepts?

- 8 For the following equations, list the possible values of a that will give integer solutions for x .

a $x^2 + ax + 24 = 0$

b $x^2 + ax - 24 = 0$

- 9 Solve the equation $(x^2 - 3x)^2 - 16(x^2 - 3x) - 36 = 0$ for all values of x . (Hint: Let $a = x^2 - 3x$.)

- 10 Solve the equation $x^4 - 10x^2 + 9 = 0$ for all values of x . (Hint: Let $a = x^2$.)

Turning point form

$y = a(x - h)^2 + k$
 turning point (h, k)
 e.g. $y = 2(x + 1)^2 + 3$
 TP: $(-1, 3)$
 y-int: $x = 0, y = 2(0 + 1)^2 + 3$
 $= 2(1)^2 + 3$
 $= 5$
 $\therefore (0, 5)$

Standard form

A quadratic is of the form
 $y = ax^2 + bx + c, a \neq 0$

Translation

$y = x^2 + k$ $k > 0$, graph shifts up k units
 $k < 0$, graph shifts down k units
 $y = (x - h)^2$ $h > 0$, graph shifts h units right
 $h < 0$, graph shift h units left

e.g.

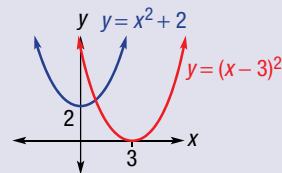
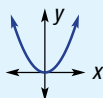
**Parabola**Basic form $y = x^2$ 

Turning point form

$y = a(x - h)^2 + k$
 $x = h$ (axis of symmetry)

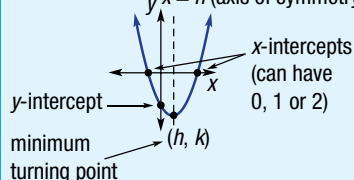
**Introduction to quadratic equations and graphs****Dilation and reflection**

$y = ax^2$
 $a < 0$, graph is reflected in x -axis

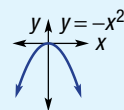

$-1 < a < 1$:
 graph appears wider than $y = x^2$ or $y = -x^2$

$a > 1$ or $a < -1$:
 graph appears narrower than $y = x^2$ or $y = -x^2$
 e.g.

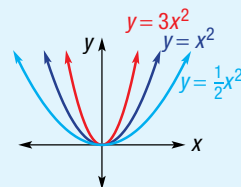
**Sketching $y = ax^2 + bx + c$**

Find x - and y -intercepts and turning point then sketch.

e.g. $y = x^2 - 6x + 5$

y-int: $x = 0, y = 0^2 - 6(0) + 5$
 $= 5$

x-int: $y = 0, 0 = x^2 - 6x + 5$
 $0 = (x - 1)(x - 5)$
 $x - 1 = 0$ or $x - 5 = 0$
 $x = 1$ or $x = 5$

Turning point: halfway between the x -intercepts:

$$x = \frac{1+5}{2} = 3$$

Substitute $x = 3$ into rule:

$$y = 3^2 - 6(3) + 5$$

$$= -4$$

$(3, -4)$ minimum turning point

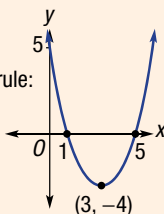
**Applications**

Define variable.
 Set up equation.
 Solve using Null Factor Law.
 Check answer makes sense.
 Answer the question in words.

Solving quadratic equations

- Rewrite equation in standard form:
i.e. $ax^2 + bx + c = 0$
- Factorise
- Apply Null Factor Law:
If $p \times q = 0$, $p = 0$ or $q = 0$.
- Solve remaining equation:
e.g. $x^2 + 5x = 0$
 $x(x + 5) = 0$
 $x = 0$ or $x + 5 = 0$
 $x = 0$ or $x = -5$
 e.g. $x^2 - 12 = 4x$
 $x^2 - 4x - 12 = 0$
 $(x - 6)(x + 2) = 0$
 $x - 6 = 0$ or $x + 2 = 0$
 $x = 6$ or $x = -2$
- If $x^2 = 16$, square root both sides so $x = 4$ or $x = -4$.

Chapter checklist with success criteria

A printable version of this checklist is available in the Interactive Textbook



10A

1. I can write a quadratic equation in standard form.

e.g. Write $x(x - 3) = 6$ in standard form.

10A

2. I can determine if a value is a solution of an equation.

e.g. Use substitution to determine if $x = -2$ is a solution of $2x^2 + 3x - 2 = 0$.

10A

3. I can use the Null Factor Law to solve an equation.

e.g. Use the Null Factor Law to solve $(x + 2)(x - 5) = 0$.

10B

4. I can solve a quadratic equation with a common factor.

e.g. Solve $2x^2 - 10x = 0$.

10B

5. I can solve a quadratic equation of the form $ax^2 = d$.

e.g. Solve $6x^2 = 24$.

10C

6. I can solve equations involving quadratic trinomials.

e.g. Solve $x^2 - 3x - 70 = 0$.

10C

7. I can solve quadratic equations not in standard form.

e.g. Solve $x^2 = 9x - 20$.

10D

8. I can set up and solve a quadratic equation from a word problem.

e.g. The length of a rectangular postcard is 5 cm more than its width and the area of the postcard is 84 cm^2 . Find the dimensions of the postcard.

10E

9. I can identify the key features of a parabola.

e.g. Consider this graph.

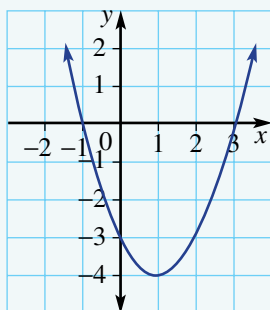

State:

- the equation of the axis of symmetry
- the type and coordinates of the turning point
- the x - and y -intercept coordinates.

10E

10. I can plot a parabola from a table of values.

e.g. For $y = x^2 - 4x + 4$, fill in the table of values and plot the points on a set of axes to form a parabola.

x	-3	-2	-1	0	1	2	3
y							

Chapter checklist with success criteria

10E

11. I can compare graphs of $y = ax^2$, $a > 0$.e.g. Sketch $y = x^2$, $y = 3x^2$ and $y = \frac{1}{3}x^2$ by first completing the table of values below.

x	-2	-1	0	1	2
$y = x^2$					
$y = 3x^2$					
$y = \frac{1}{3}x^2$					

State the turning point of each graph and whether the graphs of $y = 3x^2$ and $y = \frac{1}{3}x^2$ are wider or narrower than the graph of $y = x^2$.

10F

12. I can compare graphs of $y = ax^2$, $a < 0$.e.g. Sketch $y = -x^2$, $y = -4x^2$ and $y = -\frac{1}{4}x^2$ by first completing the table of values below.

x	-2	-1	0	1	2
$y = -x^2$					
$y = -4x^2$					
$y = -\frac{1}{4}x^2$					

State the turning point of each graph and whether the graphs of $y = -4x^2$ and $y = -\frac{1}{4}x^2$ are wider or narrower than the graph of $y = -x^2$.

10G

13. I can sketch parabolas with horizontal and vertical translations.e.g. Sketch $y = x^2 + 3$ and $y = -(x + 1)^2$ showing the y -intercept and turning point.

10G

14. I can sketch parabolas with combined translations.e.g. Sketch $y = (x - 1)^2 - 3$ showing the y -intercept and turning point.

10H

15. I can sketch parabolas using intercept form.e.g. For the quadratic relation $y = x^2 - 6x$, find the x - and y -intercepts and the turning point and sketch its graph, labelling key features.

10H

16. I can sketch a quadratic trinomial.e.g. For the quadratic relation $y = x^2 - 4x - 12$, find the x - and y -intercepts and the turning point and sketch its graph, labelling key features.

Short-answer questions

10E

1 Consider the quadratic $y = x^2 - 2x - 3$.

a Complete this table of values for the equation.

x	-3	-2	-1	0	1	2	3
y							

b Plot the points in part a on a Cartesian plane and join in a smooth curve.

10A

2 Use the Null Factor Law to solve the following equations.

a $x(x + 2) = 0$

b $3x(x - 4) = 0$

c $(x + 3)(x - 7) = 0$

d $(x - 2)(2x + 4) = 0$

e $(x + 1)(5x - 2) = 0$

f $(2x - 1)(3x - 4) = 0$

10B/C

3 Solve the following quadratic equations by first factorising.

a $x^2 + 3x = 0$

b $2x^2 - 8x = 0$

c $x^2 = 25$

d $x^2 = 81$

e $5x^2 = 20$

f $3x^2 - 30 = 0$

g $x^2 + 10x + 21 = 0$

h $x^2 - 3x - 40 = 0$

i $x^2 - 8x + 16 = 0$

10C

4 Write the following quadratic equations in standard form and solve for x .

a $x^2 = 5x$

b $3x^2 = 18x$

c $x^2 + 12 = -8x$

d $2x + 15 = x^2$

e $x^2 + 15 = 8x$

f $4 - x^2 = 3x$

10D

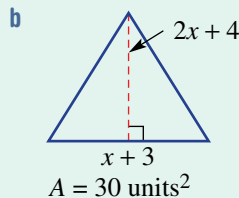
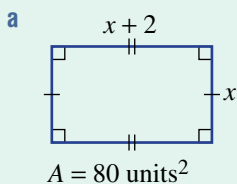
5 Set up and solve a quadratic equation to determine the value of x that gives the specified area of the shapes below.

10E

6 For the following graphs state:

i the axis of symmetry

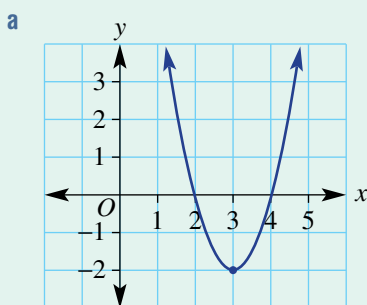

ii the turning point and its type.

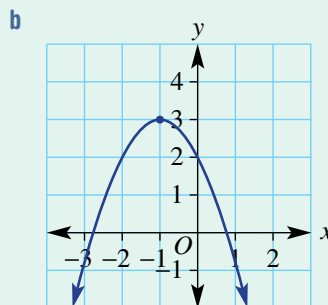

10F/G

7 Match the following quadratic rules with their graphs.

$$y = x^2 - 4, y = 2x^2, y = (x + 1)^2, y = (x - 3)^2, y = -x^2 + 2$$

a

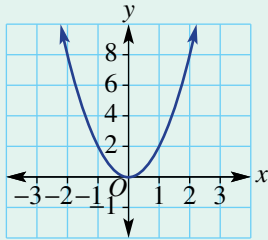

b

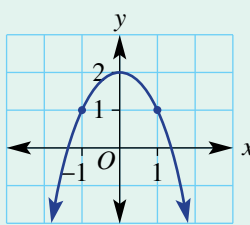

c

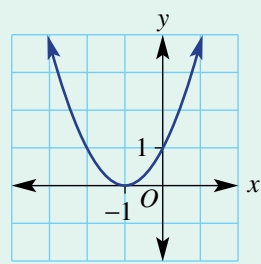

d

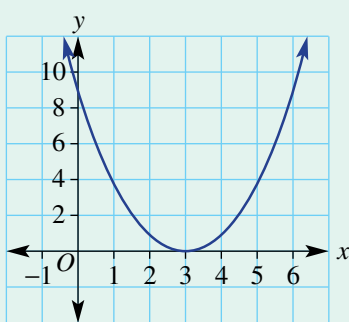

e

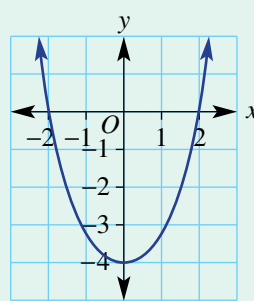

10G

8 Sketch the following graphs labelling the turning point and y-intercept.

a $y = x^2 + 2$

b $y = -x^2 - 5$

c $y = (x + 2)^2$

d $y = -(x - 3)^2$

e $y = (x - 1)^2 + 3$

f $y = 2(x + 2)^2 - 4$

10G

9 State the transformations that take $y = x^2$ to each of the graphs in Question 8.

10H

10 Sketch the following graphs labelling the y-intercept, turning point and x-intercepts.

a $y = x^2 - 8x + 12$

b $y = x^2 + 10x + 16$

c $y = x^2 + 2x - 15$

d $y = x^2 + 4x - 5$

Multiple-choice questions

10A

1 (1, 3) is a point on a curve with which equation?

A $y = x^2$

B $y = (x - 3)^2$

C $y = x^2 + 2x - 3$

D $y = x^2 + 2$

E $y = 6 - x^2$

10A

2 The solution(s) to $2x(x - 3) = 0$ is/are:

A $x = -3$

B $x = 0$ or $x = 3$

C $x = 2$ or $x = 3$

D $x = 0$ or $x = -3$

E $x = 0$

10A

3 The quadratic equation $x^2 = 7x - 12$ in standard form is:

A $x^2 - 7x - 12 = 0$

B $-x^2 + 7x + 12 = 0$

C $x^2 - 7x + 12 = 0$

D $x^2 + 7x - 12 = 0$

E $x^2 + 7x + 12 = 0$

10B

4 The solution(s) to $x(x + 2) = 2x + 9$ is/are:

A $x = -3$ or $x = 3$

B $x = 0$ or $x = -2$

C $x = 3$

D $x = 9$ or $x = -1$

E $x = 9$ or $x = 0$

The following applies to Questions 5 and 6.

The height, h metres, of a toy rocket above the ground t seconds after launch is given by $h = 6t - t^2$.

10D

5 The rocket returns to ground level after:

- A 5 seconds B 3 seconds C 12 seconds
D 6 seconds E 8 seconds

10H

6 The rocket reaches its maximum height after:

- A 6 seconds B 3 seconds C 10 seconds
D 4 seconds E 9 seconds

10G

7 The turning point of $y = (x - 2)^2 - 4$ is:

- A a maximum at (2, 4)
B a minimum at (-2, 4)
C a maximum at (-2, 4)
D a minimum at (-2, -4)
E a minimum at (2, -4)

10G

8 The transformation of the graph of $y = x^2$ to $y = x^2 - 2$ is described by:

- A a translation of 2 units to the left
B a translation of 2 units to the right
C a translation of 2 units down
D a translation of 2 units up
E a translation of 2 units right and 2 units down

10F

9 Compared to $y = x^2$, the narrowest graph is:

- A $y = 5x^2$ B $y = 0.2x^2$ C $y = 2x^2$
D $y = \frac{1}{2}x^2$ E $y = 3.5x^2$

10G

10 The graph of $y = -(x - 3)^2$ is:

A

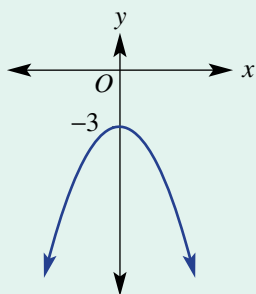

B

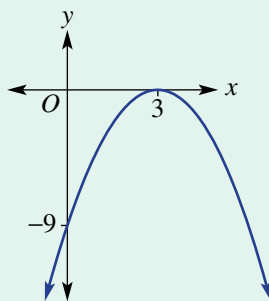

C

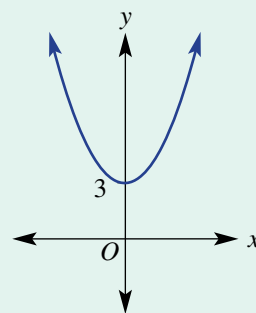

D

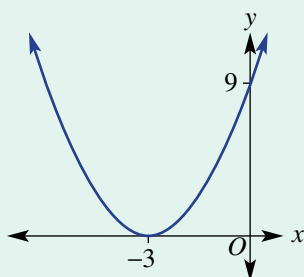

E

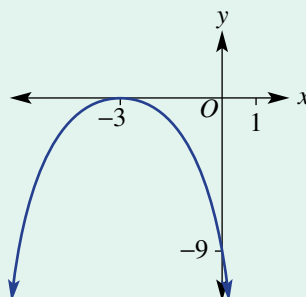

Extended-response questions

- 1 A sail of a yacht is in the shape of a right-angled triangle. It has a base length of $2x$ metres and its height is 5 metres more than half its base.
- Write an expression for the height of the sail.
 - Give an expression for the area of the sail in expanded form.
 - If the area of the sail is 14 m^2 , find the value of x .
 - Hence, state the dimensions of the sail.



- 2 Connor and Sam are playing in the park with toy rockets they have made. They launch their rockets at the same time to see whose is better.
- The path of Sam's rocket is modelled by the equation $h = 12t - 2t^2$, where h is the height of the rocket in metres after t seconds.
 - Find the coordinates of the axis intercepts.
 - Find the turning point.
 - Sketch a graph of the height of Sam's rocket over time.
 - The path of Connor's rocket is modelled by the equation $h = -(t - 4)^2 + 16$, where h is the height of the rocket in metres after t seconds.
 - Find the h -intercept coordinates (i.e. $t = 0$).
 - State the turning point.
 - Use the answers from parts **b i** and **ii** to state the coordinates of the two t -intercepts.
 - Sketch a graph of the height of Connor's rocket over time.
 - Whose rocket was in the air for longer?
 - Whose rocket reached the greater height and by how much?
 - How high was Sam's rocket when Connor's rocket was at its maximum height?

11

Algorithmic thinking

Maths in context: Algorithms and networks

For a modern society to function effectively we know that road and rail networks, electrical circuits and various communication systems need to operate efficiently. The study of how such systems work is called Networks and is a key application of mathematics, computer science and engineering. The optimisation of networks involves the use of algorithms which aim to produce the best performance using the minimum amount of resources.

The capacity of a rail network, for example, depends largely on the effectiveness of the timetable. However, these can be difficult to construct by hand given the vast number of possible combinations of factors which influence the performance of the network. Algorithms aided by computer programs are used in conjunction with network mathematics to search for optimal network solutions.

Chapter contents

Activity 1: Algorithms for number patterns and financial maths

- 1.1 Number patterns
- 1.2 Algorithms in finance
- 1.3 Income tax calculation algorithm

Activity 2: Minimising and maximising

- 2.1 Cylindrical cans
- 2.2 Cardboard boxes

Activity 3: Sorting, simulations and sampling

- 3.1 Ways of sorting data to find the median
- 3.2 Simulations in probability calculations

Australian Curriculum 9.0

design, test and refine algorithms involving a sequence of steps and decisions based on geometric constructions and theorems; discuss and evaluate refinements (AC9M9SP04)

© ACARA

Online resources

A host of additional online resources are included as part of your Interactive Textbook, including HOTmaths content, video demonstrations of all worked examples, auto-marked quizzes and much more.

Optimal solutions to network problems help find a shortest path, maximum flow, minimum cost or maximum profit, all helping to improve the society in which we live.

Introduction

An **algorithm** is a sequence of steps that when followed, lead to the solution of a problem. It has a defined set of inputs and delivers an output. Each step in the algorithm leads to another step or completes the algorithm.

Algorithms occur in mathematics and computing, as well as in simple areas of daily life such as following a recipe. Algorithmic thinking is a type of thinking that involves designing algorithms to solve problems. The algorithms we design can then be written in a way that a computer program will understand, so that the computer does the hard computational work.

In the following activities you will carry out some algorithms as well as think about the design, analysis and implementation of your own algorithms.

The algorithms in these activities will be described through the use of spreadsheets, flow charts (a way of writing an algorithm in the form of a diagram), programming language and simulations. The following symbols will be used in the flow charts with arrows to connect each stage:



for input/output stages



for process stages

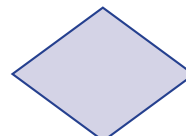

for decision stages



Activity 1: Algorithms for number patterns and financial maths

NUMBER AND ALGEBRA

Algorithms can be used to generate number patterns as well as to carry out tasks in the financial world. Some examples are seen in the following parts.

1.1 Number patterns

Consider the flowchart algorithm shown below.

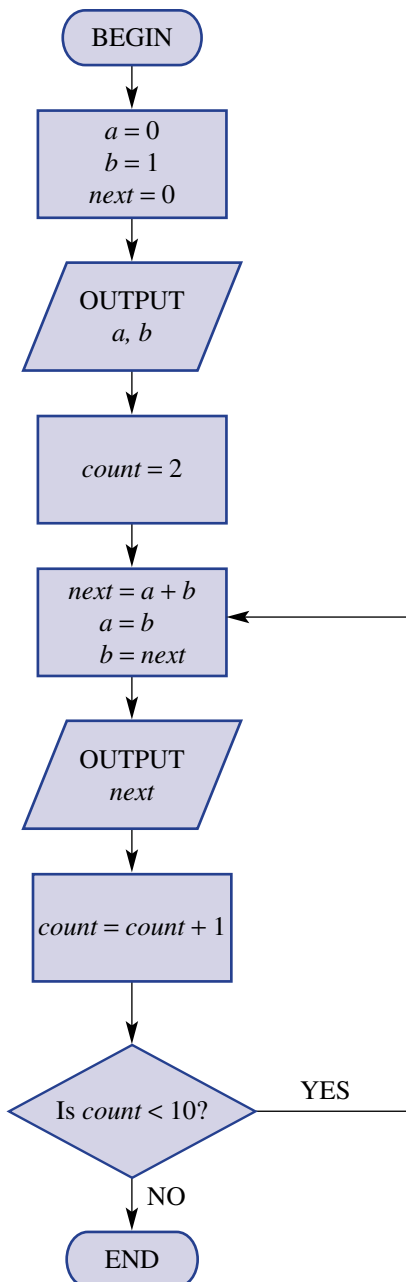

- a Trace through the algorithm by completing a table like the one shown below, updating the values of the variables as you go. Add any output to the line at the bottom of the table. The first set of values is done for you.

<i>a</i>	<i>b</i>	<i>next</i>	<i>count</i>
0	1	0	2
.	.	.	.
.	.	.	.
.	.	.	.
Output: 0, 1,			

- b What is the special sequence of numbers generated in the output of part a?
 c Which part of the algorithm controls how many numbers are displayed?

The triangular numbers are another number sequence as shown below.

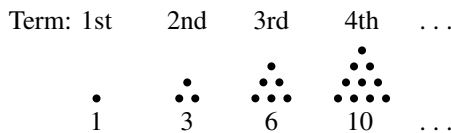

Consider the pattern in the triangular numbers.

- d Set up a spreadsheet to generate the first 20 triangular numbers based on the term number. In the first column enter the numbers 1 to 20 for the term number and in the second column set up a way of generating the triangular numbers.
 e Complete a flowchart that generates the first 10 triangular numbers. Use the flowchart from part a as a guide. Test it on a friend using a table to see if they get the correct list of numbers as they trace through the algorithm.

1.2 Algorithms in finance

a Simple interest

In **Section 1K** you would have studied simple interest. Recall, that this is the interest (I) calculated at a set rate ($r\%$), over a certain period of time (t) on a principal amount (P). When calculating simple interest, the interest is the same for each time period.

The formula is $I = \frac{Prt}{100}$.

Consider the case in which a sum of \$2000 is invested in a simple interest bank account with an interest rate of 3.8% p.a. for 5 years.

- i Set-up a spreadsheet like the one shown in Figure 1 below to display the total amount of interest earned after each year and the account balance. Once the initial formulas are entered, fill down the columns until $t = 5$.

	A	B	C
1	Principal	2000	
2	Interest rate % p.a.	3.8	
3			
4	Number of Years	Interest Earned	Amount
5	1	=(B\$1*B\$2*A5)/100	=B\$1+B5
6	=A5+1	=(B\$1*B\$2*A6)/100	=B\$1+B6
7	=A6+1	=(B\$1*B\$2*A7)/100	=B\$1+B7
8	=A7+1	=(B\$1*B\$2*A8)/100	=B\$1+B8
9	=A8+1	=(B\$1*B\$2*A9)/100	=B\$1+B9
10			
11			

Figure 1: Showing formulas

	A	B	C	D	E
1	Principal	\$2,000			
2	Interest rate % p.a.	3.8			
3					
4	Number of Years	Interest Earned	Amount		
5	1	76	\$2,076		
6	2	152	\$2,152		
7	3	228	\$2,228		
8	4	304	\$2,304		
9	5	380	\$2,380		

Figure 2: Calculated values

The spreadsheet in Figure 2 could also be generated in programming languages. The first stage is to design the flowchart algorithm.

- ii The steps of the algorithm are listed below. From these steps construct a flowchart for the algorithm.

Step 1. Receive inputs P , r and t .

Step 2. Set the counter n to $n = 1$ to represent the end of the first year.

Step 3. Calculate the simple interest and the current balance for year n .

Step 4. Display the current year n , the interest earned and the balance.

Step 5. Increase n by 1.

Step 6. If $n < t$ repeat steps 3 to 6 else End.

- iii Use your algorithm in part ii above to find the total amount after 5 years if $P = 5000$ and $r = 4$.

b Compound interest

A second type of interest, which you may have studied in **Section 1L**, is compound interest.

Compound interest is such that interest is calculated on both the principal amount and the previously accrued interest. This is achieved by increasing the current year's amount by the percentage rate.

- i Set-up the spreadsheet below to display the balance each year and the interest earned in total for an investment of \$2000 compounding annually at 3.8%.

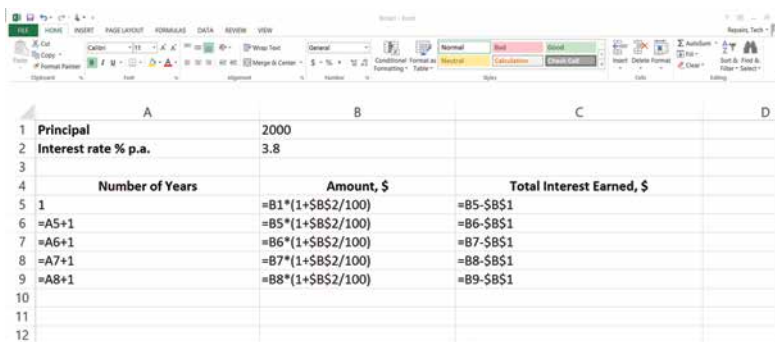

	A	B	C	D
1	Principal	2000		
2	Interest rate % p.a.	3.8		
3				
4	Number of Years	Amount, \$	Total Interest Earned, \$	
5	1	=B1*(1+\$B\$2/100)	=B5-\$B\$1	
6	=A5+1	=B5*(1+\$B\$2/100)	=B6-\$B\$1	
7	=A6+1	=B6*(1+\$B\$2/100)	=B7-\$B\$1	
8	=A7+1	=B7*(1+\$B\$2/100)	=B8-\$B\$1	
9	=A8+1	=B8*(1+\$B\$2/100)	=B9-\$B\$1	
10				
11				
12				

- ii Experiment with your spreadsheet, using different principal amounts, interest rates and time periods.

- iii Write out the steps of the compound interest algorithm, as for simple interest in part a ii, then create a flowchart that could be used to program this algorithm.

- Ext** iv Redesign your algorithm from part iii so that it determines and outputs the number of full years it takes for the amount in the account to be double the initial investment.



1.3 Income tax calculation algorithm

You may have seen tax tables used to calculate how much tax a person must pay based on their taxable income.

The taxable income is taken as the gross income minus deductions. An example of a tax table with different tax brackets is shown below. Here you are taxed at a higher rate for dollars earned over certain amounts.

Taxable income	Tax on this income
0–\$18 200	Nil
\$18 201–\$37 000	19c for each \$1 over \$18 200
\$37 001–\$80 000	\$3572 plus 32.5c for each \$1 over \$37 000
\$80 001–\$1 80 000	\$17 547 plus 37c for each \$1 over \$80 000
\$180 001 and over	\$54 547 plus 45c for each \$1 over \$180 000

- a Using the table above, find the tax payable for these taxable incomes.
 - i \$1000
 - ii \$25 000
 - iii \$50 000
 - iv \$100 000
 - v \$200 000
- b Write an algorithm in flowchart form that determines the tax payable based on input of a person's gross income and deductions total.
- c Have a friend trace through your algorithm using a gross income of \$62 487 and deductions of \$350. Do they complete the algorithm with the correct answer?
- d Carefully choose four other values to test that your algorithm works correctly. How did you make your choice?





Activity 2: Minimising and maximising

MEASUREMENT AND GEOMETRY

In the following we will consider two common scenarios. The first scenario is for a fixed volume of an object and determining the dimensions which minimise the surface area (i.e. material required to form it). The second is for a fixed surface area (amount of material), and determining the dimensions which maximise the volume.

2.1 Cylindrical cans

A company packages tinned food in cylindrical cans. They require a fixed volume for these cans and wish to use dimensions that give the minimum surface area to minimise the cost of production.

Recall the following formulas for a cylinder:

$$\text{Volume: } V = \pi r^2 h$$

$$\text{Surface area: } A = 2\pi r^2 + 2\pi r h$$

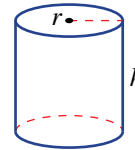

Let the required volume of the cans be 340 cm^3 .

- a In $V = \pi r^2 h$, let $V = 340$. Rearrange the formula to make h the subject to show that $h = \frac{340}{\pi r^2}$.
- b In a spreadsheet make a column for r and create a column to calculate h (using the formula from part a). Also create a column for the surface area. Start at $r = 0.1$ and increment (increase) your r values by 0.1. Using a smaller increment will give greater accuracy.

In Microsoft Excel, the PI() function accesses π .

Fill down each column.

	A	B	C
1	Fixed Volume, $V \text{ cm}^3$:	340	
2			
3	radius, $r \text{ cm}$	height, $h \text{ cm}$	surface area, cm^2
4	0.1	$=\$B\$1/(PI()*A4^2)$	$=2*PI()*A4^2+2*PI()*A4*B4$
5	$=A4+0.1$		
6			

- c Use the graphing features of your spreadsheet to sketch a graph of surface area against radius. You should notice a minimum (lowest point) on your graph. Refer to your spreadsheet and write down the closest r and h values that give the minimum surface area.



Activity 3: Sorting, simulations and sampling

STATISTICS AND PROBABILITY

3.1 Ways of sorting data to find the median

Many statistical calculations have a set process or algorithm for calculating them. For example, the mean is found by adding the data values and dividing by the number of values. The range is found by finding the maximum and minimum values and calculating the difference between them.

Recall that the process for finding the median of a set of data is:

- Step 1.** Sort the data in ascending order.
- Step 2.** Locate the middle value: If there is an odd number of data values this will be the median value; if there is an even number of data values, average the two middle values.

From an algorithm point of view, the most involved part of this process is sorting the list of data.

There are a number of different sorting algorithms already in existence. Here we will compare two different types: selection sort (which you may have seen in Year 8) and bubble sort.

Selection sort: This method involves finding the smallest (or largest) element in a list and swapping it with the first (or last) item in the list and then moving along the list until it is sorted.

For example, the data set ⑦ 8 6 12 ② 3 9 after one pass through becomes 2 8 6 12 7 3 9 where the minimum value 2 moves to the start of the list and swaps with the 7. The next pass through becomes 2 3 6 12 7 8 9 and so on.

- a** Use the data sets listed below to trace through the selection sort algorithm. Complete a table like the one shown to show the algorithm in action. Record the number of comparisons (comparing data elements to find the minimum) and the number of swaps made along the way. The first row for the first data set is completed for you.

i 7 3 9 5

ii 6 2 8 5 4

Pass number	List order	Number of comparisons made	Number of swaps made
1	3 7 9 5	3	1
⋮			
		Total:	Total:

Bubble sort: this method works through the list by comparing each adjacent pair of numbers along the way and swapping them if necessary so that the smaller number is on the left. One pass through the list ensures the biggest number is at the end of the list. The process continues on the list until the data sorted.

For example, for the data set 3 8 6 4 7 the first pass involves the following stages:

3 8 6 4 7
 3 8 6 4 7
 3 6 8 4 7
 3 6 4 8 7
 3 6 4 7 8

Each adjacent pair was compared (3 and 8 stayed where they were as they were already in order). This involved four comparisons and three swaps. Pass 2 will then work on the list 3 6 4 7, since 8 is now in the correct position.

- b** Use the bubble sort algorithm for the two data sets in part **a**, by setting up a similar table.
- c** Compare your tables from parts **a** and **b**.
 - i** What do you notice about the number of comparisons required in the two algorithms? How does this compare to the number of data elements?
 - ii** What do you notice about the number of swaps between the two algorithms?
 - iii** Hence, in general, which algorithm do you think is considered more efficient (runs faster or requires less processing)?
- d** A flowchart can be used to represent these algorithms as well as pseudo code (an informal programming language that can eventually be implemented in code).
The example below shows pseudo code for the selection sort algorithm.

```

for i = 1 → n - 1
    min ← i
    for j = i + 1 → n
        if aj < amin then
            min ← j
    swap ai and amin
    
```

The data is input as a list/array in which the position in the list is referenced as a_1 for the first element, a_2 for the second element up to the n th (last) element a_n .
The ‘for loop’ is used to work through the repetitive nature of the process. Inside the ‘for loop’ each value of the counter i increases by 1 each time after each process. The \leftarrow updates the value of the variable with a new value.

Read through the above code and explain how it works. Try working through the code with the data list in the table at right.

5	4	6	3
a_1	a_2	a_3	a_4

Set-up a table similar to the one below to keep track of the pronumeral values and the list order. In this list $n = 4$. The first run through with $i = 1$ is done for you.

i	min	j	Test condition	min
1	1	2 (i.e. $i + 1$)	$a_2 < a_1$ —yes	2 (updated)
1	2	3	$a_3 < a_2$ —no	No change
1	2	4 (i.e. n)	$a_4 < a_2$ —yes	4 (updated)
$j = n$, break out of for loop, update list order swapping a_i and a_{min} : 3 4 6 5				
2	2	3
⋮				

- e** Using the format below, complete the pseudo code for the bubble sort algorithm by filling in the boxes. j iterates from 1 to $n - i$ as the biggest numbers will be being sorted at the end of the list first this time.

```

for i = 1 → n - 1
    for j = 1 → n - i
        if  then
            
    
```

- (Ext) f** The efficiency of the bubble sort algorithm can be improved by stopping when the list is sorted (i.e. if no more swaps are taking place as you pass through the list). Consider ways you could implement this in your code in part **e** so that when the list is sorted it breaks out of the ‘for loop’.

Now that we have algorithms for sorting a list of data, we can use these to help us find the median of a set of data.

g i Copy and complete the empty boxes in the median flowchart algorithm below. Use the box shapes as a guide for the task.

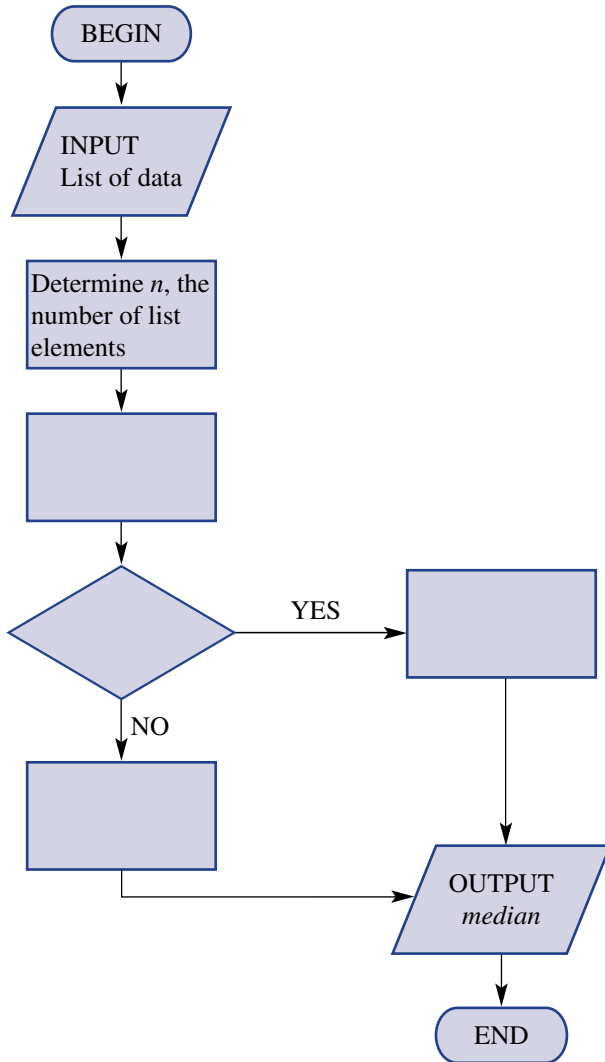

ii Turn this flowchart into pseudo code, detailing exactly how you will locate the median for an odd and even number of data values.

Ext iii Extend your code in part **ii** to also find the interquartile range (recall from **Section 9K** this is $Q_3 - Q_1$).

3.2 Simulations in probability calculations

Simulations to determine good approximations for probabilities can be carried out using different techniques. For experiments with two equally likely outcomes, a coin is a good device which can be used to carry out the simulation. Other devices include dice, spinners, random number generators such as calculators and computers and random number tables.

The following tasks will explore the use of some of these.

a Simulation devices

Consider the following scenarios and describe how you could use the given device to carry out the simulation.

- i Simulate the gender of the next baby born, using a coin.
- ii Simulate the result of the next penalty shot from a soccer player who has a poor record (1 out of every 3), using a six-sided die.
- iii Simulate getting the correct answer from a random guess on a multiple-choice question with four options, using a deck of cards.
- iv Simulate the situation '2 in 5 chocolate bars wins a prize', using a die.
- v Based on the number of paths through a maze, a mouse has a 1 in 8 chance of exiting through the path with a cheese reward at the end. Simulate, using three coins.

b Technology and random numbers

You may have noticed in part **a** that some probabilities were easier to simulate than others with certain devices. The use of random numbers on calculators and computers makes this more achievable. For example, to represent a 2 in 5 chance you can generate a random integer between 1 and 5 and assign the numbers 1 and 2 to represent a win and 3, 4 and 5 a loss.

Many scientific calculators have a `randint()` function that can generate a random integer in a specified range. In Microsoft Excel `RANDBETWEEN(1, 5)` will generate a random integer between 1 and 5.

Consider a basketball player who gets on average 75% of her free throws in.

- i Consider how you could use a random number generator to simulate her next free throw. Technology would be helpful in the following but coins or a die could also be used effectively.
- ii Using your chosen device, estimate the probability that the player makes 5 or 6 of the 6 free throw shots she takes in a game by following these steps.
 - Generate 6 random numbers and count if 5 or 6 of them are in. Use a table like the one below. Repeat for 50 trials.

Trial number	Number of free throw shots in out of 6	5 or 6 shots in? (Yes/No)
1		
2		
⋮		
50		

- Calculate the probability estimate: $\frac{\text{number of times 5 or 6 in (yes)}}{\text{number of trials}}$
- iii The theoretical probability is 0.534. How does your answer compare? Compare with other members of the class.

c Random number tables

The simulation in part **b** could also be carried out using a random number table.

The random number table shown on the next page groups digits in groups of five but is generated with a random digit between 0 and 9 at each place. These numbers can then be grouped together to represent 1, 2, 3 digit numbers and more.

58315	10578	77473	16526	53775
22646	82056	42313	50814	60650
07419	77083	11543	26629	08313
76940	62101	86568	08456	53641
15963	82704	06272	58036	61078
80644	86510	78615	06079	60154
30571	92400	07305	64811	03054
09182	14662	10472	97400	65696
34361	67837	16869	00904	79928
56845	84009	10030	28001	64238
64794	74684	75213	38693	27053
78586	70912	18697	55949	39557
92444	18934	51892	24300	20247
10287	04605	29245	52500	90501
75233	47520	50251	75778	69504
89599	84143	14821	26191	18076
35287	40045	24635	45782	12217
07320	03379	80797	26408	75542
43560	20875	53010	23045	23634
90623	75405	18139	31992	64709
06655	97645	90074	57757	48091
59959	72048	57584	39509	43253
88358	78732	45246	00345	02690
11524	56474	20503	02944	86411
45850	83072	27083	65098	92990
05013	21373	93138	21196	91294
80820	27119	29971	73672	21843
30859	16362	07037	82057	67908
19037	36352	26371	72254	33515
94869	80499	48086	43199	55744
02516	67531	73014	46866	52298
46238	37370	63515	37083	33247
26103	81339	93391	43856	95475
07664	85034	46581	88772	93372
18305	71127	91648	96303	65869
04887	10435	77400	30370	20995
08597	14871	08080	99425	73733
01876	18260	04657	87735	07273
16680	12966	75383	87195	86948
43454	22639	45772	62461	67602
89229	90868	03485	85955	73123
70283	78014	64377	40020	73714
19609	05831	80438	76003	50046
87442	56988	25210	21541	81928
43409	93065	52495	77536	81227

Consider the following scenario:

Over his career, an AFL player has a set shot for goal record of 68% goals, 24% behinds and 8% out on the full.

As we have percentages, we can use random numbers between 0 (i.e. 00) and 99.

- i** Decide which sets of two-digit numbers you would use to represent a goal, a behind and out on the full.

Two-digit numbers can be drawn from the random number table by selecting a starting point in the table and reading off two digits at a time to form a number.

For example, for the block of numbers 58315 10578 you would get the numbers 58, 31, 51, 05 (i.e. 5) and 78.

- ii** Use the random number table (starting from any location in the table) to carry out 20 trials to estimate the probability that in 5 set shots on goal the player scores at least 3 goals.

- Record your results in a table like the one shown on the right.
- Estimate the probability: $\frac{\text{number of 'yes'}}{\text{number of trials}}$
- Compare your result with those of other members of the class.

Trial number	Number of goals	At least 3 goals? (Yes/No)
1		
2		
⋮		
20		

d The birthday problem

A famous problem in probability is the question of how many people you need in a room for there to be more than a 50–50 chance of two people sharing the same birthday.

In Senior Mathematics courses you can prove that you need 23 people in a room for this to be the case. We will investigate this using a simulation.

- i** Use a spreadsheet to get a sample of 23 random integers from 1 to 365 (representing the different birthdays across the year – February 29 is left out!). Fill down the formula shown to get 23 numbers.

- ii** Repeat part **i** 50 times by filling across to column AX. Cut and paste your data values onto a new sheet so that they do not keep changing.

- iii** Sort each column from smallest to largest in order to quickly compare if there are any duplicates (repeat numbers representing the same birthday).

- iv** Count how many columns have duplicates and calculate your probability. Is it over 50%?

- v** As a class, record all of your probabilities and find the mean of these. Does this support the result outlined?

- vi** Repeat the process in parts **i–v** for 22 people in the room to see if this probability falls below 50%.

- Ext** **vii** Use these methods to investigate how many people you would need in the room for there to be a probability of more than 90% that two people will share a birthday.

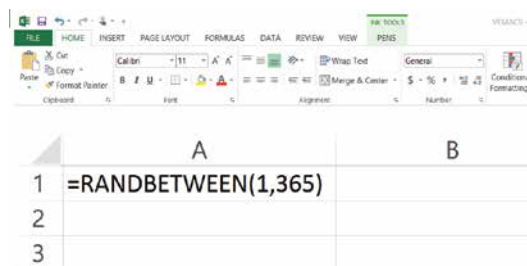

Indices and surds

Short-answer questions

1 Use index laws to simplify the following.

a $\frac{9a^6b^3}{18a^4b^2}$

b $\frac{(-3x^4y^2)^2 \times 6xy^2}{27x^6y}$

c $(2x^2)^3 - 3x^0 + (5x)^0$

2 Write each of the following using positive indices and simplify.

a $\frac{5}{m^{-2}}$

b $\frac{4a^6b^{-4}}{6a^{-2}b}$

Ext c $3\left(x^{\frac{1}{2}}\right)^3 y^{-\frac{1}{3}} \times x^{\frac{1}{2}} y^{-\frac{2}{3}}$

3 Convert these numbers to the units given in brackets. Write your answer using scientific notation with three significant figures.

a 30.71 g (kg)

b 4236 tonnes (kg)

c 3.4 hours (seconds)

d 235 nanoseconds (seconds)

Ext 4 Simplify the following.

a $144^{\frac{1}{2}}$

b $27^{\frac{1}{3}}$

c $2\sqrt{3} + 3\sqrt{5} + 4\sqrt{5}$

d $\sqrt{35} \div \sqrt{5}$

Multiple-choice questions

1 $3a^2b^3 \times 4ab^2$ is equivalent to:

A $12a^2b^6$

B $7a^3b^5$

C $12a^3b^5$

D $12a^4b^5$

E $7a^2b^6$

2 $\left(\frac{2x}{5}\right)^3$ is equivalent to:

A $\frac{6x^3}{5}$

B $\frac{8x^3}{125}$

C $\frac{2x^3}{5}$

D $\frac{2x^4}{15}$

E $\frac{2x^3}{125}$

3 4^{-2} can be expressed as:

A $\frac{1}{4^{-2}}$

B $\frac{1}{8}$

C -16

D $\frac{1}{16}$

E -8

4 $3x^{-4}$ written with positive indices is:

A $-3x^4$

B $\frac{1}{3x^4}$

C $-\frac{3}{x^4}$

D $\frac{1}{3x^{-4}}$

E $\frac{3}{x^4}$

5 0.00371 in scientific notation is:

A 0.371×10^{-3}

B 3.7×10^{-2}

C 3.71×10^{-3}

D 3.71×10^3

E 371×10^3

Extended-response question

The average human body contains about 74 billion cells.

a Write this number of cells:

i in decimal form

ii using scientific notation.



b If the population of a particular city is 2.521×10^6 , how many human cells are there in the city? Give your answer using scientific notation correct to three significant figures.

c If the average human weighs 64.5 kilograms, what is the average mass of one cell in grams? Give your answer using scientific notation correct to three significant figures.

Geometry

Short-answer questions

1 Find the value of each pronumeral in the following.

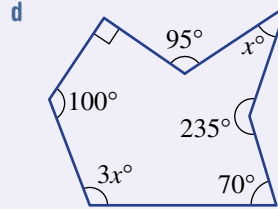
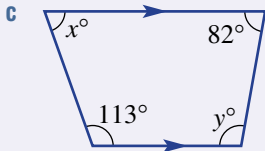
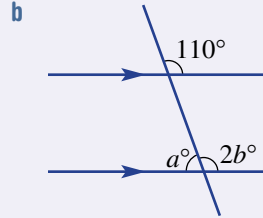
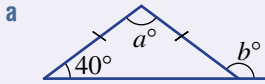

2 Find the value of $\angle ABC$ by adding a third parallel line.

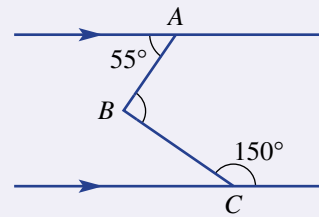

Ext 3 Prove $\triangle ABC \equiv \triangle ADC$.

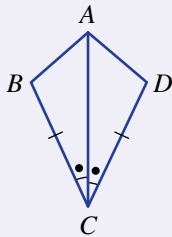

4 Consider the pair of triangles shown at right.

- a Give a reason (SSS, SAS, AAA or RHS) why the two triangles are similar.
- b Find the value of x .

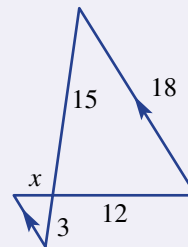

Multiple-choice questions

1 The supplementary angle to 55° is:

- A 55°
- B 35°
- C 125°
- D 135°
- E 70°

- 2 A quadrilateral with all four sides equal and opposite sides parallel is best described by a:
 A parallelogram B rhombus C rectangle
 D trapezium E kite
- 3 The size of the interior angle in a regular pentagon is:
 A 108° B 120° C 96° D 28° E 115°
- 4 The test that proves congruence in these two triangles is:
 A SAS B RHS
 C AAA D SSS
 E AAS
- 5 What is the scale factor that enlarges shape 1 to shape 2 in these similar figures, and what is the value of x ?
 A 2 and $x = 8$
 B 2.5 and $x = 7.5$
 C 3.33 and $x = 13.33$
 D 2.5 and $x = 12.5$
 E 2 and $x = 6$

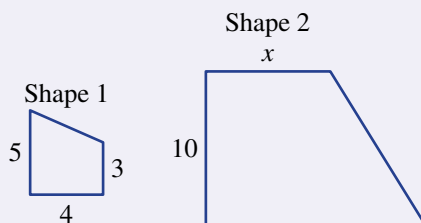
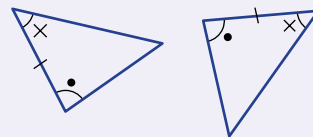

Extended-response question

-  A vertical wall is being supported by a piece of timber that touches the ground 10 m from the base of the wall. A vertical metal support 4.5 m high is placed under the timber support 4 m from the wall.

- a Prove $\triangle ABD \parallel \triangle ECD$.
- b Find how far up the wall the timber reaches.
- c How far above the ground is the point halfway along the timber support?
- d The vertical metal support is moved so that the timber support is able to reach one metre higher up the wall. If the piece of timber now touches the ground 9.2 m from the wall, find how far the metal support is from the wall. Give your answer correct to one decimal place.

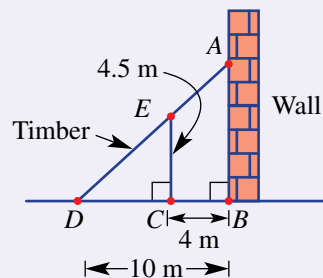

Algebraic techniques

Short-answer questions

- 1 Find the area of the following shapes in expanded form.

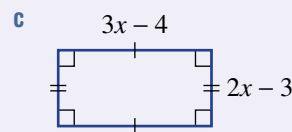
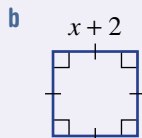
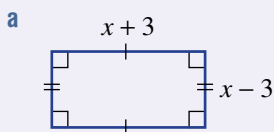

2 Factorise each of the following fully.

a $8ab + 2a^2b$

b $9m^2 - 25$

c $3b^2 - 48$

d $(a + 7)^2 - 9$

e $x^2 + 6x + 9$

f $x^2 + 8x - 20$

g $2x^2 - 16x + 30$

Ext h $2x^2 - 11x + 12$

Ext i $6x^2 + 5x - 4$

3 Factorise the following by grouping in pairs.

a $x^2 - 3x - x + 3$

b $2x^2 - 10 - 5x + 4x$

4 a Simplify these algebraic fractions.

i $\frac{3x + 24}{2x + 16}$

ii $\frac{12}{x^2 - 9} \div \frac{3}{x - 3}$

iii $\frac{x + 3}{2} + \frac{3x}{7}$

iv $\frac{2}{x} - \frac{5}{3x}$

v $\frac{7}{x + 1} + \frac{4}{x - 2}$

Ext vi $\frac{5}{x - 5} - \frac{3}{x + 2}$

Ext b Solve these equations involving algebraic fractions.

i $\frac{5}{2x} + \frac{1}{3x} = 2$

ii $\frac{4}{x - 5} = \frac{2}{x + 3}$

Multiple-choice questions

1 The expanded form of $(x + 4)(3x - 2)$ is:

A $3x^2 + 12x - 8$

B $4x^2 + 14x - 8$

C $3x^2 + 12x - 10$

D $3x^2 - 8$

E $3x^2 + 10x - 8$

2 $2(x + 2y) - x(x + 2y)$ factorises to:

A $2x(x + 2y)$

B $(x + 2y)^2(2 - x)$

C $(2 + x)(x + 2y)$

D $(x + 2y)(2 - x)$

E $(x + 2y)(2 - x^2 - 2xy)$

3 $x^2 - 2x - 24$ in factorised form is:

A $(x - 2)(x + 12)$

B $(x - 6)(x + 4)$

C $(x - 8)(x + 3)$

D $(x + 6)(x - 4)$

E $(x - 6)(x - 4)$

4 $\frac{3x + 6}{(x - 2)(x - 4)} \times \frac{x^2 - 4}{(x + 2)^2}$ is equivalent to:

A $\frac{3}{x - 4}$

B $\frac{3(x - 2)}{(x - 4)(x + 2)}$

C $\frac{3x - 2}{(x + 1)^2}$

D $\frac{3}{(x + 2)(x - 2)}$

E $\frac{3x^2}{(x - 2)(x + 2)}$

Ext 5 $\frac{7}{(x + 1)^2} - \frac{4}{x + 1}$ simplifies to:

A $\frac{3x + 1}{(x + 1)^2}$

B $\frac{6 - 4x}{(x + 1)^2}$

C $\frac{-9}{(x + 1)^2}$

D $\frac{3 - 4x}{(x + 1)^2}$

E $\frac{11 - 4x}{(x + 1)^2}$

Extended-response question

A rectangular room 10 metres long and 8 metres wide has a rectangular rug in the middle of it that leaves a border x metres wide all the way around it as shown.

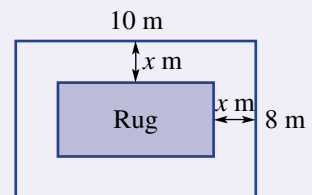

a Write expressions for the length and the width of the rug.

b Write an expression for the area of the rug in expanded form.

c What is the area of the rug when $x = 1$?

d Fully factorise your expression in part b by first removing the common factor.

e What happens when $x = 4$?

Probability and statistics

Short-answer questions

- 1 In a survey of 30 people, 18 people drink coffee, 14 people drink tea and 8 people drink both. Let C be the set of people who drink coffee and T the set of people who drink tea.
 - a Construct a Venn diagram for the survey results.
 - b Find:
 - i $n(C \cup T)$
 - ii $n(T)$.
 - c If one of the 30 people was randomly selected, find:
 - i $\Pr(\text{drinks neither coffee nor tea})$
 - ii $\Pr(\text{drinks coffee only})$.

- 2 Two ice-creams are randomly selected without replacement from a box containing one vanilla (V), two strawberry (S) and one chocolate (C) flavoured ice-creams.
 - a Draw a tree diagram to show each of the possible outcomes.
 - b What is the probability of selecting:
 - i a vanilla and a strawberry flavoured ice-cream?
 - ii two strawberry flavoured ice-creams?
 - iii no vanilla flavoured ice-cream?

- 3 Identify the sampling method used in each of these surveys.
 - a Employees are selected from each department in a workplace and surveyed on their job satisfaction.
 - b Every tenth customer in a store is surveyed regarding their thoughts on customer service in the store.

- 4 The data below shows the number of aces served by a player in each of their grand slam tennis matches for the year.

15 22 11 17 25 25 12 31 26 18 32 11 25 32 13 10

 - a Classify the type of data collected.
 - b Construct a stem-and-leaf plot for the data.
 - c From the stem-and-leaf plot, find the mode and median number of aces.
 - d Is the data symmetrical or skewed?

- 5 The frequency table shows the number of visitors, in intervals of fifty, to a theme park each day in April.
 - a Complete the frequency table shown. Round to one decimal place where necessary.
 - b Construct a frequency histogram.
 - c
 - i On how many days were there fewer than 100 visitors?
 - ii On what percentage of days were there between 50 and 200 visitors?

Class interval	Frequency	Percentage frequency
0–	2	
50–	4	
100–	5	
150–	9	
200–		
250–	3	
Total	30	

Multiple-choice questions

- 1 The probability of not rolling a number less than 3 on a normal six-sided die is:
 A $\frac{1}{3}$ B 4 C $\frac{1}{2}$ D $\frac{2}{3}$ E 3

- 2 From the two-way table, $\Pr(A \cap B)$ is:
 A $\frac{1}{5}$ B 4 C $\frac{9}{20}$
 D $\frac{1}{4}$ E 16

	A	A'	Total
B		7	
B'	5		
Total		11	20

- 3 In the selection of 40 marbles, 28 were blue. The experimental probability of the next one selected being blue is:
 A 0.28 B 0.4 C 0.7 D 0.54 E 0.75

- 4 The median, mean and range of the data set 12 3 1 6 10 1 5 18 11 15 are, respectively:
 A 5.5, 8.2, 1 – 18 B 8, 8.2, 17 C 5.5, 8, 17
 D 8, 8.2, 1 – 18 E 8, 74.5, 18

- Ext** 5 The interquartile range of the data in the box plot shown is:
 A 10 B 27
 C 13 D 30
 E 17

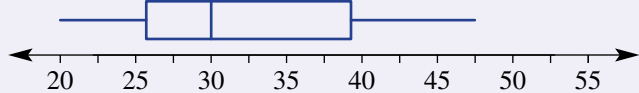
**Extended-response question**

A game at the school fair involves randomly selecting a green ball and a red ball each numbered 1, 2 or 3.

- a List the outcomes in a table.
 b What is the probability of getting an odd and an even number?
 c Participants win \$1 when they draw two balls showing the same number.
 i What is the probability of winning \$1?
 ii If someone wins six times, how many games are they likely to have played?

- Ext** d The ages of those playing the game in the first hour are recorded and are shown below.
 12 16 7 24 28 9 11 17 18 18 37 9 40 16 32 42 14
 i Draw a box plot to represent the data.
 ii Twenty-five per cent of the participants are below what age?
 iii If this data is used as a model for the 120 participants throughout the day, how many would be expected to be aged less than 30?

Introduction to quadratic equations and graphs

Short-answer questions

- Solve the following quadratic equations.

<p>a $(x + 5)(x - 3) = 0$</p> <p>c $4x^2 + 8x = 0$</p> <p>e $x^2 - 9x + 14 = 0$</p>	<p>b $(2x - 1)(3x + 5) = 0$</p> <p>d $5x^2 = 45$</p> <p>f $8x = -x^2 - 16$</p>
---	--
- The length of a rectangular swimming pool is x m and its width is 7 m less than its length. If the area occupied by the pool is 120 m^2 , solve an appropriate equation to find the dimensions of the pool.
- Sketch the following graphs showing the y -intercept and turning point, and state the transformations that have taken place from the graph of $y = x^2$.
 - $y = x^2 + 3$
 - $y = -(x + 4)^2$
 - $y = (x - 2)^2 + 5$
- Consider the quadratic relation $y = x^2 - 4x - 12$.
 - Find the coordinates of the y -intercept.
 - Factorise the relation and find the coordinates of the x -intercepts.
 - Find the coordinates of the turning point.
 - Sketch the graph.

Multiple-choice questions

- The solution(s) to $3x(x + 5) = 0$ is/are:

A $x = -5$	B $x = 0$ or $x = -5$	C $x = 3$ or $x = 5$
D $x = 5$	E $x = 0$ or $x = 5$	
- $x^2 = 3x - 2$ is the same as the equation:

A $x^2 + 3x - 2 = 0$	B $x^2 - 3x + 2 = 0$	C $x^2 - 3x - 2 = 0$
D $-x^2 + 3x + 2 = 0$	E $x^2 + 3x + 2 = 0$	
- The *incorrect* statement about the graph of $y = 2x^2$ is:
 - the graph is the shape of a parabola
 - the point $(-2, 8)$ is on the graph
 - its turning point is at $(0, 0)$
 - it has a minimum turning point
 - the graph is wider than the graph of $y = x^2$
- The type and coordinates of the turning point of the graph of $y = -(x + 3)^2 + 2$ are:
 - a minimum at $(3, 2)$
 - a maximum at $(3, 2)$
 - a maximum at $(-3, 2)$
 - a minimum at $(-3, 2)$
 - a minimum at $(3, -2)$

5 The graph shown has the equation:

- A $y = 4x^2$
- B $y = x^2 + 4$
- C $y = (x + 2)^2$
- D $y = x^2 + 2$
- E $y = (x - 2)^2$

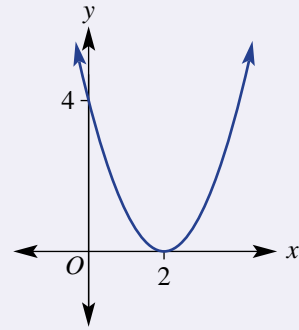

Extended-response question

The flight path of a soccer ball kicked upwards from the ground is given by the equation $y = 120x - 20x^2$, where y is the height of the ball above the ground in centimetres at any time x seconds.

- a Find the x -intercepts to determine when the ball lands on the ground.
- b Find the coordinates of the turning point and state:
 - i the maximum height reached by the ball
 - ii after how many seconds the ball reaches this maximum height.
- c At what times was the ball at a height of 160 cm?
- d Sketch a graph of the path of the ball until it returns to the ground.



Index

- absolute percentage difference/error 37, 333
- accuracy 202, 209, 214, 309, 331–2, 347, 448
- acute angles 480–1
- addition 5, 20–2, 105, 119, 147–8, 360, 462, 598–600
- adjacent side 195
- algebra 123, 208
- algebraic expressions 98, 100, 104–6, 109, 569, 600, 606
- algebraic fractions 589, 593–5, 598, 605–6, 610–11
- alternate angles 489
- alternative method 22, 45, 731
- angle of depression/elevation 220–3
- angle sum 496–7, 499
- angles 194–5, 213, 215, 218–19, 344–5, 480–1, 483–4, 498–9, 506–7, 527, 530
- apex 367
- approximation 14, 461
- area 109, 134, 136, 146, 337, 350–1, 353–5, 359, 361–2, 380, 559, 603–4, 760
- arithmetic mean 673
- arrays 648
- average 673, 686
- axes 255, 267
- axis of symmetry 743, 764, 772
- back-to-back stem-and-leaf plots 679, 681
- backtracking 115
- bars 15
- bases 367, 380, 415–16, 422
- bearings 227–31
- best buys 26, 29
- bias 666–7
- bi-modal datasets 673
- binomial products 559–60, 571, 574, 583
- box plots 701–4
- brackets 5, 98, 109–11, 119–20, 141, 432–4
- branches 655
- calculators 201, 203, 213, 448, 450, 461
- cancelling 21, 104, 437, 563, 593–4
- capacity 381, 389
- cardinal numbers 642
- Cartesian planes 249, 303, 762
- categorical data 667
- categories 635
- census 667
- chance 628, 660
- change, rate of 275
- circles 344–6, 351, 355, 373, 387
- circumference 337, 344–7, 373, 378
- clockwise direction 227
- closed circles 129–30
- clusters 679
- coefficients 99, 582, 733
- cointerior angles 489
- commission 49, 52, 64
- common denominators 15, 20, 606
- common factors 104, 574, 584, 588–9, 594, 729
- comparison 17, 26, 50, 628, 679, 754–6
- compass points 227–8
- complementary angles 482
- complements 481, 629
- composite numbers 5
- composite shapes 359–62
- compound events 628
- compound interest 70–2, 76–8
- compounding period 77
- concave up/down 753, 764
- congruence 503–6, 511–13, 519, 528
- congruent triangles/figures 503–4
- constant (quality) 66
- constant of proportionality 275
- constant terms 99, 248, 260, 277
- conversion 21, 33, 100, 134, 351, 353, 382, 593
- convex polygons 496
- coordinate geometry 249
- coordinate pairs 249
- coordinates 251, 259, 293, 763, 766–8, 774–6
- corresponding angles/sides 488, 504–6, 511, 520, 529, 537
- cosine (cos) 194–5, 201–2
- critical digits 9
- cross-section 218, 367, 380–1, 387
- cube roots 134, 455
- cubes (of numbers) 5, 134
- cubic units 380–1
- cuboids 190–1, 368
- cylinders 373–5, 387–9
- data 666–7, 675, 678, 685–6, 688, 695, 697–8, 701, 704
- data classification 668–9, 688
- data collection 672
- decay 70
- decimal places/points 9–10, 14–15, 33, 174, 203, 209–10, 229–30, 295, 346, 355, 361, 374, 388, 444–5, 454
- decimals 4, 14, 16–17, 32–3, 173, 443, 445
- decrease (amount) 37–8
- degrees 201–2, 213, 215
- denominators 15, 21, 208–9, 599–600, 607, 610, 612
- depreciation 70, 72, 76–7, 79, 454
- depression 220–3
- difference of two squares 563–6, 574–6, 729
- digits 227
- dilations 519–20, 522, 752–3
- direct proportion 275, 277
- direction 227
- discount 43, 45
- distance 134, 219, 266, 294, 302, 378, 387
- distributive law 109, 559, 582, 733
- division 5, 20, 23, 28, 32, 35, 99, 104, 106, 208, 337, 421–4, 437, 461, 463, 593, 595, 729
- dots 15, 259
- double pay 49
- element, of a set 642
- elevation 220–2
- elimination 147–9, 153
- empty sets 642
- endpoints 267, 293–4
- enlargement 519–20, 522, 752
- equally likely (events) 629, 655
- equals sign 114
- equations 114, 119–20, 124, 148, 288–90, 299–300, 421, 610–12
- equivalence 104, 109, 114
- equivalent equations 114–15
- equivalent fractions 15, 21
- error 37, 213, 332–3, 605, 667, 724
- estimation 11, 660
- evaluation 99, 135, 417, 439–40
- events 628, 630, 649–50
- exact values 173–5, 180
- expanding/expanded form 109–11, 119, 416–17, 421, 427, 432–4, 559–60, 564–5, 569, 574, 582, 588–9, 733
- expected number of occurrences 660
- experimental probability 660–1
- exponents 415–16
- expressions 65, 98–101, 145, 153, 415, 432, 438–9, 570, 604
- exterior angles 484
- factorisation 569–71, 574–6, 578–80, 582–4, 588, 590, 603, 729, 733, 760
- factorised form 569
- factors 105, 416, 427, 432, 569, 724
- favourable outcomes 628
- formula 65–6, 76–7, 134–6, 350–1, 381
- fraction form 197
- fractional indices 455–8
- fractions 4, 14, 16–17, 22–3, 32–3, 63, 116, 432–4
- frequency tables 688–91
- geometrical results 511, 513
- geometry 480
- gradient 266–7, 269–71, 275, 281–3, 288, 290, 299, 304
- gradient–intercept form 280–1
- graphs 248, 250, 255, 262, 275, 282–3, 293, 312, 701–2, 742, 752–6, 764
- grids 267
- gross income 49

- grouping 578–80, 588–9, 643, 667
growth 70
- height 218, 381
highest common factor (HCF) 5, 17, 27, 569–70, 593
histograms 688–91
horizontal lines 259–60, 262
horizontal translations 764, 766
horizontals 220–1, 266
hypotenuse 172, 174–5, 195, 504–6, 530
- identities 421
improper fractions 15
income 48, 57, 64
increase (amount) 37–8, 76
index form 416–18, 422
index laws 415, 421–4, 427–9, 432–4, 437, 455, 458
index notation 415–16
indices 5, 416
inequality 129–31
infinite/non-recurring decimals 15
integers 5–6, 20, 444
intercept form 772, 775
intercepts 255–7, 259, 774
interest 65, 67, 70, 76–7
interior angles 497
interpretation 703, 737
interquartile range (IQR) 695
intersection 309, 643
inverse operations 115
inverse sine/cosine/tangent 213–14
inverted graphs 753, 764
investment/period 67, 453
irrational numbers 4, 14–15, 172, 455–6
- kites 351, 497, 519
- labels/labelling 184, 194
leave loading 49
leaves; stems 678–9
left to right convention 5, 267, 448
left-hand side (LHS) 114, 134, 593, 729
length 174, 179–81, 202, 204, 210, 218–19, 293, 295, 337, 379, 387
length of a line segment 294
letters 504, 520, 529, 631
like surds 462
like terms 104–6, 111, 119
limits of accuracy 332–4
line of sight 220
line segments 267, 293–5, 480
linear equations 114–16, 119, 282
linear inequality 129–31
linear modelling 304
linear relations 248, 250, 298, 302–6
lines 129, 252, 259–60, 262, 269–70, 288–90, 480
long-run proportion 660
loss 76
lower bounds 130
lower quartiles 695, 702
- lowest common denominator (LCD) 21, 610
lowest common multiple (LCM) 5, 17, 598
- mark-up 43, 45
matching order 511, 520, 529
mathematical statements 114, 179
maximums/minimums 702, 743
mean 672–3, 675, 695
measurement/error 331–3
measures of centre/location/central tendency 673–4
median 672–3, 678, 695, 702
Medicare levy 57–8
mental strategy 109
metric units 337, 380–1
midpoint 293–5
mixed numbers 15
mode 672–3, 678, 695
models/modelling 304
money 32, 43, 48, 65–6
monic quadratic trinomials 582–3, 733
months 78
multiplication 5, 20–1, 23, 32, 99, 104–5, 208, 337, 415, 421–4, 437, 455, 461, 463, 559, 593, 595, 610
- negative gradients 267, 269–70
negative indices 437, 443–4
negative integers 4–5, 130, 583, 590
negative reciprocal 299
net income 49
nets 367–8, 373
non-convex polygons 496
non-monic trinomials 588
non-parallel lines 488–9
non-recurring decimals 173, 455–6
non-zero digits 444, 448
Null Factor Law 724, 726, 729, 733, 737, 772–3
null sets 642
numbers/number lines 129–31, 445, 450, 457, 599
numerators 15, 598, 607
numerical data 667
- obtuse angles 480–1
open circles 129–30
operations 461
opposite sides 195
order 105, 119, 648, 673, 678
order of operations 5, 99
ordered pairs 249
origin 249, 259–60, 262, 763
original amount 34–5, 39, 45–6, 72
outcomes 628, 648, 656, 660
outliers 673, 695
overtime 49, 51
- pairs 148, 150, 578–80, 588–9
parabolas 742–4, 746, 752–3, 762, 772–3
parallel lines 221, 298–9, 310, 488–92
parallelograms 351, 353, 497
- patterns 14–15, 437, 455, 563
PAYG income tax system 56
per annum 65
percentage change/discount/profit/error 37–9, 43, 46, 332–3
percentage frequency histograms 689
percentages 32, 34, 37, 65
perfect squares 563–5, 733, 735
perimeter 146, 337, 339–40, 344–7, 359, 361
perpendicular lines 298–300
perpendicularity 380–1
pi 337, 345, 350
piecework 49, 52
plane figures 353–4
plots/plotting 250, 746
points 252, 259, 271, 290, 480–1
points of intersection 309–11
polygons 496, 499
population 667
positive gradient 267, 269–70
positive indices 438–9, 443–4
positive integers 4, 583, 644–5
powers 70, 114, 415–16, 422, 427–8, 432–3, 439–40, 443–4
prediction 303
prefixes 444
prime factorisation 416, 418
prime numbers 5
principal 65–7, 70, 76
prisms 367, 380, 383
probability 628–31, 635, 660, 685, 687
problem solving 63, 98, 123–4, 145–6, 184, 201, 213, 218–21, 302–3, 378–9, 453–4, 527–9, 603–4, 685–7, 724, 737–8, 760–2
products 70, 416, 461, 559, 569, 582, 606, 724
profit 43–4, 63–4, 603
pronumerals 98, 105, 109, 114, 119–20, 180–1, 208–10, 432, 483–4, 491, 498, 506–7
proof 511–13, 537–9
proper fractions 15
proportionality 275, 520
pyramids 218–19, 367
Pythagoras' theorem 172, 180, 184–6, 189–91, 218, 294
Pythagorean triad 173
- quadrants 249, 345
quadratic equations 583–4, 724–5, 729–30, 737–8
quadratic trinomials 733–5, 776
quadratics 742–3, 761, 772
quadrilaterals 496–8
quantities 26, 34, 37, 98
quartiles 697–8
quotients 461
- radius 134, 344–5, 387
random selection 628, 654, 657
range 695, 697

- rates 26, 28, 66, 275, 277
 rational numbers 4, 14–15, 20
 ratios 26–8, 63, 201, 214, 520, 530, 537
 rays 480
 real numbers 4, 15
 rearranging (equations/terms) 208, 282, 578, 580, 729
 reciprocals 21, 438, 593
 rectangles 350–1, 353, 367, 373, 497, 603–4
 rectangular prisms 190–1, 368–9
 recurring decimals 15
 reflection 752–3
 reflex angles 480
 regular polygons 497, 527–8
 relative frequencies 660
 repeated products 70
 retainers 49
 revolution 480–1
 rhombuses 351, 354, 497
 right angles 480, 504–6, 530
 right cylinders 387
 right prisms 367, 380, 387
 right pyramids 367, 369
 right square-based pyramids 218–19, 369
 right-angled triangles 172–4, 179–80, 184, 189–90, 195, 213, 220–1
 right-hand side (RHS) 114, 504–6, 530, 593
 rise and run 266–7, 288
 root signs 455–7
 rotation 752
 rounding 9–11, 63, 174, 219, 374, 379, 389
 royalties 49
 rules 5, 65, 134, 248, 259, 275, 280, 288, 350, 387, 454, 461, 603, 746, 752, 760–1, 766, 772
 salary 49–50
 sample spaces 628, 642–3, 648–50, 654–5
 sampling/methods 666–7, 669
 scale factor 519–20, 523, 537
 scientific notation 443–5, 448, 450, 453–4
 sectors 344–5, 350–1, 355
 semicircles 345, 375
 set brackets 628
 set notation 642, 644–5
 sets 4, 130, 644–5, 701, 704
 shapes 339, 347, 359–60
 sides (shapes) 496–7
 sides (triangles) 172, 179–81, 194–5, 201–2, 204, 213, 337, 340, 480, 504–6, 530
 sign 148, 455–7, 583
 significant figures 9–11, 448–50, 453–4
 similar figures 519–20
 similar triangles 529–32, 537–9
 similarity 520, 529, 531–2, 539–40
 simple interest 65–7
 simple random sampling 667
 simplifying 27–8, 104–6, 111, 421, 423–4, 427–30, 432, 458, 461, 565–6, 593–5, 598, 605–7
 simultaneous equations 140–2, 147–50, 153–5, 309–10, 312
 sine (sin) 194–5, 201–2
 skewed/symmetrical data 679, 689
 slope 218, 266
 SOHCAHTOA 195
 solids 189, 367, 383
 solution sets 130
 solution/solving 20, 114–16, 119, 123–4, 131, 140–2, 147–50, 153–5, 189, 203, 208, 218, 309–10, 360, 611, 724, 726, 729, 733–4
 spread 695, 702
 square roots 134, 455, 729
 square-based pyramids 368
 squares 351, 497
 squares (of numbers) 5, 134, 172
 standard form 724–5
 statistics 666, 672, 685
 steepness 266
 stem-and-leaf plots 678, 680
 straight lines 248–50, 255, 289, 480
 stratified sampling 667
 subjects 134, 208
 subsets 642–3
 substitution 101, 115, 134–5, 140–2, 147–8, 153, 180, 260, 288, 593, 773
 subtraction 5, 20–2, 105, 119, 147–8, 360–2, 461–2, 598–600
 sum 367, 481, 497
 supplementary angles 482
 supplements 481
 surds 173, 180, 455–6, 461–3
 surface area 367, 369, 373–5, 378–9
 surveys 666–7
 symbols 14, 104, 345, 520
 systematic sampling 667
 tables (of values) 194, 250, 742
 tangent (tan) 194–5, 201–2
 taxation 48–9, 56–8, 64
 terminating decimals 15
 terms 99, 104–6, 148, 582, 600
 theoretical probabilities 660
 three-dimensional objects 367
 three-dimensional problems 189–91
 time 65–6, 134, 248
 time and a half 49
 transformation 752, 763
 translation 763–4, 767–8
 transposing 134, 136
 transversals 488
 trapeziums 351, 354, 497
 tree diagrams 654–7, 687
 trials 213, 453, 660, 685, 724
 triangles 351, 353, 480–1, 483, 512–13, 531
 trigonometric ratios 194–5, 197, 203, 208, 210
 trigonometry 220–1, 224, 229–30
 trinomials 588, 590
 true bearings 227–9
 true equations 421
 turning points/form 743, 753, 763–8, 773, 775–6
 two-dimensional problems 184
 two-dimensional shapes 496
 two-step experiments 648
 two-way tables 635, 638
 undefined gradient 267, 269–70
 union (probability) 643
 unitary method 26, 32, 34
 units 26, 65, 351, 353, 382, 444
 unknown values/variables 98, 123, 136, 140, 179–80, 184, 189, 194–5, 201–4, 210, 213, 215, 340, 483, 505–6, 532, 537, 737
 unlike terms 105
 upper bounds 130
 upper quartiles 695, 702
 upright graphs 753, 764
 values 15, 26, 70, 72, 76, 101, 134, 147–8, 180–1, 210, 288, 332, 421, 454, 483–4, 491, 498, 506–7, 675, 697–8, 702
 variables 98, 120, 123, 134, 141, 147–8, 153, 421, 737
 Venn diagrams 635–7, 642–3, 685
 vertical lines 259–60, 262, 267
 vertical translations 764, 766
 vertically opposite angles 481
 vertices 337, 743, 753
 volume 248, 337, 380–3, 387–8
 wage 49–50
 whole numbers 15, 21, 173
 without/with replacement 648–50, 657
 worded problems 123–4, 153, 155
 x-axis 249
 x-intercept 249, 251, 255–7, 743, 772–6
 y-axis 249
 years 65, 70
 y-intercept 249, 251, 255–7, 281–3, 288–9, 743, 765–8, 773–6
 zero 724
 zero gradient 267, 269–70
 zero index 427–9

Working with unfamiliar problems: Part 1

- 1 a 9999999800000001
b 99999999000000001
- 2 31 lockers open
1, 4, 9, 16, 25, 36, 49, 64, 81, 100, 121, 144, 169, 196, 225, 256, 289, 324, 361, 400, 441, 484, 529, 576, 625, 676, 729, 784, 841, 900, 961
- 3 61
- 4 12, 23, 34, 45, 56, 67, 78 and 89
- 5 85 km; Adina: 20 km, 53.13°; Birubi: 65 km, 306.87°
- 6 $\frac{1}{3}$
- 7 approximately 70 days
- 8 Answers may vary.
- 9 20% 10 $x = 15$ 11 48 12 72
- 13 6 m, 11 m
- 14 a one revolution of a spiral
b 6.18 m c 75.82 m
- 15 49 16 254 17 $\frac{x}{y}$

Working with unfamiliar problems: Part 2

- 1 $x = 1$ and $y = 3$
- 2 any prism with a quadrilateral cross-section (e.g. cube, rectangular prism, trapezoidal prism), heptagonal pyramid, truncated rectangular pyramid
- 3 $x = 20$
- 4 $2n - 1 + 2m - 1 = 2(n + m - 1)$, which is a multiple of two and is therefore even where m and n are integers
- 5 $xy = 24$ 6 98° 7 $n + 2\sqrt{n} + 1$
- 8 a $64 \text{ cm}^2, 32 \text{ cm}^2, 16 \text{ cm}^2, 8 \text{ cm}^2, 4 \text{ cm}^2$
 $2^6, 2^5, 2^4, 2^3, 2^2$
b $2^1, 2^0, 2^{-1}, 2^{-2}, 2^{-3}; 1 \text{ cm}^2, \frac{1}{8} \text{ cm}^2$
c $A = 2^{7-n}; \frac{1}{256}$
- 9 7 : 5 : 3
- 10 2
- 11 Sam 36 years, Noah 12 years
- 12 20 cm^2
- 13 a 3^{x-1} b 0
- 14 a 96 cm^3 b $24\frac{1}{40} \text{ unit}^2$
- 15 7 or -4
- 16 $2\frac{1}{2}$ hours, $\frac{3}{4}$ hour 17 5 : 2

Chapter 1

1A

Building understanding

- 1 a 1, 2, 4, 7, 8, 14, 28, 56 b HCF = 8
c 3, 6, 9, 12, 15, 18, 21 d LCM = 15
e 2, 3, 5, 7, 11, 13, 17, 19, 23, 29
- 2 a 121 b 12 c 27 d 2
- 3 a -1 b -1 c 15
d -6 e 22 f -9

Now you try

Example 1

- a 5 b 4 c -65

Exercise 1A

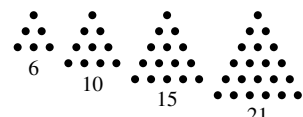
- 1 a 2 b 2 c 10 d 16
e -9 f -3 g -4 h 10
i -11 j 2 k -3 l 4
m -23 n 10 o 0 p 3
q -9 r 7 s -1 t 4
- 2 a 28 b 24 c 187 d 30
- 3 a 4 b 5 c 1 d 23
- 4 a 4 b 23 c -3
d 2 e -2 f -18
g -6 h -1 i 1
- 5 a -2 b -38 c -8
d 27 e 1 f 24
g 21 h 0 i 24
- 6 a $-2 \times [11 + (-2)] = -18$ b $[-6 + (-4)] \div 2 = -5$
c $[2 - 5] \times (-2) = 6$ d $-10 \div [3 + (-5)] = 5$
e $3 - [(-2) + 4] \times 3 = -3$
f $[(-2)^2 + 4] \div (-2) = -2^2$
- 7 252 days
- 8 4
- 9 a 7 and -2 b -5 and 2
- 10 8
- 11 a i 16 ii 16
b $a = \pm 4$
c $a = 3$
d The square of a negative number has negative signs occurring in pairs and will create a positive answer.
e -3
f The squaring of any number produces a positive answer.
- g i -4 ii -125
iii -9 iv -16
h no
i yes
j A prime number has only two factors - itself and 1, therefore the only common factor for any pair of prime numbers is 1.
k Again as there are only two factors of any prime, the LCM must be the multiple of primes.
- 12 a false b false c true
d true e false f true
- 13 a i $1 + 2 + 3 = 6$
ii $28(1 + 2 + 4 + 7 + 14 = 28)$
iii $1 + 2 + 4 + 8 + 16 + 31 + 62 + 124 + 248 = 496$
b i 
ii 28, 36
c i 0, 1, 1, 2, 3, 5, 8, 13, 21, 34
ii -21, 13, -8, 5, -3, 2, -1, 1, 0, 1...
 $\therefore -21, -8, -3, -1$

1B

Building understanding

- 1 a 40 b 270 c 7.9 d 0.04
 2 a 32 100 b 432 c 5.89 d 0.443
 3 a 60 b 57.375 c 2.625

Now you try

- Example 2
 a 138.47 b 0.03 c 2.80

- Example 3
 a 3600 b 49 000 c 0.029

- Example 4
 26, -25.85792

Exercise 1B

- 1 a i 124.27 ii 830.44
 b i 0.02 ii 0.07
 c i 7.69 ii 13.50
- 2 a 17.96 b 11.08 c 72.99
 d 47.86 e 63.93 f 23.81
 g 804.53 h 500.57 i 821.27
 j 5810.25 k 1005.00 l 2650.00
- 3 a 7 b 73 c 130 d 36 200
 4 a 0.333 b 0.286 c 1.182 d 13.793
 5 a 2400 b 35 000 c 0.060 d 34
 e 110 000 f 0.0025 g 2.1 h 0.71
 6 a 30 000 b 200 c 0.05 d 0.0006
 7 a 3600, 3693 b 760, 759.4
 c 4000, 4127.16 d 3000, 3523.78
 e 0, 0.72216 f 4, 0.716245
 g 0.12, 0.1186 h 0.02, 0.02254
 i 10, 8.4375 j 1600, 1683.789156
 k 0.08, 0.074957... l 11, 10.25538...
- 8 a A: 54.3, B: 53.8, 0.5 b A: 54.28, B: 53.79, 0.49
 c A: 54, B: 54, 0 d A: 50, B: 50, 0
- 9 a each to 1 significant figure
 b each to 2 significant figures
 c each to the nearest integer
- 10 8.33 m
 11 0.143 tonnes
 12 2.14999 is closer to 2.1 correct to 1 decimal place
 ∴ round down
- 13 as magnesium in this case would be zero if rounded to two decimal places rather than 2 significant figures
- 14 a i 50 ii 624
 b 50
 c 600
 d The addition is the same as the original but the multiplication is lower ($20 \times 30 < 24 \times 26$). When rounding the two numbers to one sig fig, you are changing the numbers by the same amount in opposite directions, so the sum will stay the same, but product will differ

- 15 a 0.18181818
 b i 8 ii 1 iii 8
 c 0.1428571428571
 d i 4 ii 2 iii 8
 e not possible

1C

Building understanding

- 1 a $1\frac{2}{5}$ b $4\frac{1}{3}$ c $4\frac{4}{11}$
 2 a $\frac{11}{7}$ b $\frac{16}{3}$ c $\frac{19}{2}$
 3 a $\frac{2}{5}$ b $\frac{4}{29}$ c $4\frac{1}{6}$
 4 a 9 b 24 c 3 d 10

Now you try

- Example 5
 a 4.625 b $0.\overline{18}$

- Example 6
 a $\frac{9}{20}$ b $1\frac{17}{40}$

- Example 7
 $\frac{7}{11}$

Exercise 1C

- 1 a 2.75 b 0.35 c 2.3125
 d 1.875 e 2.625 f 3.8
 g 3.4 h 1.21875
- 2 a 0.27 b 0.7 c $1.\overline{285714}$
 d 0.416 e 1.1 f 3.83
 g 7.26 h $2.\overline{63}$
- 3 a $\frac{7}{20}$ b $\frac{3}{50}$ c $3\frac{7}{10}$
 d $\frac{14}{25}$ e $1\frac{7}{100}$ f $\frac{3}{40}$
 g $3\frac{8}{25}$ h $7\frac{3}{8}$ i $2\frac{1}{200}$
 j $10\frac{11}{250}$ k $6\frac{9}{20}$ l $2\frac{101}{1000}$
- 4 a $\frac{5}{6}$ b $\frac{13}{20}$ c $\frac{7}{10}$
 d $\frac{5}{12}$ e $\frac{7}{16}$ f $\frac{11}{14}$
 g $\frac{19}{30}$ h $\frac{11}{27}$
- 5 a $\frac{5}{12}, \frac{7}{18}, \frac{3}{8}$ b $\frac{5}{24}, \frac{3}{16}, \frac{1}{6}$ c $\frac{7}{12}, \frac{23}{40}, \frac{8}{15}$
 6 a $\frac{9}{20}$ b $\frac{3}{20}$ c $\frac{32}{45}$ d $\frac{23}{75}$
 7 a $\frac{11}{6}, \frac{7}{3}$ b $\frac{2}{5}, \frac{2}{15}$ c $\frac{11}{12}, \frac{12}{12}$ d $\frac{5}{7}, \frac{11}{14}$
- 8 Weather forecast
 9 a $\frac{3}{5}$ b $\frac{5}{9}$ c $\frac{8}{13}$ d $\frac{23}{31}$

- 10 a 31, 32 b 36, 37, 38, ..., 55
 c 4, 5 d 2, 3
 e 43, 44, 45, ..., 55 f 4, 5, 6

11 $\frac{ac+b}{c}$

- 12 a yes, e.g. $\frac{7}{14} = \frac{1}{2}$ and 7 is prime
 b no as a and b will have no common factors other than one
 c no as then a factor of 2 can be used to cancel

d yes, e.g. $\frac{5}{7}$

- 13 a $\frac{8}{9}$ b $\frac{2}{9}$ c $\frac{9}{11}$ d $3\frac{43}{99}$
 e $9\frac{25}{33}$ f $\frac{44}{333}$ g $2\frac{917}{999}$ h $13\frac{8125}{9999}$

1D

Building understanding

- 1 a 6 b 63 c 4 d 60
 2 a $\frac{7}{3}$ b $\frac{39}{5}$ c $\frac{41}{4}$
 3 a $\frac{9}{6} + \frac{8}{6} = \frac{17}{6}$ b $\frac{4}{3} - \frac{2}{5} = \frac{20}{15} - \frac{6}{15} = \frac{14}{15}$
 c $\frac{5}{3} \times \frac{7}{2} = \frac{35}{6}$
 4 a $\frac{1}{5}$ b 4 c $\frac{3}{2}$ d $\frac{4}{5}$

Now you try

Example 8

- a $\frac{11}{15}$ b $\frac{41}{8}$ or $5\frac{1}{8}$ c $\frac{37}{20}$ or $1\frac{17}{20}$

Example 9

- a $\frac{12}{35}$ b $\frac{23}{3}$ or $7\frac{2}{3}$

Example 10

- a $\frac{5}{6}$ b $\frac{46}{33}$ or $1\frac{13}{33}$

Exercise 1D

- 1 a $\frac{3}{5}$ b $\frac{4}{9}$ c $1\frac{2}{7}$ d $\frac{19}{20}$
 e $\frac{19}{21}$ f $1\frac{7}{40}$ g $\frac{7}{10}$ h $\frac{17}{27}$
 2 a $\frac{2}{5}$ b $\frac{1}{45}$ c $\frac{11}{20}$ d $\frac{1}{10}$
 e $\frac{1}{18}$ f $\frac{1}{8}$ g $\frac{13}{72}$ h $\frac{5}{48}$
 3 a 5 b $3\frac{2}{5}$ c $5\frac{1}{7}$
 d $6\frac{11}{15}$ e $7\frac{17}{63}$ f $17\frac{13}{16}$
 4 a $1\frac{1}{2}$ b $\frac{3}{4}$ c $\frac{13}{20}$
 d $\frac{29}{40}$ e $\frac{5}{6}$ f $1\frac{16}{77}$
 5 a $\frac{6}{35}$ b $\frac{1}{2}$ c $\frac{1}{12}$ d $\frac{4}{9}$
 e $4\frac{1}{2}$ f $5\frac{1}{3}$ g $7\frac{1}{2}$ h 5
 i 15 j 26 k $\frac{2}{3}$ l $\frac{5}{6}$
 m $2\frac{1}{4}$ n $3\frac{1}{2}$ o 6 p $1\frac{1}{3}$

- 6 a $\frac{20}{21}$ b $1\frac{1}{8}$ c $\frac{45}{56}$ d $\frac{27}{28}$
 e $1\frac{1}{3}$ f $1\frac{1}{2}$ g 6 h $\frac{7}{8}$
 i 18 j 9 k 16 l 64
 m $\frac{1}{10}$ n $\frac{1}{12}$ o $\frac{4}{27}$ p $3\frac{1}{3}$
 q 4 r $\frac{1}{6}$ s $1\frac{1}{2}$ t $\frac{7}{8}$

7 $\frac{7}{8}$ tonnes

8 $5\frac{29}{56}$ tonnes

9 $\frac{5}{12}$ hours (25 min)

- 10 a $\frac{2}{7}$ b $\frac{8}{15}$ c 16
 d $\frac{66}{85}$ e $2\frac{10}{21}$ f $\frac{3}{13}$

11 7 truckloads

12 3 hours

13 $\frac{5}{6}$ problem is the use of negatives in the method since $\frac{1}{3} < \frac{1}{2}$

- 14 a $\frac{b}{a}$ b $\frac{c}{ac+b}$
 15 a 1 b $\frac{a^2}{b^2}$ c 1
 d $\frac{c}{a}$ e a f $\frac{c}{b}$

- 16 a $-\frac{2}{3}$ b $\frac{5}{4}$ c $\frac{83}{10}$ d 1
 e $\frac{50}{31}$ f $\frac{81}{400}$ g $\frac{329}{144}$ h $\frac{969}{100}$
 i $\frac{583}{144}$ j $\frac{5}{11}$

1E

Building understanding

- 1 a 4 b 12 c 11 d 3
 2 a 9 b $\frac{4}{9}$ c $\frac{5}{9}$ d 8 e 10
 3 a i 240 km ii 40 km iii 520 km
 b i 5 h ii $4\frac{1}{2}$ h iii 15 min
 4 a \$4 b \$3 c \$2.50

Now you try

Example 11

- a 3 : 2 b 16 : 9 c 5 : 3

Example 12

\$200

Example 13

- a 35 km/h b 400 revs/min

Example 14

- a 7 kg bag b juice B

Exercise 1E

- 1 a 1 : 5 b 2 : 5 c 3 : 2 d 4 : 3
 e 9 : 20 f 45 : 28 g 3 : 14 h 22 : 39
 i 1 : 3 j 1 : 5 k 20 : 7 l 10 : 3

- 2 a 1 : 10 b 1 : 5 c 2 : 3
 d 7 : 8 e 25 : 4 f 1 : 4
 g 1 : 4 h 24 : 5 i 4 : 20 : 5
 j 4 : 3 : 10 k 5 : 72 l 3 : 10 : 40
- 3 a \$200, \$300 b \$150, \$350
 c \$250, \$250 d \$175, \$325
- 4 a \$10, \$20, \$40 b \$14, \$49, \$7 c \$40, \$25, \$5
- 5 a 15 km/h b 2000 rev/min
 c 45 strokes/min d 14 m/s
 e 8 mL/h f 92 beats/min
- 6 a 55 km b $16\frac{1}{2}$ km c $5\frac{1}{2}$ km
- 7 a 3 kg deal b Red Delicious
 c 2.4 L d 0.7 GB
- 8 a coffee A: \$3.60, coffee B: \$3.90
 Therefore, coffee A is the best buy.
 b pasta A: \$1.25, pasta B: \$0.94
 Therefore, pasta B is the best buy.
 c cereal A: \$0.37, cereal B: \$0.40
 Therefore, cereal A is the best buy.
- 9 120
- 10 \$3000, \$1200, \$1800 respectively
- 11 \$15.90
- 12 108 L
- 13 \$1.62
- 14 1 : 4
- 15 36° , 72° , 108° , 144°
- 16 Find cost per kilogram or number of grams per dollar.
 Cereal A is the best buy.
- 17 a false b false c true d true
- 18 a $a + b$ b $\frac{a}{a + b}$ c $\frac{b}{a + b}$
- 19 a i 100 mL ii 200 mL
 b i 250 mL ii 270 mL
 c i 300 mL ii 1 : 4
 d i 1 : 3 ii 7 : 19
 iii 26 : 97 iv 21 : 52
 e jugs 3 and 4

1F**Building understanding**

- 1 a $\frac{3}{100}$ b $\frac{11}{100}$ c $\frac{7}{20}$ d $\frac{2}{25}$
 2 a 0.04 b 0.23 c 0.86 d 0.463
 3 a 50% b 25% c 75% d 20%

Now you try

Example 15

- a 75% b 0.6 c $\frac{11}{400}$

Example 16

12.5%

Example 17

\$8.40

Example 18

\$300

Exercise 1F

- 1 a 34% b 40% c 6% d 70%
 e 100% f 132% g 109% h 310%
- 2 a 0.67 b 0.3 c 2.5 d 0.08
 e 0.0475 f 0.10625 g 0.304 h 0.4425
- 3 a $\frac{67}{100}$ b $\frac{3}{10}$ c $2\frac{1}{2}$ d $\frac{2}{25}$
 e $\frac{19}{400}$ f $\frac{17}{160}$ g $\frac{38}{125}$ h $\frac{177}{400}$

Percentage	Fraction	Decimal
10%	$\frac{1}{10}$	0.1
50%	$\frac{1}{2}$	0.5
5%	$\frac{1}{20}$	0.05
25%	$\frac{1}{4}$	0.25
20%	$\frac{1}{5}$	0.2
12.5%	$\frac{1}{8}$	0.125
1%	$\frac{1}{100}$	0.01
11.1%	$\frac{1}{9}$	0.1
22.2%	$\frac{2}{9}$	0.2
75%	$\frac{3}{4}$	0.75
15%	$\frac{3}{20}$	0.15
90%	$\frac{9}{10}$	0.9
37.5%	$\frac{3}{8}$	0.375
$33\frac{1}{3}\%$	$\frac{1}{3}$	0.3
$66\frac{2}{3}\%$	$\frac{2}{3}$	0.6
62.5%	$\frac{5}{8}$	0.625
16.6%	$\frac{1}{6}$	0.16

- 5 a 25% b $33\frac{1}{3}\%$ c 16%
 d 200% e 2800% f 25%
- 6 a \$36 b \$210 c 48 kg
 d 30 km e 15 apples f 350 m
 g 250 people h 200 cars i \$49
- 7 a \$120 b \$700 c \$300
 d \$7 e \$0.20 f \$400
- 8 a \$540 b \$600 c \$508
 d \$1250 e \$120 f \$40
- 9 $16\frac{2}{3}\%$
- 10 $6\frac{1}{4}\%$

- 11 48 kg
 12 15 students
 13 9 students
 14 \$1150
 15 a $P = 100$ b $P < 100$ c $P > 100$
 16 a $x = 2y$ b $x = 5y$
 c $x = \frac{3}{5}y$ (or $5x = 3y$) d $14x = 5y$
 17 a 72 b $\frac{10}{11}$ c 280%
 d $3\frac{1}{4}$ e 150%

1G

Building understanding

- 1 a 1.4 b 21% c 0.27 d 6%
 2 a \$30 b 25%
 3 a 12 kg b 11.1%

Now you try

Example 19
 \$50

Example 20
 \$4.76

Example 21
 a 25% b 12%

Example 22
 227 m²

Exercise 1G

- 1 a \$52.50 b 37.8 min (37 min 48 s)
 c 375 mL d 1.84 m
 e 27.44 kg f 36 watts
 g \$13 585 h \$1322.40
 2 a 19.2 cm b 24.5 cm
 c 39.06 kg d 48.4 min (49 m in 24 s)
 e \$78.48 f 202.4 mL
 g 18°C h \$402.36
 3 50% 4 44% 5 28% 6 4%
 7 a 22.7% b 26.7% c 30.9% d 38.4%
 8 \$21.50 9 30 068 10 \$14 895
 11 a 10% b 12.5% c 16% d 9.375%
 12 \$10.91
 13 \$545.45
 14 a \$900
 b \$990
 c As 10% of 1000 = 100 but 10% of 900 = 90
 15 25% 16 100% 17 42.86%
 18 a \$635.58 b \$3365.08
 c \$151.20 d \$213.54
 19 a 79.86 g b \$97 240.50
 c \$336 199.68 d 7.10 cm

Progress quiz

- 1 a -54 b 8
 2 a 3.46 b 45.9
 c 0.0079 d 46 800 000
 3 a 0.75 b 0.8 c 0.35 d 0.3
 4 a $\frac{9}{10}$ b $\frac{17}{20}$ c $\frac{1}{8}$
 5 a $1\frac{1}{3}$ b $\frac{4}{21}$ c $1\frac{1}{5}$ d $2\frac{1}{12}$
 6 a 5 : 9 b 30 : 1 c 20 : 3 d 3 : 32
 7 a \$250, \$150
 b 1.8 kg, 4.2 kg
 c $266\frac{2}{3}$ cm, $333\frac{1}{3}$ cm, 400 cm
 8 a \$70/h b 80 km/h
 9 B
 10 a 80% b 96% c 375% d 8%
 11 2040 cm
 12 \$400
 13 a \$504 b 475 kg
 14 40%
 15 850 L

1H

Building understanding

- 1 \$3 profit, \$2.50 loss, \$7.30, \$2070
 2 a 90% b 85%

Now you try

Example 23
 a \$144 b 45%

Example 24
 \$16.80

Example 25
 \$171.36

Example 26
 \$40 000

Exercise 1H

- 1 a \$75 b 15%
 2 a i \$2 ii 20%
 b i \$5 ii 25%
 c i \$16.80 ii 14%
 d i \$2450 ii 175%
 3 166.67% 4 40% 5 \$37.50
 6 \$1001.25 7 42.3% 8 \$148.75
 9 \$760.50 10 \$613.33 11 \$220
 12 increased by 4%
 13 25%
 14 a \$54.75 b 128%
 15 No, both methods give the same price. Whichever order you use you'll still multiply the original amount by the same two values, and multiplication is commutative.
 16 \$2100

- 17 a i \$54 187.50 ii \$33 277.90
 b 10 years
 18 a \$34 440 b \$44 000 c \$27 693.75
 d \$32 951.10 e \$62 040 f \$71 627.10

1I

Building understanding

- 1 a \$3952 b \$912 c \$24
 2 a \$79.80 b \$62.70 c \$91.20 d \$102.60
 3 a \$200 b \$900

Now you try

- Example 27
 a \$2394.23 b Gary c \$67 080

- Example 28
 a \$418 b \$16.50

- Example 29
 a \$1299.50 b \$20

Exercise 1I

- 1 a \$1826.92 b Georgia c \$37 606.40
 2 a i \$19.50 ii \$27 iii \$42.50
 b i \$30 201.60 ii \$44 044 iii \$20 134.40
 3 a \$165.60 b \$239.20 c \$368
 d \$552 e \$515.20 f \$809.60
 4 a 7 b 18 c 33
 d 25 e 37 f 40
 5 \$14.50 per hour
 6 \$12.20 per hour
 7 \$490
 8 \$4010
 9 \$0.06
 10 \$25
 11 Cate, Adam, Ed, Diana, Bill
 12 \$839.05
 13 \$1239.75
 14 4.58%
 15 \$437.50
 16 a 12 hours b 9 and 2, 6 and 4, 3 and 6
 17 a i \$920 ii \$1500
 b i $A = 0.02x$
 ii $A = 1200 + 0.025(x - 60\,000)$ or $0.025x - 300$
 18 a \$5500
 b Choose plan A if you expect that you will sell less than \$5500 worth of jewellery in a week and plan B if you expect to sell more than \$5500.
 19 a i Superannuation is a system in which part of your salary is set aside for your retirement.
 ii It is compulsory in the hope that when workers retire they will have enough funds for a comfortable retirement and will not require the age pension, which is funded by taxpayers.

- iii 9.5%
 iv It is invested by the people who manage superannuation funds, in the hope that the funds will grow rapidly over time.
 b No
 c \$8312
 d 27.02% (to 2 decimal places)
 e 27

1J

Building understanding

- 1 Taxable income = **gross** income minus **tax deductions**.
 2 False
 3 Anything from \$0 to \$18 200
 4 30 cents

Now you try

- Example 30
 a \$128 200 b \$30 052
 c \$2564 d \$32 616
 e 25.4% (to 1 d.p.)
 f. Bella receives a tax refund of \$2384.

Exercise 1J

- 1 a. \$91 600 b. \$19 072 c. \$1832
 d. \$20 904 e. 22.8%
 f. He needs to pay another \$904.
 2 a \$2242 b \$9592
 c \$36 592 d \$51 592

3

Taxable income	\$0	\$18 200	\$45 000	\$200 000	\$250 000
Tax payable	\$0	\$0	\$5092	\$51 592	\$74 092

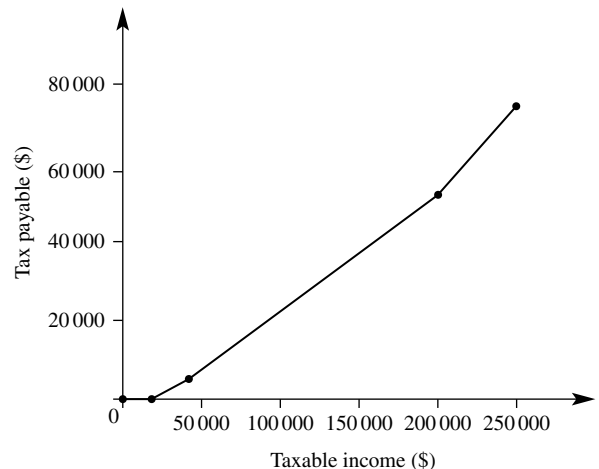

- 4 \$5092
 5 a \$65 625
 b \$11 279.50
 c \$13 12.50
 d \$12 592
 e 19.2% (to 1 decimal place)
 f Refund due of \$478
 6 \$87 500
 7 \$6172.84
 8 \$103 766.67
 9 a i \$2000 ii \$11 500 iii \$35 000

b

Income	Rate	Tax payable
\$40 001 – \$90 000	25%	\$3750 + 25% of (income – \$40 000)
\$90 001 –	33%	\$16 250 + 33% of (income – \$90 000)

- c i \$2000 ii \$6300
 iii \$24 000 iv \$40 000.50
 d An extra dollar of income can push you into a higher tax bracket where you don't just pay the higher tax rate on the dollar but on your entire income. No incentive to earn more.
 10 Gross income is the total income earned before tax is deducted. Taxable income is found by subtracting tax deductions from gross income.
 11 If a person pays too much tax during the year, they will receive a tax refund. If they do not pay enough tax during the year, they will have a tax liability to pay.
 12 They only pay 45 cents for every dollar over \$200 000.
 13 a Answers will vary.
 b i \$15 592
 ii \$30, so this means the \$100 donation really only cost you \$70.

1K

Building understanding

- 1 a i 3 ii 1.5 iii 5.5
 b i 48 ii 30 iii 87
 2 a \$50 b \$60 c \$240
 3 a \$12 000 b 6% p.a. c 3.5 years
 d \$720 e \$1440 f \$2520

Now you try

- Example 31
 \$420
 Example 32
 \$4550, \$24 550
 Example 33
 9 months

Exercise 1K

- 1 a \$3600 b \$416
 2 \$600 3 \$2700, \$17 700
 4 \$1980, \$23 980 5 \$2560
 6 9 months 7 16 months
 8 \$2083.33 9 Choice 2
 10 a \$14 400 b \$240
 11 10%
 12 a \$P b 12.5%
 c i 20 years ii 40 years iii double
 13 a \$51 000 b 4 years
 14 a $P = \frac{100I}{rt}$ b $t = \frac{100I}{Pr}$ c $r = \frac{100I}{Pt}$
 15 a \$1750 a month b \$18 000
 c \$6000 d 2%

1L

Building understanding

- 1 a \$200 b \$2200 c \$220
 d \$2420 e \$242 f \$2662
 2 a 2731.82 b 930.44
 c 2731.82 d 930.44
 3 a $4000 \times (1.2)^3$
 b $15000 \times (1.07)^6$
 c $825 \times (1.11)^4$

Now you try

- Example 34
 \$6749.18
 Example 35
 \$25 207
 Example 36
 \$1654.10

Exercise 1L

- 1 \$4282.32
 2 a \$6515.58 b \$10314.68
 c \$34 190.78 d \$5610.21
 3 \$293 865.62
 4 a 21.7% b 19.1% c 136.7% d 33.5%
 5 \$33 776
 6 a \$23 558 b \$33 268
 c \$28 879 d \$25 725
 7 a \$480 b \$22 185
 c \$9844
 8 \$543 651
 9 6142 people
 10 6.54 kg
 11 trial and error gives 12 years
 12 trial and error gives 5 years

- 13 a 35%
b 40.26%
c It calculates each year's interest on the original \$400 not the accumulated total that compound interest uses.
- 14 a 15.76% b 25.44%
c 24.02% d 86.96%
e $\left(1 + \frac{r}{100}\right)^t - 1 \times 100\%$
- 15 a \$7509.25 b 9.39% p.a.
16 a 70.81% b 7.08%
17 a 5.39% p.a. b 19.28% p.a.

1M

Building understanding

1 C

Year	Value at start of year	10% depreciation	Value at end of year
1	\$20 000	\$2000	\$18 000
2	\$18 000	\$1800	\$16 200
3	\$16 200	\$1620	\$14 580
4	\$14 580	\$1458	\$13 122

3 C

Now you try

Example 37

- a \$6215.95 b \$2215.95

Example 38

\$28 892.30

Example 39

\$29 524.50

Exercise 1M

- 1 a \$8508.54 b \$1508.54
2 a \$5909.82 b \$2341.81
c \$31 737.49 d \$10770.33
e \$1270.29 f \$399.07
g \$87 045.75 h \$2704 813.83
- 3 a \$6448.90 b \$5635.80
c \$19629.68 d \$1119.92
e \$100 231.95 f \$35 905.58
- 4 a \$116 622 b \$18 946
c \$9884 d \$27 022
e \$18 117 f \$18 301
- 5 a \$48 b \$49.44 c \$50.86
- 6 a \$555.13
b 5.7 years
c 7.4% p.a.
- 7 a \$3.83 b \$4.10 c \$2.00
d \$133.05 e \$8.86
- 8 \$20887.38

- 9 a i \$1236
ii \$1255.09
iii \$1264.93
iv \$1271.60
v \$1274.86

b The more compounding periods, the more interest is earned over time.

10 9.01% p.a.

11 Answers can vary – some examples of possible scenarios are shown here.

- a \$300 at 7% p.a. for 12 years compounded annually or \$300 at 84% p.a. compounded monthly for 1 year
b \$300 at 2% p.a. compounded annually for 36 years or \$300 at 24% p.a. compounded monthly for 3 years or \$300 at 8% p.a. compounded quarterly for 9 years
c \$1000 at 0.5% p.a. compounded annually for 48 years or \$1000 at 6% p.a. compounded monthly for 4 years
d \$1000 depreciating at 5% p.a. for 5 years
e \$9000 depreciating at 20% p.a. for 3 years

12 a \$2155.06

b \$4310.13, yes

c \$2100, no

d Doubling the principal doubles the interest.

e Doubling the interest rate and halving the time period does not produce the same amount of interest on the investment.

13 a i \$60 ii \$60.90 iii \$61.36

iv \$61.68 v \$61.76 vi \$61.83

b As the interest is being added back onto the principal at a faster rate, then the more compounding periods used, the more interest is earned over time.

14 a

n	1	2	3	4	5
$(1.09)^n$	1.09	1.188	1.295	1.412	1.539
	6	7	8	9	
	1.677	1.828	1.993	2.17	

b i Approx. 9 years

ii Approx. 6 years

iii Approx. 4 years

c 26% p.a. compounded annually

d 72 (it is known as the rule of 72)

e i 36% p.a. ii 16% p.a. iii 7.2% p.a.

f years \times rate = 144

g The rule of 72 still applies.

Problems and challenges

1 Discuss the answer with classmates as more than one answer for each may be possible. Some suggestions are given below (be creative).

$$(4 - 4) \times (4 + 4) = 0 \qquad (4 - 4) + (4 \div 4) = 1$$

$$4 \div 4 + 4 \div 4 = 2 \qquad \sqrt{4} \times 4 - (4 \div 4) = 3$$

$$4 + (4 - 4) \times 4 = 4 \qquad \sqrt{4} \times 4 + 4 \div 4 = 5$$

$$(4 + 4 + 4) \div \sqrt{4} = 6 \qquad 4 + 4 - 4 \div 4 = 7$$

$$\sqrt{4} + \sqrt{4} + \sqrt{4} + \sqrt{4} = 8 \qquad 4 + 4 + 4 \div 4 = 9$$

$$\sqrt{4} \times \sqrt{4} \times \sqrt{4} + \sqrt{4} = 10$$

- 2 12
 3 a $\frac{4}{7}$ b $\frac{14}{17}$
 4 125 mL
 5 40.95% reduction
 6 7.91% p.a.
 7 a 44% b 10%
 8 200 000 cm² (20 m²)
 9 9, 7, 2, 14, 11, 5, 4, 12, 13, 3, 6, 10, 15, 1, 8

Success criteria example questions

- 1 -23
 2 1
 3 3.46
 4 25 000; 0.042
 5 4000
 6 0.583
 7 $\frac{47}{20} = 2\frac{7}{20}$
 8 $\frac{11}{15} > \frac{18}{25}$
 9 $\frac{19}{24}$
 10 $\frac{13}{20}$
 11 $\frac{16}{3} = 5\frac{1}{3}$
 12 $\frac{21}{20} = 1\frac{1}{20}$
 13 8:5; 5:2
 14 250 cm
 15 \$35/hour
 16 2 kg of rice for \$3.60
 17 0.245; $\frac{2}{25}$
 18 85%
 19 \$21.60
 20 \$600
 21 \$32.40; \$34
 22 75% increase
 23 \$1.38
 24 75%
 25 \$1092
 26 \$80
 27 \$40.84
 28 \$899.10
 29 \$850
 30 \$24 592
 31 \$240
 32 $2\frac{1}{3}$ years = 2 years 4 months
 33 \$14 599.83
 34 \$91 776
 35 \$31 663.92
 36 \$9549.11
 37 \$8939.07
 38 \$2509.27

Short-answer questions

- 1 a -16 b 2 c 0
 d 10 e -23 f 1
 2 a 21.5 b 29100 c 0.153 d 0.00241
 3 a 200 b 60 c 2
 4 a 2.125 b 0.8 $\dot{3}$ c $\overline{1.857142}$
 5 a $\frac{3}{4}$ b $1\frac{3}{5}$ c $2\frac{11}{20}$
 6 a $\frac{1}{2}$ b $2\frac{1}{6}$ c $\frac{7}{24}$
 d 2 e $3\frac{3}{4}$ f $2\frac{19}{28}$
 7 a 5 : 2 b 16 : 9 c 75 : 14
 8 a 50, 30 b 25, 55 c 10, 20, 50
 9 a store A: \$2.25/kg; store B: \$2.58/kg ∴ A is best buy
 b store A: 444 g/\$; store B: 388 g/\$

Decimal	Fraction	Percentage
0.6	$\frac{3}{5}$	60%
0.3	$\frac{1}{3}$	33 $\frac{1}{3}$ %
0.0325	$\frac{13}{400}$	3 $\frac{1}{4}$ %
0.75	$\frac{3}{4}$	75%
1.2	$1\frac{1}{5}$	120%
2	2	200%

- 11 a \$77.50 b 1.65
 12 a 150 b 25
 13 a 72 b 1.17 c 20%
 14 12.5 kg
 15 \$1800
 16 a \$25 b $16\frac{2}{3}$ %
 17 a \$18.25 b \$14.30
 18 \$27 592 19 \$525 20 $4\frac{1}{2}$ years
 21 \$63 265.95 22 \$39 160 23 \$1857.62
 24 \$31 407.49

Multiple-choice questions

- 1 D 2 B 3 C 4 A 5 E 6 E
 7 D 8 E 9 C 10 A 11 C 12 B

Extended-response questions

- 1 a \$231 b \$651
 c i \$63 ii \$34.65
 2 a i \$26 625 ii \$46 928.44
 b 87.71% c \$82 420
 d 26.26% e 7.4% p.a.

Chapter 2

2A

Building understanding

- 1 a 2 b 2 c 3 d 1
 2 a C b D c B
 d A e F f E
 3 a 5 b -2 c $\frac{1}{3}$ d $-\frac{2}{5}$

Now you try

Example 1

a $a + 7$ b $1.2n$ c $\frac{60}{p}$

Example 2

a $x + 6$ b $3x - 1$ c $\frac{a-2}{3}$ d $\sqrt{a+b}$

Example 3

a 8 b 13

Exercise 2A

- 1 a i $4 + r$ ii $t + 2$
 iii $b + g$ iv $x + y + z$
 b i $6P$ ii $10n$
 iii $2D$ iv $5P + 2D$
 c $\frac{500}{C}$
- 2 a $2 + x$ b $ab + y$
 c $x - 5$ d $3x$
 e $3x - 2y$ or $2y - 3x$ f $3p$
 g $2x + 4$ h $\frac{x+y}{5}$
 i $4x - 10$ j $\frac{(m+n)^2}{(m+n)}$
 k $m^2 + n^2$ l $\sqrt{x+y}$
 m $a + \frac{1}{a}$ n $(\sqrt{x})^3$
- 3 a -31 b -25 c -33 d -19
 e $\frac{1}{2}$ f 4 g 1 h 85
- 4 a $1\frac{1}{6}$ b $4\frac{1}{4}$ c $\frac{1}{6}$ d $-1\frac{1}{3}$
- 5 a 60 m^2
 b length = $12 + x$, width = $5 - y$
 c $A = (12 + x)(5 - y)$
- 6 a 18 square units b 1, 2, 3, 4, 5
- 7 a $\frac{P}{10}$ b $\frac{nP}{10}$
- 8 a i $P = 2x + 2y$ ii $A = xy$
 b i $P = 4p$ ii $A = p^2$
 c i $P = x + y + 5$ ii $A = \frac{5x}{2}$
- 9 a A: $2(x + y)$; B: $2x + y$, different
 b same
- 10 a B b $A : c^2 = (a + b)^2$
- 11 a $\frac{n(n+1)}{2}$
 b i 10 ii 55
 c $\frac{n^2}{2} + \frac{n}{2}$ d 10, 55
 e Half the sum of n and the square of n .

2B

Building understanding

- 1 a variable (pronomeral) b $5x$
 c unlike
 2 a $\frac{5}{2}$ b 3 c $\frac{1}{5}$ d $-\frac{1}{20}$
 3 a like b unlike c unlike
 d unlike e like f unlike

Now you try

Example 4

a $35n$ b $-18x^2y$

Example 5

a $\frac{y}{2}$ b $-2b$

Example 6

a $5a + 2$ b $6m + 7n$ c $3a^2b - 2ab$

Exercise 2B

- 1 a $18r$ b $16b$ c $-14x$ d $-15p$
 e $-12cd$ f $-15mn$ g $-24rs$ h $-40jk$
- 2 a $21a^2b$ b $-15mn^2$ c $18gh^2$
 d $12x^2y^2$ e $8a^2b^2$ f $-6m^2n^2$
- 3 a $4b$ b $-\frac{a}{3}$ c $\frac{2ab}{3}$
 d $\frac{m}{2}$ e $-\frac{x}{4}$ f $\frac{5s}{3}$
 g uv h $\frac{5rs}{8}$ i $\frac{5ab}{9}$
- 4 a $\frac{2x}{5}$ b $\frac{4}{3a}$ c $\frac{11mn}{3}$ d $6ab$
 e $-\frac{5}{gh}$ f 8 g -3 h $\frac{7n}{3}$
 i $-\frac{9q}{2}$ j $3b$ k $-5x$ l $\frac{m}{2}$
- 5 a $\frac{4x}{y}$ b $\frac{5p}{2}$ c $-6ab$ d $-\frac{3a}{2b}$
 e $-\frac{7n}{5m}$ f $\frac{10s}{t}$ g $8n$ h $3y$
 i $4b$ j $6xy$ k $5m$ l $3pq^2$
- 6 a $10a$ b $7n$ c $8y$
 d $11x$ e $3ab$ f $7mn$
 g $y + 8$ h $3x + 5$ i $7xy + 4y$
 j $12ab + 3$ k $2 - 6m$ l $4 - x$
- 7 a $5a + 9b$ b $6x + 5y$
 c $4t + 6$ d $11x + 4$
 e $5xy + 4x$ f $7mn - 9$
 g $5ab - a$ h 0
- 8 a xy^2 b $7a^2b$
 c $3m^2n$ d p^2q^2
 e $7x^2y - 4xy^2$ f $13rs^2 - 6r^2s$
 g $-7x - 2x^2$ h $4a^2b - 3ab^2$
 i $7pq^2 - 8pq$ j $8m^2n^2 - mn^2$
- 9 a $x + y$ b $4x + 2y$
- 10 a $8x$ b $3x^2$

- 11 a $30x$ cm b $30x^2$ cm²
 12 $\frac{20x + 75}{21}$
 13 a true b false c true
 d false e false f true
 14 a $(4x + 4y)$ km b $(8x + 4)$ km c $(2x - 2)$ km
 15 a a^3 b $\frac{b^2}{3}$ c $\frac{b^2}{3}$ d $\frac{3ab}{8}$
 e $-\frac{2a^3}{3}$ f $-\frac{2}{5a^2}$ g $\frac{2}{5a^5}$ h $\frac{a^2}{4b^3}$
 i $3a^3b$ j $\frac{4b^3}{a}$ k $\frac{a^3}{3b}$ l $-\frac{a}{2b^3}$

2C

Building understanding

- 1 a i $5x$ ii 10
 b $5x + 10$ c $x + 2$ d $5(x + 2)$ e $5x + 10$
 2 a $3 \times x + 3 \times 5$
 $= 3x + 15$
 b $4 \times y + 4 \times (-3)$
 $= 4y - 12$
 c $-2 \times x + (-2) \times 3$
 $= -2x - 6$
 d $-3 \times x + (-3) \times (-1)$
 $= -3x + 1$

Now you try

Example 7

- a $5x + 10$ b $3x - 21$ c $-3x + 6$

Example 8

- a $3x + 21y$ b $-6a^2 + 12a$

Example 9

- a $2y + 2$ b $x - 9y$

Exercise 2C

- 1 a $2x + 6$ b $5x + 60$ c $2x + 14$ d $7x - 63$
 e $3x - 6$ f $2x - 12$ g $28 - 4x$ h $21 - 7x$
 2 a $-3x - 6$ b $-2x - 22$ c $-5x + 15$
 d $-6x + 36$ e $-8 + 4x$ f $-65 - 13x$
 g $-180 - 20x$ h $-300 + 300x$
 3 a $2a + 4b$ b $15a - 10$ c $12m - 15$
 d $-16x - 40$ e $-12x - 15$ f $-4x^2 + 8xy$
 g $-18ty + 27t$ h $3a^2 + 4a$ i $2d^2 - 5d$
 j $-6b^2 + 10b$ k $8x^2 + 2x$ l $5y - 15y^2$
 4 a $2x + 11$ b $6x - 14$
 c $15x - 3$ d $3x + 1$
 e $4x - 5$ f $2x + 1$
 g $-3x - 4$ h $-5x - 19$
 i $11 - x$ j $12 - x$
 k $2 - 2x$ l $6 - 3x$
 5 a $5x + 12$ b $4x - 8$
 c $11x - 2$ d $17x - 7$
 e $-4x - 6$ f $x - 7$
 g $2x - 4$ h $-27x - 4$

- i $-4x - 18$ j $-13x - 7$
 k $11x - 7$ l $2x - 15$
 6 a $x^2 + 4x$
 7 a $2x + 2$ b $2x^2 - 3x$ c $6x^2 - 2x$
 d $2x^2 + 4x$ e $x^2 + 2x + 6$ f $20 + 8x - x^2$
 8 $20n - 200$
 9 $0.2x - 2000$
 10 a $2x + 12$ b $x^2 - 4x$ c $-3x - 12$
 d $-7x + 49$ e $19 - 2x$ f $x - 14$
 11 a $6(50 + 2) = 312$ b $9(100 + 2) = 918$
 c $5(90 + 1) = 455$ d $4(300 + 26) = 1304$
 e $3(100 - 1) = 297$ f $7(400 - 5) = 2765$
 g $9(1000 - 10) = 8910$ h $6(900 - 21) = 5274$
 12 a $a = \$6000, b = \$21\,000$
 b i $\$3000$ ii $\$12\,600$ iii $\$51\,000$
 c i 0
 ii $0.2x - 4000$
 iii $0.3x - 9000$
 iv $0.5x - 29\,000$
 d Answers may vary.
 e Answers may vary.

2D

Building understanding

- 1 a 3 b 40 c 5 d 6
 2 a 3 b 2 c 12 d 6
 3 B, C

Now you try

Example 10

- a $x = 3$ b $x = -1$

Example 11

- a $x = 22$ b $x = \frac{6}{5}$ c $x = 17$

Exercise 2D

- 1 a 2 b 1 c 4 d -4
 e $-3\frac{2}{3}$ f $1\frac{2}{3}$ g $4\frac{1}{2}$ h $\frac{1}{2}$
 i $1\frac{1}{3}$ j $-\frac{5}{7}$ k $-\frac{1}{8}$ l $-\frac{3}{20}$
 2 a -3 b -1 c 2 d 8
 e $-1\frac{2}{5}$ f $-2\frac{5}{7}$ g $\frac{3}{8}$ h $1\frac{3}{4}$
 3 a -6 b -6 c 30
 d -15 e -8 f 12
 g 20 h -5
 4 a 9 b 6 c $-6\frac{3}{4}$
 d $-7\frac{1}{2}$ e $\frac{2}{3}$ f $-\frac{4}{25}$
 g 12 h 12 i -9
 j -8 k 6 l $-1\frac{1}{2}$

- 5 a 11 b 6 c -10 d -12
 e -5 f -1 g 7 h 5
 i $4\frac{2}{7}$ j $5\frac{1}{3}$ k -7 l 3
- 6 a 26 b 28 c 3
 d 28 e 8 f $3\frac{3}{7}$
- 7 7
- 8 \$900
- 9 a should have +1 before $\div 2$
 b should have $\times 3$ before -2
 c need to $\div -1$ as $-x = 7$
 d should have +4 before $\times 3$
- 10 a i 5 ii -3 iii $\frac{1}{5}$
 iv 3 v $-\frac{5}{6}$ vi $\frac{3}{10}$
- b when the common factor divides evenly into the RHS
- 11 a $a = b + c$ b $a = \frac{c-b}{2}$
 c $a = \frac{c-2d}{b}$ d $a = c(b+d)$
 e $a = -\frac{cd}{b}$ f $a = \frac{b}{2c}$
 g $a = \frac{c(3-d)}{2b}$ h $a = \frac{2d(b-3)}{c}$
 i $a = cd - b$ j $a = b + cd$
 k $a = \frac{2be+6c}{d}$ l $a = \frac{d-3ef}{4c}$

2E

Building understanding

- 1 a $4x - 12$ b 2 c $5x - 9$
 2 a $2x + 6 = 5$ b $5 + 2x - 2 = 7$
 c $2x + 1 = -6$ d $2x - 3 = 1$

Now you try

Example 12

a $x = \frac{7}{6}$ b $x = 3$

Example 13

a $x = -3$ b $x = 14$

Exercise 2E

- 1 a $6\frac{1}{3}$ b $9\frac{2}{5}$ c $3\frac{3}{4}$ d $9\frac{1}{2}$
 e $\frac{1}{2}$ f $-5\frac{1}{2}$ g $-\frac{4}{5}$ h $\frac{1}{14}$
 i $3\frac{1}{6}$ j $\frac{2}{3}$ k $\frac{9}{10}$ l $1\frac{1}{6}$
- 2 a 2 b -10 c 1 d 5
 e 3 f 3 g 1 h -2
- 3 a 1 b 4 c 2
 d 8 e 8 f 3
 g 4 h -1 i $\frac{5}{11}$
- 4 a -1 b $3\frac{1}{2}$ c -9 d -14
 e -16 f 3 g 19 h -3
 i -13 j -26 k $-2\frac{2}{3}$ l $-1\frac{1}{10}$
- 5 a $\frac{1}{2}$ b $2\frac{2}{3}$ c $1\frac{1}{2}$ d $-\frac{5}{6}$
 e $\frac{2}{5}$ f $1\frac{1}{2}$ g -6

6 Let \$ w be the wage, $2(3w - 6) = 18$, \$5

7 11 marbles

8 a $x = 5$ b $x = 5$
 c Dividing both sides by 3 is faster because $9 \div 3$ is an integer.9 a $x = 4\frac{1}{3}$ b $x = 4\frac{1}{3}$
 c Expanding the brackets is faster because $7 \div 3$ gives a fraction answer.10 a $x = 4$ b $x = 4$
 c Method a is preferable as you don't have to deal with negatives.

Final step in method a: divide both sides by a positive number.

Final step in method b: divide both sides by a negative number.

- 11 a $x = \frac{d}{a-b}$
 b $x = \frac{2}{a-b}$
 c $x = \frac{c}{5a-b}$
 d $x = -\frac{6}{3a-4b}$ or $\frac{6}{4b-3a}$
 e $x = -c$
 f $x = b$
 g $x = \frac{d+bd+c}{a-b}$
 h $x = -\frac{ab+bc}{a-b+1}$ or $\frac{ab+bc}{b-a-1}$

2F

Building understanding

- 1 a $2x - 1 = 11$ b $2x + 100 = 2200$
 c $m + (m + 12) = 60$ d $80n + 100 = 480$

Now you try

Example 14

5

Example 15

\$187 and \$239

Exercise 2F

- 1 a $2x = x + 5$ b $x - 8 = 3x + 2$
 c $x - 3 = 4x - 9$ d $3(x + 7) = 9$
- 2 a Let e be the number of goals for Emma.
 b $e + 8$
 c $e + e + 8 = 28$
 d $e = 10$
 e Emma scored 10 goals, Leonie scored 18 goals.
- 3 a Let w be the width in centimetres.
 b length = $4w$
 c $2w + 2(4w) = 560$
 d $w = 56$
 e length = 224 cm, width = 56 cm
- 4 $40x + 50 = 290$, 6 days.
- 5 $x + 2x + 2 = 32$, 10 km, 20 km
- 6 $x + x + 280 = 1000$, \$360, \$640.

- 7 15, 45
- 8 Andrew \$102.50, Brenda \$175, Cammi \$122.50
- 9 19 km
- 10 I am 10 years old.
- 11 first leg = 54 km, second leg = 27 km, third leg = 18 km, fourth leg = 54 km
- 12 Eric is 18 years old now.
- 13 4 fiction, 8 non-fiction books
- 14 2 hours
- 15 8 p.m.
- 16 rectangle $L = 55$ m, $W = 50$ m; triangle side = 70 m
- 17 a 27, 28, 29
 - b i $x, x + 2, x + 4$ ii 4, 6, 8
 - c i $x, x + 2, x + 4$ ii 15, 17, 19
 - d i $x, x + 3, x + 6$ ii 24, 27, 30
- 18 a $T = 8x + 7200$ b 300
- c $R = 24x$ d $x = 350$
- e 3825
- 19 \$15200
- 20 438 km
- 21 Anna 6; Henry 4; Chloe 12; twins 11

Progress quiz

- 1 a $5 + x + y$ b $4y - 15$ c $k^2 + p^2$
d $(m - n)^2$ or $(n - m)^2$ e $\sqrt{x + 16}$
- 2 a 12 b -28 c $\frac{1}{2}$ d -12
- 3 a $14ab$ b $-40p^2q$
c $\frac{4}{m}$ d $-6y$
- 4 a $2x + 7$ b $11 + km$
c $5xy - x$ d $a^2b + ab^2 + b$
- 5 a $4a + 28$ b $-6x^2 + 15x$
- 6 a $3a + 4$ b $5x - 2y$
- 7 a $x = 4$ b $a = 21$ c $p = -3\frac{1}{2}$
d $t = 20$ e $x = 11$ f $k = 7$
- 8 a $x = 6\frac{1}{3}$ b $a = 3$ c $m = -2$ d $y = 9\frac{1}{2}$
- 9 a $2(x + 5) = 14$ b $x - 9 = 4x + 6$
- 10 Let g be Jed's team's goals: $g + g + 14 = 30$; 22 goals
- 11 Let a be my age, $4(a + 5) = 88$, 17 years old

2G

Building understanding

- 1 a $3 > 2$ b $-1 < 4$
c $-7 < -3$ d $5 > -50$
- 2 a C b A c B

Now you try

Example 16

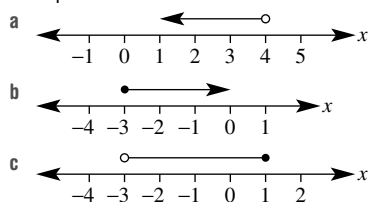

Example 17

- a $x < 11$ b $x < -1$ c $a \geq -9$ d $a \geq -\frac{7}{2}$

Exercise 2G

- 1 a b c d e f
- 2 a $x < 3$ b $b > 5$ c $y > 6$
d $x \geq 3$ e $t > -5$ f $y \geq -10$
g $m < 6$ h $a \geq 1\frac{1}{2}$ i $x < 1$
- 3 a $x < 4$ b $n \leq -1$ c $x \geq \frac{3}{5}$
d $a \geq 4$ e $x \geq -6$ f $x \geq 10$
g $x < -6$ h $t \leq -2$ i $m > -4\frac{5}{6}$
- 4 a $x \leq 16$ b $x \leq -9$ c $x \leq 20$
d $x < 11$ e $x > -2\frac{2}{3}$ f $x \geq -2$
- 5 a $x < 1$ b $a < -8$ c $x \leq -2$
d $x < 2\frac{1}{2}$ e $y < -3\frac{1}{5}$ f $x < -\frac{4}{7}$
- 6 a $x \geq 2\frac{1}{2}$ b $t > -\frac{3}{5}$ c $y \leq \frac{3}{8}$
d $a < 1\frac{1}{5}$ e $m \geq 6$ f $b < 5\frac{1}{2}$

- 7 less than 18
- 8 less than 13 cm
- 9 a 3 b 2 c 4 d 0
- 10 $x = 3$ or $x = 4$ or $x = 5$
- 11 399 km

- 12 a i -0.9, 0, 0.5, 1, 1.8 etc
ii Numbers must be less than 2.
b i -4, -2, 0, 1, 5 etc
ii Numbers must be greater than -5.
c i $x < a$ ii $x > -a$
- 13 a $x < 3$ b $x < 3$
c Reverse the inequality sign when dividing by a negative number.
- 14 a $x < -13$ b $x \geq -3$ c $x > \frac{4}{7}$
d $x \leq \frac{13}{5}$ e $x > \frac{10}{17}$ f $x \geq \frac{3}{4}$
- 15 a $x > \frac{b-c}{a}$ b $x \geq b - a$ c $x \leq a(b + c)$
d $x \leq \frac{ac}{b}$ e $x < \frac{cd-b}{a}$ f $x \geq \frac{b-cd}{2}$
g $x < \frac{c}{a} - b$ h $x > \frac{b-a}{a}$ i $x < b - \frac{c}{a}$
j $x \leq \frac{b+c}{1-a}$ k $x < \frac{b+1}{b-a}$ l $x \leq \frac{c-b}{b-a}$

2H

Building understanding

- 1 a A b D c M d A
 2 a subtract 3 b multiply by 4
 c square both sides d subtract c
 3 a i subtract 5, divide by 3
 ii subtract b , divide by a
 b i divide by 3, take square root of both sides
 ii divide by a , take square root of both sides

Now you try

Example 18

- a 10 b 180

Example 19

21

Example 20

- a
- $a = \frac{b}{2} + c$
- or
- $a = \frac{b+2c}{2}$
- b
- $a = \sqrt{c+b}$

Exercise 2H

- 1 a 21 b 24 c 2 d 6
 e 452.39 f 249.86 g 25.06 h 14.95
 2 a 36 b 5 c 20 d 4.14
 e 3.39 f 18.67 g 0.06
 3 a $t = \frac{v-u}{a}$ b $x = \frac{2A}{y}$
 c $n = \frac{p}{m} - x$ d $x = \frac{cd-a}{b}$
 e $r = \frac{A}{2\pi h}$ f $r = \frac{100I}{Pt}$
 g $r = \sqrt{\frac{V}{\pi h}}$ h $v = \sqrt{PR}$
 i $h = \frac{S - 2\pi r^2}{2\pi r}$ j $p = -q \pm \sqrt{A}$
 k $A = (4C - B)^2$ l $g = \frac{4\pi^2 l}{T^2}$
 4 a 88.89 km/h
 b i $d = st$ ii 285 km
 5 a i 212°F ii 100.4°F
 b $C = \frac{5}{9}(F - 32)$
 c i -10°C ii 36.7°C
 6 a 35 m/s b 2s
 7 a decrease b 3988 L
 c 6 hours 57 minutes d 11 hours 7 minutes
 8 a $D = \frac{c}{100}$ b $d = 100e$ c $D = 0.7m$
 d $V = 1.15P$ e $C = 50 + 18t$ f $d = 42 - 14t$
 g $C = \frac{c}{b}$
 9 a $a = \frac{P}{4}$ b $a = 180 - b$ c $a = 90 - b$
 d $a = \frac{180-b}{2}$ e $a = \sqrt{c^2 - b^2}$ f $a = \sqrt{\frac{4A}{\pi}}$
 10 a 73 b 7 c 476.3

2I

Building understanding

- 1 a $y = 5$ b $x = -3$ c $x = 10$
 2 a A b C
 3 a no b yes

Now you try

Example 21

- a
- $x = 2, y = 6$
- b
- $x = -1, y = 4$
- c
- $x = 2, y = -3$

Exercise 2I

- 1 a $x = 1, y = 2$ b $x = 5, y = 1$ c $x = \frac{1}{2}, y = \frac{3}{2}$
 2 a $x = 3, y = 9$ b $x = -1, y = 3$
 c $x = 1, y = 0$ d $x = 2, y = 1$
 e $x = 1, y = 3$ f $x = 0, y = 4$
 g $x = 3, y = -2$ h $x = 4, y = 1$
 i $x = -1, y = 4$
 3 a $x = 6, y = 11$ b $x = 4, y = 3$
 c $x = 12, y = -3$ d $x = -18, y = -4$
 e $x = -2, y = 10$ f $x = 2, y = -4$
 4 17, 31
 5 10 tonnes, 19 tonnes
 6 width = $1\frac{2}{3}$ cm, length = $3\frac{5}{6}$ cm
 7 $x - (3x - 1) = x - 3x + 1$; to avoid sign error use brackets when substituting
 8 a $x = \frac{1}{3}, y = 2\frac{1}{3}$ b $x = -\frac{5}{6}, y = 6\frac{1}{3}$
 c $x = -22, y = -7$
 9 a $x = \frac{b}{a+b}, y = \frac{b^2}{a+b}$
 b $x = \frac{b}{a+1}, y = \frac{1}{a+1}$
 c $x = \frac{a-b}{2}, y = \frac{a+b}{2}$
 d $x = \frac{a-ab}{a-b}, y = \frac{a-ab}{a-b} - a$
 e $x = \frac{2a}{a-b}, y = \frac{2ab}{a-b} + a$
 f $x = \frac{2a+ab}{a-b} - b, y = \frac{2a+ab}{a-b}$

2J

Building understanding

- 1 a - b + c + d -
 2 a i subtraction ii addition
 iii subtraction
 b i addition ii subtraction
 iii addition

Now you try

Example 22

a $x = 1, y = 2$

Example 23

a $x = 2, y = -1$

b $x = 3, y = -2$

b $x = -1, y = 4$

Exercise 2J

1 a $x = 1, y = 1$
c $x = 2, y = -1$

2 a $x = 2, y = 4$
c $x = -2, y = 6$

e $x = 2, y = 3$

3 a $x = -3, y = 4$
c $x = 2, y = 1$

e $x = 7, y = -5$
g $x = 5, y = -5$

i $x = -1, y = -3$

4 a $x = 3, y = -5$
c $x = 2, y = 4$

e $x = -1, y = 4$
g $x = 5, y = -3$

i $x = 2, y = 1$
k $x = -3, y = 9$

5 21 and 9

6 $102^\circ, 78^\circ$

7 $L = 261.5 \text{ m}, W = 138.5 \text{ m}$

8 11 mobile phones, 6 iPads

9 a $x = 2, y = 1$

b $x = 2, y = 1$

c Method b is preferable as it avoids the use of a negative coefficient.

10 Rearrange one equation to make x or y the subject.

a $x = 4, y = 1$

11 a no solution

12 a $x = \frac{a+b}{2}, y = \frac{a-b}{2}$

c $x = -\frac{a}{2}, y = -\frac{3a}{2b}$

e $x = \frac{1}{3}, y = \frac{b}{3a}$

g $x = \frac{3b}{7a}, y = \frac{b}{7}$

i $x = 0, y = \frac{b}{a}$

k $x = \frac{b-4}{ab-4}, y = \frac{1-a}{ab-4}$

m $x = \frac{c-bd}{a(b+1)}, y = \frac{c+d}{b+1}$

o $x = \frac{3b}{a+3b}, y = \frac{3b-2a}{a+3b}$

q $x = \frac{c+f}{a+d}, y = \frac{cd-af}{b(a+d)}$

b $x = 2, y = 2$

b $x = 8, y = -1$

d $x = -3, y = -13$

f $x = 1, y = 3$

b $x = 2, y = 1$

d $x = -2, y = 3$

f $x = 5, y = 4$

h $x = -3, y = -2$

b $x = 2, y = -3$

d $x = 3, y = 1$

f $x = 3, y = -2$

h $x = -2, y = -2$

j $x = -5, y = -3$

l $x = -1, y = -2$

b $x = 2, y = 1$

b $x = -1, y = -1$

b no solution

b $x = \frac{b}{2a}, y = -\frac{b}{2}$

d $x = 0, y = b$

f $x = -\frac{4}{a}, y = 6$

h $x = \frac{3b}{7a}, y = -\frac{b}{7}$

j $x = -\frac{c}{a}, y = c$

l $x = 1, y = 0$

n $x = \frac{a+2b}{a-b}, y = \frac{3a}{a-b}$

p $x = -\frac{b}{a-bc}, y = \frac{bc-2a}{a-bc}$

r $x = \frac{c-f}{a-d}, y = \frac{af-cd}{b(a-d)}$

2K

Building understanding

1 a $x + y = 42, x - y = 6$

b elimination

2 a $l = 3w, 2l + 2w = 120$

b substitution

Now you try

Example 24

The dimensions of the rectangle are 16 cm by 10 cm.

Example 25

hat \$8.40, scarf \$11.20

Exercise 2K

1 a Let l m be the length

Let w m be the width

b $l = w + 10, 2l + 2w = 80$

c $w = 15, l = 25$

d The length of the pool is 25 m and the width is 15 m.

2 potatoes 480 ha; corn 340 ha

3 a Let $\$m$ be the cost of milk.

Let $\$c$ be the cost of chips.

b $3m + 4c = 17, m + 5c = 13$

c $m = 3, c = 2$

d A bottle of milk costs \$3 and a bag of chips \$2.

4 a Let $\$g$ be the cost of lip gloss.

Let $\$e$ be the cost of eye shadow.

b $7g + 2e = 69, 4g + 3e = 45$

c $g = 9, e = 3$

d A lip gloss costs \$9 and eye shadow \$3

5 cricket ball \$12; tennis ball \$5

6 4 buckets of chips; 16 hot dogs

7 300 adults, 120 children

8 11 five-cent and 16 twenty-cent coins

9 Michael is 35 years old now.

10 Jenny \$100, Kristy \$50

11 160 adult tickets and 80 child tickets

12 5 hours

13 jogging 3 km/h; cycling 9 km/h

14 a Malcolm is 14 years old.

b The second digit of Malcolm's age is 3 more than the first digit.

c 6:14, 25, 36, 47, 58 or 69

15 original number is 37

16 any two-digit number that has the first digit 2 more than the second (e.g. 42 or 64 etc.)

Problems and challenges

1 a $x = \frac{k+4}{w-a}$

b $K = \frac{a-b}{y}$

c $a = \frac{w}{1-km^2}$

2 39

- 3 \$140
 4 8
 5 a i > ii < iii > iv <
 b c, b, a, d
 6 $x = 1, y = -2, z = 5$
 7 a $x = \frac{ab}{a-b}$ b $x = \frac{10}{3}$ or $3\frac{1}{3}$
 c $x = -\frac{7}{11}$ d $x = \frac{29}{4}$ or $7\frac{1}{4}$

Success criteria example questions

- 1 $20t$
 2 10
 3 $28x^2y$
 4 $\frac{2y}{3}$
 5 $3xy - 2x^2y$
 6 $12x^2 - 20x$
 7 $-9x + 13$
 8 $x = -3$
 9 $x = 5$
 10 $x = \frac{1}{8}$
 11 $x = -6$
 12 $x + 4 = 2x - 3$
 13 Ava has 16 and Elise has 11

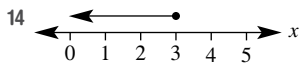

- 15 $x > -4$
 16 $c = 15$
 17 $a = 5$
 18 $r = \sqrt{\frac{V}{\pi h}}$
 19 $x = 2, y = 1$
 20 $x = -1, y = 3$
 21 A meat pie costs \$6 and a bottle of water costs \$3

Short-answer questions

- 1 a $7m$ b $2(x + y)$ c $3m$ d $\frac{n}{4} - 3$
 2 a -7 b 7 c 24 d 8
 3 a $8mn$ b $\frac{xy}{3}$
 c $6b^2$ d $4 - 3b$
 e $2mn + 2m - 1$ f $2p + 4q$
 4 a $2x + 14$ b $-6x - 15$ c $6x^2 - 8x$
 d $-10a + 8a^2$ e $13 - 4x$ f $27x - 10$
 5 a $x = 9$ b $x = 26$ c $x = 15$
 d $x = 1$ e $x = 2$ f $x = -9$
 g $x = -10$ h $x = \frac{5}{7}$

- 6 a $2n + 3 = 21, n = 9$ b $\frac{l-5}{3} = 7, l = 26$
 c $\frac{x}{4} - 5 = 0, x = 20$
 7 a $x = 5$ b $x = 1\frac{5}{6}$ c $x = 4$
 d $x = -5$ e $x = 1$ f $x = 4$

8 \$260

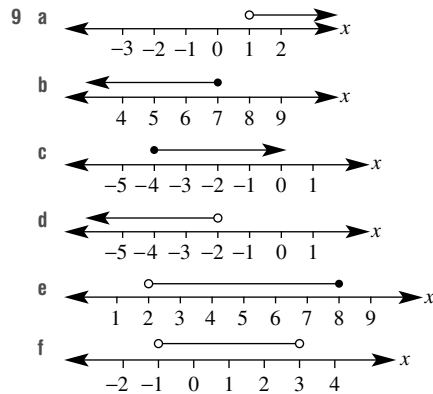

- 10 a $x < 12$ b $m > -1$ c $y \geq -6$
 d $x < 17$ e $a > 4$ f $x \geq 2$
 11 n (sales) \geq \$24 000
 12 a $E = 60$ b $a = 5$ c $h = 10$
 13 a $x = \frac{v^2 - u^2}{2a}$ b $\theta = \frac{2A}{r^2}$
 c $l = \sqrt{\frac{P}{R}}$ d $a = \frac{2S}{n} - l = \frac{2S - nl}{n}$
 14 a $x = 8, y = 2$ b $x = -\frac{3}{5}, y = -1\frac{3}{5}$
 c $x = 4, y = 11$ d $x = 11, y = 4$
 e $x = -3, y = -5$ f $x = 4, y = 1$
 15 Billy is 20 years old and his sister is 12 years old

Multiple-choice questions

- 1 C 2 D 3 D 4 C 5 B 6 A
 7 A 8 E 9 B 10 A 11 B 12 D

Extended-response questions

- 1 a $0 < b \leq 10$
 b $b = \frac{2A}{h} - a$ or $b = \frac{2A - ah}{h}$
 c 8 m d $h = \frac{2A}{a + b}$ e 8 m
 2 a \$5 per ride
 b i Let \$ c be the cost of a bucket of chips.
 Let \$ d be the cost of a drink.
 ii $2d + c = 11, 3d + 2c = 19$
 iii $d = 3, c = 5$
 iv Chips cost \$5 per bucket and drinks cost \$3 each.

Chapter 3

3A

Building understanding

- 1 a 17 b 50 c $\sqrt{8}$
 2 a $c^2 = a^2 + b^2$ b $x^2 = y^2 + z^2$ c $j^2 = k^2 + l^2$
 3 a 10.24 b 13 c 10 d 4.90

Now you try

Example 1

- a 5 b 5.59

Example 2

$\sqrt{58}$

Exercise 3A

- 1 a $c = 26$ b $c = 17$ c $c = 15$
 d $c = 25$ e $c = 41$ f $c = 50$
 2 a 4.47 b 3.16 c 15.62
 d 11.35 e 7.07 f 0.15
 3 a $\sqrt{5}$ b $\sqrt{58}$ c $\sqrt{34}$
 d $\sqrt{37}$ e $\sqrt{109}$ f $\sqrt{353}$
 4 a 21.63 mm b 150 mm c 50.99 mm
 d 155.32 cm e 1105.71 m f 0.02 m
 5 a hypotenuse = 3.61 m; perimeter = 8.61 m
 b hypotenuse = 2.24 m; perimeter = 5.24 m
 c hypotenuse = 5.67 cm; perimeter = 13.19 cm
 d hypotenuse = 0.08 m; perimeter = 0.19 m
 e hypotenuse = 7.07 mm; perimeter = 17.07 mm
 f hypotenuse = 4.53 cm; perimeter = 10.93 cm
 6 4.4 m
 7 42 m
 8 250 m
 9 2.4 m
 10 495 m
 11 a 5 cm b $\frac{25}{3}$ or $8\frac{1}{3}$ cm
 12 5.83 m
 13 a no b no c yes
 d no e yes f yes
 14 a 9.4 m
 b i acute-angled ii obtuse-angled
 c i obtuse-angled ii acute-angled
 15 a 5.66 cm b 5.66 cm c yes
 16 a 77.78 cm b 1.39 m
 c reduce is by 7.47 cm d 43.73 cm
 17 42.43 cm, 66.49 cm

3B

Building understanding

- 1 a 14 b 12 c 4 d 8
 2 a true b false c false
 d true e true f false

Now you try

Example 3

- a $a = 7$ b $b = 10.27$
 c $x = \sqrt{\frac{49}{2}} \left(= \frac{7}{\sqrt{2}} = \frac{7\sqrt{2}}{2} \right)$

Exercise 3B

- 1 a 16 b 24 c 6
 d 21 e 60 f 27
 2 a 8.66 b 11.31 c 5.11
 d 17.55 e 7.19 f 0.74
 3 a 30 cm b 149.67 cm c 1.65 cm
 d 2.24 km e 12 cm f 52.92 mm
 4 a $\sqrt{\frac{25}{2}} \left(= \frac{5\sqrt{2}}{2} \right)$ b $\sqrt{8} (= 2\sqrt{2})$
 c $\sqrt{\frac{1521}{200}} \left(= \frac{39\sqrt{2}}{20} \right)$
 5 5.3 m
 6 14.2 m
 7 a $\sqrt{187}$ b $\sqrt{567}$ or $9\sqrt{7}$ c 40
 8 49 cm
 9 1.86 m
 10 a $\sqrt{\frac{81}{5}} \left(= \frac{9\sqrt{5}}{5} \right)$ b $\sqrt{5}$
 c $\sqrt{\frac{5}{2}}$ or $\sqrt{\frac{10}{2}}$
 11 a $\sqrt{\frac{5}{2}}$, $3\sqrt{\frac{5}{2}}$ b $\frac{10}{\sqrt{13}}$, $\frac{15}{\sqrt{13}}$ c $\frac{25}{\sqrt{74}}$, $\frac{35}{\sqrt{74}}$
 12 a the side c
 b $\sqrt{6}$
 c no, c^2 is enough
 d error due to rounding, x would not be exact
 13 a i $\sqrt{8}$ or $2\sqrt{2}$ ii $\sqrt{7}$ iii $\sqrt{6}$
 b $OB: 2.60, OC: 2.79, OD: 2.96$
 c differ by 0.04; the small difference is the result of rounding errors
 d Answers may vary.

3C

Building understanding

- 1 a C, II b A, III c B, I

Now you try

Example 4

40.45 m

Exercise 3C

- 1 3.0 m
 2 142.9 m
 3 3823 mm
 4 1060 m
 5 a 6.4 m b 5.7 cm c 5.4 m d 6.0 m
 6 466.18 m

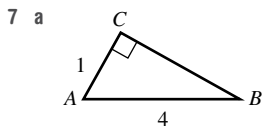

b 3.9 cm

8 a 47 m

b 89.8 m

9 171 cm

10 a $\frac{5}{\sqrt{2}}$ or $\frac{5\sqrt{2}}{2}$

b $6 + \frac{5}{\sqrt{2}}$ or $6 + \frac{5\sqrt{2}}{2}$

c 10.2

11 a 1.1 km

b 1.1 km

c 3.8 km

12 a 28.28 cm

b i 80 cm

ii 68.3 cm

iii 48.3 cm

c Answers may vary.

d Answers may vary.

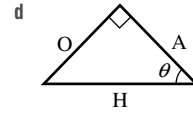
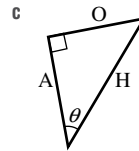
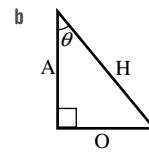
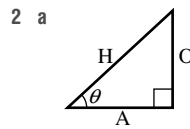

3 a 5

b 4

c 3

d 3

e 4

3D**Building understanding**

1 a yes

b yes

c no

d yes

e yes

f no

g yes

h no

i yes

Now you try

Example 5

7.60 cm

Exercise 3D

1 11.18 mm

2 a 0.34 m

b 19.75 cm

3 a 3.0 cm

b 2.5 m

c 3.1 cm

4 a 18.0 cm

b 7 mm

c 0.037 m

5 a $\sqrt{2}$ cm

b 1.7 cm

6 a $\sqrt{208}$ cm or $4\sqrt{13}$ cm

b 15.0 cm

7 84 m

8 2.86 cm

9 $\sqrt{3} : 2$

10 a $\sqrt{65}$

b 8.06

c $\sqrt{69}$, 8.31

d 8.30

e Rounding errors have accumulated.

11 a i $\sqrt{8}$ cm or $2\sqrt{2}$ cm

ii 3.74 cm

b i $\sqrt{50}$ cm or $5\sqrt{2}$ cm

ii 5.45 cm

12 a i 11.82 m

ii 12.15 m

iii 11.56 m

iv 11.56 m

b Shortest distance is 10.44 m.

3E**Building understanding**

1 a hypotenuse

b opposite

c adjacent

d opposite

e hypotenuse

f adjacent

Now you try

Example 6

a $\tan \theta = \frac{6}{5}$

b $\cos \theta = \frac{3}{8}$

c $\sin \theta = \frac{2}{3}$

Exercise 3E

1 a $\sin \theta = \frac{4}{7}$

b $\tan \theta = \frac{5}{4}$

c $\cos \theta = \frac{3}{5}$

d $\sin \theta = \frac{2}{3}$

e $\tan \theta = 1$

f $\sin \theta = \frac{x}{y}$

g $\tan \theta = \frac{4}{5}$

h $\cos \theta = \frac{a}{2b}$

i $\sin \theta = \frac{5y}{3x}$

2 a i $\frac{5}{13}$

ii $\frac{5}{13}$

iii the same

b i $\frac{12}{13}$

ii $\frac{12}{13}$

iii the same

c i $\frac{5}{12}$

ii $\frac{5}{12}$

iii the same

3 a $\sin \theta = \frac{3}{5}$, $\cos \theta = \frac{4}{5}$, $\tan \theta = \frac{3}{4}$

b $\sin \theta = \frac{5}{13}$, $\cos \theta = \frac{12}{13}$, $\tan \theta = \frac{5}{12}$

c $\sin \theta = \frac{12}{13}$, $\cos \theta = \frac{5}{13}$, $\tan \theta = \frac{12}{5}$

4 a $\frac{4}{5}$

b $\frac{3}{5}$

c $\frac{3}{5}$

d $\frac{3}{4}$

e $\frac{4}{5}$

f $\frac{4}{3}$

5 $\frac{3}{4}$

6 a $\frac{7}{25}$

b $\frac{24}{25}$

c $\frac{7}{24}$

7 a i 5

ii $\sin \theta = \frac{3}{5}$, $\cos \theta = \frac{4}{5}$, $\tan \theta = \frac{3}{4}$

b i 25

ii $\sin \theta = \frac{7}{25}$, $\cos \theta = \frac{24}{25}$, $\tan \theta = \frac{7}{24}$

c i 15

ii $\sin \theta = \frac{9}{15} = \frac{3}{5}$, $\cos \theta = \frac{12}{15} = \frac{4}{5}$, $\tan \theta = \frac{9}{12} = \frac{3}{4}$

d i 10

ii $\sin \theta = \frac{8}{10} = \frac{4}{5}$, $\cos \theta = \frac{6}{10} = \frac{3}{5}$, $\tan \theta = \frac{8}{6} = \frac{4}{3}$

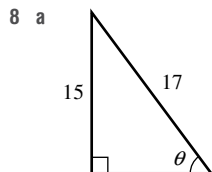

- 8 a
- b 8
- c $\sin \theta = \frac{15}{17}$, $\cos \theta = \frac{8}{17}$, $\tan \theta = \frac{15}{8}$
- 9 a i $\frac{1}{2}$ ii $\frac{\sqrt{3}}{2}$ iii $\frac{1}{\sqrt{3}}$
 iv $\frac{\sqrt{3}}{2}$ v $\frac{1}{2}$ vi $\sqrt{3}$
- b i They are equal. ii They are equal.
- 10 a Answers may vary.
- b i 0.766 ii 0.643 iii 0.839
 iv 0.766 v 1.192 vi 0.643
- c $\sin 40^\circ = \cos 50^\circ$, $\sin 50^\circ = \cos 40^\circ$,
 $\tan 50^\circ = \frac{1}{\tan 40^\circ}$, $\tan 40^\circ = \frac{1}{\tan 50^\circ}$
- 11 a yes, any isosceles right-angled triangle
 b no, as it would require the hypotenuse (the longest side) to equal the opposite
 c no, adjacent side can't be zero
 d no; the numerator < denominator for sin and cos as the hypotenuse is the longest side
- 12 a $\sin \theta = \frac{3}{5}$, $\tan \theta = \frac{3}{4}$
- b i $\cos \theta = \frac{\sqrt{3}}{2}$, $\tan \theta = \frac{1}{\sqrt{3}}$
 ii $\tan \theta = \sqrt{3}$, $\sin \theta = \frac{\sqrt{3}}{2}$
 iii $\sin \theta = \frac{1}{\sqrt{2}}$, $\cos \theta = \frac{1}{\sqrt{2}}$
- c equals one
 d $(\sin \theta)^2 + (\cos \theta)^2 = 1$ (the Pythagorean identity)

3F

Building understanding

- 1 a A b O c H
 2 a sin b tan c cos

Now you try

- Example 7
 a 0.94 b 0.87 c 1.39

- Example 8
 3.21

- Example 9
 a 2.12 b 4.49 c 2.02

Exercise 3F

- 1 a 0.73 b 0.10 c 0.25 d 0.46
 2 a 3.06 b 18.94 c 5.03
 d 0.91 e 1.71 f 9.00
 g 2.36 h 4.79 i 7.60

- 3 a 5.95 b 0.39 c 12.59 d 3.83
 e 8.40 f 1.36 g 29.00 h 1.62
 i 40.10 j 4.23 k 14.72 l 13.42
 m 17.62 n 5.48 o 9.75 p 1.01
- 4 1.12 m
 5 44.99 m
 6 10.11 m
 7 a 20.95 m b 10 cm
 8 a 65° b 1.69 c 1.69
 d They are the same as both are suitable methods for finding x .
- 9 a i 80° ii 62° iii 36° iv 9°
 b i both 0.173... ii both 0.469...
 iii both 0.587... iv both 0.156...
 c $\sin \theta^\circ = \cos(90^\circ - \theta^\circ)$
 d i 70° ii 31° iii 54° iv 17°
- 10 a $\sqrt{2}$
 b i $\frac{1}{\sqrt{2}}$ ii $\frac{1}{\sqrt{2}}$ iii 1
 c $\sqrt{3}$
 d i $\frac{1}{2}$ ii $\frac{\sqrt{3}}{2}$ iii $\frac{1}{\sqrt{3}}$
 iv $\frac{\sqrt{3}}{2}$ v $\frac{1}{2}$ vi $\sqrt{3}$

Progress quiz

- 1 a 6.66 b 7.88
 2 a $\sqrt{41}$ b $\sqrt{50} (= 5\sqrt{2})$
 3 224.5 cm
 4 a 10.4 cm b 10.8 cm
 5 a AC b BC c $\frac{3}{5}$ d $\frac{4}{3}$
 6 a 7.46 b 6.93
 7 a 13.80 b 25.27 c 2.50
 8 a 3.464 cm b 6.9 cm²

3G

Building understanding

- 1 a $x = 2$ b $x = 5$ c $x = 7$ d $x = 4$
 2 a N b D c D

Now you try

- Example 10
 3.40
- Example 11
 a 8.00 b $x = 7.58$, $y = 23.27$

Exercise 3G

- 1 a 0.98 b 12.80 c 14.43
 d 9.52 e 114.83 f 22.05
 2 a 13.45 b 16.50 c 57.90 d 26.33
 e 15.53 f 38.12 g 9.15 h 32.56
 i 21.75 j 49.81 k 47.02 l 28.70

- 3 a $x = 7.5, y = 6.4$ b $a = 7.5, b = 10.3$
 c $a = 6.7, b = 7.8$ d $x = 9.5, y = 12.4$
 e $x = 12.4, y = 9.2$ f $x = 21.1, y = 18.8$
 g $m = 56.9, n = 58.2$ h $x = 15.4, y = 6.0$
- 4 40 m
- 5 3848 m
- 6 a 23.7 m b 124.9 m
- 7 a B, as student B did not use an approximation in their working out
 b Use your calculator and do not round $\sin 31^\circ$ during working.
 c i difference of 0.42 ii difference of 0.03
 8 a i 10.990 ii 11.695
 b i 0.34 ii 0.94 iii 0.36
 c equal to $\tan 20^\circ$
 d i $\frac{b}{c}$ ii $\frac{a}{c}$ iii $\frac{b}{a}$ iv $\frac{b}{a}$
 e same as $\tan \theta$

3H

Building understanding

- 1 a 11.54 b 41.41 c 26.57
- 2 a $\frac{1}{2}$
 b 50°
 c $45^\circ = \tan^{-1}(1)$
- 3 a sine b cosine c tan

Now you try

Example 12

- a
- 65°
- b
- 59.0°

Example 13

 34°

Exercise 3H

- 1 a 30° b 45° c 30°
 d 90° e 50° f 90°
- 2 a 34.85° b 19.47° c 64.16°
 d 75.52° e 36.87° f 38.94°
 g 30.96° h 57.99° i 85.24°
- 3 a 43° b 31° c 41° d 16°
 e 55° f 50° g 49° h 41°
- 4 17°
- 5 25.4°
- 6 26.6°
- 7 23.13°
- 8 a 128.7° b 72.5° c 27.3°
- 9 a $90^\circ, 37^\circ, 53^\circ$ b $90^\circ, 23^\circ, 67^\circ$ c $90^\circ, 16^\circ, 74^\circ$
- 10 45°
- 11 $\angle ACM = 18.4^\circ$ $\angle ACB = 33.7^\circ$, no it is not half
- 12 a 18° b 27° c 45°
 d 5.67 m e up to 90°

3I

Building understanding

1 $a = 65, b = 25$

2 a 22°

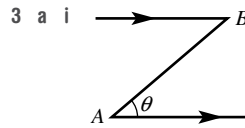

b 22°

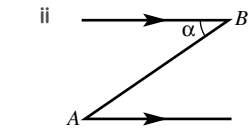
b yes, $\theta = \alpha$, alternate angles are equal on parallel lines

Now you try

Example 14

31 m

Example 15

11 m

Example 16

 22°

Example 17

yes, 7 m above

Exercise 3I

- 1 29 m
- 2 16 m
- 3 157 m
- 4 38 m
- 5 90 m
- 6 37°
- 7 6°
- 8 10°
- 9 yes by 244.8 m
- 10 a 6° b 209 m
- 11 4634 mm
- 12 $15^\circ, 4319$ mm
- 13 1.25 m
- 14 a 6.86 m b 26.6°
 c i $m = h + y$ ii $y = x \tan \theta$
 iii $m = h + x \tan \theta$
- 15 $A = \frac{1}{2}a^2 \tan \theta$
- 16 a i 47.5 km ii 16.25 km
 b no, $\sin(2 \times \theta) < 2 \times \sin \theta$
 c yes, $\sin\left(\frac{1}{2}\theta\right) > \frac{1}{2}\sin \theta$
- 17 a yes b 12.42 km
 c no, after 10 min the plane will be above 4 km
 d 93 km/h or more
- 18 a 1312 m b 236 km/h

3J

Building understanding

- 1 a 0° b 045° c 090° d 135°
 e 180° f 225° g 270° h 315°
- 2 a 070° b 130° c 255° d 332°

Chapter 4

4A

Building understanding

- 1 a $A(4, 1)$ $B(2, 3)$ $C(0, 3)$
 $D(-2, 2)$ $E(-3, 1)$ $F(-1, 0)$
 $G(-3, -2)$ $H(-2, -4)$ $I(0, -3)$
 $J(2, -2)$ $K(3, -4)$ $L(2, 0)$
- b i F, L ii C, I
c i D, E ii J, K
- 2 a 2 b -7
3 a 1 b 21
- 4 Answers may vary; e.g. $(1, 4)$, $(-1, 2)$ etc.

Now you try

Example 1

a

x	-3	-2	-1	0	1	2	3
y	-4	-3	-2	-1	0	1	2

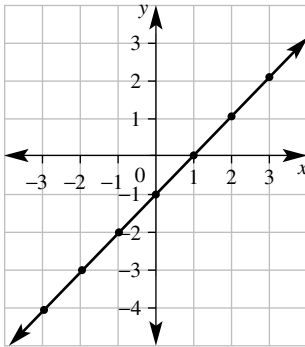

b

x	-3	-2	-1	0	1	2	3
y	10	7	4	1	-2	-5	-8

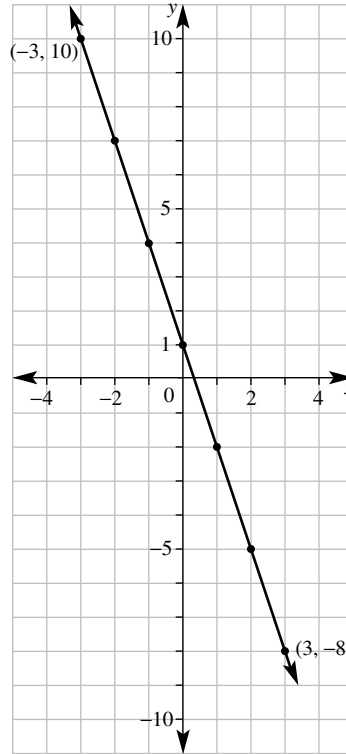

Example 2

- a x -intercept is at $(1, 0)$,
 y -intercept is at $(0, 1)$
- b x -intercept is at $(5, 0)$,
 y -intercept is at $(0, -3)$

Example 3

- a yes b no

Exercise 4A

1 a $y = x - 1$

x	-3	-2	-1	0	1	2	3
y	-4	-3	-2	-1	0	1	2

b $y = 2x - 3$

x	-3	-2	-1	0	1	2	3
y	-9	-7	-5	-3	-1	1	3

c $y = -x + 4$

x	-3	-2	-1	0	1	2	3
y	7	6	5	4	3	2	1

d $y = -3x$

x	-3	-2	-1	0	1	2	3
y	9	6	3	0	-3	-6	-9

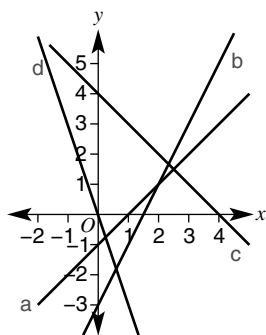

- 2 a (1, 0), (0, 1) b (-2, 0), (0, 2)
 c (4, 0), (0, 8) d (-5, 0), (0, 10)
 e (2, 0), (0, 3) f (7, 0), (0, -3)
 g (-11, 0), (0, 5) h (-2, 0), (0, -5)

- 3 a yes b no c yes
 d yes e no f no
 4 a no b yes c no
 d no e yes f no

- 5 a $y = x + 2$ b $y = 2x$
 c $y = 2x + 1$ d $y = -x + 2$

- 6 a C b D c B d A
 7 a yes b no c no d yes

- 8 a For graph to move 1 down from (1, 1) it moves $1\frac{1}{2}$ across.
 b For graph to move 1 up from (0, -1) it moves $1\frac{1}{2}$ across.

- 9 a false b true c true d false

- 10 a $y = 2x + 7$ b $y = -x + 20$
 c $y = -3x - 10$ d $y = -5x + 4$
 e $y = \frac{1}{2}x + \frac{1}{2}$ f $y = -\frac{1}{2}x - \frac{3}{2}$

4B

Building understanding

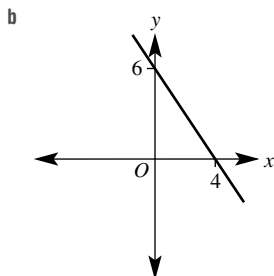
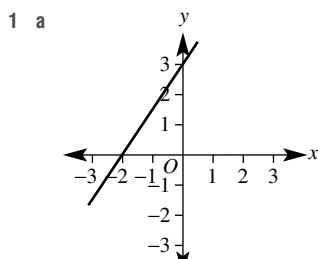

- 2 a i 3 ii 4 iii -6
 b i 10 ii 1 iii 6

- 3 a (0, 4) b (0, -5) c (0, 3)
 4 a (-2, 0) b (3, 0) c (2, 0)

Now you try

Example 4

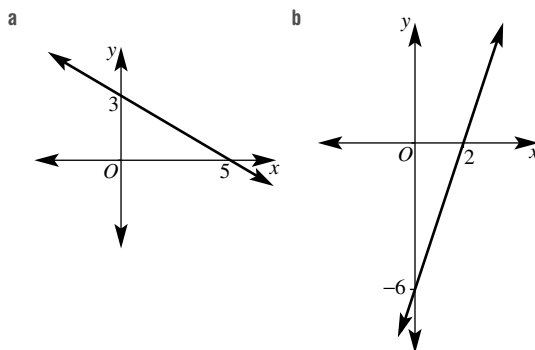

Exercise 4B

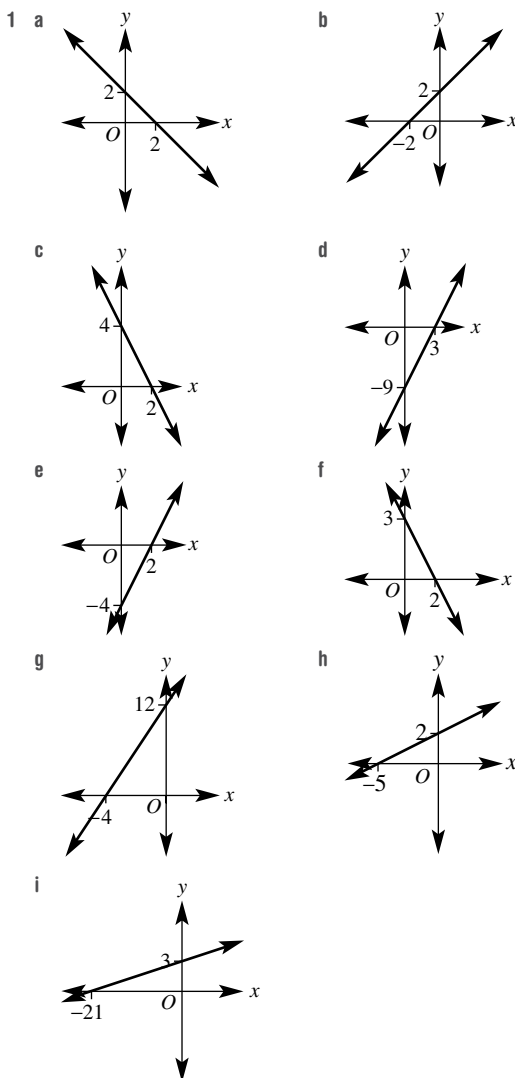

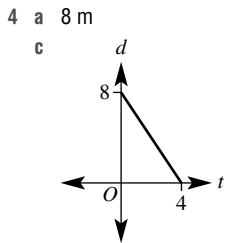
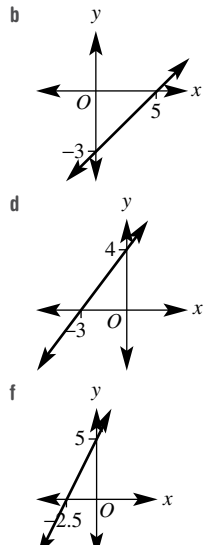
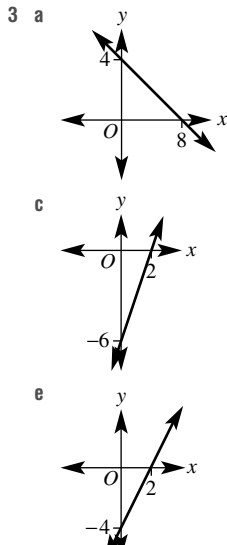
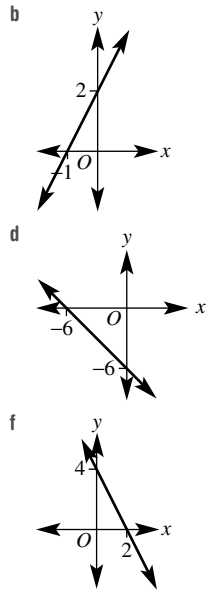
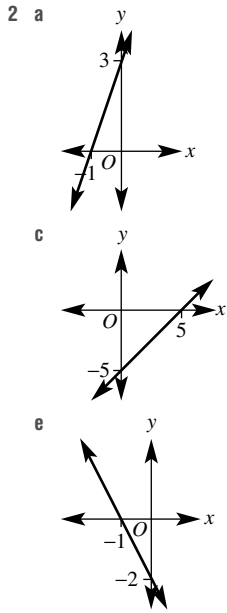

- 5 a 100 m
- 6 a $(1\frac{2}{3}, 0), (0, -2\frac{1}{2})$
- c $(6\frac{1}{2}, 0), (0, -13)$
- e $(3, 0), (0, -1\frac{1}{2})$

- b 4 seconds
- b 12.5 s
- b $(-7, 0), (0, -1\frac{2}{5})$
- d $(-\frac{1}{2}, 0), (0, -1)$
- f $(\frac{1}{3}, 0), (0, -\frac{1}{7})$

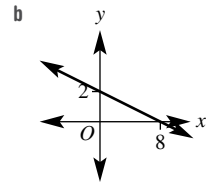
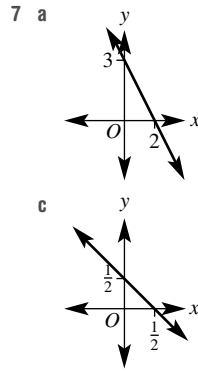

- 8 $(0, 0)$ is the x - and y -intercept for all values of a and b
- 9 a $x + y = 4$ b $x + y = 2$
- c $x - y = 3$ d $x - y = -1$
- e $x + y = k$ f $x + y = -k$
- 10 a $(\frac{c}{a}, 0), (0, \frac{c}{b})$ b $(-\frac{cb}{a}, 0), (0, c)$
- c $(\frac{c}{a}, 0), (0, -\frac{c}{b})$ d $(-\frac{c}{b}, 0), (0, \frac{c}{a})$
- e $(-\frac{c}{b}, 0), (0, \frac{c}{a})$ f $(\frac{bc}{a}, 0), (0, \frac{bc}{a})$

4C

Building understanding

- 1 a $(2, 0)$ b $(-3, 0)$ c $(0, 0)$
- 2 a $(0, 3)$ b $(0, -2)$ c $(0, 0)$
- 3 a 5 b $\frac{1}{3}$ c -4 d -0.1

Now you try

Example 5

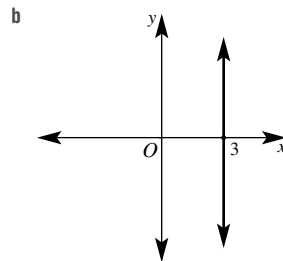
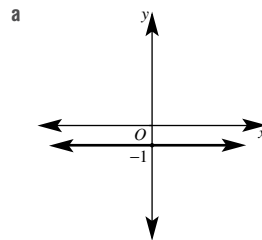

Example 6

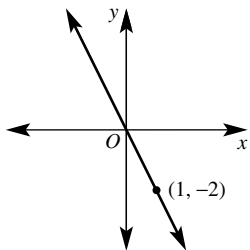

Exercise 4C

1 a

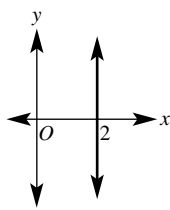

c

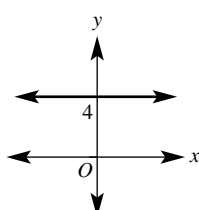

e

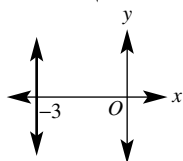

g

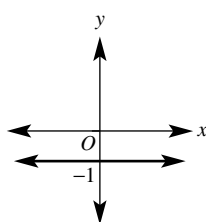

2 a

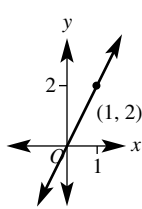

c

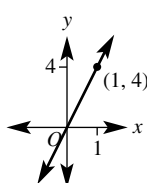

b

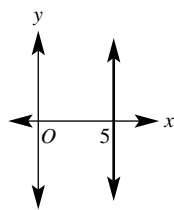

d

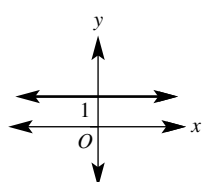

f

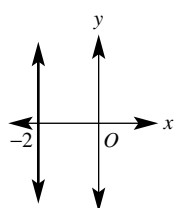

h

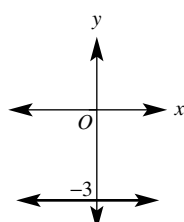

b

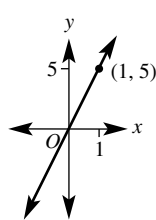

d

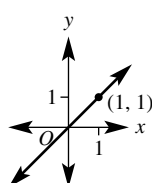

e

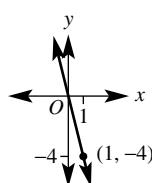

g

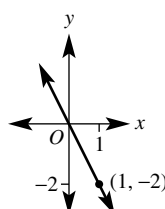

f

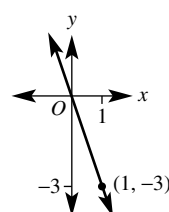

h

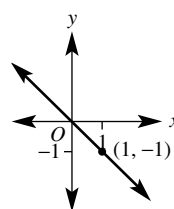

3

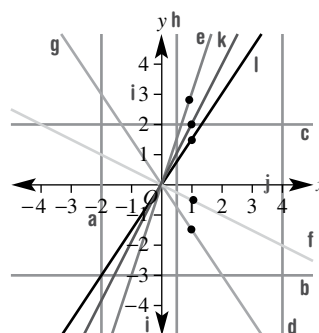

- 4 a $y = -2$ b $y = 4$ c $x = -2$
- d $x = 5$ e $y = 1.5$ f $x = -6.7$
- 5 a $y = 3$ b $x = 5$ c $x = -2$ d $y = 0$
- 6 a $y = 250$ b $y = -45$
- 7 a (1, 2) b (-3, 5) c (0, -4)
- d (4, 0) e (0, 0) f (1, 3)
- g (3, -27) h (5, 40)
- 8 a $A = 15$ square units b $A = 68$ square units
- 9 a i $y = 1$ or $y = -5$
- ii $y = 0$ or $y = -4$
- iii $y = 3\frac{1}{2}$ or $y = -7\frac{1}{2}$
- b i $y = 1$ or $y = -5$
- ii $y = 7$ or $y = -11$
- iii $y = 9\frac{1}{2}$ or $y = -13\frac{1}{2}$
- 10 a $y = 2x$ b $y = -x$
- c $y = 3x$ d $y = -3x$
- 11 a $y = 3x$ b $y = 4x$
- c $y = -5x$ d $y = -2x$

12 a

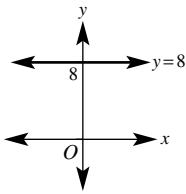

c

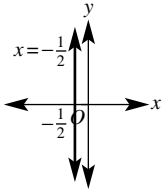

e

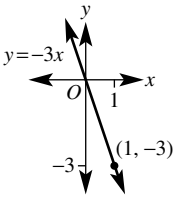

g

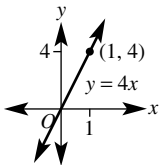

b

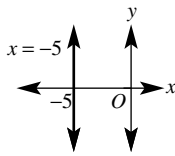

d

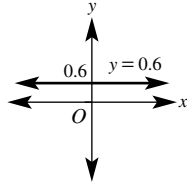

f

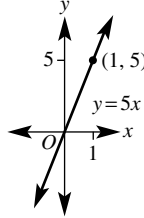

h

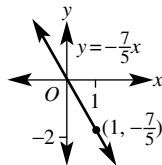

13 $x = -1, y = -5, y = 5x$

14 a (b, c)

15 $m = \frac{1}{2}$

b $m = \frac{c}{b}$

4D

Building understanding

- 1 a 2 b $\frac{1}{2}$ c 3
 d -1 e -3 f $-\frac{1}{4}$
- 2 a zero b negative
 c positive d undefined
- 3 a 2 b 0.5 c 6 d -6

Now you try

Example 7

- a negative, gradient = $-\frac{2}{3}$ b zero, gradient = 0
 c undefined d positive, gradient = $\frac{3}{5}$

Example 8

- a $m = 2$ b $m = -\frac{4}{7}$

Exercise 4D

- 1 a positive, 2 b zero
 c negative, $-\frac{3}{4}$ d undefined
 e positive, $\frac{1}{2}$ f positive, 3
 g positive, 2 h negative, -4

- 2 a 2 b $\frac{4}{3}$ c 2 d 1
 e $-\frac{1}{4}$ f -2 g -1 h $\frac{1}{2}$
 i $\frac{3}{2}$ j $-\frac{5}{2}$ k $\frac{1}{3}$ l $\frac{5}{2}$
- 3 A 1 B -2 C 1 D $\frac{1}{2}$ E -2 F 3
- 4 a $-\frac{1}{20}$ b $\frac{35}{2}$ c $-\frac{1}{5}$ d $\frac{15}{2}$
- 5 a 6 b -1 c 4 d $-\frac{3}{2}$
- 6 300 m
- 7 A 9 B -4 C -1
 D 4 E -0.4 F 2.4
- 8 $\frac{7}{11} = \frac{35}{55}, \frac{3}{5} = \frac{33}{55}$ hence $\frac{7}{11} > \frac{3}{5}$ so $\frac{7}{11}$ is steeper
- 9 a run = $x_2 - x_1$ b rise = $y_2 - y_1$ c $m = \frac{y_2 - y_1}{x_2 - x_1}$
 d i $m = \frac{3}{2}$ ii $m = \frac{5}{4}$
 iii $m = -\frac{5}{3}$ iv $m = \frac{4}{3}$
- e yes, the rise and the run work out regardless
- 10 a i -1 ii -3
 b (4.5, 0)
 c i (6, 0) ii (2.4, 0)
 iii $(\frac{9}{7}, 0)$ iv (7.5, 0)

4E

Building understanding

- 1 a i 10 km ii 20 km iii 30 km
 b 10 km/h c 10
 d They are the same.
- 2 a 15 mm
 b i 6 days ii 20 days
- c
- | | | | | | |
|-----|---|---|----|----|----|
| t | 0 | 1 | 2 | 3 | 4 |
| h | 0 | 5 | 10 | 15 | 20 |
- d B e 5

Now you try

Example 9

- a 90 km/h
 b d (km)

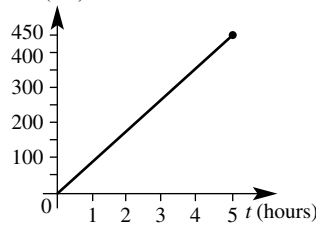

- c i 90 ii $d = 90t$
 d i 315 km ii 1.5 hours

Exercise 4E

1 a 100 L/hour

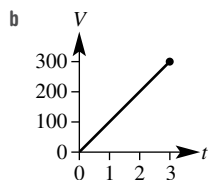

c i 100

ii $V = 100t$

d i $V = 150L$

ii $t = 2$ hours

2 a 25 km/h

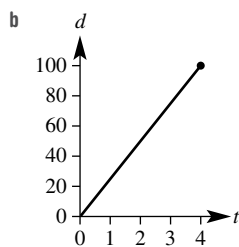

c i 25

ii $d = 25t$

d i 62.5 km

ii 1.6 hours or 1 h 36 min

3 a $d = 50t$

b $g = 2t$

c $C = 1.25\pi$

d $P = 20t$

4 a 100 km/h

b 7 cm/s

c 2.5 cm/min

d 49 mm/min

5 a 10.2 L

b 72.25 L

c 800 km

6 Sally

7 Leopard

8 25 months

9 a i 0

ii 4π

iii 12π

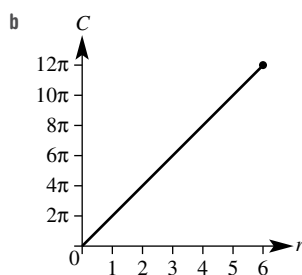

c gradient is 2π , the coefficient of r

10 No, $A = \pi r^2$ so area (A) is proportional to square of radius (r^2).

11 a $A = 2h$

b 2 cm^2 increase for each 1 cm increase in height

12 yes, for any fixed time, e.g. $t = 5$, $s = \frac{d}{5}$

13 1.2 minutes or 72 seconds

14 $\frac{5}{12}$ km

4F

Building understanding

1 a $y = 2x + 5$

b $y = -2x + 3$

c $y = -x - 2$

d $y = -\frac{1}{2}x - 10$

2 a 1

b -5

c 9

3 a $y = x + 7$

b $y = -x + 3$

c $y = 2x + 5$

Now you try

Example 10

a gradient = 5

y-intercept = $(0, -2)$

b gradient = 6

y-intercept = $(0, 0)$

Example 11

a $y = -5x + 10$

b $2x + y = 3$

Example 12

a gradient = 3

y-intercept = $(0, -2)$

b gradient = $\frac{2}{5}$

y-intercept = $(0, -2)$

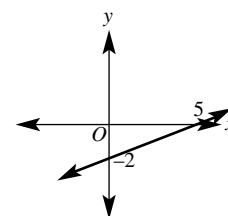
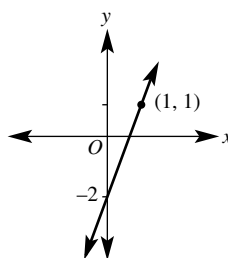

Exercise 4F

1 a gradient = 3, y-intercept = $(0, 4)$

b gradient = -5, y-intercept = $(0, -2)$

c gradient = -2, y-intercept = $(0, 3)$

d gradient = $\frac{1}{3}$, y-intercept = $(0, -4)$

e gradient = -4, y-intercept = $(0, 0)$

f gradient = 2, y-intercept = $(0, 0)$

g gradient = 1, y-intercept = $(0, 0)$

h gradient = -0.7, y-intercept = $(0, 0)$

2 a $y = -2x + 3$

b $y = 3x - 1$

c $y = -3x + 2$

d $y = x + 2$

e $2x - y = 1$ or $-2x + y = -1$

f $3x + y = 4$ or $-3x - y = -4$

g $x - 3y = 1$ or $-x + 3y = -1$

h $2x - 7y = -2$ or $-2x + 7y = 2$

3 a $1, (0, -2)$

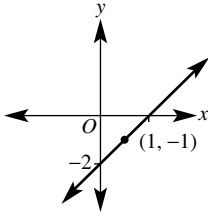

b $2, (0, -1)$

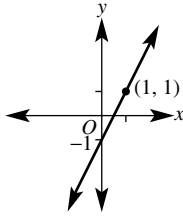

c $-\frac{1}{2}, (0, 3)$

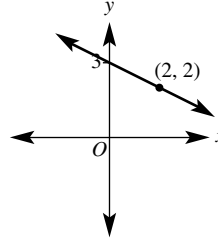

d $\frac{1}{2}, (0, -4)$

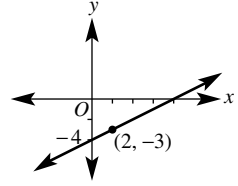

c $\frac{1}{2}, (0, 1)$

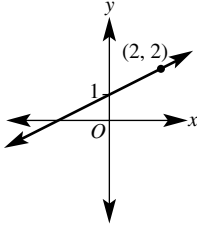

d $-\frac{1}{2}, (0, 2)$

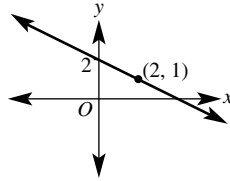

e $\frac{2}{3}, (0, -2)$

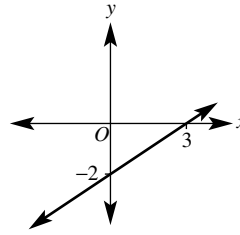

f $-\frac{4}{3}, (0, 4)$

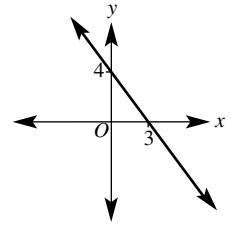

e $-3, (0, 3)$

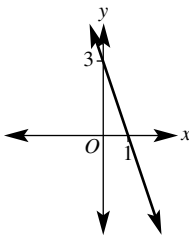

f $\frac{3}{2}, (0, 1)$

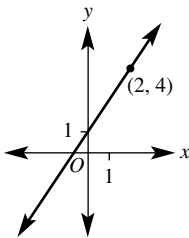

g $\frac{1}{3}, (0, \frac{4}{3})$

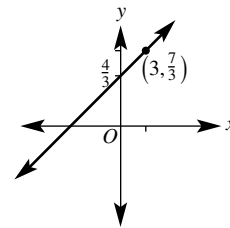

h $-\frac{2}{3}, (0, 2)$

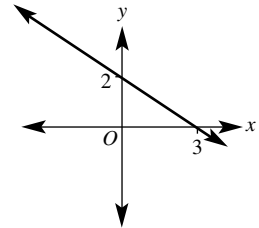

g $-\frac{4}{3}, (0, 0)$

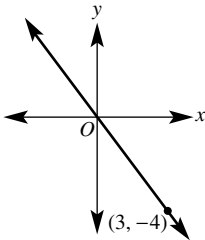

h $\frac{5}{3}, (0, -\frac{1}{3})$

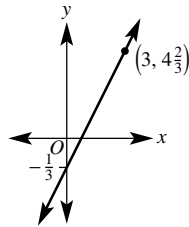

i $\frac{3}{4}, (0, -3)$

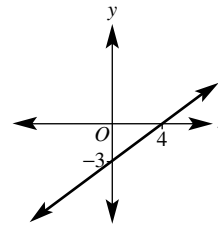

j $-\frac{1}{4}, (0, 0)$

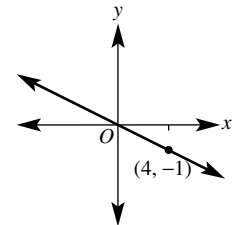

4 a $-1, (0, 4)$

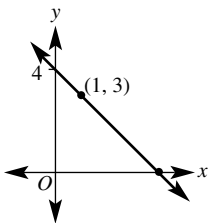

b $1, (0, -6)$

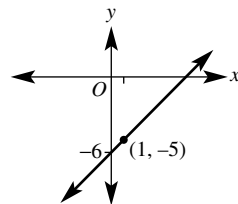

k $\frac{1}{5}, (0, 0)$

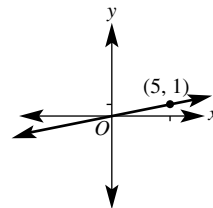

l $\frac{1}{2}, (0, 0)$

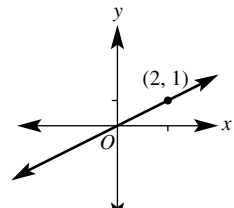

5 a D
d B

b F
e E

c C
f A

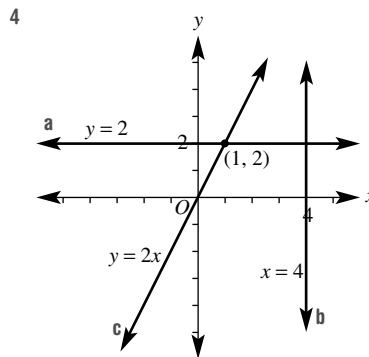
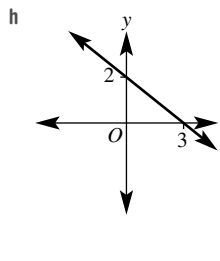
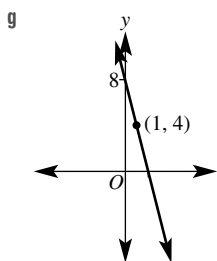
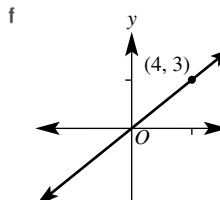
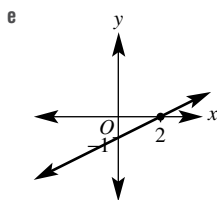
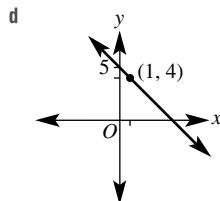
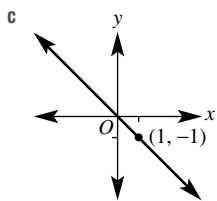
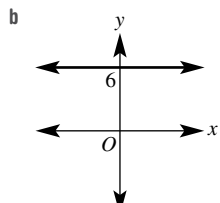
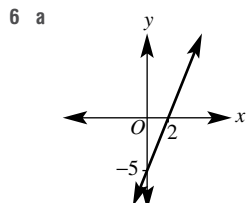

- 5 a positive, 2 b undefined
 c zero d negative, $-\frac{2}{3}$
 6 a $m = 2$ b $m = -3$

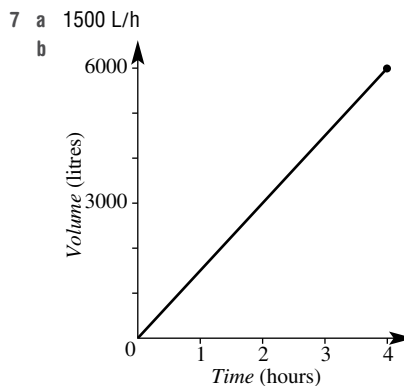

- c i 1500 ii $V = 1500t$
 d i 4500 L ii 3.5 hours
 8 a $y = -5x + 8$ b $-3x + y = -5$
 9 a 3, (0, -2) b $-\frac{2}{3}, (0, 3)$

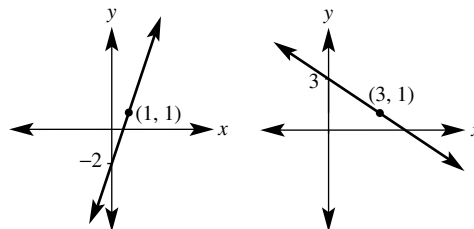

- 7 C, D, F, H
 8 a $y = 2x + 2$, y-intercept is (0, 2)
 b expand brackets and simplify
 9 $y = k$
 10 $y = -\frac{a}{b}x + \frac{d}{b}$, $m = -\frac{a}{b}$, y-int $(0, \frac{d}{b})$
 11 a $y = 2x + 3$ b $y = -x + 2$
 c $y = \frac{5}{3}x + \frac{2}{3}$ d $y = -\frac{2}{5}x - \frac{1}{5}$

Progress quiz

- 1 a (2, 0), (0, -4) b (3, 0), (0, 6)
 2 a not on line b on line
 3 a
-
- b
-

4G

Building understanding

- 1 a $y = 2x + 5$ b $y = 4x - 1$ c $y = -2x + 5$
 2 a 1 b 9 c 5

Now you try

Example 13
 $y = -2x + 4$

Example 14
 $y = \frac{2}{3}x + 6$

Exercise 4G

- 1 a $y = x + 3$ b $y = 2x - 2$
 c $y = 8x + 8$ d $y = -x + 4$
- 2 a $y = 3x + 5$ b $y = -2x - 1$ c $y = -3x + 8$
 d $y = x - 3$ e $y = -3x + 3$ f $y = 5x - 1$
 g $y = -x + 8$ h $y = -3x + 6$ i $y = -2x + 2$
 j $y = -4x - 9$
- 3 a $y = \frac{3}{4}x + 3$ b $y = -\frac{3}{4}x + 3$ c $y = -\frac{5}{4}x + 3$
 d $y = \frac{3}{2}x + 4$ e $y = \frac{3}{5}x$ f $y = -\frac{1}{3}x - 1$
- 4 a i 2 ii $y = 2x + 2$
 b i -1 ii $y = -x + 3$
 c i -4 ii $y = -4x + 11$
 d i 1 ii $y = x - 4$

5 $(2\frac{1}{2}, 0)$

6 $(\frac{3}{5}, 0), (0, -\frac{3}{4})$

7 $V = -20t + 120, V = 120$ L initially

- 8 a $y = 5x$ b $y = 6.5x + 2$
 9 a 1 b 8 c -6 d $\frac{5}{2}$

- 10 a $c = 3$ b $c = 3$
 c no, y-intercept is fixed for any given line

11 $y = \frac{b}{a}x$

- 12 a $y = 2x$ b $y = -2x + 4$
 c $y = 2x + 5$ d $y = -\frac{3}{2}x + 2$
 e $y = \frac{5}{7}x + \frac{1}{7}$ f $y = -\frac{13}{3}x - \frac{11}{3}$

4H

Building understanding

- 1 a 4 b 8 c 1 d -3
 2 a 5.5 b 2.5 c -1.5 d -2.5
 3 a 2.24 b 8.60 c 10.20

Now you try

Example 15

a (2, 3.5) b (-1, -1.5)

Example 16

8.06

Exercise 4H

- 1 a (3, 3) b (2, 2)
 c (4, 1) d (-1, 3)
 e (-1, -1) f (1.5, 1.5)
 g (0.5, 3) h (-1.5, -2.5)
 i (-3, -8.5) j (0.5, -2.5)
- 2 a 5.10 b 2.83 c 5.39
 d 4.47 e 3.61 f 2.83
 g 8.94 h 7.21 i 6.71
- 3 B(8, 0); A(-6, 5), A(-6, 9)
 4 a (-3, 1) b (1, -4) c (8, 2.5)
 5 a 12.8 b 24.2

- 6 (0, 0), (0, 4), (2, 0), (2, 4)

7 a $x = \frac{x_1 + x_2}{2}$ b $y = \frac{y_1 + y_2}{2}$
 c M(1, -0.5)

8 a i $x_2 - x_1$ ii $y_2 - y_1$

iii $\sqrt{(x_2 - x_1)^2 + (y_2 - y_1)^2}$

b Answers may vary.

9 a $\frac{1}{3}$

b $\frac{1}{3}$

c i (1, 1) ii (-2, -0.5) iii (2, 1.5)

d i (-1, 1) ii (-2, 5)

iii (0.4, -1.8) iv (-2.4, 2.6)

4I

Building understanding

- 1 a yes b no c yes d no
 2 a $-\frac{1}{5}$ b $\frac{1}{3}$
 3 a yes b no c no d yes

Now you try

Example 17

$y = 4x - 2$

Example 18

$y = \frac{1}{3}x + 4$

Exercise 4I

- 1 a $y = 4x + 8$ b $y = -2x - 7$
 c $y = \frac{2}{3}x - 5$ d $y = -\frac{4}{5}x + \frac{1}{2}$
- 2 a $y = -\frac{1}{3}x + 3$ b $y = -\frac{1}{5}x + 7$
 c $y = \frac{1}{2}x - 4$ d $y = x + 4$
 e $y = \frac{1}{7}x - \frac{1}{2}$ f $y = -x + \frac{5}{4}$
- 3 a i $y = 1$ ii $y = -2$
 b i $x = 3$ ii $x = -3$
 c i $x = 2$ ii $x = 0$
 d i $y = 7$ ii $y = -\frac{1}{2}$
- 4 a $y = -3x + 9$ b $y = \frac{1}{2}x + \frac{5}{2}$
 c $y = -\frac{1}{5}x + 6\frac{1}{5}$ d $y = x + 5$
- 5 $y = 0, y = x + 3, y = -x + 3$
 6 $y = 2x - 10$ or $y = 2x + 10$
- 7 a i $-\frac{3}{2}$ ii -5
 iii 7 iv $\frac{11}{3}$
 b $-\frac{b}{a}$
- 8 a i $-\frac{1}{2}$ ii 3
 b i 1 ii $-\frac{1}{7}$
- 9 a $y = -\frac{1}{2}x + 4$ b $y = \frac{2}{3}x + 1\frac{2}{3}$
 c $y = 2x - 3$ d $y = -2x - 5\frac{1}{2}$
 e $y = \frac{3}{7}x - \frac{5}{7}$ f $y = -\frac{5}{6}x + \frac{1}{6}$

4J

Building understanding

- 1 B
 2 a i \$1200 ii \$1500 iii \$2200
 b $A = 1000 + 100n$
 3 a 46 b 3.5 c 2 d 3

Now you try

Example 19

a $W = 500 + 10x$

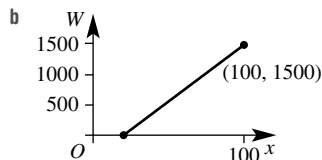

- c \$750 d 35

Exercise 4J

1 a $W = 20x + 400$

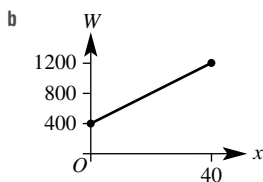

(Note: This graph should really be a series of points but a full line segment is used as a guide.)

- c \$640 d 30

2 a $C = 25n + 500$

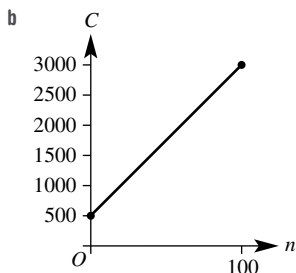

(Note: This graph should really be a series of points but a full line segment is used as a guide.)

- c \$1500 d 70

3 a $C = 50n + 40$ b \$240 c \$640

4 a $C = 120t + 300$

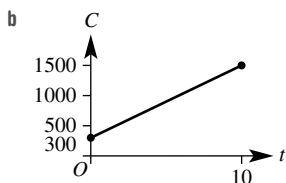

- c \$1020 d 3 hours

- 5 a $F = 18t + 12$ b 3 minutes c 2.5 minutes
 6 a $V = 4000 - 20t$ b 2200 L
 c 200 minutes or 3 hours 20 minutes
 d 2 hours 55 minutes or 175 minutes

7 a b $V = 1500 - 50t$

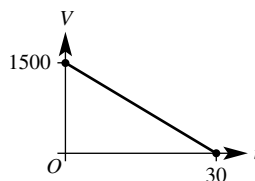

- c the number of litres drained per minute
 d 1250 L e 15 minutes
 8 a 80 km/h
 b rate changes, i.e. new gradient = 70, $d = 50 + 70t$
 9 a 20 m/s b -20 m/s
 c 350 m d 17.5 s
 e increasing altitude at rate of 20 m/s
 10 a i $C = 0.4n + 20$ ii 160
 b i $P = 0.8n - 20$ ii 25
 iii 120
 11 a $C = 10x + 6700$ b \$8700
 c 630 d \$11700
 e 670 f $P = 10x - 6700$
 g $T = \frac{10x - 6700}{x}$ h 1340

4K

Building understanding

- 1 a (1, 3) b (-1, 2) c (2, 2)
 2 a true b false c false d true
 3 a yes b yes c yes

Now you try

Example 20

- a yes b no

Example 21

(2, -1)

Exercise 4K

- 1 a yes b no c no
 d yes e no f no
 2 a (2, 2) b (3, 2) c (2, -4)
 d (3, 2) e (2, 1) f (3, 7)
 g (1, 2) h (2, 4) i (4, 1)
 j (-1, 3) k (-1, -5) l (1, 3)

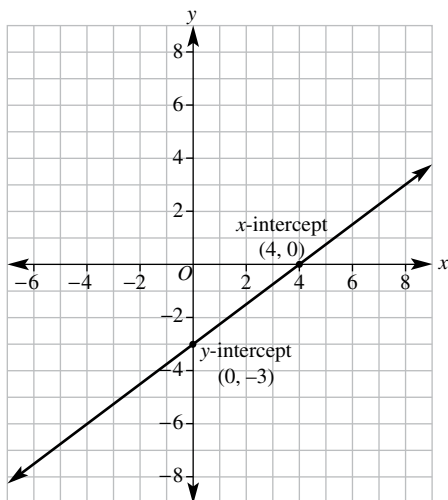

5

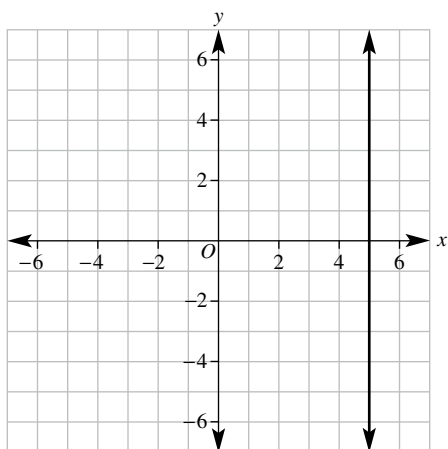
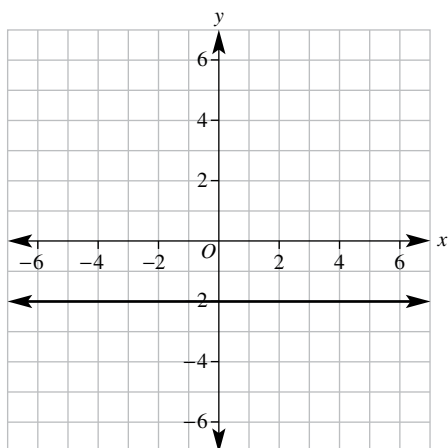

6

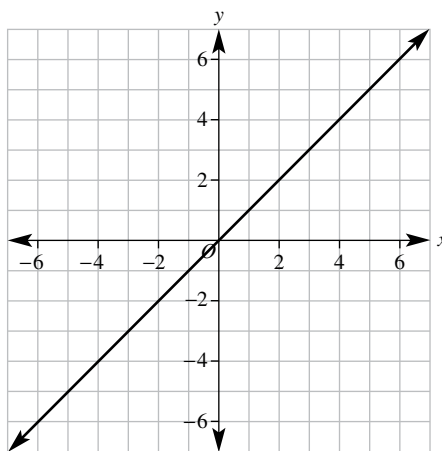

7 Negative, -2 ; zero, 0

8 $\frac{6}{5}$

9

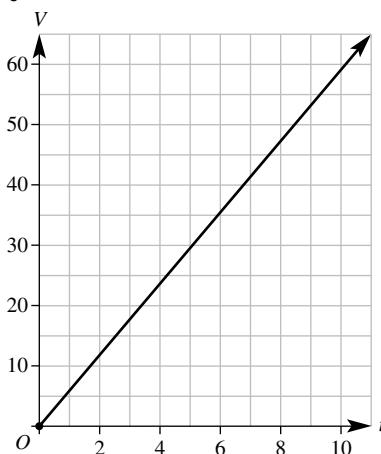

$V = 6t$; it takes $7\frac{1}{2}$ minutes to fill to 45 L

10 $y = -\frac{2}{3}x + \frac{8}{3}$

11 $y = -2x + 3$: Gradient = -2 , y-intercept = $(0, 3)$

$2y - 4x = 5$: Gradient = 2 , y-intercept = $(0, \frac{5}{2})$

12 $y = 3x - 2$: Gradient = 3 , y-intercept = $(0, -2)$

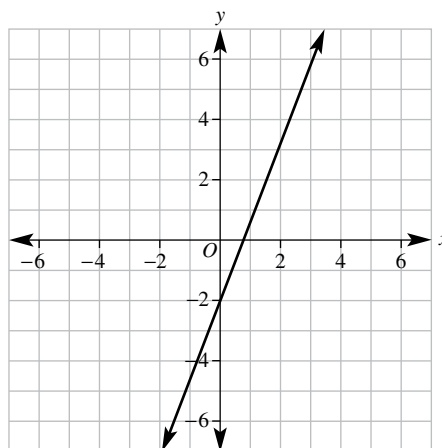

$2x + 3y = 8$: Gradient = $-\frac{2}{3}$, y-intercept = $(0, \frac{8}{3})$

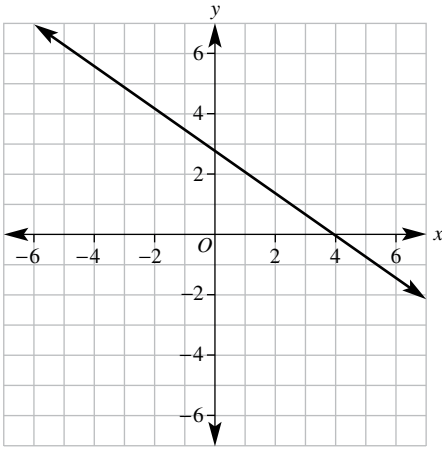

- 13 $y = 2x - 2$
- 14 $y = 2x + 9$
- 15 $(4, \frac{3}{2})$
- 16 6.40
- 17 $y = -2x + 1$
- 18 $y = -\frac{1}{4}x - 3$
- 19 $C = 80 + 40h$

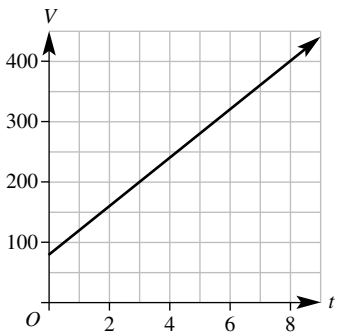

It would cost \$280 for 5 hours; for 3 hours it would cost \$200

- 20 (2, -1) is the intersection point
- 21

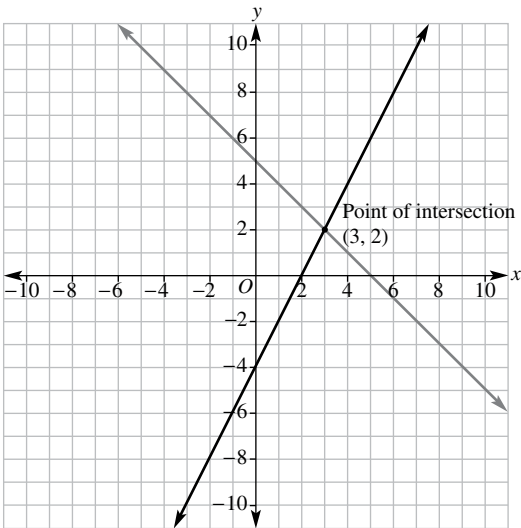

The intersection point is (3, 2)

Short-answer questions

- 1 a (-2, 0), (0, 4)
- 2 a

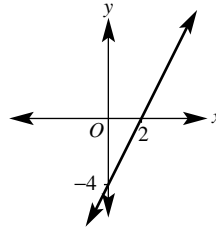

- b (3, 0), (0, -2)
- b

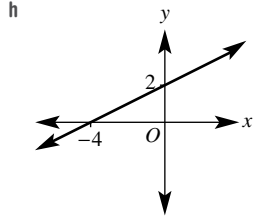
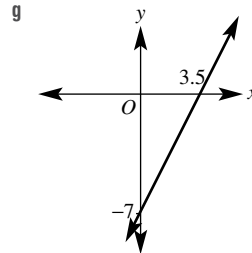
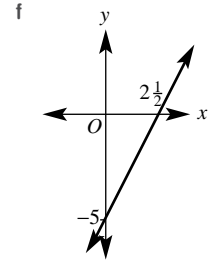
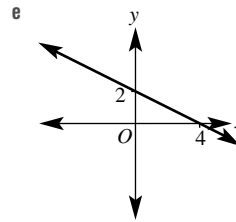
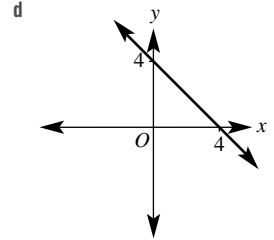
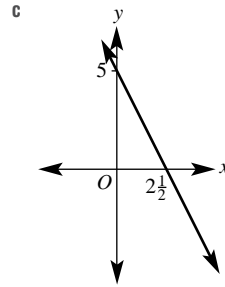
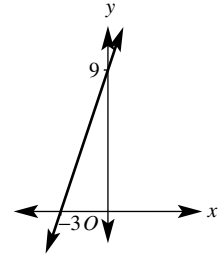

- 3 a 175 km
- b 2.5 hours
- c

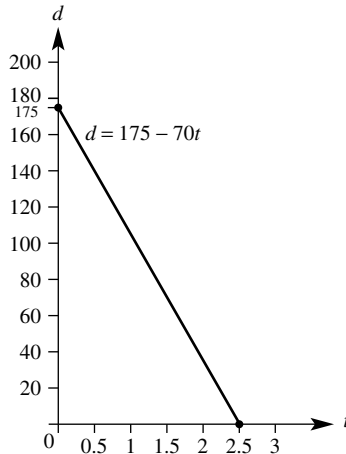

4 a $y = 3$ b $y = -2$ c $x = -4$

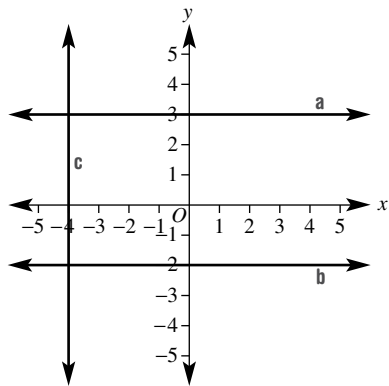

d $x = 5$ e $y = 3x$ f $y = -2x$

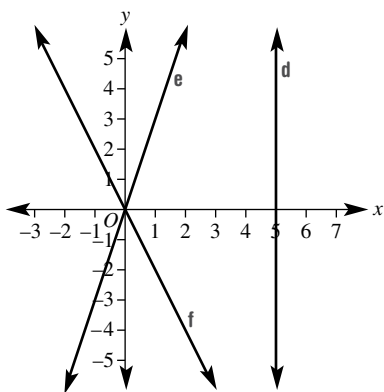

5 a 2 b -1 c $-\frac{5}{2}$
 d $\frac{4}{3}$ e 2 f $-\frac{10}{3}$

6 a 2000 L/h

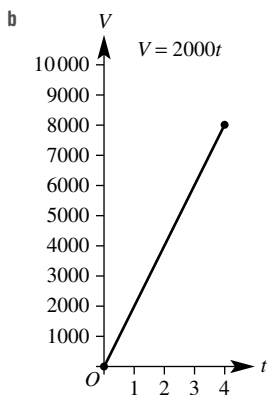

c $V = 2000t$
 d 2.5 hours

7 a gradient = 2 y-intercept = 3

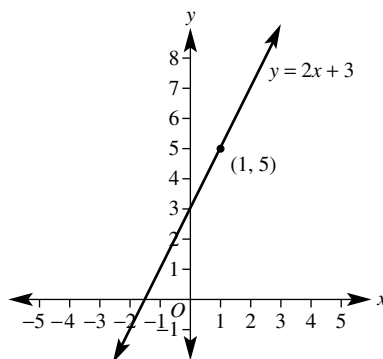

b gradient = -3 y-intercept = 7

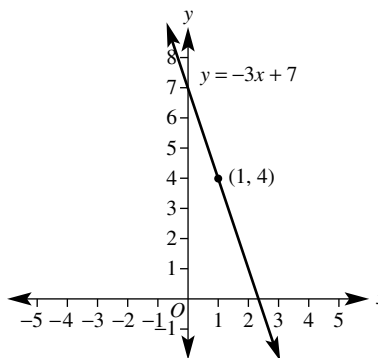

c gradient = $-\frac{2}{3}$ y-intercept = 3

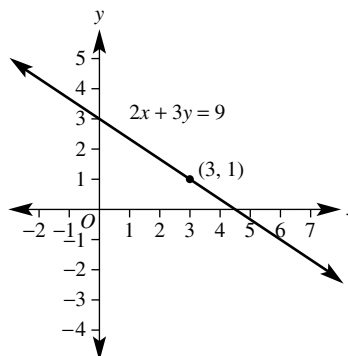

d gradient = $\frac{3}{2}$ y-intercept = 4

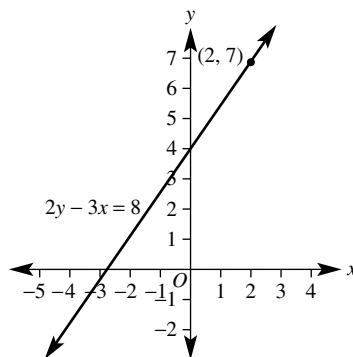

- 8 a $y = 3x + 2$ b $y = -2x + 6$ c $y = \frac{4}{3}x - 5$
 9 a $y = \frac{x}{2} - 1$ b $y = -3x + 6$
 c $y = 3x - 2$ d $y = -2x + 2$
 10 a i $M(4, 6)$ ii 5.66
 b i $M(7.5, 4.5)$ ii 7.07
 c i $M(0, 4)$ ii 7.21
 d i $M(-3, 2.5)$ ii 9.85
 11 a $n = 9$ b $n = 10$ c $n = 6$
 12 a $y = 2x + 4$ b $y = -x - 3$
 c $y = -\frac{1}{2}x - 1$ d $y = 3x + 4$
 e $y = 3x + 1$ f $3x + 2y = 8$ or
 $y = -\frac{3x}{2} + 4$
 13 a no b yes
 14 a (2, 0) b (-2, 4)

Multiple-choice questions

- 1 C 2 D 3 A 4 C 5 E
 6 B 7 B 8 A 9 D 10 D

Extended-response questions

- 1 a i \$40/h, \$80
 ii

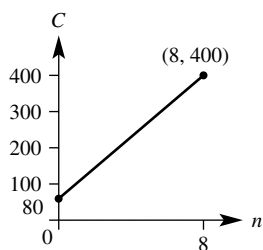

- iii \$180 iv 5 hours
 b i $C = 65 + 45n$
 ii

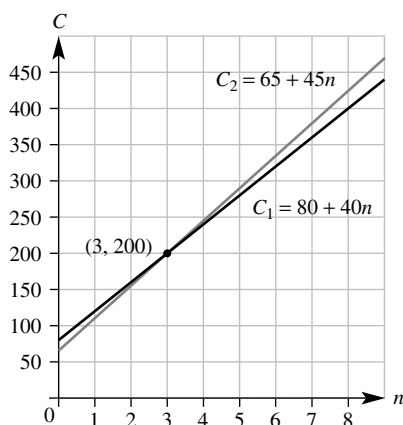

- c (3, 200) d after 3 hours
 2 a $C = 8v + 90$
 b i \$90 ii \$8 per vase
 c 23 vases

Chapter 5

5A

Building understanding

- 1 a 1 cm b 0.5°C c 0.25 L
 2 a 23 g b 1.78 L c 41.1 s
 3 a \$20 b 25%
 4 a yes b yes c no d yes e no

Now you try

Example 1

- a 10% b 6%

Example 2

- a 57.5 g and 58.5 g b 575 g and 585 g

Exercise 5A

- 1 a 10% b 5%
 c 4% d 12.5%
 2 a 5% b 6% c 6.25% d 3.75%
 3 a 25.45 g and 25.55 g
 b 509 g and 511 g
 4 a 14.5 g and 15.5 g
 b 435 g and 465 g
 5 a 1.505 L and 1.515 L b 15.05 L and 15.15 L
 6 a 35.5 cm, 36.5 cm
 b 102.5 m, 103.5 m
 c 3.15 mm, 3.25 mm
 d 6.75 min, 6.85 min
 e 45.235 hours, 45.245 hours
 f 83.505 g 83.515 g
 g 3.1055 kg, 3.1065 kg
 h 0.03565 L, 0.03575 L
 7 13.9%
 8 15 g
 9 172.5 cm or 174.3 cm
 10 21.2 kg or 21.8 kg
 11 a 22.975 km b 0.54%
 12 To indicate that the error is less than the actual amount.
 13 a 97.5% b 98.8%
 14 a 60.6% b 2.9%

5B

Building understanding

- 1 a 50 mm b 280 cm c 52.1 cm
 d 0.837 m e 4600 m f 2.17 km
 2 825 cm, 2.25 cm
 3 a $a = 3, b = 6$ b $a = 12, b = 4$
 c $a = 6.2, b = 2$ d $a = 9, b = 7$

Now you try

Example 3

- a 22 m b 20 cm

Example 4
7 mm

Exercise 5B

- 1 a 12 m b 27 cm c 18 km d 10 m
 2 a 32 cm b 80 cm c 170 cm
 d 30.57 m e 25.5 cm f 15.4 km
 3 a 9 cm b 4015 m c 102.1 cm
 4 a 8000 mm b 110 m c 1 cm
 d 20 mm e 0.284 km f 62.743 km
 5 a $x = 4$ b $x = 2.2$ c $x = 14$
 d $x = 9.5$ e $x = 6$ f $x = 4.2$
 6 108 m
 7 a 86 cm b 13.6 m
 8 a $x = 2$ b $x = 2.1$ c $x = 7$
 9 88 cm
 10 a $P = 2a + 2b$ b $P = 4x$ c $P = 2a + b$
 d $P = 2x + 2y$ e $P = 4(a + b)$ f $P = 2x$
 11 All vertical sides add to 13 cm and all horizontal sides add to 10 cm.
 12 a 8.3% b 8.3%
 c The percentage error is the same.
 13 a 25 cm, 75 cm
 b 40 cm, 60 cm
 c 62.5 cm, 37.5 cm
 d 10 cm, 20 cm, 30 cm, 40 cm
 14 a i 96 cm ii 104 cm iii 120 cm
 b $P = 4(20 + 2x)$, $\therefore P = 8x + 80$
 c i 109.6 cm ii 136.4 cm
 d i $x = 1.25$ ii $x = 2.75$
 e no, as with no frame the picture has a perimeter of 80 cm

5C

Building understanding

- 1 a 2.8 cm b 96 mm
 2 a 6π b 12π c $3 + 2\pi$
 d $12 + 3\pi$ e $8 + 2\pi$ f $3 + \frac{3\pi}{4}$
 3 a $\frac{1}{4}$ b $\frac{1}{2}$ c $\frac{3}{4}$
 d $\frac{1}{6}$ e $\frac{5}{12}$ f $\frac{5}{8}$

Now you try

Example 5

- a 25.13 m b 6.79 mm

Example 6

- a 12π m b $16 + 8\pi$ cm

Exercise 5C

- 1 a 87.96 cm b 9.42 mm c 12.57 km
 2 a 9.14 cm b 14.94 m c 33.13 cm
 d 10.00 cm e 20.05 m f 106.73 km
 3 a 12.56 m b 62.8 cm c 22 mm d 44 m

- 4 a 14π cm b 4π m c 41π km
 d 10π cm e 20π m f 11π mm
 5 a $8 + 2\pi$ m b $4 + 2\pi$ cm c $10\pi + 20$ cm
 d $12 + 2\pi$ km e $5\pi + 6$ m f $5\pi + 8$ cm
 6 28.27 m
 7 4.1 m
 8 31.42 cm
 9 a 188.50 cm
 b i 376.99 cm ii 1979.20 cm
 c 531
 10 a 11.5π m b $2.4 + 0.6\pi$ cm c $21 + 3.5\pi$ m
 d $5 + 1.875\pi$ km e $40 + 20\pi$ mm f $23 + 5.75\pi$ m
 11 a $r = \frac{C}{2\pi}$
 b i 1.6 cm ii 4.0 m
 c $d = \frac{C}{\pi}$ d 67 cm
 12 a 131.95 m b 791.68 m
 c i 3.79 ii 15.16
 d 63.66 m

5D

Building understanding

- 1 a 6 b 16 c 12
 d 1 e 12 f 153
 2 a rectangle b circle c rhombus/kite
 d sector of circle e triangle f trapezium
 g parallelogram h square i semicircle
 3 a $\frac{1}{4}$ b $\frac{1}{3}$ c $\frac{3}{4}$
 d $\frac{1}{6}$ e $\frac{5}{8}$ f $\frac{5}{18}$
 4 a 300 cm and 100 cm
 b $30\,000\text{ cm}^2$

Now you try

Example 7

- a 1.421 m^2 b 316 mm^2

Example 8

- a 40 m^2 b 36 mm^2 c 7.2 m^2

Example 9

- a 80 km^2 b 34 m^2

Example 10

- a 36.32 m^2 b 21.99 cm^2

Exercise 5D

- 1 a i 2.36 cm^2 ii 4.8 m^2
 b i $41\,600\text{ cm}^2$ ii 350 mm^2
 2 a 200 mm^2 b 5 cm^2 c $21\,000\text{ cm}^2$
 d 21 m^2 e 1000 m^2 f 3.2 km^2
 3 a 24 m^2 b 10.5 cm^2 c 20 km^2
 d 25.2 m^2 e 15 m^2 f 36.8 m^2
 4 a 21 mm^2 b 12 cm^2 c 17 cm^2
 d 63 m^2 e 6.205 m^2 f 15.19 km^2

- 5 a 12.25 cm^2 b 3.04 m^2 c 0.09 cm^2
 d 6.5 mm^2 e 18 cm^2 f 2.4613 cm^2
- 6 a 21.23 m^2 b 216.51 km^2 c 196.07 cm^2
- 7 a 7.07 m^2 b 157.08 cm^2 c 19.24 cm^2
 d 84.82 m^2 e 26.53 m^2 f 62.86 m^2
- 8 a $1.5 \times 10^{10} (15\,000\,000\,000) \text{ cm}^2$
 b 5 mm^2 c 0.075 m^2
- 9 $500\,000 \text{ m}^2$
- 10 0.51 m^2
- 11 12.89%
- 12 31%
- 13 a $r = \sqrt{\frac{A}{\pi}}$
 b i 1.3 cm ii 1.5 m iii 2.5 km
- 14 a i 64° ii 318°
 b as angle would be greater than 360° , which is not possible (28.3 m^2 is the largest area possible, i.e. full circle)
- 15 a 6.35 cm and 6.45 cm
 b 25.4 cm and 25.8 cm
 c 40.3 cm^2 and 41.6 cm^2
- 16 a i 1.5 m ii 1.5 m
 b 78 m^2
 c yes
- 17 46.7%

5E

Building understanding

- 1 a semicircle and rectangle b triangle and semicircle
 c rhombus and parallelogram
- 2 a $P = 2 \times 5 + 3 + \frac{1}{2} \times 2\pi r$ $A = bh + \frac{1}{2}\pi r^2$
 $= 10 + 3 + 1.5\pi$ $= 5 \times 2 + \frac{1}{2} \times \pi \times 1.5^2$
 $= 13 + 1.5\pi$ $= 10 + 1.125\pi$
 $= 17.7 \text{ m}$ $= 13.5 \text{ m}^2$
- b $P = 20 + 12 + 12 + 10 + 6$ $A = lw - \frac{1}{2}bh$
 $= 60 \text{ cm}$ $= 12 \times 20 - \frac{1}{2} \times 8 \times 6$
 $= 240 - 24$
 $= 216 \text{ cm}^2$

Now you try

Example 11

$$P = 16.71 \text{ m}, A = 16.07 \text{ m}^2$$

Example 12

$$24 \text{ cm}^2$$

Exercise 5E

- 1 a $46 \text{ m}, 97 \text{ m}^2$ b $18.28 \text{ m}, 22.28 \text{ m}^2$
 c $34 \text{ m}, 76 \text{ m}^2$ d $40 \text{ m}, 90 \text{ m}^2$
 e $19.42 \text{ m}, 26.14 \text{ m}^2$ f $85.42 \text{ mm}, 326.37 \text{ mm}^2$
- 2 a 17 cm^2 b 3.5 cm^2 c 21.74 cm^2
 d 6.75 m^2 e 189 cm^2 f 115 cm^2

- 3 a 108 m^2 b 33 cm^2 c 98 m^2
 d 300 m^2 e 16 cm^2 f 22.5 m^2
- 4 a 90 cm^2 b 15 m^2 c 9 m^2
 d 7.51 cm^2 e 7.95 m^2 f 180.03 cm^2
 g 8.74 mm^2 h 21.99 cm^2 i 23.83 mm^2
- 5 189.27 m^2
- 6 68.67 cm^2
- 7 a $37.70 \text{ m}, 92.55 \text{ m}^2$ b $20.57 \text{ mm}, 16 \text{ mm}^2$
 c $18.00 \text{ cm}, 11.61 \text{ cm}^2$ d $12.57 \text{ m}, 6.28 \text{ m}^2$
 e $25.71 \text{ cm}, 23.14 \text{ cm}^2$ f $33.56 \text{ m}, 83.90 \text{ m}^2$
- 8 a 136.3 cm^2 b 42.4 m^2 c 345.6 m^2
- 9 8 cm
- 10 a $36 + 18\pi$ b 16 c $12 - \frac{\pi}{8}$
 d 2π e $12.96 + 3.24\pi$ f $25 + \frac{75\pi}{4}$
- 11 7.1 cm
- 12 a hypotenuse (diameter) would equal 4.24 not 5
 b hypotenuse (sloped edge) should be 13 cm not 14 cm
 c hypotenuse (diameter) should be 5.83 not 8 m
- 13 5267.1 cm^2
- 14 a $34 \text{ cm}, 18 \text{ cm}$ b 226.9 cm^2 c 385.1 cm^2

Progress quiz

- 1 20%
- 2 25.35 cm and 25.45 cm
- 3 a 3.54 m b 15.2 cm
- 4 a $C = 25.1 \text{ mm}, A = 50.3 \text{ mm}^2$
 b $C = 37.7 \text{ cm}, A = 113.1 \text{ cm}^2$
- 5 a 15 cm^2 b 72 cm^2 c $16\pi \text{ cm}^2$
- 6 850 cm^2
- 7 a $P = 29.71 \text{ m}, A = 63.27 \text{ m}^2$
 b $P = 32 \text{ cm}, A = 44 \text{ cm}^2$
- 8 103.67 m^2

5F

Building understanding

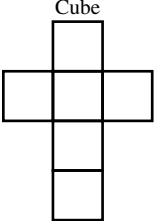
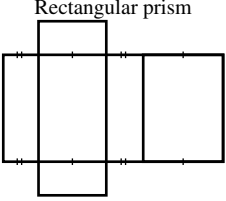
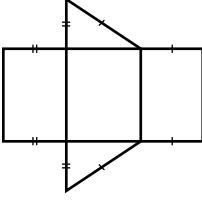
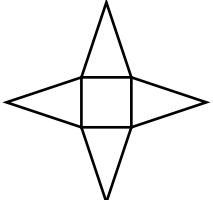
- 1 a  Cube
- b  Rectangular prism
- c  Triangular prism
- d  Square pyramid

e Tetrahedron
(triangular pyramid)

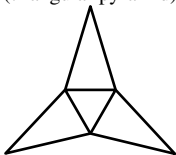

f Pentagonal pyramid

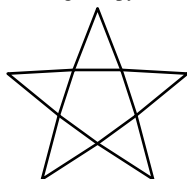

2 a $TSA = 2 \times 8 \times 7 + 2 \times 8 \times 3 + 2 \times 7 \times 3$
 $= 112 + 48 + 42$
 $= 202 \text{ m}^2$

b $TSA = 2 \times \frac{1}{2} \times 4 \times 3 + 5 \times 7 + 4 \times 7 + 3 \times 7$
 $= 12 + 35 + 28 + 21$
 $= 96 \text{ cm}^2$

Now you try

Example 13

a 202 m^2

b 85 m^2

Exercise 5F

- 1 a 242 cm^2 b 192 cm^2 c 85.76 m^2
 2 a 224 cm^2 b 39 mm^2 c 9.01 m^2
 3 a 108 cm^2 b 199.8 cm^2 c 0.96 m^2
 d 44.2 m^2 e 22 cm^2 f 28 cm^2

4 6 m^2

5 14.54 m^2

6 $34\,000 \text{ cm}^2$

7 a 44.4 m^2

b 4.44 L

8 a 1400 cm^2

b 1152 cm^2

9 a 10 cm^2



b 16 cm^2



c 24 cm^2

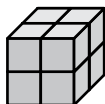

10 a $\{6, 10, 14, 18, 22, 26, 30, 34, 38\}$

b $S = 4n + 2$

c Answers may vary.

11 a 17.7 cm^2

b 96 m^2

c 204 cm^2

d 97.9 m^2

e 137.8 cm^2

f 43.3 mm^2

5G

Building understanding

1 a

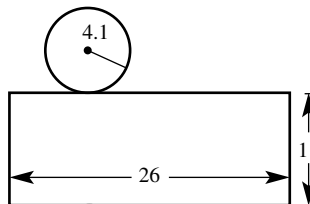

b

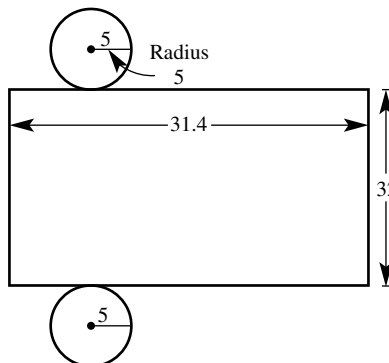

2 a 22 cm by 10 cm

b 12.57 cm by 8 cm

c 50.27 m by 9 m

Now you try

Example 14

716.28 cm^2

Example 15

182.52 m^2

Exercise 5G

- 1 a 25.13 m^2 b 471.24 cm^2 c 50.27 m^2
 2 a 44.0 cm^2 b 603.2 cm^2 c 113.1 m^2
 3 395.84 cm^2
 4 a 251.33 cm^2 b 207.35 mm^2 c 24.13 m^2
 5 a 54.56 m^2 b 218.23 m^2 c 63.98 cm^2
 d 71.91 cm^2 e 270.80 m^2 f 313.65 km^2
 g 326.41 m^2 h 593.92 m^2 i 43.71 mm^2
 6 7539.82 cm^2
 7 80424.8 cm^2
 8 a $18\,849.556 \text{ cm}^2$
 b i 1.88 m^2 ii 37.70 m^2
 c 239
 9 a $8\pi \text{ m}^2$ b $150\pi \text{ cm}^2$ c $16\pi \text{ m}^2$
 10 Surface area of half cylinder is more than half surface area of a cylinder as it includes new rectangular surface.
 11 a $\left(\frac{135\pi}{2} + 36\right) \text{ cm}^2$ b $\left(\frac{70\pi}{3} + 12\right) \text{ cm}^2$
 c $\left(\frac{29\pi}{12} + 4\right) \text{ m}^2$

5H

Building understanding

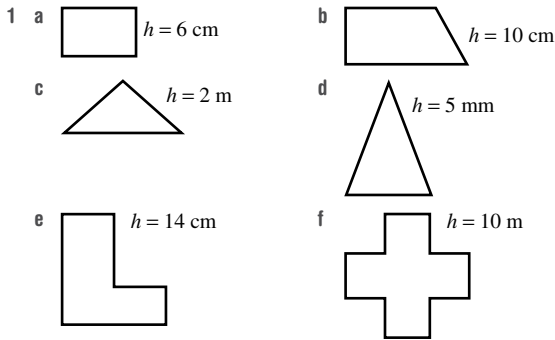

- 2 a 8 cm^3 b 84 m^3 c 21 mm^3

Now you try

Example 16

- a 4800 mm^3 b 0.612 m^3

Example 17

- a 12 cm^3 b 8 cm^3 c 15 m^3

Exercise 5H

- 1 a 3000 mm^3 b 2 cm^3
 c $87\,000\,000 \text{ cm}^3$ d 0.0059 m^3
 e $10\,000 \text{ m}^3$ f 0.0000217 km^3
 g 3000 mL h 200 L
 i 3.5 L j 21 mL
 k 37 kL l 42.9 mL
- 2 a 4 cm^3 b 18 m^3
 c 30 mm^3 d 16 cm^3
 e 42.875 m^3 f 15 cm^3
- 3 a 4 cm^3 b 10.5 m^3
 c 11.96 cm^3 d 29 cm^3
 e 14.88 m^3 f 8.1351 cm^3
 g 108 m^3 h 29.82 m^3
 i 0.382044 cm^3
- 4 a 75 m^3 b 30 cm^3 c 1.25 cm^3
- 5 a 8 L b 125 L
 c 0.36 L d 0.48 L
- 6 8000 cm^3
- 7 0.19 m^3
- 8 Yes, the tank only holds 20 L
- 9 a 67.2 cm^3 b 28 m^3
 c 8.9 km^3 d 28 m^3
 e 0.4 m^3 f 29232 mm^3
- 10 a 20 L b $75\,000 \text{ L}$ c 8000 L
- 11 a 55 m^2 b $825\,000 \text{ L}$
- 12 a i 1000 ii $\frac{1}{1000}$ iii 1000
 b i 1000 000 ii 1000

13 a $V = x^2h$ b $V = s^3$ c $V = 6r^3$

- 14 a Answers may vary. b $\frac{1}{3}$
 c Answers may vary.

5I

Building understanding

- 1 a $r = 4, h = 10$ b $r = 2.6, h = 11.1$
 c $r = 9, h = 23$
- 2 a 2 L b 4.3 mL c 3700 cm^3
 d 1000 L e 38 m^3 f 200 mL

Now you try

Example 18

- a 169.65 m^3 b 13.57 cm^3

Example 19

503 L

Exercise 5I

- 1 a 226.19 cm^3 b 137.44 m^3
 c 18.85 m^3 d 8.48 m^3
 e 100.53 cm^3 f 68.05 m^3
- 2 a 13 L b 503 L c 20 L
 d 4712 L e 589 049 L f 754 L
- 3 a 25.133 m^3 b 25 133 L
- 4 37 699 L
- 5 cylinder by 0.57 m^3
- 6 a 502.65 cm^3 b 1.02 m^3 c 294.52 m^3
 d 35342.92 m^3 e 47.12 cm^3 f 1017.88 cm^3
- 7 a 0.707 b 2.523
- 8 a $160\pi \text{ m}^3$ b $320\pi \text{ cm}^3$ c $54\pi \text{ km}^3$
 d $\frac{3\pi}{4} \text{ cm}^3$ e $1500\pi \text{ cm}^3$ f $144\pi \text{ mm}^3$
- 9 Answers may vary, but require $h = 2\pi r$.
- 10 a 113.10 cm^3 b 10471.98 m^3 c 3.73 m^3
 d 20.60 cm^3 e 858.41 cm^3 f 341.29 m^3

Problems and challenges

- 1 100 L
- 2 non-shaded is half the shaded area
- 3 157.1 m^2
- 4 $\sqrt{200} \text{ cm} = 14.14 \text{ cm}$
- 5 $\frac{1}{6} \text{ cm}$
- 6 $V = 2\pi^2 r^3$
- 7 $h = \frac{1-r^2}{r}$
- 8 Answers may vary, but $1000 = \pi r^2 h$ needs to hold true for r and h in centimetres. Designers need to consider production costs, material costs and keeping the surface area to a minimum so that they can maximise profits, as well as the ability to use, stack and market their products. If the container

is for cold storage, then fitting into a standard fridge door is also a consideration.

Success criteria example questions

- 23%
- 6.65 kg and 6.75 kg
- 20 cm
- 34 cm
- $x = 4$
- 37.70 cm
- 9.93 m
- 0.32 m^2 ; 240 mm^2
- 40 m^2 ; 30 m^2
- 40 m^2 ; 40 cm^2
- 12.57 m^2
- 104.72 cm^2
- Perimeter = 33.42 cm; area = 64.27 cm^2
- 76 m^2
- 180 cm^2
- 256 cm^2
- 164.93 m^2
- 167.96 cm^2
- $3\,000\,000 \text{ cm}^3$; 1.276 cm^3
- 200 cm^3
- 336 cm^3
- 20.36 m^2
- 101 L

Short-answer questions

- | | | |
|--------------------------|--------------------------|-----------------------|
| a 380 cm | b 1270 m | c 2.73 cm^2 |
| d $52\,000 \text{ cm}^2$ | e $10\,000 \text{ cm}^3$ | f 53.1 cm^3 |
| g 3.1 L | h 43 mL | i 2830 L |
- | | |
|------|-------|
| a 4% | b 40% |
|------|-------|
- | | | |
|--------|---------|-----------|
| a 14 m | b 51 mm | c 16.2 cm |
|--------|---------|-----------|
- | | | |
|---------------------|-----------------------|------------------------|
| a 4 cm^2 | b 1122 mm^2 | c 30.34 mm^2 |
| d 7.5 m^2 | e 15 cm^2 | f 3 cm^2 |
- | | |
|---------------------|----------------------|
| a 2.5 m^2 | b 37.4 m^2 |
|---------------------|----------------------|
- | |
|---|
| a $A = 28.27 \text{ cm}^2$, $P = 18.85 \text{ cm}$ |
| b $A = 5.38 \text{ m}^2$, $P = 9.51 \text{ m}$ |
- | |
|---|
| a $P = 15.24 \text{ m}$, $A = 13.09 \text{ m}^2$ |
| b $P = 14.10 \text{ m}$, $A = 10.39 \text{ m}^2$ |
| c $P = 24.76 \text{ km}$, $A = 33.51 \text{ km}^2$ |
- | | |
|------------------------------|-----------------------------------|
| a 8.86 m, 4.63 m^2 | b 45.56 cm, 128.54 cm^2 |
|------------------------------|-----------------------------------|
- | | |
|---------------------|---------------------|
| a 46 cm^2 | b 114 m^2 |
|---------------------|---------------------|
- | | |
|-------------------------|-----------------------|
| a 659.73 mm^2 | b 30.21 m^2 |
|-------------------------|-----------------------|
- | | | |
|---------------------|--------------------|--------|
| a 30 cm^3 | b 54 m^3 | c 25 L |
|---------------------|--------------------|--------|

Multiple-choice questions

- | | | | | |
|-----|-----|-----|-----|------|
| 1 E | 2 B | 3 C | 4 B | 5 A |
| 6 D | 7 B | 8 E | 9 C | 10 E |

Extended-response questions

- | | | |
|---|--------|-----------------------------|
| a 517.08 cm | b \$65 | c $15\,853.98 \text{ cm}^2$ |
| d 1.58 m^2 ; claim is correct | | |
- | | | |
|---------------------------|------------------------|---------------------------|
| a 1 cm | b 15.71 cm^2 | c $125\,680 \text{ cm}^3$ |
| d $0.125\,68 \text{ m}^3$ | e 18.85 cm | f 15 m^2 |
| g \$1200 | | |

Semester review 1

Reviewing number and financial mathematics

Short-answer questions

- | | | | |
|-------------------|-----------------|-----------------|------------------|
| a $\frac{19}{28}$ | b $\frac{7}{9}$ | c $\frac{3}{8}$ | d $1\frac{4}{5}$ |
|-------------------|-----------------|-----------------|------------------|
- | | | | |
|-------|----------|-------|-------|
| a 60% | b 31.25% | c 10% | d 25% |
|-------|----------|-------|-------|
- | | | |
|---------|-----------|------------|
| a 5 : 3 | b 55 km/h | c 2.4 mL/h |
|---------|-----------|------------|
- | | |
|-----------|-----------|
| a \$67.20 | b 64.4 cm |
|-----------|-----------|
- \$892

Multiple-choice questions

- | | | | | |
|-----|-----|-----|-----|-----|
| 1 B | 2 E | 3 D | 4 D | 5 A |
|-----|-----|-----|-----|-----|

Extended-response question

- | | | | |
|------------------|-----------------|-------------|--------|
| a i \$17 500 | ii \$23 520 | iii 9 years | iv 27% |
| b \$23 635.69 | | | |
| c i Jim by \$116 | ii Jim by \$922 | | |

Expressions and linear equations

Short-answer questions

- | | |
|-------------------------|----------------------|
| a $x = 6$ | b $x > \frac{9}{2}$ |
| c $m = \frac{3}{8}$ | d $y = -1$ |
| e $a \leq \frac{1}{11}$ | f $x = \frac{-1}{3}$ |
- | |
|-------------------------------|
| a $\frac{m-3}{2} = 6$ |
| b Noah gets \$15 pocket money |
- | | | |
|-------|--------------------------|------|
| a 155 | b $I = \frac{2S}{n} - a$ | c 18 |
|-------|--------------------------|------|
- | | |
|-------------------|--------------------|
| a $x = 6, y = 3$ | b $x = -1, y = -5$ |
| c $x = 5, y = -2$ | d $x = -3, y = 4$ |

Multiple-choice questions

- | | | | | |
|-----|-----|-----|-----|-----|
| 1 E | 2 A | 3 C | 4 B | 5 D |
|-----|-----|-----|-----|-----|

Extended-response question

- a i $12x + 20 > 74$ ii 5 games
 b i Let $\$x$ be the cost of a raffle ticket and $\$y$ the cost of a badge.
 ii $5x + 2y = 11.5$ and $4x + 3y = 12$
 iii A raffle ticket costs $\$1.50$ and a badge costs $\$2$.

Pythagoras' theorem and trigonometry

Short-answer questions

- 1 a $x = 15.1$ b $x = 5.7$
 c $x = 11.2$ d $\theta = 29.5^\circ$
 2 a $x = 13, y = 14.7$ b $y = 9.4, x = 9.9$
 3 a 19.21 m b 38.7°
 4 a 16.3 km west b 115°

Multiple-choice questions

- 1 D 2 A 3 C 4 A 5 E

Extended-response question

- a 17.75 m b 14.3°
 c i 18.8 m ii 6.8 s

Linear relationships

Short-answer questions

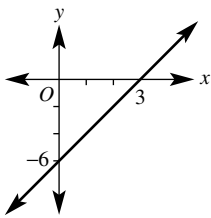
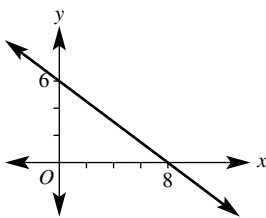
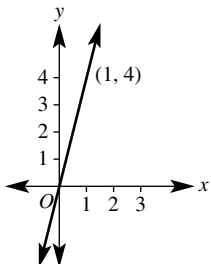
- 1 a 
- b 
- c 

- 2 a $\frac{2}{3}$ b -3 c -2 d $\frac{4}{3}$
 3 a $y = -3x + 6$ b $y = 3x - 1$
 c $y = 2x$ d $y = -\frac{1}{3}x + 2$
 4 (3, 2)

Multiple-choice questions

- 1 C 2 D 3 B 4 C 5 A

Extended-response question

- a 12 kg/h b $S = 180 - 12t$

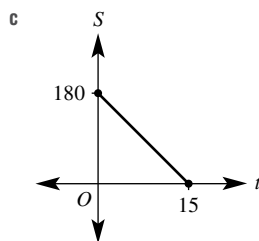

- d 15 hours
 e i $P = 40 + 25h$ ii $\$415$

Measurement

Short-answer questions

- 1 a 6.25% b 6.35 kg, 6.45 kg
 2 a 24.57 m^2 b 36 cm^2
 3 4 tins
 4 a 216 m^2 b 25.45 m^2
 5 a 192 cm^3 b 156.4 cm^3

Multiple-choice questions

- 1 C 2 E 3 D 4 A 5 A

Extended-response question

- a 45.71 m^2
 b i 0.0377 m^2 ii 3.77 m^2
 c 1213 d 37.85 m^3 e 19.45 m^3

Chapter 6

6A

Building understanding

- 1 a 2 b 3 c 3 d 2
 2 a 3 b -7 c $\frac{2}{3}$ d y
 3 a 3 b 7 c 4 d 13
 4 a 2, 3 b 3, 5 c 2, 3, 5 d 7, 11

Now you try

Example 1

a $b \times b \times b \times b$ b $mn \times mn \times mn$ c $5 \times a \times a \times b$

Example 2

a 16 b -27 c $\frac{16}{9}$

Example 3

a $2y^3$ b $(\frac{5}{9})^3 \times (\frac{3}{7})^2$ c 3^3a^2

Example 4

$2^2 \times 3 \times 5$

Exercise 6A

- 1 a $b \times b \times b$ b $x \times x \times x$
 c $5 \times a \times 5 \times a \times 5 \times a \times 5 \times a$
 d $3 \times y \times 3 \times y \times 3 \times y$ e $p \times q \times p \times q$
 f $-3 \times s \times s \times s \times t \times t$
 g $6 \times x \times x \times x \times y \times y \times y \times y \times y \times y$
 h $5 \times y \times z \times y \times z \times y \times z \times y \times z \times y \times z \times y \times z \times y \times z$
- 2 a 36 b 16 c 243 d 12
 e -8 f -1 g 81 h 25
- i $\frac{8}{27}$ j $\frac{9}{16}$ k $\frac{1}{216}$ l $\frac{25}{4}$
 m $-\frac{8}{27}$ n $\frac{81}{256}$ o $\frac{1}{16}$ p $-\frac{3125}{32}$
- 3 a 3^3 b 8^6 c y^2 d $3x^3$
 e $4c^5$ f 5^3d^2 g x^2y^3 h 7^3b^2
- 4 a $(\frac{2}{3})^4$ b $(\frac{3}{5})^5$
 c $(\frac{4}{7})^2 (\frac{1}{5})^4$ d $(\frac{7x}{9})^2 (\frac{y}{4})^3$
- 5 a $3^3 \cdot 3^3 y^2$ b $(3x)^2(2y)^2$ or $3^2 2^2 x^2 y^2$
 c $(4d)^2(2e)^2$ or $4^2 2^2 d^2 e^2$ d $6^3 b^2 y^3$
 e $(3pq)^4$ or $3^4 p^4 q^4$ f $(7mn)^3$ or $7^3 m^3 n^3$
- 6 a 2×5 b 2^3 c $2^4 \times 3^2$
 d 2^9 e $2^3 \times 3^3$ f $2^2 \times 5^3$
- 7 a 36 b -216 c 1 d $-\frac{8}{27}$
 e -18 f 15 g -36 h 216
- 8 a 4 b 8 c 5 d 2
 e -4 f -2 g $\frac{1}{2}$ h 4
- 9 a i 10 min ii 20 min iii 30 min
 b $2^{24} = 16777216$ cells
- 10 a $1000 \times 3^5 = \$243\,000$ b 5 years
- 11 7 months
- 12 a i 9 ii 9 iii -9 iv -9
 b Same signs give positive when multiplying
 c A positive answer is multiplied by the -1 outside the bracket.
- 13 a i 8 ii -8 iii -8 iv 8
 b A positive cubed is positive.
 A negative answer is multiplied by negative.
 c A negative number cubed will be negative.
 A positive answer is multiplied by negative one.

- 14 a $\frac{1}{8}$ b $\frac{1}{16}$ c $\frac{1}{125}$
 d $\frac{1}{64}$ e $\frac{49}{100}$ f $\frac{81}{16}$
 g $\frac{169}{25}$ h $\frac{12769}{100}$ i $\frac{289}{25}$
- 15 a LCM = 12, HCF = 2 b LCM = 84, HCF = 14
 c LCM = 72, HCF = 12 d LCM = 30, HCF = 5
 e LCM = 360, HCF = 10 f LCM = 300, HCF = 10
 g LCM = 1764, HCF = 14 h LCM = 13068, HCF = 198

6B

Building understanding

- 1 a multiply, base, add b divide, base, subtract
- 2 a $3 \times 3 \times 3 \times 3 \times 3 \times 3 = 3^6$
 b $\frac{5 \times 5 \times 5 \times 5 \times 5}{5 \times 5 \times 5} = 5^2$
- 3 a true b true c false
 d false e true f false

Now you try

Example 5

a 2^9 b 9^4

Example 6

a x^{11} b a^3b^7 c $28m^5$

Example 7

a a^4 b $\frac{2x^3y}{5}$

Example 8

a a^5 b $2a^2b^2$

Exercise 6B

- 1 a i 2^7 ii 5^9
 b i 3^3 ii 6^5
- 2 a 7^6 b 8^{10} c 3^8 d 6^{14}
 e 5^3 f 10 g 9^3 h $(-2)^2$
- 3 a x^7 b a^9 c t^8 d y^5
 e d^3 f y^7 g b^8 h q^{11}
 i x^7y^5 j x^9y^4 k $5x^4y^9$ l $4x^2y^5z$
 m $15m^5$ n $8e^6f^4$ o $20c^7d^2$ p $18y^2z^7$
- 4 a a^2 b x^3 c q^{10} d d
 e $2b^5$ f $\frac{d^5}{3}$ g $2a^7$ h $2y^8$
 i $9m$ j $14x^3$ k $5y^2$ l $6a$
 m $\frac{m^5}{4}$ n $\frac{w}{5}$ o $\frac{a}{5}$ p $\frac{x^4}{9}$
 q $\frac{4x^6y^3}{3}$ r $\frac{3st^2}{7}$ s $\frac{4mn}{3}$ t $-5x$
- 5 a b^6 b y^6 c c^7 d x
 e t f p^6 g d^6 h x^{10}
 i $4x^2y^3$ j $6b^2g$ k $3m^5n^6$ l p^5q^4

- 6 a $\frac{m^5}{n^5}$ b $\frac{x^4}{y^2}$ c a^3b^3
 d $\frac{6a^5}{c^7}$ e $6f^6$ f $12x^4b^2$
 g $6k^3m^3$ h $\frac{15x^4y}{2}$ i $\frac{3m^2n^3}{2}$
- 7 a 12 b 8 c 3 d 3
 e 1 f 18 g 12 h 11
 i 4 j 15 k 2 l 39
- 8 a $7^2 = 49$ b 10
 c $13^2 = 169$ d $2^3 = 8$
 e 101 f $200^2 = 40000$
 g $7 \times 31 = 217$ h $43 \times 50^2 = 7500$
- 9 a 7 combinations b 14 combinations
- 10 a a^5 , power of one not added
 b x^6 , power of one not subtracted
 c $\frac{a^2}{2}$, $3 \div 6$ is $\frac{1}{2}$ not 2
 d $\frac{x^4}{2}$, numerator power is larger hence x^4 in numerator
 e $6x^{11}$, multiply coefficients not add
 f $a^3 \times a = a^4$, order of operations done incorrectly
- 11 a $4x$ b $12x^2$ c $10x^3$ d $-4x$
 e $40x^6$ f $\frac{5x}{4}$ g $\frac{8}{5}$ h $-20x^4$
- 12 a 2^{x+y} b 5^{a+b} c t^{x+y}
 d 3^{x-y} e 10^{p-y} f 2^{p+q-r}
 g 10^{p-q-r} h $25a$ i a^{3x-2b^x+3}
 j $a^{x+y}b^{x+y}$ k $a^{x-y}b^{y-x}$ l $w^{2-x}b^{x+3}$
 m a^{x+y-2} n p^aq^{b-5} o $4m^{y-3-2x}$
- 13 Answers may vary.
 14 Answers may vary.

6C

Building understanding

- 1 a multiply b 1
 2 a 16, 8, 4, 2, 1 b 64, 16, 4, 1
 3 a $(4 \times 4) \times (4 \times 4) \times (4 \times 4) = 4^6$
 b $(a \times a) \times (a \times a) \times (a \times a) \times (a \times a) \times (a \times a) = a^{10}$

Now you try

Example 9

a a^6 b $5b^{14}$

Example 10

a 1 b -1 c 5

Example 11

a y^{18} b t^5 c m

Exercise 6C

- 1 a x^{10} b b^{12} c a^{20} d m^{12}
 e 3^6 f 4^{15} g 3^{30} h 7^{10}
 i $4q^{28}$ j $3m^{10}$ k $-3c^{10}$ l $-4a^{21}$

- 2 a 1 b 1 c 1 d 1
 e -1 f 1 g 1 h 1
 3 a 5 b -3 c 4 d -6
 e 4 f 3 g 1 h 0
 4 a 4^7 b 3^9 c x d y^{13}
 e b^{14} f a^{10} g d^{24} h y^{16}
 i z^{25} j $a^{11}f^{13}$ k $x^{14}y^5$ l $5rs^8$
- 5 a 7^2 b 4 c 3^8 d 1 e y^3
 f h^2 g b^6 h x^5 i y^6
- 6 a $\frac{2}{x^5}$ b $\frac{10}{x^3}$ c $3x^8$
 d $\frac{d^2e}{2}$ e $\frac{2m^6n}{5}$ f $\frac{a^{12}}{8}$
- 7 a i 400 ii 6400 iii 100
 b i 800 ii 12800 iii 102400
 c 13 years
- 8 5 ways
- 9 a 4 b 1000 c 1
 d 1 e 4 f 1
- 10 a 4×5 not $4 + 5$, a^{20}
 b power of 2 only applies to x^3 , $3x^6$
 c power zero applies to whole bracket, 1
- 11 a i 2^{24} ii $(-2)^{30} = 2^{30}$
 iii x^{84} iv a^{48}
 b i 2^{abc} ii a^{mnp} iii x^{6yz}
- 12 a Answers may vary. b Answers may vary.
- 13 a 2^{12} b 2^{15} c 3^6 d 3^{20} e 5^{10}
 f 3^{50} g 2^{72} h 7^{80} i 10^{50}

6D

Building understanding

- 1 a $a^m \times b^m$ b $\frac{a^m}{b^m}$
 2 a $5a \times 5a \times 5a$
 $= 5 \times 5 \times 5 \times a \times a \times a$
 $= 5^3 \times a^3$
 b $\frac{x}{6} \times \frac{x}{6} \times \frac{x}{6}$
 $= \frac{x \times x \times x}{6 \times 6 \times 6}$
 $= \frac{x^3}{6^3}$

Now you try

Example 12

a $9a^2$ b $-27x^6y^9$ c $5a^8b^4$ d $16b^{11}$

Example 13

a $\frac{32}{x^5}$ b $\frac{9m^6}{4n^2p^4}$ c $\frac{x^5y^4}{72}$

Exercise 6D

- 1 a $25y^2$ b $64a^6$
 c $9r^2$ d $-81b^4$
 e $-343r^3$ f $(-2)^4h^8 = 16h^8$

- g $625c^8d^{12}$
- i $9p^6q^{12}$
- k $-4p^8q^2r^2$
- 2 a $9ab^2$
- c $-12a^8b^8$
- e $-64b^6c^{15}d^3$
- g $9a^5$
- i $160m^{15}p^5t^{10}$
- k $1024x^{12}y^3z^9$
- m $a^{10}b^{11}$
- o $12c^8d^7$
- 3 a $\frac{p^3}{q^3}$
- c $\frac{64}{y^3}$
- e $\frac{y^6}{49}$
- g $\frac{27n^9}{8m^{12}}$
- i $\frac{9f^2}{64g^{10}}$
- k $\frac{27k^3m^9}{64n^{21}}$
- 4 a $\frac{2x^7}{y^7}$
- c $\frac{p^2q^{14}}{r^8}$
- e $x^{11}y^2z$
- 5 a i 8
- b $N = \frac{t^3}{8}$
- c i 27
- d i 8
- 6 a 2
- d 2
- 7 a false, $(-2)^2 = +(2)^2$
- c true, $(-5)^5 = -(5)^5$
- 8 a By simplifying first, there are smaller numbers to raise to powers.
- b i 8
- 9 a 25
- c no
- e i true
- iii true

- h $32x^{15}y^{10}$
- j 1
- l $25s^{14}t^2$
- b $27ab^6$
- d $54x^6y^9$
- f $8a^4$
- h $-40a^{15}b^3$
- j $-49d^4f^8g^2$
- l $-16a^8b^7$
- n $8m^5n^3$

- b $\frac{x^4}{y^4}$
- d $\frac{4}{r^6}$
- f $\frac{32m^5}{n^5}$
- h $\frac{16r^4}{n^4}$
- j $\frac{9x^2}{4y^6g^{10}}$
- l $\frac{25w^8y^2}{4x^6}$
- b $\frac{a^8b^{10}}{c^7}$
- d $a^{11}bc^5$
- f $\frac{r^9t^{10}}{s}$
- ii 125
- ii 8
- ii 2
- c 2
- f 14
- b true, $(-3)^3 = -(3)^3$
- d false, $(-4)^4 = +(4)^4$
- iii $\frac{1}{81}$
- iv $\frac{1}{1000}$
- b 13
- d no, $(3-2)^2 \neq 3^2 - 2^2$
- ii false
- iv false

- 3 a $\frac{p^3}{q^3}$
- c $\frac{64}{y^3}$
- e $\frac{y^6}{49}$
- g $\frac{27n^9}{8m^{12}}$
- i $\frac{9f^2}{64g^{10}}$
- k $\frac{27k^3m^9}{64n^{21}}$
- 4 a $\frac{2x^7}{y^7}$
- c $\frac{p^2q^{14}}{r^8}$
- e $x^{11}y^2z$
- 5 a i 8
- b $N = \frac{t^3}{8}$
- c i 27
- d i 8
- 6 a 2
- d 2
- 7 a false, $(-2)^2 = +(2)^2$
- c true, $(-5)^5 = -(5)^5$
- 8 a By simplifying first, there are smaller numbers to raise to powers.
- b i 8
- 9 a 25
- c no
- e i true
- iii true

6E

Building understanding

- 1 a $\frac{1}{2^2}$
- b $\frac{1}{3^2}$
- c $\frac{1}{5^3}$
- d $\frac{1}{3^3}$

2 a

Index form	3^4	3^3	3^2	3^1
Whole number or fraction	81	27	9	3

Index form	3^0	3^{-1}	3^{-2}	3^{-3}
Whole number or fraction	1	$\frac{1}{3}$	$\frac{1}{9} = \frac{1}{3^2}$	$\frac{1}{27} = \frac{1}{3^3}$

b

Index form	10^4	10^3	10^2	10^1
Whole number or fraction	10 000	1000	100	10

Index form	10^0	10^{-1}	10^{-2}	10^{-3}
Whole number or fraction	1	$\frac{1}{10}$	$\frac{1}{100} = \frac{1}{10^2}$	$\frac{1}{1000} = \frac{1}{10^3}$

Now you try

Example 14

- a $\frac{1}{a^3}$
- b $\frac{2y^3}{x^4}$

Example 15

- a a^3
- b $\frac{6b^5}{a^2}$
- c $\frac{y^4}{x^2}$

Example 16

- a $\frac{1}{32}$
- b -32
- c $\frac{49}{25}$

Exercise 6E

- 1 a $\frac{1}{x^5}$
- e $\frac{1}{64}$
- i $\frac{3}{m^5}$
- m $\frac{2}{a^3b}$
- 2 a y
- e $7q$
- i ab^2
- m $-\frac{3y^4}{7}$
- 3 a $\frac{7x^4}{y^3}$
- e $\frac{5a^2b^2}{6c^4d}$
- 4 a $\frac{b^3}{a^3}$
- e $\frac{343}{5}$
- 5 a $\frac{1}{5}$
- e $\frac{1}{25}$
- b $\frac{1}{a^4}$
- f $\frac{1}{9}$
- j $\frac{p^7}{q^2}$
- k $\frac{m}{n^4}$
- n $\frac{7}{r^2s^3}$
- b b^2
- f $3t^2$
- j de
- n $-2b^8$
- b $\frac{u^3}{v^2}$
- f $\frac{4h^3m^2}{5k^2p}$
- b $\frac{y^5}{x^2}$
- f $\frac{64}{9}$
- b $\frac{1}{9}$
- f $-\frac{1}{200}$
- c $\frac{1}{b^6}$
- g $\frac{5}{x^2}$
- k $\frac{m}{n^4}$
- o $\frac{y^2}{5u^8}$
- c m^5
- g $5h^4$
- k $2m^3n^2$
- o $-\frac{3gh^3}{4}$
- c $\frac{y^3}{5a^3}$
- c $\frac{y^3}{5a^3}$
- c $\frac{h^3}{g^2}$
- c $\frac{6}{25}$
- c $\frac{1}{16}$
- g $-\frac{3}{4}$
- d $\frac{1}{25}$
- h $\frac{4}{y^3}$
- i $\frac{x^4}{y^4}$
- p $\frac{1}{9m^3n^5}$
- d x^4
- h $4p^4$
- l $\frac{x^2y^5}{3}$
- p $\frac{9u^2t^2}{5}$
- d $\frac{2b^5}{a^4c^2}$
- h $\frac{mn^4x^2}{16y^5}$
- d $\frac{n}{m}$
- h 1
- d $-\frac{1}{25}$
- h $\frac{1}{2}$

i $\frac{1}{36}$	j $\frac{1}{8}$	k $\frac{4}{25}$	l $\frac{7}{81}$
m 8	n 100	o -250	p 16
q -10	r 64	s $\frac{64}{9}$	t $-\frac{27}{64}$
u 100	v $\frac{1}{3}$	w -2	x 49

6 1.95 g

7 a -4 b -4 c -4

d -1 e -2 f -1

8 a negative power only applies to x , $\frac{2}{x^2}$

b $5 = 5^1$ has a positive power, $5a^{-4}$

c $\frac{2}{3^{-2}b^{-2}} = 2 \times 3^2 \times b^2 = 18b^2$

9 a $1 \div \frac{2}{3} = 1 \times \frac{3}{2}$

b i $\frac{4}{5}$ ii $\frac{7}{2}$ iii $\frac{3}{x}$ iv $\frac{b}{a}$

c (fraction)⁻¹ = reciprocal of fraction

d i $\frac{9}{4}$ ii $\frac{25}{16}$ iii 32 iv $\frac{27}{343}$

10 a 4 b 4 c 3 d 2

e 4 f $\frac{3}{2}$ g 4 h $\frac{7}{3}$

Progress quiz

1 a $a \times a \times a \times a$

c $2 \times 2 \times 2 \times 2 = 16$

2 a $7m^4$

c $8^3e^4h^3 = (8h)^3e^4$

3 a 2^8

d 5^8

b a^9

e $2a^6$

c $12k^7m^2$

f $\frac{a^5m^4}{3}$

4 a x^6

5 a x^{12}

6 a 1

7 a a^{14}

b $3xy$

b $-4q^{42}$

c 7

c 4

d -5

d $\frac{4m^8n^4}{3}$

8 a $8b^3$

d $\frac{64}{c^3}$

b $5h^6j^9k^3$

e $\frac{-8w^3x^9}{125y^6}$

c $-27x^{12}y^6$

f a^8c^2

9 a $\frac{1}{m^4}$

d $\frac{c^3}{a^2}$

b $\frac{7y^5}{x^3}$

e $-13m^5$

c a^5

f $\frac{-15u^3w^3}{t^2v^2}$

10 a $\frac{1}{16}$

b 27

c $\frac{1}{36}$

d $\frac{8}{27}$

6F**Building understanding**

1 a 10 000

d 1000

b 1000

e 100 000

c 100 000

f 10 000

2 a 10^5

b 10^2

c 10^9

3 a positive

b negative

c positive

d negative

Now you try

Example 17

a 7.2×10^5

b 3×10^{-6}

Example 18

a 6170

b 0.00000402

Exercise 6F

1 a 4.3×10^4

d -7.2×10^6

g 5.2×10^3

2 a 3×10^{-6}

d 7.3×10^{-10}

g -8.09×10^{-9}

3 a 6×10^3

d 7.86903×10^3

g 3.28×10^{-4}

j -4.601×10^8

4 a 57 000

c 430 000 000

e 423 000

g 197 000 000

i 635 700

5 a 0.00012

c 0.0000000008

e 0.3678

g 0.00009

i 0.4

6 a 6×10^{24}

d 1.5×10^8

g 4.5×10^9

7 a 4600 000 000

c 384 000

e 0.000000000000001

8 a 4.92×10^{-1}

d 5.2×10^{-8}

g 4×10^6

j 1.82×10^5

9 a $\$1.84 \times 10^9$

10 1.62×10^9 km

11 2.126×10^{-2} g

12 a 3.2×10^4

d 5.714×10^5

g 3×10^5

j 4.24

m 2×10^{-5}

p 4.001×10^{-8}

13 a 8×10^6

d 3.375×10^{-9}

g 9×10^{-4}

14 a 6×10^6

d 3×10^9

g 1.2×10^3

j 7.5×10^{-8}

15 $5 \times 10^2 = 500$ seconds

16 a 3×10^{-4} km = 30 cm

b 1×10^{-3} seconds (one thousandth of a second)

= 0.001 seconds

b 2.3×10^{12}

e -3.5×10^3

h 3×10^6

b 4×10^{-4}

e -3×10^{-5}

h 2.4×10^{-8}

b 7.2×10^5

e 8.45912×10^3

h 9.87×10^{-3}

k 1.7467×10^4

c 1.6×10^{10}

f -8.8×10^6

i 2.1×10^4

c -8.76×10^{-3}

f 1.25×10^{-10}

i 3.45×10^{-5}

c 3.245×10^2

f 2×10^{-1}

i -1×10^{-5}

l -1.28×10^2

b 3600 000

d 32 100 000

f 90 400 000 000

h 709

b 0.0000046

d 0.0000352

f 0.000000123

h 0.05

b 4×10^7

e 6.67×10^{-11}

c 1×10^{-10}

f 1.5×10^{-4}

b 8 000 000 000 000

d 0.0038

f 720 000

b 3.8×10^{-4}

e 4×10^{-9}

h 2×10^{12}

k 1.8×10^{-11}

c 2.1×10^{-6}

f 1.392×10^{-7}

i 5.2×10^7

l 4×10^{-7}

b $\$2.647 \times 10^9$

b 4.1×10^6

e 1.3×10^4

h 4.6×10^5

k 1.013×10^{-3}

n 4×10^{-6}

c 3.17×10^4

f 9.2×10^1

i 6.1×10^{-2}

l 4.9×10^{-4}

o 3.72×10^{-4}

b 9×10^8

e 1.25×10^8

h 2.5×10^{-4}

b 8×10^{11}

e 5.6×10^5

h 9×10^3

k 1.5×10^{-5}

c 6.25×10^{-4}

f 4×10^6

c 2×10^4

f 1.2×10^8

i 9×10^{-9}

l 1

6G

Building understanding

- 1 a 57 260, 57 300, 57 000, 60 000
 b 0.003661, 0.00366, 0.0037, 0.004
- 2 a yes b no c no d no e yes
 f yes g yes h no i no

Now you try

Example 19
 a 4 b 3 c 3

Example 20
 a 4.9×10^5 b 6.5×10^{-2}

Example 21
 a 7.71×10^9 b 6.94×10^{-2}

Exercise 6G

- 1 a i 4 ii 2
 b i 2 ii 3
 c i 2 ii 4
- 2 a 3 b 4 c 5 d 2
 e 3 f 1 g 3 h 3
 i 3 j 4 k 3 l 2
- 3 a 2.42×10^5 b 1.71×10^5 c 2.83×10^3
 d 3.25×10^6 e 3.43×10^{-4} f 6.86×10^{-3}
 g 1.46×10^{-2} h 1.03×10^{-3} i 2.34×10^1
 j 3.26×10^2 k 1.96×10^1 l 1.72×10^{-1}
- 4 a 4.78×10^4 b 2.2×10^4 c 4.833×10^6
 d 3.7×10^1 e 9.95×10^1 f 1.443×10^{-2}
 g 2×10^{-3} h 9×10^{-2} i 1×10^{-4}
- 5 a 2.441×10^{-4} b 2.107×10^{-6} c -4.824×10^{15}
 d 4.550×10^{-5} e 1.917×10^{12} f 1.995×10^8
 g 3.843×10^2 h 1.710×10^{-11} i 1.524×10^8
 j 3.325×10^{15} k 4.000×10^3 l -8.959×10^3
- 6 a 9.3574×10^1 b 2.1893×10^5 c 8.6000×10^5
 d 8.6288×10^{-2} e 2.2985×10^{15} f 3.5741×10^{28}
 g 6.4000×10^7 h 1.2333×10^9 i 1.8293
 j 5.4459×10^{-1}
- 7 1.98×10^{30} kg
- 8 1.39×10^6 km
- 9 1.09×10^{12} km³
- 10 0.02×10^8 , 0.239×10^7 , 2.41×10^6 , 24.2×10^5 , 2421×10^3
- 11 a 4.26×10^6 b 9.1×10^{-3}
 c 5.04×10^{11} d 1.931×10^{-1}
 e 2.1×10^6 f 6.14×10^{-11}
- 12 should be 8.8×10^{10}
- 13 a i 2.30×10^2 ii 4.90×10^{-2} iii 4.00×10^6
 b It is zero
 c It clarifies the precision of the number
- 14 a 5.40046×10^{12}
 b i 4.32×10^{13} ii 1.61×10^{19} iii 4.01×10^{51}

6H

Building understanding

- 1 a 4, 2 b 8, 2 c 9, 3
 d 27, 3 e 16, 4 f 64, 4
- 2 a true b false c true d true
 e false f false g false
- 3 a 2.6458 b 3.6056 c 9.1104

Now you try

Example 22
 a $\sqrt{7}$ b $\sqrt[6]{3}$

Example 23
 a 8 b 6

Example 24
 a x^3 b $a^{\frac{1}{6}}$ c b^2

Exercise 6H

- 1 a $\sqrt{3}$ b $\sqrt{7}$ c $\sqrt[3]{5}$ d $\sqrt[3]{12}$
 e $\sqrt[5]{31}$ f $\sqrt[7]{18}$ g $\sqrt[9]{9}$ h $\sqrt[8]{3}$
- 2 a $8^{\frac{1}{2}}$ b $19^{\frac{1}{2}}$ c $10^{\frac{1}{3}}$ d $31^{\frac{1}{3}}$
 e $5^{\frac{1}{4}}$ f $9^{\frac{1}{5}}$ g $11^{\frac{1}{8}}$ h $20^{\frac{1}{11}}$
- 3 a 5 b 7 c 9 d 13
 e 2 f 4 g 5 h 10
 i 2 j 3 k 5 l 2
- 4 a a b $a^{\frac{2}{3}}$ c a^2 d $a^{\frac{5}{2}}$
 e $x^{\frac{1}{3}}$ f x g $x^{\frac{5}{6}}$ h x
 i y j y^2 k $y^{\frac{3}{2}}$ l $x^{\frac{1}{4}}$
 m $x^{\frac{8}{3}}$ n $a^{\frac{2}{15}}$ o $a^{\frac{3}{8}}$ p $n^{\frac{4}{3}}$
- 5 a $a^{\frac{4}{3}}$ b $a^{\frac{7}{10}}$ c $a^{\frac{23}{21}}$
 d $a^{\frac{8}{3}}$ e $b^{\frac{1}{6}}$ f $x^{\frac{2}{15}}$
- 6 a $\frac{1}{2}$ b $\frac{1}{2}$ c $\frac{1}{2}$ d $\frac{1}{3}$
 e $\frac{1}{5}$ f $\frac{1}{3}$ g $\frac{1}{10}$ h $\frac{1}{4}$
- 7 a $\sqrt{29}$ b $\sqrt{13}$ c $\sqrt{65}$
 d $\sqrt{125}$ e $\sqrt{10}$ f $\sqrt{1700}$
- 8 a 9 b 16 c 27 d 125
 e 32 f 32 g 729 h 3125
- 9 a $a^{\frac{1}{2} + (-\frac{1}{2})} = a^0 = 1$
 b $a^{\frac{2}{3} + (-\frac{2}{3})} = a^0 = 1$

c $a^{\frac{4}{7}-\frac{4}{7}} = a^0 = 1$

d $a^{\frac{5}{6}-\frac{5}{6}} = a^0 = 1$

e $a^{\frac{1}{4}} \times a^{-\frac{1}{4}} = a^{\frac{1}{4} + (-\frac{1}{4})} = a^0 = 1$

f $a^2 \div a^2 = a^{2-2} = a^0 = 1$

10 Brackets needed for fractional power, $9^{\frac{1}{2}} = 3$

11 a i 3 ii 5 iii 10

b a

c $(a^2)^{\frac{1}{2}} = a^{2 \times \frac{1}{2}} = a$

d i 4 ii 9 iii 36

e a

f $(a^{\frac{1}{2}})^2 = a^{\frac{1}{2} \times 2} = a$

g i a ii a iii a iv a

12 a $\frac{4}{5}$ b $\frac{3}{7}$ c $\frac{2}{9}$ d $\frac{2}{3}$

e $\frac{4}{5}$ f $\frac{2}{3}$ g $\frac{4}{5}$ h $\frac{10}{7}$

13 a $\frac{2}{3}$ b $\frac{12}{7}$ c $\frac{5}{2}$ d $\frac{5}{6}$

6I

Building understanding

1 a like b like c unlike d unlike

e unlike f like g like h unlike

2 a both = 3.162 b both = 1.732

Now you try

Example 25

a $8\sqrt{3}$ b $-3\sqrt{7}$

Example 26

a $\sqrt{15}$ b $\sqrt{6}$

Exercise 6I

1 a $8\sqrt{7}$ b $8\sqrt{11}$ c $9\sqrt{5}$

d $4\sqrt{6}$ e $7\sqrt{3} + 2\sqrt{5}$ f $9\sqrt{7} + 3\sqrt{5}$

g $-5\sqrt{5}$ h $-4\sqrt{7}$ i $5\sqrt{7}$

j $-\sqrt{14}$ k $7\sqrt{2} - \sqrt{5}$ l $3\sqrt{3} + 2\sqrt{7}$

2 a $\sqrt{30}$ b $\sqrt{21}$ c $\sqrt{70}$

d 4 e 6 f $\sqrt{22}$

g 3 h 12 i $\sqrt{3}$

j $\sqrt{10}$ k $\sqrt{7}$ l $\sqrt{3}$

m 3 n 4 o $\sqrt{7}$

3 a $8 - 3\sqrt{3}$ b $6\sqrt{2} - \sqrt{3}$ c $7\sqrt{5} + 1$

d $\frac{5\sqrt{2}}{6}$ e $\frac{7\sqrt{7}}{10}$ f $-\frac{3\sqrt{6}}{14}$

g $\frac{2\sqrt{10}}{3}$ h $5 + \frac{\sqrt{3}}{3}$ i $-\frac{19\sqrt{8}}{56}$

4 a $15\sqrt{6}$ b $6\sqrt{21}$ c $8\sqrt{30}$

d $10\sqrt{18}$ e $2\sqrt{3}$ f $3\sqrt{6}$

g $4\sqrt{14}$ h $\frac{\sqrt{2}}{2}$

5 a $6\sqrt{15} + 2\sqrt{3}$ b $\sqrt{10} + \sqrt{15}$

c $5\sqrt{12} + 15\sqrt{30}$ d $14\sqrt{30} - 70$

e $13 - 2\sqrt{39}$ f $\sqrt{35} - 10$

6 a $2\sqrt{2}$ b $2\sqrt{3}$ c $3\sqrt{3}$ d $3\sqrt{5}$

e $5\sqrt{3}$ f $10\sqrt{2}$ g $2\sqrt{15}$ h $6\sqrt{2}$

7 a $5\sqrt{2}$ b $\sqrt{2}$ c $4\sqrt{2}$ d $\sqrt{3}$

e $6\sqrt{2}$ f $5\sqrt{3}$ g $2\sqrt{5}$ h $4\sqrt{3}$

8 a $2 + \sqrt{10} + \sqrt{6} + \sqrt{15}$

b $3 + \sqrt{6} - \sqrt{15} - \sqrt{10}$

c $6\sqrt{10} + 8\sqrt{5} - 3\sqrt{2} - 4$

d $2 + 3\sqrt{2} - 6\sqrt{7} - 9\sqrt{14}$

e 1

f 4

g 15

h 123

i $3 + 2\sqrt{2}$

j $15 - 6\sqrt{6}$

k $13 - 4\sqrt{3}$

l $22 + 4\sqrt{10}$

Problems and challenges

1 a 4 b 1 c 6

2 a 6

b 30

3 $\frac{9}{4}$

4 a $2t^2$

b $\frac{2}{t}$

5 100 minutes

6 $-\frac{2}{3}$

7 a i 2^4 ii 2^7 iii 2^{15}

b 2

8 2^7

9 a $7\sqrt{2}$ b $\frac{3}{\sqrt{2}}$ or $\frac{3\sqrt{2}}{2}$ c $12\sqrt{10}$

10 a-c Answers may vary.

b $x = 1$ or 2

11 a $x = 0$ or 1

12 $x = 2^2 \times 3 \times 5^2 = 300$

13 $x = -1, y = \frac{1}{2}$

Success criteria example questions

1 $ab \times ab \times ab$

2 $(-4) \times (-4) \times (-4) = -64$

3 $6x^3y^2$

4 $2^2 \times 3^3$

5 $5^7; 3^3$

6 $12a^6b^4$

7 $\frac{3x^5y}{2}$

8 $4a^2b$

9 m^{30}

- 2 a $a = 63$ b $a = 71$ c $a = 38$
 d $a = 147$ e $a = 233$ f $a = 33$
- 3 a obtuse isosceles, $a = 40$
 b acute scalene, $b = 30$
 c right-angled scalene, $c = 90$
 d equilateral, $d = 60$
 e obtuse isosceles, $e = 100$
 f right-angled isosceles, $f = 45$
 g obtuse scalene, $g = 100$
 h equilateral, $h = 60$
 i acute scalene, $i = 70$
- 4 a $s = 120$ b $t = 20$
 c $r = 70$ d $a = 60, x = 120$
 e $a = 100, b = 140$ f $c = 115, d = 65$
- 5 a 360° b 90° c 60° d 90°
 e 432° f 6° g 720° h 8640°
- 6 a $x = 56$ b $x = 155$
- 7 a 90° b 150° c 15°
 d 165° e 157.5° f 80°
 g 177.5° h 171° i 121.5°
- 8 $\angle AOB + \angle ABO = 120^\circ$ (exterior angle of triangle)
 $\angle AOB = 30^\circ$
 (reflex) $x = 330$
- 9 $AO = BO$ (radii)
 $\triangle AOB$ is isosceles, 2 sides equal, $\angle AOB = 116^\circ$
 $\therefore \angle OAB = 32^\circ$, base angles of isosceles triangle
- 10 a 160°
 b 165°
 c $\angle WYZ + a^\circ + b^\circ = 180^\circ$ angle sum of a triangle
 $\angle XYZ + \angle WYZ = 180^\circ$ straight line
 $\therefore \angle XYZ = a^\circ + b^\circ$
- 11 Let the interior angles of any triangle be a°, b° and c° .
 Now $a + b + c = 180$
 The exterior angles become $180^\circ - a^\circ, 180^\circ - b^\circ, 180^\circ - c^\circ$
 (straight line)
 Exterior sum $= (180 - a)^\circ + (180 - b)^\circ + (180 - c)^\circ$
 $= 540^\circ - a^\circ - b^\circ - c^\circ$
 $= 540^\circ - (a + b + c)^\circ$
 $= 540^\circ - 180^\circ$
 $= 360^\circ$
- 12 a $4x = 90, x = 22.5$
 b $3x = 180, x = 60$
 c $10x = 360, x = 36$
 d $2(x + 15) + x = 180, x = 50$
 e $2x + 20 = 140, x = 60$
 f $6x + 90 = 360, x = 45$

7B

Building understanding

- 1 a equal
 b equal
 c supplementary
- 2 a 125, alternate angles in \parallel lines
 b 110, cointerior angles in \parallel lines
 c 80, corresponding angles in \parallel lines
- d 96, vertically opposite
 e 54, supplementary angles
 f 116, cointerior angles in \parallel lines
- Now you try**
- Example 4
 a No, cointerior angles are not supplementary.
 b Yes, corresponding angles are equal.
 c Yes, alternate angles are equal.
- Example 5
 a $a = 75$ (cointerior angles in parallel lines),
 $b = 105$ (vertically opposite angles)
 b $a = 38$ (supplementary angles),
 $b = 142$ (corresponding angles in parallel lines)
- Example 6
 115°
- Exercise 7B**
- 1 a Yes, alternate angles are equal.
 b Yes, cointerior angles add to 180° .
 c Yes, corresponding angles are equal.
 d No, corresponding angles are not equal.
 e No, alternate angles are not equal.
 f No, cointerior angles do not add to 180° .
- 2 a $a = 110, b = 70$
 b $c = 95, d = 95$
 c $e = 100, f = 100, g = 100$
 d $a = 60, b = 120$
 e $a = 100, b = 80, c = 80$
 f $e = 140, f = 140, d = 140$
- 3 a $x = 70, y = 40$ b $t = 58, z = 122$
 c $u = 110, v = 50, w = 50$ d $x = 118$
 e $x = 295$ f $x = 79$
- 4 a 105° b 105° c 56°
 d 105° e 90° f 85°
- 5 a 56 b 120 c 50
- 6 a $180^\circ - a^\circ$ b $180^\circ - a^\circ$
 c $180^\circ - (a^\circ + b^\circ)$ d $180^\circ - (a^\circ + b^\circ)$
 e $a^\circ + c^\circ$ f $180^\circ - 2c^\circ$
- 7 $\angle ABC = 100^\circ, \angle BCD = 80^\circ, \angle ABC + \angle BCD = 180^\circ$
 $\therefore AB \parallel DC$ as cointerior angles are supplementary.
- 8 a cointerior angles on parallel lines add to 180°
 b alternate angles are equal, on parallel lines
 c $\triangle ABC = \triangleright a + b + c = 180$ and these are the three angles of the triangle
- 9 a $\angle BAE = 180^\circ - a^\circ$ (alternate angles and $AB \parallel DE$)
 $\angle ABC = 180^\circ - c^\circ - (180 - a)^\circ$ (angle sum of a triangle)
 $= 180^\circ - c^\circ - 180^\circ + a^\circ$
 $= -c^\circ + a^\circ$
 $= a^\circ - c^\circ$
 b $\angle ABD = 180^\circ - (a^\circ + b^\circ)$ (angle sum of triangle $\triangle ABD$)
 $\angle ABC + \angle ABD = 180^\circ$ (straight line)
 $\therefore \angle ABC = a^\circ + b^\circ$

- c construct XY through B parallel to AE
 $\therefore \angle ABY = a^\circ$ (alternate angles, $AE \parallel XY$)
 $\therefore \angle CBY = b^\circ$ (alternate angles, $DC \parallel XY$)
 $\therefore \angle ABC = a^\circ + b^\circ$
- d construct XY through A parallel to ED
 $\angle XAD = 180^\circ - b^\circ$ (cointerior angles, $ED \parallel XY$)
 $\angle DAB = 360^\circ - a^\circ$ (revolution)
 $\therefore \angle XAB = 360^\circ - a^\circ - (180^\circ - b^\circ)$
 $= 180^\circ + b^\circ - a^\circ$
 $\angle ABC = \angle XAB$ (alternate angles and $XY \parallel BC$)
 $\therefore \angle ABC = 180^\circ + b^\circ - a^\circ$

7C

Building understanding

- 1 a 5 b 7 c 4 d 11 e 9 f 12
 2 a 720° b 1080° c 1620°
 3 a parallel b right
 c trapezium d equal
 4 a convex quadrilateral b non-convex hexagon
 c non-convex heptagon

Now you try

- Example 7
 a 60 b 80 c 109
- Example 8
 a $a = 215$ b $a = 120, b = 60$

Exercise 7C

- 1 a 115 b 149 c 30
 d 121 e 140 f 220
- 2 a 110 b 70 c 54
 d 33 e 63 f 109
- 3 a 110 b 150 c 230 d 20
 e $b = 108, a = 72$
 f $b = 140, a = 40$
 g $b = 120, a = 240$
 h $b = 128\frac{4}{7}, a = 231\frac{3}{7}$
 i 108
- 4 a parallelogram, rectangle, kite
 b rectangle, square
 c square, rectangle
 d square, rhombus, kite
- 5 a 16 b 25 c 102
- 6 a 255 b 86 c 115
 d 37 e 28 f 111
- 7 A parallelogram has opposite sides parallel and equal.
 Rectangles, squares and rhombi have these properties (and more) and are therefore all parallelograms.
- 8 a $S = (n - 2) \times 180^\circ$ b $I = \frac{(n - 2) \times 180^\circ}{n}$
 c $E = \frac{360}{n}$ d 36°
- 9 a i one ii two iii five
 b $(n - 3)$

- 10 $(180 - a) + (180 - b) + (180 - c) + (180 - d) + (180 - e) = 360$
 (sum of exterior angles is 360°)
 $180 + 180 + 180 + 180 + 180 - (a + b + c + d + e) = 360$
 $900 - (a + b + c + d + e) = 360$
 $a + b + c + d + e = 540$
- a $a + b + c + d + e + f = 720$
 b $a + b + c + d + e + f + g = 900$

7D

Building understanding

- 1 a size
 b $\triangle ABC \equiv \triangle STU$
 c SAS, RHS, AAS
- 2 a i XY ii XZ iii YZ
 b $\angle A$ ii $\angle B$ iii $\angle C$
- 3 a $\triangle ABC \equiv \triangle FGH$ b $\triangle DEF \equiv \triangle STU$

Now you try

- Example 9
 a SSS b AAS c RHS
 d SAS e SAS f AAS
- Example 10
 a $x = 4, y = 8$ b $a = 75, b = 15$

Exercise 7D

- 1 a SAS b AAS c RHS d SSS
 e SAS f RHS g SSS
- 2 a $x = 3, y = 4$ b $x = 2, y = 6$
 c $a = 105, b = 40$ d $a = 65, b = 85$
 e $x = 2.5, b = 29$ f $a = 142, x = 9.21, b = 7$
 g $y = 4.2, a = 28$ h $a = 6.5, b = 60$
- 3 a $\triangle ABC \equiv \triangle GHI$ (RHS) b $\triangle DEF \equiv \triangle GHI$ (SSS)
 c $\triangle ABC \equiv \triangle DEF$ (SAS) d $\triangle ABC \equiv \triangle GHI$ (AAS)
 e $\triangle ACB \equiv \triangle DEF$ (SAS)
- 4 $\triangle DEF \equiv \triangle BRP$
 $\triangle LMN \equiv \triangle KIJ$
 $\triangle BCD \equiv \triangle FGH$
 $\triangle MNO \equiv \triangle RQP$
- 5 a $BC = 13$ b $BC = 85$
- 6 No, they can all be different sizes, one might have all sides 2 cm and another all sides 5 cm.
- 7 a one given, the other pair are vertically opposite
 b AAS
- 8 a SSS b equal
- 9 a one given ($BA = BC$) and side BD is common
 b SAS
 c $\triangle ABD \equiv \triangle CBD$
 d $\angle ADB = \angle CDB$ (corresponding angles in congruent triangles)
 but $\angle ADB + \angle CDB = 180^\circ$ (straight angle)
 $\therefore \angle ADB = \angle CDB = 90^\circ$
 and AC is perpendicular to DB
- 10 a-e Answers may vary.

7E

Building understanding

- 1 a BD b AC c AC
 2 $OA = OB$ radii of circle centre O
 3 a $\angle ECD$ b $\angle CBA$ c $\angle DEC$
 4 a SSS b $\angle BMC$

Now you try

Example 11

In $\triangle ABC$ and $\triangle EDC$: $\angle ACB = \angle ECD$ (vertically opposite) (A) $\angle ABC = \angle EDC$ (alternate angles in parallel lines) (A) $BC = DC$ (given) (S) $\therefore \triangle ABC \equiv \triangle EDC$ (AAS)

Example 12

a In $\triangle ABC$ and $\triangle ADC$: $AB = AD$ (given) (S) $BC = DC$ (given) (S) AC is common (S) $\therefore \triangle ABC \equiv \triangle ADC$ (SSS)b Since $\triangle ABC \equiv \triangle ADC$ then $\angle ABC = \angle ADC$.

Exercise 7E

- 1 a $AD = CD$ (given)
 $\angle DAB = \angle DCB = 90^\circ$ (given)
 DB is common
 $\therefore \triangle ABD \equiv \triangle CBD$ (RHS)
- b AC is common
 $AD = AB$ (given)
 $\angle DAC = \angle BAC$ (given)
 $\therefore \triangle ADC \equiv \triangle ABC$ (SAS)
- c AC is common
 $\angle ADC = \angle ABC$ (given)
 $\angle DAC = \angle BAC$ (given)
 $\therefore \triangle ADC \equiv \triangle ABC$ (AAS)
- d AC is common
 $AD = AB$ (given)
 $DC = BC$ (given)
 $\therefore \triangle ADC \equiv \triangle ABC$ (SSS)
- e $AC = DC$ (given)
 $BC = EC$ (given)
 $\angle ACB \equiv \angle DCE$ (vertically opposite)
 $\therefore \triangle ABC \equiv \triangle DEC$ (SAS)
- f $AC = EC$ (given)
 $\angle CAB = \angle CED$ (alternate angles, $AB \parallel DE$)
 $\angle ACB = \angle ECD$ (vertically opposite)
 (or $\angle CBA = \angle CDE$ (alternate angles, $AB \parallel DE$))
 $\therefore \triangle ABC \equiv \triangle DEC$ (AAS)
- g $DC = BC$ (given)
 $\angle EDC = \angle ABC$ (alternate angles, $DE \parallel AB$)
 $\angle DCE = \angle BCA$ (vertically opposite)
 (or $\angle DEC = \angle BAC$ (alternate angles, $AB \parallel DE$))
 $\therefore \triangle CDE \equiv \triangle CBA$ (AAS)
- h BD is common
 $AD = CD$ (given)
 $\angle ADB = \angle CDB$ (given)
 $\therefore \triangle ABD \equiv \triangle CBD$ (SAS)
- i AC is common
 $AB = CD$ (given)
 $BC = DA$ (given)
 $\therefore \triangle ABC \equiv \triangle CDA$ (SSS)
- j BD is common
 $\angle ABD = \angle CDB$ (alternate angles, $AB \parallel CD$)
 $\angle ADB = \angle CBD$ (alternate angles, $AD \parallel CB$)
 $\therefore \triangle ABD \equiv \triangle CDB$ (AAS)
- k $OA = OC$ (radii)
 OB is common
 $AB = CB$ (given)
 $\therefore \triangle AOB \equiv \triangle COB$ (SSS)
- l $OA = OD$ and $OB = OC$ (radii)
 $\angle AOB = \angle COD$ (vertically opposite)
 $\triangle AOB \equiv \triangle COD$ (SAS)
- 2 a $DC = BC$ (given)
 $EC = AC$ (given)
 $\angle DCE = \angle BCA$ (vertically opposite)
 $\therefore \triangle ABC \equiv \triangle EDC$ (SAS)
- b $\angle EDC = \angle ABC$ (corresponding angles in congruent triangles)
 $\therefore AB \parallel DE$ (alternate angles are equal)
- 3 a $AE = CD$ (given)
 $BE = BD$ (given)
 $\angle ABE = \angle CBD$ (vertically opposite with $\angle ABE$ given 90°)
 $\therefore \triangle ABE \equiv \triangle CBD$ (RHS)
- b $\angle EAB = \angle DCB$ (corresponding angles in congruent triangles)
 $\therefore AE \parallel CD$ (alternate angles equal)
- 4 a DB is common
 $AB = CD$ (given)
 $AD = CB$ (given)
 $\therefore \triangle ABD \equiv \triangle CDB$ (SSS)
- b $\angle ADB = \angle CBD$ (corresponding angles in congruent triangles)
 $\therefore AD \parallel BC$ (alternate angles equal)
- 5 a $OB = OC$ (radii)
 $OA = OD$ (radii)
 $\angle AOB = \angle DOC$ (vertically opposite)
 $\therefore \triangle AOB \equiv \triangle DOC$ (SAS)
- b $\angle ABO = \angle DCO$ (corresponding angles in congruent triangles)
 $\therefore AB \parallel CD$ (alternate angles equal)
- 6 a BD is common
 $AD = CD$ (given)
 $\angle ADB = \angle CDB$ (given)
 $\therefore \triangle ABD \equiv \triangle CBD$ (SAS)
- b $\angle ABD = \angle CBD$ (corresponding angles in congruent triangles)
 and $\angle ABD + \angle CBD = 180^\circ$ (straight line)
 $\therefore \angle ABD = \angle CBD = 90^\circ$ and AC is perpendicular to BD

- 7 a DB is common
 $\angle ABD = \angle CBD$ (given 90°)
 $\angle ADB = \angle CDB$ (given)
 $\therefore \triangle ABD \equiv \triangle CBD$ (AAS)
 b $AD = CD$ (corresponding side in congruent triangles)
 $\therefore \triangle ACD$ is isosceles (2 equal sides)

- 8 Consider $\triangle ADC$ and $\triangle CBA$
 AC is common
 $\angle DAC = \angle BCA$ (alternate angles, $AD \parallel BC$)
 $\angle DCA = \angle BAC$ (alternate angles, $DC \parallel AB$)
 $\therefore \triangle ADC \equiv \triangle CBA$ (AAS)
 So $AD = BC$, $AB = DC$ are equal corresponding sides in congruent triangles.

- 9 Consider $\triangle OAD$ and $\triangle OBD$
 OD is common
 $OA = OB$ (radii)
 $AD = BD$ (given)
 $\therefore \triangle OAD \equiv \triangle OBD$ (SSS)
 $\angle ODA = \angle ODB = 90^\circ$ (corresponding angles in congruent triangles are equal and supplementary to a straight line)
 $\therefore OC \perp AB$

- 10 $AB = DC$ (opposite sides of parallelogram)
 $\angle AEB = \angle CED$ (vertically opposite)
 $\angle BAE = \angle DCE$ (alternate angles $DC \parallel AB$)
 $\therefore \triangle ABE \equiv \triangle CDE$ (AAS)
 So $AE = CE$ and $BE = DE$, corresponding sides in congruent triangles

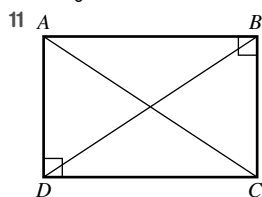

- 11 Consider $\triangle ADC$ and $\triangle BCD$
 $AD = CB$ and DC is common (opposite sides of a rectangle are equal)
 $\angle ADC = \angle BCD = 90^\circ$ (angles of a rectangle)
 $\therefore \triangle ADC \equiv \triangle BCD$ (SAS)
 So $AC = BD$ (corresponding sides in congruent triangles)
 \therefore The diagonals of a rectangle are equal

- 12 a Consider $\triangle ABE$ and $\triangle CDE$
 $AB = CD$ (sides of a rhombus)
 $\angle ABE = \angle CDE$ (alternate angles, $AB \parallel CD$)
 $\angle BAE = \angle DCE$ (alternate angles, $AB \parallel CD$)
 $\therefore \triangle ABE \equiv \triangle CDE$ (AAS)
 b Consider $\triangle DCE$ and $\triangle BCE$
 CE is common
 $DC = BC$ (sides of a rhombus)
 $DE = BE$ (corresponding sides in congruent triangles)
 $\therefore \triangle DCE \equiv \triangle BCE$ (SSS)
 $\angle DEC = \angle BEC$ (corresponding angles in congruent triangles)
 $\angle DEC + \angle BEC = 180^\circ$ (straight line)
 $\therefore \angle DEC = \angle BEC = 90^\circ$
 and $AE = CE$ (corresponding sides in congruent triangles)
 $\therefore AC$ bisects BD at 90°

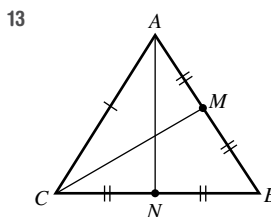

Let $\triangle ABC$ be any equilateral triangle $AB = CB = AC$.

- Step one**
 Join C to M , the midpoint of AB .
 Prove $\triangle CAM \equiv \triangle CBM$ (SSS).
 $\therefore \angle CAM = \angle CBM$ (corresponding angles in congruent triangles)

- Step two**
 Join A to N , the midpoint of CB .
 Prove $\triangle ANC \equiv \triangle ANB$.
 $\therefore \angle ACN = \angle ABN$ (corresponding angles in congruent triangles)
 Now $\angle CAB = \angle ABC = \angle ACB$
 and as $\angle CAB + \angle ABC + \angle ACB = 180^\circ$
 (angle sum of $\triangle ABC$)
 $\angle CAB = \angle ABC = \angle ACB = 60^\circ$

Progress quiz

- 1 a 37° b 127°
 2 a 60 b 56 c 50
 d 142 e 50 f 84
 3 a yes, as there is a pair of equal alternate angles
 b no, as the pair of cointerior angles are not supplementary
 4 a $\alpha = 68$ (alternate angles equal in parallel lines)
 b $\beta = 68$ (corresponding angles equal in parallel lines)
 b $w = 98$ (alternate angles equal in parallel lines)
 5 a $x = 92$ (angle sum of a quadrilateral)
 b $y = 110$ (kite, angle sum of quadrilateral)
 c $\alpha = 125$ (angle sum of a pentagon)
 d $x = 60$ (exterior angle of a regular hexagon)
 6 a AAS
 b SAS
 7 AC is common
 $DC = BC$ (given)
 $\angle ACD = \angle ACB$ (given 90°)
 $\therefore \triangle ABC \equiv \triangle ADC$ (SAS)
 $AB = AD$ (corresponding sides in congruent triangles)
 $\therefore \triangle ABD$ is isosceles
 8 a $AE = DC$ (given)
 $\angle ABE = \angle DBC$ (vertically opposite angles)
 $\angle EAB = \angle CDB$ (alternate angles, $AE \parallel CD$)
 $\therefore \triangle ABE \equiv \triangle DBC$ (AAS)
 b 62° c 7 cm d 21 cm²

7F

Building understanding

- 1 a $\angle F$ b $\angle D$ c GH d AE e 2

- 2 a double b double c double
 d 2 e yes
- 3 a OA' is a quarter of OA b OD' is a quarter of OD
 c $\frac{1}{4}$ d yes
- 4 a yes b 8 cm c 25 m

Now you try

Example 13

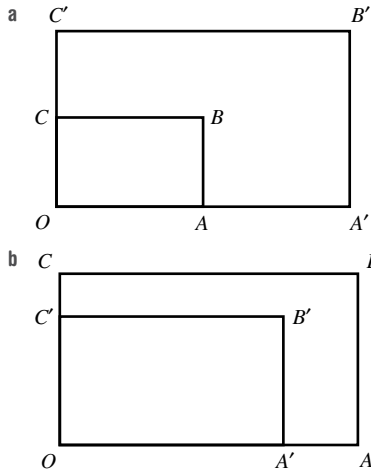

Example 14

- a 2 b 6 c 8

Exercise 7F

- 1 a $\Delta A'B'C'$ should have sides $\frac{1}{3}$ that of ΔABC
 b $\Delta A'B'C'$ should have sides double that of ΔABC
- 2 a $A'B'C'D'$ should have sides lengths $\frac{1}{2}$ that of $ABCD$
 b $A'B'C'D'$ should have side lengths 1.5 times that of $ABCD$
- 3 a i 2 ii 14 iii 10
 b i 1.5 ii 9 iii 8
 c i 1.5 ii 45 iii 24
 d i 0.4 ii 1 iii 1.4
 e i 2.5 ii 0.6 iii 2
 f i 1.75 ii 3.5 iii 3
- 4 a i 2 ii (0, 0)
 b i 0.5 ii (0, 0)
 c i 0.5 ii (3, 0)
 d i 3 ii (1, 0)
- 5 a i 3.6 m ii 9 m iii 2.7 m
 b i 5.4 m ii 6.3 m
 c i 6 m ii 3 m
- 6 a 12.7 cm b 3 cm c 3 m
- 7 a $a > 1$ b $a < 1$ c $a = 1$
- 8 a all angles of any square equal 90° , with only 1 side length
 b all angles in any equilateral triangle equal 60° with only 1 side length
 c length and width might be multiplied by different numbers
 d Two isosceles triangles do not have to have the same base angles

- 9 $\frac{1}{k}$
- 10 a 100 000 cm = 1 km b 24 cm
- 11 a N/A
 b i $\frac{l}{2}$ ii $\frac{l}{4}$ iii $\frac{l}{128}$
 c i $\frac{3}{4}$ ii $\frac{9}{16}$ iii $\frac{243}{1024}$
 d zero

7G

Building understanding

- 1 a E b C c DF
 d BC e $\angle A$ f $\angle E$
- 2 2.5
- 3 a SAS, AAA, and RHS b shape, size

Now you try

Example 15

- a SAS b SSS c RHS d AAA

Example 16

- a AAA b 10.5

Exercise 7G

- 1 a AAA b RHS c SSS d SAS
 e RHS f AAA g SAS h SSS
- 2 a $\Delta ABC \equiv \Delta GHI$ b $\Delta ABC \equiv \Delta MNO$
 c $\Delta ABC \equiv \Delta ADE$ d $\Delta HFG \equiv \Delta HJI$
 e $\Delta ADC \equiv \Delta AEB$ f $\Delta ABD \equiv \Delta ECD$
- 3 a AAA b 12
- 4 a RHS b 8
- 5 a i 1.6 ii 14.4
 b i 3.5 ii 5
- 6 a AAA b 15
- 7 a i AAA ii 6.5
 b i AAA ii 10
 c i AAA ii 24
- 8 a 2 b 16 c 2.8
- 9 a ΔDEF b ΔDEF c ΔABC d ΔDEF
- 10 $\angle ACB = 25^\circ$, AAA
- 11 $\angle WXY = 55^\circ$, not similar as angles not equal
- 12 2 pairs of equal alternate angles are always formed
- 13 AAA, in congruency a side length is needed for the triangles to be the same size, in similarity it is not needed.

14 a

Triangle	Original	Image 1	2	3
Length scale factor	1	2	3	4
Area	4	16	36	64
Area scale factor	1	4	9	16
Volume	12	96	324	768
Volume scale factor	1	8	27	64

- b Area scale factor = (length scale factor)²
 c n^2
 d i 100 ii 400 iii 10 000
 e $\frac{1}{4}$
 f volume scale factor = (length scale factor)³
 g n^3
 h i 125 ii 1000 iii $\frac{1}{8}$

7H

Building understanding

- 1 $\angle C$
 2 a $\angle ACB$ and $\angle ECD$
 b $\angle BAC = \angle DEC$ and $\angle CBA = \angle CDE$
 3 a $\angle C$
 b i AC ii DB

Now you try

Example 17

- a $\angle ACE = \angle BCD$ (common)
 $\angle CAE = \angle CBD$ (corresponding angles in parallel lines)
 $\angle AEC = \angle BDC$ (corresponding angles in parallel lines)
 $\therefore \triangle ACE \parallel \triangle BCD$ (AAA)
 b $\angle CAD = \angle EAB$ (common)
 $\frac{AD}{BA} = \frac{9}{3} = 3$
 $\frac{AC}{AE} = \frac{7.5}{2.5} = 3$
 $\therefore \triangle ACD \parallel \triangle AEB$ (SAS)

Example 18

- a All angles are the same (AAA).
 b 8 m

Exercise 7H

- 1 a $\angle AEB = \angle CDB$ (alternate angles, $EA \parallel DC$)
 $\angle EAB = \angle DCB$ (alternate angles, $EA \parallel DC$)
 $\angle EBA = \angle DBC$ (vertically opposite)
 $\therefore \triangle AEB \parallel \triangle CDB$ (AAA)
 b $\angle BAC = \angle DEC$ (alternate angles, $AB \parallel DE$)
 $\angle ABC = \angle EDC$ (alternate angles, $AB \parallel DE$)
 $\angle ACB = \angle ECD$ (vertically opposite)
 $\therefore \triangle ACB \parallel \triangle ECD$ (AAA)
 c $\angle C$ is common
 $\angle CDB = \angle CEA$ (corresponding angles, $AE \parallel BD$)
 $\angle CBD = \angle CAE$ (corresponding angles, $AE \parallel BD$)
 $\therefore \triangle CBD \parallel \triangle CAE$ (AAA)
 d $\angle A$ is common
 $\angle ABE = \angle ADC$ (given)
 $\therefore \triangle ABE \parallel \triangle ADC$ (AA)
 (note 2 angles is enough – $\angle AEB = \angle ACD$ (angle sum of a triangle))
 2 a $\angle C$ is common
 $\frac{CA}{CD} = \frac{6}{2} = 3$
 $\frac{CE}{CB} = \frac{9}{3} = 3$
 $\therefore \triangle CDB \parallel \triangle CAE$ (SAS)

- b $\angle D$ is common
 $\frac{AD}{CD} = \frac{28}{7} = 4$
 $\frac{DB}{DE} = \frac{48}{12} = 4$
 $\therefore \triangle ABD \parallel \triangle CED$ (SAS)
 c $\angle DCE = \angle BCA$ (vertically opposite)
 $\frac{EC}{AC} = \frac{2}{5}$
 $\frac{DC}{BC} = \frac{3}{7.5} = \frac{2}{5}$
 $\therefore \triangle DCE \parallel \triangle BCA$ (SAS)
 3 a AAA b 40 m
 4 a AAA b 7.5 m
 5 6 m 6 20 m 7 7.2 m 8 $\frac{55}{6}$
 9 a $\angle ADC = \angle ACD = 80^\circ$ (base angles of isosceles $\triangle ADC$)
 $\angle ACB = 100^\circ$ (straight angle)
 $\angle CAB = 60^\circ$ (angle sum of $\triangle ACB$)
 Now $\angle DAB = 80^\circ$
 $\angle DAC = \angle DBA$ (given 20°)
 $\angle D$ is common
 $\angle ACD = \angle BAD$ (both 80°)
 $\therefore \triangle ACD \parallel \triangle BAD$ (AAA)
 b $DC = \frac{20}{3}$ $CB = \frac{25}{3}$
 10 a i $\angle B$ is common
 $\angle DAB = \angle ACB$ (given 90°)
 $\therefore \triangle ABD \parallel \triangle CBA$ (AAA)
 ii $\angle D$ is common
 $\angle DCA = \angle DAB$ (given 90°)
 $\therefore \triangle ABD \parallel \triangle CAD$ (AAA)
 b i $BD = \frac{25}{3}$ ii $AC = 4$ iii $AB = \frac{20}{3}$
 11 a $\angle ACB = \angle ECD$ (vertically opposite)
 $\angle CAB = \angle CED$ (alternate angles, $DE \parallel BA$)
 $\therefore \triangle ABC \parallel \triangle EDC$ (AAA)
 $\therefore \frac{DC}{BC} = \frac{EC}{AC}$ (ratio of corresponding sides in similar triangles)
 $\frac{6}{2} = \frac{EC}{AC}$
 $\therefore 3AC = CE$
 as $AC + CE = AE$
 $AE = 4AC$
 b $\angle C$ is common
 $\angle DBC = \angle AEC$ (given)
 $\therefore \triangle CBD \parallel \triangle CEA$ (AAA)
 $\therefore \frac{DB}{AE} = \frac{2}{4} = \frac{BC}{CE}$ (ratio of corresponding sides in similar triangles)
 $\therefore 4BC = 2CE$
 $BC = \frac{1}{2}CE$
 c $\angle C$ is common
 $\angle CBD = \angle CAE$ (corresponding angles, $BD \parallel AE$)
 $\therefore \triangle CBD \parallel \triangle CAE$ (AAA)
 $\therefore \frac{CB}{CA} = \frac{CD}{CE}$ (ratio of corresponding sides in similar triangles)
 $\therefore \frac{5}{7} = \frac{CD}{CE}$
 $\therefore 5CE = 7CD$
 $\therefore CE = \frac{7}{5}CD$

- d $\angle C$ is common
 $\angle CBD = \angle CAE$ (given 90°)
 $\therefore \triangle CBD \parallel \triangle CAE$ (AAA)
 $\therefore \frac{BD}{AE} = \frac{CB}{CA}$ (ratio of corresponding sides in similar triangles)
 $\frac{2}{8} = \frac{CB}{CA}$
 $\frac{1}{4} = \frac{CB}{CB + AB}$
 $CB + AB = 4CB$
 $\therefore AB = 3CB$

Problems and challenges

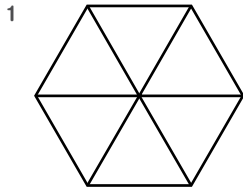

- 2 15
 3 40°
 4 A, B and C should be placed where the three altitudes of the triangle intersect the three sides.
 5 45°
 6 11
 7 $\frac{120}{7}$

Answers to success criteria example questions

- 1 $118^\circ; 28^\circ$
 2 Isosceles; $a = 55$
 3 $x = 120$
 4 No, alternate angles are not equal
 5 $a = 122$ (vertically opposite angles are equal); $b = 58$ (cointerior angles are supplementary)
 6 99°
 7 $x = 121$
 8 $540^\circ; y = 212$
 9 SAS
 10 $a = 88; b = 17$
 11 $AB = AD$ (given equal sides) (S)
 $\angle BAC = \angle DAC$ (given equal angles) (A)
 AC is common (S)
 $\therefore \triangle ABC \equiv \triangle ADC$ (SAS)
 12 $AC = EC$ (given equal sides) (S)
 $BC = DC$ (given equal sides) (S)
 $\angle ACB = \angle ECD$ (vertically opposite angles) (A)
 $\triangle ABC \equiv \triangle EDC$ (SAS)
 $\angle BAC = \angle DEC$ (matching angles in congruent triangles)
 $\therefore AB \parallel DE$ (alternate angles are equal)

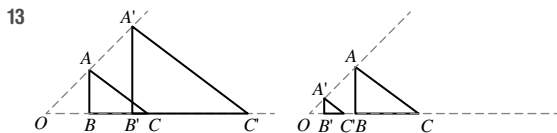

- 14 $x = 6; y = 8.8$
 15 RHS
 16 AA; $x = 10$
 17 $\frac{DC}{AC} = \frac{12}{4} = 3$
 $\angle ECD = \angle BCA$ (vertically opposite angles are equal)
 $\frac{EC}{BC} = \frac{15}{5} = 3 = \frac{DC}{AC}$
 $\therefore \triangle ACB \parallel \triangle DCE$ (SAS)
 18 All angles are the same (AAA); 30 m

Short-answer questions

- 1 a isosceles, $x = 50, y = 80$
 b right angled, $x = 25$
 c obtuse angled, $x = 30, y = 110$
 2 a $a = 30$ (vertically opposite) $b = 150$ (straight angle)
 b $x = 60$ (revolution) $y = 120$ (cointerior angles in parallel lines)
 c $a = 70$ (alternate angles and parallel lines)
 $b = 55$ (angle sum of isosceles triangle)
 $c = 55$ (corresponding angles and parallel lines)
 3 $\angle ABC = 75^\circ$
 4 a $a = 70, b = 110$ b $x = 15$
 c $x = 30$ d $a = 120$
 5 a SSS, $x = 60$ b not congruent
 c RHS, $x = 8$ d AAS, $x = 9$
 6 a AD is common
 $\angle ADC = \angle ADB$ (given 90°)
 $CD = BD$ (given)
 $\therefore \triangle ADC \equiv \triangle ADB$ (SAS)
 b i $AC = EC$ (given)
 $\angle BAC = \angle DEC$ (given)
 $\angle ACB = \angle ECD$ (vertically opposite)
 $\therefore \triangle ACB \equiv \triangle ECD$ (AAS)
 ii as $\angle BAC = \angle DEC$ (alternate angles are equal)
 $\therefore AB \parallel DE$
 7 For image $\triangle A'B'C'$, $OA' = 3OA, OB' = 3OB, OC' = 3OC$
 8 a yes, SAS b yes, AAA c not similar
 9 a 3.5 b 4 c 18
 10 a $\angle C$ is common
 $\angle DBC = \angle EAC = 90^\circ$ (given)
 $\therefore \triangle BCD \parallel \triangle ACE$ (AAA)
 b 5 m

Multiple-choice questions

- 1 D 2 A 3 B 4 D 5 C
 6 D 7 E 8 B 9 D 10 A

Extended-response questions

- 1 a $\angle ABC + \angle BCF = 180^\circ$ (cointerior angles, $AB \parallel CF$)
 $\therefore \angle BCF = 70^\circ$
 $\therefore \angle DCF = 32^\circ$
 Now $\angle EDC + \angle DCF = 32^\circ + 148^\circ$
 $= 180^\circ$
 $\therefore DE \parallel CF$ as cointerior angles add to 180°

- b $\angle CDA = 40^\circ$ (revolution)
 reflex $\angle BCD = 270^\circ$ (revolution)
 $\angle DAB = 30^\circ$ (angle sum in isosceles triangle)
 BADC quadrilateral angle sum 360°
 $\therefore a = 360 - (30 + 270 + 40)$
 $= 20$
 or other proof
- c $AB = CD$ (given)
 $\angle ABC = \angle DCB$ (given)
 BC is common
 $\therefore \triangle ABC \cong \triangle DCB$ (SAS)
 $\therefore AC = BD$ (corresponding sides in congruent triangles)
- 2 a $\angle ECD$
 b $\angle ABC = \angle EDC$ (given 90°)
 $\angle ACB = \angle ECD$ (vertically opposite)
 $\therefore \triangle ABC \cong \triangle EDC$ (AAA)
 c 19.8 m

Chapter 8

8A

Building understanding

- 1 a $x^2, 2x, 3x, 6$
 b $x^2 + 3x + 2x + 6 = x^2 + 5x + 6$
- 2 a $2x^2, 2x, 3x, 3$
 b $(2x + 3)(x + 1) = 2x^2 + 2x + 3x + 3$
 $= 2x^2 + 5x + 3$
- 3 a $x^2 + 5x + x + 5 = x^2 + 6x + 5$
 b $x^2 + 2x - 3x - 6 = x^2 - x - 6$
 c $21x^2 + 6x - 14x - 4 = 21x^2 - 8x - 4$
 d $12x^2 - 16x - 3x + 4 = 12x^2 - 19x + 4$

Now you try

Example 1

- a $x^2 + 6x + 8$
 b $x^2 + 2x - 15$
 c $2x^2 - 11x + 12$
 d $12x^2 - 11x - 15$

Exercise 8A

- | | |
|---------------------|--------------------|
| 1 a $x^2 + 7x + 10$ | b $b^2 + 7b + 12$ |
| c $t^2 + 15t + 56$ | d $a^2 + 8a + 7$ |
| e $y^2 + 12y + 20$ | f $m^2 + 16m + 48$ |
| g $x^2 - x - 12$ | h $x^2 - 4x - 32$ |
| i $x^2 - 4x - 12$ | j $x^2 + 9x - 10$ |
| k $x^2 - 3x + 2$ | l $x^2 - 9x + 20$ |
- 2 a $8x^2 + 26x + 15$
- | |
|----------------------|
| b $6x^2 + 7x + 2$ |
| c $15x^2 + 17x + 4$ |
| d $6x^2 + x - 15$ |
| e $24x^2 + 23x - 12$ |
| f $6x^2 - x - 2$ |
| g $10x^2 - 31x - 14$ |
| h $6x^2 + 5x - 6$ |
| i $16x^2 - 16x - 5$ |
| j $18x^2 - 27x + 10$ |
| k $15x^2 - 11x + 2$ |
| l $21x^2 - 37x + 12$ |

- | | |
|--------------------------|--------------------------|
| 3 a $a^2 + ac + ab + bc$ | b $a^2 + ac - ab - bc$ |
| c $yz - y^2 - xz + xy$ | d $2x^2 - 3xy - 2y^2$ |
| e $2a^2 - ab - b^2$ | f $6x^2 + xy - y^2$ |
| g $6a^2 + 4a - 3ab - 2b$ | h $12x^2 - 25xy + 12y^2$ |
| i $3x^2y - yz^2 - 2xyz$ | |
- 4 a $x^2 + 9x + 20$
- | | |
|----------------------|---------------------|
| b i 56 m^2 | ii 36 m^2 |
|----------------------|---------------------|
- 5 a $2x^2$
- | |
|----------------------|
| b $2x^2 - 30x + 100$ |
|----------------------|
- 6 a $150 - 50x + 4x^2$
- | |
|--------------------|
| b 66 m^2 |
|--------------------|
- 7 a 3
- | |
|----------------|
| b 2 |
| c 6, 6 |
| d 2, 18 |
| e 2, 6 |
| f 3, 15 |
| g $2x, 5x, 3$ |
| h $3x, 15x, 4$ |
| i $7x, 3, 17x$ |
| j $3x, 4, 11x$ |
- 8 a $a = 3, b = 2$ or $a = 2, b = 3$
 b $a = -3, b = -2$ or $a = -2, b = -3$
 c $a = 3, b = -2$ or $a = -2, b = 3$
 d $a = 2, b = -3$ or $a = -3, b = 2$
- 9 a $x^3 + 2x^2 + 2x + 1$
- | |
|-----------------------------|
| b $x^3 - 3x^2 + 5x - 6$ |
| c $4x^3 - 4x^2 + 9x - 4$ |
| d $x^3 + 2x^2 - 2x + 3$ |
| e $10x^3 - 17x^2 + 7x - 6$ |
| f $8x^3 - 18x^2 + 35x - 49$ |
| g $x^3 + ax - a^2x + a^2$ |
| h $x^3 - 2ax^2 + a^3$ |
| i $x^3 + a^3$ |
| j $x^3 - a^3$ |
- 10 $x^3 + 6x^2 + 11x + 6$

8B

Building understanding

- 1 a $+3x + 9 = x^2 + 6x + 9$
 b $+5x + 25 = x^2 + 10x + 25$
 c $-2x + 4 = x^2 - 4x + 4$
 d $-7x + 49 = x^2 - 14x + 49$
- 2 a i $x^2 + 6x + 9$
 ii $x^2 + 22x + 121$
 iii $x^2 + 30x + 225$
 b i $x^2 - 4x + 4$
 ii $x^2 - 18x + 81$
 iii $x^2 - 60x + 900$
- 3 a $+4x - 16 = x^2 - 16$
 b $-10x - 100 = x^2 - 100$
 c $+2x - 2x - 1 = 4x^2 - 1$
 d $-12x + 12x - 16 = 9x^2 - 16$

Now you try

Example 2

- a $x^2 - 6x + 9$
- | |
|---------------------|
| b $9x^2 + 24x + 16$ |
|---------------------|

Example 3

- a $x^2 - 16$
- | |
|------------------|
| b $25x^2 - 9y^2$ |
|------------------|

Exercise 8B

- | | |
|--------------------|--------------------|
| 1 a $x^2 + 2x + 1$ | b $x^2 + 6x + 9$ |
| c $x^2 + 4x + 4$ | d $x^2 + 10x + 25$ |
| e $x^2 + 8x + 16$ | f $x^2 + 18x + 81$ |
| g $x^2 - 4x + 4$ | h $x^2 - 12x + 36$ |

- i $x^2 - 2x + 1$
 k $x^2 - 18x + 81$
 2 a $4x^2 + 4x + 1$
 c $9x^2 + 12x + 4$
 e $25x^2 + 20x + 4$
 g $49 + 28x + 4x^2$
 i $4x^2 - 12x + 9$
 k $16x^2 - 40x + 25$
 m $9x^2 + 30xy + 25y^2$
 o $49x^2 + 42xy + 9y^2$
 q $16x^2 - 72xy + 81y^2$
 s $9x^2 - 60xy + 100y^2$
 u $81x^2 - 36xy + 4y^2$
 3 a $9 - 6x + x^2$
 c $1 - 2x + x^2$
 e $121 - 22x + x^2$
 g $4 - 12x + 9x^2$
 i $100 - 80x + 16x^2$
 4 a $x^2 - 1$
 c $x^2 - 64$
 e $x^2 - 144$
 g $x^2 - 81$
 i $x^2 - 36$
 k $4 - x^2$
 5 a $9x^2 - 4$
 c $16x^2 - 9$
 e $81x^2 - 25y^2$
 g $64x^2 - 4y^2$
 i $49x^2 - 25y^2$
 k $64x^2 - 9y^2$
 6 a i x^2
 b No, they differ by 4.
 7 a $20 - 2x$
 b $(20 - 2x)(20 - 2x) = 400 - 80x + 4x^2$
 c 196 cm^2
 d 588 cm^3
 8 a $a + b$
 b $(a + b)(a + b) = a^2 + 2ab + b^2$
 c $a - b$
 d $(a - b)(a - b) = a^2 - 2ab + b^2$
 e $4ab$
 f ab , so yes area of four courts is $4ab$
 9 a $x^2 - 1$
 b No, area of rectangle is 1 square unit less.
 10 a $a^2 - b^2$
 b i $(a - b)^2 = a^2 - 2ab + b^2$
 ii $b(a - b) = ab - b^2$
 iii $b(a - b) = ab - b^2$
 c yes, $a^2 - 2ab + b^2 + ab - b^2 + ab - b^2 = a^2 - b^2$
 11 a $x^2 + 4x$
 c $x^2 + 6x - 9$
 e 1
 g $-12x - 8$
 i $x^2 + 4xy - y^2$
 k $-8x$
 m $9x^2 - 48x + 48$
 j $x^2 - 6x + 9$
 l $x^2 - 14x + 49$
 b $4x^2 + 20x + 25$
 d $9x^2 + 6x + 1$
 f $16x^2 + 24x + 9$
 h $25 + 30x + 9x^2$
 j $9x^2 - 6x + 1$
 l $4x^2 - 36x + 81$
 n $4x^2 + 16xy + 16y^2$
 p $36x^2 + 60xy + 25y^2$
 r $4x^2 - 28xy + 49y^2$
 t $16x^2 - 48xy + 36y^2$
 b $25 - 10x + x^2$
 d $36 - 12x + x^2$
 f $64 - 32x + 4x^2$
 h $81 - 36x + 4x^2$
 b $x^2 - 9$
 d $x^2 - 16$
 f $x^2 - 121$
 h $x^2 - 25$
 j $25 - x^2$
 l $49 - x^2$
 b $25x^2 - 16$
 d $49x^2 - 9y^2$
 f $121x^2 - y^2$
 h $100x^2 - 81y^2$
 j $36x^2 - 121y^2$
 l $81x^2 - 16y^2$
 ii $x^2 - 4$

8C

Building understanding

- 1 a 4 b 6 c 25 d 8
 2 a x b $2a$ c $-3x$ d $-2x$
 3 a i 6 ii $3x$ iii $6x$
 b iii
 c terms have no common factor

Now you try

- Example 4
 a $2x$ b $5x$
 Example 5
 a $7(4 - 3a)$ b $-3x(3x + 5)$
 Example 6
 a $(a + b)(4 + a)$ b $(4x + 3)(1 - x)$

Exercise 8C

- 1 a i $5a$ ii $3b$
 b i $2x$ ii $5x$
 2 a $2x$ b $6a$ c 2 d 4
 e 3 f 1 g $3x$ h $3n$
 i $2y$ j $2x$ k $2xy$ l $5ab$
 3 a $7(x + 1)$ b $3(x + 1)$
 c $4(x - 1)$ d $5(x - 1)$
 e $4(1 + 2y)$ f $5(2 + a)$
 g $3(1 - 3b)$ h $2(3 - x)$
 i $3(4a + b)$ j $6(m + n)$
 k $2(5x - 4y)$ l $4(a - 5b)$
 m $x(x + 2)$ n $a(a - 4)$
 o $y(y - 7)$ p $x(1 - x)$
 q $3p(p + 1)$ r $8x(1 - x)$
 s $4b(b + 3)$ t $2y(3 - 5y)$
 u $3a(4 - 5a)$ v $9m(1 + 2m)$
 w $16x(y - 3x)$ x $7ab(1 - 4b)$
 4 a $-4(2x + 1)$ b $-2(2x + 1)$
 c $-5(2x + y)$ d $-7(a + 2b)$
 e $-3(3x + 4)$ f $-2(3y + 4)$
 g $-5(2x + 3y)$ h $-4(m + 5n)$
 i $-3x(x + 6)$ j $-4x(2x + 3)$
 k $-2y(8y + 3)$ l $-5a(a + 2)$
 m $-2x(3 + 10x)$ n $-3p(2 + 5p)$
 o $-8b(2 + b)$ p $-9x(1 + 3x)$
 5 a $(x + 3)(4 + x)$ b $(x + 1)(3 + x)$
 c $(m - 3)(7 + m)$ d $(x - 7)(x + 2)$
 e $(a + 4)(8 - a)$ f $(x + 1)(5 - x)$
 g $(y + 3)(y - 2)$ h $(x + 2)(a - x)$
 i $(2t + 5)(t + 3)$ j $(5m - 2)(m + 4)$
 k $(4y - 1)(y - 1)$ l $(7 - 3x)(1 + x)$
 6 a $6(a + 5)$ b $5(x - 3)$
 c $2(4b + 9)$ d $x(x - 4)$
 e $y(y + 9)$ f $a(a - 3)$
 g $xy(x - 4 + y)$ h $2ab(3 - 5a + 4b)$
 i $(m + 5)(m + 2)$ j $(x + 3)(x - 2)$

- k $(b - 2)(b + 1)$
 m $(3 - 2y)(y - 5)$
 o $(y + 1)(y - 3)$
- 7 a $4(x + 2)$
 d $2(x + 7)$
- 8 $4x$
- 9 a $t(5 - t)$
 b i 0 m
 c 5 seconds
- 10 a 63
 d -70
- 11 a $3(a^2 + 3a + 4)$
 c $x(x - 2y + xy)$
 e $-4y(3x + 2z + 5xz)$
- 12 a $-4(x - 3) = 4(3 - x)$
 b $-3(x - 3) = 3(3 - x)$
 c $-8(n - 1) = 8(1 - n)$
 d $-3(b - 1) = 3(1 - b)$
 e $-5m(1 - m) = 5m(m - 1)$
 f $-7x(1 - x) = 7x(x - 1)$
 g $-5x(1 - x) = 5x(x - 1)$
 h $-2y(2 - 11y) = 2y(11y - 2)$
- 13 a $(x - 4)(x - 3)$
 c $(x - 3)(x + 3)$
 e $(2x - 5)(3 - x)$
 g $(x - 3)(4 - x)$
 i $(x - 3)(x - 2)$
- l $(2x + 1)(x - 1)$
 n $(x + 4)(x + 9)$
- b $2(x + 3)$
 e $2(2x + 3)$
- c $10(x + 2)$
 f $2(x + 7)$
- ii 4 m
 iii 6 m
- b 72
 e 69
- b $z(5z - 10 + y)$
 d $2b(2y - 1 + 3b)$
 f $ab(3 + 4b + 6a)$

8D

Building understanding

- 1 a $x^2 - 4$
 2 a 3
 3 a $(x + 4)(x - 4)$
 b $x^2 - (12)^2 = (x + 12)(x - 12)$
 c $(4x)^2 - (1)^2 = (4x + 1)(4x - 1)$
 d $(3a)^2 - (2b)^2 = (3a + 2b)(3a - 2b)$
- b $x^2 - 49$
 c $9x^2 - y^2$
- b 11
 c 5b
 d 7y

Now you try

Example 7

- a $(x + 4)(x - 4)$
 c $(5a + b)(5a - b)$
- b $(2a + 3)(2a - 3)$

Example 8

- a $3(a + 3)(a - 3)$
 b $(x - 1)(x + 5)$

Exercise 8D

- 1 a $(x + 3)(x - 3)$
 c $(y + 1)(y - 1)$
 e $(x + 4)(x - 4)$
 g $(a + 9)(a - 9)$
 i $(a + b)(a - b)$
 k $(5 + x)(5 - x)$
 m $(6 + y)(6 - y)$
 o $(x + 20)(x - 20)$
- b $(y + 5)(y - 5)$
 d $(x + 8)(x - 8)$
 f $(b + 7)(b - 7)$
 h $(x + y)(x - y)$
 j $(4 + a)(4 - a)$
 l $(1 + b)(1 - b)$
 n $(11 + b)(11 - b)$
 p $(30 + y)(30 - y)$

- 2 a $(2x + 5)(2x - 5)$
 c $(5b + 2)(5b - 2)$
 e $(10y + 3)(10y - 3)$
 g $(1 + 2x)(1 - 2x)$
 i $(4 + 3y)(4 - 3y)$
 k $(2x + 5y)(2x - 5y)$
 m $(2p + 5q)(2p - 5q)$
 o $(5a + 7b)(5a - 7b)$
- 3 a $3(x + 6)(x - 6)$
 c $6(x + 2)(x - 2)$
 e $2(7 + x)(7 - x)$
 g $5(xy + 1)(xy - 1)$
 i $7(3 + ab)(3 - ab)$
- 4 a $(x + 8)(x + 2)$
 c $(x + 14)(x + 6)$
 e $(x - 6)(x - 8)$
 g $(10 + x)(4 - x)$
 i $(17 + x)(1 - x)$
- 5 a $4(3 + t)(3 - t)$
 b i 36 m
 c 3 seconds
- 6 a i x^2
 b i 500 cm²
- 7 a $(x + 3)(x - 3)$
 c $(2 + 5a)(2 - 5a)$
 e $(2b + 5a)(2b - 5a)$
 g $(yz + 4x)(yz - 4x)$
- 8 a Factorise each binomial:
 $(4x + 2)(4x - 2) = 2(2x + 1)2(2x - 1)$
 $= 4(2x + 1)(2x - 1)$
- b Take out common factor of 4.
- 9 $9 - (x - 1)^2$
 $= (3 + x - 1)(3 - (x - 1))$ insert brackets
 when subtracting a binomial
 $= (2 + x)(3 - x + 1)$ remember $-1 \times -1 = +1$
 $= (2 + x)(4 - x)$
- 10 a $\left(x + \frac{1}{2}\right)\left(x - \frac{1}{2}\right)$
 c $\left(5x + \frac{3}{4}\right)\left(5x - \frac{3}{4}\right)$
 e $\left(\frac{a}{2} + \frac{b}{3}\right)\left(\frac{a}{2} - \frac{b}{3}\right)$
 g $7\left(\frac{a}{5} + \frac{2b}{3}\right)\left(\frac{a}{5} - \frac{2b}{3}\right)$
 i $(x + y)(x - y)(x^2 + y^2)$
 k $21(a + b)(a - b)(a^2 + b^2)$
- b $(3x + 7)(3x - 7)$
 d $(2m + 11)(2m - 11)$
 f $(9a + 2)(9a - 2)$
 h $(5 + 8b)(5 - 8b)$
 j $(6x + y)(6x - y)$
 l $(8a + 7b)(8a - 7b)$
 n $(9m + 2n)(9m - 2n)$
 p $(10a + 3b)(10a - 3b)$
- b $10(a + 1)(a - 1)$
 d $4(y + 4)(y - 4)$
 f $8(2 + m)(2 - m)$
 h $3(1 + xy)(1 - xy)$
- b $(x + 5)(x + 1)$
 d $(x + 2)(x - 8)$
 f $(x + 3)(x - 9)$
 h $-x(x + 4)$
- ii 20 m
 ii $(30 + x)(30 - x)$
 ii 675 cm²
- b $(4x + 11)(4x - 11)$
 d $(x + y)(x - y)$
 f $(c + 6ab)(c - 6ab)$
 h $(b + 30a)(b - 30a)$

8E

Building understanding

- 1 a $2x - 2$
 c $a^2 + 5a$
 e $ax + x + 2a + 2$
- 2 a $2 + x$
 c $a + 1$
- b $-5 + 5a$
 d $4y - y^2$
 f $bx - 2b - 3x + 6$
 b $5 - x$
 d $1 - a$

- 3 a $(x-3)(x-2)$ b $(x+4)(x+3)$
 c $(2x+1)(3-x)$ d $(3x-2)(4-x)$
 e $(5-x)(3x+2)$ f $(x-2)(x+1)$

Now you try

Example 9

- a $(x+4)(x+2)$ b $(x+2)(x-3)$

Example 10

$$(x-5)(2x+3)$$

Exercise 8E

- 1 a $(x+3)(x+2)$ b $(x+4)(x+3)$
 c $(x+7)(x+2)$ d $(x-6)(x+4)$
 e $(x-4)(x+6)$ f $(x-3)(x+10)$
 g $(x+2)(x-18)$ h $(x+3)(x-14)$
 i $(x+4)(x-18)$ j $(x-2)(x-a)$
 k $(x-3)(x-3c)$ l $(x-5)(x-3a)$
 2 a $(3a+5c)(b+d)$ b $(4b-7c)(a+d)$
 c $(y-4z)(2x+3w)$ d $(s-2)(5r+t)$
 e $(x+3y)(4x-3)$ f $(2b-a)(a-c)$
 3 a $(x-b)(x+1)$ b $(x-c)(x+1)$
 c $(x+b)(x+1)$ d $(x+c)(x-1)$
 e $(x+a)(x-1)$ f $(x-b)(x-1)$
 4 a $(x-7)(2x+1)$ b $(x+5)(x+2)$
 c $(x+3)(2x-1)$ d $(1-2x)(3x+4)$
 e $(x-5)(11+a)$ f $(3-2x)(4y-1)$
 g $(n+2)(3m-1)$ h $(3-r)(5p+8)$
 i $(2-y)(8x+3)$
 5 a $x^2+4x-ax-4a$ b $x^2-dx-cx+cd$
 c $2x-xz+2y-yz$ d $ax+bx-a-b$
 e $3cx-3bx-bc+b^2$ f $2xy+2xz-y^2-yz$
 g $6ab+15ac+2b^2+5bc$ h $3my+mz-6xy-2xz$
 i $2ps+4pt-3qs-6qt$
 6 a $(x+2)(x+5)$ b $(x+3)(x+5)$
 c $(x+4)(x+6)$ d $(x-3)(x+2)$
 e $(x+6)(x-2)$ f $(x-9)(x-2)$
 7 a Method 1: $a(x+7)-3(x+7)=(x+7)(a-3)$
 Method 2: $x(a-3)+7(a-3)=(a-3)(x+7)$
 b i $(x-3)(b+2)$ ii $(x+2)(y-4)$
 iii $(2m+3)(2m-5n)$ iv $(2-n)(m-3)$
 v $(1-2b)(4a+3b)$ vi $(3a-1)(b+4c)$
 8 Answers may vary.
 9 a $(a-3)(2-x-c)$ b $(2a+1)(b+5-a)$
 c $(a+1)(x-4-b)$ d $(a-b)(3-b-2a)$
 e $(1-a)(c-x+2)$ f $(x-2)(a+2b-1)$
 g $(a-3c)(a-2b+3bc)$ h $(1-2y)(3x-5z+y)$
 i $(x-4)(3x+y-2z)$ j $(ab-2c)(2x+3y-1)$

8F**Building understanding**

- 1 a $x^2+9x+14$ b $x^2+14x+33$
 c $x^2+7x-60$ d $x^2-8x+12$
 2 a 3, 2 b 12, 1 c 4, 5
 d 5, -3 e -6, 5 f -9, -2

Now you try

Example 11

- a $(x+2)(x+7)$ b $(x+6)(x-2)$
 c $(x-3)(x-4)$

Example 12

$$3(x+3)(x-5)$$

Exercise 8F

- 1 a $(x+6)(x+2)$ b $(x+9)(x+1)$
 c $(x+7)(x+1)$ d $(x+14)(x+1)$
 e $(x+3)(x+4)$ f $(x+8)(x+2)$
 g $(x+5)(x+3)$ h $(x+4)(x+5)$
 i $(x+8)(x+3)$
 2 a $(x+4)(x-1)$ b $(x+2)(x-1)$
 c $(x+5)(x-1)$ d $(x+7)(x-2)$
 e $(x+5)(x-3)$ f $(x+10)(x-2)$
 g $(x+6)(x-3)$ h $(x+9)(x-2)$
 i $(x+4)(x-3)$
 3 a $(x-5)(x-1)$ b $(x-1)(x-1)$
 c $(x-1)(x-4)$ d $(x-8)(x-1)$
 e $(x-2)(x-2)$ f $(x-6)(x-2)$
 g $(x-9)(x-2)$ h $(x-7)(x-3)$
 i $(x-3)(x-2)$
 4 a $(x-8)(x+1)$ b $(x-4)(x+1)$
 c $(x-6)(x+1)$ d $(x-8)(x+2)$
 e $(x-6)(x+4)$ f $(x-5)(x+3)$
 g $(x-4)(x+3)$ h $(x-12)(x+1)$
 i $(x-6)(x+2)$
 5 a $2(x+4)(x+1)$ b $2(x+10)(x+1)$
 c $3(x+2)(x+4)$ d $2(x+10)(x-3)$
 e $2(x-9)(x+2)$ f $4(x-1)(x-1)$
 g $2(x-2)(x+3)$ h $6(x-6)(x+1)$
 i $5(x-4)(x-2)$ j $3(x-5)(x-6)$
 k $2(x-5)(x+2)$ l $3(x-4)(x+3)$
 6 a $6x$ b $6x$ or $10x$
 c $x, 4x, 11x$ d $x, 4x, 11x$
 e $9x, 11x, 19x$ f $9x, 11x, 19x$
 g $0x, 6x, 15x$ h $0x, 24x$
 7 a i $x(x+2)$ ii $x^2+2x-15$
 iii $(x+5)(x-3)$
 b i 105 m^2 ii 48 m^2
 8 a $(x+4)^2$ b $(x+5)^2$ c $(x+15)^2$
 d $(x-1)^2$ e $(x-7)^2$ f $(x-13)^2$
 g $2(x+1)^2$ h $5(x-3)^2$ i $-3(x-6)^2$
 9 B, C, E, F
 10 a $(x-1)^2-9$ b $(x+2)^2-5$
 c $(x+5)^2-22$ d $(x-8)^2-67$
 e $(x+9)^2-74$ f $(x-16)^2-267$

Progress quiz

- 1 a x^2+6x+8 b $a^2+3a-40$
 c $2x^2+9x-18$ d $3a^2-7ab+2b^2$
 2 a $y^2+8y+16$ b x^2-6x+9
 c $4a^2-12a+9$ d $49k^2+28km+4m^2$
 3 a x^2-25 b $121x^2-81y^2$

- 4 a $5(5a - 3)$
 c $-4x(3x + 4)$
 e $(8 + a)(7 - a)$
 5 a $(x + 9)(x - 9)$
 c $(5x + y)(5x - y)$
 e $12(xy + 1)(xy - 1)$
 6 a $(x + 7)(x + 2)$
 c $(x - h)(x + 1)$
 7 a $(x - 3)(2x + 3)$
 8 a $(x + 4)(x + 2)$
 c $(m - 6)(m - 5)$
- b $x(x - 7)$
 d $(a + 3)(2 + a)$
 f $(k - 4)(k - 1)$
 b $(4a + 7)(4a - 7)$
 d $2(a + 5)(a - 5)$
 f $(h + 11)(h - 5)$
 b $(a + 5)(a - 4)$
 b $(3a + 2)(p - 5)$
 b $(a + 5)(a - 3)$
 d $2(k - 3)(k + 4)$

8G

Building understanding

- 1 a 2, 6
 c $-5, -7$
 2 a $= 2x^2 + 2x + 5x + 5$
 $= 2x(x + 1) + 5(x + 1)$
 $= (x + 1)(2x + 5)$
 c $= 5x^2 + 10x - x - 2$
 $= 5x(x + 2) - 1(x + 2)$
 $= (x + 2)(5x - 1)$
 b 8, -3
 d $-7, 4$
 b $= 2x^2 - 3x - 4x + 6$
 $= x(2x - 3) - 2(2x - 3)$
 $= (2x - 3)(x - 2)$
 d $= 4x^2 + 8x + 3x + 6$
 $= 4x(x + 2) + 3(x + 2)$
 $= (x + 2)(4x + 3)$

Now you try

Example 13
 $(3x + 2)(x + 3)$

Example 14

- a $(2x + 5)(2x - 3)$ b $(4x - 3)(2x - 3)$

Exercise 8G

- 1 a $(2x + 1)(x + 4)$
 c $(2x + 3)(x + 2)$
 e $(5x + 2)(x + 2)$
 g $(3x + 5)(2x + 1)$
 i $(4x + 5)(2x + 1)$
 2 a $(3x + 5)(x - 1)$
 c $(2x + 3)(4x - 1)$
 e $(2x + 1)(5x - 4)$
 g $(2x - 5)(2x - 3)$
 i $(2x - 5)(3x - 2)$
 k $(2x - 3)(2x - 3)$
 m $(x + 5)(9x - 1)$
 o $(2x - 5)(2x + 3)$
 3 a $2(3x - 2)(5x + 1)$
 c $3(3x - 5)(3x - 1)$
 e $4(3x - 2)(3x + 5)$
 4 a $(2x + 1)(5x + 11)$
 c $(2x - 3)(10x - 3)$
 e $(5x - 3)(5x + 4)$
 g $(3x + 2)(9x - 4)$
 i $(6x - 5)(9x + 1)$
 k $(3x - 1)(25x - 6)$
 5 a $-(x - 2)(2x - 3)$
 c $-(2x + 1)(3x - 8)$
 e $-(2x - 5)(2x - 3)$
 b $(3x + 1)(x + 2)$
 d $(3x + 2)(x + 2)$
 f $(2x + 3)(x + 4)$
 h $(4x + 1)(x + 1)$
 b $(5x - 4)(x + 2)$
 d $(2x + 1)(3x - 8)$
 f $(x - 3)(5x + 4)$
 h $(x - 6)(2x - 3)$
 j $(3x - 4)(4x + 1)$
 l $(x + 3)(7x - 3)$
 n $(x - 2)(3x - 8)$
 b $6(x - 1)(2x + 5)$
 d $7(x - 3)(3x - 2)$
 f $5(2x - 3)(5x + 4)$
 b $(3x + 4)(5x - 2)$
 d $(2x + 1)(9x - 5)$
 f $(4x + 1)(8x - 5)$
 h $(3x + 1)(11x + 10)$
 j $(2x - 3)(6x - 7)$
 l $(6x - 1)(15x + 8)$
 b $-(x - 1)(5x + 8)$
 d $-(x + 3)(5x - 6)$
 f $-(2x - 1)(4x - 5)$

- 6 a $(x + 4)(2x - 5)$
 b $(2x - 5)(x + 4)$
 c No, you get the same result.
 d i $(x + 3)(3x - 4)$
 ii $(x - 2)(5x + 7)$
 iii $(2x - 1)(3x + 4)$
 7 Answers may vary.
 8 See answers to Questions 2 and 4.

8H

Building understanding

- 1 a $\frac{1}{3}$ b $\frac{2x}{3}$ c $\frac{3}{x}$ d $\frac{x + 1}{2}$
 2 a $3(x + 2)$
 c $x(x - 7)$
 3 a $\frac{2(x - 2)}{8} = \frac{x - 2}{4}$
 4 a 9
 b $20(1 - 2x)$
 d $6x(x + 4)$
 b $\frac{6(2 - 3x)}{x(2 - 3x)}$
 b $\frac{1}{12}$

Now you try

Example 15

- a $\frac{x - 3}{3}$ b $\frac{3}{5}$ c $x - 3$

Example 16

- a $\frac{9}{5(x - 4)}$ b $\frac{2(x - 2)}{x}$ c $\frac{x - 3}{3}$

Exercise 8H

- 1 a $\frac{3}{4}$ b $\frac{1}{3}$ c 4
 d $x - 5$ e $\frac{2(x - 1)}{3}$ f $\frac{2}{x + 4}$
 2 a $x - 1$ b $\frac{2(x - 3)}{5}$ c $\frac{2}{3}$
 d 2 e $x - 3$ f $\frac{2(2x + 5)}{5}$
 g $\frac{3}{2}$ h $\frac{4}{3}$
 3 a $x - 10$ b $x - 7$ c $x - 5$
 d $\frac{2}{x + 20}$ e $\frac{5}{x + 6}$ f $\frac{3}{x - 9}$
 4 a $x + 2$ b $x + 4$ c $x - 3$
 d $\frac{1}{x + 3}$ e $\frac{1}{x - 2}$ f $\frac{1}{x - 10}$
 5 a $\frac{x - 4}{2}$ b $x - 3$
 c $3(x - 3)$ d $\frac{x + 4}{2(x - 5)}$
 6 a x b $\frac{2(x - 2)}{x + 2}$
 c $\frac{4}{x + 1}$ d $\frac{x - 2}{2(x + 2)}$
 e $\frac{2(x + 2)^2}{3(x + 4)}$ f $\frac{5}{x + 2}$
 7 a $(x + 2)(x - 5)$ b $\frac{x + 2}{x + 3}$
 c $\frac{x - 3}{x - 4}$ d $\frac{x - 5}{x + 2}$
 e $\frac{3x - 1}{2 - 15x}$ f $\frac{x - 4}{3 - x}$
 g $\frac{x + 5}{2(x + 4)}$ h $\frac{3}{2(x + 3)}$

- 8 a $a+1$ b $5(a-3)$ c $\frac{x+7}{2}$
 d $\frac{x+2}{6}$ e $\frac{x+3}{2}$ f $\frac{11}{x-2}$
 9 a -1 b -1 c -8
 d $-\frac{1}{3}$ e $-\frac{1}{6}$ f $-(x+3)$
 10 a $-\frac{x+3}{2}$ b $-\frac{x-7}{3}$
 c $-\frac{x-8}{x+8}$ d $-\frac{2}{x+2}$
 e $-\frac{4}{x+3}$ f $\frac{3(x+1)}{4}$
 g $\frac{3(2x+3)}{2x}$ h $-\frac{1}{2(x+2)}$
 i $\frac{x}{3}$ j $-\frac{2}{x-2}$

8I

Building understanding

- 1 a 24 b 15 c 143 d 36
 2 a $21x$ b 2 c 8 d 90
 3 a $\frac{3x}{12} + \frac{8x}{12} = \frac{11x}{12}$
 b $\frac{25x}{35} - \frac{14x}{35} = \frac{11x}{35}$
 c $\frac{2(x+1)}{4} + \frac{(2x+3)}{4} = \frac{2x+2+2x+3}{4} = \frac{4x+5}{4}$
 4 a 15 b 14 c 6

Now you try

Example 17

- a $-\frac{5x}{12}$ b $\frac{11x}{8}$ c $\frac{5x-8}{6}$

Example 18

- a $\frac{5}{3x}$ b $\frac{4x+5}{x^2}$

Exercise 8I

- 1 a $\frac{9x}{14}$ b $\frac{2x}{5}$ c $\frac{x}{8}$ d $\frac{14x}{45}$
 e $\frac{y}{56}$ f $\frac{13a}{22}$ g $\frac{2b}{9}$ h $\frac{m}{6}$
 i $\frac{11m}{12}$ j $\frac{15a}{28}$ k $\frac{x}{2}$ l $-\frac{20p}{63}$
 m $-\frac{5b}{18}$ n $\frac{61y}{40}$ o $\frac{13x}{35}$ p $\frac{5x}{12}$
 2 a $\frac{7x+11}{10}$ b $\frac{7x}{12}$ c $\frac{15a-51}{56}$
 d $\frac{11y+9}{30}$ e $\frac{13m+28}{40}$ f $\frac{5x-13}{24}$
 g $\frac{11b-6}{24}$ h $\frac{7x}{6}$ i $\frac{7y-8}{14}$
 j $\frac{5r-4}{16}$ k $\frac{34-10x}{21}$ l $\frac{8m-9}{12}$
 3 a $\frac{11}{2x}$ b $\frac{1}{3x}$ c $-\frac{3}{4x}$
 d $\frac{14}{9x}$ e $\frac{7}{20x}$ f $\frac{13}{15x}$
 g $-\frac{31}{4x}$ h $-\frac{29}{12x}$

- 4 a $\frac{3x+2}{x^2}$ b $\frac{5+4x}{x^2}$ c $\frac{7x+3}{x^2}$
 d $\frac{4x-5}{x^2}$ e $\frac{3-8x}{x^2}$ f $\frac{x-4}{x^2}$
 g $\frac{6x-7}{2x^2}$ h $\frac{9-2x}{3x^2}$
 5 a $\frac{8+x^2}{4x}$ b $\frac{x^2-10}{2x}$
 c $\frac{-6-4x^2}{3x}$ d $\frac{6-5x^2}{4x}$
 e $\frac{9x^2-10}{12x}$ f $\frac{3-x^2}{9x}$
 g $\frac{15x^2-4}{10x}$ h $\frac{-25-6x^2}{20x}$
 6 a $\frac{x}{3}$ b $\frac{x}{8}$ c $\frac{x}{2}$
 d $\frac{x}{5}$ e $\frac{8x}{9}$ f $\frac{x}{4}$
 7 a $\frac{4x}{3}$ b 200 seconds

8 a $\frac{8x+2}{8} = \frac{2(4x+1)}{8} = \frac{4x+1}{4}$

b $\frac{4x+1}{4}$

c Using denominator 8 does not give answer in simplified form and requires extra steps. Preferable to use actual LCD.

- 9 a didn't make a common denominator, $\frac{7x}{15}$
 b didn't use brackets: $2(x+1) = 2x+2$, $\frac{7x+2}{10}$
 c didn't use brackets: $3(x-1) = 3x-3$, $\frac{13x-3}{6}$
 d didn't multiply numerator in $\frac{2}{x}$ by x as well as denominator, $\frac{2x-3}{x^2}$

- 10 a $-\frac{43x}{30}$ b $\frac{5x}{12}$ c $\frac{13x}{24}$
 d $\frac{43x-5}{60}$ e $\frac{23x-35}{42}$ f $\frac{29x+28}{40}$
 g $\frac{14}{3x}$ h $\frac{1}{6x}$ i $-\frac{11}{20x}$
 j $\frac{24-x}{6x^2}$ k $\frac{60x-21}{14x^2}$ l $\frac{3-4x}{9x^2}$
 m $\frac{30-2x^2}{15x}$ n $\frac{11x^2-3}{6x}$ o $\frac{18-2x^2}{45x}$

8J

Building understanding

- 1 a $-2x-6$ b $-14-21x$
 c $-3x+3$ d $-30+20x$
 2 a 9 b $2x$
 c x^2 d $(x-2)(x+3)$
 3 a $-x-4$ b $3x+16$ c $6-2x$

Now you try

Example 19

a $\frac{x-16}{6}$ b $\frac{10x-5}{12}$

Example 20

a $\frac{5x-5}{(x+2)(x-3)}$ b $\frac{11-3x}{(x-2)^2}$

Exercise 8J

- 1 a $\frac{1-x}{12}$ b $\frac{2x-14}{15}$ c $\frac{x-9}{6}$
 d $\frac{-7x-14}{10}$ e $\frac{9x-4}{8}$ f $\frac{-x-24}{28}$
 g $\frac{5x-3}{12}$ h $\frac{1-18x}{15}$ i $\frac{8x-23}{30}$
 2 a $\frac{13-x}{6}$ b $\frac{2x+2}{35}$ c $\frac{x-5}{4}$
 d $\frac{22x-41}{21}$ e $\frac{17x}{20}$ f $\frac{30-13x}{24}$
 g $\frac{14x+4}{9}$ h $\frac{20x-9}{28}$ i $\frac{10-11x}{56}$
 3 a $\frac{7x-1}{(x-1)(x+1)}$ b $\frac{7x-7}{(x+4)(x-3)}$
 c $\frac{7x+1}{(x-2)(x+3)}$ d $\frac{5x+13}{(x-4)(x+7)}$
 e $\frac{4x+15}{(x+2)(x+3)}$ f $\frac{x-26}{(x+4)(x-6)}$
 g $\frac{x+9}{(x+5)(x+1)}$ h $\frac{16-6x}{(x-3)(x-2)}$
 i $\frac{7-2x}{(x-5)(x-6)}$
 4 a $\frac{1-3x}{(x+1)^2}$ b $\frac{-4x-10}{(x+3)^2}$ c $\frac{3x-2}{(x-2)^2}$
 d $\frac{18-2x}{(x-5)^2}$ e $\frac{9-x}{(x-6)^2}$ f $\frac{14-3x}{(x-4)^2}$
 g $\frac{4x+7}{(2x+1)^2}$ h $\frac{1-12x}{(3x+2)^2}$ i $\frac{20x-1}{(1-4x)^2}$
 5 a $\frac{5x-2}{(x-1)^2}$ b $\frac{19x+8}{12x}$
 c $\frac{10x^2-11x+4}{20x}$ d $\frac{x^2+7x}{(x-5)(x+1)}$
 e $\frac{2x^2-5x-3}{(4-x)(x-1)}$ f $\frac{x^2+2x+1}{(x-3)^2}$
 g $\frac{3-2x}{(x-2)^2}$ h $\frac{-x^2-11x}{(2x+1)(x+2)}$
 i $\frac{x^2-4x-1}{(x+1)^2}$
 6 a $\frac{3x+11}{(x+3)(x+4)(x+5)}$ b $\frac{2-2x}{(x+1)(x+2)(x+4)}$
 c $\frac{26-10x}{(x-1)(x-3)(2-x)}$ d $\frac{3x-2}{(x+1)(x-5)}$
 e $\frac{2x+9}{(x-4)(3-2x)}$ f $\frac{7x^2+7x}{(x+4)(2x-1)(3x+2)}$
 7 a second line $-2 \times (-2) = +4$ not -4
 b $\frac{33x+4}{10}$
 8 a $\frac{5}{1-x}$ b $\frac{4x-3}{5-x}$ c $\frac{9}{7x-3}$
 d $\frac{1-2x}{4-3x}$ e 1 f 0
 9 a $\frac{11}{2(x+2)}$ b $\frac{1}{3(x-1)}$
 c $\frac{23}{4(2x-1)}$ d $\frac{13-3x}{(x+3)(x-3)}$
 e $\frac{5x-6}{2(x+2)(x-2)}$ f $\frac{30x+33}{(3x-4)(3x+4)}$

- g $\frac{9x-27}{(x+3)(x+4)(x-5)}$ h $\frac{x+11}{(x-1)(x+3)^2}$
 i $\frac{2x+5}{5(x-2)(x-5)}$ j $\frac{-2}{x(x-1)(x+1)}$

8K

Building understanding

- 1 a 15 b 6 c 28
 2 a $4x$ b $2(x+3)$
 c 3 d $4(x-1)$
 3 a multiply by 5, subtract 3 then divide by 2
 b multiply by x then divide by 2

Now you try

- Example 21
 a $x = 12$ b $x = 12$ c $x = 3$

- Example 22
 a $x = \frac{7}{40}$ b $x = 7$

Exercise 8K

- 1 a 10 b 12 c 24
 d 10 e $\frac{6}{7}$ f $7\frac{1}{2}$
 g -8 h 15 i 4
 2 a 13 b 1 c $1\frac{3}{5}$
 d 59 e 1 f 5
 g 8 h $3\frac{2}{7}$ i $-3\frac{1}{4}$
 3 a -3 b -4 c 5
 d 1 e -1 f 6
 4 a $\frac{1}{16}$ b $\frac{1}{12}$ c $\frac{8}{15}$
 d $\frac{1}{36}$ e $\frac{3}{4}$ f $\frac{5}{24}$
 g $\frac{5}{12}$ h $-\frac{1}{6}$ i $2\frac{5}{6}$
 5 a $-\frac{5}{2}$ b -5 c -19
 d -4 e -1 f -6
 6 a $\frac{x}{2} + \frac{2x}{3} = 4$ b $x = 3\frac{3}{7}$
 7 a $\frac{x}{3} + \frac{x}{4} = 77$ b 132 games
 8 a $\frac{1}{6}$ b 2 c 0
 d $\frac{9}{13}$ e $\frac{3}{7}$ f $\frac{2}{11}$
 g $1\frac{5}{7}$ h 0 i -12
 j 9
 9 a $\frac{1}{x} + \frac{1}{2x} = \frac{3}{10}$ b 5 and 10
 10 On the second line, not every term has been multiplied by 12.
 The $2x$ should be $24x$ to give an answer $x = \frac{3}{29}$.
 11 On third line of working, $-2 \times (-1) = +2$ not -2 , giving
 answer $x = -4$.

12 a $4\frac{1}{2}$ b $5\frac{2}{3}$ c $1\frac{1}{2}$
 d 3 e 15 f -2

13 a $x = 2ab$ b $x = \frac{2bd}{2a - bc}$
 c $x = \frac{ac}{c - b}$ d $x = \frac{bd + be - ac}{c}$
 e $x = \frac{4c - 3b}{3a - 4}$ f $x = \frac{6b + a}{5}$
 g $x = -\frac{a^2}{2a - b - a^2}$ or $\frac{a^2}{a^2 - 2a + b}$
 h $x = \frac{ac}{c - a}$ i $x = \frac{ac}{b}$
 j $x = \frac{c - a}{b}$ k $x = \frac{b - bc}{a - c}$
 l $x = \frac{ad - b}{c - d}$ m $x = ab - 2a$
 n $x = \frac{a + b}{1 - a}$ o $x = \frac{2ab - a^2}{a - b}$

Problems and challenges

- 1 a 48, 49 b 33, 35 c 12, 15
 2 a 15 b 5
 3 $a = 2, b = 1, c = 7$ and $d = 8$
 4 a $(n + 1)^2 + 1$ or $n^2 + 2n + 2$
 b Answers may vary.
 5 $(n - 1)(n + 1)$
 a $n - 1$ and $n + 1$ are both even, since they are consecutive even numbers one of them is divisible by 4 hence their product is also divisible by 4
 b $n - 1, n, n + 1$ are 3 consecutive numbers, one of them must be divisible by 3. Since n is prime it must be $n - 1$ or $n + 1$ so their product is divisible by 3
 c $n^2 - 1$ is divisible by 3 and 4 and since they have no common factor it must also be divisible by $3 \times 4 = 12$
 6 Factorise each expression and cancel.
 7 $4x^2 - 4x + 1 = (2x - 1)^2$, which is always greater than or equal to zero
 8 Ryan

Success criteria example questions

- 1 $2x^2 + 5x - 12$
 2 $x^2 - 12x + 36$; $16x^2 - 25$
 3 $4x(3x - 2)$; $(2x + 3)(x + 5)$
 4 $(x - 10)(x + 10)$; $(2a - 3)(2a + 3)$
 5 $(x + 6)(x - 3)$
 6 $(x - 3)(2x + 3)$
 7 $(x + 7)(x - 3)$
 8 $2(x - 3)(x + 3)$; $3(x - 3)(x - 4)$
 9 $3x^2 + 11x + 6$; $(2x + 1)(2x - 3)$
 10 $\frac{3}{8}$
 11 $\frac{5(x - 1)}{3}$
 12 $\frac{1}{2}$
 13 $\frac{5x + 8}{6}$
 14 $\frac{10}{3x}$
 15 $\frac{5x + 23}{12}$

16 $\frac{5x - 8}{(x + 2)(x - 4)}$
 17 $x = \frac{30}{17}$; $x = -4$

Short-answer questions

- 1 a $x^2 + x - 12$ b $x^2 - 9x + 14$
 c $6x^2 - 5x - 6$ d $9x^2 + 3x - 12$
 2 a $x^2 + 6x + 9$ b $x^2 - 8x + 16$
 c $9x^2 - 12x + 4$ d $x^2 - 25$
 e $49 - x^2$ f $121x^2 - 16$
 3 a $4(a + 3b)$ b $3x(2 - 3x)$
 c $-5xy(x + 2)$ d $(x - 7)(x + 3)$
 e $(2x + 1)(x - 1)$ f $(x - 2)(x - 6)$
 4 a $(x + 10)(x - 10)$ b $3(x + 4)(x - 4)$
 c $(5x + y)(5x - y)$ d $(7 + 3x)(7 - 3x)$
 e $(x - 12)(x + 6)$ f $(1 - x)(1 + x)$
 5 a $(x - 3)(x + 6)$ b $(2x + 5)(2x - 1)$
 c $(x - 4)(3 + 2b)$
 6 a $(x + 3)(x + 5)$ b $(x - 6)(x + 3)$
 c $(x - 6)(x - 1)$ d $3(x + 7)(x - 2)$
 e $2(x + 4)^2$ f $(5x + 2)(x + 3)$
 g $(2x - 3)(2x + 1)$ h $(3x - 4)(2x - 3)$
 7 a $x + 4$ b $\frac{2}{3}$ c $\frac{x - 3}{5}$
 8 a $\frac{1}{4}$ b $\frac{x - 4}{2}$ c $\frac{x}{3}$
 d $\frac{2}{5}$ e $\frac{2x + 3}{50x}$ f 4
 9 a $\frac{11x}{12}$ b $\frac{5}{4x}$
 c $\frac{7x - 2}{x^2}$ d $\frac{x - 13}{24}$
 e $\frac{8x + 11}{(x + 1)(x + 2)}$ f $\frac{15 - 2x}{(x - 4)^2}$
 10 a $x = 20$ b $x = \frac{1}{6}$
 c $x = 7$ d $x = -1\frac{2}{9}$

Multiple-choice questions

- 1 A 2 E 3 D 4 C 5 B
 6 D 7 A 8 E 9 B 10 A

Extended-response questions

- 1 a $(x + 3)m$
 b i no change
 ii $(x^2 - 1)m^2$, 1 square metre less in area
 c i width = $(x - 3)m$, decreased by 3 metres
 ii $A = (x + 7)(x - 3) = (x^2 + 4x - 21)m^2$
 iii $A = 0 m^2$
 2 a $400 m^2$
 b i $l = w = (20 + 2x)m$
 ii $(4x^2 + 80x + 400)m^2$
 c $\frac{1}{4}$
 d $4x(x + 20)m^2$
 e $x = 5$

Chapter 9

9A

Building understanding

- 1 a i $\frac{1}{4}$ ii 0.25 iii 25%

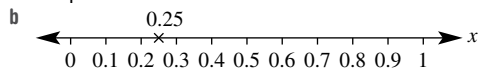

2

	Percentage	Decimal	Fraction	Number line
	50%	0.5	$\frac{1}{2}$	
a	25%	0.25	$\frac{1}{4}$	
b	20%	0.2	$\frac{1}{5}$	
c	60%	0.6	$\frac{3}{5}$	
d	85%	0.85	$\frac{17}{20}$	

- 3 0.15, $\frac{2}{9}$, 1 in 4, 0.28, $\frac{1}{3}$, $\frac{2}{5}$, $\frac{3}{7}$, 2 in 3, 0.7, 0.9

Now you try

Example 1

- a {1, 2, 3, 4, 5} b $\frac{3}{8}$ c $\frac{5}{8}$

- d $\frac{5}{8}$ e $\frac{7}{8}$

Example 2

- a $\frac{1}{9}$ b $\frac{8}{9}$ c $\frac{5}{9}$ d $\frac{4}{9}$ e $\frac{2}{3}$ f 1

Exercise 9A

- 1 a {1, 2, 3, 4, 5, 6, 7} b $\frac{1}{7}$
 c $\frac{6}{7}$ d $\frac{2}{7}$
 e $\frac{6}{7}$
- 2 a i {2, 6, 7} ii $\frac{1}{2}$ iii $\frac{1}{2}$
 iv $\frac{1}{2}$ v 1
 b i {1, 2, 3} ii $\frac{2}{3}$ iii $\frac{1}{3}$
 iv $\frac{5}{6}$ v $\frac{5}{6}$
 c i {1, 2, 3} ii $\frac{1}{3}$ iii $\frac{2}{3}$
 iv $\frac{2}{3}$ v $\frac{2}{3}$
 d i {1, 2, 3, 4} ii $\frac{1}{7}$ iii $\frac{6}{7}$
 iv $\frac{3}{7}$ v $\frac{5}{7}$
- 3 a $\frac{1}{2}$ b $\frac{3}{8}$ c $\frac{1}{6}$
 d $\frac{1}{4}$ e 1 f 0

- 4 a $\frac{1}{2}$ b $\frac{5}{8}$ c $\frac{5}{6}$
 d $\frac{3}{4}$ e 0 f 1

- 5 a $\frac{1}{8}$ b $\frac{7}{8}$

- 6 a $\frac{1}{8}$ b $\frac{1}{4}$ c $\frac{3}{8}$ d $\frac{3}{8}$ e $\frac{5}{8}$
 f 1 g 0 h $\frac{1}{4}$ i $\frac{3}{4}$ j $\frac{3}{4}$

- 7 a {Hayley, Alisa, Rocco, Stuart}

- b i $\frac{1}{4}$ ii $\frac{1}{2}$ iii $\frac{1}{2}$

- 8 a $\frac{1}{6}$ b $\frac{1}{6}$ c $\frac{5}{6}$ d $\frac{1}{3}$ e $\frac{2}{3}$

- f 1 g $\frac{1}{3}$ h $\frac{1}{2}$ i $\frac{5}{6}$

- 9 a $\frac{1}{52}$ b $\frac{1}{13}$ c $\frac{1}{26}$ d $\frac{1}{2}$

- e $\frac{2}{13}$ f $\frac{12}{13}$ g $\frac{23}{26}$ h $\frac{25}{26}$

- 10 a $\frac{2}{11}$ b $\frac{9}{11}$ c $\frac{3}{11}$

- d $\frac{7}{11}$ e $\frac{4}{11}$

11 Amanda has not taken into account the fact there are two 0's.

12 A, D, F

- 13 a $\frac{12}{25}$ b $\frac{8}{25}$ c $\frac{1}{5}$ d $\frac{9}{25}$ e $\frac{8}{25}$

- f $\frac{16}{25}$ g $\frac{4}{25}$ h $\frac{17}{25}$ i 0

- 14 a 31 min b $\frac{3}{31}$

- c i $\frac{4}{31}$ ii $\frac{4}{31}$ iii $\frac{20}{31}$

- iv $\frac{5}{31}$ v $\frac{8}{31}$ vi $\frac{11}{31}$

9B

Building understanding

- 1 a 26
 b i 10 ii 9 iii 4
 iv 7 v 19

- c i 12 ii 17

- 2 a B b D c A d C

3 a

	A	Not A	Total
B	7	8	15
Not B	3	1	4
Total	10	9	19

b

	A	Not A	Total
B	2	5	7
Not B	9	4	13
Total	11	9	20

Now you try

Example 3

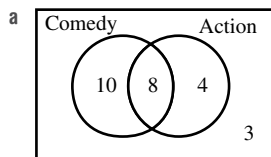

- b i 22 ii 13 iii 10
 c i $\frac{8}{25}$ ii $\frac{3}{25}$ iii $\frac{4}{25}$

Example 4

a

	Classes	Not classes	Total
Equipment	8	11	19
Not equipment	10	1	11
Total	18	12	30

- b i 12 ii 1
 c i $\frac{19}{30}$ ii $\frac{1}{3}$ iii $\frac{29}{30}$

Exercise 9B

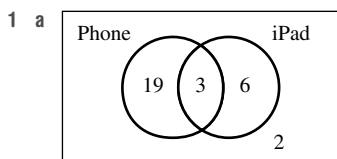

- b i 28 ii 21 iii 6
 c i $\frac{1}{10}$ ii $\frac{1}{15}$ iii $\frac{19}{30}$

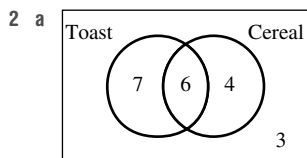

- b i 17 ii 7 iii 7
 c i $\frac{3}{10}$ ii $\frac{1}{5}$
 3 a i $\frac{2}{5}$ ii $\frac{1}{3}$ iii $\frac{7}{15}$
 iv $\frac{1}{15}$ v $\frac{13}{15}$ vi $\frac{2}{15}$
 b i $\frac{3}{7}$ ii $\frac{12}{35}$ iii $\frac{13}{35}$
 iv $\frac{3}{35}$ v $\frac{34}{35}$ vi $\frac{1}{35}$

4 a

	Cream	Not cream	Total
Ice-cream	5	20	25
Not ice-cream	16	9	25
Total	21	29	50

- b i 29 ii 9
 c i $\frac{21}{50}$ ii $\frac{8}{25}$ iii $\frac{41}{50}$

- 5 a i $\frac{5}{8}$ ii $\frac{3}{8}$ iii $\frac{3}{8}$
 iv $\frac{3}{4}$ v $\frac{1}{8}$ vi $\frac{1}{4}$
 b i $\frac{17}{26}$ ii $\frac{9}{26}$ iii $\frac{11}{26}$
 iv $\frac{21}{26}$ v $\frac{2}{13}$ vi $\frac{5}{26}$

6 a

	A	Not A	Total
B	2	6	8
Not B	3	1	4
Total	5	7	12

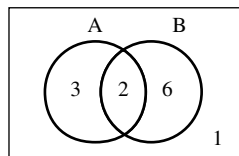

b

	A	Not A	Total
B	3	4	7
Not B	9	4	13
Total	12	8	20

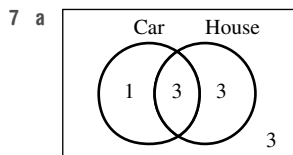
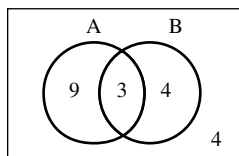

- b 3 c $\frac{1}{10}$

8 a

	Rainwater	Not rainwater	Total
Tap water	12	36	48
Not tap water	11	41	52
Total	23	77	100

- b 12 c $\frac{9}{25}$ d $\frac{59}{100}$
 9 23
 10 $\frac{7}{15}$

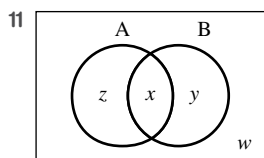

- 12 a $T-x-y+z$ b $T-x$ c $T-y$
 d $x-z$ e $y-z$ f $y-z$
 g $T-x+z$

13

	A	Not A	Total
B	0	12	12
Not B	11	-4	7
Total	11	8	19

Filling in table so totals add up requires a negative number, which is impossible!

14 4

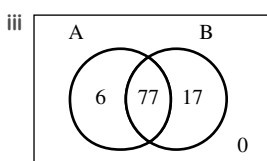
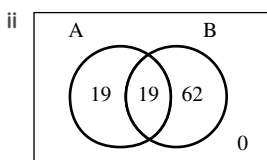
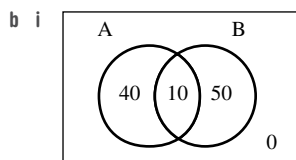
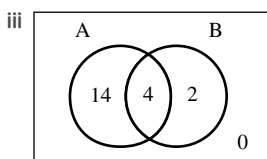
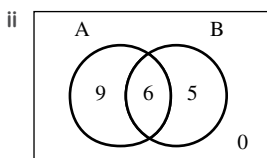
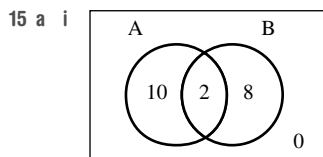

c overlap = $(A + B) - \text{total}$

9C

Building understanding

- 1 a C b D c E d A
 e F f B
 2 a B b D c A d C
 3 a 2 b 10 c 7 d 9

Now you try

Example 5

- a i {1, 2, 3, 4, 5, 6, 7, 8, 9, 10, 11, 12, 13, 14, 15}
 ii {1, 3, 5, 7, 9, 11, 13, 15}
 iii {2, 3, 5, 7, 11, 13}

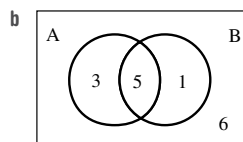

- c i {3, 5, 7, 11, 13} ii {1, 2, 3, 5, 7, 9, 11, 13, 15}
 iii {2, 4, 6, 8, 10, 12, 14} iv {2}
 d i 8 ii $\frac{8}{15}$ iii 5 iv $\frac{1}{3}$

Exercise 9C

- 1 a i {1, 2, 3, 4, 5, 6, 7, 8, 9, 10} ii {1, 3, 5, 7, 9} iii {2, 3, 5, 7}

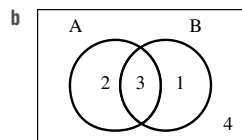

- c i {3, 5, 7} ii {1, 2, 3, 5, 7, 9}
 iii {2, 4, 6, 8, 10} iv {2}
 d i 5 ii $\frac{1}{2}$ iii 3 iv $\frac{3}{10}$

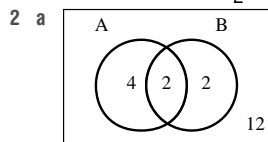

$A = \{3, 6, 9, 12, 15, 18\}$
 $B = \{1, 3, 5, 15\}$

- b i {3, 15} ii {1, 3, 5, 6, 9, 12, 15, 18}
 iii {1, 2, 4, 5, 7, 8, 10, 11, 13, 14, 16, 17, 19, 20}
 iv {1, 5}
 c i 4 ii $\frac{1}{5}$ iii 2
 iv $\frac{1}{10}$ v 8 vi $\frac{2}{5}$
 3 a i true ii true iii false iv false
 v true vi false vii true viii false
 b i $\frac{1}{2}$ ii $\frac{1}{2}$ iii 0
 4 a i $\frac{1}{6}$ ii $\frac{11}{12}$ iii $\frac{5}{12}$
 b i $\frac{6}{25}$ ii $\frac{21}{25}$ iii $\frac{8}{25}$
 c i $\frac{1}{3}$ ii $\frac{11}{15}$ iii $\frac{2}{5}$
 d i $\frac{5}{21}$ ii $\frac{17}{21}$ iii $\frac{4}{7}$
 5 a i {Fred, Ron, Rachel} ii {Fred, Rachel, Helen}
 iii { } iv {Fred, Rachel}
 b i $\frac{3}{4}$ ii $\frac{1}{4}$ iii 0
 iv 1 v $\frac{1}{2}$ vi 1
 6 a 26 b 5 c 3 d 18
 e $\frac{5}{26}$ f $\frac{21}{26}$ g $\frac{3}{26}$ h $\frac{5}{13}$

- 7 a 11 b 21 c 1 d $\frac{9}{25}$
 8 a own both a dog and a cat
 b own dogs or cats or both
 c does not own a cat
 d owns a cat but no dogs
 9 $B \text{ only} = B \cap A'$
 10 a yes

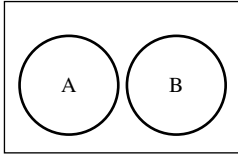

- b No, as $A \cup B$ includes only elements from sets A and B.

	A	A'	Total
B	$n(A \cap B)$	$n(B \cap A')$	$n(B)$
B'	$n(A \cap B')$	$n(A' \cap B')$	$n(B')$
Total	$n(A)$	$n(A')$	$n(\text{sample space})$

- 12 Mutually exclusive events have no common elements, i.e. $A \cap B = \emptyset$.

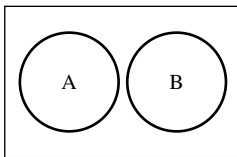

- 13 a i {2, 3, 5, 7, 11, 13, 17, 19} iii {2, 3}
 ii {1, 2, 3, 4, 6, 12} iv {1, 2, 3, 4, 5, 6, 7, 11, 12, 13, 17, 19}
 v {1, 4, 6, 12} vi {5, 7, 11, 13, 17, 19}
 vii {1, 2, 3, 4, 6, 8, 9, 10, 12, 14, 15, 16, 18, 20}
 viii {2, 3, 5, 7, 8, 9, 10, 11, 13, 14, 15, 16, 17, 18, 19, 20}
 ix {1, 4, 5, 6, 7, 8, 9, 10, 11, 12, 13, 14, 15, 16, 17, 18, 19, 20}
- b i $\frac{3}{5}$ ii $\frac{1}{10}$ iii $\frac{1}{5}$ iv $\frac{2}{5}$
 v $\frac{4}{5}$ vi $\frac{9}{10}$ vii $\frac{9}{10}$ viii $\frac{2}{5}$
 c They are equal.

9D

Building understanding

- 1 a 9 outcomes

	1	2	3
1	(1, 1)	(2, 1)	(3, 1)
2	(1, 2)	(2, 2)	(3, 2)
3	(1, 3)	(2, 3)	(3, 3)

- b 6 outcomes

	A	B	C
A	X	(B, A)	(C, A)
B	(A, B)	X	(C, B)
C	(A, C)	(B, C)	X

- 2 a table A b table B
 c i $\frac{1}{9}$ ii $\frac{1}{6}$
 d i 5 ii 4

Now you try

Example 6

		Counter 1	
		R	B
Counter 2	R	(R, R)	(B, R)
	B	(R, B)	(B, B)

- b $\frac{1}{4}$ c $\frac{1}{2}$

Example 7

		1st			
		D	A	T	A
2nd	D	×	(A, D)	(T, D)	(A, D)
	A	(D, A)	×	(T, A)	(A, A)
	T	(D, T)	(A, T)	×	(A, T)
	A	(D, A)	(A, A)	(T, A)	×

- b $\frac{1}{6}$ c $\frac{5}{6}$

Exercise 9D

	1	2	3	4	5	6
1	(1, 1)	(2, 1)	(3, 1)	(4, 1)	(5, 1)	(6, 1)
2	(1, 2)	(2, 2)	(3, 2)	(4, 2)	(5, 2)	(6, 2)
3	(1, 3)	(2, 3)	(3, 3)	(4, 3)	(5, 3)	(6, 3)
4	(1, 4)	(2, 4)	(3, 4)	(4, 4)	(5, 4)	(6, 4)
5	(1, 5)	(2, 5)	(3, 5)	(4, 5)	(5, 5)	(6, 5)
6	(1, 6)	(2, 6)	(3, 6)	(4, 6)	(5, 6)	(6, 6)

- b 36
 c i $\frac{1}{36}$ ii $\frac{1}{6}$ iii $\frac{1}{12}$ iv $\frac{5}{9}$

2 a

		A	
		•	°
B	•	(•, •)	(°, •)
	°	(•, °)	(°, °)
	°	(°, °)	(°, °)

- b 6
 c i $\frac{1}{3}$ ii $\frac{1}{2}$ iii $\frac{1}{2}$

3 a

	D	O	G
D	X	(O, D)	(G, D)
O	(D, O)	X	(G, O)
G	(D, G)	(O, G)	X

- b $\frac{1}{6}$ c $\frac{2}{3}$

4 a

		1st			
		1	2	3	4
2nd	1	X	(2, 1)	(3, 1)	(4, 1)
	2	(1, 2)	X	(3, 2)	(4, 2)
	3	(1, 3)	(2, 3)	X	(4, 3)
	4	(1, 4)	(2, 4)	(3, 4)	X

b i $\frac{1}{12}$

ii $\frac{1}{12}$

c i $\frac{1}{6}$

ii $\frac{5}{6}$

iii $\frac{1}{6}$

iv $\frac{1}{2}$

5 a

	1	2	3	4
1	2	3	4	5
2	3	4	5	6
3	4	5	6	7
4	5	6	7	8

b i $\frac{1}{16}$

ii $\frac{3}{16}$

iii $\frac{3}{8}$

iv $\frac{3}{16}$

v $\frac{13}{16}$

6 a

	A	B	C	D	E
A	(A, A)	(B, A)	(C, A)	(D, A)	(E, A)
B	(A, B)	(B, B)	(C, B)	(D, B)	(E, B)
C	(A, C)	(B, C)	(C, C)	(D, C)	(E, C)
D	(A, D)	(B, D)	(C, D)	(D, D)	(E, D)
E	(A, E)	(B, E)	(C, E)	(D, E)	(E, E)

b i $\frac{1}{25}$

ii $\frac{1}{5}$

iii $\frac{4}{5}$

c i $\frac{8}{25}$

ii $\frac{1}{25}$

7 a i $\frac{1}{36}$

ii $\frac{1}{12}$

iii $\frac{1}{12}$

iv $\frac{7}{12}$

v $\frac{5}{12}$

vi $\frac{1}{6}$

vii $\frac{1}{6}$

viii 0

b $7, \frac{1}{6}$

8 a i 169

ii 156

b i 25

ii 12

9 Yes; if one O is removed another remains to be used.

10 a $\frac{1}{25}$

b $\frac{1}{20}$

11 7, 8, 9, 10, 11

12 a $\frac{1}{2500}$

b $\frac{1}{50}$

c $\frac{1}{1250}$

d $\frac{49}{2500}$

e $\frac{23}{1250}$

13 a without replacement

b 2652

c $\frac{2}{52} \times \frac{1}{51} + \frac{2}{52} \times \frac{1}{51}$

d i $\frac{1}{221}$

ii $\frac{1}{17}$

9E

Building understanding

1 TT, TO, OT, OO

2 AB, AC, BA, BC, CA, CB

Now you try

Example 8

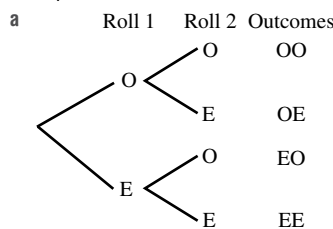

b 4

c i $\frac{1}{4}$

ii $\frac{1}{2}$

iii $\frac{3}{4}$

Example 9

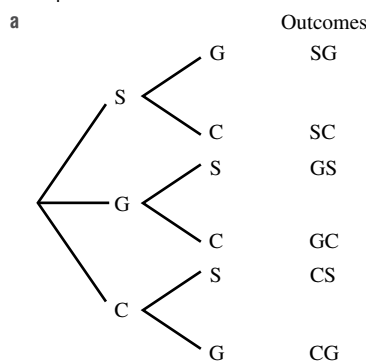

b i $\frac{1}{3}$

ii $\frac{2}{3}$

iii 1

Exercise 9E

1 a HH, HT, TH, TT

b 4

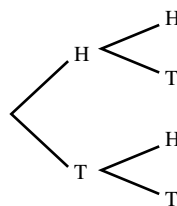

c i $\frac{1}{4}$

ii $\frac{1}{2}$

iii $\frac{3}{4}$

iv $\frac{3}{4}$

2 a Spin 1 Spin 2 Outcomes

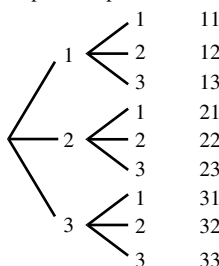

b 9

c i $\frac{1}{9}$

ii $\frac{5}{9}$

iii $\frac{8}{9}$

iv $\frac{4}{9}$

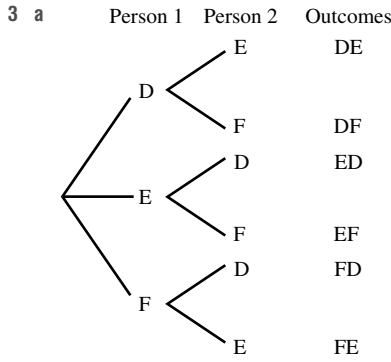

b i $\frac{1}{3}$ ii $\frac{2}{3}$ iii 1

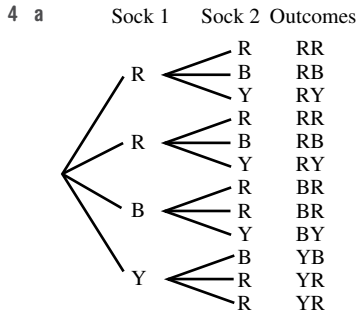

b i $\frac{1}{3}$ ii $\frac{1}{6}$ iii $\frac{1}{6}$ iv $\frac{5}{6}$

5 a $\frac{4}{9}$ b $\frac{2}{9}$ c $\frac{1}{27}$ d $\frac{8}{27}$

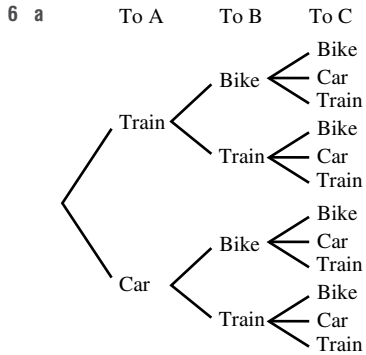

b 12
 c i $\frac{1}{12}$ ii $\frac{1}{3}$ iii $\frac{1}{2}$ iv $\frac{1}{4}$
 v $\frac{2}{3}$

7 a $\frac{1}{16}$ b $\frac{1}{16}$ c $\frac{5}{16}$ d $\frac{11}{16}$

e $\frac{15}{16}$

8 a $\frac{1}{16}$ b $\frac{1}{4}$ c $\frac{3}{8}$ d $\frac{1}{4}$

e $\frac{1}{16}$

9 a 32 b 2^n

10 Yes, there is a difference; the probability of obtaining two of the same colour is lower without replacement.

11 a $\frac{1}{9}$ b $\frac{1}{9}$ c $\frac{7}{18}$ d $\frac{7}{18}$ e $\frac{1}{2}$
 f 0 g $\frac{1}{6}$ h $\frac{2}{3}$ i $\frac{1}{9}$ j $\frac{17}{18}$

9F

Building understanding

1 a B: $\frac{5}{20} = 0.25$, C: $\frac{30}{100} = 0.3$
 b C, as it is a larger sample size
 2 a 5 b 20 c 4

Now you try

Example 10

a 0.6 b 120

Exercise 9F

1 a 0.6
 b i 60 ii 120 iii 360

2 a $\frac{7}{8}$
 b i 350 ii 4375 iii 35

3 a $\frac{1}{15}$ b $\frac{2}{5}$ c $\frac{11}{60}$

4 a 20
 b i $\frac{1}{4}$ ii $\frac{7}{20}$

c i 25 ii 20 iii 45

5 a 20 b 40 c 60 d 40

6 a 0.64 b SEE

7 a i 0.52 ii 0.48 iii 0.78

b 78
 c $\frac{1}{2}, \frac{1}{4}, \frac{1}{4}$

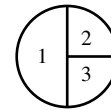

8 0.41, from the 100 throws as the more times an experiment is carried out the closer the experimental probability becomes to the actual/theoretical probability

9 a $\frac{9}{10}$
 b No, as the number of throws increases, the experiment should produce results closer to the theoretical probability ($\frac{1}{6}$).

10 a fair, close to 0.5 chance of tails
 b biased, nearly all results are heads
 c can't determine on such a small sample

11 a no b true c no d true

12 a $\frac{\text{shaded area}}{\text{total area}} = 0.225 \therefore 100 \text{ shots} \approx 23$

b $\frac{1}{10} \times 100 = 10$

c $\frac{150 - 32}{150} \times 100 \approx 79$

d $\frac{225\pi - 25\pi}{225\pi} \times 100 \approx 89$

13 3 blue, 2 red, 4 green, 1 yellow

14 2 strawberry, 3 caramel, 2 coconut, 4 nut, 1 mint

Progress quiz

- 1 a {1, 2, 3, 4, 5, 6} b {WL, LW, WW, LL}
 2 $\frac{4}{11}$

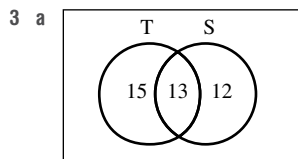

- b 13 c $\frac{27}{40}$
 4 $\frac{3}{10}$ or 0.3
 5 a i {10, 11, 12, 13, 14, 15, 16, 17, 18, 19, 20}
 ii {10, 12, 14, 16, 18, 20}
 iii {12, 15, 18}
 iv {12, 18}
 b i 2 ii $\frac{2}{11}$ iii $\frac{5}{11}$
 6 a $\frac{1}{2}$ b $\frac{1}{6}$ c $\frac{1}{18}$

7 a Outcomes

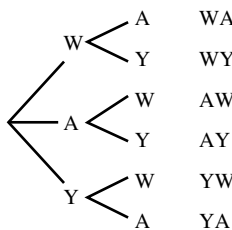

- b i $\frac{2}{3}$ ii 1 iii $\frac{1}{3}$ iv $\frac{1}{3}$
 8 a 0.4 b 0.56
 9 140

9G

Building understanding

- 1 a survey b bias
 c population d sample
 2 a categorical b numerical
 3 a stratified
 b simple random
 c systematic

Now you try

Example 11

- a numerical discrete b categorical nominal
 c numerical continuous d categorical ordinal

Example 12

- a i stratified
 ii systematic
 iii simple random
 b Yes. Wasram's team-mates at the soccer club are unlikely to represent the views of the wider community.

Exercise 9G

- 1 a numerical b categorical
 c categorical d numerical
 2 a categorical nominal b categorical ordinal
 c numerical continuous d numerical discrete
 3 a categorical nominal b numerical continuous
 c categorical ordinal d numerical discrete
 4 a i simple random
 ii stratified
 iii systematic
 b Yes. Only the people who are confident in answering the questions will raise their hand.
 5 a i systematic
 ii stratified
 iii simple random
 b Yes. There is a good chance that more water birds are in that area.
 6 Sales (3), Administration (7)
 7 Length: Numerical continuous
 Weight: Numerical continuous
 Favourite food: Categorical nominal
 Number of toys: Numerical discrete
 Type of scratching post: Categorical ordinal
 8 a expand his sample to include other member of the class
 b survey other vets in the practice too
 c consider the price of bread in other types of shops
 d survey other students not in the extension program
 9 10 Junior
 10 numerical discrete
 11 The data might be only relevant if sorted into age groups
 12 There is a good chance that the people who volunteer for surveys do not represent the wider community.
 13 Answers may vary

9H

Building understanding

- 1 a common/frequent
 b middle
 c mean

2

	Mean	Median	Mode
a	3	2	2
b	15	16	20

Now you try

Example 13

- a i 5 ii 4 iii 2
 b i 17 ii 16.5 iii no mode

Example 14

- a \$23 b \$37

Exercise 9H

	Mean	Median	Mode
1 a	8	6	5, 10
b	11	12	none
c	4	3.5	2.1
d	5	4.5	none
e	3	3.5	-3
f	0	2	3

- 2 a yes b no c no d yes
- 3 a outlier = 33, mean = 12, median = 7.5
 b outlier = -1.1, mean = 1.075, median = 1.4
 c outlier = -4, mean = -49, median = -59
 d outlier = 10, mean = -1.34, median = -2.4
- 4 a 24.67 s b 24.8 s
- 5 a 15 b 26
- 6 a 90 b 60
- 7 9
- 8 Answers may vary; examples below.
 a 1, 4, 6, 7, 7 is a set b 2, 3, 4, 8, 8 is a set
 c 4, 4, 4, 4, 4 is a set d 2.5, 2.5, 3, 7, 7.5 is a set
 e -3, -2, 0, 5, 5 is a set f $0, \frac{1}{2}, 1\frac{1}{4}, 1\frac{1}{4}, 2$ is a set
- 9 a \$354 500 b \$1 700 000
 c (\$354 500 and \$324 000) drops \$30 500
 d \$570 667
 e (\$570 667 and \$344 800) drops \$225 867
- 10 An outlier has a large impact on the addition of all the scores and therefore significantly affects the mean. An outlier does not move the middle of the group of scores significantly.
- 11 a 15 b 1.2 c 1 d 1
 e No, as it will still lie in the 1 column.
- 12 a 2 b 3 c 7
- 13 a 76.75
 b i 71.4, B⁺ ii 75, B⁺ iii 80.2, A
 c 81.4; he cannot get an A⁺
 d i 43 ii 93
 e $M = \frac{307 + m}{5}$
 f $m = 5M - 307$

9I

Building understanding

- 1 a 9
 b i 8 min ii 35 min
 c 21 min
- 2 a 26
 b skewed
 c symmetrical

Now you try

Example 15

Stem	Leaf
0	2 3
1	4 4
2	0 3 5
3	1 4 5 8 9
4	3 4 7 8
5	1 6 7
6	4

2 | 3 means 2.3

- b 3.65 c 1.4
 d Data is approximately symmetrical.

Example 16

Taipans		JackJumpers
8 7 4 2	6	
8 5 3 2 1	7	5 6 6
8	8	1 2 7 8 9
	9	4 7

7 | 2 means 72

- b The JackJumpers have the highest scores, with scores between 75 and 97. The scores for the Taipans are generally between 62 and 78, with one high score of 88.

Exercise 9I

Stem	Leaf
1	8
2	3 3 4
3	2 6 7 8
4	1 5 8
5	5 9
6	2

2 | 3 means 2.3

- ii 3.75 iii 2.3
 iv almost symmetrical

- 4 a i \$12 000 ii \$547 000 iii \$71 500
 iv \$46 000 v \$78 000 vi \$32 000
 b The middle 50% of prices differs by no more than \$32 000.
 c No effect on Q_1 , Q_2 or Q_3 but the mean would increase.
 5 a 17.5 b 2.1
 6 a 2 b 2
 c No, only the maximum value has changed, so no impact on IQR.
 7 No, as the range is the difference between the highest and lowest scores and different sets of two numbers can have the same difference ($10 - 8 = 2$, $22 - 20 = 2$).
 8 a Yes, as lowering the highest price reduces the range.
 b No, the middle price will not change.
 c No, as only one value; the highest has changed, yet it still remains the highest, Q_1 and Q_3 remain unchanged.
 9 a Yes (3, 3, 3, 4, 4, 4: IQR = $4 - 3 = 1$: range = 1)
 b Yes (4, 4, 4, 4, 4 has IQR = 0)
 10 a i $Q_1 = 25$; $Q_2 = 26$; $Q_3 = 27$
 ii $Q_1 = 22$; $Q_2 = 24.5$; $Q_3 = 27$
 b 27 jelly beans c 22 jelly beans
 d i IQR = 2 ii IQR = 5
 e Shop B is less consistent than shop A and its data is more spread out.
 f shop A

9L

Building understanding

- 1 a minimum value b lower quartile, Q_1
 c median, Q_2 d upper quartile, Q_3
 e maximum value f scale
 g whisker h box
 2 D

Now you try

Example 20

- a min = 0, max = 30 b 30
 c 15 d 15
 e 15 f 25
 g 20

Example 21

- a i 2 ii 8 iii 6
 iv 4 v 7

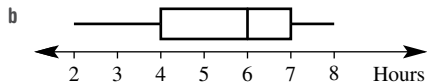

Exercise 9L

- 1 a min = 35 cm, max = 60 cm
 b 25 cm c 50 cm d 10 cm
 e 50 cm f 55 cm g 20 babies
 2 a min = 0 rabbits, max = 60 rabbits
 b 60 c 25 d 25
 e 35 f 25 g 25

- 3 a i 2 ii 13 iii 8
 iv 4 v 11

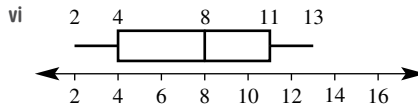

- b i 10 ii 88 iii 43
 iv 34 v 56

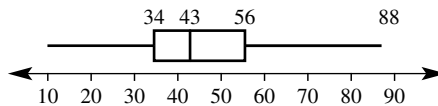

- c i 244 ii 933 iii 435 iv 255
 v 674

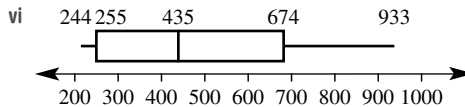

- d i 0.1 ii 1.3 iii 0.6 iv 0.4
 v 0.95

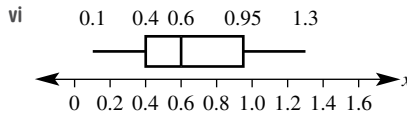

4 a

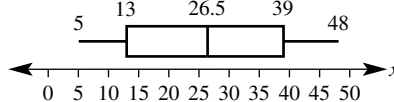

- b i 100% ii 50%
 iii 75% iv 25%
 5 a Africa b 10 kg c yes, 25 kg
 d i 50% ii 75%
 e African

- 6 a Mac b 75% c 50%
 d They are the same. Mac has 100% of times within same range as the middle 50% of PC start up times. Mac is more consistent.

- 7 a Waldren b Yeng c Yeng
 d Yeng, smaller range and IQR
 e Yeng, higher median

- 8 a 1, 3, 5, 6, 6 b 1, 4, 4, 4, 5, 6

- 9 No, the median is anywhere within the box, including at times at its edges.

- 10 Yes, one reason is if an outlier is the highest score, then the mean $> Q_3$; e.g. [1, 1, 3, 5, 6, 7, 256].

- 11 a $Q_1 = 4$, $Q_2 = 6$, $Q_3 = 8$
 b yes, 17 c 9

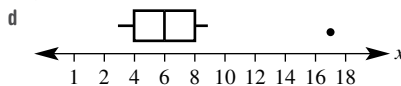

- e This calculator may have been used less often than the others, so the battery lasted longer.

Problems and challenges

- 1 a $2^5 = 32$ b $\frac{3}{16}$ c $\frac{31}{32}$
 2 a $\frac{1}{6}$ b $\frac{1}{3}$

- 3 a i $\frac{1}{4}$ ii $\frac{1}{2}$
 b $\frac{1}{6}$ c $\frac{1}{12}$ d $\frac{1}{3}$
 4 a mean and median increase by 5, range unchanged
 b mean, median and range all double
 c mean and median double and decrease 1, range doubles
 5 5m grams
 6 a 3, 5, 7, 8, 10 or 3, 5, 7, 9, 10
 b 2, 2, 8, 12
 7 1, 4, 6, 7, 7; 2, 3, 6, 7, 7 and 1, 2, 5, 6, 6
 8 $\frac{3}{8}$

Success criteria example questions

- 1 Sample space: {1, 2, 4, 2, 4, 3}; Pr(not a 2) = $\frac{2}{3}$;
 Pr(a 1 or a 2) = $\frac{1}{2}$

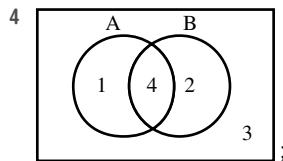
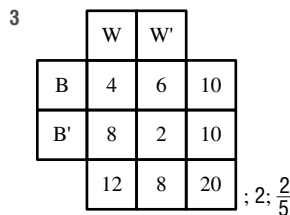
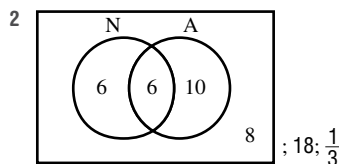

- i {1, 2, 3, 4, 6, 8, 10}; {1, 3}
 ii 5; $\frac{2}{5}$

5

	1	2	3	4
1	(1, 1)	(1, 2)	(1, 3)	(1, 4)
2	(2, 1)	(2, 2)	(2, 3)	(2, 4)
3	(3, 1)	(3, 2)	(3, 3)	(3, 4)
4	(4, 1)	(4, 2)	(4, 3)	(4, 4)

Pr(2 even numbers) = $\frac{1}{4}$

6

	G	R	E	E	N
G	X	(G, R)	(G, E)	(G, E)	(G, N)
R	(R, G)	X	(R, E)	(R, E)	(R, N)
E	(E, G)	(E, R)	X	(E, E)	(E, N)
E	(E, G)	(E, R)	(E, E)	X	(E, N)
N	(N, G)	(N, R)	(N, E)	(N, E)	X

Pr(at least one of the letters is an E) = $\frac{7}{10}$

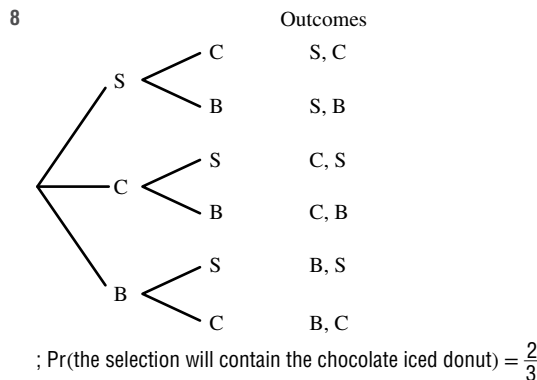
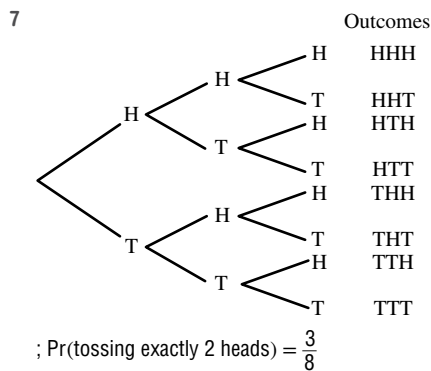

- 9 $\frac{2}{5}$; 120
 10 i numerical discrete;
 ii Categorical ordinal
 11 i systematic;
 ii stratified
 12 Yes, it is more likely that people at the airport travel more often.
 13 Mean = 5.5, median = 5, mode = 4 & 8
 14 6; 10

15

0	4	
1	7	Key
2	1 4 7	0 4 = 0.4
3	2 2	
4	1 4	

; median = 2.7, mode = 3.2; skewed

16

	City A		City B
		0	9 9
	9 9 8 8	1	0 2 2 3 5 7 7 8
	8 7 6 6 4 4 2 1	2	0 1 1 2
	2 0	3	

Key
 0 | 9 = 9
 City A has the highest recorded maximum daily temperature of 32°C. Its maximum daily temperatures are generally between 18°C and 28°C. City B's maximum daily temperatures are lower than City A, being generally between 10°C and 22°C

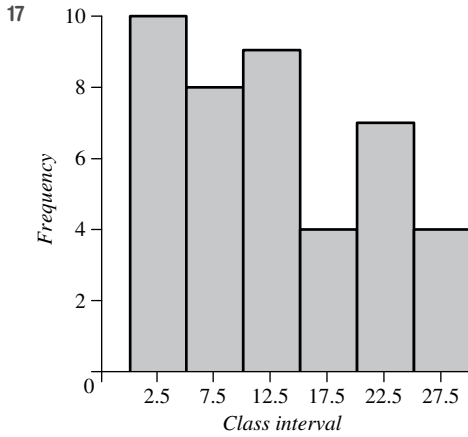

There are 15 hours of sales of 15 or more ice creams.

- 18 31
 19 $Q_1 = 7.5, Q_2 = 17, Q_3 = 21.5, IQR = 14$
 20 $Q_1 = 10, Q_2 = 14, Q_3 = 21, IQR = 11$; the middle 50% of the data differed by less than 11
 21 i range = 60, IQR = 30;
 ii 90;
 iii 12

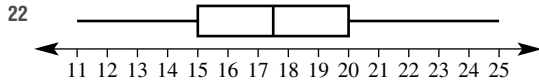

Short-answer questions

- 1 a $\frac{2}{3}$ b $\frac{5}{9}$ c $\frac{3}{5}$

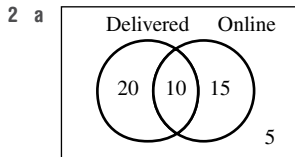

- b 15
 c i $\frac{1}{5}$ ii $\frac{2}{5}$ iii $\frac{3}{10}$

	A	A'	Total
B	9	16	25
B'	8	12	20
Total	17	28	45

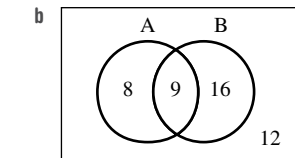

- c i $\frac{4}{9}$ ii $\frac{1}{5}$ iii 8 iv 33

4 a 12 outcomes

	1	2	3	4
Red	(red, 1)	(red, 2)	(red, 3)	(red, 4)
Green	(green, 1)	(green, 2)	(green, 3)	(green, 4)
Blue	(blue, 1)	(blue, 2)	(blue, 3)	(blue, 4)

- b i $\frac{1}{6}$ ii $\frac{1}{6}$ iii $\frac{2}{3}$

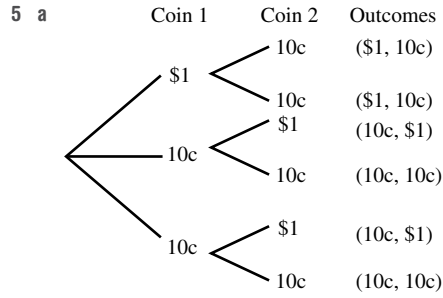

- b $\frac{2}{3}$
 6 a $\frac{48}{120} = \frac{2}{5}$ b 14
 7 a Categorical nominal
 b i simple random ii systematic
 c Yes, her extension science class may have different interests to others in the year level.
 8 a 26 b 26.5 c 23, 31
 9 15

Employee 1	Employee 2
9	1
5 3 1	2
9 8 6 5 5 4	3
6 5 0	4
3 1	5

2 | 4 means 24

- b i Employee 1: 36, Employee 2: 37
 ii Employee 1: 36, Employee 2: 33
 c Employee 1, they have a higher mean and more sales at the high end.
 d Employee 1 symmetrical, Employee 2 skewed

Class interval	Frequency	Percentage frequency
120–	1	4
130–	3	12
140–	4	16
150–	8	32
160–	7	28
170–180	2	8
Total	25	100%

b Finish times in car rally

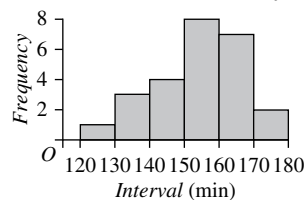

- c i 4 ii 60%

12 a 52 runs

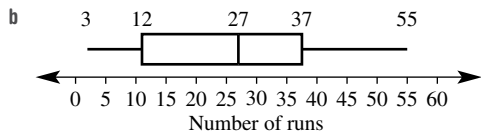

c 37 runs

Multiple-choice questions

- 1 B 2 A 3 D 4 B 5 D
6 B 7 E 8 C 9 B 10 E

Extended-response questions

1 a i

		1st spin				
		1	2	3	4	5
2nd spin	1	(1, 1)	(2, 1)	(3, 1)	(4, 1)	(5, 1)
	2	(1, 2)	(2, 2)	(3, 2)	(4, 2)	(5, 2)
	3	(1, 3)	(2, 3)	(3, 3)	(4, 3)	(5, 3)
	4	(1, 4)	(2, 4)	(3, 4)	(4, 4)	(5, 4)
	5	(1, 5)	(2, 5)	(3, 5)	(4, 5)	(5, 5)

- ii $\frac{12}{25}$ iii $\frac{4}{25}$ iv 24 v \$68

b i

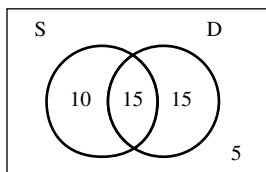

- ii 5 iii 10 iv $\frac{1}{3}$ v $\frac{4}{9}$
vi $\frac{7}{9}$, the probability a person did not buy only a sausage

2 a Yes, 52 min

- b i 12 ii 4 iii 15.5

c and e

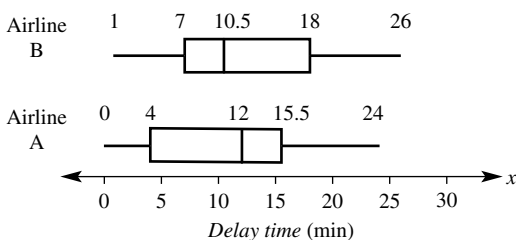

- d No, the median time is 12 min, so half the flights have less than a 12 minute delay.
f Airline A: range = 24, IQR = 11.5
Airline B: range = 25, IQR = 11
Both airlines have a very similar spread of their data when the outlier is removed.
g There is not much difference when airline A's outlier is removed. It has a marginally better performance with 75% of flights delayed less than 15.5 min compared with 18 min for airline B.

Chapter 10

10A

Building understanding

- 1 a -4 b -1 c 72
2 a no b yes c yes
d no e no f yes
3 a 1 b -3 c -2
4 a $x - 5 = 0, x = 5$
b $2x + 1 = 0, 2x = -1$ or $x = 3, x = -\frac{1}{2}$ or $x = 3$

Now you try

Example 1

- a $x^2 - 3x - 5 = 0$ b $2x^2 + 8x - 7 = 0$
c $2x^2 + 3x - 4 = 0$

Example 2

- a not a solution b is a solution

Example 3

- a $x = 0, -5$ b $x = -2, 3$ c $x = \frac{2}{3}, -\frac{5}{2}$

Exercise 10A

- 1 a $x^2 - 7x - 2 = 0$ b $x^2 - 5x + 2 = 0$
c $x^2 - 4x + 1 = 0$ d $3x^2 - 6x - 4 = 0$
e $2x^2 + 2x + 1 = 0$ f $3x^2 - 3x + 4 = 0$
g $3x^2 + 4 = 0$ h $x^2 - 3x - 1 = 0$
i $2x^2 + 5x - 10 = 0$
2 a yes b yes c no d no e yes
f no g yes h no i no
3 both are solutions
4 both are solutions
5 a 0, -1 b 0, -5 c 0, 2 d 0, 7
e -1, 3 f 4, -2 g -7, 3 h $-\frac{1}{2}, \frac{1}{2}$
i 0, -5 j $0, \frac{2}{3}$ k $0, -\frac{2}{3}$ l 0, -2
6 a $\frac{1}{2}, -2$ b $-2, \frac{1}{3}$ c $-\frac{2}{5}, -4$
d $1, \frac{1}{3}$ e $-5, -\frac{2}{7}$ f $\frac{2}{3}, -\frac{1}{5}$
g $\frac{7}{11}, \frac{13}{2}$ h $-\frac{9}{4}, \frac{7}{2}$ i $\frac{4}{3}, -\frac{1}{7}$
7 a 0, -3 b 0, 7 c 1, -4
d $\frac{1}{2}, -6$ e $-\frac{3}{2}, \frac{1}{2}$
8 a $4x^2 + x + 1 = 0$ b $3x^2 - 3x = 0$
c $3x^2 - x - 4 = 0$ d $5x^2 + x - 2 = 0$
e $2x^2 - x - 3 = 0$ f $3x^2 - 10x + 6 = 0$
g $x^2 - x - 5 = 0$ h $4x^2 - 5x - 6 = 0$
9 a -1, 2 b 1, 3 c 0, 4
d 0, -3 e -4, 1 f -4, 4
10 a $(x + 2)(x + 2) = 0$
b both solutions are the same, $x = -2$
c i -3 ii 5 iii $\frac{1}{2}$ iv $\frac{7}{5}$
11 a $(x - 1)(x + 2) = 0$ b $x = 1, x = -2$
c Multiplying by a constant doesn't change a zero value.
d i -2, 3 ii 0, -2 iii -1, 3 iv -2, 5

- 12 a i no ii no iii no iv no
 b It has no solutions as $(x-3)^2$ is always ≥ 0 , so $(x-3)^2 + 1 \geq 1$
 13 a linear b quadratic c quintic
 d cubic e quartic f quintic
 14 a $-2, -1, 3$ b $-11, 2, 5$
 c $-\frac{2}{3}, \frac{1}{5}, \frac{1}{2}$ d $-\frac{10}{7}, -\frac{4}{5}, -\frac{2}{3}, \frac{13}{2}$

10B**Building understanding**

- 1 a 8 b x c $3x$
 2 a $x(x-3)$ b $2x(3x+2)$
 c $4x(1-4x)$ d $2(x-2)(x+2)$
 3 a $x=0, x=3$ b $x=0, x=-1$
 4 $3^2 = 3 \times 3 = 9$ and $(-3)^2 = -3 \times (-3) = 9$

Now you try

Example 4

- a
- $x=0, -6$
- b
- $x=0, 5$

Example 5

- a
- $x=-7, 7$
-
- b
- $x=-\sqrt{7}, \sqrt{7}$

Exercise 10B

- 1 a $x=0, x=-3$ b $x=0, x=-7$ c $x=0, x=-4$
 d $x=0, x=5$ e $x=0, x=8$ f $x=0, x=2$
 g $x=0, x=-\frac{1}{3}$ h $x=0, x=\frac{1}{2}$
 2 a $x=0, x=3$ b $x=0, x=4$ c $x=0, x=-5$
 d $x=0, x=3$ e $x=0, x=3$ f $x=0, x=-4$
 3 a $x=0, x=3$ b $x=0, x=2$ c $x=0, x=4$
 d $x=0, x=-3$ e $x=0, x=-4$ f $x=0, x=-3$
 4 a $x=3, x=-3$ b $x=6, x=-6$
 c $x=5, x=-5$ d $x=12, x=-12$
 e $x=9, x=-9$ f $x=20, x=-20$
 5 a $x=2, x=-2$ b $x=3, x=-3$
 c $x=5, x=-5$ d $x=2, x=-2$
 e $x=\sqrt{6}, x=-\sqrt{6}$ f $x=\sqrt{5}, x=-\sqrt{5}$
 g $x=\sqrt{7}, x=-\sqrt{7}$ h $x=\sqrt{3}, x=-\sqrt{3}$
 6 a $x=2, x=-2$ b $x=5, x=-5$
 c $x=10, x=-10$ d $x=0, x=-7$
 e $x=0, x=7$ f $x=-1, x=1$
 g $x=0, x=\frac{2}{3}$ h $x=0, x=\frac{3}{5}$
 i $x=-\sqrt{3}, x=\sqrt{3}$
 7 a 0 or 7 b 8 or -8 c 0 or -4
 8 a $x=-2, x=2$ b $x=-6, x=6$
 c $x=-1, x=1$ d $x=-1, x=1$
 e $x=0, x=-7$ f $x=0, x=4$
 9 a $(x+2)(x-2) = x^2 - 4$ not $x^2 + 4$
 b no, $x^2 \geq 0$, so $x^2 + 4 \geq 4$
 10 a $ax^2 + bx = x(ax + b) = 0, x=0$ is always one solution
 b $x = -\frac{b}{a}$

- 11 a $x = -\frac{4}{3}, x = \frac{4}{3}$ b $x = -\frac{6}{5}, x = \frac{6}{5}$
 c $x = -\frac{1}{5}, x = \frac{1}{5}$ d $x = -\frac{9}{5}, x = \frac{9}{5}$
 e $x = -\frac{8}{11}, x = \frac{8}{11}$ f $x = -\frac{12}{7}, x = \frac{12}{7}$
 12 a $x = -1, x = 5$ b $x = -1, x = -9$
 c $x = -1, x = 0$ d $x = -\frac{2}{5}, x = \frac{8}{5}$
 e $x = 1, x = 7$ f $x = -1, x = \frac{13}{7}$

10C**Building understanding**

- 1 a 3, 2 b $-5, -2$ c 5, -1 d $-4, 3$
 2 a $(x+5)(x+7)$ b $(x+9)(x-5)$
 c $(x-2)(x-8)$
 3 a $(x+5)(x+4) = 0, x+5 = 0$ or $x+4 = 0, x = -5$
 or $x = -4$
 b $(x-6)(x+4) = 0, x-6 = 0$ or $x+4 = 0, x = 6$ or $x = -4$

Now you try

Example 6

- a
- $x = -2, -4$
- b
- $x = 5, -2$
- c
- $x = 6, 2$

Example 7

- a
- $x = 5$
- b
- $x = 8, -5$

Exercise 10C

- 1 a $-6, -2$ b $-8, -3$ c $-5, -2$
 2 a $-4, -6$ b $-6, -3$ c $-3, -1$ d 4, 8
 e 3, 6 f 3, 7 g $-3, 5$ h $-2, 8$
 i $-5, 9$ j 4, 6 k $-6, 7$ l $-12, 7$
 3 a -3 b -2 c -7 d -12 e 5
 f 8 g 6 h 9 i 10
 4 a $-2, 5$ b 2, 5 c 3 d $-4, 1$
 e $-7, 2$ f 4 g $-6, 2$ h $-6, 1$
 i 3, 5 j $-8, 2$ k $-4, -2$ l $-9, 2$
 5 a $-2, 3$ b $-5, -3$ c $-2, 8$
 d 2, 3 e 2 f -1
 g 5 h -3 i $-7, 1$
 6 11 am, 6 pm
 7 a $x^2 - 3x + 2 = 0$ b $x^2 - x - 6 = 0$
 c $x^2 + 3x - 4 = 0$ d $x^2 - 7x - 30 = 0$
 e $x^2 - 10x + 25 = 0$ f $x^2 + 22x + 121 = 0$
 8 a 2, 3 b 3 c $-10, 2$
 d $-5, 7$ e -1 f 2
 9 a Equation is not written in standard form $x^2 + bx + c = 0$
 so cannot apply Null Factor Law in this form.
 b $x = -2, x = 3$
 10 It is a perfect square: $(x-1)(x-1), (x-1)^2 = 0, x = 1$
 11 a $(x-a)(x-a) = 0$ or $(x-a)^2 = 0$
 b $(x-a)(x-b) = 0$
 12 a $x = -3$ or $x = -\frac{1}{5}$ b $x = \frac{2}{3}$ or $x = -2$
 c $x = \frac{1}{3}$ or $x = -\frac{1}{2}$ d $x = \frac{1}{2}$ or $x = -1$

- e $x = \frac{3}{2}$ or $x = -5$ f $x = \frac{3}{2}$
 g $x = \frac{7}{3}$ or $x = -2$ h $x = \frac{3}{5}$ or $x = -4$
 i $x = -\frac{5}{3}$

10D

Building understanding

- 1 a $-6, 3$ b $5, -4$ c $2, -5$
 2 a $x(x+2) = 8$ b $2, -4$
 c $2, \text{width} > 0$ d $l = 4 \text{ cm}, w = 2 \text{ cm}$

Now you try

Example 8
 width = 20 cm and length = 32 cm

Exercise 10D

- 1 $l = 20 \text{ cm}, w = 12 \text{ cm}$
 2 $l = 9 \text{ cm}, w = 4 \text{ cm}$
 3 $-8, 6$
 4 $-5, 12$
 5 $-2, 15$
 6 $L = 3 \text{ m}, W = 23 \text{ m}$
 7 a $A = 100 - x^2$ b $x = 6$
 8 $h = 5$
 9 a $A = x^2 + 5x + 15$ b $x = 7$
 10 a $x = 3$ (-4 not valid)
 b $x = 12$ c $x = 25$
 11 -8 not valid because dimensions must be > 0
 12 $x = -2$ or $x = 3$; both valid as both are integers
 13 a $10, 15, 21$
 b i 28 ii 210
 c i 9 ii 15
 14 a $9, 14$
 b i 8 ii 12
 15 a $A = (20 + 2x)^2 = 4x^2 + 80x + 400$
 b 10 cm
 16 4 cm

Progress quiz

- 1 a $x^2 - 3x - 8 = 0$ b $3x^2 - 4x - 6 = 0$
 c $2x^2 - 2x - 3 = 0$
 2 a $x = 2$ is not a solution b $x = -2$ is a solution
 3 a $x = 0$ or $x = 7$ b $x = 5$ or $x = -2$
 c $x = \frac{1}{3}$ or $x = \frac{3}{4}$
 4 a $x = 0$ or $x = -11$ b $x = 0$ or $x = 6$
 c $x = 0$ or $x = 4$
 5 a $x = 7$ or $x = -7$ b $x = 1$ or $x = -1$
 c $x = 2$ or $x = -2$ d $x = 3$ or $x = -3$
 6 a $x = -3$ or $x = -8$ b $x = 3$ or $x = 12$
 c $x = -5$ or $x = 7$
 7 a $x = -4$ b $x = 7$
 c $x = -3$ or $x = 8$

- 8 length 9 m; width 6 m
 9 number is -12 or 7
 10 a $x^2 - 5x + 6 = 0$ b $x^2 - 5x - 6 = 0$
 c $x^2 + 6x + 9 = 0$

10E

Building understanding

- 1 a highest b parabola c intercepts
 d vertex e lowest f zero
 2 a $x = 3$ b $x = 1$ c $x = -2$

Now you try

- Example 9
 a $x = 4$ b maximum c $(4, 6)$
 d $(2, 0), (6, 0)$ e $(0, -18)$

Example 10

a

x	-3	-2	-1	0	1	2	3
y	0	-5	-8	-9	-8	-5	0

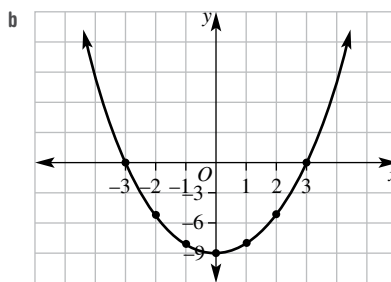

- c i minimum ii $x = 0$ iii $(0, -9)$
 iv $(0, -9)$
 v $(-3, 0)$ and $(3, 0)$

Exercise 10E

1

	i	ii	iii	iv	v
a	$x = 2$	minimum	$(2, -1)$	$(1, 0), (3, 0)$	$(0, 3)$
b	$x = 0$	minimum	$(0, -4)$	$(-2, 0), (2, 0)$	$(0, -4)$
c	$x = 0$	maximum	$(0, 3)$	$(-1, 0), (1, 0)$	$(0, 3)$
d	$x = 0$	maximum	$(0, 4)$	$(-2, 0), (2, 0)$	$(0, 4)$
e	$x = 2$	minimum	$(2, 1)$	none	$(0, 4)$
f	$x = -1$	maximum	$(-1, 7)$	$(-4, 0), (2, 0)$	$(0, 6)$
g	$x = 0$	minimum	$(0, 0)$	$(0, 0)$	$(0, 0)$
h	$x = 0$	minimum	$(0, -4)$	$(-2, 0), (2, 0)$	$(0, -4)$
i	$x = 3$	maximum	$(3, 4)$	$(1, 0), (5, 0)$	$(0, -5)$
j	$x = 3$	minimum	$(3, -\frac{1}{2})$	$(2, 0), (4, 0)$	$(0, 4)$
k	$x = 0$	maximum	$(0, 2)$	$(-1, 0), (1, 0)$	$(0, 2)$
l	$x = -2$	maximum	$(-2, -1)$	none	$(0, -4)$

2 a $y = x^2 - 1$

x	-2	-1	0	1	2
y	3	0	-1	0	3

b, c

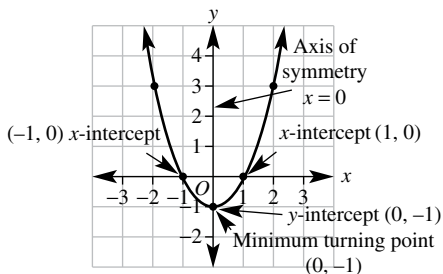

3 a $y = x^2 + 2x - 3$

x	-4	-3	-2	-1	0	1	2
y	5	0	-3	-4	-3	0	5

b, c

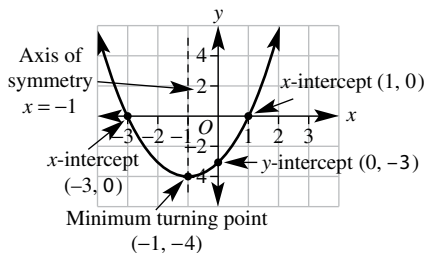

4 a $y = 9 - x^2$

x	-3	-2	-1	0	1	2	3
y	0	5	8	9	8	5	0

b, c

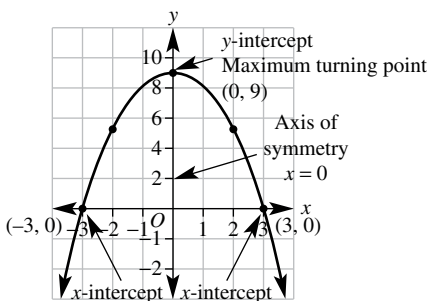

5 a $y = -x^2 + x + 2$

x	-2	-1	0	1	2	3
y	-4	0	2	2	0	-4

b, c

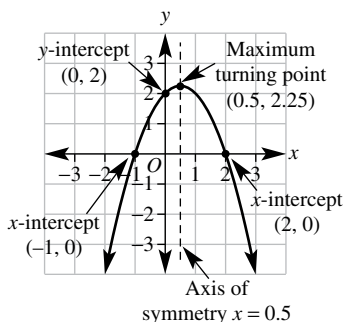

6 a i 1 s, 3 s

ii one time is on the way up, the other is on the way down

b i 2 s

ii 12 m

iii 4 s

7 a 100 m

b 155 m

c 5 s

d journey takes 1 s longer to go down to the ground

8 a $x = 1$

b (1, -3)

9 a $x = 1$

b (2, 0)

10 a $y = x^2$

b $y = x^2 - 4$

c $y = 1 - x^2$

d $y = x^2 - 2x + 1$

e $y = -x^2 - 2x$

f $y = x^2 - 3x - 4$

11 a Yes

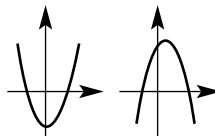

Two x-intercepts

b Yes

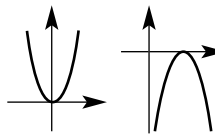

One x-intercept

c Yes

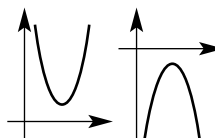

Zero x-intercepts

d No

12 a $-2^2 = -1 \times 2^2 = -4$. It is not $(-2)^2 = 4$, so correct solution is $y = -2^2 + 2 \times 2 = -4 + 4 = 0$

b $-(-3)^2 = -1 \times 9 = -9$. It is not $(-3)^2 = +9$, so correct solution is $y = -3 - (-3)^2 = -3 - 9 = -12$

13 a $x = -2, x = 2$

b $x = 0$

c i infinite

ii one

iii none

14 a i $x = 0, x = 2$

ii $x = -1, x = 3$

b two; a parabola is symmetrical

c one; this is the minimum turning point

d none; -1 is the minimum y-value so there are no values of y less than -1

15 Answers may vary.

10F

Building understanding

- 1 a $y = 3x^2, y = x^2, y = \frac{1}{2}x^2$
 b $y = -3x^2, y = -x^2, y = -\frac{1}{2}x^2$
 c (0, 0) d $x = 0$
 e i $y = 3x^2$ ii $y = \frac{1}{2}x^2$
 iii $y = -3x^2$ iv $y = -\frac{1}{2}x^2$
 f i $y = -x^2$ ii $y = -3x^2$ iii $y = \frac{1}{2}x^2$
- 2 a positive
 b negative

Now you try

Example 11

a

x	-2	-1	0	1	2
$y = x^2$	4	1	0	1	4
$y = 4x^2$	16	4	0	4	16
$y = \frac{1}{4}x^2$	1	$\frac{1}{4}$	0	$\frac{1}{4}$	1

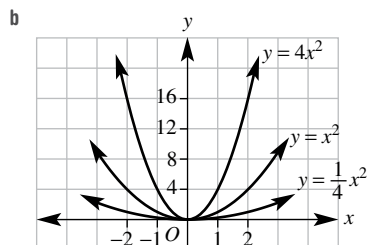

- c axis of symmetry: $x = 0$, turning point (0, 0)
 d i narrower
 ii wider

Example 12

a

x	-2	-1	0	1	2
$y = -x^2$	-4	-1	0	-1	-4
$y = -4x^2$	-16	-4	0	-4	-16
$y = -\frac{1}{4}x^2$	-1	$-\frac{1}{4}$	0	$-\frac{1}{4}$	-1

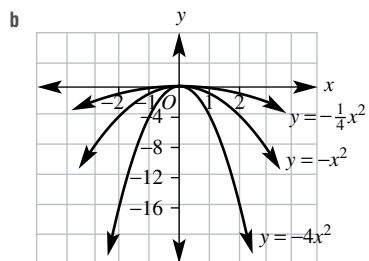

- c axis of symmetry: $x = 0$, turning point (0, 0)
 d i narrower
 ii wider

Exercise 10F

1 a

x	-2	-1	0	1	2
$y = x^2$	4	1	0	1	4
$y = 3x^2$	12	3	0	3	12
$y = \frac{1}{3}x^2$	$\frac{4}{3}$	$\frac{1}{3}$	0	$\frac{1}{3}$	$\frac{4}{3}$

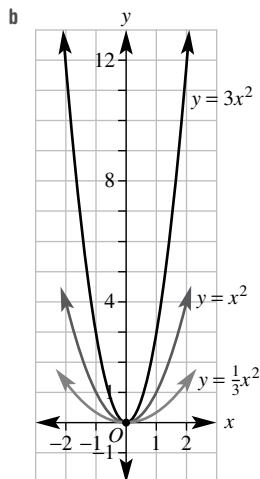

- c For all three graphs, the turning point is a minimum at (0, 0) and the axis of symmetry is $x = 0$.
 d i narrower
 ii wider

2 a i

x	-2	-1	0	1	2
y	24	6	0	6	24

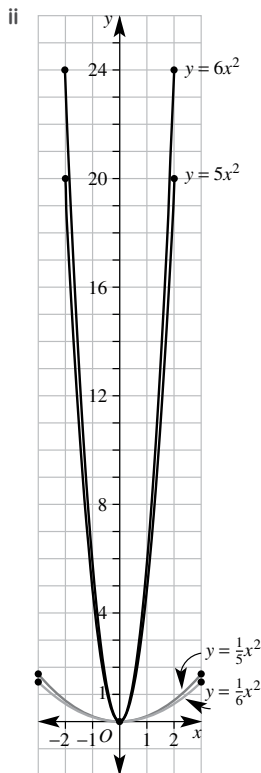

iii axis of symmetry: $x = 0$; turning point: $(0, 0)$

iv narrower

b i

x	-2	-1	0	1	2
y	20	5	0	5	20

ii See part b.

iii axis of symmetry: $x = 0$; turning point: $(0, 0)$; x - and y -intercept: $(0, 0)$

iv narrower

c i

x	-2	-1	0	1	2
y	$\frac{2}{3}$	$\frac{1}{6}$	0	$\frac{1}{6}$	$\frac{2}{3}$

ii See part a.

iii axis of symmetry: $x = 0$; turning point: $(0, 0)$

iv wider

d i

x	-2	-1	0	1	2
y	$\frac{4}{5}$	$\frac{1}{5}$	0	$\frac{1}{5}$	$\frac{4}{5}$

ii See part a.

iii axis of symmetry: $x = 0$; turning point: $(0, 0)$

iv wider

3 a i

x	-2	-1	0	1	2
y	-8	-2	0	-2	-8

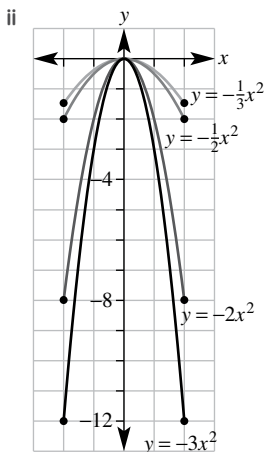

iii axis of symmetry: $x = 0$; turning point: $(0, 0)$; x - and y -intercept: $(0, 0)$

iv narrower

b i

x	-2	-1	0	1	2
y	-12	-3	0	-3	-12

ii See part a.

iii axis of symmetry: $x = 0$; turning point: $(0, 0)$; x - and y -intercept: $(0, 0)$

iv narrower

c i

x	-2	-1	0	1	2
y	-2	$-\frac{1}{2}$	0	$-\frac{1}{2}$	-2

ii See part a.

iii axis of symmetry: $x = 0$; turning point: $(0, 0)$; x - and y -intercept: $(0, 0)$

iv wider

d i

x	-2	-1	0	1	2
y	$-\frac{4}{3}$	$-\frac{1}{3}$	0	$-\frac{1}{3}$	$-\frac{4}{3}$

ii See part a.

iii axis of symmetry: $x = 0$; turning point: $(0, 0)$; x - and y -intercept: $(0, 0)$

iv wider

4 a A b H

5 a D b C c A

d E e F f B

6 a reflection in the x -axis, dilaton by a factor of 3 from the x -axis

b reflection in the x -axis, dilaton by a factor of 6 from the x -axis

c reflection in the x -axis, dilaton by a factor of $\frac{1}{2}$ from the x -axis

d reflection in the x -axis, dilaton by a factor of 2 from the x -axis

e reflection in the x -axis, dilaton by a factor of 3 from the x -axis

f reflection in the x -axis, dilaton by a factor of $\frac{1}{3}$ from the x -axis

7 a $y = -4x^2$ b $y = \frac{1}{3}x^2$

c $y = -4x^2$ d $y = -\frac{4}{3}x^2$

8 No, because both transformations are multiplying to 'a' and multiplication is commutative: $bc = cb$

9 $y = ax^2$, has y -axis as axis of symmetry so it is symmetrical about the y -axis

10 a $y = 5x^2$ b $y = 7x^2$

c $y = x^2$ d $y = \frac{7}{4}x^2$

e $y = \frac{4}{25}x^2$ f $y = \frac{26}{9}x^2$

g $y = 5x^2$ h $y = -52x^2$

11 $y = \frac{67}{242064}x^2$

10G

Building understanding

1 a i $(-2, 0)$ ii $(3, 0)$

b left c right

2 a i $(0, -3)$ ii $(0, 2)$

b down c up

3 a $(0, 3)$ b $(0, -4)$ c $(0, -4)$ d $(0, 25)$

Now you try

Example 13

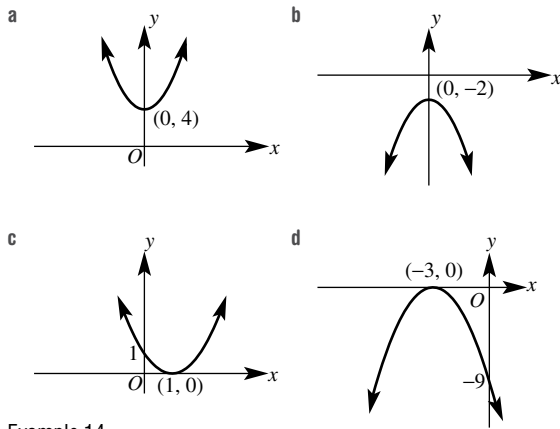

Example 14

a and b

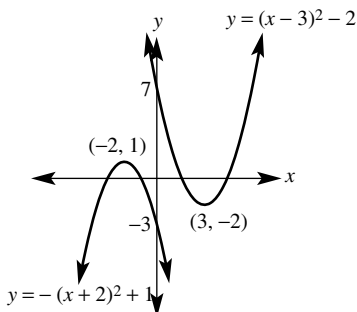

Exercise 10G

- 1 a $y = x^2 + 1$ b $y = x^2 + 3$ c $y = x^2 - 2$

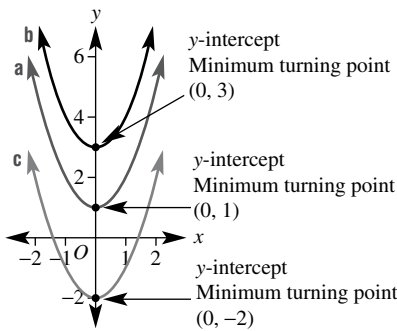

- d $y = -x^2 + 4$ e $y = -x^2 + 1$ f $y = -x^2 - 5$

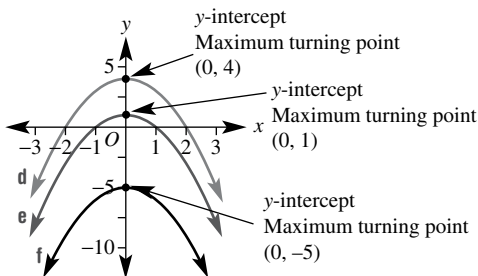

- 2 a $y = (x - 2)^2$ b $y = (x - 4)^2$ c $y = (x + 3)^2$

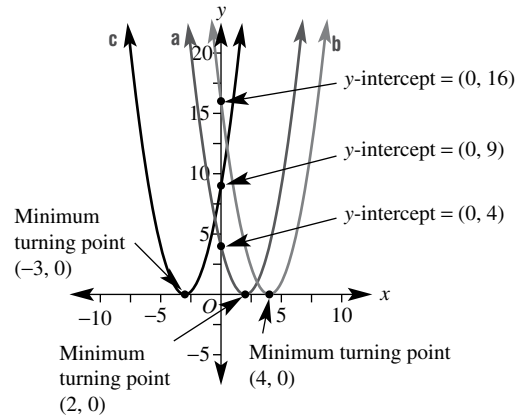

- d $y = -(x - 3)^2$ e $y = -(x + 6)^2$ f $y = -(x + 2)^2$

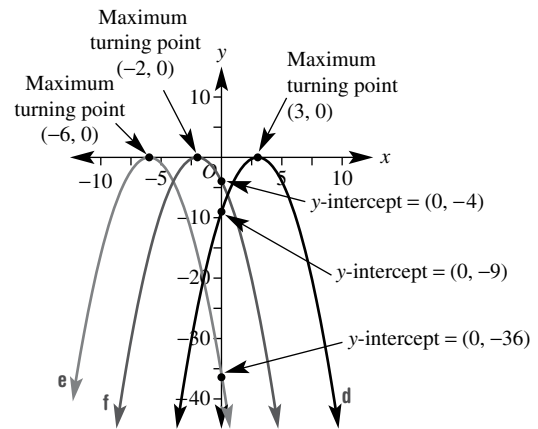

- 3 a i (2, 3) ii (-1, -1)
 b i one, left, one, down ii two, right, three, up
 4 a $y = (x - 3)^2 + 2$

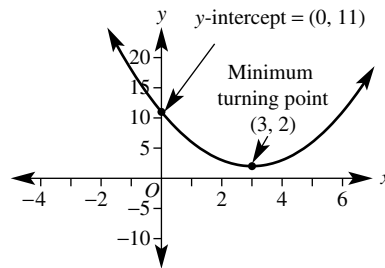

- b $y = (x - 1)^2 - 1$

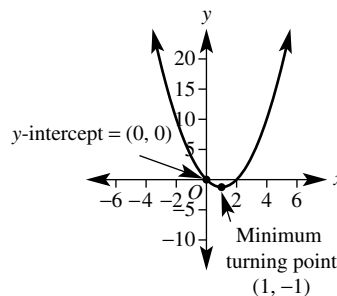

c $y = (x + 2)^2 - 3$

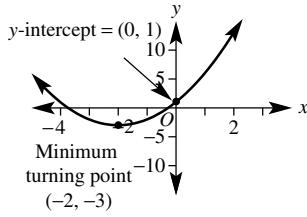

d $y = (x + 1)^2 + 7$

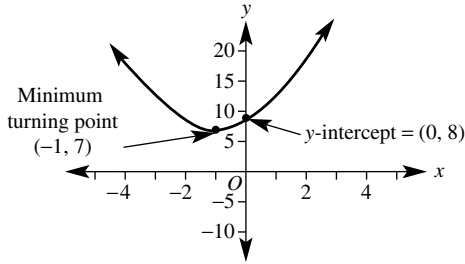

e $y = -(x - 2)^2 + 1$

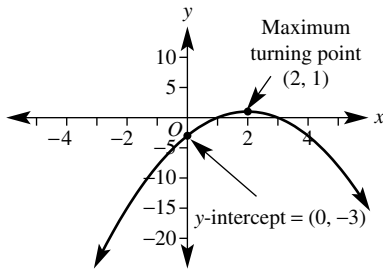

f $y = -(x - 5)^2 + 3$

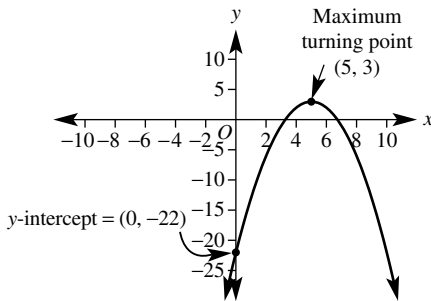

g $y = -(x + 3)^2 - 4$

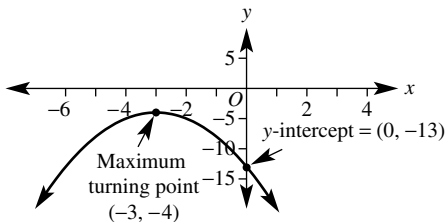

h $y = -(x + 1)^2 - 5$

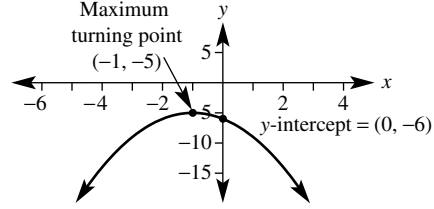

i $y = -(x - 3)^2 - 6$

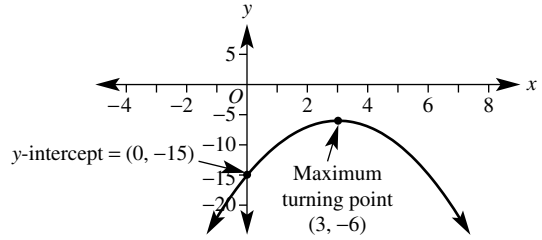

- 5 a J b D c B d H e K f G
g A h E i L j I k F l C

- 6 a $y = (x - 1)^2 + 1$ b $y = (x + 2)^2 + 2$
c $y = (x + 1)^2 - 3$ d $y = -(x - 1)^2 + 4$
e $y = -(x - 2)^2 - 2$ f $y = -(x + 2)^2 + 4$

- 7 a $y = -(x - 2)^2 + 9$, turning point (2, 9)
 $y = (x - 7)^2 - 4$, turning point (7, -4)

b

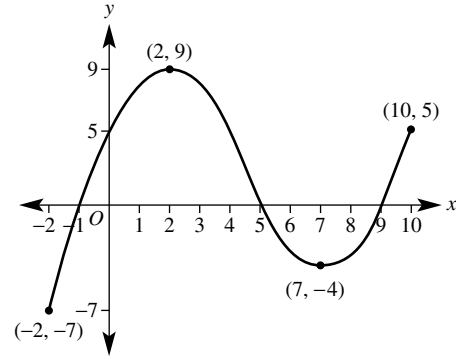

- 8 a i $y = -(x + 1)^2 + 3$ ii $y = (x + 3)^2 + 4$
iii $y = (x - 1)^2 - 3$ iv $y = -(x - 5)^2 - 7$
v $y = -x^2 - 2$ vi $y = x^2 - 6$

- b i (-1, 3) ii (-3, 4) iii (1, -3)
iv (5, -7) v (0, -2) vi (0, -6)

- 9 a (h, k) b $y = ah^2 + k$

- 10 a $(2 - x)^2 = (-1(x - 2))^2 = (-1)^2(x - 2)^2 = (x - 2)^2$, so graphs are the same

b graphs are the same

- 11 a $y = x^2 + 3$ b $y = x^2 - 4$
c $y = x^2 - 3$ d $y = x^2 - 5$
12 a $y = -x^2 + 4$ b $y = -x^2 + 4$
c $y = -x^2 + 24$ d $y = -x^2 + 10$

- 13 a $y = (x + 3)^2$ or $y = (x - 5)^2$
b $y = (x - 2)^2$ or $y = (x - 4)^2$

c $y = (x + 4)^2$ or $y = (x - 2)^2$

d $y = x^2$ or $y = (x - 6)^2$

14 a $y = -(x - 1)^2 + 1$

b $y = (x + 2)^2$

c $y = -(x - 3)^2$

d $y = -(x + 3)^2 + 2$

e $y = (x + 1)^2 + 4$

f $y = (x - 3)^2 - 9$

10H

Building understanding

1 a $x(x + 2)$

b $x(x - 3)$

c $(x + 3)(x - 3)$

d $(x + 7)(x - 7)$

e $(x - 4)(x + 3)$

f $(x - 2)(x - 2) = (x - 2)^2$

2 a 0

b -3

c -1

d -0.5

3 a -4

b -9

c -1

Now you try

Example 15

a i (0, 0), (-5, 0)

ii (0, 0)

b i (-1, 0), (4, 0)

ii (0, -12)

Example 16

a (0, 0)

b $y = x(x - 4)$

c (0, 0), (4, 0)

d $x = 2$

e (2, -4)

f

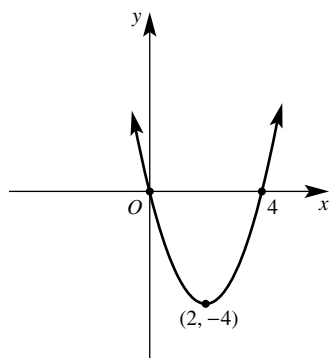

Example 17

a (0, -12)

b $y = (x - 6)(x + 2)$

c (6, 0), (-2, 0)

d $x = 2$

e (2, -16)

f

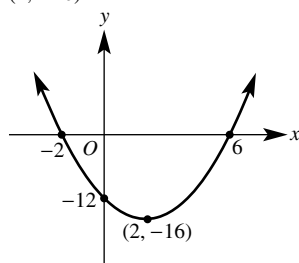

Exercise 10H

1 a i (0, 0), (-7, 0)

ii (0, 0)

b i (0, 0), (-3, 0)

ii (0, 0)

c i (0, 0), (-4, 0)

ii (0, 0)

d i (4, 0), (-2, 0)

ii (0, -8)

e i (-2, 0), (5, 0)

ii (0, -10)

f i (-3, 0), (7, 0)

ii (0, -21)

g i (-3, 0), (1, 0)

ii (0, -6)

h i (-4, 0), (-1, 0)

ii (0, 12)

i i (2, 0), (3, 0)

ii (0, 6)

2 a $y = x(x - 5)$

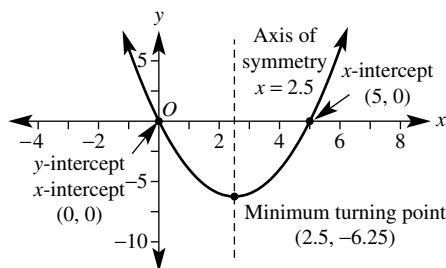

b $y = x(x + 1)$

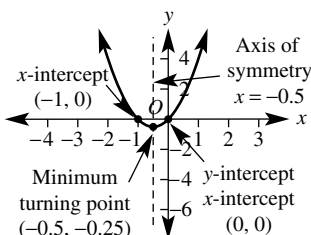

c $y = x(x - 3)$

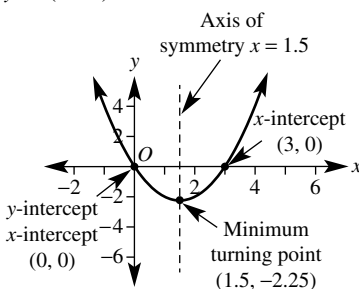

d $y = x(2 + x)$

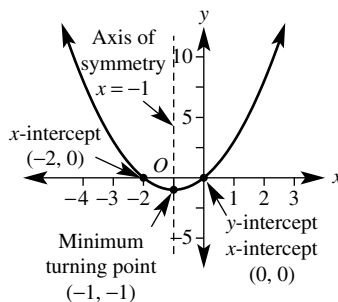

e $y = x(5 + x)$

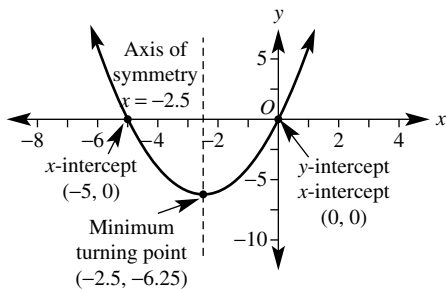

f $y = x(3 - x)$

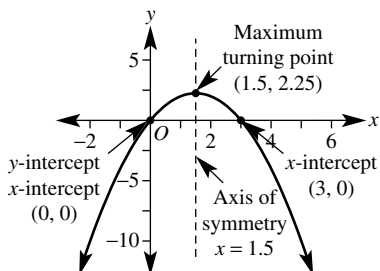

g $y = -x(x + 8)$

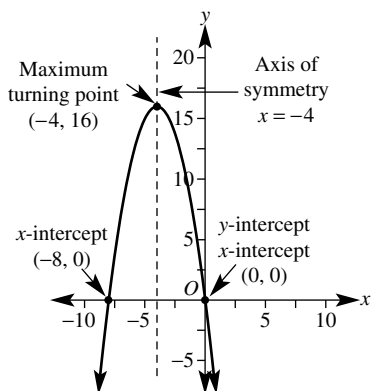

h $y = -x(2 + x)$

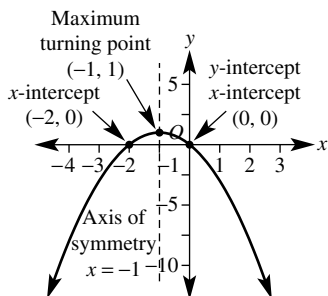

i $y = -x(x - 1)$

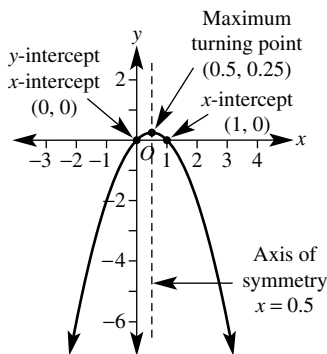

3 a $y = (x - 2)(x - 1)$

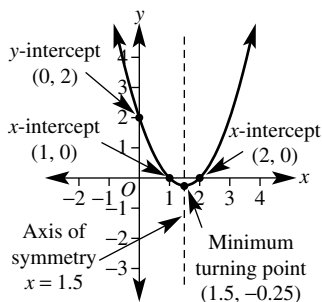

b $y = (x - 3)(x - 1)$

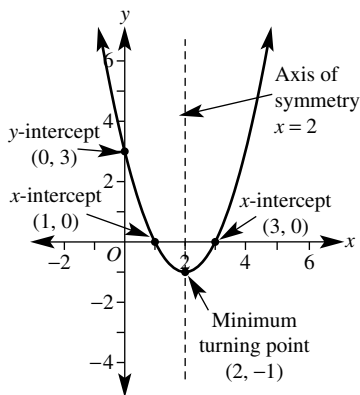

c $y = (x + 3)(x - 1)$

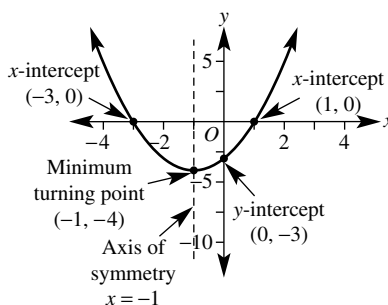

d $y = (x + 2)^2$

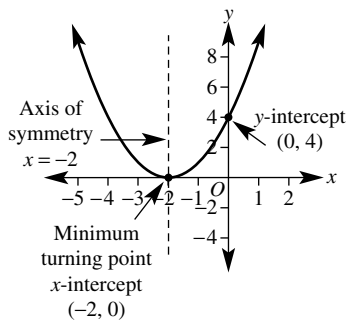

b $y = 9 - x^2$

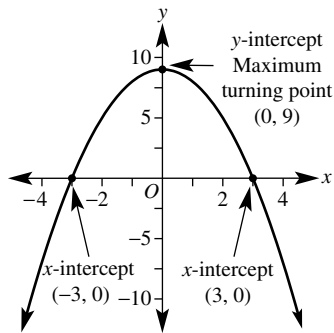

e $y = (x + 1)^2$

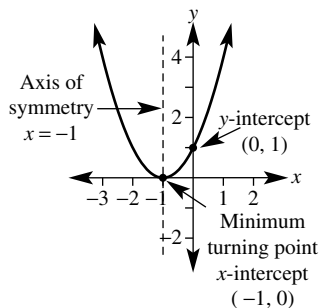

c $y = x^2 + 5x$

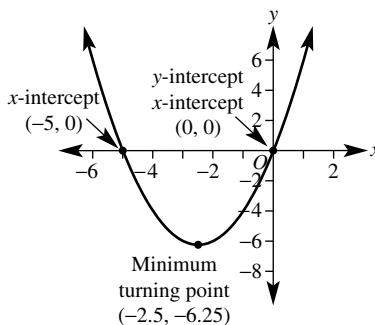

f $y = (x + 4)(x - 2)$

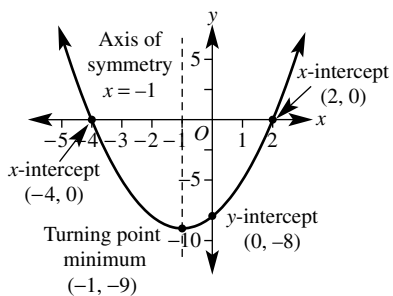

d $y = 2x^2 - 6x$

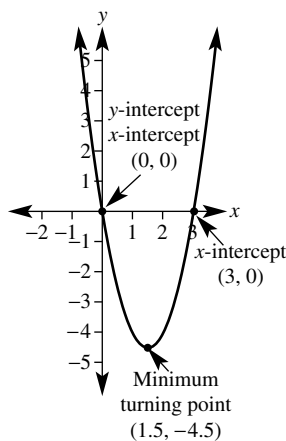

4 a $y = x^2 - 1$

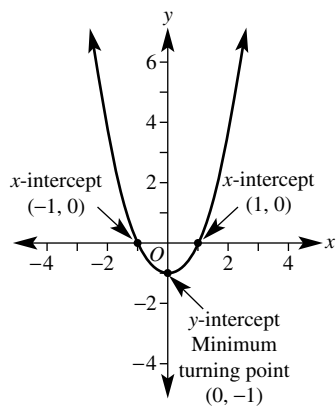

e $y = 4x^2 - 8x$

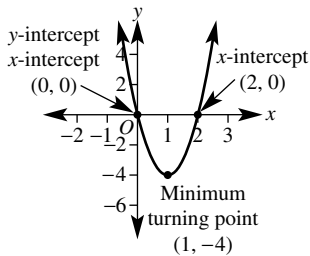

f $y = x^2 - 3x - 4$

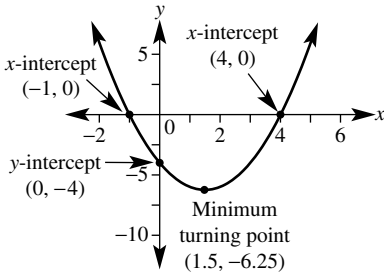

g $y = x^2 + x - 12$

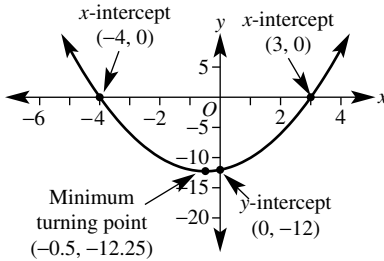

h $y = x^2 + 2x + 1$

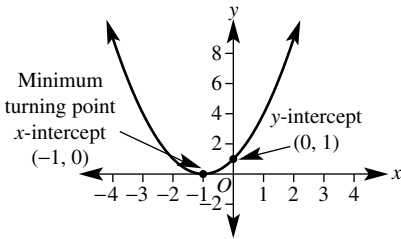

i $y = x^2 - 6x + 9$

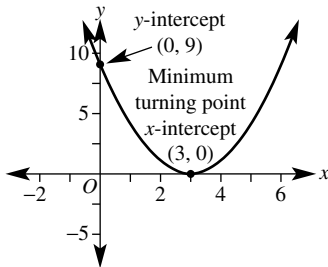

- 5 a -3 b 2 c 3
 d -4 e -5 f 6

- 6 a 30 m b 225 m
 7 a 200 m b 1000 m

8 There is only one x -intercept so this must be the turning point.

- 9 a $y = c$
 b $y = ab$

10 a $(1, -16)$

b $(5, 0), (-3, 0)$, turning point x -coordinate: $\frac{5 + (-3)}{2} = 1$, turning point $(1, -16)$

c $y = (x - 2)^2 - 49, h = 2, k = -49$

11 b $y = (x + 3)(x - 1)$

d $y = -(x + 1)(x - 5)$

f $y = \frac{1}{2}(x + 8)(x - 2)$

c $y = 2(x + 5)(x - 1)$

e $y = -(x + 8)(x + 2)$

g $y = -\frac{1}{3}(x + 3)(x - 7)$

Problems and challenges

1 a They are square numbers.

b $100^2 = 10000$

2 a $\frac{5}{3}, -\frac{7}{2}$

b 2, -1

c $2^{\frac{2}{3}} + 1$

3 6 seconds

4 $\frac{n(n+1)}{2}, n = 11$

5 $x = 2$

6 a 20 units, 21 units, 29 units

b 17 units

7 a $k < 0$

b $k = 0$

c $k > 0$

8 a 10, -10, 11, -11, 14, -14, 25, -25

b 2, -2, 5, -5, 10, -10, 23, -23

9 $x = -3, 1, 2, 6$

10 $x = -3, -1, 1, 3$

Success criteria example questions

1 $x^2 - 3x - 6 = 0$

2 Yes, $x = -2$ is a solution

3 $x = -2$ or $x = 5$

4 $x = 0$ or $x = 5$

5 $x = \pm 2$

6 $x = 10$ or $x = -7$

7 $x = 4$ or $x = 5$

8 Width = 7 cm, length = 12 cm

9 i $x = 1$

ii Minimum turning point $(1, -4)$

iii x -intercepts: $(-1, 0)$ and $(3, 0)$; y -intercept: $(0, -3)$

x	-3	-2	-1	0	1	2	3
y	25	16	9	4	1	0	1

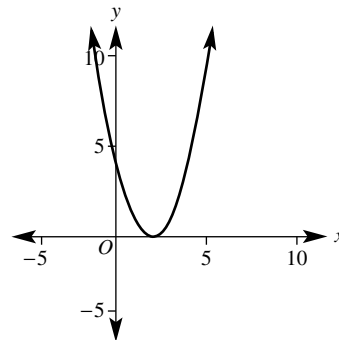

x	-2	-1	0	1	2
$y = x^2$	4	1	0	1	4
$y = 3x^2$	12	3	0	3	12
$y = \frac{1}{3}x^2$	$1\frac{1}{3}$	$\frac{1}{3}$	0	$\frac{1}{3}$	$1\frac{1}{3}$

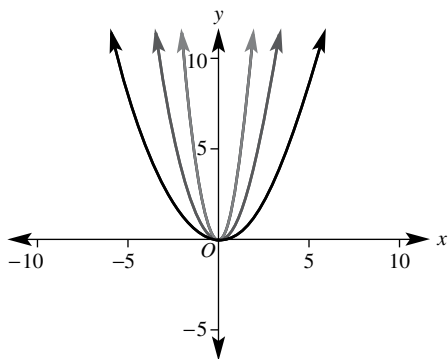

Turning point of each graph: minimum at (0, 0)
 The graph of $y = 3x^2$ appears narrower than the graph of $y = x^2$
 The graph of $y = \frac{1}{3}x^2$ appears wider than the graph of $y = x^2$

12

x	-2	-1	0	1	2
$y = -x^2$	-4	-1	0	-1	-4
$y = -4x^2$	-16	-4	0	-4	-16
$y = -\frac{1}{4}x^2$	-1	$-\frac{1}{4}$	0	$-\frac{1}{4}$	-1

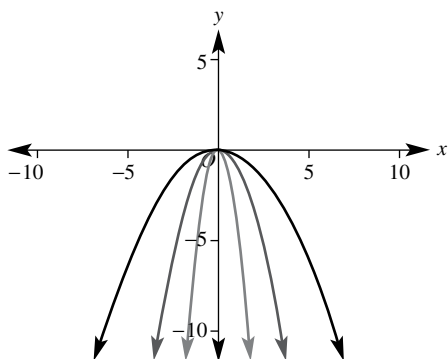

Turning point of each graph: maximum at (0, 0)
 The graph of $y = -4x^2$ appears narrower than the graph of $y = -x^2$
 The graph of $y = -\frac{1}{4}x^2$ appears wider than the graph of $y = -x^2$

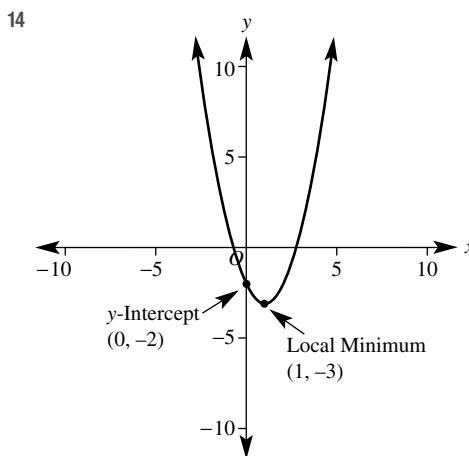
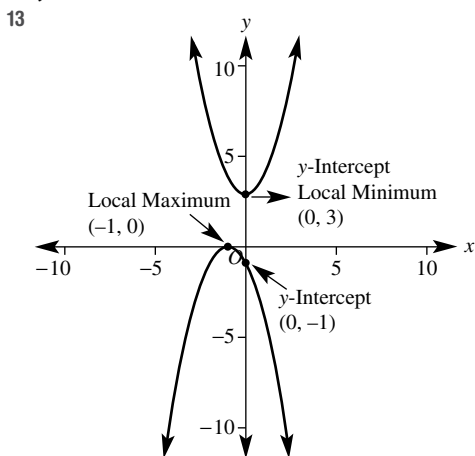

15 x -intercepts: (0, 0) and (6, 0)
 y -intercept: (0, 0)
 turning point: (3, -9)

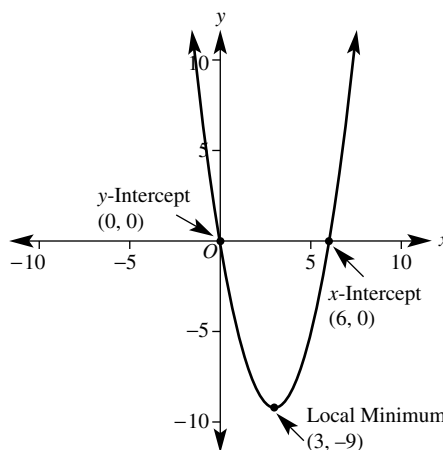

16 x -intercepts: (-2, 0) and (6, 0)
 y -intercept: (0, -12)
 turning point: (2, -16)

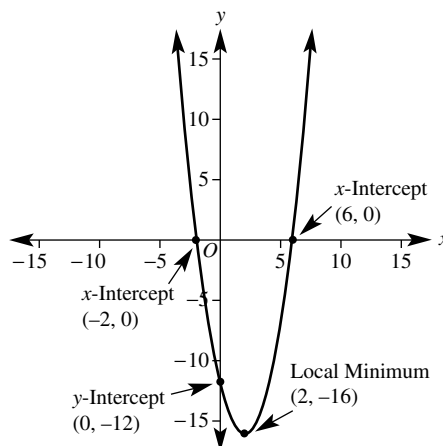

Short-answer questions

1 a $y = x^2 - 2x - 3$

x	-3	-2	-1	0	1	2	3
y	12	5	0	-3	-4	-3	0

b

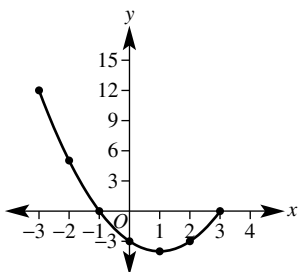

- 2 a 0, -2 b 0, 4 c -3, 7
 d 2, -2 e $-1, \frac{2}{5}$ f $\frac{1}{2}, \frac{4}{3}$
 3 a 0, -3 b 0, 4 c -5, 5
 d -9, 9 e -2, 2 f $-\sqrt{10}, \sqrt{10}$
 g -3, -7 h -5, 8 i 4

- 4 a $x^2 - 5x = 0; x = 0, 5$
 b $3x^2 - 18x = 0; x = 0, 6$
 c $x^2 + 8x + 12 = 0; x = -6, -2$
 d $x^2 - 2x - 15 = 0; x = -3, 5$
 e $x^2 - 8x + 15 = 0; x = 3, 5$
 f $x^2 + 3x - 4 = 0; x = -4, 1$
 5 a $x^2 + 2x - 80 = 0; x = 8$ units
 b $x^2 + 5x - 24 = 0; x = 3$ units
 6 a i $x = 3$ ii minimum (3, -2)
 b i $x = -1$ ii maximum (-1, 3)
 7 a $y = 2x^2$ b $y = -x^2 + 2$ c $y = (x + 1)^2$
 d $y = (x - 3)^2$ e $y = x^2 - 4$

8 a $y = x^2 + 2$

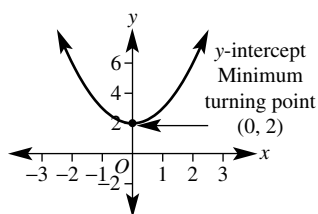

b $y = -x^2 - 5$

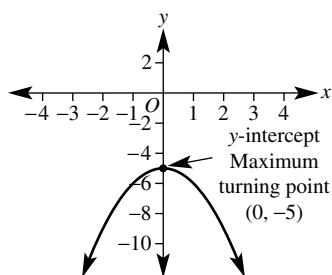

c $y = (x + 2)^2$

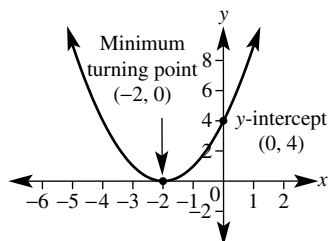

d $y = -(x - 3)^2$

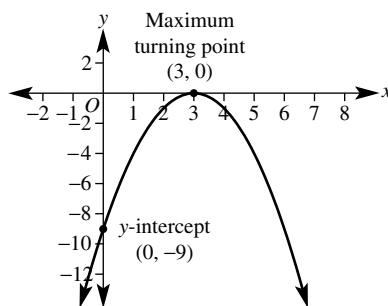

e $y = (x - 1)^2 + 3$

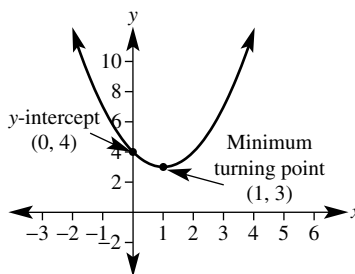

f $y = 2(x + 2)^2 - 4$

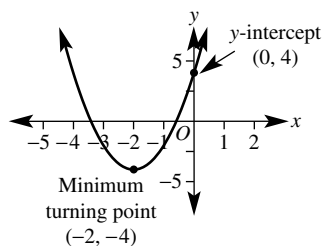

- 9 a $y = x^2$ translated up 2 units
 b $y = x^2$ reflected in the x -axis and translated down 5 units
 c $y = x^2$ translated 2 units left
 d $y = x^2$ reflected in the x -axis then translated 3 units right
 e $y = x^2$ translated 1 unit right then 3 units up
 f $y = x^2$ dilated by a factor of 2 from the x -axis, translated 2 units left and then down 4 units

10 a $y = x^2 - 8x + 12$

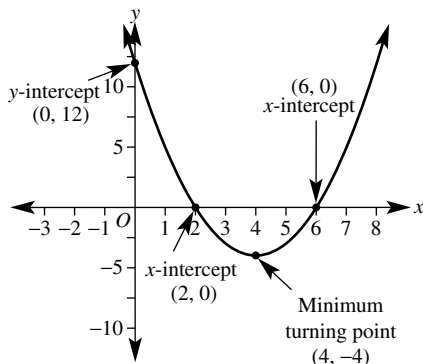

b $y = x^2 + 10x + 16$

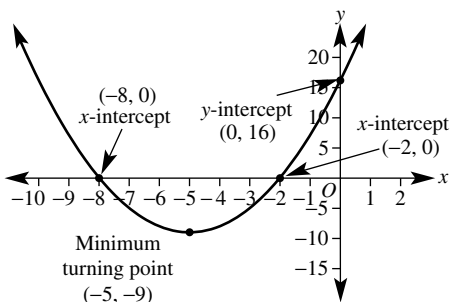

c $y = x^2 + 2x - 15$

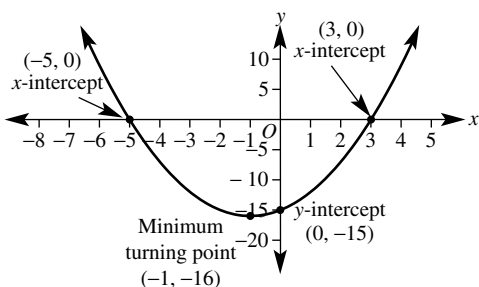

d $y = x^2 + 4x - 5$

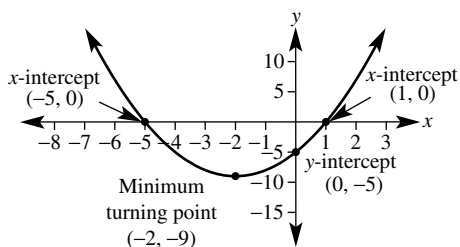

Multiple-choice questions

- 1 D 2 B 3 C 4 A 5 D
6 B 7 E 8 C 9 A 10 B

Extended-response questions

- 1 a $x + 5$ b $A = x^2 + 5x$
c $x = 2$ ($x = -7$ not valid as $x > 0$)
d base = 4 m, height = 7 m
2 a i (0, 0), (6, 0) ii maximum at (3, 18)
iii

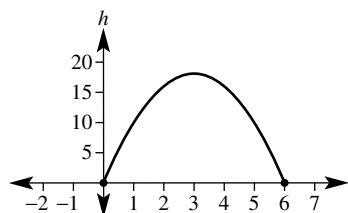

- b i (0, 0) ii (4, 16) iii (0, 0), (8, 0)

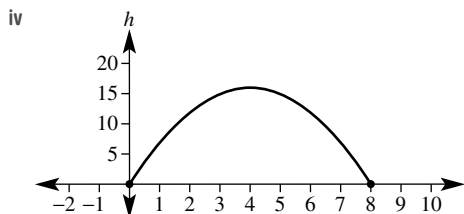

- c i Connor's rocket, 8 s
ii Sam's rocket, 2 m higher
iii 16 m, the same height

Semester review 2

Indices and surds

Short-answer questions

- 1 a $\frac{a^2b}{2}$ c $8x^6 - 2$
b $2x^3y^5$
2 a $5m^2$ b $\frac{2a^8}{3b^5}$ c $\frac{3x^2}{y}$
3 a 3.07×10^{-2} kg b 4.24×10^6 kg
c 1.22×10^4 seconds d 2.35×10^{-7} seconds
4 a 12 b 3
c $2\sqrt{3} + 7\sqrt{5}$ d $\sqrt{7}$

Multiple-choice questions

- 1 C 2 B 3 D 4 E 5 C

Extended-response questions

- a i 74 000 000 000 ii 7.4×10^{10}
b 1.87×10^{17} c 8.72×10^{-7}

Geometry

Short-answer questions

- 1 a $a = 100, b = 140$ b $a = 70, b = 55$
c $x = 67, y = 98$ d $x = 35$
2 85°

- 3 $CB = CD$ (given equal sides)
 $\angle ACB = \angle ACD$ (given equal angles)
 AC is common
 $\therefore \triangle ABC \equiv \triangle ADC$ (SAS)

- 4 a AAA b 2.4

Multiple-choice questions

- 1 C 2 B 3 A 4 E 5 B

Extended-response question

- a $\angle ABD = \angle ECD$ (given right angles)
 $\angle ADB = \angle EDC$ (common angle)
 $\angle DAB = \angle DEC$ (corresponding angles in parallel lines are equal)
 $\therefore \triangle ABD \equiv \triangle ECD$ (AAA)
- b 7.5 m c 3.75 m d 4.3 m

Algebraic techniques

Short-answer questions

- 1 a $x^2 - 9$ b $x^2 + 4x + 4$
 c $6x^2 - 17x + 12$
- 2 a $2ab(4 + a)$ b $(3m - 5)(3m + 5)$
 c $3(b - 4)(b + 4)$ d $(a + 4)(a + 10)$
 e $(x + 3)^2$ f $(x - 2)(x + 10)$
 g $2(x - 3)(x - 5)$ h $(2x - 3)(x - 4)$
 i $(2x - 1)(3x + 4)$
- 3 a $(x - 3)(x - 1)$ b $(x + 2)(2x - 5)$
- 4 a i $\frac{3}{2}$ ii $\frac{4}{x + 3}$
 iii $\frac{13x + 21}{14}$ iv $\frac{1}{3x}$
 v $\frac{11x - 10}{(x + 1)(x - 2)}$ vi $\frac{2x + 25}{(x - 5)(x + 2)}$
- b i $x = \frac{17}{12}$ ii $x = -11$

Multiple-choice questions

- 1 E 2 D 3 B 4 A 5 D

Extended-response question

- a $10 - 2x$ and $8 - 2x$
 b $(10 - 2x)(8 - 2x) = 80 - 36x + 4x^2$
 c 48 m^2
 d $4(x - 4)(x - 5)$
 e Area of rug is 0 as it has no width.

Probability and statistics

Short-answer questions

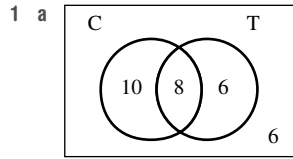

- b i 24 ii 16
 c i $\frac{1}{5}$ ii $\frac{1}{3}$

- 2 a Outcome

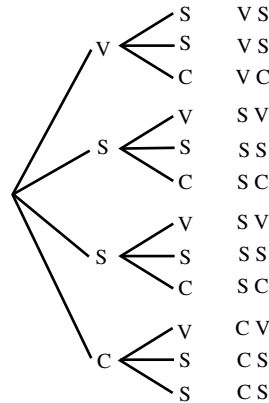

- b i $\frac{1}{3}$ ii $\frac{1}{6}$ iii $\frac{1}{2}$

- 3 a stratified b systematic

- 4 a numerical discrete

b

Stem	Leaf
1	0 1 1 2 3 5 7 8
2	2 5 5 5 6
3	1 2 2

1 | 3 means 13 aces

- c mode = 25, median = 20
 d positively skewed

- 5 a

Class interval	Frequency	Percentage frequency
0–	2	6.7
50–	4	13.3
100–	5	16.7
150–	9	30
200–	7	23.3
250–	3	10
Total	30	100

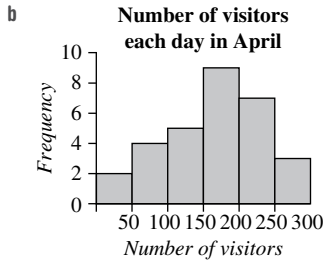

c i 6 ii 60%

Multiple-choice questions

1 D 2 A 3 C 4 B 5 C

Extended-response question

a

		Red		
		1	2	3
Green	1	(1, 1)	(1, 2)	(1, 3)
	2	(2, 1)	(2, 2)	(2, 3)
	3	(3, 1)	(3, 2)	(3, 3)

b $\frac{4}{9}$

c i $\frac{1}{3}$

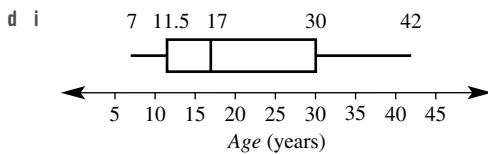

ii 11.5 years iii 90

Introduction to quadratic equations and graphs

Short-answer questions

- 1 a $x = -5$ or $x = 3$ b $x = \frac{1}{2}$ or $x = -\frac{5}{3}$
 c $x = 0$ or $x = -2$ d $x = -3$ or $x = 3$
 e $x = 2$ or $x = 7$ f $x = -4$
- 2 15 m by 8 m
- 3 a translated 3 units up

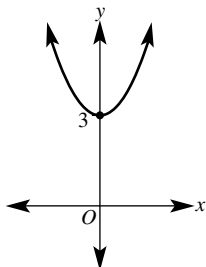

b reflected in the x -axis and translated 4 units left

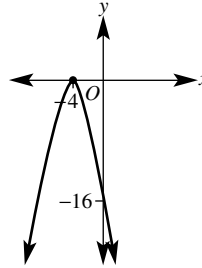

c translated 2 units right and 5 units up

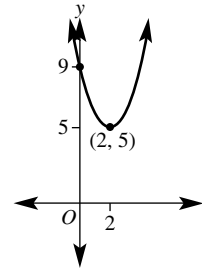

4 a (0, -12) b (-2, 0), (6, 0) c (2, -16)

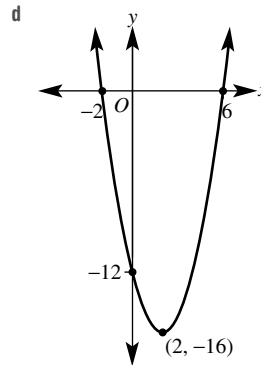

Multiple-choice questions

1 B 2 B 3 E 4 C 5 E

Extended-response question

- a Lands after 6 seconds.
 b i 180 cm ii 3 seconds
 c after 2 seconds and 4 seconds
 d

