



Victorian Certificate of Education 2013

SUPERVISOR TO ATTACH PROCESSING LABEL HERE

STUDENT NUMBER

Letter

Figures										
Words										

PHYSICS

Written examination

Wednesday 13 November 2013

Reading time: 9.00 am to 9.15 am (15 minutes)

Writing time: 9.15 am to 11.45 am (2 hours 30 minutes)

QUESTION AND ANSWER BOOK

Structure of book

Section	Number of questions	Number of questions to be answered		Number of marks
A – Core studies	23	23		128
	<i>Number of detailed studies</i>	<i>Number of detailed studies to be answered</i>	<i>Number of questions to be answered</i>	<i>Number of marks</i>
B – Detailed studies	6	1	11	22
				Total 150

- Students are permitted to bring into the examination room: pens, pencils, highlighters, erasers, sharpeners, rulers, one folded A3 sheet or two A4 sheets of notes and one scientific calculator.
- Students are NOT permitted to bring into the examination room: blank sheets of paper and/or white out liquid/tape.

Materials supplied

- Question and answer book of 78 pages. A formula sheet.
- Answer sheet for multiple-choice questions.

Instructions

- Write your **student number** in the space provided above on this page.
- Check that your **name** and **student number** as printed on your answer sheet for multiple-choice questions are correct, **and** sign your name in the space provided to verify this.
- Unless otherwise indicated, the diagrams in this book are **not** drawn to scale.
- All written responses must be in English.

At the end of the examination

- Place the answer sheet for multiple-choice questions inside the front cover of this book.

Students are NOT permitted to bring mobile phones and/or any other unauthorised electronic devices into the examination room.

Table of contents**SECTION A**

Area of study	Page
Motion in one and two dimensions	3
Electronics and photonics	15
Electric power	24
Interactions of light and matter	34

SECTION B**Detailed study**

Einstein's special relativity	41
Materials and their use in structures	46
Further electronics	52
Synchrotron and its applications	62
Photonics	66
Sound	71

SECTION A – Core studies

Instructions for Section A

Answer **all** questions in this section in the spaces provided. Write using black or blue pen.

Where an answer box has a unit printed in it, give your answer in that unit.

You should take the value of g to be 10 m s^{-2} .

Where answer boxes are provided, write your final answer in the box.

In questions worth more than 1 mark, appropriate working should be shown.

Unless otherwise indicated, diagrams are not to scale.

Area of study – Motion in one and two dimensions

Question 1 (5 marks)

Students set up an inclined plane surface, as shown in Figure 1a. It is angled at 10° to the horizontal. They place a frictionless trolley of mass 0.50 kg at the top of the incline, so that the distance from the front of the trolley to the stopper at the bottom is 3.5 m .

They release the trolley from rest and find that it takes 2.0 s to reach the stopper at the bottom.

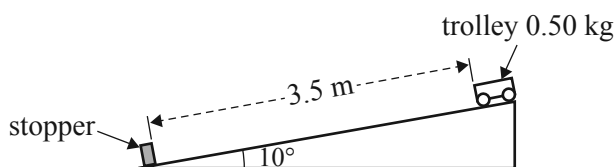
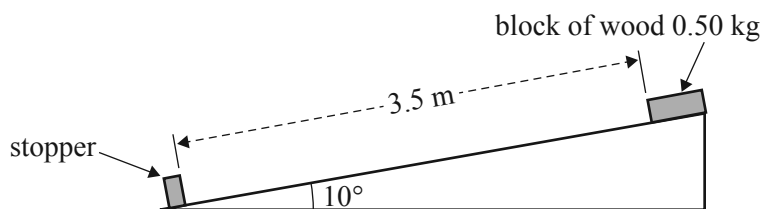

Figure 1a

- a. Calculate the acceleration of the trolley.

2 marks

m s⁻²

**Figure 1b**

- b.** The students replace the frictionless trolley with a block of wood of the same mass. They release the block of wood at a distance of 3.5 m from the stopper, the same as they did with the trolley. When the block is sliding down the incline, there is a constant frictional force between it and the surface. They find that it takes 6.0 s to reach the stopper at the bottom.

Calculate the magnitude of the frictional force of the plane surface acting on the block.

3 marks

N

Question 2 (4 marks)

Students set up an experiment that consists of two masses, m_1 , of 2.0 kg, and m_2 , of 6.0 kg, connected by a string, as shown in Figure 2. The mass of the string can be ignored. The surface is frictionless. The pulley is frictionless.

**Figure 2**

At the start of the experiment, the bottom of mass m_1 is 1.2 m above the floor and both masses are stationary.

- a. Calculate the gravitational force on m_1 . Include the correct unit in your answer. 1 mark

- b. Calculate the tension in the string as m_1 is falling. 3 marks

 N

Question 3 (5 marks)

Figure 3 shows an experiment in which a frictionless trolley, m_1 , of mass 2.0 kg, moving to the right at 6.0 m s^{-1} , collides with and sticks to an initially stationary trolley, m_2 , of mass 4.0 kg and also frictionless.

**Figure 3**

- a. Calculate the magnitude of the total momentum of the two trolleys when they stick together after the collision.

1 mark

kg m s⁻¹

- b. Determine, by using calculations, whether this collision is elastic or inelastic.

2 marks

- c. Calculate the magnitude and direction of the impulse exerted **on** m_1 **by** m_2 during the collision.

2 marks

N s

direction

Question 4 (4 marks)

Engineers are designing a curve on a high-speed railway track. To prevent excessive wear and for the comfort of passengers, it is important that the track be correctly banked so that there are no sideways forces between the rail and the wheel of the train. This is shown in Figures 4a and 4b.

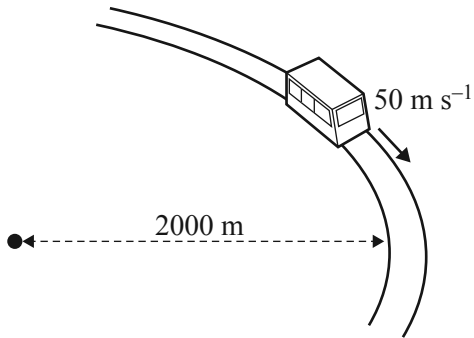
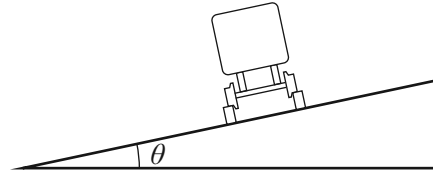
**Figure 4a****Figure 4b**

The radius of the curve is 2000 m and the speed of the train is a constant 50 m s^{-1} .

- a. On Figure 4b, draw two arrows to show external forces acting on the train and a third arrow, marked F_{net} , to show the net force on the train. 2 marks
- b. Calculate the correct angle of bank (θ) for the track to the horizontal for there to be no sideways force on the wheels by the track. Show the steps of your working. 2 marks

o

Question 5 (4 marks)

A mass of 2.0 kg is being swung by a light rod in a vertical circle of radius 1.0 m at a constant speed of 7.0 m s^{-1} , as shown in Figure 5.

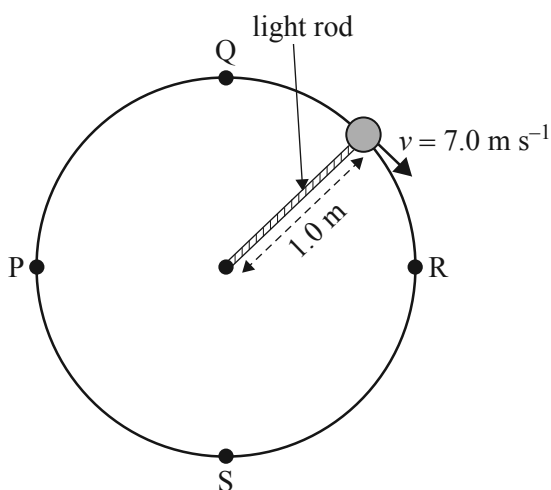
**Figure 5**

- a. Which of the directions (A–F) below shows the direction of the net force on the mass when it is at point P?

1 mark

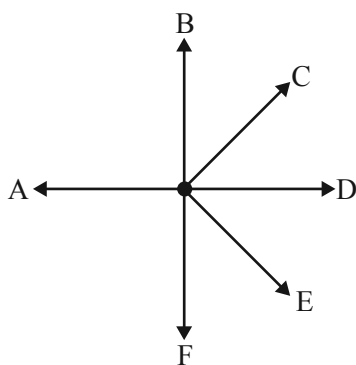

- b. Calculate the magnitude of the tension in the light rod at point S. Show the steps of your working. 3 marks

N

Question 6 (6 marks)

Students hang a mass of 1.0 kg from a spring that obeys Hooke's law with $k = 10 \text{ N m}^{-1}$. The spring has an unstretched length of 2.0 m . The mass then hangs stationary at a distance of 1.0 m below the unstretched position (X) of the spring, at Y, as shown at position 6b in Figure 6. The mass is then pulled a further 1.0 m below this position and released so that it oscillates, as shown in position 6c.

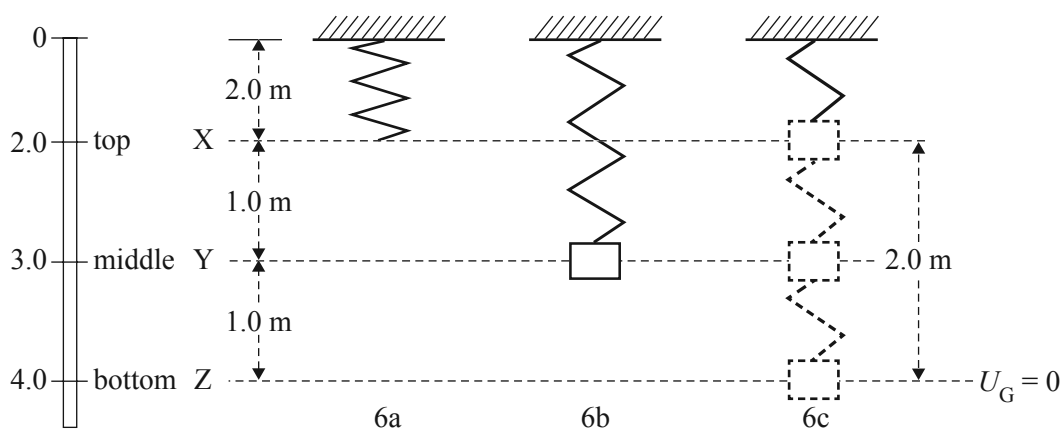

Figure 6
not to scale

The zero of gravitational potential energy is taken to be the bottom point (Z).

The spring potential energy and gravitational potential energy are plotted on a graph, as shown in Figure 7.

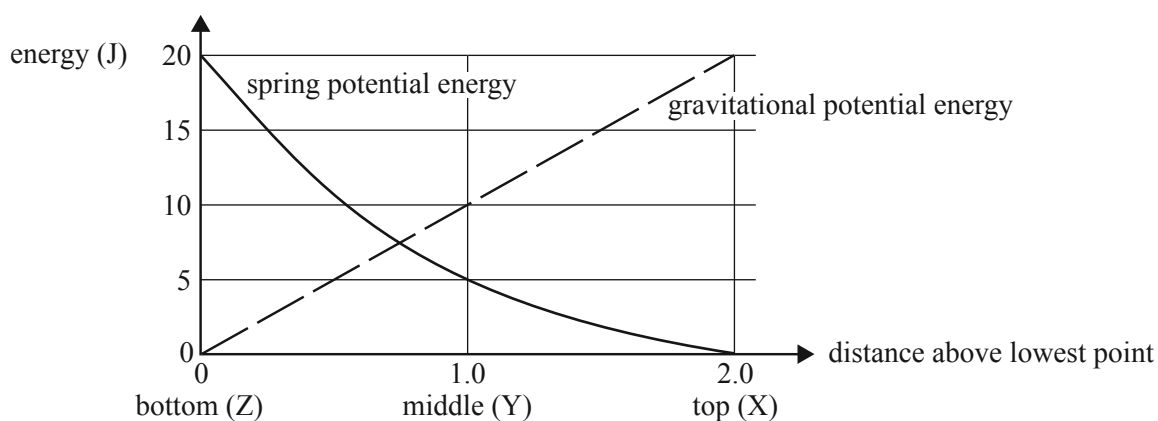

Figure 7

- a. Calculate the total energy of the system when the mass is at its lowest point (Z).

1 mark

J

- b. From the data in the graph, calculate the speed of the mass at its midpoint (Y).

2 marks

m s^{-1}

Without making any other changes, the students now pull the mass down to point P, 0.50 m below Y. They release the mass and it oscillates about Y, as shown in Figure 8.

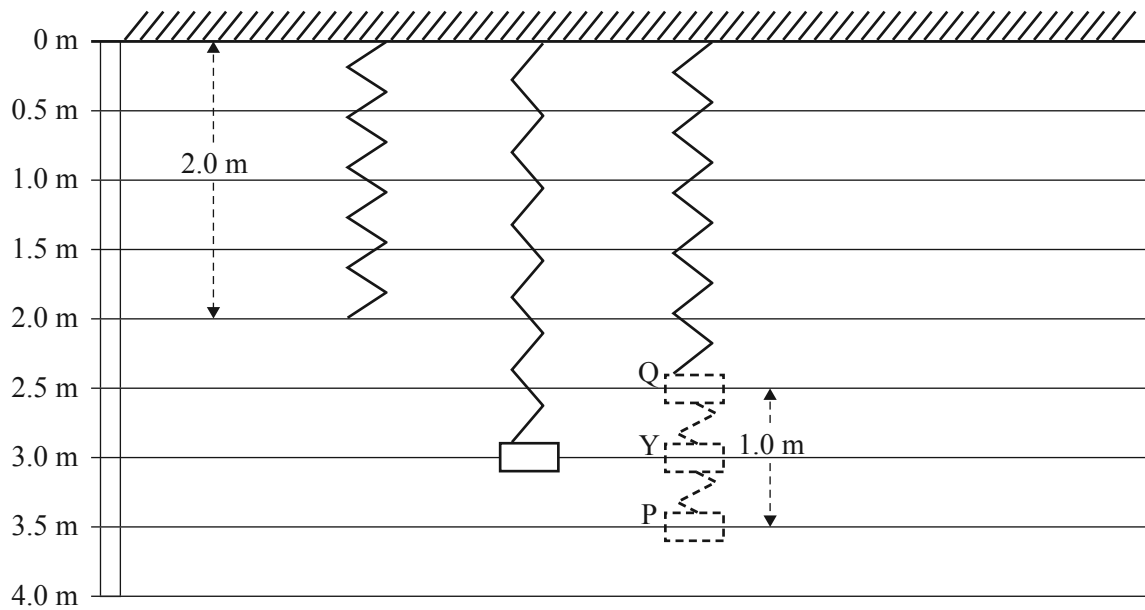

Figure 8

The students now take the zero of gravitational potential energy to be at P and the zero of spring potential energy to be at Q. They expect the total energy at P to be equal to the total energy at Q.

They prepare the following table.

Position	Gravitational potential energy (GPE)	Spring potential energy (SPE)	Kinetic energy (KE)
Q	$GPE = mgh$ $= 1.0 \times 10 \times 1.0 = 10 \text{ J}$	$SPE = 0$	$KE = 0$
P	$GPE = 0$	$SPE = \frac{1}{2}k(\Delta x)^2$ $= \frac{1}{2} \times 10 \times 1.0^2 = 5.0 \text{ J}$	$KE = 0$

However, their calculation of the total energy (GPE + SPE + KE) at Q (10 J) is different from their calculation of the total energy at P (5.0 J).

c. Explain the mistake that the students have made.

3 marks

Question 7 (6 marks)

A satellite is in a geostationary circular orbit over Earth's equator. It remains vertically above the same point X on the equator, as shown in Figure 9.

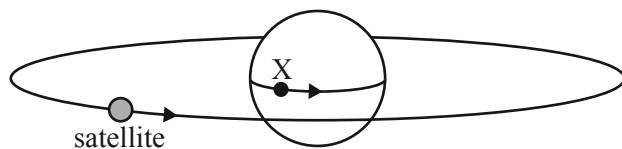
**Figure 9****Data**

mass of Earth	$M_E = 6.0 \times 10^{24} \text{ kg}$
radius of Earth	$R_E = 6.4 \times 10^6 \text{ m}$
mass of satellite	1000 kg
universal gravitational constant	$G = 6.7 \times 10^{-11} \text{ N m}^2 \text{ kg}^{-2}$

- a. Calculate the period of the orbit of the satellite.

1 mark

	s
--	---

- b. Calculate the radius of the orbit of the satellite from the centre of Earth.

2 marks

	m
--	---

- c. An astronaut of mass 65 kg is on board the satellite. She is interviewed on television and says that she is weightless.

Explain how the terms 'weight', 'weightlessness' and 'apparent weightlessness' either apply or do not apply to the astronaut.

3 marks

NO WRITING ALLOWED IN THIS AREA

Question 8 (6 marks)

A stone is thrown from the top of a 15 m high cliff above the sea at an angle of 30° to the horizontal. It has an initial speed of 20 m s^{-1} . The situation is shown in Figure 10. Ignore air resistance.

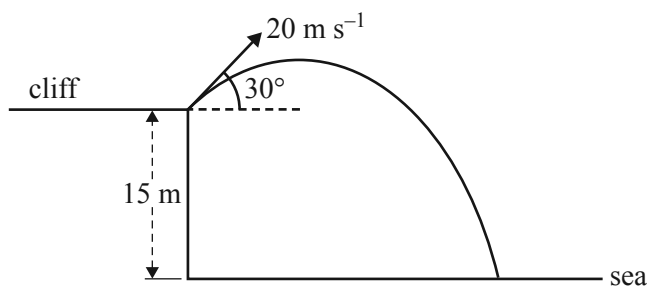

Figure 10
not to scale

- a. Calculate the time taken for the stone to reach the sea.

3 marks

s

- b. Calculate the magnitude and direction of the velocity of the stone immediately before it reaches the sea. Give the direction as the magnitude of the angle between the velocity and the horizontal.

3 marks

m s^{-1}

°

Area of study – Electronics and photonics**Question 9** (3 marks)

A voltage divider is shown in Figure 11. It is connected to a 15 V DC battery. The output is connected to points X and Y.

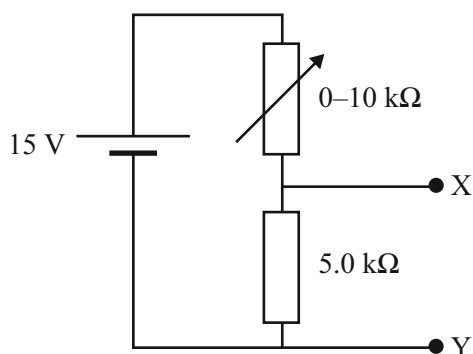
**Figure 11**

The fixed resistor has a value of 5.0 kΩ and the variable resistor can be adjusted smoothly to any value from 0 to 10 kΩ.

Calculate the range of output voltages possible at the output of the voltage divider.

Question 10 (2 marks)

A student needs a resistor of $125\ \Omega$ for an electronics circuit. However, the only available resistors have a value of $50\ \Omega$. He has six of these resistors.

In the space below, sketch how he could connect some or all of these resistors to create a total resistance of $125\ \Omega$.

Question 11 (10 marks)

A student is experimenting with a battery, a light-dependent resistor (LDR), a thermistor and a resistor. She connects them all to form the series circuit shown in Figure 12. There is a current of 5.0 mA flowing through the battery. There is a voltage of 2.5 V across the resistor, 1.0 V across the thermistor and 10 V across the LDR.

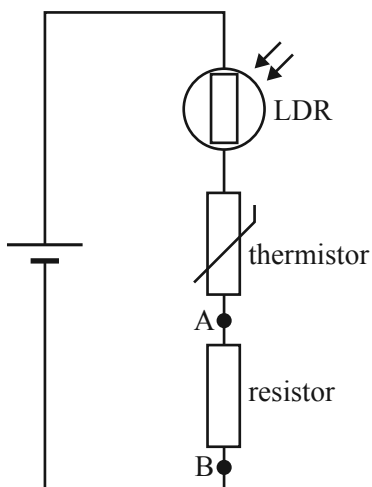
**Figure 12**

- a. Calculate the resistance of the resistor. Show your working.

2 marks

	Ω
--	----------

The characteristics of the thermistor are shown in Figure 13.

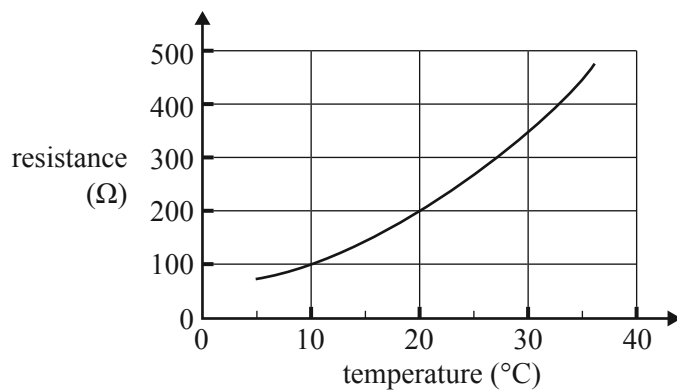

Figure 13

b. Calculate the temperature of the thermistor.

2 marks

°C

The characteristics of the LDR are shown in Figure 14.

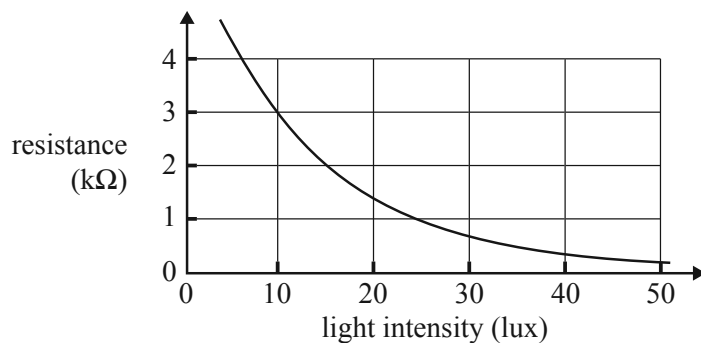

Figure 14

c. Calculate the light intensity falling on the LDR.

2 marks

lux

NO WRITING ALLOWED IN THIS AREA

- d.** A buzzer with a very high resistance is connected across the ends of the resistor (to the points A and B, as shown in Figure 12). It buzzes at any voltage greater than 2.4 V. Initially it is buzzing. The student finds this irritating; she wants to stop it from buzzing by changing the temperature of the room or by changing the light intensity falling on the LDR. She discovers two such changes that have the effect of turning off the buzzer.

Describe these two changes clearly and explain why each of them will turn off the buzzer. You may use calculations, but they are not required.

4 marks

change 1

change 2

NO WRITING ALLOWED IN THIS AREA

Question 12 (5 marks)

A light-emitting diode (LED) has the current-voltage characteristics shown in Figure 15.

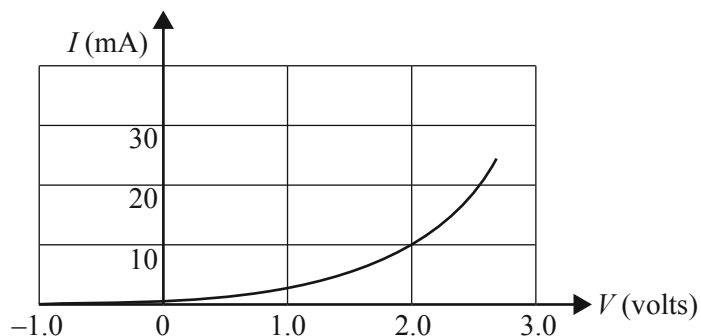

Figure 15

The LED is connected into the circuit shown in Figure 16.

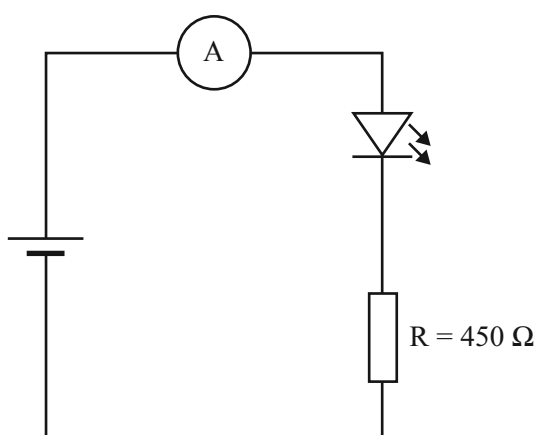

Figure 16

- a. The current measured by the ammeter is 10 mA.
Calculate the voltage of the battery.

3 marks

V

NO WRITING ALLOWED IN THIS AREA

- b.** Compare the types of energy transfers occurring in the LED with the energy transfers in the resistor in this circuit.

2 marks

NO WRITING ALLOWED IN THIS AREA

Question 13 (4 marks)

The input-output characteristics of an inverting amplifier are shown in Figure 17.

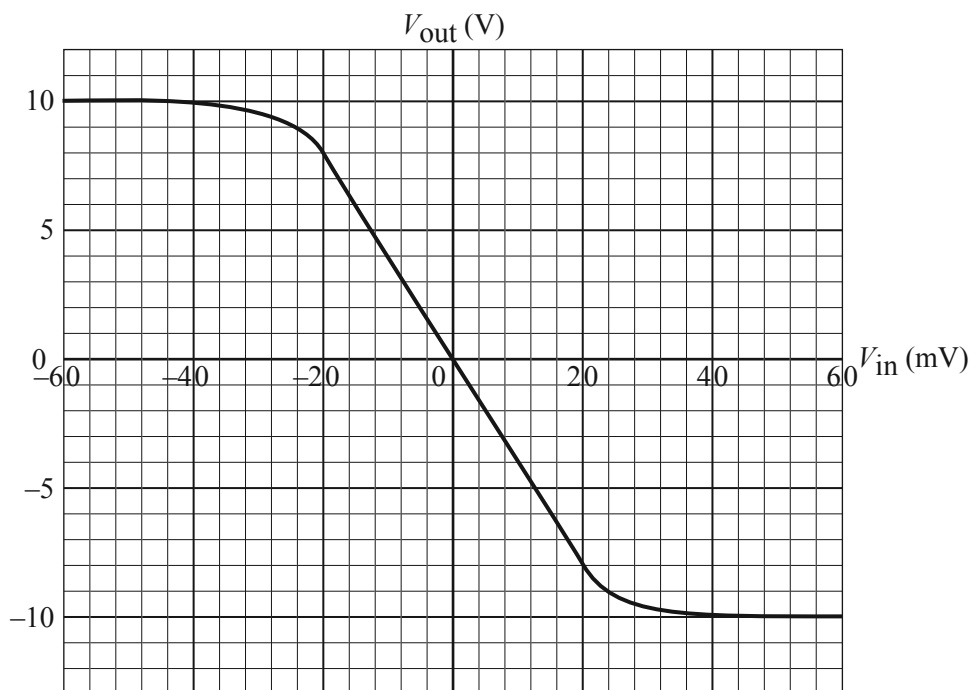

Figure 17

- a. Calculate the magnitude of the gain of the amplifier in its linear region. 2 marks

- b. Explain why it is described as an inverting amplifier. 2 marks

NO WRITING ALLOWED IN THIS AREA

NO WRITING ALLOWED IN THIS AREA

CONTINUES OVER PAGE

SECTION A – Core studies – continued
TURN OVER

Area of study – Electric power**Question 14** (2 marks)

Two solenoids are shown in Figure 18. Current is flowing through their coils and both of them are generating magnetic fields. Their combined field is much greater than Earth's field.

Sketch at least **four** field lines in the space enclosed by the dashed rectangle. Mark the direction of each field line that you draw.

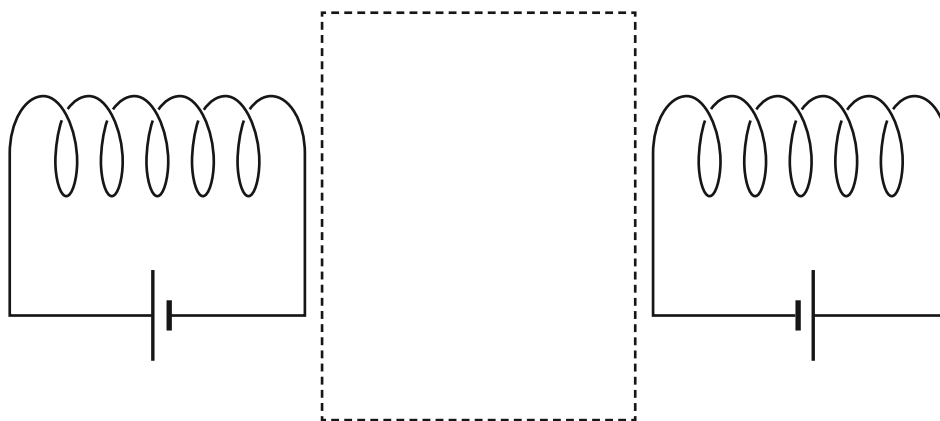
**Figure 18**

Question 15 (7 marks)

Students are experimenting with an ideal transformer. The circuit is shown in Figure 19.

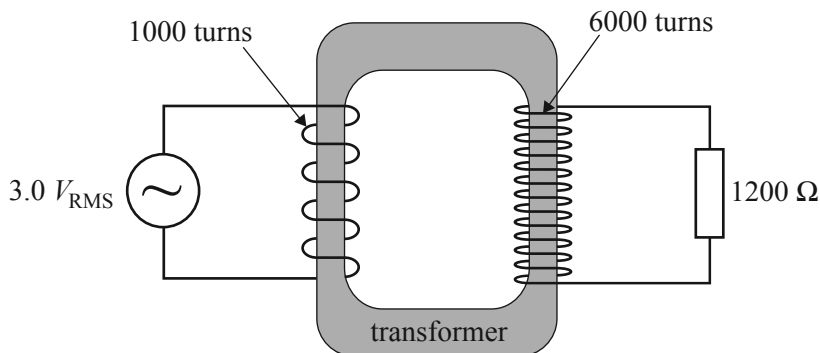
**Figure 19**

The primary coil has 1000 turns; the secondary coil has 6000 turns. There is a 1200 Ω resistor in the secondary circuit. A 3.0 V_{RMS} AC power supply is connected across the primary coil.

- a. Calculate the RMS voltage across the resistor.

1 mark

 V

- b. Calculate the peak voltage across the resistor.

1 mark

 V

- c. Calculate the power dissipated in the resistor.

2 marks

 W

Question 16 (6 marks)

A diagram of a DC motor is shown in Figure 21.

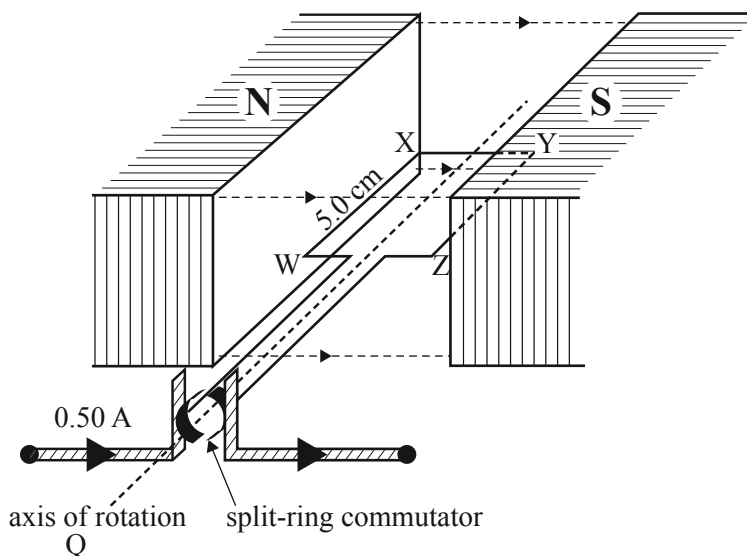

Figure 21

- a. The motor is operating and the rectangular coil is rotating about the axis of rotation. Mary views the operating motor from point Q.

Is the direction of rotation clockwise or anticlockwise? Give a reason for your answer.

2 marks

- b. While in the position shown in the diagram, a current of 0.50 A is flowing in the rotating coil. The coil has 20 turns and the magnetic field at the side labelled WX has a strength of 500 mT. The side WX has a length of 5.0 cm.

Calculate the magnitude of the force on the side WX.

2 marks

N

- c. There is a split-ring commutator fitted to the motor. Mary suggests that the split-ring commutator causes a lot of friction on the motor, and that the motor would rotate faster if the split-ring commutator were removed and, instead, slip-rings were used to connect the input DC current to the rotating coil. Would this change improve the operation of the motor? Give reasons for your answer. 2 marks

Question 17 (11 marks)

Students conduct an experiment that is shown in Figure 22. An aluminium ring is made to oscillate vertically between point A and point B. Point C is the midpoint between A and B. A strong, small bar magnet is fixed at the centre of the oscillation, as shown in Figure 22.

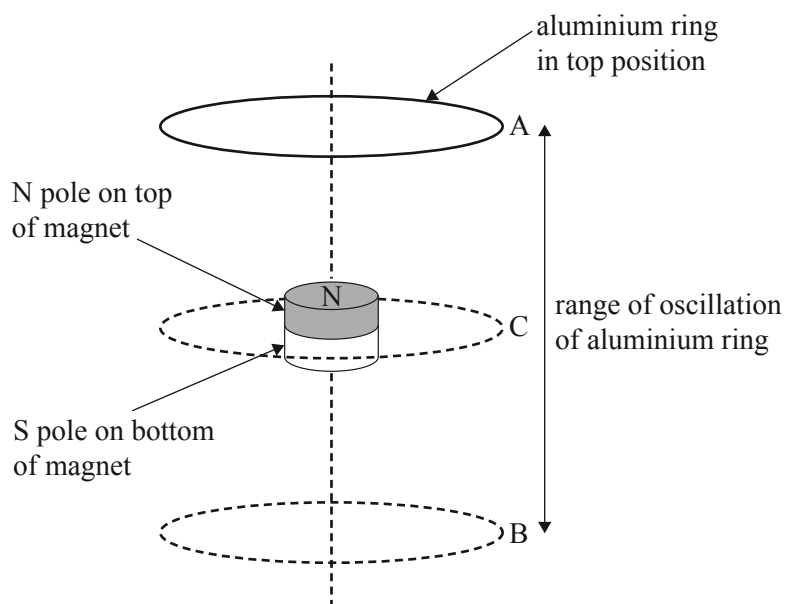

Figure 22

The vertical dashed line goes through the centre of the aluminium ring and also through the centre of the bar magnet in the diagram.

The magnetic flux through the aluminium ring is graphed as a function of time in the graph shown in Figure 23.

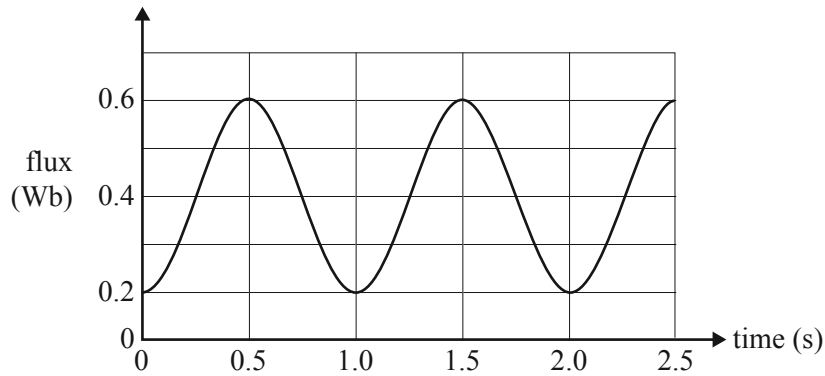

Figure 23

- a. The resistance measured around the aluminium ring is 0.1Ω .
Calculate the average current flowing around the ring from time $t = 1.0 \text{ s}$ to $t = 1.5 \text{ s}$. 3 marks

A

- b. Use information from the graph in Figure 23 to specify the time(s) after $t = 0 \text{ s}$ and before $t = 2.0 \text{ s}$ when the emf around the ring will be zero. 2 marks

- c. When the ring is moving downwards towards the N pole of the magnet, a current flows around the ring.
Use a sketch or words to describe the direction of this current when viewed from above. Explain your answer carefully.

4 marks

- d. Use information from the graph in Figure 23 to complete the table below, showing the times (between $t = 0$ s and $t = 2.5$ s) when the aluminium ring is located at point A, point B and point C, as shown in Figure 22.

At $t = 0$ s, the ring is at point A.

2 marks

Position of ring	Time(s)
at point A	0
at point C	
at point B	

Question 18 (10 marks)

A bank of solar cells generates DC electricity. The current generated is transmitted along two transmission lines to a toolshed. The voltage loss along the transmission lines is 24 V. The current in the transmission lines is 6.0 A. The output power of the bank of solar cells is 1200 W.

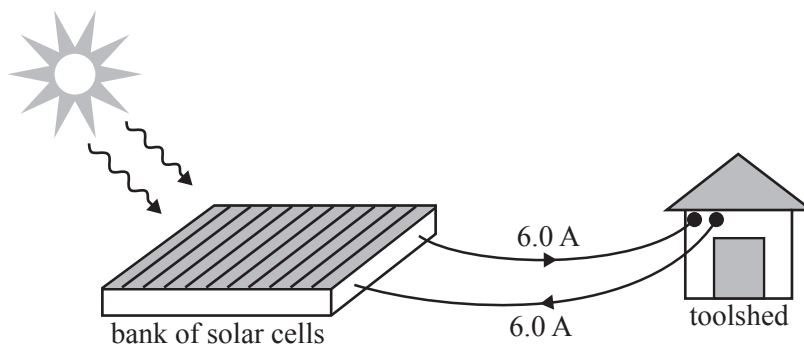
**Figure 24**

- a. Calculate the total resistance of the transmission lines. 2 marks

Ω

- b. Calculate the output voltage of the bank of solar cells. 2 marks

V

- c. Calculate the value of the ratio (as a percentage) 3 marks

$$\frac{\text{power loss in the transmission lines}}{\text{power input to the transmission lines}}$$

%

NO WRITING ALLOWED IN THIS AREA

- d.** The owner of the toolshed wants to reduce the power lost in the transmission lines. She installs a new bank of solar cells that produces the same power (1200 W), but at a different voltage. She also installs new transmission lines with a total resistance of 2.0Ω . This will change the voltage at the toolshed. With the new arrangement, the voltage loss in the transmission lines is 10 V. Calculate the output voltage of the new bank of solar cells.

3 marks

V

NO WRITING ALLOWED IN THIS AREA

CONTINUES OVER PAGE

SECTION A – Core studies – continued
TURN OVER

Area of study – Interactions of light and matter**Question 19** (2 marks)

A photon of blue light has a frequency of 6.7×10^{14} Hz.

- a. Calculate the energy (in joules) of the photon of blue light.

1 mark

J

- b. Calculate the wavelength (in metres) of the photon of blue light.

1 mark

m

Question 20 (5 marks)

An energy-level diagram for a sodium atom is shown in Figure 25.

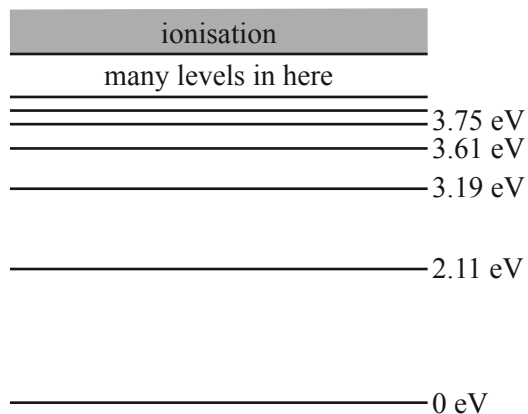
**Figure 25**

- a. An atom is in the 3.19 eV state. It returns to the ground state, emitting one or more photons. Calculate the **longest** wavelength of light that could be emitted by the atom.

2 marks

m

- b. Explain, with a calculation, why the emission spectrum of sodium shows a spectral line at 588.63 nm.

3 marks

Question 21 (7 marks)

Students are investigating the photoelectric effect by shining monochromatic light with a frequency of 1.00×10^{15} Hz onto a sodium plate. Their apparatus is shown in Figure 26.

**Figure 26**

Figure 27 shows a graph of the relationship between the photocurrent and the reading on the voltmeter.

**Figure 27**

- a. Use the information in the graph to calculate the maximum kinetic energy (in joules) of the photoelectrons.

1 mark

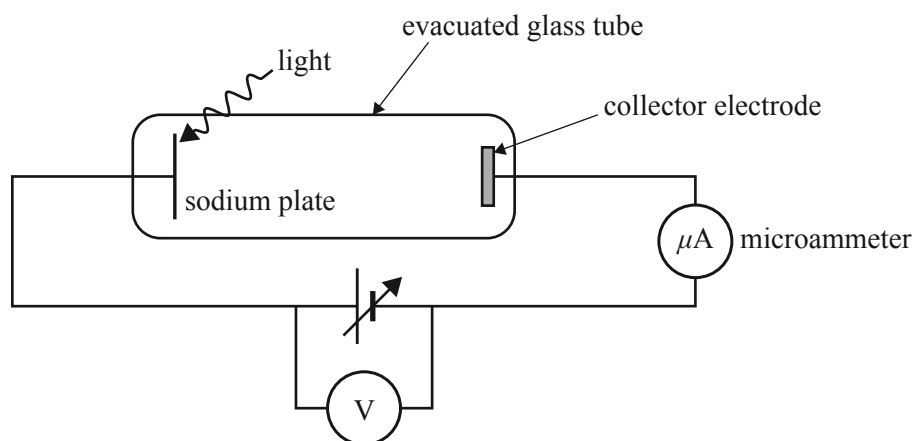
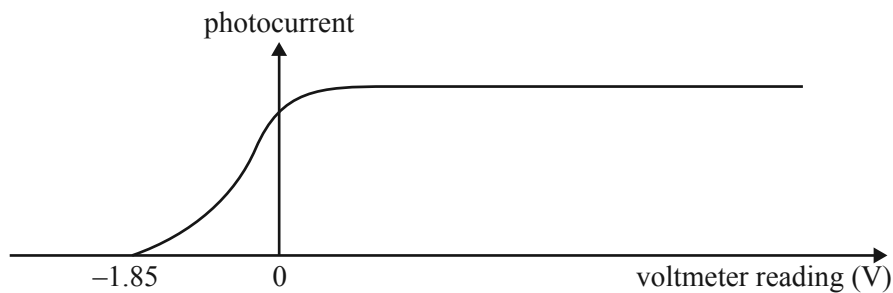
J

b. Calculate the work function (in eV) of sodium.

2 marks

eV

c. The intensity of the light is now reduced and the experiment is repeated. The students obtain a new graph of photocurrent against voltage.

Sketch the new graph on Figure 27.

2 marks

d. The students change the light source to one with a different frequency. They observe that the photocurrent is zero and remains at zero regardless of the size or sign of the voltage.

Explain this observation.

2 marks

Question 22 (9 marks)

The apparatus for a Young's double-slit experiment is shown in Figure 28.

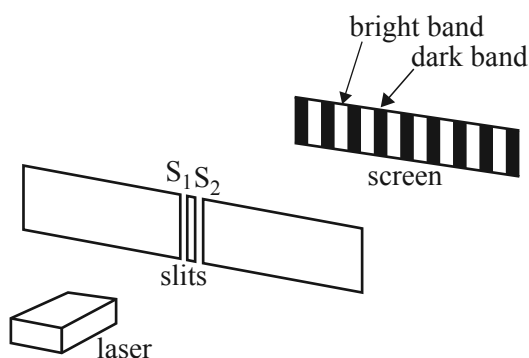

Figure 28
not to scale

- a. A beam of green light ($\lambda = 550 \text{ nm}$) is incident on the slits.

Describe the intensity at the exact centre of the interference pattern on the screen and give a reason for your answer.

2 marks

- b. The beam is now replaced with light of a lower frequency.

The second dark band from the centre of the interference pattern would

- A. become narrower.
 B. remain in the same position.
 C. move closer to the centre of the pattern.
 D. move further away from the centre of the pattern.

1 mark

- c. The path difference from the slits to the second bright band from the centre of the interference pattern is 1.4×10^3 nm.

Calculate the path difference (in metres) from the slits to the first dark band from the centre of the pattern.

3 marks

m

- d. A student reads on a website that ‘Young’s experiment supports the particle model of light’.

Explain, with reasons, whether the statement is correct or incorrect.

3 marks

Question 23 (5 marks)

Students aim X-rays with a photon energy of 80 keV at a thin metal foil. The resulting diffraction pattern is shown in Figure 29.

Due to copyright restriction,
this material is not supplied.

Figure 29

- a. Calculate the magnitude of the momentum of a single X-ray photon.

2 marks

kg m s ⁻¹

- b. The students are aware that electrons can also be used to form diffraction patterns. They wish to use a beam of electrons to form a diffraction pattern with fringe spacings identical to those in Figure 29. Student A says that the fringe spacing will be identical if the electrons have the same momentum as the X-rays. Student B says that the fringe spacing will be identical if the electrons have the same energy as the X-rays.

Which student is correct? Explain your answer.

3 marks

END OF SECTION A

NO WRITING ALLOWED IN THIS AREA

SECTION B**Instructions for Section B**

Select **one** Detailed study and answer **all** questions within that Detailed study in pencil on the answer sheet provided for multiple-choice questions.

Show the Detailed study you are answering by shading the matching box on your multiple-choice answer sheet and writing the name of the Detailed study in the box provided.

Choose the response that is **correct** for the question.

A correct answer scores 2, an incorrect answer scores 0.

Marks will **not** be deducted for incorrect answers.

No marks will be given if more than one answer is completed for any question.

Detailed study 1 – Einstein’s special relativity**Question 1**

James is stationary ($v = 0$) on a footpath while Amanda drives past at a constant speed of 60 km h^{-1} .

Which one of the following statements is correct?

- A. Amanda is in a non-inertial reference frame because she is moving relative to James.
- B. James must be in a non-inertial reference frame because he is stationary at the moment.
- C. James is not stationary in his reference frame because he is moving in Amanda’s reference frame.
- D. Amanda is stationary in her reference frame even though she is moving in James’s reference frame.

Question 2

Students use sound to test the ideas of the Michelson–Morley experiment. They conduct an experiment on an outdoor basketball court on a windy day.

Student A stood at the western end and created a loud pulse of sound. Student B stood 30.0 m away at the eastern end with a sound detector, as shown in Figure 1.

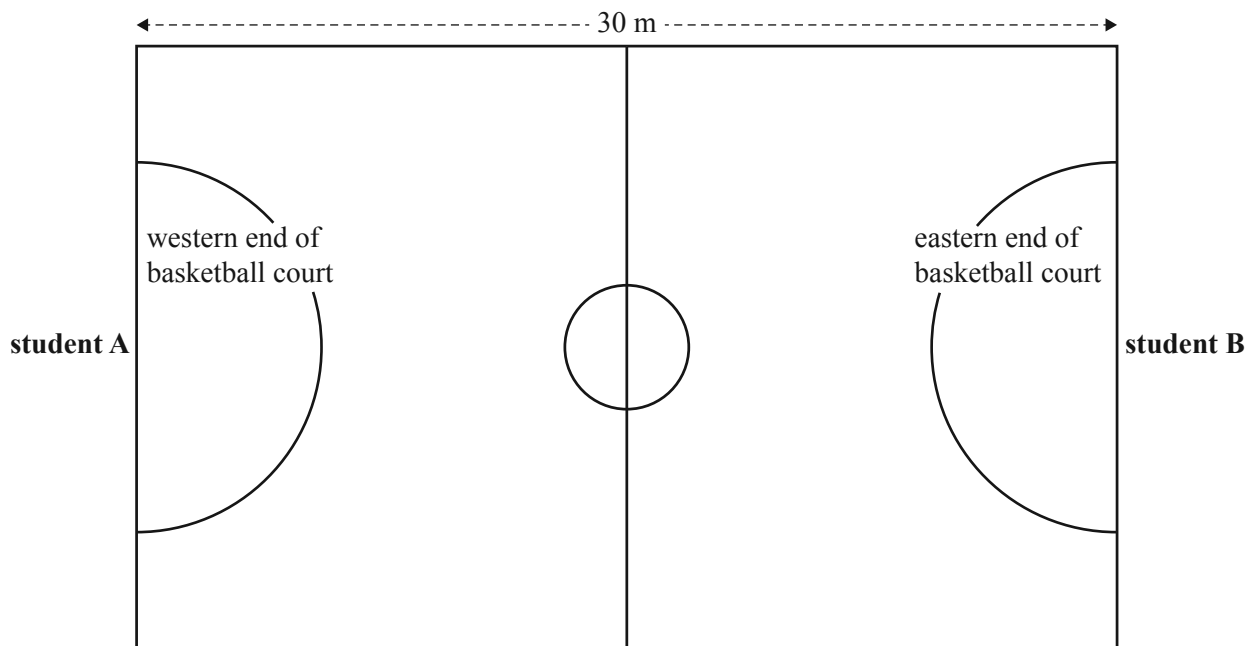

Figure 1

They found that the sound travelling towards the eastern end took 0.0857 s to reach student B.

Student B, at the eastern end, then created a loud pulse of sound. This time the sound travelling towards the western end took 0.0909 s to reach student A.

Which one of the following best explains their observations?

- A. The wind was blowing to the east at 10 m s^{-1} .
- B. The wind was blowing to the east at 20 m s^{-1} .
- C. The wind was blowing to the west at 20 m s^{-1} .
- D. The speed of sound is the same in all inertial reference frames.

Question 3

Scientists accelerate a proton from rest to a final speed where its relativistic mass is $5.1 \times 10^{-27} \text{ kg}$.

The rest mass of a proton is $1.7 \times 10^{-27} \text{ kg}$.

How much work was done on the proton?

- A. $3.1 \times 10^{-10} \text{ J}$
- B. $3.1 \times 10^{-17} \text{ J}$
- C. $1.0 \times 10^{-18} \text{ J}$
- D. $3.4 \times 10^{-27} \text{ J}$

Question 4

The spaceship *Andromeda* (A) is travelling at $0.7c$ towards the asteroid Ceres (C). It sends a light pulse to the nearby ship *Bradbury* (B), which is approaching the asteroid from the far side at $0.8c$, as shown in Figure 2.

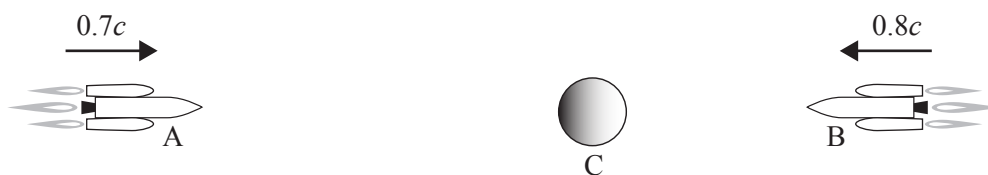
**Figure 2**

The speed of the light pulse as measured from each body is

- A. greatest for A and least for B.
- B. greatest for B and least for A.
- C. greatest for C and least for B.
- D. the same for each body.

Question 5

A physicist purchased a limousine, but found that it was twice as long as her garage. She reasoned that in the garage's reference frame, it should be possible for a moving limousine to fit exactly inside the garage for an instant.

What is the minimum speed at which the limousine would have to travel in order for this to work?

- A. $\frac{c}{\sqrt{2}}$
- B. $\frac{3}{4}c$
- C. $\frac{\sqrt{3}}{2}c$
- D. $\sqrt{3}c$

Question 6

A neutral pion is a type of particle. In a collider experiment, a neutral pion with $\gamma = 10.0$ decays into two photons. The total energy of both photons together is measured to be 2.17×10^{-10} J. Before the decay, only the neutral pion exists; after the decay, only the photons exist.

What is the rest mass of the neutral pion?

- A. 2.41×10^{-28} kg
- B. 2.41×10^{-27} kg
- C. 7.23×10^{-27} kg
- D. 7.23×10^{-20} kg

Question 7

It is not possible for a particle with a rest mass greater than zero to be accelerated to a speed of c .

Which one of the following is the best explanation for this?

- A. It would violate causality and is therefore impossible.
- B. As v approaches c , the rest mass of the particle approaches infinity.
- C. Massless particles such as photons are constrained to travel at a speed of c .
- D. An infinite amount of work would be required in order to accelerate the particle to a speed of c .

Question 8

Which one of the following statements is correct?

- A. Proper time cannot be measured on a moving clock.
- B. Proper time is the time interval between two events that is measured by a stationary clock.
- C. Proper time is the shortest possible time interval between two events that any observer can measure.
- D. An observer who measures a proper time is the only observer performing a correct measurement of the time between two events.

Question 9

Lucy is on a train travelling at $0.8c$. The train passes Edmund, who is standing on the platform at a train station.

They each measure a different length for the train and also measure a different length for the platform.

Which one of the following statements is correct?

- A. Lucy measures a proper length for the train because she is stationary with respect to the train.
- B. Edmund measures a proper length for the train because he is stationary in his reference frame.
- C. Edmund measures a proper length for both the platform and the train because he is standing still.
- D. Lucy measures a proper length for the platform because she passes the start and the end of the platform over the course of her journey.

Use the following information to answer Questions 10 and 11.

The global positioning system (GPS) makes use of satellites in orbit around Earth. The student shown in Figure 3 is standing on the ground while one such satellite passes directly overhead.

The satellite has $\gamma = (1 + [5 \times 10^{-11}])$.

Approximate the satellite's path as a horizontal straight line and neglect Earth's gravitational field. Assume that both the satellite and the student are in inertial reference frames.

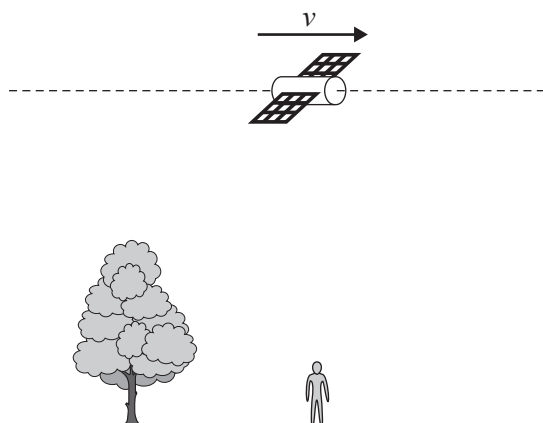

Figure 3
not to scale

Question 10

If exactly 1 s passes as measured on the satellite, how much time elapses for the student?

- A. $(1 - [5 \times 10^{-11}]) \times 1$ s
- B. $(1 + [5 \times 10^{-11}]) \times 1$ s
- C. $\left(\frac{1}{1 + [5 \times 10^{-11}]} \right) \times 1$ s
- D. 1 s exactly

Question 11

It is necessary to have accurate measurements of distances. In the student's reference frame, a satellite that is vertically overhead is measured to be 20 000 km distant from the student.

What measurement would instruments on the satellite take of the same distance?

- A. $(1 - [5 \times 10^{-11}]) \times 20\,000$ km
- B. $\left(\frac{1}{1 + [5 \times 10^{-11}]} \right) \times 20\,000$ km
- C. 20 000 km
- D. $(1 + [5 \times 10^{-11}]) \times 20\,000$ km

SECTION B

Instructions for Section B

Select **one** Detailed study and answer **all** questions within that Detailed study in pencil on the answer sheet provided for multiple-choice questions.

Show the Detailed study you are answering by shading the matching box on your multiple-choice answer sheet and writing the name of the Detailed study in the box provided.

Choose the response that is **correct** for the question.

A correct answer scores 2, an incorrect answer scores 0.

Marks will **not** be deducted for incorrect answers.

No marks will be given if more than one answer is completed for any question.

Detailed study 2 – Materials and their use in structures

Use the following information to answer Questions 1–5.

Engineers are testing four different steels (P, Q, R and S) to be used in the manufacture of steel cables for cranes. The cables are all to have a cross-sectional area of $4.0 \times 10^{-2} \text{ m}^2$.

The stress-strain graphs for the four different steels are shown in Figure 1.

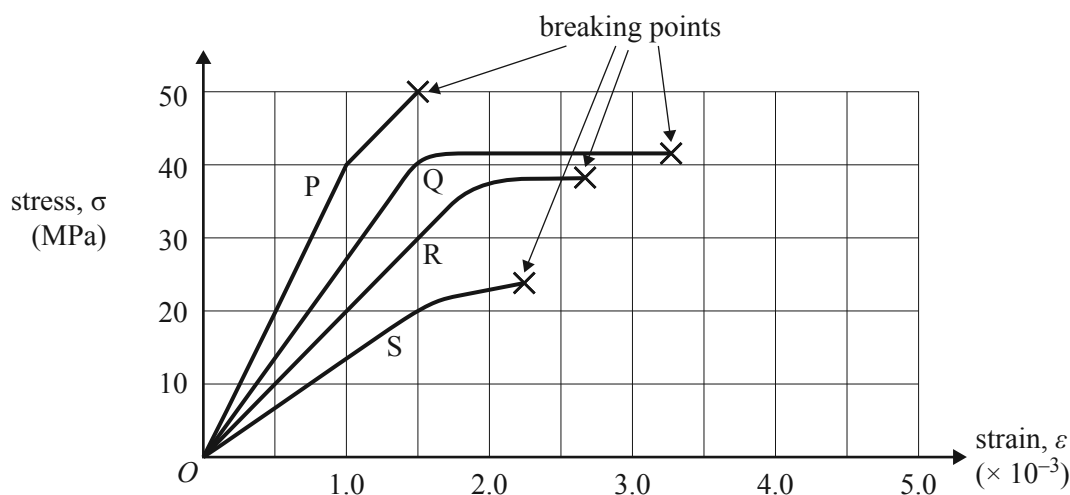

Figure 1

Question 1

Which one of the following options is the closest to Young's modulus for steel P?

- A. 33 Pa
- B. 4.0×10^7 Pa
- C. 3.3×10^{10} Pa
- D. 4.0×10^{10} Pa

Question 2

Which one of the following is the best estimate of the mass that could be suspended from a cable of steel P of cross-sectional area $4.0 \times 10^{-2} \text{ m}^2$ at its breaking point?

- A. 50 kg
- B. 200 kg
- C. $2.0 \times 10^5 \text{ kg}$
- D. $5.0 \times 10^6 \text{ kg}$

Question 3

A sample of steel S is stretched to a strain of 1.5×10^{-3} .

Which one of the following is the best estimate of the strain energy (energy per unit volume)?

- A. 15 J m^{-3}
- B. $1.5 \times 10^4 \text{ J m}^{-3}$
- C. $2.3 \times 10^4 \text{ J m}^{-3}$
- D. $3.0 \times 10^4 \text{ J m}^{-3}$

Question 4

The engineers decide that steel R is the best type of steel for a cable in a crane.

The most likely reason for this decision is that

- A. R is the strongest.
- B. R has the highest Young's modulus.
- C. R has the greatest strain energy to breaking point.
- D. R has the greatest range of strain values in its elastic region.

Question 5

A cable of steel R of length 20 m and cross-sectional area $4.0 \times 10^{-2} \text{ m}^2$ is used to suspend a mass of 1000 kg.

Which one of the following is closest to the amount that the cable will stretch?

- A. 0.25 mm
- B. 0.4 mm
- C. 2.5 cm
- D. 4.0 cm

Use the following information to answer Questions 6 and 7.

A rod PQ of mass 10 kg and length 6.0 m is joined to a wall at point P by a frictionless hinge. A mass of 20 kg hangs from point Q.

A cable SR holds the rod at an angle of 60° to the horizontal. SR makes an angle of 90° with the rod PQ. The situation is shown in Figure 2.

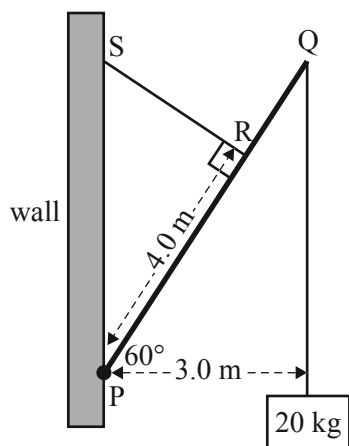

Figure 2

Question 6

Which one of the following is closest to the torque about point P due to the 20 kg mass?

- A. 60 N m
- B. 120 N m
- C. 600 N m
- D. 1200 N m

Question 7

Which one of the following is closest to the tension in the cable SR?

- A. 20 N
- B. 150 N
- C. 190 N
- D. 200 N

Use the following information to answer Questions 8 and 9.

A platform is constructed with a concrete beam KL of length 6.0 m and mass 4000 kg. The concrete beam is reinforced with steel rods. It is attached to stable rock at point K with a frictionless pivot and supported by a column MN. M is located 2.0 m from point K.

The situation is shown in Figure 3.

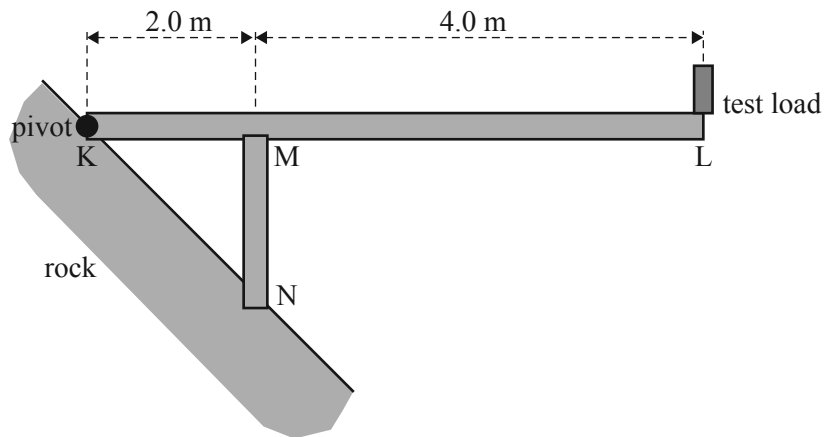

Figure 3

The designers test the platform with a test load of 1000 kg, located at the end of the platform at point L.

Question 8

Which one of the following is closest to the force exerted by the beam KL downwards on the support MN?

- A. 5000 N
- B. 9000 N
- C. 50000 N
- D. 90000 N

Question 9

Which one of the following shows the best placement for the reinforcing steel rods (shown as dashed lines) in the concrete beam KL?

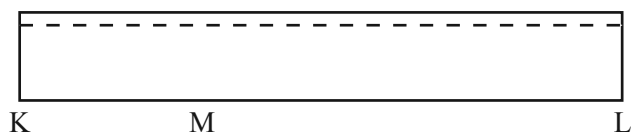
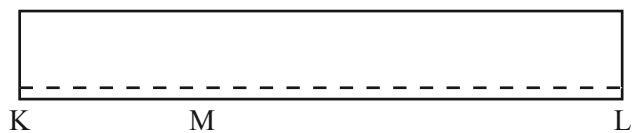
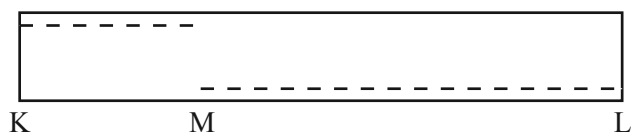
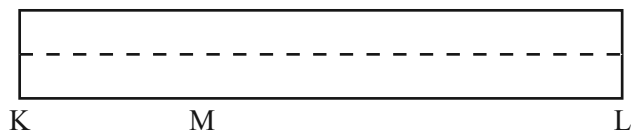
A.**B.****C.****D.**

Question 10

A simple truss bridge carries a roadway across a valley. The situation is shown in Figure 4. The truss rests on the sides of the valley at points E and I.

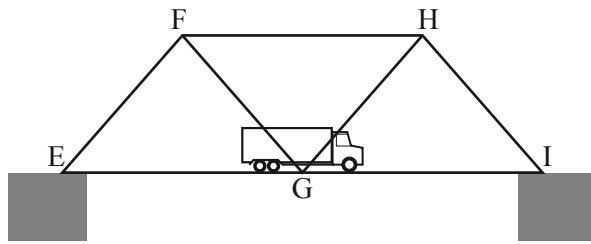
**Figure 4**

Which one of the following correctly identifies the beams that are in tension or compression?

	Beam EF	Beam FG	Beam FH
A.	tension	compression	tension
B.	compression	tension	compression
C.	compression	compression	tension
D.	tension	tension	compression

Another type of bridge is based on an arch shape. A typical arch-shaped bridge is shown in Figure 5.

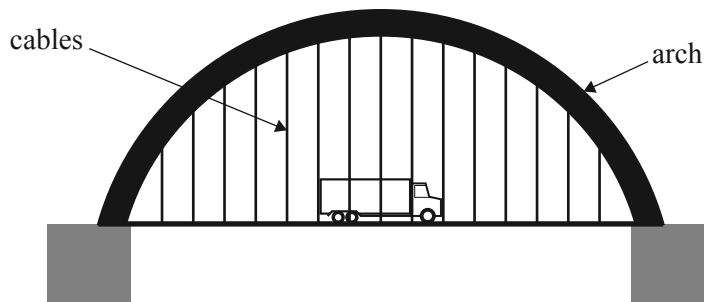
**Figure 5****Question 11**

Which one of the following correctly identifies whether the components are in tension or compression?

	Arch	Cables
A.	tension	compression
B.	compression	tension
C.	compression	compression
D.	tension	tension

SECTION B

Instructions for Section B

Select **one** Detailed study and answer **all** questions within that Detailed study in pencil on the answer sheet provided for multiple-choice questions.

Show the Detailed study you are answering by shading the matching box on your multiple-choice answer sheet and writing the name of the Detailed study in the box provided.

Choose the response that is **correct** for the question.

A correct answer scores 2, an incorrect answer scores 0.

Marks will **not** be deducted for incorrect answers.

No marks will be given if more than one answer is completed for any question.

Detailed study 3 – Further electronics

Use the following information to answer Questions 1–11.

A group of VCE students is designing and constructing an AC to DC smoothed, regulated DC power supply.

Various transformers, diodes, Zener diodes, capacitors and resistors are available to them. They start by conducting a number of tests.

Question 1

The students begin by testing the output of one of the transformers with an oscilloscope. The circuit is shown in Figure 1a and the display on the oscilloscope is shown in Figure 1b.

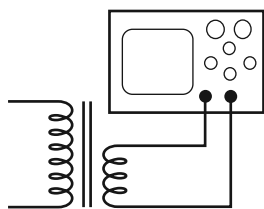

Figure 1a

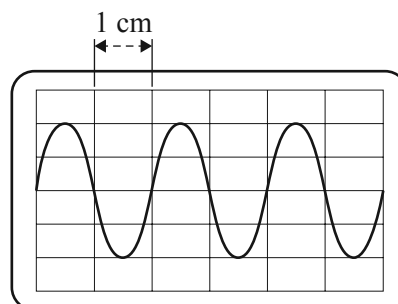

Figure 1b

The time (x -axis) of the oscilloscope is set to 5 ms/cm.

Which one of the following is closest to the frequency of the AC signal of the transformer's output?

- A. 10 Hz
- B. 50 Hz
- C. 100 Hz
- D. 500 Hz

Use the following information to answer Questions 2 and 3.

The students next test the diodes. Their teacher tells them that one or more of the diodes may be faulty. They set up the circuit, as shown in Figure 2. The output of the transformer is $12 V_{\text{RMS}}$.

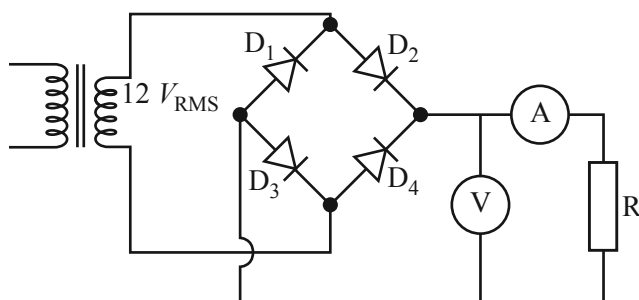

Figure 2

Question 2

The circuit is correctly assembled, but one or more of the diodes are faulty and there is no voltage or current at the output of the bridge rectifier.

Which one of the following best explains this behaviour of the circuit?

- A. Only D_2 is faulty.
- B. Only D_2 and D_3 are faulty.
- C. Only D_2 and D_4 are faulty.
- D. It would be necessary for all four diodes D_1 – D_4 to be faulty for there to be no output voltage or current.

Question 3

The characteristics of the diodes shown in Figure 2 are shown in Figure 3.

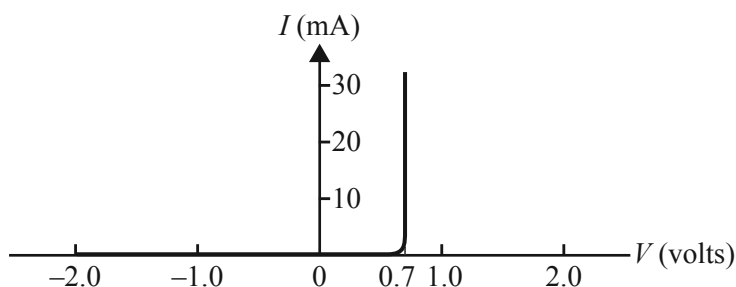

Figure 3

The students replace the faulty diode(s) and test the circuit again.

Which one of the following is closest to the voltage that will be measured by the voltmeter V shown in Figure 2?

- A. 9.2 V
- B. 10.6 V
- C. 11.3 V
- D. 12.0 V

Use the following information to answer Questions 4 and 5.

The students next test one of the capacitors. They set up the circuit shown in Figure 4.

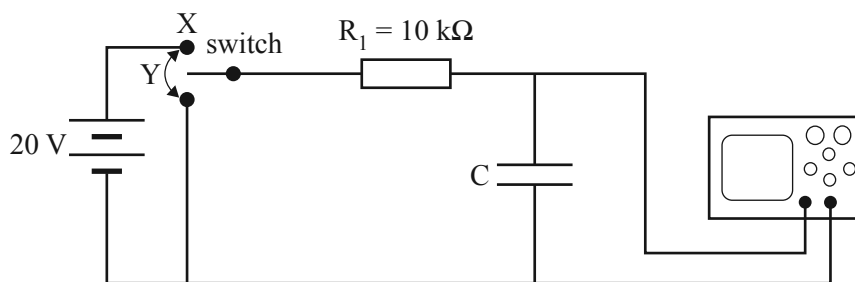

Figure 4

With the capacitor initially discharged, they move the switch to position X and observe the signal on the oscilloscope. From this data, they plot the graph shown in Figure 5.

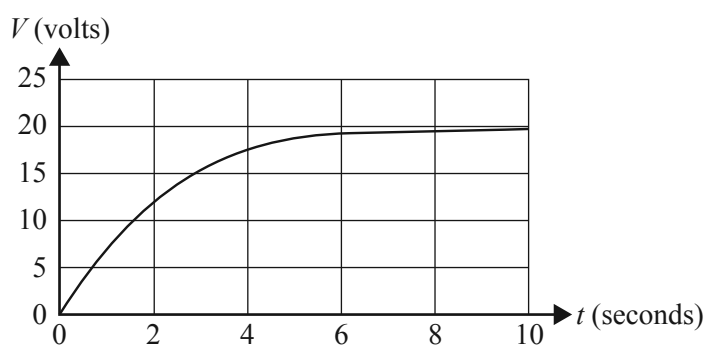

Figure 5

Question 4

Which one of the following is closest to the value of the capacitor?

- A. $10 \mu\text{F}$
- B. $20 \mu\text{F}$
- C. $100 \mu\text{F}$
- D. $200 \mu\text{F}$

Question 5

Some time later, when the capacitor is fully charged, the students move the switch to position Y at time $t = 0$. Which one of the following best represents the display that will be seen on the oscilloscope?

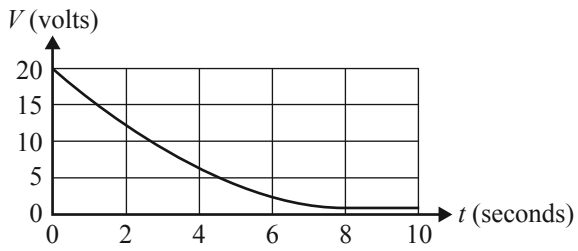
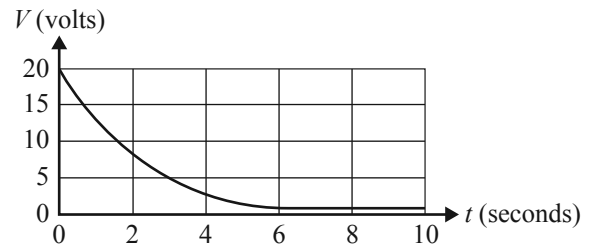
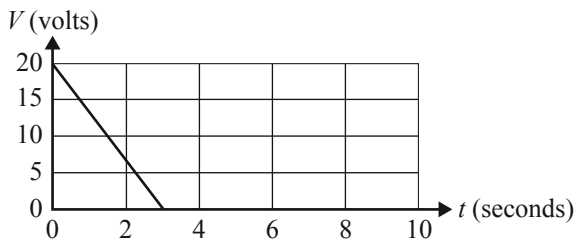
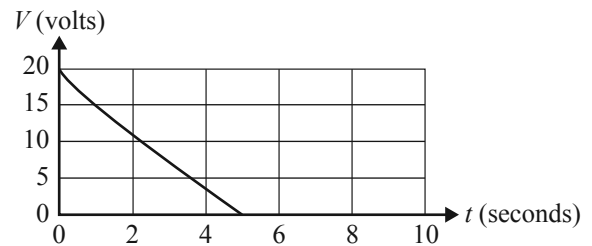
A.**B.****C.****D.**

Question 6

The students now test another capacitor, of value $100\ \mu\text{F}$, for use as a smoothing capacitor. They set up the circuit shown in Figure 6.

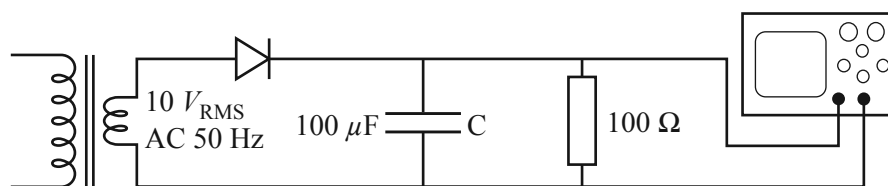
**Figure 6**

Which one of the following best shows the display they will observe on the oscilloscope?

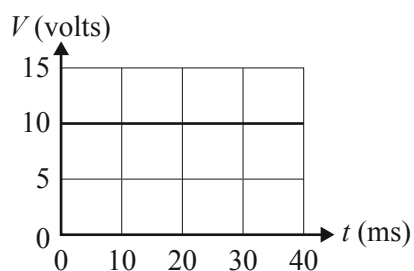
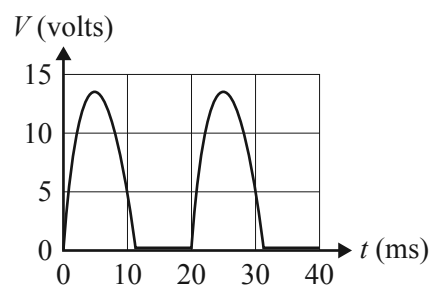
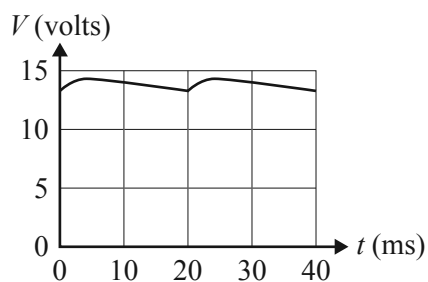
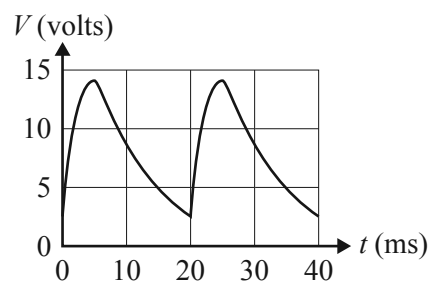
A.**B.****C.****D.**

The students next test a Zener diode. The characteristics of the diode are shown in Figure 7a and the test circuit is shown in Figure 7b.

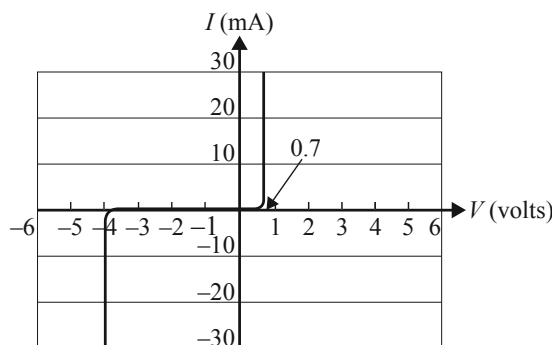

Figure 7a

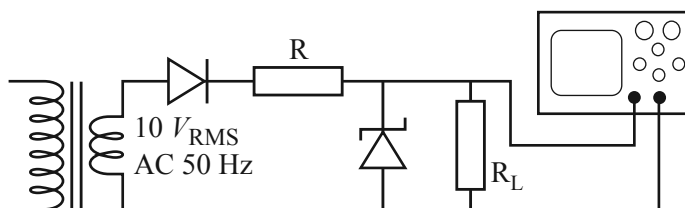

Figure 7b

Question 7

Which one of the following best describes the diode used in the test?

- A. a 0.7 V Zener diode
- B. a 1.4 V Zener diode
- C. a 4.0 V Zener diode
- D. an 8.0 V Zener diode

Question 8

The students now set up the circuit shown in Figure 8.

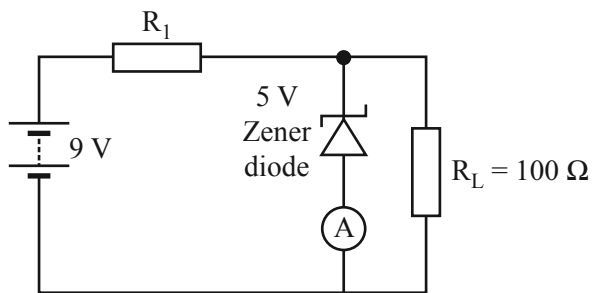

Figure 8

This circuit is powered by a 9 V battery. The current through the ammeter A is 50 mA and the load resistor is 100 Ω . The diode is a 5 V Zener diode.

Which one of the following is closest to the value of resistor R_1 ?

- A. 40 Ω
- B. 50 Ω
- C. 75 Ω
- D. 100 Ω

The students now set up the circuit shown in Figure 9.

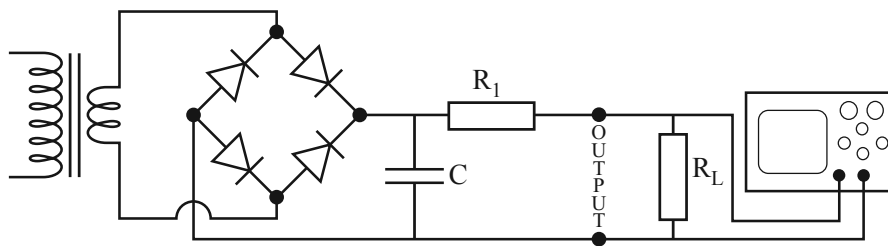

Figure 9

Figure 10 shows the display that they observe on the oscilloscope.

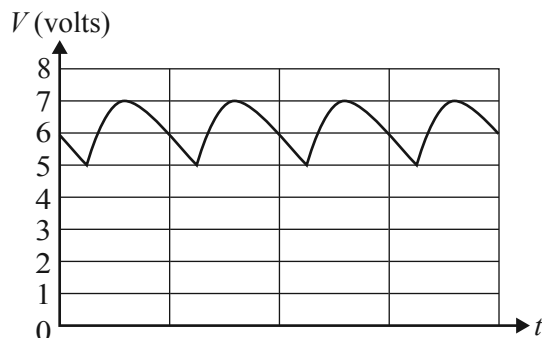

Figure 10

Question 9

They consider the ripple voltage to be too great for their application.

Which one of the changes described below would reduce the magnitude of the ripple voltage?

- A. Decrease the value of R_1 .
- B. Increase the value of the capacitor C .
- C. Decrease the value of the capacitor C .
- D. Increase the output voltage of the transformer.

Use the following information to answer Questions 10 and 11.

The students now set up the complete circuit, as shown in Figure 11. The characteristics of **this** Zener diode are shown in Figure 12.

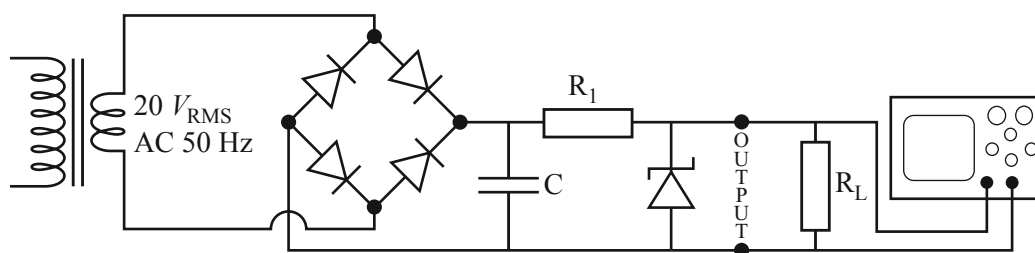

Figure 11

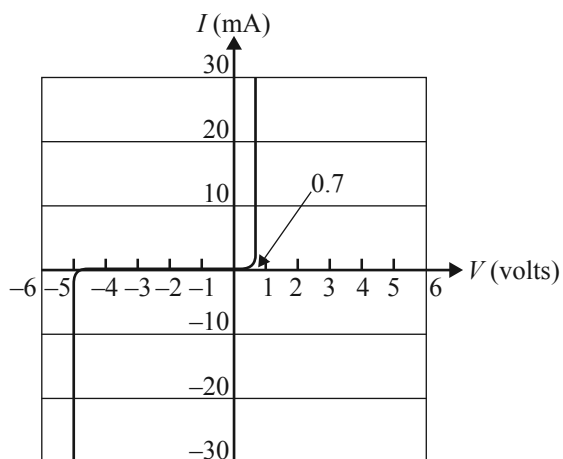

Figure 12

The output voltage to the oscilloscope is shown in Figure 13.

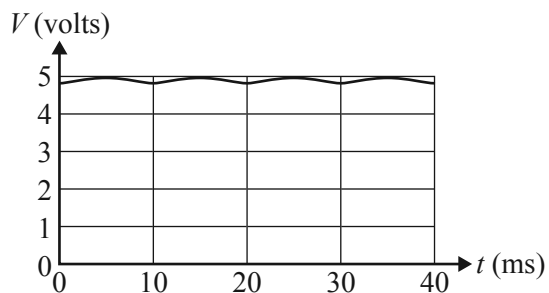
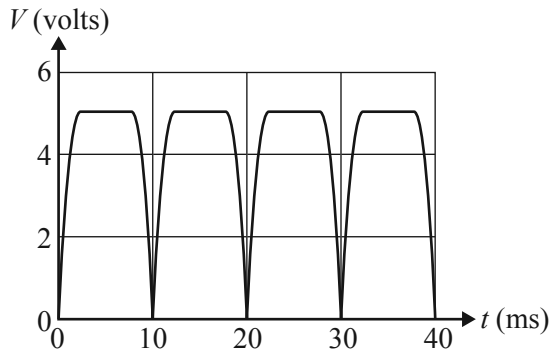

Figure 13

NO WRITING ALLOWED IN THIS AREA

Question 10

After a few minutes of operation, one of the components fails. The output is now as shown in Figure 14.

**Figure 14**

Which one of the following is most likely to have caused this fault?

- A. One diode has failed.
- B. The Zener diode has failed.
- C. The capacitor has failed. The capacitor now acts as an open circuit ($R = \infty$).
- D. The capacitor has failed. The capacitor now acts as a short circuit ($R = 0$).

Question 11

After fixing the fault described in Question 10, the power supply operates correctly for a few more minutes and then fails again. Figure 15 shows the output now seen on the oscilloscope.

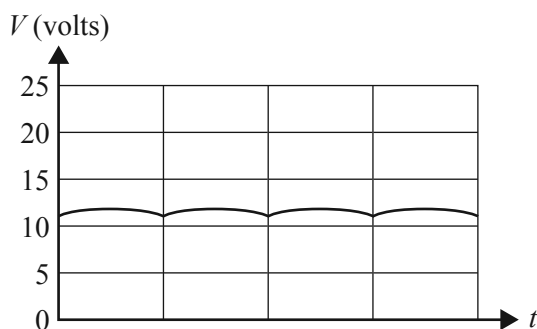
**Figure 15**

Which one of the following is most likely to have caused this fault?

- A. One diode has failed.
- B. The Zener diode has failed.
- C. The capacitor has failed. The capacitor now acts as an open circuit ($R = \infty$).
- D. The capacitor has failed. The capacitor now acts as a short circuit ($R = 0$).

SECTION B**Instructions for Section B**

Select **one** Detailed study and answer **all** questions within that Detailed study in pencil on the answer sheet provided for multiple-choice questions.

Show the Detailed study you are answering by shading the matching box on your multiple-choice answer sheet and writing the name of the Detailed study in the box provided.

Choose the response that is **correct** for the question.

A correct answer scores 2, an incorrect answer scores 0.

Marks will **not** be deducted for incorrect answers.

No marks will be given if more than one answer is completed for any question.

Detailed study 4 – Synchrotron and its applications

Use the following information to answer Questions 1 and 2.

Figure 1 shows a simplified diagram of the electron gun in the Australian Synchrotron.

The potential difference between the plates is equal to 90 kV and the separation of the plates is 0.20 m.

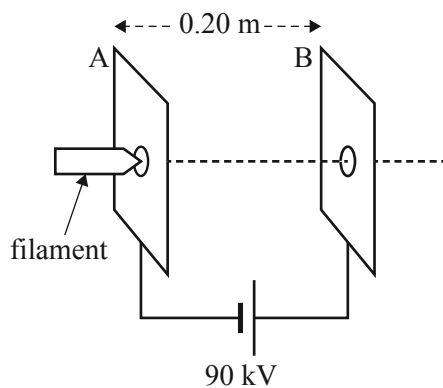

Figure 1

Question 1

Which one of the following best gives the magnitude of the force acting on electrons that enter the space between the plates?

- A. $7.2 \times 10^{-14} \text{ N}$
- B. $7.2 \times 10^{15} \text{ N}$
- C. $4.5 \times 10^{-4} \text{ N}$
- D. $4.5 \times 10^4 \text{ N}$

Question 2

Which one of the following is closest to the kinetic energy of an electron that reaches the positive plate?

- A. 90 kJ
- B. 90 keV
- C. 1.44×10^{-15} kJ
- D. 1.44×10^{-17} keV

Question 3

Figure 2 shows an approximate, simplified graph of the variation in speed of an electron as it moves away from the filament and through the main parts of the Australian Synchrotron.

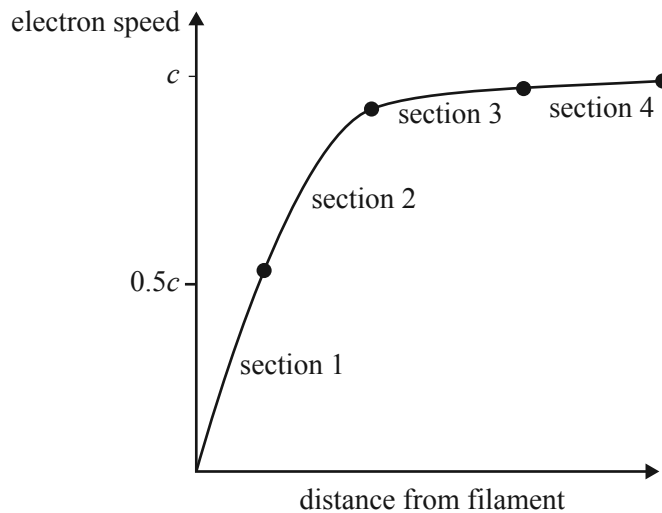

Figure 2
not to scale

Which section of the graph best corresponds to the linac?

- A. section 1
- B. section 2
- C. section 3
- D. section 4

Question 4

Electrons accelerate in

- A. all parts of the synchrotron.
- B. all parts of the synchrotron, except the beamlines.
- C. all parts of the synchrotron, except the storage ring.
- D. all parts of the synchrotron, except the booster ring.

Question 5

X-ray diffraction experiments can be carried out using the Australian Synchrotron. Photons of a single wavelength are required for a particular experiment. The beamline assigned to the research group contains photons with a range of wavelengths.

This problem can be overcome by inserting

- A. a wiggler into the beamline.
- B. a wobblers into the beamline.
- C. an undulator into the beamline.
- D. a monochromator crystal into the beamline.

Question 6

Photons with a wavelength of 0.25 nm are incident on a crystal. Figure 3 is a graph of the intensity against the Bragg angle of the diffracted photons.

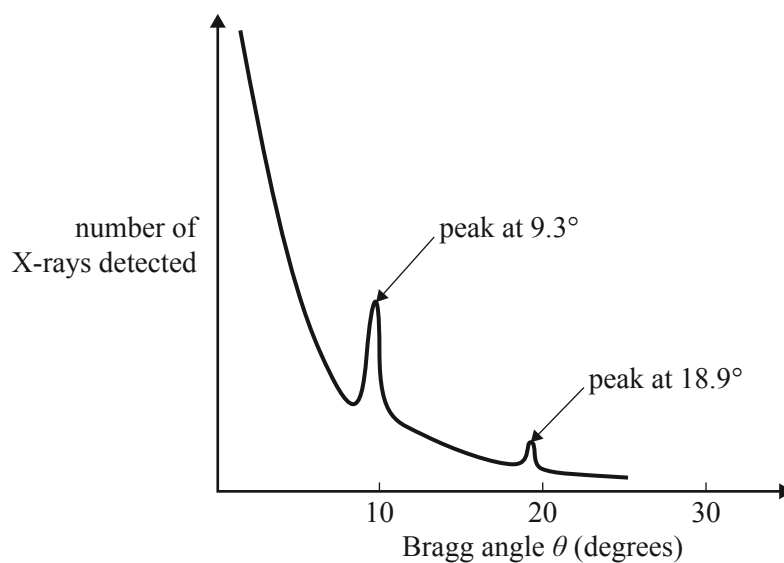

Figure 3

From this data, the spacing between planes of atoms in the crystal would be closest to

- A. 7.7×10^{-1} m
- B. 7.7×10^{-8} m
- C. 7.7×10^{-9} m
- D. 7.7×10^{-10} m

Question 7

In another experiment, photons with a wavelength of 0.4 nm are directed at a crystal with a plane spacing of 0.3 nm. At how many different angles will intensity peaks be observed?

- A. 0
- B. 1
- C. 2
- D. 3

Question 8

Figures 4a and 4b show an X-ray striking a stationary electron head-on and Compton scattering directly backwards.

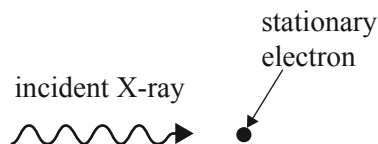
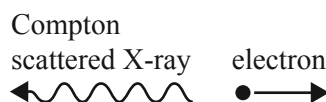
**Figure 4a****Figure 4b**

In Figure 4a, the X-ray is moving to the right. It has a wavelength of 6.9×10^{-12} m. The electron is stationary. In Figure 4b, the electron is moving to the right with a kinetic energy of 74 keV.

Which one of the following is closest to the wavelength of the Compton scattered X-ray?

- A. 1.7×10^{-11} m
- B. 4.5×10^{-12} m
- C. 6.9×10^{-12} m
- D. 12×10^{-12} m

Question 9

An X-ray undergoes Thomson scattering.

This interaction is best described as

- A. pair production.
- B. a diffuse collision.
- C. an elastic collision.
- D. an inelastic collision.

Question 10

Which one of the following statements about wigglers and undulators is correct?

- A. Wigglers produce coherent light over a narrower range of frequencies than undulators.
- B. Undulators produce coherent light over a narrower range of frequencies than wigglers.
- C. Wigglers produce incoherent light over a narrower range of frequencies than undulators.
- D. Undulators produce incoherent light over a narrower range of frequencies than wigglers.

Question 11

An electron in the storage ring has a momentum of 1.6×10^{-18} kg m s⁻¹. It moves along one of the curved sections that has a radius of 40 m.

The magnetic field produced by the bending magnets in this section of the storage ring is closest to

- A. 0.25 T
- B. 0.50 T
- C. 0.75 T
- D. 1.00 T

SECTION B**Instructions for Section B**

Select **one** Detailed study and answer **all** questions within that Detailed study in pencil on the answer sheet provided for multiple-choice questions.

Show the Detailed study you are answering by shading the matching box on your multiple-choice answer sheet and writing the name of the Detailed study in the box provided.

Choose the response that is **correct** for the question.

A correct answer scores 2, an incorrect answer scores 0.

Marks will **not** be deducted for incorrect answers.

No marks will be given if more than one answer is completed for any question.

Detailed study 5 – Photonics**Question 1**

A student's television has an LED that emits red light with a wavelength of 649 nm when the television is on stand-by.

Which one of the following best describes the cause of the red light from the LED?

- A. the transition of electrons from the valence band
- B. the transition of electrons from the conduction band
- C. collisions between thermal valence electrons
- D. collisions between thermal conduction electrons

Question 2

The table below shows the approximate wavelengths of different colours in the visible electromagnetic spectrum.

Colour	Wavelength (nm)
red	650
orange	590
yellow	570
green	510
blue	475
violet	400

An LED has a band gap of 2.1 eV.

Which one of the following best describes the colour of the emitted light?

- A. blue
- B. green
- C. violet
- D. orange

Question 3

The word 'laser' is an acronym for 'light amplification by stimulated emission of radiation'.

Which one of the following best describes what the term 'amplification' refers to?

- A. the conversion of incoherent light to coherent light in the laser
- B. a large population of electrons moving to an excited energy state in the laser
- C. a constant input power causing the emission of photons of many frequencies in the laser
- D. emission of a single photon from one atom causing emission of more identical photons in the laser

Use the following information to answer Questions 4–6.

Optical fibres are constructed of core and cladding, as shown in Figure 1.

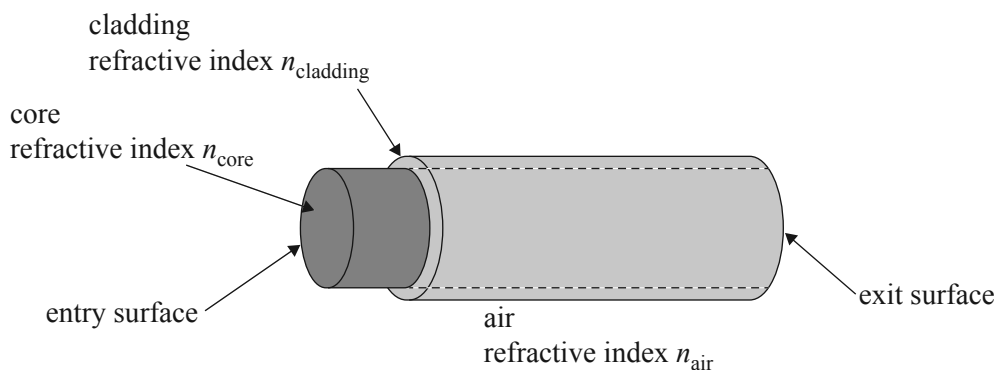

Figure 1

Question 4

At which interface is it necessary that total internal reflection occurs?

- A. the air–core interface at the entry surface
- B. the core–air interface at the exit surface
- C. the core–cladding interface
- D. the cladding–air interface

Question 5

Optical fibre type X is intended for use in the telecommunications industry. The refractive index of the cladding of type X is 1.38 and the refractive index of the core is 1.45.

The critical angle at the boundary between the core and cladding for optical fibre type X is closest to

- A. 18°
- B. 26°
- C. 64°
- D. 72°

Question 6

Optical fibre type X is being evaluated against optical fibre type Y. The cores of both type X and type Y have a refractive index of 1.45. The cladding of type X has a refractive index of 1.38 and that of type Y is 1.39.

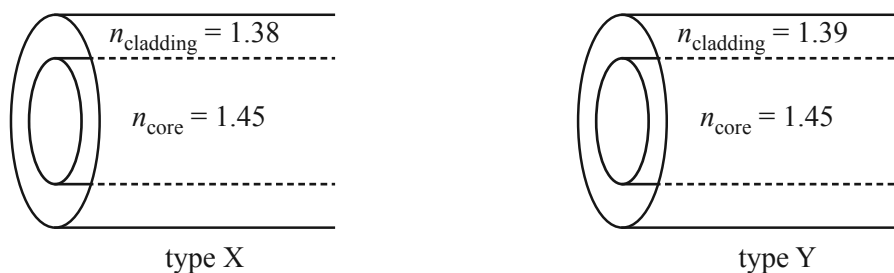

Which one of the following best describes the acceptance angles of the two optical fibre types?

- A. The acceptance angle of type X will be the same as that of type Y.
- B. The acceptance angle of type X will be greater than that of type Y.
- C. The acceptance angle of type X will be smaller than that of type Y.
- D. The acceptance angle of type X may be smaller or greater than that of type Y.

Question 7

The graph in Figure 2 shows the variation of Rayleigh scattering with wavelength for a single-mode optical fibre.

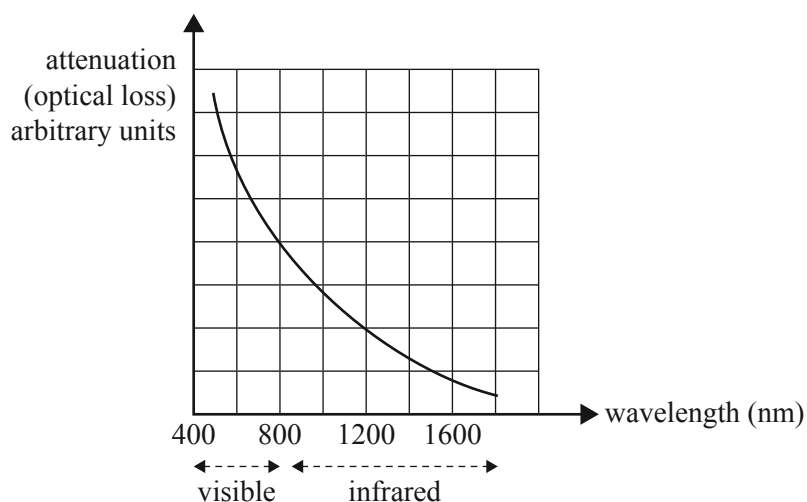

Figure 2

White light is shone into the optical fibre. During its path along the fibre, the light is affected by Rayleigh scattering. The light is viewed from the far end of the optical fibre.

Which one of the following best describes the colour of the light at the far end?

- A. white, with a bluish tinge
- B. white, with less intensity
- C. white, with a yellow-red tinge
- D. white, the same as that which enters the fibre

Question 8

Which one of the following combinations would be the best choice for an optical-fibre based communication system for very long distances?

- A. a multimode fibre combined with an LED light source
- B. a single-mode fibre combined with an LED light source
- C. a multimode fibre combined with a laser diode light source
- D. a single-mode fibre combined with a laser diode light source

Question 9

In fibre-optic imaging, a bundle of many small-diameter fibres is used instead of one large-diameter fibre.

Which one of the following statements gives the best reason for this?

- A. Each fibre captures an image of a small part of the object.
- B. Many fibres can usually capture more light than a single fibre.
- C. Small-diameter fibres are less likely to cause diffraction blurring.
- D. Small-diameter fibres are less likely to leak light in transmission.

Question 10

Students are observing the refraction of light using a light ray passing through the interface of two different media, as shown in Figure 3.

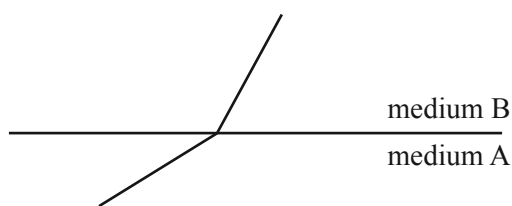

Figure 3

Which one of the following statements best describes a conclusion that can be drawn from this observation about total internal reflection?

- A. It can occur only when light rays travel from medium A to medium B.
- B. It can occur only when light rays travel from medium B to medium A.
- C. It can occur when light rays travel from medium A to medium B, and also from medium B to medium A.
- D. It can never occur between medium A and medium B.

Question 11

Engineers design a simple detector for an alarm on a door. It consists of a short section of optical fibre, with light entering at one end and a photocell at the other end.

With the door shut, the optical fibre is straight. However, when the door is opened, the fibre is bent sharply and the light intensity at the photocell drops. This triggers the alarm. A sketch of the arrangement is shown in Figure 4.

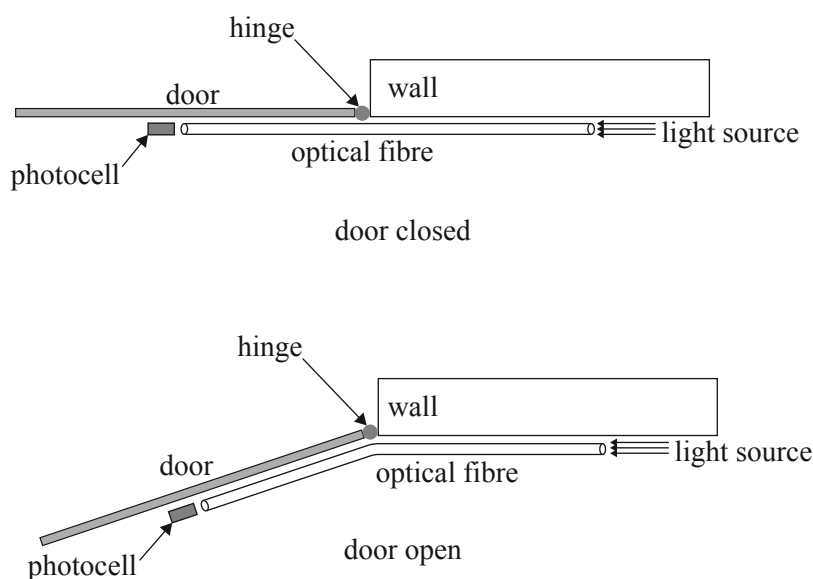

Figure 4

Which one of the following best describes the reason for the drop in light intensity at the photocell?

- A. The acceptance angle has changed.
- B. Absorption within the optical fibre has increased.
- C. The critical angle between the core and the cladding has changed.
- D. Attenuation has increased because of increased light leakage from the core of the fibre to the cladding.

SECTION B**Instructions for Section B**

Select **one** Detailed study and answer **all** questions within that Detailed study in pencil on the answer sheet provided for multiple-choice questions.

Show the Detailed study you are answering by shading the matching box on your multiple-choice answer sheet and writing the name of the Detailed study in the box provided.

Choose the response that is **correct** for the question.

A correct answer scores 2, an incorrect answer scores 0.

Marks will **not** be deducted for incorrect answers.

No marks will be given if more than one answer is completed for any question.

Detailed study 6 – Sound**Question 1**

A small dust particle is at rest in front of a loudspeaker that is not operating. The loudspeaker is then connected to a strong audio signal and switched on. The situation is shown in Figure 1.

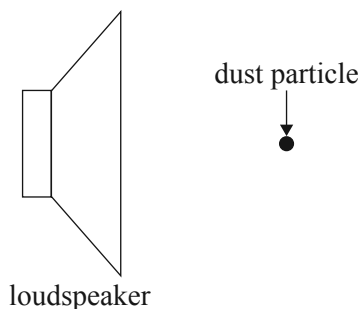
**Figure 1**

Which one of the following statements best describes the motion of the dust particle after the loudspeaker is switched on?

- A. It will be pushed steadily away from the speaker.
- B. It will oscillate vertically about the position shown in Figure 1.
- C. It will not interact with the sound wave; it will remain stationary.
- D. It will oscillate horizontally about the position shown in Figure 1.

Use the following information to answer Questions 2 and 3.

A concert flute, as shown in Figure 2, can be modelled as a tube of length 0.67 m that is open at both ends. Take the speed of sound as 335 m s^{-1} . Assume all the flute holes are closed.

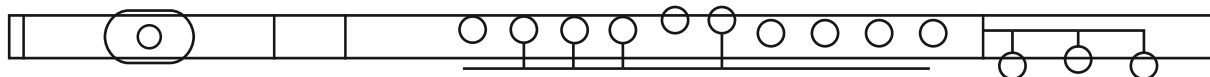

Figure 2

Question 2

The wavelength of the fundamental frequency played by this flute is closest to

- A. 2.68 m
- B. 1.34 m
- C. 0.34 m
- D. 0.17 m

Question 3

The next harmonic above the fundamental will have a frequency closest to

- A. 500 Hz
- B. 375 Hz
- C. 250 Hz
- D. 125 Hz

Use the following information to answer Questions 4 and 5.

Sensational new rock band Students at Work are recording music in a soundproof recording room. The sound engineer left the room, leaving the door open, and stood at point X. The situation is shown in Figure 3.

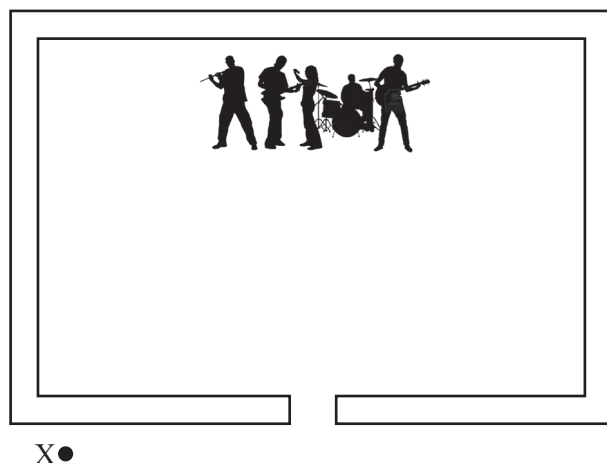

Figure 3

Question 4

The sound engineer commented that the low-frequency notes from the bass guitar were brilliant, but the high-frequency notes in the flute solo were barely audible.

Which one of the following best explains these observations?

- A. The sound made by a flute is always quieter and less intense than that of other instruments.
- B. High-frequency sound is diffracted through the doorway more readily than low-frequency sound.
- C. Long-wavelength sound diffracts more readily through the doorway than short-wavelength sound.
- D. Short-wavelength sound diffracts more readily through the doorway than long-wavelength sound.

Question 5

The same band played on Grandparents' Day. They arranged the seating so that students were seated 2.0 m from the band and grandparents were seated at the end of the hall, a distance of 20 m from the band. Modelling the band as a point source of sound, select the option below that is closest to the value of

$$\frac{\text{sound intensity the students experienced}}{\text{sound intensity the grandparents experienced}}$$

- A. 10 000
- B. 1
- C. 100
- D. 0.01

Question 6

An Occupational Health and Safety official checks the difference in sound intensity level in a concert hall during a rehearsal. She finds that the intensity at the back of the hall is only 0.5% of the intensity at the front of the hall.

Which one of the following is closest to the difference in sound intensity level at these two points?

- A. 0.5 dB
- B. 5.0 dB
- C. 20 dB
- D. 23 dB

Question 7

Dynamic loudspeakers, velocity microphones, crystal microphones and electret-condenser microphones are all devices used in sound recording and reproduction. Their operation is based on a range of electrical and electromagnetic effects.

In the table below, identify the option (A.–D.) that links the device with the correct electrical or electromagnetic effect.

	Changing capacitance	Electromagnetic induction	Piezo-electric effect
A.	electret-condenser microphones	dynamic loudspeakers	crystal microphones
B.	crystal microphones	velocity microphones	electret-condenser microphones
C.	crystal microphones	dynamic loudspeakers	electret-condenser microphones
D.	electret-condenser microphones	velocity microphones	crystal microphones

Question 8

A student is testing the performance of a loudspeaker. First, the student suspends the loudspeaker in free air. Next, the loudspeaker is mounted on a large wooden board, as shown in Figure 4. The student finds the volume of the sound produced by the mounted loudspeaker increased markedly, particularly at low frequencies.

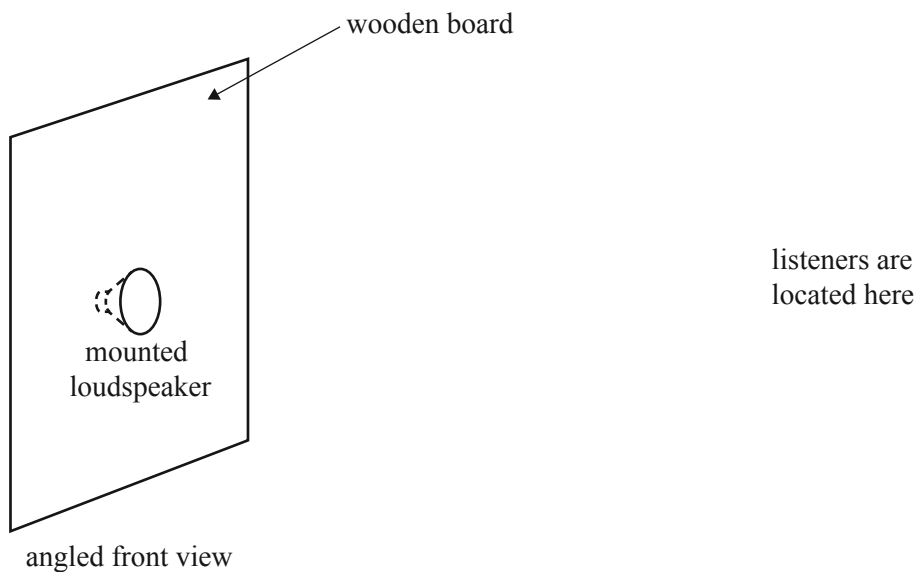
**Figure 4**

Which one of the following best explains why the increase in volume occurs?

- A. The low frequencies from the front of the loudspeaker diffract more easily.
- B. The out-of-phase waves from the back of the loudspeaker are blocked by the board.
- C. The board supports the loudspeaker framework and enables it to work more efficiently.
- D. Particles in the board act as sound sources for low frequencies and hence increase the volume.

Question 9

A loudspeaker connected to a signal generator is placed near a microphone. The microphone is connected to an oscilloscope. The display on the screen of the oscilloscope is shown in Figure 5.

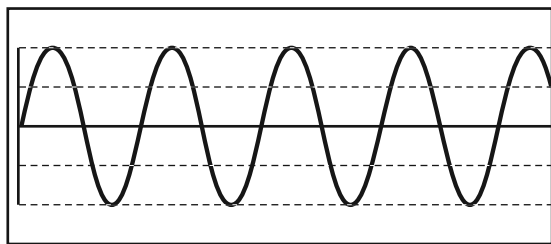
**Figure 5**

The student varies the settings on the signal generator, but the oscilloscope controls are unaltered. The display on the screen now is shown in Figure 6.

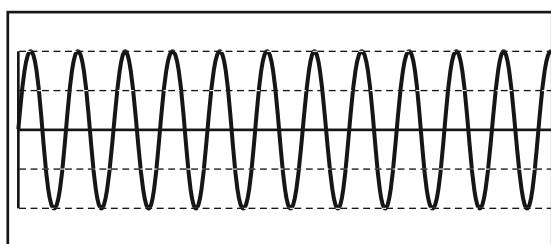
**Figure 6**

The sound entering the microphone (compared with the earlier situation) is best described as

- A. of smaller intensity.
- B. of greater wavelength.
- C. having a greater frequency.
- D. travelling at a greater speed.

Question 10

A simplified graph of the frequency response for a typical human ear is shown in Figure 7. Lines of equal phon value are shown.

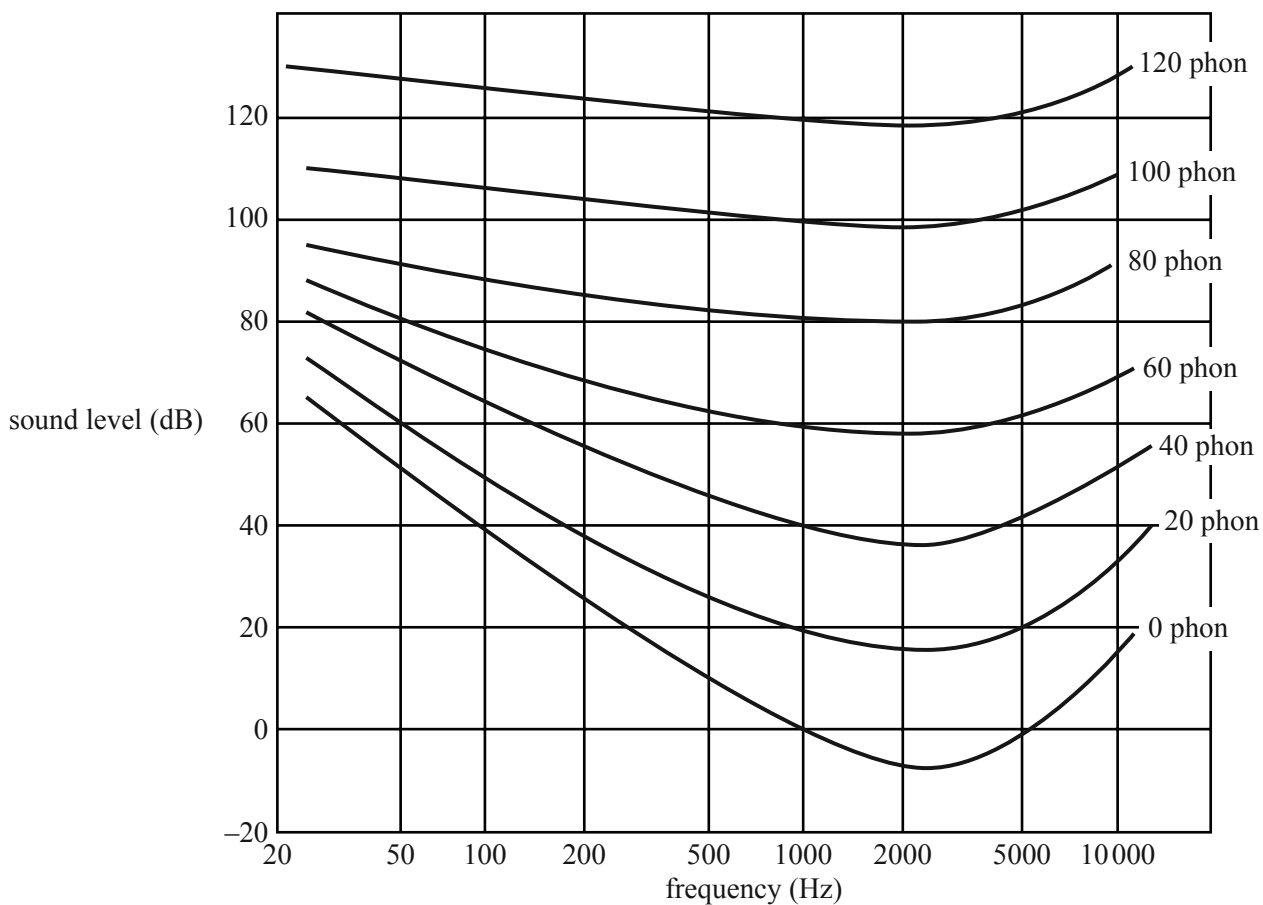
**Figure 7**

Which one of the following is closest to the sound intensity level at 10 kHz that will be heard with the same loudness as 50 Hz at 80 dB?

- A. 50 dB
- B. 60 dB
- C. 70 dB
- D. 80 dB

Question 11

A teacher asks a student to identify a gas contained in a tube by measuring the speed of sound.

The student connects a signal generator to a loudspeaker and a microphone is moved away from the speaker (to the right of the page) until a minimum (node) is displayed on the oscilloscope.

At a frequency of 500 Hz, the student finds the distance between two adjacent nodes to be 0.96 m.

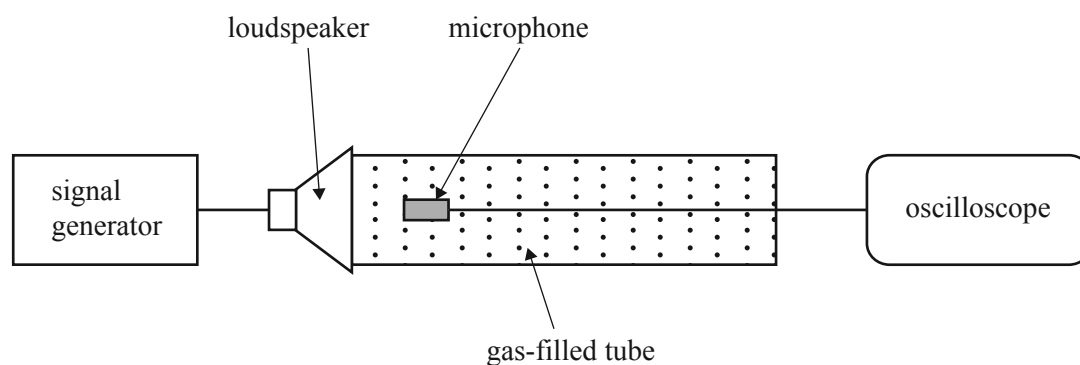

Figure 8

Which one of the following is the most likely speed of sound in the gas?

- A. 480 m s^{-1}
- B. 500 m s^{-1}
- C. 960 m s^{-1}
- D. 1000 m s^{-1}



Victorian Certificate of Education 2013

PHYSICS

Written examination

Wednesday 13 November 2013

Reading time: 9.00 am to 9.15 am (15 minutes)

Writing time: 9.15 am to 11.45 am (2 hours 30 minutes)

FORMULA SHEET

Directions to students

- A question and answer book is provided with this formula sheet.

Students are NOT permitted to bring mobile phones and/or any other unauthorised electronic devices into the examination room.

1	velocity; acceleration	$v = \frac{\Delta x}{\Delta t}; \quad a = \frac{\Delta v}{\Delta t}$
2	equations for constant acceleration	$v = u + at$ $x = ut + \frac{1}{2}at^2$ $v^2 = u^2 + 2ax$ $x = \frac{1}{2}(v + u)t$
3	Newton's second law	$\Sigma F = ma$
4	circular motion	$a = \frac{v^2}{r} = \frac{4\pi^2 r}{T^2}$
5	Hooke's law	$F = -kx$
6	elastic potential energy	$\frac{1}{2}kx^2$
7	gravitational potential energy near the surface of Earth	mgh
8	kinetic energy	$\frac{1}{2}mv^2$
9	Newton's law of universal gravitation	$F = G \frac{M_1 M_2}{r^2}$
10	gravitational field	$g = G \frac{M}{r^2}$
11	acceleration due to gravity at Earth's surface	$g = 10 \text{ m s}^{-2}$
12	voltage; power	$V = RI \quad P = VI = I^2 R$
13	resistors in series	$R_T = R_1 + R_2$
14	resistors in parallel	$\frac{1}{R_T} = \frac{1}{R_1} + \frac{1}{R_2}$
15	transformer action	$\frac{V_1}{V_2} = \frac{N_1}{N_2}$
16	AC voltage and current	$V_{\text{RMS}} = \frac{1}{\sqrt{2}} V_{\text{peak}} \quad I_{\text{RMS}} = \frac{1}{\sqrt{2}} I_{\text{peak}}$
17	magnetic force	$F = I l B$

18	electromagnetic induction	emf : $\varepsilon = -N \frac{\Delta\Phi}{\Delta t}$ flux: $\Phi = BA$
19	transmission losses	$V_{\text{drop}} = I_{\text{line}} R_{\text{line}}$ $P_{\text{loss}} = I_{\text{line}}^2 R_{\text{line}}$
20	mass of the electron	$m_e = 9.1 \times 10^{-31} \text{ kg}$
21	charge on the electron	$e = -1.6 \times 10^{-19} \text{ C}$
22	Planck's constant	$h = 6.63 \times 10^{-34} \text{ J s}$ $h = 4.14 \times 10^{-15} \text{ eV s}$
23	speed of light	$c = 3.0 \times 10^8 \text{ m s}^{-1}$
24	photoelectric effect	$E_{K\text{max}} = hf - W$
25	photon energy	$E = hf$
26	photon momentum	$p = \frac{h}{\lambda}$
27	de Broglie wavelength	$\lambda = \frac{h}{p}$
28	speed, frequency and wavelength	$v = f\lambda$
29	energy transformations for electrons in an electron gun (<100 keV)	$\frac{1}{2}mv^2 = eV$
30	radius of electron path	$r = \frac{mV}{eB}$
31	magnetic force on a moving electron	$F = evB$
32	Bragg's law	$n\lambda = 2d\sin\theta$
33	electric field between charged plates	$E = \frac{V}{d}$
34	band gap energy	$E = \frac{hc}{\lambda}$
35	Snell's law	$n_1 \sin\theta_1 = n_2 \sin\theta_2$
36	intensity and level	sound intensity level (in dB) $L(\text{dB}) = 10\log_{10}\left(\frac{I}{I_0}\right)$ where $I_0 = 1.0 \times 10^{-12} \text{ W m}^{-2}$

37	Lorentz factor	$\gamma = \frac{1}{\sqrt{1 - \frac{v^2}{c^2}}}$
38	time dilation	$t = t_0 \gamma$
39	length contraction	$L = \frac{L_0}{\gamma}$
40	relativistic mass	$m = m_0 \gamma$
41	total energy	$E_{\text{total}} = E_k + E_{\text{rest}} = mc^2$
42	stress	$\sigma = \frac{F}{A}$
43	strain	$\varepsilon = \frac{\Delta L}{L}$
44	Young's modulus	$E = \frac{\text{stress}}{\text{strain}}$
45	capacitors	time constant : $\tau = RC$
46	universal gravitational constant	$G = 6.67 \times 10^{-11} \text{ N m}^2 \text{ kg}^{-2}$
47	mass of Earth	$M_E = 5.98 \times 10^{24} \text{ kg}$
48	radius of Earth	$R_E = 6.37 \times 10^6 \text{ m}$
49	mass of the electron	$m_e = 9.1 \times 10^{-31} \text{ kg}$
50	charge on the electron	$e = -1.6 \times 10^{-19} \text{ C}$
51	speed of light	$c = 3.0 \times 10^8 \text{ m s}^{-1}$

Prefixes/Units

p = pico = 10^{-12}

n = nano = 10^{-9}

μ = micro = 10^{-6}

m = milli = 10^{-3}

k = kilo = 10^3

M = mega = 10^6

G = giga = 10^9

t = tonne = 10^3 kg

END OF FORMULA SHEET