

Chapter 1 – Reviewing linear equations

Solutions to Exercise 1A

1 a $x + 3 = 6$

$$\therefore x = 3$$

b $x - 3 = 6$

$$\therefore x = 9$$

c $3 - x = 2$

$$-x = -1$$

$$\therefore x = 1$$

d $x + 6 = -2$

$$x + 8 = 0$$

$$\therefore x = -8$$

e $2 - x = -3$

$$-x = -5$$

$$\therefore x = 5$$

f $2x = 4$

$$\therefore x = 2$$

g $3x = 5$

$$\therefore x = \frac{5}{3}$$

h $-2x = 7$

$$\therefore x = -\frac{7}{2}$$

i $-3x = -7$

$$\therefore x = \frac{7}{3}$$

j $\frac{3x}{4} = 5$

$$3x = 20$$

$$\therefore x = \frac{20}{3}$$

k $-\frac{3x}{5} = 2$

$$-3x = 10$$

$$\therefore x = -\frac{10}{3}$$

l $-\frac{5x}{7} = -2$

$$-5x = -14$$

$$\therefore x = \frac{-14}{-5} = \frac{14}{5}$$

2 a $x - b = a$

$$\therefore x = a + b$$

b $x + b = a$

$$\therefore x = a - b$$

c $ax = b$

$$\therefore x = \frac{b}{a}$$

d $\frac{x}{a} = b$

$$\therefore x = ab$$

e $\frac{ax}{b} = c$

$$ax = bc$$

$$\therefore x = \frac{bc}{a}$$

3 a

$$\begin{aligned}2y - 4 &= 6 \\2y &= 10 \\y &= 5\end{aligned}$$

b

$$\begin{aligned}3t + 2 &= 17 \\3t &= 15 \\t &= 5\end{aligned}$$

c

$$\begin{aligned}2y + 5 &= 2 \\2y &= -3 \\y &= -\frac{3}{2}\end{aligned}$$

d

$$\begin{aligned}7x - 9 &= 5 \\7x &= 14 \\x &= 2\end{aligned}$$

e

$$\begin{aligned}2a - 4 &= 7 \\2a &= 11 \\a &= \frac{11}{2}\end{aligned}$$

f

$$\begin{aligned}3a + 6 &= 14 \\3a &= 8 \\a &= \frac{8}{3}\end{aligned}$$

g

$$\begin{aligned}\frac{y}{8} - 11 &= 6 \\ \frac{y}{8} &= 17 \\ y &= 136\end{aligned}$$

h

$$\begin{aligned}\frac{t}{3} + \frac{1}{6} &= \frac{1}{2} \\ \frac{t}{3} &= \frac{1}{3} \\ t &= 1\end{aligned}$$

i

$$\begin{aligned}\frac{x}{3} + 5 &= 9 \\ \frac{x}{3} &= 4 \\ x &= 12\end{aligned}$$

j

$$\begin{aligned}3 - 5y &= 12 \\ -5y &= 9 \\ y &= -\frac{9}{5}\end{aligned}$$

k

$$\begin{aligned}-3x - 7 &= 14 \\ -3x &= 21 \\ x &= -7\end{aligned}$$

l

$$\begin{aligned}14 - 3y &= 8 \\ -3y &= -6 \\ y &= 2\end{aligned}$$

4 a $6x - 4 = 3x$

$$\begin{aligned}3x &= 4 \\ \therefore x &= \frac{4}{3}\end{aligned}$$

b $x - 5 = 4x + 10$

$$\begin{aligned}-3x &= 15 \\ \therefore x &= \frac{15}{-3} = -5\end{aligned}$$

$$\begin{aligned} \mathbf{c} \quad 3x - 2 &= 8 - 2x \\ 5x &= 10 \\ \therefore x &= 2 \end{aligned}$$

$$\begin{aligned} \mathbf{5 a} \quad 2(y + 6) &= 10 \\ y + 6 &= 5 \\ \therefore y &= 5 - 6 = -1 \end{aligned}$$

$$\begin{aligned} \mathbf{b} \quad 2y + 6 &= 3(y - 4) \\ 2y + 6 &= 3y - 12 \\ -y &= -18 \\ \therefore y &= 18 \end{aligned}$$

$$\begin{aligned} \mathbf{c} \quad 2(x + 4) &= 7x + 2 \\ 2x + 8 &= 7x + 2 \\ -5x &= -6 \\ \therefore x &= \frac{6}{5} \end{aligned}$$

$$\begin{aligned} \mathbf{d} \quad 5(y - 3) &= 2(2y + 4) \\ 5y - 15 &= 4y + 8 \\ 5y - 4y &= 18 + 8 \\ \therefore y &= 23 \end{aligned}$$

$$\begin{aligned} \mathbf{e} \quad x - 6 &= 2(x - 3) \\ x - 6 &= 2x - 6 \\ -x &= 0 \\ \therefore x &= 0 \end{aligned}$$

$$\begin{aligned} \mathbf{f} \quad \frac{y + 2}{3} &= 4 \\ y + 2 &= 12 \\ \therefore y &= 10 \end{aligned}$$

$$\begin{aligned} \mathbf{g} \quad \frac{x}{2} + \frac{x}{3} &= 10 \\ \frac{5x}{6} &= 10 \\ 5x &= 60 \\ \therefore x &= 12 \end{aligned}$$

$$\begin{aligned} \mathbf{h} \quad x + 4 &= \frac{3x}{2} \\ -\frac{x}{2} &= -4 \\ -x &= -8 \\ \therefore x &= 8 \end{aligned}$$

$$\begin{aligned} \mathbf{i} \quad \frac{7x + 3}{2} &= \frac{9x - 8}{4} \\ 14x + 6 &= 9x - 8 \\ 5x &= -14 \\ \therefore x &= -\frac{14}{5} \end{aligned}$$

$$\begin{aligned} \mathbf{j} \quad \frac{2}{3}(1 - 2x) - 2x &= -\frac{2}{5} + \frac{4}{3}(2 - 3x) \\ 10(1 - 2x) - 30x &= -6 + 20(2 - 3x) \\ 10 - 20x - 30x &= -6 + 40 - 60x \\ 10x &= 24 \\ \therefore x &= \frac{12}{5} \end{aligned}$$

$$\begin{aligned} \mathbf{k} \quad \frac{4y - 5}{2} - \frac{2y - 1}{6} &= y \\ (12y - 15) - (2y - 1) &= 6y \\ 12y - 15 - 2y + 1 &= 6y \\ 4y &= 14 \\ \therefore y &= \frac{7}{2} \end{aligned}$$

6 a $ax + b = 0$

$$ax = -b$$

$$\therefore x = -\frac{b}{a}$$

b $cx + d = e$

$$cx = e - d$$

$$\therefore x = \frac{e - d}{c}$$

c $a(x + b) = c$

$$x + b = \frac{c}{a}$$

$$\therefore x = \frac{c}{a} - b$$

d $ax + b = cx$

$$ax - cx = -b$$

$$x(c - a) = b$$

$$\therefore x = \frac{b}{c - a}$$

e $\frac{x}{a} + \frac{x}{b} = 1$

$$bx + ax = ab$$

$$x(a + b) = ab$$

$$\therefore x = \frac{ab}{a + b}$$

f $\frac{a}{x} + \frac{b}{x} = 1$

$$\therefore x = a + b$$

g $ax - b = cx - d$

$$ax - cx = b - d$$

$$x(a - c) = b - d$$

$$\therefore x = \frac{b - d}{a - c}$$

h $\frac{ax + c}{b} = d$

$$ax + c = bd$$

$$ax = bd - c$$

$$\therefore x = \frac{bd - c}{a}$$

7 a $0.2x + 6 = 2.4$

$$0.2x = -3.6$$

$$\therefore x = -18$$

b $0.6(2.8 - x) = 48.6$

$$2.8 - x = 81$$

$$-x = 78.2$$

$$\therefore x = -78.2$$

c $\frac{2x + 12}{7} = 6.5$

$$2x + 12 = 45.5$$

$$x + 6 = 22.75$$

$$\therefore x = 16.75$$

d $0.5x - 4 = 10$

$$0.5x = 14$$

$$\therefore x = 28$$

e $\frac{1}{4}(x - 10) = 6$

$$x - 10 = 24$$

$$\therefore x = 34$$

f $6.4x + 2 = 3.2 - 4x$

$$10.4x = 1.2$$

$$\therefore x = \frac{1.2}{10.4} = \frac{3}{26}$$

$$\begin{aligned}
 8 \quad & \frac{b-cx}{a} + \frac{a-cx}{b} + 2 = 0 \\
 & b(b-cx) + a(a-cx) + 2ab = 0 \\
 & b^2 - bcx + a^2 - acx + 2ab = 0 \\
 & b^2 + a^2 + 2ab = acx + bcx \\
 & (a+b)^2 = cx(a+b) \\
 & \therefore x = \frac{a+b}{c}
 \end{aligned}$$

so long as $a+b \neq 0$

$$\begin{aligned}
 9 \quad & \frac{a}{x+a} + \frac{b}{x-b} = \frac{a+b}{x+c} \\
 & \frac{a(x-b) + b(x+a)}{(x+a)(x-b)} = \frac{a+b}{x+c} \\
 & \frac{ax-ab+bx+ab}{(x+a)(x-b)} = \frac{a+b}{x+c} \\
 & \frac{ax+bx}{(x+a)(x-b)} = \frac{a+b}{x+c} \\
 & \frac{x}{(x+a)(x-b)} = \frac{1}{x+c} \\
 & x(x+c) = (x+a)(x-b) \\
 & x^2 + cx = x^2 + ax - bx - ab \\
 & cx - ax + bx = -ab \\
 & x(a-b-c) = ab \\
 & \therefore x = \frac{ab}{a-b-c} \\
 & \text{so long as } a+b \neq 0
 \end{aligned}$$

Solutions to Exercise 1B

1 a $x + 2 = 6$

$$\therefore x = 4$$

b $3x = 10$

$$\therefore x = \frac{10}{3}$$

c $3x + 6 = 22$

$$3x = 16$$

$$\therefore x = \frac{16}{3}$$

d $3x - 5 = 15$

$$3x = 20$$

$$\therefore x = \frac{20}{3}$$

e $6(x + 3) = 56$

$$x + 3 = \frac{56}{6} = \frac{28}{3}$$

$$\therefore x = \frac{19}{3}$$

f $\frac{x + 5}{4} = 23$

$$x + 5 = 92$$

$$\therefore x = 87$$

2 $A + 3A + 2A = 48$

$$6A = 48$$

$$\therefore A = 8$$

A gets \$8, B \$24 and C \$16

3 $y = 2x; x + y = 42 = 3x$

$$x = \frac{42}{3}$$

$$\therefore x = 14, y = 28$$

4 $\frac{x}{3} + \frac{1}{3} = 3$

$$x + 1 = 9$$

$$\therefore x = 8 \text{ kg}$$

5 $L = w + 0.5; A = Lw$

$$P = 2(L + w)$$

$$= 2(2w + 0.5)$$

$$= 4w + 1$$

$$4w + 1 = 4.8$$

$$4w = 3.8$$

$$\therefore w = 0.95$$

$$A = 0.95(0.95 + 0.5)$$

$$= 1.3775 \text{ m}^2$$

6 $(n - 1) + n + (n + 1) = 150$

$$3n = 150$$

$$\therefore n = 50$$

Sequence = 49, 50 & 51, assuming n is the middle number.

7 $n + (n + 2) + (n + 4) + (n + 6) = 80$

$$4n + 12 = 80$$

$$4n = 68$$

$$\therefore n = 17$$

17, 19, 21 and 23 are the odd numbers.

8 $6(x - 3000) = x + 3000$

$$6x - 18000 = x + 3000$$

$$5x = 21000$$

$$\therefore x = 4200 \text{ L}$$

$$\begin{aligned}
 \mathbf{9} \quad 140(p - 3) &= 120p \\
 140p - 420 &= 120p \\
 20p &= 420 \\
 \therefore p &= 21
 \end{aligned}$$

$$\begin{aligned}
 \mathbf{10} \quad \frac{x}{6} + \frac{x}{10} &= \frac{48}{60} \\
 5x + 3x &= 24 \\
 8x &= 24 \\
 x &= 3 \text{ km}
 \end{aligned}$$

11 Profit = x for crate 1 and $0.5x$ for crate 2, where x = amount of dozen eggs in each crate.

$$\begin{aligned}
 x + \frac{x + 3}{2} &= 15 \\
 2x + x + 3 &= 30 \\
 3x &= 27
 \end{aligned}$$

$\therefore x = 9$
Crate 1 has 9 dozen, crate 2 has 12 dozen.

$$\begin{aligned}
 \mathbf{12} \quad 3\left(\frac{45}{60}\right) + x\left(\frac{30}{60}\right) &= 6 \\
 \frac{9}{4} + \frac{x}{2} &= 6 \\
 \frac{x}{2} &= \frac{15}{4} \\
 \therefore x &= \frac{15}{2} = 7.5 \text{ km/hr}
 \end{aligned}$$

13

$$\begin{aligned}
 t &= \frac{x}{4} + \frac{x}{6} = \frac{45}{60} \\
 60 \times \frac{x}{4} + 60 \times \frac{x}{6} &= 45 \\
 15x + 10x &= 45 \\
 25x &= 45 \\
 x &= \frac{45}{25} \\
 &= \frac{9}{5} \\
 &= 1.8
 \end{aligned}$$

$$\text{Total} = 2 \times 1.8$$

$$= 3.6 \text{ km (there and back)}$$

$$\text{Total} = 4 \times 0.9$$

$$= 3.6 \text{ km there and back twice}$$

14

$$\begin{aligned}
 f &= b + 24 \\
 (f + 2) + (b + 2) &= 40 \\
 b + 26 + b + 2 &= 40 \\
 2b &= 12 \\
 \therefore b &= 6
 \end{aligned}$$

The boy is 6, the father 30.

Solutions to Exercise 1C

1 a $y = 2x + 1 = 3x + 2$

$$-x = 1, \therefore x = -1$$

$$\therefore y = 2(-1) + 1 = -1$$

b $y = 5x - 4 = 3x + 6$

$$2x = 10, \therefore x = 5$$

$$\therefore y = 5(5) - 4 = 21$$

c $y = 2 - 3x = 5x + 10$

$$-8x = 8, \therefore x = -1$$

$$\therefore y = 2 - 3(-1) = 5$$

d $y - 4 = 3x$ (1)

$$y - 5x + 6 = 0$$
 (2)

From (1) $y = 3x + 4$

Substitute in (2).

$$3x + 4 - 5x + 6 = 0$$

$$-2x + 10 = 0$$

$$x = 5$$

Substitute in (1). $y - 4 = 15$.

Therefore $x = 5$ and $y = 19$.

e $y - 4x = 3$ (1)

$$2y - 5x + 6 = 0$$
 (2)

From (1) $y = 4x + 3$

Substitute in (2).

$$2(4x + 3) - 5x + 6 = 0$$

$$3x + 12 = 0$$

$$x = -4$$

Substitute in (1). $y + 16 = 3$.

Therefore $x = -4$ and $y = -13$.

f $y - 4x = 6$ (1)

$$2y - 3x = 4$$
 (2)

From (1) $y = 4x + 6$

Substitute in (2).

$$2(4x + 6) - 3x = 4$$

$$5x + 12 = 4$$

$$5x = -8$$

$$x = -\frac{8}{5}$$

Substitute in (1). $y - 4 \times \left(-\frac{8}{5}\right) = 6$.

$$y = \frac{50}{3}$$

Therefore $x = -\frac{8}{5}$ and $y = \frac{50}{3}$.

2 a $x + y = 6$

$$x - y = 10$$

$$\frac{2x}{2x} = 16$$

$$\therefore x = 8; y = 6 - 8 = -2$$

b $y - x = 5$

$$y + x = 3$$

$$\frac{2y}{2y} = 8$$

$$\therefore y = 4; x = 3 - 4 = -1$$

c $x - 2y = 6$

$$-(x + 6y = 10)$$

$$\frac{-8y}{-8y} = -4$$

$$\therefore y = \frac{1}{2}, x = 6 + \frac{2}{2} = 7$$

3 a $2x - 3y = 7$

$$9x + 3y = 15$$

$$\frac{11x}{11x} = 22$$

$$\therefore px = 2$$

$$4 - 3y = 7, \therefore y = -1$$

b $4x - 10y = 20$

$$\underline{\underline{-(4x + 3y = 7)}}$$

$$\begin{aligned}
 -13y &= 13 \\
 \therefore y &= -1 \\
 4x - 3 &= 7, \therefore x = 2.5
 \end{aligned}$$

c $4m - 2n = 2$

$$\begin{aligned}
 \frac{m + 2n}{5m} &= \frac{8}{10} \\
 \therefore m &= 2 \\
 8 - 2n &= 2, \therefore n = 3
 \end{aligned}$$

d $14x - 12y = 40$

$$\begin{aligned}
 \frac{9x + 12y}{23x} &= \frac{6}{46} \\
 \therefore x &= 2 \\
 14 - 6y &= 20, \therefore y = -1
 \end{aligned}$$

e $6s - 2t = 2$

$$\begin{aligned}
 \frac{5s + 2t}{11s} &= \frac{20}{22} \\
 \therefore s &= 2 \\
 6 - t &= 1, \therefore t = 5
 \end{aligned}$$

f $16x - 12y = 4$

$$\begin{aligned}
 -15x + 12y &= 6 \\
 \frac{x}{x} &= \frac{10}{10} \\
 \therefore 4y - 5(10) &= 2 \\
 \therefore y &= 13
 \end{aligned}$$

g $15x - 4y = 6$

$$\begin{aligned}
 -(18x - 4y) &= 10 \\
 \frac{-3x}{-3x} &= \frac{-4}{-4} \\
 \therefore x &= \frac{4}{3} \\
 9\left(\frac{4}{3}\right) - 2y &= 5 \\
 -2y &= -7, \therefore y = \frac{7}{2}
 \end{aligned}$$

h $2p + 5q = -3$

$$\frac{7p - 2q}{7p - 2q} = 9$$

$$4p + 10q = -6 \quad 39p = 39$$

$$\begin{aligned}
 \frac{35p - 10q}{p} &= \frac{45}{1} \\
 \therefore q &= -1
 \end{aligned}$$

i $2x - 4y = -12$

$$\begin{aligned}
 \frac{6x + 4y}{8x} &= \frac{4}{-8} \\
 \therefore x &= -1 \\
 2y - 3 - 2 &= 0, \therefore y = \frac{5}{2}
 \end{aligned}$$

4 a $3x + y = 6 \quad (1)$

$$6x + 2y = 7 \quad (2)$$

Multiply (1) by 2.

$$6x + 2y = 12 \quad (3)$$

Subtract (2) from (3)

$$0 = 5.$$

There are no solutions.

The graphs of the two straight lines are parallel.

b $3x + y = 6 \quad (1)$

$$6x + 2y = 12 \quad (2)$$

Multiply (1) by 2.

$$6x + 2y = 12 \quad (3)$$

Subtract (2) from (3)

$$0 = 0.$$

There are infinitely many solutions.

The graphs of the two straight lines coincide.

c $3x + y = 6 \quad (1)$

$$6x - 2y = 7 \quad (2)$$

Multiply (1) by 2.

$$6x + 2y = 12 \quad (3)$$

Add (2) and (3)

$$12x = 19.$$

$x = \frac{19}{12}$ and $y = \frac{5}{4}$. There is only one solution.

The graphs intersect at the point $\left(\frac{19}{12}, \frac{5}{4}\right)$

d $3x - y = 6$ (1)

$6x + 2y = 7$ (2)

Multiply (1) by 2.

$6x - 2y = 12$ (3)

Add (2) and (3)

$12x = 19.$

$x = \frac{19}{12}$ and $y = -\frac{5}{4}$. There is only one solution.

The graphs intersect at the

point $\left(\frac{19}{12}, -\frac{5}{4}\right)$

Solutions to Exercise 1D

1 $x + y = 138$

$$\begin{array}{r} x - y = 88 \\ \hline 2x = 226 \end{array}$$

$\therefore x = 113$

$y = 138 - 113 = 25$

2 $x + y = 36$

$$\begin{array}{r} x - y = 9 \\ \hline 2x = 45 \end{array}$$

$\therefore x = 22.5$

$y = 36 - 22.5 = 13.5$

3 $6S + 4C = 58$

$5S + 2C = 35, \therefore 10S + 4C = 70$

$10S + 4C = 70$

$-(6S + 4C) = 58$

$$\begin{array}{r} 4S = 12 \end{array}$$

$\therefore S = \$3$

$2C = 35 - 35, \therefore C = \10

a $10S + 4C = 10 \times 3 + 4 \times 10$

$= 30 + 40 = \$70$

b $4S = 4 \times 3 = \$12$

c $S = \$3$

4 $7B + 4W = 213$

$B + W = 42, \therefore 4B + 4W = 168$

$7B + 4W = 213$

$-(4B + 4W = 168)$

$$\begin{array}{r} 3B = 45 \end{array}$$

$\therefore B = 15$

$15 + W = 42, \therefore W = \27

a $4B + 4W = 4 \times 15 + 4 \times 27$

$= 60 + 108 = \$168$

b $3B = 3 \times 15 = \$45$

c $B = \$15$

5 $x + y = 45$

$x - 7 = 11$

$$\begin{array}{r} 2x = 56 \end{array}$$

$\therefore x = 28; y = 17$

6 $m + 4 = 3(c + 4) \dots (1)$

$m - 2 = 5(c - 4) \dots (2)$

From (1), $m = 3c + 8$.

Substitute into (2):

$3c + 8 - 4 = 5(c - 4)$

$3c + 4 = 5c - 20$

$-2c = -24, \therefore c = 12$

$\therefore m - 4 = 5(12 - 4)$

$m = 44$

7 $h = 5p$

$h + p = 20$

$\therefore 5p + p = 30$

$\therefore p = 5; h = 25$

8 Let one child have x marbles and the other y marbles.

$$x + y = 110$$

$$\frac{x}{2} = y - 20$$

$$\therefore x = 2y - 40$$

$$\therefore 2y - 40 + y = 110$$

$$3y = 150$$

$$\therefore y = 50; x = 60$$

They started with 50 and 60 marbles, and finished with 30 each.

- 9** Let x be the number of adult tickets and y be the number of child tickets.

$$x + y = 150 \quad (1)$$

$$4x + 1.5y = 560 \quad (2)$$

Multiply (1) by 1.5.

$$1.5x + 1.5y = 225 \quad (1')$$

Subtract (1') from (2)

$$2.5x = 335$$

$$x = 134$$

Substitute in (1). $y = 16$

There were 134 adult tickets and 16 child tickets sold.

- 10** Let a be the numerator and b be the denominator.

$$a + b = 17 \quad (1)$$

$$\frac{a+3}{b} = 1 \quad (2).$$

$$\text{From (2), } a + 3 = b \quad (1')$$

Substitute in (1)

$$a + a + 3 = 17$$

$$2a = 14$$

$$a = 7 \text{ and hence } b = 10.$$

The fraction is $\frac{7}{10}$

- 11** Let the digits be m and n .

$$m + n = 8 \quad (1)$$

$$10n + m - (n + 10m) = 36$$

$$9n - 9m = 36$$

$$n - m = 4 \quad (2)$$

Add (1) and (2)

$$2n = 12 \text{ implies } n = 6.$$

Hence $m = 2$.

The initial number is 26 and the second number is 62.

- 12** Let x be the number of adult tickets and y be the number of child tickets.

$$x + y = 960 \quad (1) \quad 30x + 12y = 19\,080$$

(2)

$$\text{Multiply (1) by 12. } 12x + 12y = 11\,520$$

(1')

Subtract (1') from (2).

$$18x = 7560$$

$$x = 420.$$

There were 420 adults and 540 children.

- 13** $0.1x + 0.07y = 1400 \dots (1)$

$$0.07x + 0.1y = 1490 \dots (2)$$

$$\text{From (1), } x = (14\,000 - 0.7y)$$

From (2):

$$0.07(14\,000 - 0.7y) + 0.1y = 1490$$

$$\therefore 980 - 0.049y + 0.1y = 1490$$

$$0.051y = 510$$

$$\therefore y = \frac{510}{.051}$$

$$= 10\,000$$

From (1):

$$0.1x + 0.07 \times 10\,000 = 1400$$

$$0.1x = 1400 - 700$$

$$= 700$$

$$\therefore x = 7000$$

So $x + y = \$17\,000$ invested.

$$14 \quad \frac{100s}{3} + 20t = 10\,000 \dots (1)$$

$$\left(\frac{100}{3}\right)\left(\frac{s}{2}\right) + 20\left(\frac{2t}{3}\right) = 6000$$

$$\therefore \left(\frac{50s}{3}\right) + \frac{40t}{3} = 6000 \dots (2)$$

From (1):

$$20t = 10\,000 - \frac{100s}{3}$$

$$\therefore t = 500 - \frac{5s}{3} \dots (3)$$

Substitute into (2):

$$\left(\frac{50s}{3}\right) + \left(\frac{40}{3}\right)\left(500 - \frac{5s}{3}\right) = 6000$$

$$150s + 120\left(500 - \frac{5s}{3}\right) = 54\,000$$

$$150s + 60\,000 - 200s = 54\,000$$

$$-50s = -6000$$

$$\therefore s = 120$$

Substitute into (3):

$$t = 500 - \left(\frac{5}{3}\right) \times 120$$

$$= 500 - 200$$

$$\therefore t = 300$$

He sold 120 shirts and 300 ties.

$$15 \quad \text{Outback} = x, \text{ BushWalker} = y; x = 1.2y$$

$$200x + 350y = 177\,000$$

$$200(1.2y) + 350y = 177\,000$$

$$240y + 350y = 177\,000$$

$$\therefore y = \frac{177\,000}{590} = 300$$

$$\therefore x = 1.2 \times 300$$

$$= 360$$

$$16 \quad \text{Mydney} = x \text{ jeans; Selbourne} = y \text{ jeans}$$

$$30x + 28\,000 = 24y + 35\,200 \dots (1)$$

$$x + y = 6000 \dots (2)$$

From (2): $y = 6000 - x$

Substitute in (1):

$$30x + 28\,000 = 24(6000 - x) + 35\,200$$

$$30x + 28\,000 = 144\,000 - 24x + 35\,200$$

$$54x = 151\,200$$

$$\therefore x = 2800; y = 3200$$

$$17 \quad \text{Tea } A = \$10; B = \$11, C = \$12 \text{ per kg}$$

$$B = C; C + B + A = 100$$

$$10A + 11B + 12C = 1120$$

$$10A + 23B = 1120$$

$$\therefore A = 100 - 2B$$

$$10(100 - 2B) + 23B = 1120$$

$$3B = 1120 - 1000$$

$$\therefore B = 40$$

$$A = 20\text{kg}, B = C = 40 \text{ kg}$$

Solutions to Exercise 1E

1 a $x + 3 < 4$

$$x < 4 - 3, \therefore x < 1$$

b $x - 5 > 8$

$$x > 8 + 5, \therefore x > 13$$

c $2x \geq 6$

$$\frac{2x}{2} \geq \frac{6}{2}, \therefore x \geq 3$$

d $\frac{x}{3} \leq 4$

$$3\left(\frac{x}{3}\right) \leq 12, \therefore x \leq 12$$

e $-x \geq 6$

$$0 \geq 6 + x$$

$$-6 \geq x, \therefore x \leq -6$$

f $-2x < -6$

$$-x < -3$$

$$0 < x - 3$$

$$3 < x, \therefore x > 3$$

g $6 - 2x > 10$

$$3 - x > 5$$

$$-x > 2$$

$$0 > x + 2$$

$$-2 > x, \therefore x < -2$$

h $-\frac{3x}{4} \leq 6$

$$-x \leq 8$$

$$0 \leq x + 8$$

$$-8 \leq x, \therefore x \geq -8$$

i $4x - 4 \leq 2$

$$x - 1 \leq \frac{1}{2}, \therefore x \leq \frac{3}{2}$$

2 a $4x + 3 < 11$

$$4x < 8, \therefore x < 2$$

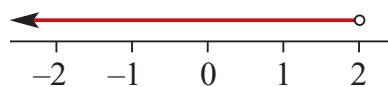

b $3x + 5 < x + 3$

$$2x < -2, \therefore x < -1$$

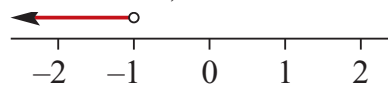

c $\frac{1}{2}(x + 1) - x > 1$

$$\frac{x}{2} + \frac{1}{2} - x > 1$$

$$-\frac{x}{2} > \frac{1}{2}$$

$$-x > 1, \therefore x < -1$$

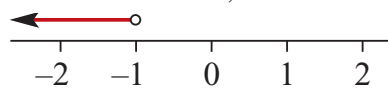

d $\frac{1}{6}(x + 3) \geq 1$

$$x + 3 \geq 6, \therefore x \geq 3$$

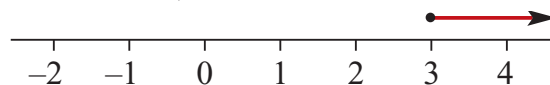

e $\frac{2}{3}(2x - 5) < 2$

$$2x - 5 < 3$$

$$2x < 8, \therefore x < 4$$

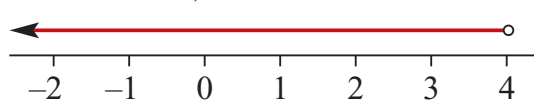

$$\mathbf{f} \quad \frac{3x-1}{4} - \frac{2x+3}{2} < -2$$

$$(3x-1) - (4x+6) < -8$$

$$-x-7 < -8$$

$$-x < -1, \therefore x > 1$$

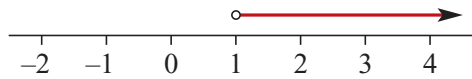

$$\mathbf{g} \quad \frac{4x-3}{2} - \frac{3x-3}{3} < 3$$

$$\frac{4x-3}{2} - (x-1) < 3$$

$$4x-3 - (2x-2) < 6$$

$$2x-1 < 6$$

$$2x < 7, \therefore x < \frac{7}{2}$$

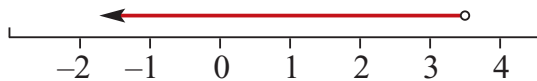

$$\mathbf{h} \quad \frac{1-7x}{-2} \geq 10$$

$$\frac{7x-1}{2} \geq 10$$

$$7x-1 \geq 20$$

$$7x \geq 21, \therefore x \geq 3$$

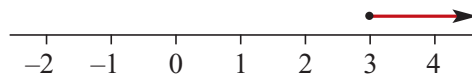

$$\mathbf{i} \quad \frac{5x-2}{3} - \frac{2-x}{3} > -1$$

$$(5x-2) - (2-x) > -3$$

$$6x-4 > -3$$

$$6x > 1, \therefore x > \frac{1}{6}$$

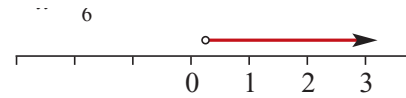

$$\mathbf{3 a} \quad 2x+1 > 0$$

$$2x > -1, \therefore x > -\frac{1}{2}$$

$$\mathbf{b} \quad 100-50x > 0$$

$$100 > 50x$$

$$2 > x, \therefore x < 2$$

$$\mathbf{c} \quad 100+20x > 0$$

$$20x > -100, \therefore x > -5$$

$$\mathbf{4} \quad \text{Let } p \text{ be the number of sheets of paper.}$$

$$3p < 20$$

$$p < \frac{20}{3}$$

$$p \in \mathbb{Z}, \therefore p = 6$$

$$\mathbf{5} \quad \frac{66+72+x}{3} \geq 75$$

$$138+x \geq 225$$

$$\therefore x \geq 87$$

Lowest mark: 87

Solutions to Exercise 1F

1 a $c = ab$

$$= 6 \times 3 = 18$$

b $r = p + q$

$$= 12 + -3 = 9$$

c $c = ab$

$$\begin{aligned}\therefore b &= \frac{c}{a} \\ &= \frac{18}{6} = 3\end{aligned}$$

d $r = p + q$

$$\begin{aligned}\therefore q &= r - p \\ &= -15 - 3 = -18\end{aligned}$$

e $c = \sqrt{a}$

$$= \sqrt{9} = 3$$

f $c = \sqrt{a}$

$$\begin{aligned}\therefore a &= c^2 \\ &= 9^2 = 81\end{aligned}$$

g $p = \frac{u}{v}$

$$= \frac{10}{2} = 5$$

h $p = \frac{u}{v}$

$$\begin{aligned}\therefore u &= pv \\ &= 2 \times 10 = 20\end{aligned}$$

2 a $S = a + b + c$

b $P = xy$

c $C = 5p$

d $T = dp + cq$

e $T = 60a + b$

3 a $E = IR$

$$= 5 \times 3 = 15$$

b $C = pd$

$$= 3.14 \times 10 = 31.4$$

c $P = R\left(\frac{T}{V}\right)$

$$= 60 \times \frac{150}{9} = 1000$$

d $I = \frac{E}{R}$

$$= \frac{240}{20} = 12$$

e $A = \pi rl$

$$= 3.14 \times 5 \times 20 = 314$$

f $S = 90(2n - 4)$

$$= 90(6 \times 2 - 4) = 720$$

4 a $PV = c, \therefore V = \frac{c}{P}$

b $F = ma, \therefore a = \frac{F}{m}$

c $I = Prt, \therefore P = \frac{I}{rt}$

d $w = H + Cr$

$$\therefore Cr = w - H$$

$$\therefore r = \frac{w - H}{C}$$

$$\mathbf{e} \quad S = P(1 + rt)$$

$$\therefore \frac{S}{P} = 1 + rt$$

$$\therefore rt = \frac{S}{P} - 1 = \frac{S - P}{P}$$

$$\therefore t = \frac{S - P}{rP}$$

$$\mathbf{f} \quad V = \frac{2R}{R - r}$$

$$\therefore (R - r)V = 2R$$

$$V - rV - 2R = 0$$

$$R(V - 2) = rV$$

$$\therefore r = \frac{R(V - 2)}{V}$$

$$\mathbf{5} \quad \mathbf{a} \quad D = \frac{T + 2}{P}$$

$$10 = \frac{T + 2}{5}$$

$$T + 2 = 50, \therefore T = 48$$

$$\mathbf{b} \quad A = \frac{1}{2}bh$$

$$40 = \frac{10h}{2}$$

$$10h = 80, \therefore h = 8$$

$$\mathbf{c} \quad V = \frac{1}{3}\pi hr^2$$

$$\therefore h = \frac{3V}{\pi r^2}$$

$$= \frac{300}{25 \times 3.14}$$

$$= \frac{12}{3.14} = 3.82$$

$$\mathbf{d} \quad A = \frac{1}{2}h(a + b)$$

$$50 = \frac{5}{2} \times (10 + b)$$

$$20 = 10 + b, \therefore b = 10$$

$$\mathbf{6} \quad \mathbf{a} \quad l = 4a + 3w$$

$$\mathbf{b} \quad H = 2b + h$$

$$\mathbf{c} \quad A = 3 \times (h \times w) = 3hw$$

\mathbf{d}

$$\text{Area} = H \times l - 3hw$$

$$= (4a + 3w)(2b + h) - 3hw$$

$$= 8ab + 6bw + 4ah + 3hw - 3hw$$

$$= 8ab + 6bw + 4ah$$

$$\mathbf{7} \quad \mathbf{a} \quad \mathbf{i} \quad \text{Circle circumferences} = 2\pi(p + q)$$

Total wire length

$$T = 2\pi(p + q) + 4h$$

$$\mathbf{ii} \quad T = 2\pi(20 + 24) + 4 \times 28$$

$$= 88\pi + 112$$

$$\mathbf{b} \quad A = \pi h(p + q)$$

$$\therefore p + q = \frac{A}{\pi h}$$

$$\therefore p = \frac{A}{\pi h} - q$$

$$\mathbf{8} \quad \mathbf{a} \quad P = \frac{T - M}{D}$$

$$6 = \frac{8 - 4}{D}$$

$$6D = 4, \therefore D = \frac{2}{3}$$

$$\mathbf{b} \quad H = \frac{a}{3} + \frac{a}{b}$$

$$5 = \frac{6}{3} + \frac{6}{b}$$

$$\frac{6}{b} = 5 - 2 = 3$$

$$3b = 6, \therefore b = 2$$

$$\begin{aligned} \text{c} \quad a &= \frac{90(2n-4)}{n} \\ 6 &= \frac{90(2n-4)}{n} \\ 6n &= 90(2n-4) \\ n &= 15(2n-4) \\ n &= 30n-60 \\ 29n &= 30, \therefore n = \frac{60}{29} \end{aligned}$$

$$\begin{aligned} \text{d} \quad R &= \frac{r}{a} + \frac{r}{3} \\ 4 &= \frac{r}{2} + \frac{r}{3} \\ \frac{5r}{6} &= 4 \\ \therefore r &= \frac{24}{5} = 4.8 \end{aligned}$$

$$\begin{aligned} \text{9 a} \quad \text{Big triangle area} &= \frac{1}{2}bc \\ \text{Small triangle area} &= \frac{1}{2}bk \times ck \\ &= \frac{1}{2}bck^2 \\ \text{Shaded area } D &= \frac{1}{2}bc(1-k^2) \end{aligned}$$

$$\begin{aligned} \text{b} \quad D &= \frac{1}{2}bc(1-k^2) \\ 1-k^2 &= \frac{2D}{bc} \\ k^2 &= 1 - \frac{2D}{bc} \\ \therefore k &= \sqrt{1 - \frac{2D}{bc}} \end{aligned}$$

$$\begin{aligned} \text{c} \quad k &= \sqrt{1 - \frac{2D}{bc}} \\ &= \sqrt{1 - \frac{4}{12}} \\ &= \sqrt{\frac{2}{3}} = \frac{\sqrt{6}}{3} \end{aligned}$$

$$\begin{aligned} \text{10 a} \quad \text{Width of each arm} &= c \\ \text{Length of each of the 8 arms} &= \frac{b-c}{2} \\ P &= 8 \times \frac{b-c}{2} + 4c \\ &= 4b - 4c + 4c = 4b \end{aligned}$$

$$\begin{aligned} \text{b} \quad \text{Area of each piece} &= bc, \text{ but the} \\ \text{centre area } (c^2) &\text{ is counted twice} \\ \therefore A &= 2bc - c^2 \end{aligned}$$

$$\begin{aligned} \text{c} \quad 2bc &= A + c^2 \\ \therefore b &= \frac{A + c^2}{2c} \end{aligned}$$

$$\begin{aligned} \text{11 a} \quad a &= \sqrt{a+2b} \\ a^2 &= a+2b \\ 2b &= a(a-1) \\ \therefore b &= \frac{a}{2}(a-1) \end{aligned}$$

$$\begin{aligned} \text{b} \quad \frac{a+x}{a-x} &= \frac{b-y}{b+y} \\ (a+x)(b+y) &= (a-x)(b-y) \\ ab+bx+ay+xy &= ab-bx-ay+xy \\ bx+ay &= -bx-ay \\ 2bx+2ay &= 0 \\ 2bx &= -2ay \\ \therefore x &= -\frac{ay}{b} \end{aligned}$$

$$\begin{aligned} \text{c} \quad px &= \sqrt{3q-r^2} \\ p^2x^2 &= 3q-r^2 \\ r^2 &= 3q-p^2x^2 \\ \therefore r &= \pm\sqrt{3q-p^2x^2} \end{aligned}$$

$$\begin{aligned}
 \mathbf{d} \quad \frac{x}{y} &= \sqrt{1 - \frac{v^2}{u^2}} \\
 \frac{x^2}{y^2} &= 1 - \frac{v^2}{u^2} \\
 \frac{v^2}{u^2} &= 1 - \frac{x^2}{y^2} = \frac{y^2 - x^2}{y^2} \\
 v^2 &= \frac{u^2}{y^2}(y^2 - x^2) \\
 \therefore v &= \pm \frac{u}{y} \sqrt{y^2 - x^2} \\
 &= \pm \sqrt{(u^2) \left(1 - \frac{x^2}{y^2}\right)}
 \end{aligned}$$

Solutions to Technology-free questions

1 a $2x + 6 = 8$

$$2x = 2, \therefore x = 1$$

b $3 - 2x = 6$

$$-2x = 3, \therefore x = -\frac{3}{2}$$

c $2x + 5 = 3 - x$

$$\therefore 3x = -2, \therefore x = -\frac{2}{3}$$

d $\frac{3-x}{5} = 6$

$$3 - x = 30$$

$$-x = 27, \therefore x = -27$$

e $\frac{x}{3} = 4, \therefore x = 12$

f $\frac{13x}{4} - 1 = 10$

$$\frac{13x}{4} = 11$$

$$13x = 44, \therefore x = \frac{44}{13}$$

g $3(2x + 1) = 5(1 - 2x)$

$$6x + 3 = 5 - 10x$$

$$16x = 2, \therefore x = \frac{1}{8}$$

h $\frac{3x+2}{5} + \frac{3-x}{2} = 5$

$$2(3x+2) + 5(3-x) = 50$$

$$6x + 4 + 15 - 5x = 50$$

$$\therefore x = 50 - 19 = 31$$

2 a $a - t = b$

$$a = t + b, \therefore t = a - b$$

b $\frac{at+b}{c} = d$

$$at + b = cd$$

$$at = cd - b$$

$$\therefore t = \frac{cd - b}{a}$$

c $a(t - c) = d$

$$at - ac = d$$

$$at = d + ac$$

$$\therefore t = \frac{d + ac}{a} = \frac{d}{a} + c$$

d $\frac{a-t}{b-t} = c$

$$a - t = c(b - t)$$

$$a - t = cb - ct$$

$$-t + ct = cb - a$$

$$t(c - 1) = cb - a$$

$$\therefore t = \frac{cb - a}{c - 1}$$

e $\frac{at+b}{ct-b} = 1$

$$at + b = ct - b$$

$$at - ct = -2b$$

$$t(c - a) = 2b$$

$$\therefore t = \frac{2b}{c - a}$$

$$\begin{aligned} \mathbf{f} \quad \frac{1}{at+c} &= d \\ dat + dc &= 1 \\ dat &= 1 - dc \\ \therefore t &= \frac{1 - dc}{ad} \end{aligned}$$

$$\mathbf{3 a} \quad 2 - 3x > 0$$

$$2 > 3x$$

$$\frac{2}{3} > x, \therefore x < \frac{2}{3}$$

$$\mathbf{b} \quad \frac{3 - 2x}{5} \geq 60$$

$$3 - 2x \geq 300$$

$$-2x \geq 297$$

$$-297 \geq 2x$$

$$-\frac{297}{2} \geq x$$

$$\therefore x \leq -148.5$$

$$\mathbf{c} \quad 3(58x - 24) + 10 < 70$$

$$3(58x - 24) < 60$$

$$58x - 24 < 20$$

$$58x < 44, \therefore x < \frac{22}{29}$$

$$\mathbf{d} \quad \frac{3 - 2x}{5} - \frac{x - 7}{6} \leq 2$$

$$6(3 - 2x) - 5(x - 7) \leq 60$$

$$18 - 12x - 5x - 35 \leq 60$$

$$53 - 17x \leq 60$$

$$-17x \leq 7$$

$$0 \leq 17x + 7$$

$$-\frac{7}{17} \leq x$$

$$\therefore x \geq -\frac{7}{17}$$

$$\mathbf{4} \quad z = \frac{x}{2} - 3t$$

$$\frac{1}{2}x = z + 3t$$

$$\therefore x = 2z + 6t$$

$$\text{When } z = 4 \text{ and } t = -3:$$

$$x = 2 \times 4 + 6 \times -3$$

$$= 8 - 18 = -10$$

$$\mathbf{5 a} \quad d = e^2 + 2f$$

$$\mathbf{b} \quad d - e^2 = 2f$$

$$\therefore f = \frac{1}{2}(d - e^2)$$

$$\mathbf{c} \quad \text{If } d = 10 \text{ and } e = 3, \\ f = \frac{1}{2}(10 - 3^2) = \frac{1}{2}$$

$$\mathbf{6} \quad A = 400\pi \text{ cm}^3$$

$\mathbf{7}$ The volume of metal in a tube is given by the formula $V = \pi\ell[r^2 - (r - t)^2]$, where ℓ , is the length of the tube, r is the radius of the outside surface and t is the thickness of the material.

$$\mathbf{a} \quad \ell = 100, r = 5 \text{ and } t = 0.2$$

$$V = \pi \times 100[5^2 - (5 - 0.2)^2]$$

$$= \pi \times 100(5 - 4.8)(5 + 4.8)$$

$$= \pi \times 100 \times 0.2 \times 9.8$$

$$= \pi \times 20 \times 9.8$$

$$= 196\pi$$

$$\mathbf{b} \quad \ell = 50, r = 10 \text{ and } t = 0.5$$

$$\begin{aligned}
 V &= \pi \times 50[10^2 - (10 - 0.5)^2] \\
 &= \pi \times 50(10 - 9.5)(10 + 9.5) \\
 &= \pi \times 50 \times 0.5 \times 19.5 \\
 &= \pi \times 25 \times 19.5 \\
 &= \frac{975\pi}{2}
 \end{aligned}$$

8 a $A = \pi rs$ (r)

$$\begin{aligned}
 A &= \pi rs \\
 r &= \frac{A}{\pi s}
 \end{aligned}$$

b $T = P(1 + rw)$ (w)

$$\begin{aligned}
 T &= P(1 + rw) \\
 T &= P + Prw \\
 T - P &= Prw \\
 w &= \frac{T - P}{Pr}
 \end{aligned}$$

c $v = \sqrt{\frac{n-p}{r}}$ (r)

$$\begin{aligned}
 v^2 &= \frac{n-p}{r} \\
 r \times v^2 &= n-p \\
 r &= \frac{n-p}{v^2}
 \end{aligned}$$

d $ac = b^2 + bx$ (x)

$$\begin{aligned}
 ac &= b^2 + bx \\
 ac - b^2 &= bx \\
 x &= \frac{ac - b^2}{b}
 \end{aligned}$$

9 $s = \left(\frac{u+v}{2}\right)t.$

a $u = 10, v = 20$ and $t = 5.$

$$\begin{aligned}
 s &= \left(\frac{10+20}{2}\right) \times 5 \\
 &= 75
 \end{aligned}$$

b $u = 10, v = 20$ and $s = 120.$

$$\begin{aligned}
 120 &= \left(\frac{10+20}{2}\right)t \\
 120 &= 15t \\
 t &= 8
 \end{aligned}$$

10 $V = \pi r^2 h$ where r cm is the radius and h cm is the height

$V = 500\pi$ and $h = 10.$

$$500\pi = \pi r^2 \times 10$$

$r^2 = 50$ and therefore $r = 5\sqrt{2}$

The radius is $r = 5\sqrt{2}$ cm.

11 Let the lengths be x m and y m.

$10x + 5y = 205$ (1)

$3x - 2y = 2$ (2)

Multiply (1) by 2 and (2) by 5.

$20x + 10y = 410$ (3)

$15x - 10y = 10$ (4)

Add (3) and (4)

$35x = 420$

$x = 12$ and $y = 17.$

The lengths are 12 m and 17 m.

12 $\frac{m+1}{n} = \frac{1}{5}$ (1).

$\frac{m}{n-1} = \frac{1}{7}$ (2).

They become:

$5m + 5 = n$ (1) and $7m = n - 1$

(2)

Substitute from (1) in (2).

$7m = 5m + 5 - 1$

$$m = 2 \text{ and } n = 15.$$

- 13** ■ Mr Adonis earns \$7200 more than Mr Apollo
- Ms Aphrodite earns \$4000 less than Mr Apollo.
- If the total of the three incomes is \$303 200, find the income of each person.

Let Mr Apollo earn \$ x .

Mr Adonis earns $\$(x + 7200)$

Ms Aphrodite earns $\$(x - 4000)$

We have

$$x + x + 7200 + x - 4000 = 303\,200$$

$$3x + 3200 = 303\,200$$

$$3x = 300\,000$$

$$x = 100\,000$$

Mr Apollo earns \$100 000 ; Mr Adonis earns \$107 200 and Ms Aphrodite earns \$96 000.

- 14 a** $4a - b = 11$ (1)
 $3a + 2b = 6$ (2)
 Multiply (1) by 2.

$$8a - 2b = 22 \quad (3)$$

Add (3) and (2).

$$11a = 28 \text{ which implies } a = \frac{28}{11}.$$

$$\text{From (1), } b = -\frac{9}{11}$$

b $a = 2b + 11$ (1)

$$4a - 3b = 11 \quad (2)$$

Substitute from (1) in (2).

$$4(2b + 11) - 3b = 11$$

$$5b = -33$$

$$b = -\frac{33}{5}$$

$$\text{From (1), } a = 2 \times \left(-\frac{33}{5}\right) + 11 = -\frac{11}{5}.$$

- 15** Let t_1 hours be the time spent on highways and t_2 hours be the time travelling through towns.

$$t_1 + t_2 = 6 \quad (1)$$

$$80t_1 + 24t_2 = 424 \quad (2)$$

From (1) $t_2 = 6 - t_1$

Substitute in (2).

$$80t_1 + 24(6 - t_1) = 424$$

$$56t_1 = 424 - 6 \times 24$$

$$t_1 = 5 \text{ and } t_2 = 1.$$

The car travelled for 5 hours on highways and 1 hour through towns.

Solutions to multiple-choice questions

1 D $3x - 7 = 11$

$$3x = 18$$

$$x = 6$$

2 D $\frac{x}{3} + \frac{1}{3} = 2$

$$x + 1 = 6$$

$$x = 5$$

3 C $x - 8 = 3x - 16$

$$-2x = -8$$

$$x = 4$$

4 A $7 = 11(x - 2)$

5 C $2(2x - y) = 10$

$$\therefore 4x - 2y = 20$$

$$\frac{x + 2y = 0}{5x} = 20$$

$$\therefore x = 4; y = -2$$

6 C Average cost = total \$/total items

$$= \frac{ax + by}{x + y}$$

7 B $\frac{x + 1}{4} - \frac{2x - 1}{6} = x$

$$3(x + 1) - 2(2x - 1) = 12x$$

$$3x + 3 - 4x + 2 = 12x$$

$$-13x = -5$$

$$\therefore x = \frac{5}{13}$$

8 B $\frac{72 + 15z}{3} > 4$

$$72 + 15z > 12$$

$$15z > -60$$

$$\therefore z > -4$$

9 A $A = \frac{hw + k}{w}$

$$Aw = hw + k$$

$$w(A - h) = k$$

$$\therefore w = \frac{k}{A - h}$$

10 B Total time taken (hrs)

$$= \frac{x}{2.5} + \frac{8x}{5} = \frac{1}{2}$$

$$\frac{2x}{5} + \frac{8x}{5} = \frac{1}{2}$$

$$\frac{10x}{5} = \frac{1}{2}, \therefore x = \frac{1}{4}$$

$$x = \frac{1}{4} \text{ km} = 250 \text{ m}$$

11 E The lines $y = 2x + 4$ and $y = 2x + 6$ are parallel but have different y-axis intercepts.

Alternatively if $2x + 4 = 2x + 6$ then $4 = 6$ which is impossible.

12 B $5(x + 3) = 5x + 15$ for all x .

Solutions to extended-response questions

1 a $F = \frac{9}{5}C + 32$

If $F = 30$, then $30 = \frac{9}{5}C + 32$

and $\frac{9}{5}C = -2$

which implies $C = -\frac{10}{9}$

A temperature of 30°F corresponds to $\left(-\frac{10}{9}\right)^\circ\text{C}$.

b If $C = 30$, then $F = \frac{9}{5} \times 30 + 32$

$$= 54 + 32 = 86$$

A temperature of 30°C corresponds to a temperature of 86°F .

c $x^\circ\text{C} = x^\circ\text{F}$ when $x = \frac{9}{5}x + 32$

$$-\frac{4}{5}x = 32$$

$$\therefore x = -40$$

Hence $-40^\circ\text{F} = -40^\circ\text{C}$.

d $x = \frac{9}{5}(x + 10) + 32$

$$5x = 9x + 90 + 160$$

$$-4x = 250$$

$$\therefore x = -62.5$$

e $x = \frac{9}{5}(2x) + 32$

$$\frac{-13x}{5} = 32$$

$$\therefore x = \frac{-160}{13}$$

f $k = \frac{9}{5}(-3k) + 32$

$$5k = -27k + 160$$

$$32k = 160$$

$$\therefore k = 5$$

2 a

$$\frac{1}{v} + \frac{1}{u} = \frac{2}{r}$$

Obtain the common denominator

$$\frac{u+v}{vu} = \frac{2}{r}$$

Take the reciprocal of both sides

$$\frac{vu}{u+v} = \frac{r}{2}$$

Make r the subject

$$r = \frac{2vu}{u+v}$$

b

$$m = \left(v - \frac{2vu}{u+v} \right) \div \left(\frac{2vu}{u+v} - u \right)$$

$$= \frac{v^2 - vu}{u+v} \div \frac{uv - u^2}{u+v}$$

$$= \frac{v^2 - vu}{u+v} \times \frac{u+v}{uv - u^2}$$

$$= \frac{v(v-u)}{u(v-u)} = \frac{v}{u}$$

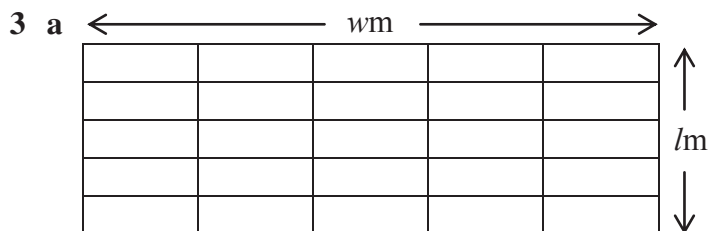

The total length of wire is given by $T = 6w + 6l$.

b i If $w = 3l$, then

$$T = 6w + 6\left(\frac{w}{3}\right)$$

$$= 8w$$

ii If $T = 100$, then $8w = 100$

Hence

$$w = \frac{25}{2}$$

$$l = \frac{w}{3}$$

$$= \frac{25}{6}$$

c i $L = 6x + 8y$

Make y the subject $8y = L - 6x$

and $y = \frac{L - 6x}{8}$

ii When $L = 200$ and $x = 4$,

$$y = \frac{200 - 6 \times 4}{8}$$

$$= \frac{176}{8} = 22$$

d The two types of mesh give

$$6x + 8y = 100 \quad (1)$$

and $3x + 2y = 40 \quad (2)$

Multiply (2) by 2 $6x + 4y = 80 \quad (3)$

Subtract (3) from (1) to give $4y = 20$

Hence $y = 5$

Substitute in (1) $6x + 40 = 100$

Hence $x = 10$

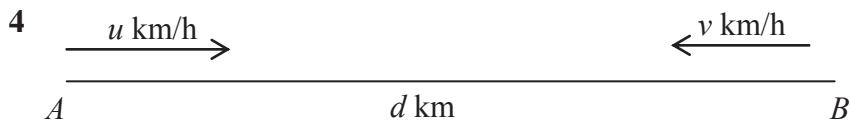

a At time t hours, Tom has travelled ut km and Julie has travelled vt km.

b i The sum of the two distances must be d when they meet.

Therefore $ut + vt = d$

and $t = \frac{d}{u + v}$

They meet after $\frac{d}{u + v}$ hours.

ii The distance from A is $u \times \frac{d}{u + v} = \frac{ud}{u + v}$ km.

c If $u = 30$, $v = 50$ and $d = 100$, the distance from A = $\frac{30 \times 100}{30 + 50}$
 $= 37.5$ km

The time it takes to meet is $\frac{100}{30 + 50} = 1.25$ hours.

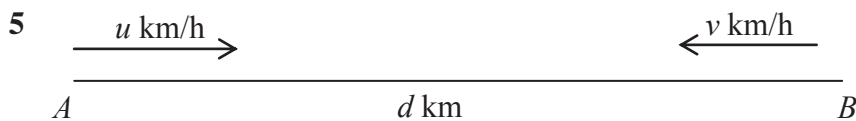

- a** The time taken to go from A to B is $\frac{d}{u}$ hours. The time taken to go from B to A is $\frac{d}{v}$ hours.

$$\text{The total time taken} = \frac{d}{u} + \frac{d}{v}$$

$$\begin{aligned} \text{Therefore, average speed} &= 2d \div \left(\frac{d}{u} + \frac{d}{v} \right) \\ &= 2d \div \frac{dv + du}{uv} \\ &= 2d \times \frac{uv}{d(u + v)} \\ &= \frac{2uv}{u + v} \text{ km/h} \end{aligned}$$

- b i** The time to go from A to B is T hours.

$$\text{Therefore} \quad T = \frac{d}{u} \quad (1)$$

$$\text{The time for the return trip} = \frac{d}{v} \quad (2)$$

$$\text{From (1)} \quad d = uT$$

and substituting in (2) gives

$$\text{the time for the return trip} = \frac{uT}{v}.$$

- ii** The time for the entire trip = $T + \frac{uT}{v}$
 $= \frac{vT + uT}{v}$ hours.

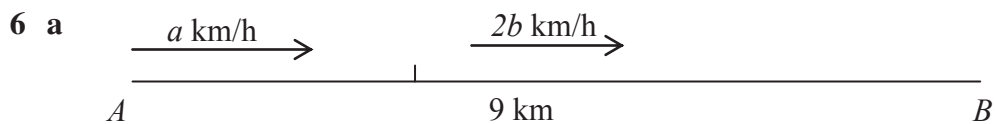

One-third of the way is 3 km.

$$\begin{aligned} \text{The time taken} &= \frac{3}{a} + \frac{6}{2b} \\ &= \frac{3}{a} + \frac{3}{b} \end{aligned}$$

b The return journey is 18 km and therefore, if the man is riding at $3c$ km/h,

$$\begin{aligned} \text{the time taken} &= \frac{18}{3c} \\ &= \frac{6}{c} \end{aligned}$$

Therefore, if the time taken to go from A to B at the initial speeds is equal to the time taken for the return trip travelling at $3c$ km/h,

$$\text{then} \quad \frac{6}{c} = \frac{3}{a} + \frac{3}{b}$$

$$\text{and hence} \quad \frac{2}{c} = \frac{1}{a} + \frac{1}{b}$$

$$\begin{aligned} \text{c i} \quad \frac{2}{c} &= \frac{1}{a} + \frac{1}{b} \\ &= \frac{a+b}{ab} \end{aligned}$$

To make c the subject, take the reciprocal of both sides.

$$\frac{c}{2} = \frac{ab}{a+b}$$

$$\text{and} \quad c = \frac{2ab}{a+b}$$

ii If $a = 10$ and $b = 20$, $c = 400 \div 30$

$$= \frac{40}{3}$$

7 a $\frac{x}{8}$ hours at 8 km/h
 $\frac{y}{10}$ hours at 10 km/h

$$\begin{aligned} \text{b} \quad \text{Average speed} &= (x+y) \div \left(\frac{x}{8} + \frac{y}{10} \right) \\ &= (x+y) \div \frac{10x+8y}{80} \\ &= (x+y) \times \frac{80}{10x+8y} \\ &= \frac{80(x+y)}{10x+8y} \end{aligned}$$

$$\text{c} \quad 10 \times \frac{x}{8} + 8 \times \frac{y}{10} = 72$$

and, from the statement of the problem,

$$x + y = 70 \quad (1)$$

Therefore simultaneous equations in x and y

$$\frac{5x}{4} + \frac{4y}{5} = 72 \quad (2)$$

Multiply (2) by 20 $25x + 16y = 1440$ (3)

Multiply (1) by 16 $16x + 16y = 1120$ (4)

Subtract (4) from (3)

$$9x = 320$$

which gives $x = \frac{320}{9}$ and $y = \frac{310}{9}$.

8 First solve the simultaneous equations:

$$2y - x = 2 \quad (1)$$

$$y + x = 7. \quad (2)$$

Add (1) and (2).

$$3y = 9$$

$$y = 3 \text{ and from (2) } x = 4.$$

Now check in

$$y - 2x = -5 \quad (3)$$

$$\text{LHS} = 3 - 8 = -5 = \text{RHS.}$$

The three lines intersect at $(4, 3)$.

Chapter 2 – Coordinate geometry and linear relations

Solutions to Exercise 2A

1 a $A(2, 12), B(8, 4)$

$$x = \frac{1}{2}(2 + 8) = 5$$

$$y = \frac{1}{2}(12 + 4) = 8$$

M is at $(5, 8)$.

b $A(-3, 5), B(4, -4)$

$$x = \frac{1}{2}(-3 + 4) = 0.5$$

$$y = \frac{1}{2}(5 + -4) = 0.5$$

M is at $(0.5, 0.5)$.

c $A(-1.6, 3.4), B(4.8, -2)$

$$x = \frac{1}{2}(-1.6 + 4.8) = 1.6$$

$$y = \frac{1}{2}(3.4 + -2) = 0.7$$

M is at $(1.6, 0.7)$.

d $A(3.6, -2.8), B(-5, 4.5)$

$$x = \frac{1}{2}(3.6 + -5) = -0.7$$

$$y = \frac{1}{2}(-2.8 + 4.5) = 0.85$$

M is at $(-0.7, 0.85)$

2 A is $(1, 1)$, B is $(5, 5)$ and C is $(11, 2)$.

$$AB: x = y = \frac{1}{2}(5 + 1) = 3$$

Midpoint is at $(3, 3)$.

$$BC: x = \frac{1}{2}(5 + 11) = 8$$

$$y = \frac{1}{2}(5 + 2) = 3.5$$

Midpoint is at $(8, 3.5)$.

$$AC: x = \frac{1}{2}(1 + 11) = 6$$

$$y = \frac{1}{2}(1 + 2) = 1.5$$

Midpoint is at $(6, 1.5)$.

3 $A(3.1, 7.1), B(8.9, 10.5)$

$$x = \frac{1}{2}(3.1 + 8.9) = 6$$

$$y = \frac{1}{2}(7.1 + 10.5) = 8.8$$

C is at $(6, 8.8)$.

4 a $X(-4, 2), M(0, 3)$

$$\text{For midpt } x: 0 = \frac{1}{2}(-4 + x)$$

$$\therefore x = 4$$

$$\text{For midpt } y: 3 = \frac{1}{2}(2 + y)$$

$$1 + \frac{y}{2} = 3$$

$$\frac{y}{2} = 2, \therefore y = 4$$

Point Y is at $(4, 4)$.

b $X(-1, -3), M(0.5, -1.6)$

$$\text{For midpt } x: 0.5 = \frac{1}{2}(-1 + x)$$

$$1 = -1 + x, \therefore x = 2$$

$$\text{For midpt } y: -1.6 = \frac{1}{2}(-3 + y)$$

$$-3.2 = -3 + y, \therefore y = -0.2$$

Point Y is at $(2, -0.2)$.

c $X(6, 3), M(2, 1)$

$$\text{For midpt } x: 2 = \frac{1}{2}(6 + x)$$

$$4 = 6 + x, \therefore x = -2$$

$$\text{For midpt } y: 1 = \frac{1}{2}(-3 + y)$$

$$2 = -3 + y, \therefore y = 5$$

Point Y is at $(-2, 5)$.

d $X(4, -3), M(0, -3)$

For midpt x : $0 = \frac{1}{2}(4 + x)$

$\therefore x = 4$

For midpt y : does not change so
 $y = -3$ Point Y is at $(-4, -3)$

5 At midpoint: $x = \frac{1}{2}(1 + a); y = \frac{1}{2}(4 + b)$

$x = \frac{1}{2}(1 + a) = 5$

$1 + a = 10, \therefore a = 9$

$y = \frac{1}{2}(4 + b) = -1$

$4 + b = -2, \therefore b = -6$

6 a Distance between $(3, 6)$ and $(-4, 5)$

$= \sqrt{(6 - 5)^2 + (3 - (-4))^2}$

$= \sqrt{1^2 + 7^2}$

$= \sqrt{50} = 5\sqrt{2} \approx 7.07$

b Distance between $(4, 1)$ and $(5, -3)$

$= \sqrt{(4 - 5)^2 + (1 - (-3))^2}$

$= \sqrt{(-1)^2 + 4^2}$

$= \sqrt{17} \approx 4.12$

c Distance between $(-2, -3)$ and
 $(-5, -8)$

$= \sqrt{(-2 - (-5))^2 + (-3 - (-8))^2}$

$= \sqrt{3^2 + 5^2}$

$= \sqrt{34} \approx 5.83$

d Distance between $(6, 4)$ and $(-7, 4)$

$= \sqrt{(6 - (-7))^2 + (4 - 4)^2}$

$= \sqrt{13^2 + 0^2}$

$= 13.00$

7 $A = (-3, -4), B = (1, 5), C = (7, -2)$

$AB = \sqrt{(1 - (-3))^2 + (5 - (-4))^2}$

$= \sqrt{4^2 + 9^2}$

$= \sqrt{97}$

$BC = \sqrt{(7 - 1)^2 + (-2 - 5)^2}$

$= \sqrt{6^2 + (-7)^2}$

$= \sqrt{85}$

$AC = \sqrt{(7 - (-3))^2 + (-2 - (-4))^2}$

$= \sqrt{10^2 + 2^2}$

$= \sqrt{104}$

$P = \sqrt{97} + \sqrt{85} + \sqrt{104} \approx 29.27$

8 $A(6, 6), B(10, 2), C(-1, 5), D(-7, 1)$

For P : $x = \frac{1}{2}(6 + 10) = 8$

$y = \frac{1}{2}(6 + 2) = 4$

P is at $(8, 4)$.

For M : $x = \frac{1}{2}(-1 + (-7)) = -4$

$y = \frac{1}{2}(5 + 1) = 3$

M is at $(-4, 3)$.

$\therefore PM = \sqrt{(-4 - 8)^2 + (3 - 4)^2}$

$= \sqrt{(-12)^2 + (-1)^2}$

$= \sqrt{145} \approx 12.04$

9 $DM = \sqrt{(-6 - 0)^2 + (1 - 6)^2}$

$= \sqrt{(-6)^2 + (-5)^2}$

$= \sqrt{61}$

$DN = \sqrt{(3 - 0)^2 + (-1 - 6)^2}$

$= \sqrt{3^2 + 7^2}$

$= \sqrt{58}$

DN is shorter.

Solutions to Exercise 2B

1 a $m = \frac{4-0}{0-(-1)} = 4$

b $m = \frac{6-0}{3-0} = 2$

c $m = \frac{1-0}{4-0} = \frac{1}{4}$

d $m = \frac{4-0}{0-1} = -4$

e $m = \frac{3-0}{3-0} = 1$

f $m = \frac{3-0}{-3-0} = -1$

g $m = \frac{10-0}{6-(-2)} = \frac{5}{4}$

h $m = \frac{8-2}{0-3} = \frac{6}{-3} = -2$

i $m = \frac{5-0}{0-4} = \frac{5}{-4} = -\frac{5}{4}$

j $m = \frac{4-0}{0-(-3)} = \frac{4}{3}$

k Rise = zero so $m = 0$

2 Line with gradient 1:

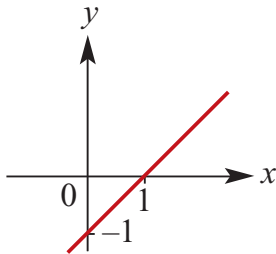

3 $m = 0$ so $y = mx + c$ means $y = c$.

Here $c = 6$:

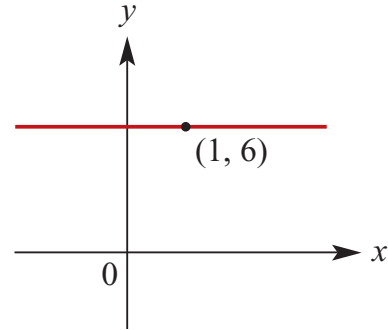

4 a $m = \frac{4-3}{2-6} = -\frac{1}{4}$

b $m = \frac{-6-4}{1-(-3)} = -\frac{5}{2}$

c $m = \frac{-3-7}{11-6} = -2$

d $m = \frac{0-8}{6-5} = -8$

e Rise = zero so $m = 0$

f $m = \frac{0-(-6)}{-6-0} = -1$

g $m = \frac{16-9}{4-3} = 7$

h $m = \frac{36-25}{6-5} = 11$

i $m = \frac{64-25}{-8-(-5)} = \frac{39}{-3} = -13$

j $m = \frac{100-1}{10-1} = \frac{99}{9} = 11$

k $m = \frac{1000-1}{10-1} = \frac{999}{9} = 111$

l $m = \frac{64-125}{4-5} = \frac{-61}{-1} = 61$

$$\begin{aligned} 5 \text{ a } m &= \frac{6a - 2a}{3a - 5a} \\ &= \frac{4a}{-2a} = -2 \end{aligned}$$

$$\begin{aligned} \text{b } m &= \frac{2b - 2a}{5b - 5a} \\ &= \frac{2(b - a)}{5(b - a)} = \frac{2}{5} \end{aligned}$$

$$\begin{aligned} 6 \text{ a } m &= \frac{a - 6}{7 - (-1)} \\ &= \frac{a - 6}{8} = 6 \\ a - 6 &= 48, \therefore a = 54 \end{aligned}$$

$$\begin{aligned} \text{b } m &= \frac{7 - 6}{b - 1} \\ &= \frac{1}{b - 1} = -6 \\ 1 &= 6(1 - b) = 6 - 6b \\ 6b &= 5, \therefore b = \frac{5}{6} \end{aligned}$$

7 We only need positive angles, so negative ones have 180° added.

$$\begin{aligned} \text{a } (0, 3), (-3, 0); m &= \frac{0 - (-3)}{3 - 0} = 1 \\ \text{Angle} &= \tan^{-1}(1) = 45^\circ \end{aligned}$$

$$\begin{aligned} \text{b } (0, -4), (4, 0); m &= \frac{0 - (-4)}{4 - 0} = 1 \\ \text{Angle} &= \tan^{-1}(1) = 45^\circ \end{aligned}$$

$$\begin{aligned} \text{c } (0, 2), (-4, 0); m &= \frac{0 - 2}{-4 - 0} = \frac{1}{2} \\ \text{Angle} &= \tan^{-1}\left(\frac{1}{2}\right) = 26.57^\circ \end{aligned}$$

$$\begin{aligned} \text{d } (0, -5), (-5, 0); m &= \frac{0 - -5}{-5 - 0} = -1 \\ \text{Angle} &= \tan^{-1}(-1) + 180^\circ = 135^\circ \end{aligned}$$

$$\begin{aligned} 8 \text{ a } (-4, -2), (6, 8); m &= \frac{8 - -2}{6 - -4} = 1 \\ \text{Angle} &= \tan^{-1}(1) = 45^\circ \end{aligned}$$

$$\begin{aligned} \text{b } (2, 6), (-2, 4); m &= \frac{4 - 6}{-2 - 2} = \frac{1}{2} \\ \text{Angle} &= \tan^{-1}\left(\frac{1}{2}\right) = 26.57^\circ \end{aligned}$$

$$\begin{aligned} \text{c } (-3, 4), (6, 1); m &= \frac{1 - 4}{6 - -3} = -\frac{1}{3} \\ \text{Angle} &= \tan^{-1}\left(-\frac{1}{3}\right) = 161.57^\circ \end{aligned}$$

$$\begin{aligned} \text{d } (-4, -3), (2, 4); m &= \frac{4 - -3}{2 - -4} = \frac{7}{6} \\ \text{Angle} &= \tan^{-1}\left(\frac{7}{6}\right) = 49.4^\circ \end{aligned}$$

$$\begin{aligned} \text{e } (3b, a), (3a, b); m &= \frac{b - a}{3a - 3b} \\ &= (b - a)\left(\frac{1}{-3}\right) = -\frac{1}{3} \\ \text{Angle} &= \tan^{-1}\left(-\frac{1}{3}\right) = 161.57^\circ \end{aligned}$$

$$\begin{aligned} \text{f } (c, b), (b, c); m &= \frac{c - b}{b - c} = -1 \\ \text{Angle} &= \tan^{-1}(-1) + 180^\circ = 135^\circ \end{aligned}$$

$$9 \text{ a } \tan 45^\circ = 1$$

$$\text{b } \tan 135^\circ = -1$$

$$\text{c } \tan 60^\circ = \sqrt{3}$$

$$\text{d } \tan 120^\circ = -\sqrt{3}$$

Solutions to Exercise 2C

1 a $m = 3, c = 6$

b $m = -6, c = 7$

c $m = 3, c = -6$

d $m = -1, c = -4$

2 a $y = mx + c; m = 3, c = 5$

so $y = 3x + 5$

b $y = mx + c; m = -4, c = 6$

so $y = -4x + 6$

c $y = mx + c; m = 3, c = -4$

so $y = 3x - 4$

3 a $y = 3x - 6$; Gradient = 3; y-axis

intercept = -6

b $y = 2x - 4$; Gradient = 2; y-axis

intercept = -4

c $y = \frac{1}{2}x - 2$; Gradient = $\frac{1}{2}$; y-axis

intercept = -2

d $y = \frac{1}{3}x - \frac{5}{3}$; Gradient = $\frac{1}{3}$; y-axis

intercept = $-\frac{5}{3}$

4 a $2x - y = 9$

$-y = -2x + 9$

$y = 2x - 9, \therefore m = 2, c = -9$

b

$3x + 4y = 10$

$4y = -3x + 10$

$y = -\frac{3}{4}x + \frac{5}{2}, \therefore m = -\frac{3}{4}, c = \frac{5}{2}$

c

$-x - 3y = 6$

$-3y = x + 6$

$y = -\frac{1}{3}x - 2, \therefore m = -\frac{1}{3}, c = -2$

d $5x - 2y = 4$

$-2y = -5x + 4$

$y = \frac{5}{2}x - 2, \therefore m = \frac{5}{2}, c = -2$

5 a The equation is of the form

$y = 3x + c;$

When $x = 6, y = 7$

$\therefore 7 = 3 \times 6 + c$

$\therefore c = -11$

The equation is $y = 3x - 11$

b The equation is of the form

$y = -2x + c;$

When $x = 1, y = 7$

$\therefore 7 = -2 \times 1 + c$

$\therefore c = 9$

The equation is $y = -2x + 9$

6 a $(-1, 4), (2, 3)$

$m = \frac{3 - 4}{2 - (-1)} = -\frac{1}{3}$

Using $(2, 3): y = -\frac{2}{3} + c = 3$

$c = \frac{11}{3}$

$\therefore y = -\frac{1}{3}x + \frac{11}{3}$

$3y = -x + 11$

$$\therefore x + 3y = 11$$

b (0, 4), (5, -3)

$$m = \frac{-3 - 4}{5 - 0} = -\frac{7}{5}$$

Using (0, 4): $y = c = 4$

$$\therefore y = -\frac{7}{5}x + 4$$

$$5y = -7x + 20$$

$$\therefore 7x + 5y = 20$$

c (3, -2), (4, -4)

$$\therefore m = \frac{-4 - (-2)}{4 - 3} = -2$$

Using (3, -2): $y = -2 \times 3 + c = -2$

$$c = 4$$

$$\therefore y = -2x + 4$$

$$\therefore 2x + y = 4$$

d (5, -2), (8, 9)

$$\therefore m = \frac{9 - (-2)}{8 - 5} = \frac{11}{3}$$

Using (5, -2): $y = \frac{11}{3} \times 5 + c = -2$

$$c + \frac{55}{3} = -2$$

$$c = -\frac{61}{3}$$

$$\therefore y = \frac{11}{3}x - \frac{61}{3}$$

$$3y = 11x - 61$$

$$\therefore -11x + 3y = -61$$

7 a The line passes through the point (0, 6) and (1, 8).

$$\text{Therefore gradient} = \frac{8 - 6}{1 - 0} = 2$$

b The equation is $y = 2x + 6$

8 a The equation is of the form

$$y = 2x + c;$$

$$\text{When } x = 1, y = 6$$

$$\therefore 6 = 2 \times 1 + c$$

$$\therefore c = 4$$

The equation is $y = 2x + 4$

b The equation is of the form

$$y = -2x + c;$$

$$\text{When } x = 1, y = 6$$

$$\therefore 6 = -2 \times 1 + c$$

$$\therefore c = 8$$

The equation is $y = -2x + 8$

9 a The equation is of the form

$$y = 2x + c;$$

$$\text{When } x = -1, y = 4$$

$$\therefore 4 = 2 \times (-1) + c$$

$$\therefore c = 6$$

The equation is $y = 2x + 6$

b The equation is of the form

$$y = -2x + c;$$

$$\text{When } x = 0, y = 4$$

$$\therefore c = 4$$

The equation is $y = -2x + 4$

c The equation is of the form

$$y = -5x + c;$$

$$\text{When } x = 3, y = 0$$

$$\therefore 0 = -5 \times 3 + c$$

$$\therefore c = 15$$

The equation is $y = -5x + 15$

10 a $y = mx + c; m = \frac{0 - 4}{6 - 0} = -\frac{2}{3}$

$$\text{Using } (0, 4), c = 4$$

$$y = -\frac{2x}{3} + 4$$

b $y = mx + c; m = \frac{-6 - 0}{0 - (-3)} = -\frac{6}{3} = -2$

$$\text{Using } (0, -6), c = -6$$

$$y = -2x - 6$$

c $y = mx + c; m = \frac{0-4}{4-0} = -\frac{4}{4} = -1$
 Using (0,4), $c = 4$
 $y = -x + 4$

d $y = mx + c; m = \frac{3-0}{0-2} = -\frac{3}{2}$
 Using (0,3):
 $y = -\frac{3}{2}x + 3$
 $\therefore y = -x + 8$

11 a Gradient = $\frac{6-4}{3-0} = \frac{2}{3}$
 Passes through (0,4), $\therefore c = 4$
 Therefore equation is $y = \frac{2}{3}x + 4$

b Gradient = $\frac{2-0}{4-1} = \frac{2}{3}$
 When $x = 1, y = 0$
 $\therefore 0 = \frac{2}{3} \times 1 + c$
 $\therefore c = -\frac{2}{3}$
 Therefore equation is $y = \frac{2}{3}x - \frac{2}{3}$

c Gradient = $\frac{3-0}{3-(-3)} = \frac{1}{2}$
 When $x = -3, y = 0$
 $\therefore 0 = \frac{1}{2} \times (-3) + c$
 $\therefore c = \frac{3}{2}$
 Therefore equation is $y = \frac{1}{2}x + \frac{3}{2}$

d Gradient = $\frac{0-3}{4-(-2)} = -\frac{1}{2}$
 When $x = 4, y = 0$
 $\therefore 0 = -\frac{1}{2} \times 4 + c$
 $\therefore c = 2$
 Therefore equation is $y = -\frac{1}{2}x + 2$

e Gradient = $\frac{8-2}{4.5-(-1.5)} = 1$
 When $x = -1.5, y = 2$

$\therefore 2 = 1 \times (-1.5) + c$
 $\therefore c = 3.5$
 Therefore equation is $y = x + 3.5$

f Gradient = $\frac{-2-1.75}{4.5-(-3)} = -0.5$
 When $x = -3, y = 1.75$
 $\therefore 1.75 = -0.5 \times (-3) + 0.25$
 $\therefore c = 0.25$
 Therefore equation is
 $y = -0.5x + 0.25$

12 a Axis intercepts: (0,4) and (-1,0)
 $m = \frac{4-0}{0-(-1)} = 4,$
 $c = 4$ so $y = 4x + 4$

b Specified points: (-3,2) and (0,0)
 $m = \frac{2-0}{-3-0} = -\frac{2}{3}$
 $c = 0$ so $y = -\frac{2x}{3}$

c Axis intercepts: (-2,0) and (0,-2)
 $m = \frac{0-(-2)}{-2-0} = 1$
 $c = -2$ so $y = -x - 2$

d Axis intercepts: (2,0) and (0,-1)
 $m = \frac{0-(-1)}{2-0} = \frac{1}{2},$
 $c = -1$ so $y = \frac{x}{2} - 1$

e $m = 0, c = 3.5$ so $y = 3.5$

f m undefined. Vertical line is $x = k$
 so $x = -2$

13 P and Q are on the line $y = mx + c;$
 $m = \frac{1-(-3)}{2-1} = 4$
 Using Q at (2,1):
 $y = 4 \times 2 + c = 1$ so $c = -7$
 Line PQ has equation $y = 4x - 7$
 Q and R are on the line $y = ax + b:$

$$a = \frac{3-1}{2.5-2} = \frac{2}{0.5} = 4$$

Using Q at $(2, 1)$:

$$y = 4 \times 2 + b = 1 \text{ so } b = -7$$

Line QR also has equation $y = 4x - 7$

P, Q and R are collinear.

c $x + y = 0$

Passes through $(0,0)$ because $c = 0$

d $x - y = 1$

Does not pass through $(0,0)$ because

$y = x + 1$ has $c = 1$

14 a $y + x = 1$

Does not pass through $(0,0)$ because

$y = 1 - x$ has $c = 1$

b $y + 2x = 2(x + 1)$

Does not pass through $(0,0)$: this

equation simplifies to $y = 2$, so y is

never 0.

15 a $x = 4$

b $y = 11$

c $x = 11$

d $y = -1$

Solutions to Exercise 2D

1 a $x + y = 4$

If $x = 0, y = 4$; if $y = 0, x = 4$

Axis intercepts are at $(0,4)$ and $(4,0)$

b $x - y = 4$

If $x = 0, y = -4$; if $y = 0, x = 4$

Axis intercepts are at $(0, -4)$ and $(4,0)$

c $-x - y = 6$

If $x = 0, y = -6$; if $y = 0, x = -6$

Axis intercepts are at $(0, -6)$ and $(-6,0)$

d $y - x = 8$

If $x = 0, y = 8$; if $y = 0, x = -8$

Axis intercepts are at $(0,8)$ and $(-8,0)$

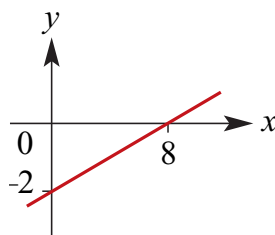

c $-3x + 4y = 24$

If $x = 0, 4y = 24$

$$\therefore y = \frac{24}{4} = 6$$

If $y = 0, -3x = 24$

$$\therefore x = \frac{24}{-3} = -8$$

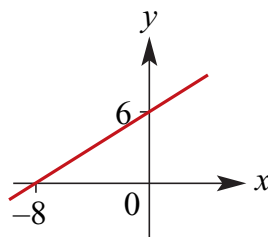

2 a $2x - 3y = 12$

If $x = 0, -3y = 12$

$$\therefore y = \frac{12}{-3} = -4$$

If $y = 0, 2x = 12$

$$\therefore x = \frac{12}{2} = 6$$

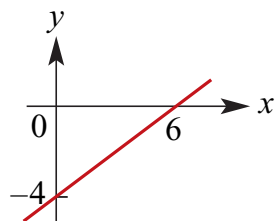

d $-5x + 2y = 20$

If $x = 0, 2y = 20$

$$\therefore y = \frac{20}{2} = 10$$

If $y = 0, -5x = 20$

$$\therefore x = \frac{20}{-5} = -4$$

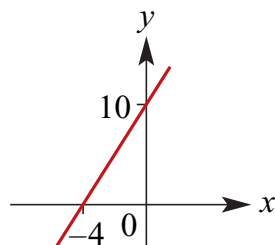

b $x - 4y = 8$:

If $x = 0, -4y = 8$

$$\therefore y = \frac{8}{-4} = -2$$

If $y = 0, x = 8$

e $4x - 3y = 15$

If $x = 0, -3y = 15$

$$\therefore y = \frac{15}{-3} = -5$$

If $y = 0, 4x = 15$

$$\therefore x = \frac{15}{4} = 3.75$$

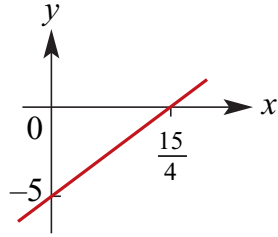

f $7x - 2y = 15$

If $x = 0, -2y = 15$

$\therefore y = \frac{15}{-2} = -7.5$

If $y = 0, 7x = 15$

$\therefore x = \frac{15}{7}$

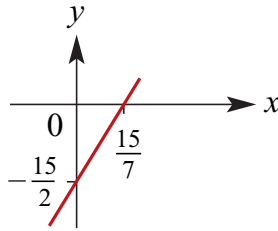

3 a $y = x - 1$

If $x = 0, y = -1$; if $y = 0, x = 1$

Intercepts at $(0, -1)$ and $(1, 0)$

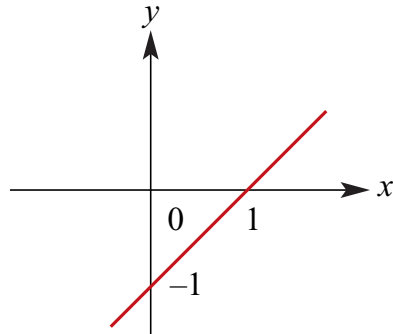

b $y = x + 2$

If $x = 0, y = 2$; if $y = 0, x = -2$

Intercepts at $(0, 2)$ and $(-2, 0)$

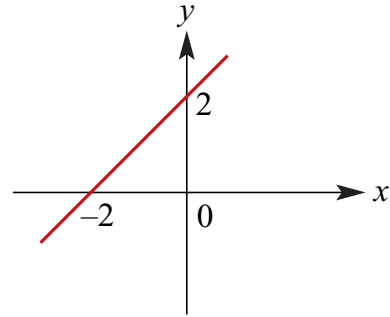

c $y = 2x - 4$

If $x = 0, y = -4$;

if $y = 0, 2x - 4 = 0$, so $x = 2$

Intercepts at $(0, -4)$ and $(2, 0)$

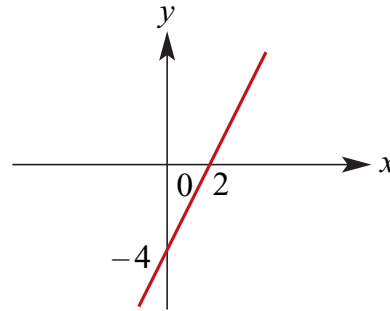

4 a $y = 2x - 10$

If $x = 0, y = -10$ so $(0, -10)$

If $y = 0, 2x = 10, x = 5$ so $(5, 0)$

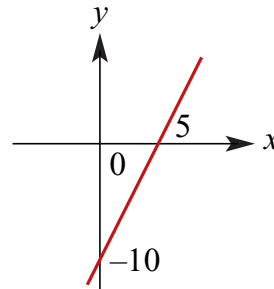

b $y = 3x - 9$

If $x = 0, y = -9$ so $(0, -9)$

If $y = 0, 3x = 9, x = 3$ so $(3, 0)$

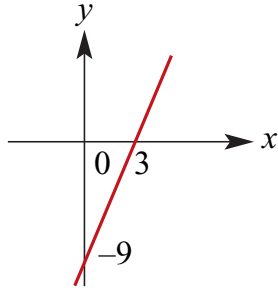

- c** $y = 5x + 10$
 If $x = 0, y = 10$ so $(0, 10)$
 If $y = 0, 5x + 10 = 0,$
 so $5x = -10$ and $x = -2$ so $(-2, 0)$

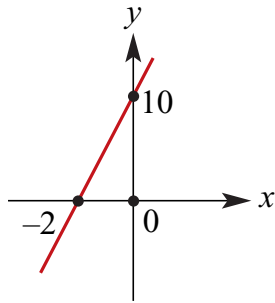

- d** $y = -2x + 10$
 If $x = 0, y = 10$ so $(0, 10)$
 If $y = 0, -2x + 10 = 0,$
 so $2x = 10$ and $x = 5$ so $(5, 0)$

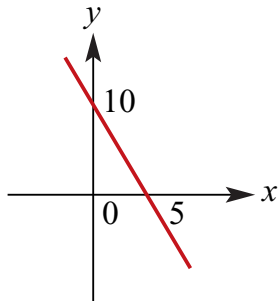

- 5 a** $y = x + 2$

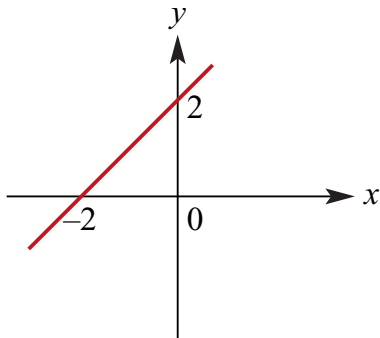

- b** $y = -x + 2$

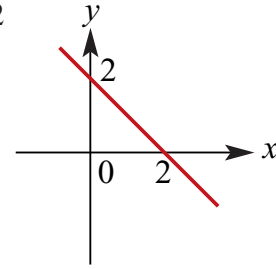

- c** $y = 2x + 1$

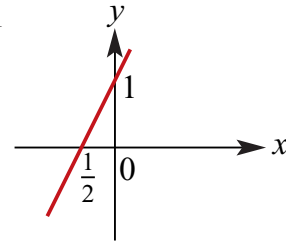

- d** $y = -2x + 1$

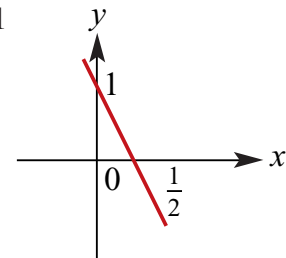

- 6 a** $x + y = 1$

$$\therefore y = -x + 1$$

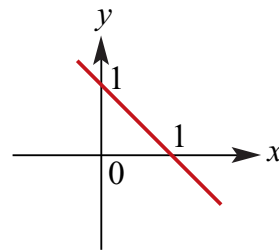

- b** $x - y = 1$

$$x - 1 = y$$

$$\therefore y = x - 1$$

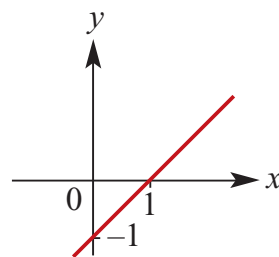

c $y - x = 1$

$\therefore y = x + 1$

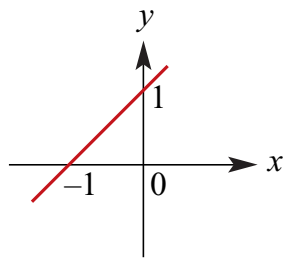

d $-x - y = 1$

$-y = x + 1$

$\therefore y = -x - 1$

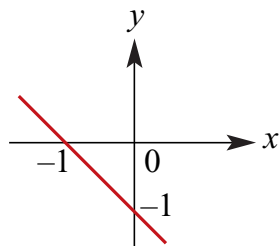

7 a $y = x + 3$

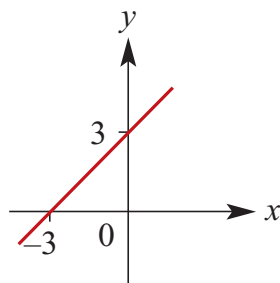

b $y = 3x + 1$

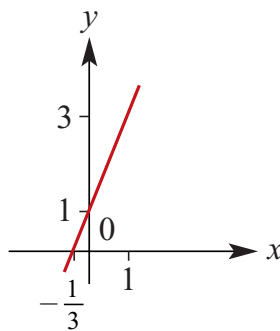

c $y = 4 - \frac{1}{2}x$

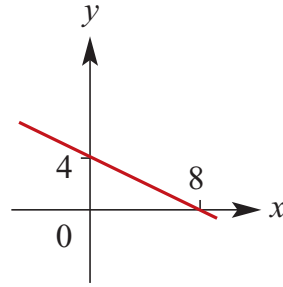

d $y = 3x - 2$

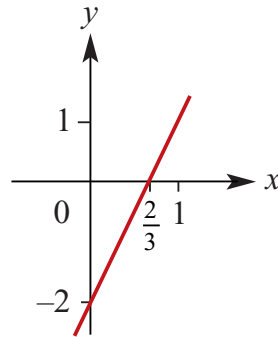

e $4y + 2x = 12$

$4y = 12 - 2x$

$\therefore y = -\frac{x}{2} + 3$

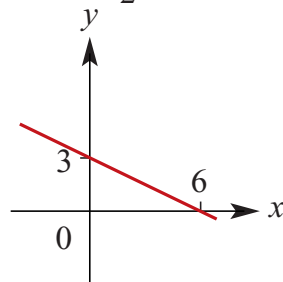

f $3x + 6y = 12$

$6y = 12 - 3x$

$\therefore y = -\frac{x}{2} + 2$

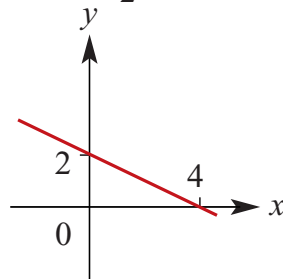

g $4y - 6x = 24$

$$4y = 24 + 6x$$

$$\therefore y = \frac{3x}{2} + 6$$

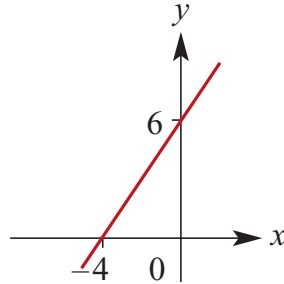

h $8x - 3y = 24$

$$-3y = 24 - 8x$$

$$\therefore y = \frac{8x}{3} - 8$$

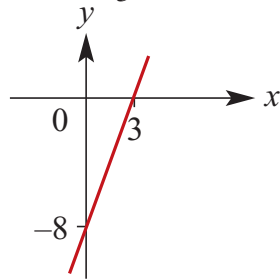

8 a

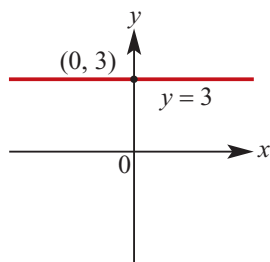

b

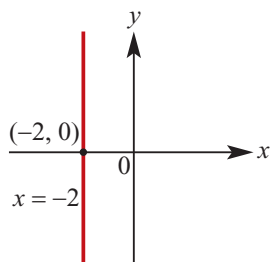

c

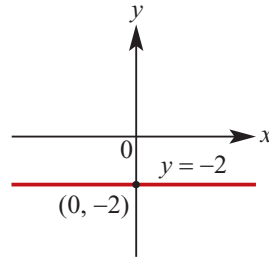

d

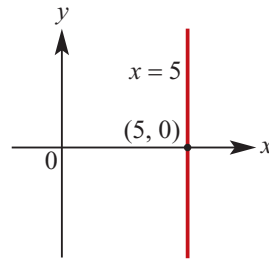

9 a $y = x$ so $m = 1; 45^\circ$

b $y = -x$ so $m = -1; 135^\circ$

c $y = x + 1$ so $m = 1; 45^\circ$

d $x + y = 1$
 $y = -x + 1$ so $m = -1; 135^\circ$

e $y = 2x$ so $m = 2;$
 $\tan^{-1}(2) = 63.43^\circ$

f $y = -2x; m = -2;$
 $\tan^{-1}(-2) + 180^\circ = 116.57^\circ$

10 a $y = 3x + 2; m = 3$
 $\tan^{-1}(3) = 71.57^\circ$

b $2y = -2x + 1$
 $\therefore y = -x + \frac{1}{2}; m = -1$
 $\tan^{-1}(-1) = 135^\circ$

c $2y - 2x = 6$
 $y - x = 3$
 $\therefore y = x + 3; m = 1$
 $\tan^{-1}(1) = 45^\circ$

$$\begin{aligned}
 \mathbf{d} \quad & 3y + x = 7 \\
 & 3y = -x + 7 \\
 & \therefore y = -\frac{x}{3} + \frac{7}{3}; m = -\frac{1}{3} \\
 & \tan^{-1}\left(-\frac{1}{3}\right) + 180^\circ = 161.57^\circ
 \end{aligned}$$

11 A straight line has equation $y = 3x - 4$

$$(0, a): a = -4$$

$$(b, 0): 0 = 3b - 4$$

$$3b = 4, \therefore b = \frac{4}{3}$$

$$(1, d): d = 3 - 4 = -1$$

$$(e, 10): 10 = 3e - 4$$

$$3e = 14, \therefore e = \frac{14}{3}$$

Solutions to Exercise 2E

1 a Gradient = 2

Equation is of the form $y = 2x + c$

When $x = 4, y = -2$

$$\therefore -2 = 2 \times 4 + c$$

$$\therefore c = -10$$

The equation is $y = 2x - 10$

b Gradient = $-\frac{1}{2}$

Equation is of the form $y = -\frac{1}{2}x + c$

When $x = 4, y = -2$

$$\therefore -2 = -\frac{1}{2} \times 4 + c$$

$$\therefore c = 0$$

The equation is $y = -\frac{1}{2}x$

c Gradient = $-\frac{1}{2}$

Equation is of the form $y = -2x + c$

When $x = 4, y = -2$

$$\therefore -2 = -2 \times 4 + c$$

$$\therefore c = 6$$

The equation is $y = -2x + 6$

d Gradient = $-\frac{1}{2}$

Equation is of the form $y = \frac{1}{2}x + c$

When $x = 4, y = -2$

$$\therefore -2 = \frac{1}{2} \times 4 + c$$

$$\therefore c = -4$$

The equation is $y = \frac{1}{2}x - 4$

e $2x - 3y = 4$

$$-3y = -2x + 4$$

$$\therefore y = \frac{2}{3}x - \frac{4}{3}$$

So the gradient we want is $\frac{2}{3}$.

Using the point $(4, -2)$:

$$y - -2 = \frac{2}{3}(x - 4)$$

$$y = \frac{2}{3}(x - 4) - 2$$

$$y = \frac{2}{3}x - \frac{8}{3} - 2$$

$$y = \frac{2}{3}x - \frac{14}{3}$$

$$3y = 2x - 14$$

$$\therefore 2x - 3y = 14$$

f $2x - 3y = 4$

$$\therefore 3y = 2x - 4$$

$$\therefore y = \frac{2}{3}x - \frac{4}{3}$$

Gradient = $-\frac{3}{2}$

Equation is of the form $y = -\frac{3}{2}x + c$

When $x = 4, y = -2$

$$\therefore -2 = -\frac{3}{2} \times 4 + c$$

$$\therefore c = 4$$

The equation is $y = -\frac{3}{2}x + 4$

g $x + 3y = 5$

$$\therefore 3y = -x + 5$$

$$\therefore y = -\frac{1}{3}x + \frac{5}{3}$$

Gradient = $-\frac{1}{3}$

Equation is of the form $y = -\frac{1}{3}x + c$

When $x = 4, y = -2$

$$\therefore -2 = -\frac{1}{3} \times 4 + c$$

$$\therefore c = -\frac{2}{3}$$

The equation is $y = -\frac{1}{3}x - \frac{2}{3}$

h $x + 3y = -4$

$$\therefore 3y = -x - 4$$

$$\therefore y = -\frac{1}{3}x - \frac{4}{3}$$

Gradient = $\frac{1}{3}$

Equation is of the form $y = 3x + c$

When $x = 4, y = -2$

$$\therefore -2 = 3 \times 4 + c$$

$$\therefore c = -14$$

The equation is $y = 3x - 14$

2 a $2y = 6x + 4; y = 3x + 4$

Parallel: $m = 3$ for both

b $x = 4 - y; 2x + 2y = 6$

Parallel: $m = -1$ for both

c $3y - 2x = 12; y + \frac{1}{3} = \frac{2}{3}x$

Parallel: $m = \frac{2}{3}$ for both

d $4y - 3x = 4; 3y = 4x - 3$

Not parallel:

$$4y - 3x = 4$$

$$4y = 3x + 4$$

$$\therefore y = \frac{3x}{4} + 1$$

$$3y = 4x - 3$$

$$\therefore y = \frac{4x}{3} - 1$$

3 a $y = 4$ (The y -coordinate)

b $x = 2$ (The x -coordinate)

c $y = 4$ (The y -coordinate)

d $x = 3$ (The x -coordinate)

4 Gradient of $y = -\frac{1}{2}x + 6$ is $-\frac{1}{2}$.

So perpendicular gradient is

$$-1 \div -\frac{1}{2} = 2$$

Using the point (1,4):

$$y - 4 = 2(x - 1)$$

$$y = 2(x - 1) + 4$$

$$\therefore y = 2x + 2$$

5 $A(1, 5)$ and $B(-3, 7)$

Midpoint

$$M\left(\frac{1 + (-3)}{2}, \frac{7 + 5}{2}\right) = M(-1, 6)$$

$$\text{Gradient } AB = \frac{7 - 5}{-3 - 1} = -\frac{1}{2}$$

\therefore gradient of line perpendicular to

$AB = 2$. The equation of the line is of the form $y = 2x + c$

When $x = -1, y = 6$

$$\therefore 6 = 2 \times (-1) + c$$

$$\therefore c = 8$$

Equation of line is $y = 2x + 8$

6 Gradient of $AB = \frac{-3 - 2}{2 - 5} = \frac{5}{3}$

$$\text{Gradient of } BC = \frac{3 - (-3)}{-8 - 2} = -\frac{3}{5}$$

Product of these gradients

$$= -\frac{3}{5} \times \frac{5}{3} = -1$$

AB and BC are perpendicular, so ABC is a right-angled triangle.

7 $A(3, 7), B(6, 1), C(-8, 3)$

$$\text{Gradient } AB = \frac{7 - 1}{3 - 6} = -2$$

$$\text{Gradient } BC = \frac{8 - 1}{20 - 6} = \frac{1}{2}$$

$\therefore AB \perp BC$

8 Gradient of $RS = \frac{4 - 6}{6 - 2} = -\frac{1}{2}$

$$\text{Gradient of } ST = \frac{-4 - 4}{2 - 6} = 2$$

Product of these gradients = -1 , so RS

and ST are perpendicular.

$$\text{Gradient of } TU = \frac{-2 - -4}{-2 - 2} = -\frac{1}{2}$$

$$\text{Gradient of } UR = \frac{6 - -2}{2 - -2} = 2$$

Similarly, TU and UR are perpendicular, as are ST and TU , and RS and UR .

So $RSTU$ must be a rectangle.

9 $4x - 3y = 10$

$$-3y = 10 - 4x$$

$$3y = 4x - 10$$

$$\therefore y = \frac{4}{3}x - \frac{10}{3}$$

$$\text{Gradient} = \frac{4}{3}$$

$$4x - ly = m$$

$$-ly = m - 4x$$

$$ly = 4x - m$$

$$\therefore y = \frac{4}{l}x - \frac{m}{l}$$

$$\text{Gradient} = \frac{4}{l}$$

These lines are perpendicular, so their gradients multiplied equal -1 :

$$\frac{4}{3} \times \frac{4}{l} = -1$$

$$\frac{16}{3} = -l$$

$$\therefore l = -\frac{16}{3}$$

At intersection $(4, 2)$ the y and x values are equal. From $4x - ly = m$:

$$\begin{aligned} m &= 16 - 2\left(-\frac{16}{3}\right) \\ &= 16 + \frac{32}{3} = \frac{80}{3} \end{aligned}$$

10 a The line perpendicular to AB through B has gradient $-\frac{1}{2}$ and passes through $(-1, 6)$.

The equation of this line is

$$y = -\frac{1}{2}x + \frac{11}{2}.$$

b Intersects AB when

$$2x + 3 = -\frac{1}{2}x + \frac{11}{2}.$$

$\therefore x = 1, y = 5$ are the coordinates of point B .

c The coordinates of A and B are $(0, 3)$ and $(1, 5)$ respectively.

\therefore the coordinates of C are $(2, 7)$.

Solutions to Exercise 2F

- 1 The point $(2, 7)$ is on the line $y = mx - 3$.

$$\text{Hence } 7 = 2m - 3$$

$$\text{That is, } m = 5$$

- 2 The point $(3, 11)$ is on the line

$$y = 2x + c.$$

$$\text{Hence } 11 = 2 \times 3 + c \text{ That is, } c = 5$$

- 3 a Gradient of line perpendicular to the line $y = mx + 3$ is $-\frac{1}{m}$ The y-intercept is 3.

The equation of the second line is

$$y = -\frac{x}{m} + 3.$$

- b If $(1, -4)$ is on the line, $-4 = -\frac{1}{m} + 3$.

$$\text{Hence } -\frac{1}{m} = -7.$$

$$\text{That is, } m = \frac{1}{7}$$

- 4 $8 = m \times 3 + 2$

$$m = 2$$

- 5 $f: R \rightarrow R, f(x) = mx - 3, m \in R/\{0\}$

- a x-axis intercept: $mx - 3 = 0, \therefore x = \frac{3}{m}$

- b $6 = 5m - 3$

$$5m = 9$$

$$m = \frac{9}{5}$$

- c x-axis intercept ≤ 1 for $\frac{3}{m} \leq 1$,

$$\therefore m \geq 3$$

- d $y = f(x)$ has gradient = m , so a

perpendicular line has gradient

$$= -\frac{1}{m}.$$

Using the straight line formula for the point $(0, -3)$:

$$y - (-3) = -\frac{1}{m}(x - 0)$$

$$\therefore y = -\frac{1}{m}x - 3$$

$$\text{OR } my + x = -3m$$

- 6 $f: R \rightarrow R, f(x) = 2x + c$, where $c \in R$

- a x-axis intercept: $2x + c = 0, \therefore x = -\frac{c}{2}$

- b $6 = 5 \times 2 + c$

$$c = -4$$

- c $-\frac{c}{2} \leq 1$
 $c \geq -2$

- d $y = f(x)$ has gradient = 2, so a

perpendicular line has gradient = $-\frac{1}{2}$.

Using the straight line formula for the point $(0, c)$:

$$y - c = -\frac{1}{2}(x - 0)$$

$$\therefore y = -\frac{1}{2}x + c$$

- 7 $\frac{x}{a} - \frac{y}{12} = 4$

- a When $y = 0, \frac{x}{a} = 4, \therefore x = 4a$

The coordinates of the x-axis intercept are $(4a, 0)$.

- b Rearranging to make y the subject.

$$y = \frac{12x}{a} - 48$$

The gradient of the line is $\frac{12}{a}$

c i When the gradient is 2, $\frac{12}{a} = 2, \therefore a = 6$

ii When the gradient is -2, $\frac{12}{a} = -2, \therefore a = -6$

8 a When $y = 0, x = \frac{c}{2}$

b $y = -2x + c$. When $x = 1, y = 7$
 $\therefore 7 = -2 + c$
 $\therefore c = 9$.

c $\frac{c}{2} \leq 1 \Leftrightarrow c \leq 2$

d Line perpendicular to $y = -2x + c$ has gradient $\frac{1}{2}$

Therefore $y = \frac{1}{2}x + c$

e $A(\frac{c}{2}, 0)$ and $B(0, c)$

i The midpoint of line segment AB has coordinates $(\frac{c}{4}, \frac{c}{2})$

If $(\frac{c}{4}, \frac{c}{2}) = (3, 6)$ then $c = 12$

ii The area of the triangle

$$AOB = \frac{1}{2} \times c \times \frac{c}{2} = \frac{c^2}{4}$$

If the area is 4, $\frac{c^2}{4} = 4$ which implies $c^2 = 16$. Therefore $c = 4$ since $(c > 0)$

iii $OM = \sqrt{\left(\frac{c}{4}\right)^2 + \left(\frac{c}{2}\right)^2}$
 $= \sqrt{\frac{5c^2}{16}}$

If $OM = 2\sqrt{5}$ then $\sqrt{\frac{5c^2}{16}} = 2\sqrt{5}$
 $\therefore c = 8$

9 $3x + by = 12$

a $3x + by = 12$

$$by = -3x + 12$$

$$y = -\frac{3}{b}x + \frac{12}{b}$$

\therefore y-axis intercept is $\frac{12}{b}$.

b \therefore gradient $= -\frac{3}{b}$

c i $-\frac{3}{b} = 1$

$$b = -3$$

ii $-\frac{3}{b} = -2$

$$b = \frac{3}{2}$$

d Gradient of perpendicular line is $\frac{b}{3}$

The line is of the form $y = \frac{b}{3}x + c$

When $x = 4, y = 0$

$$0 = \frac{b}{3} \times 4 + c$$

$$c = -\frac{4b}{3}$$

$$\therefore y = \frac{b}{3}x - \frac{4b}{3} \text{ or } 3y = bx - 4b$$

Solutions to Exercise 2G

1 At $n = 0$, $w = \$350$, paid at $\$20$ per n

$$\therefore w = 20n + 350; n \in N \cup \{0\}$$

2 a At $t = 0$, $d_1 = 0$ and $v = 50$ km/h

$$\therefore d_1 = vt = 50t$$

b At $t = 0$, $d_2 = 80$ and $v = -40$ km/h

$$\therefore d_2 = 80 - 40t$$

c Gradient = 50

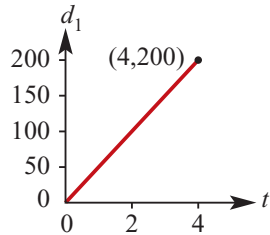

Gradient = -40

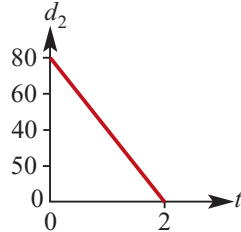

3 a At $t = 0$, $V = 0$, fills at 5 L/min

$$\therefore V = 5t$$

b At $t = 0$, $V = 10$, fills at 5 L/min

$$\therefore V = 5t + 10$$

4 a At $t = 0$, $v = 500$, empties at 2.5 L/min

$$\therefore v = -2.5t + 500$$

b Since the bag is emptying, $v \leq 500$

The bag cannot contain a negative volume so $v \geq 0$

$$\therefore 0 \leq v \leq 500$$

The bag does not go back in time so $t \geq 0$

The bag empties when

$$-2.5t + 500 = 0$$

$$2.5t = 500$$

$$t = 200$$

After that the function no longer holds true,

$$\therefore 0 \leq t \leq 200$$

c

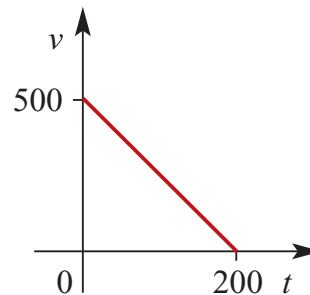

5 At $n = 0$, $C = 2.6$, C per km = 1.5

$$\therefore C = 1.5n + 2.6$$

6 a At $x = 0$, $C = 85$, C per km = 0.24

$$\therefore C = 0.24x + 85$$

b When $x = 250$,

$$C = 0.24(250) + 85$$

$$= 60 + 85 = \$145$$

7 At $t = 0$, $d = 200$ km,

$v = -5$ km/h from B

$$\therefore d = -5t + 200$$

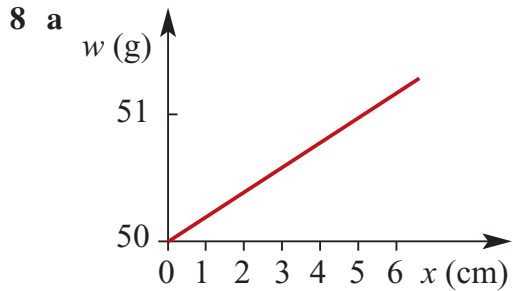

b $w = 50 + 0.2x$

c If $w = 52.5$ g,
 $x = 5 \times (52.5 - 50)$
 $= 5 \times 2.5 = 12.5$ cm

9 a $C = an + b$
 If $n = 800, C = 47$; if
 $n = 600, C = 35$
 $800a + b = 47$
 $600a + b = 35$
 $\hline 200a = 12$
 $\therefore a = \frac{12}{200} = \frac{3}{50} = 0.06$
 Substitute into 2nd equation:

$$600 \times \frac{3}{50} + b = 35$$

$$36 + b = 35$$

$$b = -1$$

$$\therefore C = 0.06n - 1$$

b If $n = 1000$,
 $c = 0.06(1000) - 1$
 $= 60 - 1 = \$59$

10 a $C = an + b$
 If $n = 160, C = 975$; if
 $n = 120, C = 775$
 $160a + b = 975$
 $120a + b = 775$
 $\hline 40a = 200$
 $\therefore a = \frac{200}{40} = 5$
 Substitute into 2nd equation:
 $600 + b = 775$
 $b = 175$
 $\therefore C = 5n + 175$

b Yes, because $b \neq 0$

c When $n = 0, C = \$175$

Solutions to Exercise 2H

1 The lines $x + y = 6$ and $2x + 2y = 13$ both have gradient -1 but different y -intercepts.

2 Let $x = \lambda$. Then solution is $\{(\lambda, 6 - \lambda) : \lambda \in \mathbb{R}\}$

3 a $m = 4$. The line $y = 4x + 6$ is parallel to the line $y = 4x - 5$

b $m \neq 4$

c $15 = 5m + 6$
 $\therefore m = \frac{9}{5}$
 Check: $(5, 15)$ lies on the line $y = 4x - 5$

4 $6 = 4 + k$ and $6 = 2m - 4$
 $\therefore k = 2$ and $m = 5$

5 $2(m - 2) + 8 = 4 \dots (1)$
 $2m + 24 = k \dots (2)$

From (1) $2m - 4 + 8 = 4$

$$m = 0$$

From (2) $k = 24$

6 The simultaneous equations have no solution when the corresponding lines have the same gradient and no point in common.

Gradient of $mx - y = 5$ is m .

Gradient of $3x + y = 6$ is -3 .

\therefore lines are parallel when $m = -3$

7

Gradient of $3x + my = 5$ is $-\frac{3}{m}$.

Gradient of $(m + 2)x + 5y = m$ is $-\frac{m + 2}{5}$.

If the gradients are equal

$$-\frac{3}{m} = -\frac{m + 2}{5}$$

$$15 = m^2 + 2m$$

$$m^2 + 2m - 15 = 0$$

$$(m + 5)(m - 3) = 0$$

$$m = -5 \text{ or } m = 3$$

a When $m = -5$ the equations become

$$3x - 5y = 5$$

$$-3x + 5y = -5$$

They are equations of the same line. There are infinitely many solutions.

b When $m = 3$ the equations become

$$3x + 3y = 5$$

$$5x + 5y = 3$$

They are the equations of parallel lines with no common point.

No solutions

8 A: $C = 10t + 20$

B: $C = 8t + 30$

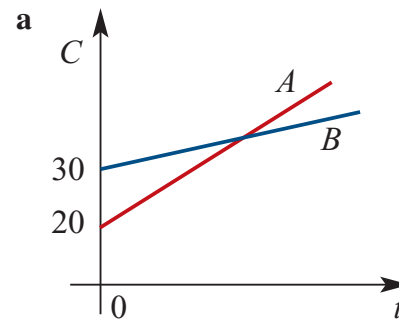

b Costs are equal when

$$10t + 20 = 8t + 30$$

$$2t = 10, \therefore t = 5$$

9 Day 1:

John: $v = \frac{1}{a}$ m/s

Michael: $v = \frac{1}{b}$ m/s

$d = vt = 50$ m, so Michael's time is:

$$t = 50 \frac{1}{v} = 50b$$

Similarly, John's time is:

$$t = 50 \frac{1}{v} = 50a$$

Michael wins by 1 second

$$\therefore 50a = 50b + 1$$

Day 2:

John runs only 47 m:

$$t = 47a$$

Michael runs the same time:

$$t = 50b$$

Michael wins by 0.1 seconds

$$\therefore 47a = 50b + 0.1$$

From day 1: $50b = 50a - 1$

$$\therefore 47a = 50a - 1 + 0.1$$

$$3a = 0.9, \therefore a = 0.3$$

$$50b = 50 \times 0.3 - 1 = 14$$

$$\therefore b = 0.28$$

Michael's speed:

$$v = \frac{1}{b} = \frac{1}{0.28} = \frac{25}{7} \text{ m/s}$$

10 $d_A = 10t + 15$

$$d_B = 20t + 5$$

t is the time in hours after 1.00 p.m.

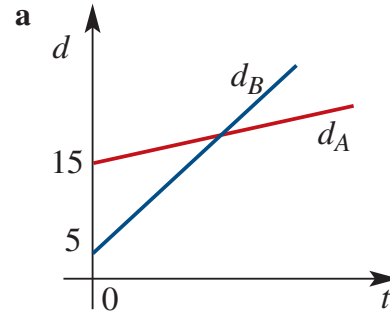

b $d_A = d_B$ when

$$20t + 5 = 10t + 15$$

$$10t = 10, \therefore t = 1$$

11 a A: $C = 1.6x + 210$
B: $C = 330$

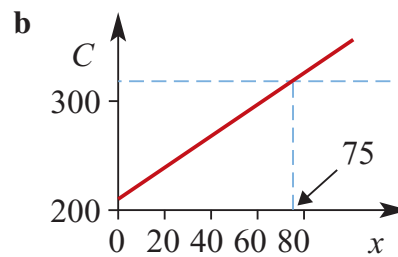

c Costs are equal when

$$1.6x + 210 = 330$$

$$1.6x = 120$$

$$x = \frac{120}{1.6} = 75$$

When $x < 75$, method A is cheaper;

when $x > 75$, method B is cheaper.

So the fixed charge method is cheaper when $x > 75$.

12 a

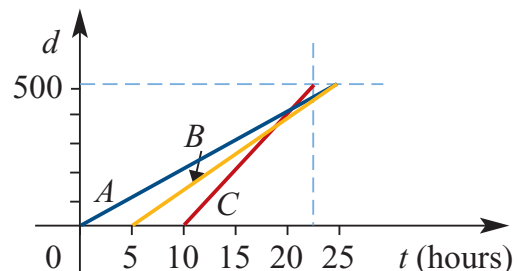

b C wins the race

c $A(t) = 20t$

$$B(t) = 25(t - 5)$$

$$C(t) = 40(t - 10)$$

After 25 hours,

$$A(25) = 500$$

$$B(25) = 25(25 - 5) = 500$$

$$C(25) = 40(25 - 10) = 600$$

C completes the course in t hours

where:

$$40(t - 10) = 500$$

$$t - 10 = \frac{500}{40} = 12.5$$

$$t = 12.5 + 10 = 22.5$$

d C, leaving 5 hours after B, overtakes B $13\frac{1}{2}$ hours after B had started and then overtakes A 20 hours after A had started. C wins the race with a total handicap time of $22\frac{1}{2}$ hours ($12\frac{1}{2}$ hours for journey + 10 hours handicap) with A and B deadheating for 2nd, each with a total handicap time of 25 hours.

13 $y = -\frac{3}{4}x$ meets $y = \frac{3}{2}x - 12$ when

$$-\frac{3x}{4} = \frac{3x}{2} - 12$$

$$-3x = 6x - 48$$

$$9x = 48$$

$$x = \frac{48}{9} = \frac{16}{3} = 5\frac{1}{3}$$

$$\therefore y = -\frac{3}{4} \times \frac{16}{3} = -4$$

The paths cross at $(5\frac{1}{3}, -4)$

14 a A: $\$C = 2.8x$

B: $\$C = x + 54$

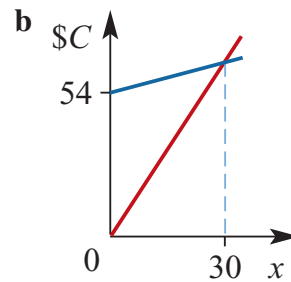

c Costs are equal when $2.8x = x + 54$

$$1.8x = 54$$

$$x = 30$$

It is more economical if there are more than 30 students.

15 a Anne: when $t = 0, d = 0$;

$$v = 20 \text{ km/h} = \frac{1}{3} \text{ km/min}$$

$$\therefore d = \frac{t}{3}$$

Maureen: when $t = 0, d = 57$;

$$v = -18 \text{ km/h} = -\frac{3}{10} \text{ km/min}$$

$$\therefore d = 57 - \frac{3}{10}t$$

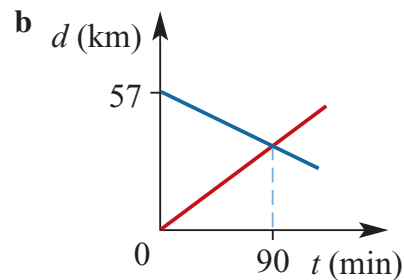

c They meet when

$$\frac{t}{3} = 57 - \frac{3t}{10}$$

$$\frac{t}{3} + \frac{3t}{10} = 37$$

$$10t + 9t = 1710$$

$$19t = 1710$$

$$t = \frac{1710}{19} = 90$$

They meet after 90 min, i.e.
10.30 a.m.

- d** Substitute into either equation, but Anne's is easier:
- $$d = \frac{t}{3} = \frac{90}{3} = 30$$
- Anne has traveled 30 km, so Maureen must have traveled $57 - 30 = 27$ km.

Solutions to Technology-free questions

1 a $A(1, 2)$ and $B(5, 2)$: y does not change.

$$\text{Length } AB = 5 - 1 = 4$$

$$\text{Midpoint } x = \frac{1 + 5}{2} = 3$$

\therefore midpoint is at $(3, 2)$.

b $A(-4, -2)$ and $B(3, -7)$

$$\text{Length } AB = \sqrt{(-4 - 3)^2 + (-2 - (-7))^2}$$

$$= \sqrt{(-7)^2 + 5^2} = \sqrt{74}$$

$$\text{Midpoint } x = \frac{-4 + 3}{2} = -\frac{1}{2}$$

$$y = \frac{-2 + (-7)}{2} = -\frac{9}{2}$$

\therefore midpoint is at $(-\frac{1}{2}, -\frac{9}{2})$.

c $A(3, 4)$ and $B(7, 1)$

$$\text{Length } AB = \sqrt{(7 - 3)^2 + (1 - 4)^2}$$

$$= \sqrt{4^2 + (-3)^2} = \sqrt{25} = 5$$

$$\text{Midpoint } x = \frac{3 + 7}{2} = 5$$

$$y = \frac{4 + 1}{2} = \frac{5}{2}$$

\therefore midpoint is at $(5, \frac{5}{2})$.

2 a $m = \frac{12 - 3}{8 - 4} = \frac{9}{4}$

b $m = \frac{-6 - 4}{8 - (-3)} = -\frac{10}{11}$

c x does not change so gradient is undefined.

d $m = \frac{0 - a}{a - 0} = -1$

e $m = \frac{b - 0}{a - 0} = \frac{b}{a}$

f $m = \frac{0 - b}{a - 0} = -\frac{b}{a}$

3 If $m = 4$ then $y = 4x + c$

a Passing through $(0, 0)$; $y = 4x$

b Passing through $(0, 5)$; $y = 4x + 5$

c Passing through $(1, 6)$;

$$y = 4 + c = 6, \therefore c = 2$$

$$y = 4x + 2$$

d Passing through $(3, 7)$;

$$y = 12 + c = 7, \therefore c = -5$$

$$y = 4x - 5$$

4 a $y = 3x - 5$

$$\text{Using } (1, a), a = 3 - 5 = -2$$

b $y = 3x - 5$

$$\text{Using } (b, 15), 3b - 5 = 15$$

$$3b = 20, \therefore b = \frac{20}{3}$$

5 $y = mx + c$; $m = \frac{-4 - 2}{3 - (-5)} = -\frac{3}{4}$

Using $(3, -4)$:

$$-4 = \left(-\frac{3}{4}\right)3 + c$$

$$\frac{9}{4} - 4 = c = -\frac{7}{4}$$

$$y = -\frac{3}{4}x - \frac{7}{4}$$

$$4y = -3x - 7$$

$$\therefore 3x + 4y = -7$$

6 $y = mx + c$; $m = -\frac{2}{3}$

Using $(-4, 1)$:

$$y = -\frac{2}{3}(-4) + c = 1$$

$$\frac{8}{3} + c = 1 \therefore c = -\frac{5}{3}$$

$$y = -\frac{2}{3x} - \frac{5}{3}$$

$$3y = -2x - 5$$

$$\therefore 2x + 3y = -5$$

- 7 a** Lines parallel to the x -axis are $y = c$.
Using $(5, 11)$, $y = 11$

- b** Parallel to $y = 6x + 3$ so gradient
 $m = 6$
When $x = 0$, $y = -10$, so $c = -10$
 $y = 6x - 10$

- c** $3x - 2y + 5 = 0$
 $-2y = -3x - 5$
 $\therefore y = \frac{3}{2}x + \frac{5}{2}$
 $m = \frac{3}{2}$ so perpendicular gradient
 $= -\frac{2}{3}$
Using $(0, 1)$, $c = 1$

$$y = -\frac{2}{3}x + 1$$

$$3y = -2x - 3$$

$$\therefore 2x + 3y = -3$$

- 8** $y = mx + c$:
Line at 30° to x -axis, $m = \tan 30^\circ = \frac{1}{\sqrt{3}}$

$$\text{Using } (2, 3) : 3 = \frac{2}{\sqrt{3}} + c$$

$$\therefore c = 3 - \frac{2}{\sqrt{3}}$$

$$\therefore \sqrt{3}y - x = 3\sqrt{3} - 2$$

- 9** $y = mx + c$:
Line at 135° to x -axis,

$$m = \tan 135^\circ = -1$$

$$\text{Using } (-2, 3) : 3 = -1 \times -2 + c$$

$$\text{So } c = 1 \text{ and } y = -x + 1$$

$$\therefore x + y = 1$$

- 10** Gradient of a line perpendicular to
 $y = -3x + 2$ is $\frac{1}{3}$.

Therefore required line is of the form

$$y = \frac{1}{3}x + c.$$

$$\text{When } x = 4, y = 8$$

$$\therefore 8 = \frac{1}{3} \times 4 + c$$

$$\text{Hence } c = 8 - \frac{4}{3} = \frac{20}{3}$$

$$y = \frac{1}{3}x + \frac{20}{3}$$

- 11** $y = 2x + 1$

$$\text{When } x = 0, y = 1. \therefore a = 1$$

$$\text{When } y = 0, 2x + 1 = 0. \therefore b = -\frac{1}{2}$$

$$\text{When } x = 2, y = 5. \therefore d = 5$$

$$\text{When } y = 7, 2x + 1 = 7. \therefore e = 3$$

- 12 a** $y = 2x - 8$

$$\text{When } x = 0, y = -8 \text{ and when } y = 0, x = 4$$

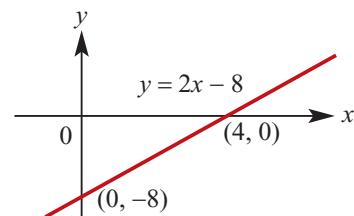

- b** $3x + y = 6$

$$\text{When } x = 0, y = 6 \text{ and when } y = 0, x = 2$$

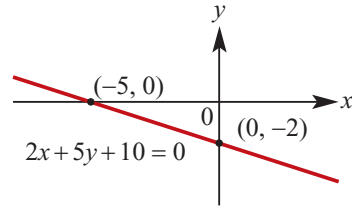
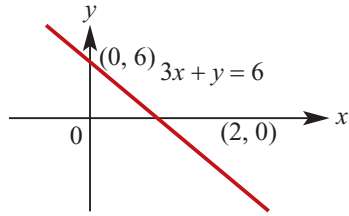

- c** $3x + y + 6 = 0$
 When $x = 0, y = -6$ and when
 $y = 0, x = -2$

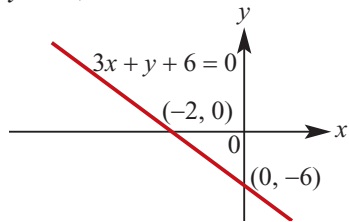

- 13 a** Line is of the form $y = c$.
 $\therefore y = -9$ is the equation

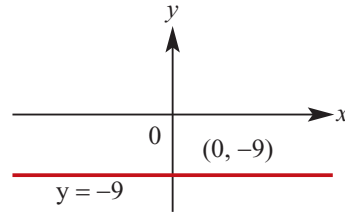

- d** $y - 2x - 8 = 0$
 When $x = 0, y = 8$ and when
 $y = 0, x = -4$

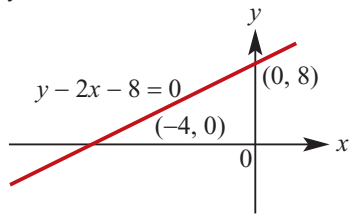

- b** Line is of the form $x = a$.
 $\therefore x = 8$ is the equation.

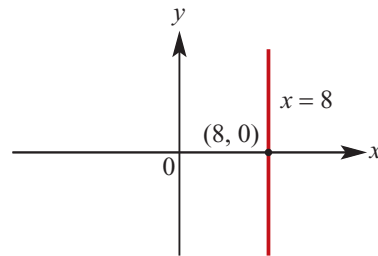

- e** $y = -6x + 6$
 When $x = 0, y = 6$ and when
 $y = 0, x = 1$

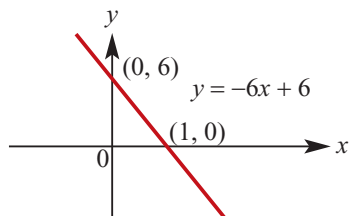

- c i** $y = 3x$

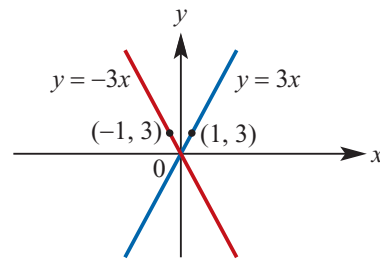

- ii** $y = -3x$

- f** $2x + 5y + 10 = 0$
 When $x = 0, y = -2$ and when
 $y = 0, x = -5$

- 14 a** $d = 60t$

- b** gradient is 60

- 15** $S = 800 + 500n$

16 a $y = ax + 2$

When $x = 2, y = 6$

$$\therefore 6 = 2a + 2$$

$$\therefore a = 2$$

The equation is $y = 2x + 2$

b i When $y = 0, ax + 2 = 0$

$$\therefore x = \frac{-2}{a}$$

ii

$$\frac{-2}{a} > 1$$

$$-2 < a$$

$$\therefore 0 > a > -2$$

Equivalently $-2 < a < 0$

c $x + 3 = ax + 2$ Substitute in

$$x - ax = 2 - 3$$

$$x(1 - a) = -1$$

$$x = \frac{1}{a-1}$$

$y = x + 3$ to find the y-coordinate.

$$y = \frac{1}{a-1} + 3$$

$$y = \frac{3a-2}{a-1}$$

.

The coordinates of the point of

(Since $a < 0$) intersection are $\left(\frac{1}{a-1}, \frac{3a-2}{a-1}\right)$

Solutions to multiple-choice questions

1 D Midpoint $x = \frac{4+6}{2} = 5$
 Midpoint $y = \frac{12+2}{2} = 7$
 Midpt is at $(5, 7)$

2 E Midpoint x -coordinate
 $6 = \frac{-4+x}{2}, \therefore x = 16$
 Midpoint y -coordinate
 $3 = \frac{-6+y}{2}, \therefore y = 12$
 $\therefore x + y = 28$

3 A Gradient $= \frac{-10 - (-8)}{6 - 5} = -2$

4 E Gradient $= \frac{2a - (-3a)}{4a - 9a} = -1$

5 C $y = mx + c; m = 3$
 Using $(1, 9)$:
 $9 = 3 + c$ so $c = 6$
 $y = 3x + 6$

6 D $y = mx + c; m = \frac{-14 - (-6)}{-2 - 2} = 2$
 Using $(2, -6)$:
 $y = 4 + c = -6; c = -10$
 So $y = 2x - 10$

7 B $y = 2x - 6$
 Using $(a, 2)$:
 $y = 2a - 6 = 2, \therefore a = 4$

8 E Axis intercepts at $(1, 0)$ and $(0, -3)$:

$y = mx + c; c = -3$
 Using $(1, 0)$: $0 = m - 3$ so $m = 3$
 $y = 3x - 3$

9 C $5x - y + 7 = 0$
 $-y = -5x - 7$
 $\therefore y = 5x + 7$
 Gradient $= 5$
 $ax + 2y - 11 = 0$

$2y = -ax + 11$
 $\therefore y = -\frac{a}{2}x + \frac{11}{2}$
 Parallel lines mean gradients are equal:
 $-\frac{a}{2} = 5, \therefore a = -10$

10 E
 $C = 2.5x + 65 = 750$
 $2.5x = 685, \therefore x = 274$

11 C $2ax + 2by = 3 \dots (1)$
 $3ax - 2by = 7 \dots (2)$
 Add (1) and (2)

$5ax = 10$
 $\therefore x = \frac{2}{a}$

Substitute in (1)

$y = -\frac{1}{2b}$

Solutions to extended-response questions

1 a $C = 100n + 27.5n + 50 + 62.5n = 550 + 190n$

b

$$C \leq 3000 \quad \therefore 550 + 190n \leq 3000$$

$$\therefore 190n \leq 2450$$

$$\therefore n \leq \frac{2450}{190}$$

$$\therefore n < 12.9$$

The cruiser can be hired for up to and including 12 days by someone wanting to spend no more than \$3000.

c $300n < 550 + 190n$

$$110n < 550$$

$$n < 5$$

It's cheaper to hire from the rival company for cruises less than 5 days.

2 a It is the cost of the plug.

b It is the cost per metre of the cable.

c 1.8

d

$$24.5 = 4.5 + 1.8x$$

$$\therefore 20 = 1.8x$$

$$\begin{aligned} \therefore x &= \frac{20}{1.8} \\ &= \frac{100}{9} \\ &= 11\frac{1}{9} \end{aligned}$$

$11\frac{1}{9}$ metres of cable would give a total cost of \$ 24.50.

3 a It is the maximum profit when the bus has no empty seats, i.e. $x = 0$.

b $P < 0$

$$1020 - 24x < 0$$

$$-24x < -1020$$

$$x > \frac{-1020}{-24}$$

$$x > 42.5$$

43 empty seats is the least number to cause a loss on a single journey.

c The profit reduces by \$24 for each empty seat.

4 a i $C = 0.091n, \quad 0 < n \leq 50$

ii $C = 0.058(n - 50) + 0.091 \times 50$
 $= 0.058n - 2.9 + 4.55$
 $= 0.058n + 1.65, \quad 50 < n \leq 200$

iii $C = 0.0356(n - 200) + 0.058 \times 200 + 1.65$
 $= 0.0356n - 7.12 + 11.6 + 1.65$
 $= 0.0356n + 6.13, \quad n > 200$

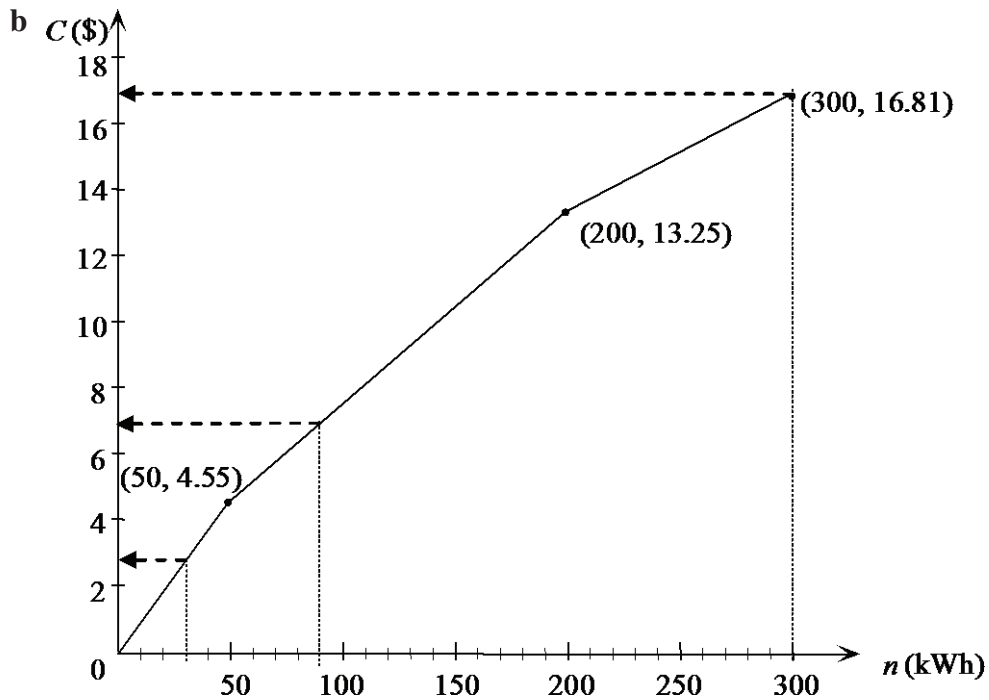

i When $n = 30$ kWh,

from the graph $C \approx \$3$
 from the formula $C = 0.091 \times 30$
 $= \$2.73$

ii When $n = 90$ kWh,
 from the graph $C \approx \$7$
 from the formula $C = 0.058 \times 90 + 1.65$
 $= \$6.87$

iii When $n = 300$ kWh,
 from the graph $C \approx 17$
 from the formula $C = 0.0356 \times 300 + 6.13$
 $= \$16.81$

c When $C = 20$, $20 = 0.0356n + 6.13$
 $\therefore 13.87 = 0.0356n$
 $\therefore n = 389.60 \dots$
 Approximately 390 kWh of electricity could be used for \$20.

5 a Let $(x_1, y_1) = (2, 10)$ and $(x_2, y_2) = (8, -4)$

$$m = \frac{y_2 - y_1}{x_2 - x_1} = \frac{-4 - 10}{8 - 2}$$

$$= \frac{-14}{6}$$

$$= \frac{-7}{3}$$

$$y - y_1 = m(x - x_1)$$

$$\therefore y - 10 = \frac{-7}{3}(x - 2)$$

$$\therefore y - 10 = \frac{-7}{3}x + \frac{14}{3}$$

$$\therefore y + \frac{7}{3}x = 10 + \frac{14}{3}$$

$$\therefore y + \frac{7}{3}x = \frac{44}{3}$$

$$\therefore 3y + 7x = 44$$

$$\therefore y = -\frac{7}{3}x + 14\frac{2}{3}$$

The equation describing the aircraft's flight path is $7x + 3y = 44$.

$$\begin{aligned}
 \text{b} \quad \text{When } x = 15, \quad & 7 \times 15 + 3y = 44 \\
 \therefore & 105 + 3y = 44 \\
 \therefore & 3y = -61 \\
 \therefore & y = \frac{-61}{3} \\
 & = -20\frac{1}{3}
 \end{aligned}$$

When $x = 15$, the aircraft is $20\frac{1}{3}$ km south of O .

6 a $s = 100 - 7x$

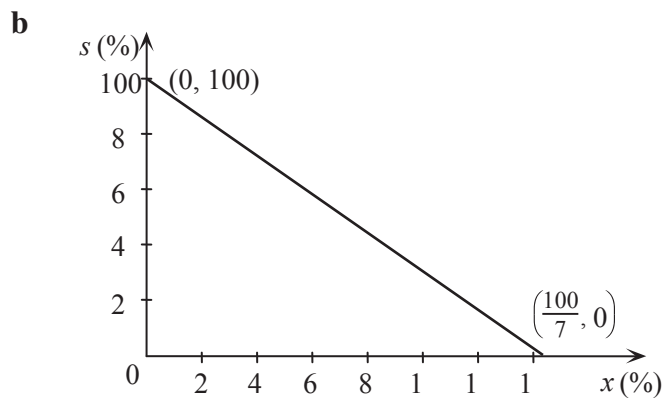

c $100 - 7x \geq 95$

$$\therefore -7x \geq -5$$

$$\therefore x \leq \frac{5}{7}$$

i.e. $\frac{5}{7}\%$ air can be left in the concrete for at least 95% strength.

d $100 - 7x = 0$

$$\therefore -7x = -100$$

$$\therefore x = \frac{100}{7}$$

$$= 14\frac{2}{7}$$

i.e. the concrete contains $14\frac{2}{7}\%$ air when at 0% strength.

e Concrete at 0% strength would not be useful, therefore not a sensible model.

f $\{x : 0 \leq x \leq 14\frac{2}{7}\}$

7 a For line AB , let $(x_1, y_1) = (0, 2)$ and $(x_2, y_2) = (4, 6)$

$$m = \frac{y_2 - y_1}{x_2 - x_1} = \frac{6 - 2}{4 - 0} = 1$$

(Alternatively, $y = mx + c$, where $m = 1$ as shown and $c = 2$, $\therefore y = x + 2$.)

Now $y - y_1 = m(x - x_1)$

$$\therefore y - 2 = 1(x - 0)$$

$\therefore y = x + 2$ is the equation of line AB .

For line CD , let $(x_1, y_1) = (3, 0)$ and $(x_2, y_2) = (5, 4)$.

$$m = \frac{y_2 - y_1}{x_2 - x_1} = \frac{4 - 0}{5 - 3} = 2$$

Now $y - y_1 = m(x - x_1)$

$$\therefore y - 0 = 2(x - 3)$$

$$\therefore y = 2x - 6$$

The equation of line CD is $y = 2x - 6$.

b The lines intersect where $x + 2 = 2x - 6$

$$\therefore 2 = x - 6$$

$$\therefore x = 8$$

When $x = 8$, $y = 2 \times 8 - 6$

$$\therefore y = 10$$

i.e. the coordinates of the point of intersection are $(8, 10)$, and the paths of the rabbit and the fox meet on the near bank of the irrigation channel.

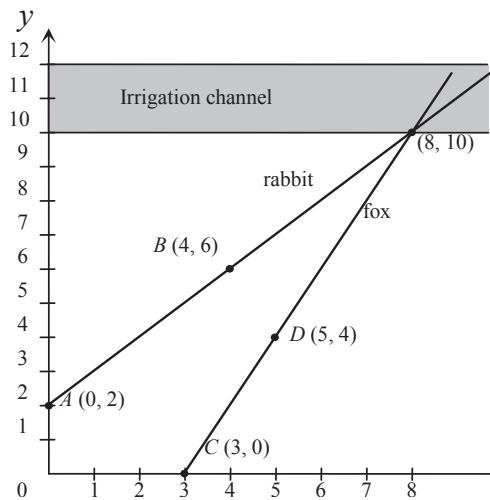

8 a For the equation of line AB , let $(x_1, y_1) = (-4.5, 2)$ and $(x_2, y_2) = (0.25, 7)$.

$$\begin{aligned}
 m &= \frac{y_2 - y_1}{x_2 - x_1} \\
 &= \frac{7 - 2}{0.25 - (-4.5)} \\
 &= \frac{5}{4.75} \\
 &= \frac{20}{19}
 \end{aligned}$$

Now $y - y_1 = m(x - x_1)$

$$\therefore y - 2 = \frac{20}{19}(x - (-4.5))$$

$$\therefore y = \frac{20}{19}x + \frac{90}{19} + 2$$

$$\therefore y = \frac{20}{19}x + \frac{128}{19}$$

The equation of line AB is $y = \frac{20}{19}x + \frac{128}{19}$.

\therefore the y -coordinate of the point V is the y -axis intercept of $\frac{128}{19}$.

b For the equation of line VC , let $(x_1, y_1) = (0, \frac{128}{19})$ and $(x_2, y_2) = (5, 1.5)$.

$$\begin{aligned}
 C = \frac{128}{19} \text{ and } m &= \frac{y_2 - y_1}{x_2 - x_1} \\
 &= \frac{1.5 - \frac{128}{19}}{5 - 0} \\
 &= \frac{\frac{57}{38} - \frac{256}{38}}{5} = \frac{1}{5} \times -\frac{199}{38} = -\frac{199}{190}
 \end{aligned}$$

Now $y = mx + c$

$$y = -\frac{199}{190}x + \frac{128}{19} \text{ is the equation of the line } VC.$$

c Cuts AB and VC are not equally inclined to the vertical axis because the gradients of AB and VC (although opposite in sign) are not the same size, (gradient $AB \approx 1.053$, gradient $VC \approx -1.047$).

9 a For the equation of line PQ , let $(x_1, y_1) = (4, -75)$ and $(x_2, y_2) = (36, -4)$.

$$\begin{aligned}
 m &= \frac{y_2 - y_1}{x_2 - x_1} \\
 &= \frac{-4 - (-75)}{36 - 4} \\
 &= \frac{71}{32}
 \end{aligned}$$

Now $y - y_1 = m(x - x_1)$

$$\therefore y - (-75) = \frac{71}{32}(x - 4)$$

$$\therefore y + 75 = \frac{71}{32}x - \frac{71}{8}$$

$$\therefore y = \frac{71}{32}x - \frac{671}{8} \text{ is the equation of line } PQ.$$

When $7x = 20$,

$$\begin{aligned}
 y &= \frac{71}{32} \times 20 - \frac{671}{8} \\
 &= \frac{355}{8} - \frac{671}{8} \\
 &= \frac{-316}{8} \\
 &= -39\frac{1}{2}
 \end{aligned}$$

i.e. line PQ does not pass directly over a hospital located at $H(20, -36)$.

b When $y = -36$,

$$-36 = \frac{71}{32}x - \frac{671}{8}$$

$$\therefore \frac{383}{8} = \frac{71}{32}x$$

$$\therefore x = \frac{383}{8} \times \frac{32}{71} = 21\frac{41}{71}$$

i.e. when $y = -36$, the aircraft is $21\frac{41}{71}$ km east of H .

10 a 5 km due south of E is $D(68, 30)$.

For the equation of line AD , let $(x_1, y_1) = (48, 10)$ and $(x_2, y_2) = (68, 30)$.

$$m = \frac{y_2 - y_1}{x_2 - x_1} = \frac{30 - 10}{68 - 48} = 1$$

Now $y - y_1 = m(x - x_1)$

$$\therefore y - 10 = 1(x - 48)$$

$$\therefore y = x - 38 \text{ is the equation of the new runway.}$$

b $A(48, 10)$

$$\therefore B((48 + 8), y) = (56, y)$$

$$\begin{aligned} \text{When } x = 56, \quad y &= x - 38 \\ &= 56 - 38 \\ &= 18 \end{aligned}$$

\therefore the coordinates of B are $(56, 18)$.

c Consider the line connecting $C(88, -10)$ and $D(68, 30)$.

Let $(x_1, y_1) = (88, -10)$ and $(x_2, y_2) = (68, 30)$.

$$\begin{aligned} m &= \frac{y_2 - y_1}{x_2 - x_1} \\ &= \frac{30 - (-10)}{68 - 88} \\ &= \frac{40}{-20} = -2 \end{aligned}$$

$$\text{Now} \quad y - y_1 = m(x - x_1)$$

$$\therefore y - (-10) = -2(x - 88)$$

$$\therefore y + 10 = -2x + 176$$

$$\therefore y = -2x + 166 \text{ is the equation defining the line } CD.$$

d $y = 10$ for an auxiliary beacon due east of A .

$$\therefore 2x + 10 = 166$$

$$\therefore 2x = 156$$

$$\therefore x = 78$$

i.e. the coordinates of the auxiliary beacon are $(78, 10)$.

$$\begin{aligned} \mathbf{11 \ a} \quad \text{Gradient of } AB &= \frac{6 - 8}{8 - 2} \\ &= -\frac{2}{6} \\ &= -\frac{1}{3} \end{aligned}$$

As $AD \perp AB$, gradient of $AD = 3$.

Equation of the line through A and D is

$$y - 8 = 3(x - 2)$$

$$= 3x - 6$$

$$\therefore y = 3x + 2$$

b D lies on the line with equation $y = 3x + 2$, and has an x -coordinate of 0 .

When $x = 0, y = 2 \therefore D$ is the point $(0, 2)$.

c Let M be the midpoint of AB , with coordinates (x, y) .

$$x = \frac{2+8}{2} = 5$$

and $y = \frac{8+6}{2} = 7$

$\therefore M$ is the point $(5, 7)$.

The point M lies on the perpendicular bisector of AB that has a gradient 3.

The equation of the perpendicular bisector of AB is

$$\begin{aligned} y - 7 &= 3(x - 5) \\ &= 3x - 15 \end{aligned}$$

$$\therefore y = 3x - 8$$

d Let C be the point (a, b) .

C lies on the lines with equation $y = 3x - 8$ and $3y = 4x - 14$

$$\therefore b = 3a - 8 \quad (1)$$

and $3b = 4a - 14 \quad (2)$

Substituting (1) into (2) yields

$$3(3a - 8) = 4a - 14$$

$$\therefore 9a - 24 = 4a - 14$$

$$\therefore 5a = 10$$

$$\therefore a = 2$$

$$\therefore b = 3(2) - 8 = -2$$

$\therefore C$ is the point $(2, -2)$.

e Area of triangle ADC

Using $\frac{1}{2}$ (base)(height), area $\triangle ADC$ is simply

$$\frac{1}{2}(2)(10) = 10 \text{ square units [since } AC = \text{base length} = 10 \text{ units]}$$

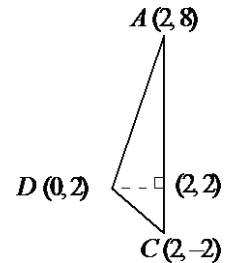

f Area $\triangle ABC$ is simply $\frac{1}{2}(6)(10) = 30$ square units

Area of quadrilateral $ABCD$

$$= \text{area of } \triangle ADC + \text{area of } \triangle ABC$$

$$= 10 + 30$$

$$= 40 \text{ square units}$$

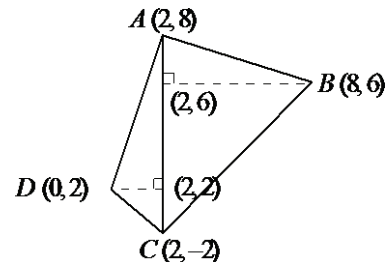

12 a $C = 40x + 30\,000$

b When $x = 6000$,

$$C = 40 \times 6000 + 30\,000$$

$$= 270\,000$$

$$\text{Cost per wheelbarrow} = \frac{270\,000}{6000}$$

$$= 45$$

i.e. overall cost per wheelbarrow is \$45.

c Cost per wheelbarrow = \$46

$$\therefore \frac{40x + 30\,000}{x} = 46$$

$$\therefore 40x + 30\,000 = 46x$$

$$\therefore 30\,000 = 6x$$

$$\therefore x = 5000$$

i.e. 5000 wheelbarrows must be made for an overall cost of \$46 each.

d $R = 80x$

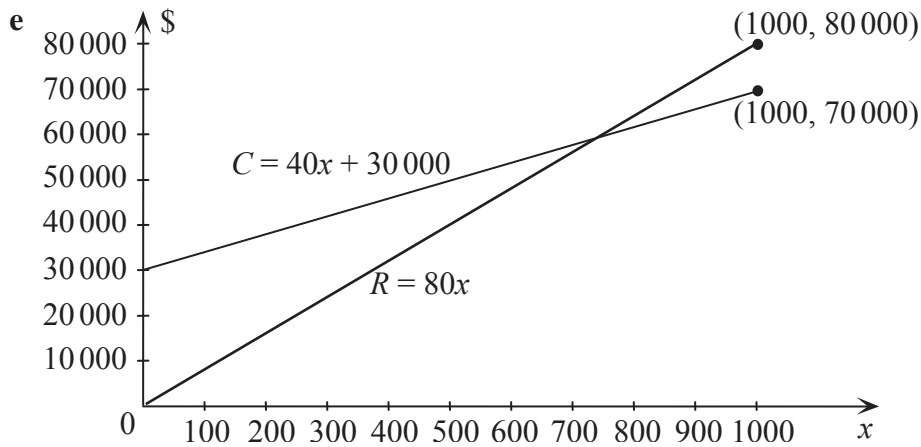

f $R > C$, $\therefore 80x > 40x + 30\,000$

$$\therefore 40x > 30\,000$$

$$\therefore x > 750$$

i.e. minimum number of wheelbarrows to make a profit is 751.

g $P = R - C$

$$= 80x - (40x + 30\,000)$$

$$= 40x - 30\,000$$

13 a Cost of Method 1 = $100 + 0.08125 \times 1560$
 $= 226.75$

Cost of Method 2 = $4 \times 27.5 + 0.075 \times 1560$
 $= 227$

i.e. Method 1 is cheaper for 1560 units.

b

	Number of units of electricity			
	0	1000	2000	3000
Cost (\$) by Method 1	100	181.25	262.50	343.75
Cost (\$) by Method 2	110	185	260	335

Calculations for Method 1:

$$100 + 0.08125 \times 0 = 100$$

$$100 + 0.08125 \times 1000 = 181.25$$

$$100 + 0.08125 \times 2000 = 262.50$$

$$100 + 0.08125 \times 3000 = 343.75$$

Calculations for Method 2:

$$4 \times 27.5 + 0.075 \times 0 = 110$$

$$4 \times 27.5 + 0.075 \times 1000 = 185$$

$$4 \times 27.5 + 0.075 \times 2000 = 260$$

$$4 \times 27.5 + 0.075 \times 3000 = 335$$

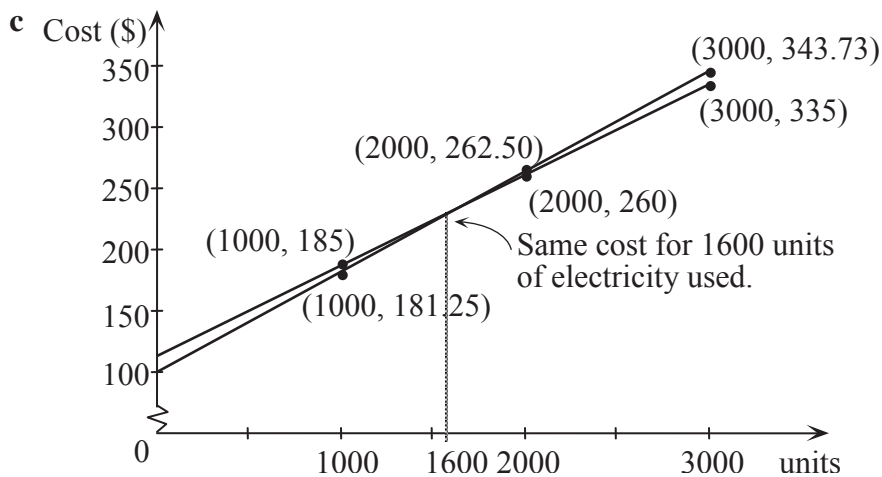

d $C_1 = 100 + 0.08125x$

$$C_2 = 4 \times 27.5 + 0.075 \times x$$

$$= 110 + 0.075x$$

$$\begin{aligned} \text{When } C_1 = C_2, \quad 100 + 0.08125x &= 110 + 0.075x \\ 0.00625x &= 10 \\ x &= 1600 \end{aligned}$$

14 a M is the point directly below the intersection of lines AC and BD .

Find the equations of the lines AC and BD .

M is the midpoint of both AC and BD .

Use the midpoint formula to find the coordinates of M .

Using line AC :

$$\begin{aligned} M &= \left(\frac{10 + 24}{2}, \frac{16 + 8}{2} \right) \\ &= (17, 12) \end{aligned}$$

i.e. the point to which the hook must be moved has coordinates $(17, 12)$.

b $(17, 12)$ is a point on the line, and $m =$ gradient of AB

where $(x_1, y_1) = (10, 16)$

and $(x_2, y_2) = (16, 20)$

$$\therefore m = \frac{20 - 16}{16 - 10} = \frac{2}{3}$$

\therefore equation of line parallel to AB is

$$y - 12 = \frac{2}{3}(x - 17)$$

$$\therefore y = \frac{2}{3}x - \frac{34}{3} + 12$$

$$\therefore 3y = 2x + 2$$

15 a Find equations of lines PA, AB, BC, CD and DP using the formula $y - y_1 = m(x - x_1)$, where $m = -\frac{y_2 - y_1}{x_2 - x_1}$.

$$\begin{aligned} \text{For line } PA \quad m &= \frac{60 - 120}{100 - 0} \\ &= -\frac{3}{5} \end{aligned}$$

$$y - 120 = -\frac{3}{5}(x - 0)$$

$$\therefore y = -\frac{3}{5}x + 120$$

$$\begin{aligned} \text{For line } AB \quad m &= \frac{100 - 60}{200 - 100} \\ &= \frac{2}{5} \end{aligned}$$

$$y - 60 = \frac{2}{5}(x - 100)$$

$$\therefore y = \frac{2}{5}x + 20$$

$$\begin{aligned} \text{For line } BC \quad m &= \frac{200 - 100}{160 - 200} \\ &= -\frac{5}{2} \end{aligned}$$

$$y - 100 = -\frac{5}{2}(x - 200)$$

$$y = -\frac{5}{2}x + 600$$

$$\begin{aligned} \text{For line } CD \quad m &= \frac{160 - 200}{60 - 160} \\ &= \frac{2}{5} \end{aligned}$$

$$y - 200 = \frac{2}{5}(x - 160)$$

$$\therefore y = \frac{2}{5}x + 136$$

$$\begin{aligned} \text{For line } DP \quad m &= \frac{120 - 160}{0 - 60} \\ &= \frac{2}{3} \end{aligned}$$

$$y - 120 = \frac{2}{3}(x - 0)$$

$$\therefore y = \frac{2}{3}x + 120$$

b $m_{PA} = -\frac{3}{5}$

$$m_{AB} = \frac{2}{5}$$

$$m_{BC} = -\frac{5}{2}$$

$$m_{CD} = \frac{2}{5}$$

and $m_{DP} = \frac{2}{3}$

Now $m_{AB} = m_{CD} = \frac{2}{5}$

and $m_{AB} \times m_{BC} = \frac{2}{5} \times -\frac{5}{2} = -1$

\therefore line BC is perpendicular to lines AB and CD , which are parallel.

Hence $\angle ABC$ and $\angle BCD$ are right angles.

Chapter 3 – Quadratics

Solutions to Exercise 3A

1 a $2(x - 4) = 2x - 8$

b $-2(x - 4) = -2x + 8$

c $3(2x - 4) = 6x - 12$

d $-3(4 - 2x) = 6x - 12$

e $x(x - 1) = x^2 - x$

f $2x(x - 5) = 2x^2 - 10x$

2 a $(2x + 4x) + 1 = 6x + 1$

b $(2x + x) - 6 = 3x - 6$

c $(3x - 2x) + 1 = x + 1$

d $(-x + 2x + 4x) - 3 = 5x - 3$

3 a $8(2x - 3) - 2(x + 4)$
 $= 16x - 24 - 2x - 8$
 $= 14x - 32$

b $2x(x - 4) - 3x$
 $= 2x^2 - 8x - 3x$
 $= 2x^2 - 11x$

c $4(2 - 3x) + 4(6 - x)$
 $= 8 - 12x + 24 - 4x$
 $= 32 - 16x$

d $4 - 3(5 - 2x)$
 $= 4 - 15 + 6x$
 $= 6x - 11$

4 a $2x(x - 4) - 3x$
 $= 2x^2 - 8x - 3x$
 $= 2x^2 - 11x$

b $2x(x - 5) + x(x - 5)$
 $= 2x^2 - 10x + x^2 - 5x$
 $= 3x^2 - 15x$

c $2x(-10 - 3x)$
 $= -20x - 6x^2$

d $3x(2 - 3x + 2x^2)$
 $= 6x - 9x^2 + 6x^3$

e $3x - 2x(2 - x)$
 $= 3x - 4x + 2x^2$
 $= 2x^2 - x$

f $3(4x - 2) - 6x$
 $= 12x - 6 - 6x$
 $= 6x - 6$

5 a $(3x - 7)(2x + 4)$
 $= 6x^2 + 12x - 14x - 28$
 $= 6x^2 - 2x - 28$

b $(x - 10)(x - 12)$
 $= x^2 - 10x - 12x + 120$
 $= x^2 - 22x + 120$

c $(3x - 1)(12x + 4)$
 $= 36x^2 + 12x - 12x - 4$
 $= 36x^2 - 4$

$$\begin{aligned} \mathbf{d} \quad & (4x - 5)(2x - 3) \\ & = 8x^2 - 12x - 10x + 15 \\ & = 8x^2 - 22x + 15 \end{aligned}$$

$$\begin{aligned} \mathbf{e} \quad & (x - \sqrt{3})(x - 2) \\ & = x^2 - 2x - \sqrt{3}x + 2\sqrt{3} \\ & = x^2 - (2 + \sqrt{3})x + 2\sqrt{3} \end{aligned}$$

$$\begin{aligned} \mathbf{f} \quad & (2x - \sqrt{5})(x + \sqrt{5}) \\ & = 2x^2 + 2\sqrt{5}x - \sqrt{5}x - 5 \\ & = 2x^2 + \sqrt{5}x - 5 \end{aligned}$$

$$\begin{aligned} \mathbf{g} \quad & (3x - \sqrt{7})(x + \sqrt{7}) \\ & = 3x^2 + 3\sqrt{7}x - 2\sqrt{7}x - 14 \\ & = 3x^2 + \sqrt{7}x - 14 \end{aligned}$$

$$\begin{aligned} \mathbf{h} \quad & (5x - 3)(x + 2\sqrt{2}) \\ & = 5x^2 + 10\sqrt{2}x - 3x - 6\sqrt{2} \\ & = 5x^2 + (10\sqrt{2} - 3)x - 6\sqrt{2} \end{aligned}$$

$$\begin{aligned} \mathbf{i} \quad & (\sqrt{5}x - 3)(\sqrt{5}x - 32\sqrt{2}) \\ & = 5x^2 - 32\sqrt{10}x - 3\sqrt{5}x + 96\sqrt{2} \\ & = 5x^2 - (32\sqrt{10} + 3\sqrt{5})x + 96\sqrt{2} \end{aligned}$$

$$\begin{aligned} \mathbf{6} \quad \mathbf{a} \quad & (2x - 3)(3x^2 + 2x - 4) \\ & = 6x^3 + 4x^2 - 8x - 9x^2 - 6x + 12 \\ & = 6x^3 - 5x^2 - 14x + 12 \end{aligned}$$

$$\begin{aligned} \mathbf{b} \quad & (x - 1)(x^2 + x + 1) \\ & = x^3 + x^2 + x - x^2 - x - 1 \\ & = x^3 - 1 \end{aligned}$$

$$\begin{aligned} \mathbf{c} \quad & (6 - 2x - 3x^2)(4 - 2x) \\ & = 24 - 12x - 8x + 4x^2 - 12x^2 + 6x^3 \\ & = 24 - 20x - 8x^2 + 6x^3 \end{aligned}$$

$$\begin{aligned} \mathbf{d} \quad & (5x - 3)(x + 2) - (2x - 3)(x + 3) \\ & = (5x^2 + 10x - 3x - 6) \\ & \quad - (2x^2 + 6x - 3x - 9) \\ & = (5x^2 + 7x - 6) - (2x^2 + 3x - 9) \\ & = 3x^2 + 4x + 3 \end{aligned}$$

$$\begin{aligned} \mathbf{e} \quad & (2x + 3)(3x - 2) - (4x + 2)(4x - 2) \\ & = (6x^2 - 4x + 9x - 6) \\ & \quad - (16x^2 - 8x + 8x - 4) \\ & = (6x^2 + 5x - 6) - (16x^2 - 4) \\ & = -10x^2 + 5x - 2 \end{aligned}$$

$$\begin{aligned} \mathbf{7} \quad \mathbf{a} \quad & (x - 4)^2 \\ & = x^2 - 4x - 4x + 16 \\ & = x^2 - 8x + 16 \end{aligned}$$

$$\begin{aligned} \mathbf{b} \quad & (2x - 3)^2 \\ & = 4x^2 - 6x - 6x + 9 \\ & = 4x^2 - 12x + 9 \end{aligned}$$

$$\begin{aligned} \mathbf{c} \quad & (6 - 2x)^2 \\ & = 36 - 12x - 12x + 4x^2 \\ & = 36 - 24x + 4x^2 \end{aligned}$$

$$\begin{aligned} \mathbf{d} \quad & \left(x - \frac{1}{2}\right)^2 \\ & = x^2 - \frac{x}{2} - \frac{x}{2} + \frac{1}{4} \\ & = x^2 - x + \frac{1}{4} \end{aligned}$$

$$\begin{aligned} \mathbf{e} \quad & (x - \sqrt{5})^2 \\ & = x^2 - \sqrt{5}x - \sqrt{5}x + 5 \\ & = x^2 - 2\sqrt{5}x + 5 \end{aligned}$$

$$\begin{aligned} \mathbf{f} \quad & (x - 2\sqrt{3})^2 \\ & = x^2 - 2\sqrt{3}x - 2\sqrt{3}x + 4(3) \\ & = x^2 - 4\sqrt{3}x + 12 \end{aligned}$$

$$\begin{aligned} \mathbf{8} \quad \mathbf{a} \quad & (x - 3)(x + 3) \\ & = x^2 - 3x + 3x - 9 \\ & = x^2 - 9 \end{aligned}$$

$$\begin{aligned} \mathbf{b} \quad & (2x - 4)(2x + 4) \\ & = 4x^2 + 8x - 8x - 16 \\ & = 4x^2 - 16 \end{aligned}$$

$$\begin{aligned} \mathbf{c} \quad & (9x - 11)(9x + 11) \\ & = 81x^2 + 99x - 99x + 121 \\ & = 81x^2 - 121 \end{aligned}$$

$$\begin{aligned} \mathbf{d} \quad & (2x - 3)(2x + 3) \\ & = 4x^2 - 9 \end{aligned}$$

$$\begin{aligned} \mathbf{e} \quad & (2x + 5)(2x - 5) \\ & = 4x^2 - 25 \end{aligned}$$

$$\begin{aligned} \mathbf{f} \quad & (x - \sqrt{5})(x + \sqrt{5}) \\ & = x^2 - 5 \end{aligned}$$

$$\begin{aligned} \mathbf{g} \quad & (2x + 3\sqrt{3})(2x + 3\sqrt{3}) \\ & = 4x^2 - 27 \end{aligned}$$

$$\begin{aligned} \mathbf{h} \quad & (\sqrt{3} - \sqrt{7})(\sqrt{3} + \sqrt{7}) \\ & = 3x^2 - 7 \end{aligned}$$

$$\begin{aligned} \mathbf{9} \quad \mathbf{a} \quad & (x - y + z)(x - y - z) \\ & = ((x - y) + z)((x - y) - z) \\ & = (x - y)^2 - z^2 \\ & = x^2 - 2xy + y^2 - z^2 \end{aligned}$$

$$\begin{aligned} \mathbf{b} \quad & (2a - b + c)(2a - b - c) \\ & = ((2a - b) + c)((2a - b) - c) \\ & = (2a - b)^2 - c^2 \\ & = 4a^2 - 4ab + b^2 - c^2 \end{aligned}$$

$$\begin{aligned} \mathbf{c} \quad & (3w - 4z + u)(3w + 4z - u) \\ & = (3w - (4z - u))(3w + (4z - u)) \\ & = (3w)^2 - (4z - u)^2 \\ & = 9w^2 - 16z^2 + 8zu - u^2 \end{aligned}$$

$$\begin{aligned} \mathbf{d} \quad & (2a - \sqrt{5}b + c)(2a + \sqrt{5}b + c) \\ & = (2a + c - \sqrt{5}b)(2a + c + \sqrt{5}b) \\ & = (2a + c)^2 - 5b^2 \\ & = 4a^2 + 4ac + c^2 - 5b^2 \end{aligned}$$

$$\mathbf{10} \quad \mathbf{a} \quad \mathbf{i} \quad A = x^2 + 2x + 1$$

$$\mathbf{ii} \quad A = (x + 1)^2$$

$$\mathbf{b} \quad \mathbf{i} \quad A = (x - 1)^2 + 2(x - 1) + 1$$

$$\mathbf{ii} \quad A = x^2$$

Solutions to Exercise 3B

1 a $2x + 4 = 2(x + 2)$

b $4a - 8 = 4(a - 2)$

c $6 - 3x = 3(2 - x)$

d $2x - 10 = 2(x - 5)$

e $18x + 12 = 6(3x + 2)$

f $24 - 16x = 8(3 - 2x)$

2 a $4x^2 - 2xy = 2x(2x - y)$

b $8ax + 32xy = 8x(a + 4y)$

c $6ab - 12b = 6b(a - 2)$

d $6xy + 14x^2y = 2xy(3 + 7x)$

e $x^2 + 2x = x(x + 2)$

f $5x^2 - 15x = 5x(x - 3)$

g $-4x^2 - 16x = -4x(x + 4)$

h $7x + 49x^2 = 7x(1 + 7x)$

i $2x - x^2 = x(2 - x)$

3 a $6x^3y^2 + 12y^2x^2 = 6x^2y^2(x + 2)$

b $7x^2y - 6y^2x = xy(7x - 6y)$

c $8x^2y^2 + 6y^2x = 2xy^2(4x + 3)$

4 a $x^3 + 5x^2 + x + 5$
 $= x^2(x + 5) + (x + 5)$
 $= (x + 5)(x^2 + 1)$

b $xy + 2x + 3y + 6$
 $= x(y + 2) + 3(y + 2)$
 $= (x + 3)(y + 2)$

c $x^2y^2 - x^2 - y^2 + 1$
 $= x^2(y^2 - 1) - (y^2 - 1)$
 $= (x^2 - 1)(y^2 - 1)$
 $= (x - 1)(x + 1)(y - 1)(y + 1)$

d $ax + ay + bx + by$
 $= a(x + y) + b(x + y)$
 $= (a + b)(x + y)$

e $a^3 - 3a^2 + a - 3$
 $= a^2(a - 3) + (a - 3)$
 $= (a^2 + 1)(a - 3)$

f $2ab - 12a - 5b + 30$
 $= 2a(b - 6) - 5(b - 6)$
 $= (b - 6)(2a - 5)$

g $2x^2 - 2x + 5x - 5$
 $= 2x(x - 1) + 5(x - 1)$
 $= (x - 1)(2x + 5)$

h $x^3 - 4x + 2x^2 - 8$
 $= x(x^2 - 4) + 2(x^2 - 4)$
 $= (x^2 - 4)(x + 2)$
 $= (x - 2)(x + 2)(x + 2)$

i $x^3 - bx^2 - a^2x + a^2b$
 $= x^2(x - b) - a^2(x - b)$
 $= (x^2 - a^2)(x - b)$
 $= (x - a)(x + a)(x - b)$

5 a $x^2 - 36 = (x - 6)(x + 6)$

b $x^2 - 81 = (x - 9)(x + 9)$

c $x^2 - a^2 = (x - a)(x + a)$

d $4x^2 - 81 = (2x - 9)(2x + 9)$

e $9x^2 - 16 = (3x - 4)(3x + 4)$

f $25x^2 - y^2 = (5x - y)(5x + y)$

g $3x^2 - 48 = 3(x^2 - 16)$
 $= 4(x - 4)(x + 4)$

h $2x^2 - 98 = 2(x^2 - 49)$
 $= 2(x - 7)(x + 7)$

i $3ax^2 - 27a = 3a(x^2 - 9)$
 $= 3a(x - 3)(x + 3)$

j $a^2 - 7 = (a - \sqrt{7})(x + \sqrt{7})$

k $2a^2 - 5 = (\sqrt{2}a - \sqrt{5})(\sqrt{2}a + \sqrt{5})$

l $x^2 - 12 = (x - \sqrt{12})(x + \sqrt{12}) =$
 $(x - 2\sqrt{3})(x + 2\sqrt{3})$

6 a $(x - 2)^2 - 16$
 $= (x - 2 - 4)(x - 2 + 4)$
 $= (x - 6)(x + 2)$

b $25 - (2 + x)^2$
 $= (5 - (2 + x))(5 + (2 + x))$
 $= (3 - x)(7 + x)$

c $3(x + 1)^2 - 12 = 3((x + 1)^2 - 4)$
 $= 3(x + 1 - 2)(x + 1 + 2)$
 $= 3(x - 1)(x + 3)$

d $(x - 2)^2 - (x + 3)^2$
 $= ((x - 2) - (x + 3))((x - 2) + (x + 3))$
 $= (x - 2 - x - 3)(x - 2 + x + 3)$
 $= -5(2x + 1)$

e $(2x - 3)^2 - (2x + 3)^2$
 $= ((2x - 3) - (2x + 3))((2x - 3) + (2x + 3))$
 $= (-6)(4x)$
 $= -24x$

f $(2x - 1)^2 - (3x + 6)^2$
 $= ((2x - 1) - (3x + 6))((2x - 1) + (3x + 6))$
 $= (-x - 7)(5x + 5)$
 $= -5(x + 7)(x + 1)$

7 a Check signs: must be + and -
 $x^2 - 7x - 18 = (x - 9)(x + 2)$

b Check signs: must be - and -
 $y^2 - 19y + 48 = (y - 16)(y - 3)$

c $a^2 - 14a + 24 = (a - 12)(a - 2)$

d $a^2 + 18a + 81 = (a + 9)(a + 9) =$
 $(a + 9)^2$

e $x^2 - 5x - 24 = (x - 8)(x + 3)$

f $x^2 - 2x - 120 = (x - 12)(x + 10)$

8 a Check signs: must be - and -
 $3x^2 - 7x + 2 = (3x - a)(x - b)$
 $a + 3b = 7; ab = 2$
 $b = 2, a = 1:$
 $3x^2 - 7x + 2 = (3x - 1)(x - 2)$

b Check signs: must be + and +
 $6x^2 + 7x + 2 = (6x + a)(x + b)$
 $a + 6b = 7, ab = 2$; no solution.

Try:

$$6x^2 + 7x + 2 = (3x + a)(2x + b)$$

$$2a + 3b = 7, ab = 2$$

$$a = 2, b = 1$$

$$6x^2 + 7x + 2 = (3x + 2)(2x + 1)$$

c $5x^2 + 23x + 12 = (5x + a)(x + b)$

$$a + 5b = 23; ab = 12$$

$$\therefore b = 4, a = 3$$

$$5x^2 + 23x + 12 = (5x + 3)(x + 4)$$

d $2x^2 + 9x + 4$

$$= 2x^2 + x + 8x + 4$$

$$= x(2x + 1) + 4(2x + 1)$$

$$= (2x + 1)(x + 4)$$

e $6x^2 - 19x + 10$

$$= 6x^2 - 15x - 4x + 10$$

$$= 3x(2x - 5) - 2(2x - 5)$$

$$= (2x - 5)(3x - 2)$$

f $6x^2 - 7x - 3$

$$= 6x^2 - 9x + (2x - 3)$$

$$= 3x(2x - 3) + (2x - 3)$$

$$= (2x - 3)(3x + 1)$$

g $12x^2 - 17x + 6$

$$= 12x^2 - 9x - 8x + 6$$

$$= 3x(4x - 3) - 2(4x - 3)$$

$$= (4x - 3)(3x - 2)$$

h $5x^2 - 4x - 12$

$$= 5x^2 - 10x + 6x - 12$$

$$= 5x(x - 2) + 6(x - 2)$$

$$= (x - 2)(5x + 6)$$

i $5x^3 - 16x^2 + 12x$

$$= x(5x^2 - 16x + 12)$$

$$= x(5x^2 - 10x - 6x + 12)$$

$$= x(5x(x - 2) - 6(x - 2))$$

$$= x(x - 2)(5x - 6)$$

9 a Check signs: must be + and -

$$3y^2 - 12y - 36 = 3(y^2 - 4y - 12)$$

$$= 3(y^2 - 4y - 12)$$

$$= 3(y + a)(y - b)$$

$$a - b = -4; ab = 12$$

$$\therefore a = 2, b = 6$$

$$3y^2 - 12y - 36 = 3(y + 2)(y - 6)$$

b $2x^2 - 18x + 28 = 2(x^2 - 9x + 14)$

$$= 2(x - 2)(x - 7)$$

c $4x^2 - 36x + 72 = 4(x^2 - 9x + 18)$

$$= 4(x - 6)(x - 3)$$

d $3x^2 + 15x + 18 = 3(x^2 + 5x + 6)$

$$= 3(x + 3)(x + 2)$$

e $ax^2 + 7ax + 12a = a(x^2 + 7x + 12)$

$$= a(x + 3)(x + 4)$$

f

$$48x - 24x^2 + 3x^3 = 3x(16 - 8x + x^2)$$

$$= 3x(4 - x)^2 \text{ or } 3x(x - 4)^2$$

10 a $(x - 1)^2 + 4(x - 1) + 3$

Put $y = x - 1$:

$$= y^2 + 4y + 3$$

$$= (y + 3)(y + 1)$$

$$= (x - 1 + 3)(x - 1 + 1)$$

$$= x(x + 2)$$

b $2(x - 1)^2 + 5(x - 1) - 3$

Put $a = x - 1$:

$$= 2a^2 + 5a - 3$$

$$= (2a - 1)(a + 3)$$

$$= (2(x - 1) - 1)(x - 1 + 3)$$

$$= (2x - 3)(x + 2)$$

c $(2x + 1)^2 + 7(2x + 1) + 12$

Put $a = 2x + 1$:

$$= a^2 + 7a + 12$$

$$= (a + 3)(a + 4)$$

$$= (2x + 1 + 3)(2x + 1 + 4)$$

$$= (2x + 4)(2x + 5)$$

$$= 2(x + 2)(2x + 5)$$

Solutions to Exercise 3C

1 a $(x-2)(x-3) = 0, \therefore x = 2, 3$

b $x(2x-4) = 0, \therefore 2x(x-2) = 0$
 $\therefore x = 0, 2$

c $(x-4)(2x-6) = 0$
 $\therefore 2(x-4)(x-3) = 0$
 $\therefore x = 3, 4$

d $(3-x)(x-4) = 0$
 $\therefore x = 3, 4$

e $(2x-6)(x+4) = 0$
 $\therefore 2(x-3)(x+4) = 0$
 $\therefore x = 3, -4$

f $2x(x-1) = 0, \therefore x = 0, 1$

g $(5-2x)(6-x) = 0$
 $\therefore 2\left(\frac{5}{2}-x\right)(6-x) = 0$
 $\therefore x = \frac{5}{2}, 6$

h $x^2 = 16, \therefore x^2 - 16 = 0$
 $\therefore (x-4)(x+4) = 0$
 $\therefore x = 4, -4$

2 a $x^2 - 4x - 3 = 0$
 $\therefore x = -0.65, 4.65$

b $2x^2 - 4x - 3 = 0$
 $\therefore x = -0.58, 2.58$

c $-2x^2 - 4x + 3 = 0$
 $\therefore x = -2.58, 0.58$

3 a $x^2 - x - 72 = 0$
 $\therefore (x-9)(x+8) = 0$
 $\therefore x = 9, -8$

b $x^2 - 6x + 8 = 0$
 $\therefore (x-2)(x-4) = 0$
 $\therefore x = 2, 4$

c Check signs: must be + and -
 $x^2 - 8x - 33 = 0$
 $\therefore (x-a)(x+b) = 0$

$a - b = 8; ab = 33$
 $a = 11; b = 3$

$(x-11)(x+3) = 0$
 $\therefore x = 11, -3$

d $x(x+12) = 64$
 $x^2 + 12x - 64 = 0$

Check signs: must be + and -

$\therefore (x-a)(x+b) = 0$
 $b - a = 12; ab = 64;$

$b = 16; a = 4$
 $(x-4)(x+16) = 0$
 $\therefore x = 4, -16$

e Check signs: must be + and -

$$x^2 + 5x - 14 = 0$$

$$(x - a)(x + b) = 0$$

$$b - a = 5; ab = 14;$$

$$b = 7; a = 2$$

$$(x - 2)(x + 7) = 0$$

$$\therefore x = 2, -7$$

f $x^2 = 5x + 24, \therefore x^2 - 5x - 24 = 0$

Check signs: must be + and -

$$\therefore (x - a)(x + b) = 0$$

$$a - b = 5; ab = 24$$

$$a = 8; b = 3$$

$$(x - 8)(x + 3) = 0$$

$$\therefore x = 8, -3$$

4 a $2x^2 + 5x + 3 = 0$

$$\therefore (2x + a)(x + b) = 0$$

$$a + 2b = 5; ab = 3$$

$$a = 3; b = 2$$

$$(2x + 3)(x + 1) = 0$$

$$\therefore x = -\frac{3}{2}, -1$$

b $4x^2 - 8x + 3 = 0$

$$\therefore (2x - a)(2x - b) = 0$$

$$2a + 2b = 8; ab = 3$$

$$a = 3; b = 1$$

$$(2x - 3)(2x - 1) = 0$$

$$\therefore x = \frac{3}{2}, \frac{1}{2}$$

c $6x^2 + 13x + 6 = 0$

$$\therefore (3x + a)(2x + b) = 0$$

$$2a + 3b = 13; ab = 6$$

$$a = 2; b = 3$$

$$(3x + 2)(2x + 3) = 0$$

$$\therefore x = -\frac{2}{3}, -\frac{3}{2}$$

d $2x^2 - x = 6$

$$\therefore 2x^2 - x - 6 = 0$$

$$\therefore x = -\frac{3}{2}, 2$$

e $6x^2 + 15 = 23x$

$$\therefore 6x^2 - 23x + 15 = 0$$

$$\therefore (6x - a)(x - b) = 0$$

$$a + 6b = 23; ab = 15$$

$$b = 3; a = 5$$

$$(6x - 5)(x - 3) = 0$$

$$\therefore x = \frac{5}{6}, 3$$

f Check signs: must be + and -

$$2x^2 - 3x - 9 = 0$$

$$\therefore (2x - a)(x + b) = 0$$

$$2b - a = -3; ab = 9$$

$$b = -3; a = -3$$

$$(2x + 3)(x - 3) = 0$$

$$\therefore x = -\frac{3}{2}, 3$$

g $10x^2 - 11x + 3 = 0$
 $\therefore (5x - a)(2x - b) = 0$
 $2a + 5b = 11; ab = 3$
 $a = 3; b = 1$
 $(5x - 3)(2x - 1) = 0$
 $\therefore x = \frac{3}{5}, \frac{1}{2}$

h $12x^2 + x = 6$
 $\therefore 12x^2 + x - 6 = 0$
 Check signs: must be + and -
 $\therefore (6x - a)(2x + b) = 0$
 $6b - 2a = 1; ab = 6; \text{no solution}$
 $\therefore (4x - a)(3x + b) = 0$
 $4b - 3a = 1; ab = 6$
 $a = -3; b = -2$
 $(4x + 3)(3x - 2) = 0$
 $\therefore x = -\frac{3}{4}, \frac{2}{3}$

i $4x^2 + 1 = 4x$
 $\therefore 4x^2 - 4x + 1 = 0$
 $\therefore (2x - 1)^2 = 0, \therefore x = \frac{1}{2}$

j $x(x + 4) = 5$
 $x^2 + 4x - 5 = 0$
 Check signs: must be + and -
 $\therefore (x - a)(x + b) = 0$
 $b - a = 4; ab = 5$
 $b = 5; a = 1$
 $(x - 1)(x + 5) = 0$
 $\therefore x = 1, -5$

k $\frac{1}{7}x^2 = \frac{3}{7}x$
 $\therefore x^2 = 3x, \therefore x^2 - 3x = 0$
 $\therefore x(x - 3) = 0, \therefore x = 0, 3$

l $x^2 + 8x = -15$
 $x + 8x + 15 = 0$
 $(x + 5)(x + 3) = 0$
 $\therefore x = -5, -3$

m $5x^2 = 11x - 2$
 $\therefore 5x^2 - 11x + 2 = 0$
 $\therefore (5x - a)(x - b) = 0$
 $a + 5b = 11; ab = 2$
 $a = 1; b = 2$
 $(5x - 1)(x - 2) = 0$
 $\therefore x = \frac{1}{5}, 2$

5 Cut vertically down middle:

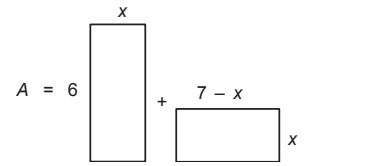

$A = 6x + x(7 - x)$
 $\therefore A = 6x + x(7 - x) = 30$
 $\therefore 6x + 7x - x^2 = 30$
 $\therefore x^2 - 13x + 30 = 0$
 $\therefore (x - 3)(x - 10) = 0$
 $\therefore x = 3, 10$

However, $0 < x < 7$ so $x = 3$

$$6 \quad M = \frac{wl}{2}x - \frac{w}{2}x^2$$

$$\therefore 104x - 8x^2 = 288$$

$$\therefore x^2 - 13x + 36 = 0$$

$$\therefore (x - 4)(x - 9) = 0$$

$$\therefore x = 4, 9$$

$$7 \quad h = 70t - 16t^2 = 76$$

$$\therefore 16t^2 - 70t + 76 = 0$$

$$\therefore 8t^2 - 35t + 38 = 0$$

$$\therefore (8t - 19)(t - 2) = 0$$

$$\therefore t = 2, \frac{19}{8} \text{ seconds}$$

$$8 \quad D = \frac{n}{2}(n - 3) = 65$$

$$\therefore n^2 - 3n - 130 = 0$$

$$\therefore (n - a)(n + b) = 0$$

$$b - a = -3; ab = 130$$

$$b = 10; a = 13$$

$$(n - 10)(n + 13) = 0$$

$$\therefore n = -10, 13$$

Since $n > 0$, the polygon has 13 sides.

$$9 \quad R = 1.6 + 0.03v + 0.003v^2 = 10.6$$

$$\therefore 3v^2 + 1600 + 30v = 10600$$

$$\therefore 3v^2 + 30v - 9000 = 0$$

$$\therefore v^2 + 10v - 3000 = 0$$

$$\therefore (v - a)(v + b) = 0$$

$$b - a = 10; ab = 3000$$

$$b = 60, a = 50$$

$$(v - 50)(v + 60) = 0$$

$$\therefore v = 50, -60$$

$$v \geq 0, \therefore v = 50 \text{ km/h}$$

$$10 \quad P = 2L + 2W = 16$$

$$\therefore L = 8 - W$$

$$A = LW = W(8 - W) = 12$$

$$\therefore 8W - W^2 = 12$$

$$\therefore W^2 - 8W + 12 = 0$$

$$\therefore (W - 2)(W - 6) = 0$$

$$\therefore w = 2, 6$$

Length = 6 cm, width = 2 cm

$$11 \quad A = \frac{bh}{2} = 15$$

$$h = b - 1, \therefore A = \frac{b}{2}(b - 1)$$

$$\frac{b}{2}(b - 1) = 15$$

$$b^2 - b = 30, \therefore b^2 - b - 30 = 0$$

$$\therefore (b + 5)(b - 6) = 0$$

$$b = 6, -5$$

$$b \geq 0, \therefore b = 6 \text{ cm}$$

Therefore height (altitude) = 5 cm

$$12 \quad e = c + 30 \dots (1)$$

$$\frac{1800}{e} + 10 = \frac{1800}{c} \dots (2)$$

Substitute (1) into (2):

$$\frac{1800}{c + 30} + 10 = \frac{1800}{c}$$

$$\therefore 1800c + 10c(c + 30) = 1800(c + 30)$$

$$\therefore 1800c + 10c^2 + 300c = 1800c + 54000$$

$$\therefore 10c^2 + 300c = 54000$$

$$\therefore c^2 + 30c - 5400 = 0$$

$$\therefore (c - a)(c + b) = 0$$

$$b - a = 30;$$

$$ab = 5400$$

$$b = 90, a = 60$$

$$(c - 60)(c + 90) = 0$$

$$\therefore c = \$60$$

Cheap seats are \$60, expensive \$90

13 Original cost per person = x

Original members = N where

$$Nx = 2100$$

$$\therefore x = \frac{2100}{N}$$

$$\text{Later: } (N - 7)(x + 10) = 2100$$

$$\therefore (N - 7)\left(\frac{2100}{N} + 10\right) = 2100$$

$$\therefore (N - 7)(2100 + 10N) = 2100N$$

$$\begin{aligned} \therefore 2100N - 14700 + 10N^2 - 70N \\ = 2100N \end{aligned}$$

$$\therefore -14700 + 10N^2 - 70N = 0$$

$$\therefore N^2 - 7N - 1470 = 0$$

$$\therefore (N - a)(N + b) = 0$$

$$a - b = 7; ab = 1470$$

$$a = 42; b = 35$$

$$\therefore (N - 42)(N + 35) = 0$$

$$\text{Since } N > 7, N = 42$$

So 42 members originally agreed to go on the bus.

Solutions to Exercise 3D

1 a $y = x^2 - 4$

- i** turning point at $(0, -4)$
- ii** the axis of symmetry $x = 0$
- iii** the x -axis intercepts $(-2, 0)$ and $(2, 0)$

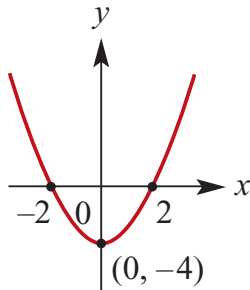

b $y = x^2 + 2$

- i** turning point at $(0, 2)$
- ii** the axis of symmetry $x = 0$
- iii** No x -axis intercepts: $y(\min) = 2$

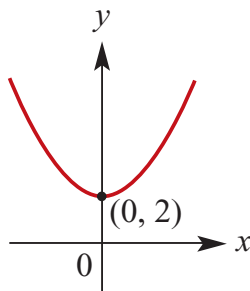

c $y = -x^2 + 3$

- i** turning point at $(0, 3)$
- ii** the axis of symmetry $x = 0$
- iii** the x -axis intercepts $(-\sqrt{3}, 0)$ and $(\sqrt{3}, 0)$

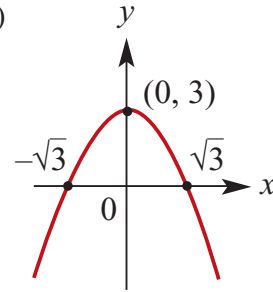

d $y = -2x^2 + 5$

- i** turning point at $(0, 5)$
- ii** the axis of symmetry $x = 0$
- iii** the x -axis intercepts $(-\sqrt{\frac{5}{2}}, 0)$ and $(\sqrt{\frac{5}{2}}, 0)$

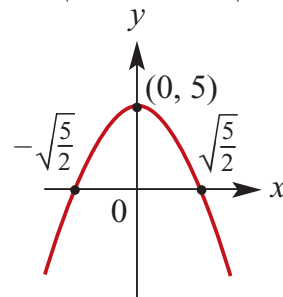

e $y = -x^2 + 4$

- i turning point at (0, 4)
- ii the axis of symmetry $x = 0$
- iii the x -axis intercepts (-2, 0) and (2, 0)

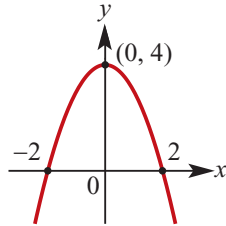

f $y = 3x^2 - 9$

- i turning point at (0, -9)
- ii the axis of symmetry $x = 0$
- iii the x -axis intercepts $(-\sqrt{3}, 0)$ and $(\sqrt{3}, 0)$

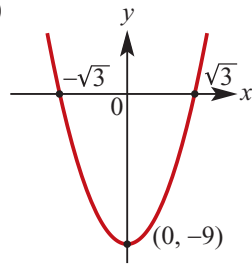

2 a $y = (x - 2)^2$

- i turning point at (2, 0)
- ii the axis of symmetry $x = 2$
- iii the x -axis intercept (2, 0) (turning pt)

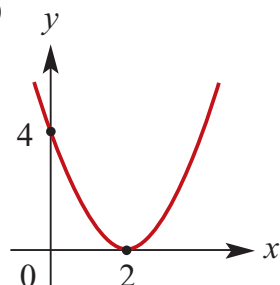

b $y = (x + 3)^2$

- i turning point at (-3, 0)
- ii the axis of symmetry $x = -3$
- iii the x -axis intercept (-3, 0) (= turning pt)

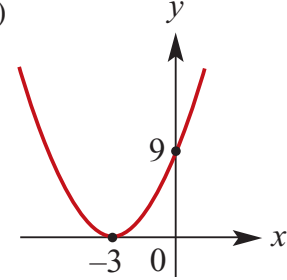

c $y = -(x + 1)^2$

- i turning point at (-1, 0)
- ii the axis of symmetry $x = -1$
- iii the x -axis intercept (-1, 0) (= turning pt)

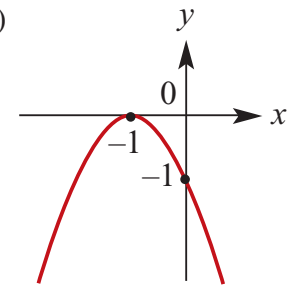

d $y = -\frac{1}{2}(x - 4)^2$

- i turning point at (4, 0)
- ii the axis of symmetry $x = 4$
- iii the x -axis intercept (4, 0) (= turning pt)

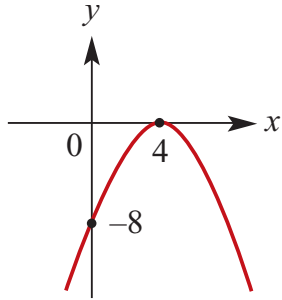

3 a $y = (x - 2)^2 + 1$

- i** turning point at (2, 1)
- ii** the axis of symmetry $x = 2$
- iii** no x -axis intercepts.

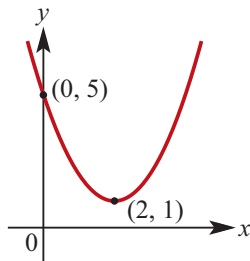

b $y = (x - 2)^2 - 1$

- i** turning point at (2, -1)
- ii** the axis of symmetry $x = 2$
- iii** the x -axis intercepts (1, 0) and (3, 0)

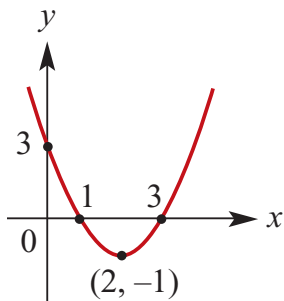

c $y = (x - 1)^2 + 2$

- i** turning point at (1, 2)

- ii** the axis of symmetry $x = 1$
- iii** no x -axis intercepts

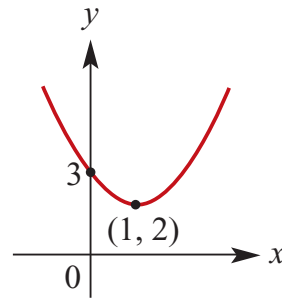

d $y = (x + 1)^2 - 1$

- i** turning point at (-1, -1)
- ii** the axis of symmetry $x = -1$
- iii** the x -axis intercepts (0, 0) and (-2, 0)

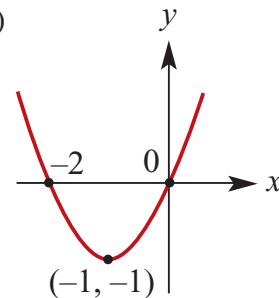

e $y = -(x - 3)^2 + 1$

- i** turning point at (3, 1)
- ii** the axis of symmetry $x = 3$
- iii** the x -axis intercepts:
 $y = -(x - 3)^2 + 1 = 0$
 $\therefore (x - 3)^2 = 1$
 $\therefore x - 3 = \pm 1$
 $\therefore x = 3 \pm 1$
(2, 0) and (4, 0)

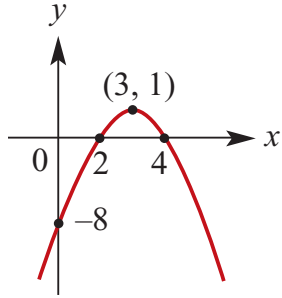

f $y = (x + 2)^2 - 4$

- i** turning point at $(-2, -4)$
- ii** the axis of symmetry $x = -2$
- iii** the x -axis intercepts $(0, 0)$ and $(-4, 0)$

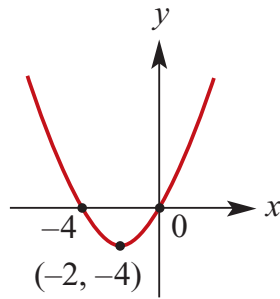

g $y = 2(x + 2)^2 - 18$

- i** turning point at $(-2, -18)$
- ii** the axis of symmetry $x = -2$
- iii** the x -axis intercepts:
 $y = 2(x + 2)^2 - 18 = 0$
 $\therefore 2(x + 2)^2 = 18$
 $\therefore (x + 2)^2 = 9$
 $\therefore x + 2 = \pm 3$
 $\therefore x = -2 \pm 3$
 $(-5, 0)$ and $(1, 0)$

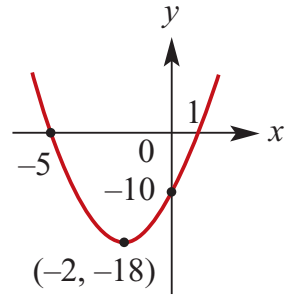

h $y = -3(x - 4)^2 + 3$

- i** turning point at $(4, 3)$
- ii** the axis of symmetry $x = 4$
- iii** the x -axis intercepts:

$$y = -3(x - 4)^2 + 3 = 0$$

$$\therefore 3(x - 4)^2 = 3$$

$$\therefore (x - 4)^2 = 1$$

$$\therefore x - 4 = \pm 1$$

$$\therefore x = 4 \pm 1$$

$(5, 0)$ and $(3, 0)$

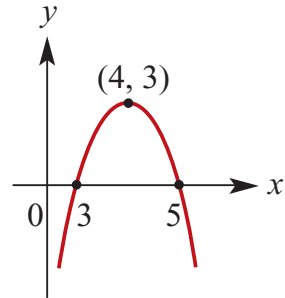

i $y = -\frac{1}{2}(x + 5)^2 - 2$

- i** turning point at $(-5, -2)$
- ii** the axis of symmetry $x = -5$
- iii** the x -axis intercepts:

$$y = -\frac{1}{2}(x + 5)^2 - 2 = 0$$

$$\therefore -\frac{1}{2}(x + 5)^2 = 2$$

$$\therefore (x + 5)^2 = -4$$

No x -axis intercepts because no real roots.

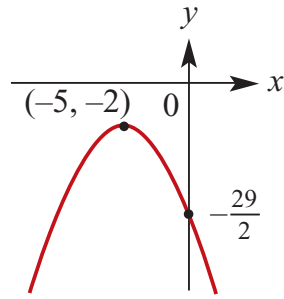

j $y = 3(x + 2)^2 - 12$

i turning point at $(-2, -12)$

ii the axis of symmetry $x = -2$

iii the x -axis intercepts:

$$y = 3(x + 2)^2 - 12 = 0$$

$$\therefore 3(x + 2)^2 = 12$$

$$\therefore (x + 2)^2 = 4$$

$$\therefore x + 2 = \pm 2$$

$$\therefore x = -2 \pm 2$$

$(0, 0)$ and $(-4, 0)$

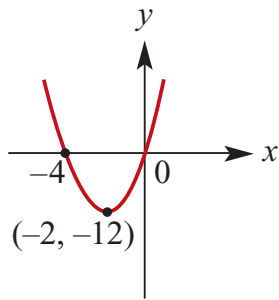

k $y = -4(x - 2)^2 + 8$

i turning point at $(2, 8)$

ii the axis of symmetry $x = 2$

iii the x -axis intercepts:

$$y = -4(x - 2)^2 + 8 = 0$$

$$\therefore 4(x - 2)^2 = 8$$

$$\therefore (x - 2)^2 = 2$$

$$\therefore x - 2 = \pm \sqrt{2}$$

$$\therefore x = 2 \pm \sqrt{2}$$

$(2 - \sqrt{2}, 0)$ and $(2 + \sqrt{2}, 0)$

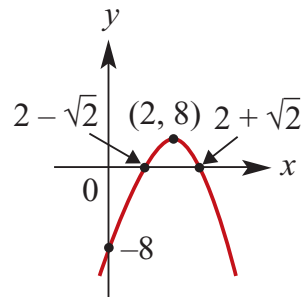

l $y = \frac{1}{3}(x - 1)^2 - 3$

i turning point at $(1, -3)$

ii the axis of symmetry $x = 1$

iii the x -axis intercepts $(-2, 0)$ and

$(4, 0)$

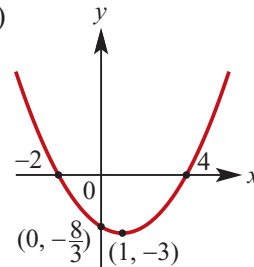

Solutions to Exercise 3E

1 a $(x - 1)^2 = x^2 - 2x + 1$

b $(x + 2)^2 = x^2 + 4x + 4$

c $(x - 3)^2 = x^2 - 6x + 9$

d $(-x + 3)^2 = x^2 - 6x + 9$

e $(-x - 2)^2 = (-1)^2(x + 2)^2$
 $= x^2 + 4x + 4$

f $(x - 5)^2 = x^2 - 10x + 25$

g $\left(x - \frac{1}{2}\right)^2 = x^2 - x + \frac{1}{4}$

h $\left(x - \frac{3}{2}\right)^2 = x^2 - 3x + \frac{9}{4}$

2 a $x^2 - 4x + 4 = (x - 2)^2$

b $x^2 - 12x + 36 = (x - 6)^2$

c $-x^2 + 4x - 4 = -(x^2 - 4x + 4)$
 $= -(x - 2)^2$

d $2x^2 - 8x + 8 = 2(x^2 - 4x + 4)$
 $= 2(x - 2)^2$

e $-2x^2 + 12x - 18$
 $= -2(x^2 - 6x + 9)$
 $= -2(x - 3)^2$

f $x^2 - x + \frac{1}{4} = \left(x - \frac{1}{2}\right)^2$

g $x^2 - 3x + \frac{9}{4} = \left(x - \frac{3}{2}\right)^2$

h $x^2 + 5x + \frac{25}{4} = \left(x + \frac{5}{2}\right)^2$

3 a $x^2 - 2x - 1 = 0$

$\therefore x^2 - 2x + 1 - 2 = 0$

$\therefore (x - 1)^2 - 2 = 0$

$\therefore (x - 1)^2 = 2$

$\therefore x - 1 = \pm\sqrt{2}$

$\therefore x = 1 \pm \sqrt{2}$

b $x - 4x - 2 = 0$

$\therefore x^2 - 4x + 4 - 6 = 0$

$\therefore (x - 2)^2 - 6 = 0$

$\therefore (x - 2)^2 = 6$

$\therefore x - 2 = \pm\sqrt{6}$

$\therefore x = 2 \pm \sqrt{6}$

c $x^2 - 6x + 2 = 0$

$\therefore x^2 - 6x + 9 - 7 = 0$

$\therefore (x - 3)^2 - 7 = 0$

$\therefore (x - 3)^2 = 7$

$\therefore x - 3 = \pm\sqrt{7}$

$\therefore x = 3 \pm \sqrt{7}$

d $x^2 - 5x + 2 = 0$

$\therefore x^2 - 5x + \frac{25}{4} + 2 - \frac{25}{4} = 0$

$\therefore \left(x - \frac{5}{2}\right)^2 - \frac{17}{4} = 0$

$\therefore \left(x - \frac{5}{2}\right)^2 = \frac{17}{4}$

$\therefore x - \frac{5}{2} = \pm\frac{1}{2}\sqrt{17}$

$\therefore x = \frac{5 \pm \sqrt{17}}{2}$

e $2x^2 - 4x + 1 = 0$

$$\therefore 2\left(x^2 - 2x + \frac{1}{2}\right) = 0$$

$$\therefore x^2 - 2x + 1 - \frac{1}{2} = 0$$

$$\therefore (x-1)^2 = \frac{1}{2}$$

$$\therefore x-1 = \pm \frac{1}{\sqrt{2}}$$

$$\therefore x = \frac{2 \pm \sqrt{2}}{2}$$

f $3x^2 - 5x - 2 = 0$

$$\therefore 3\left(x^2 - \frac{5x}{3} - \frac{2}{3}\right) = 0$$

$$\therefore x^2 - \frac{5x}{3} - \frac{2}{3} = 0$$

$$\therefore x^2 - \frac{5x}{3} + \frac{25}{36} - \frac{2}{3} - \frac{25}{36} = 0$$

$$\therefore \left(x - \frac{5}{6}\right)^2 - \frac{49}{36} = 0$$

$$\therefore \left(x - \frac{5}{6}\right)^2 = \frac{49}{36}$$

$$\therefore x - \frac{5}{6} = \pm \frac{7}{6}$$

$$\therefore x = \frac{5}{6} \pm \frac{7}{6}$$

$$= 2, -\frac{1}{3}$$

g $x^2 + 2x + k = 0$

$$\therefore x^2 + 2x + 1 - (1 - k) = 0$$

$$\therefore (x+1)^2 - (1 - k) = 0$$

$$\therefore x+1 = \pm \sqrt{1 - k}$$

h $kx^2 + 2x + k = 0$

$$\therefore x^2 + \frac{2x}{k} + 1 = 0$$

$$\therefore x^2 + \frac{2x}{k} + \frac{1}{k^2} - \frac{1}{k^2 + 1} = 0$$

$$\therefore \left(x + \frac{1}{k}\right)^2 - \left(\frac{1}{k^2} - 1\right) = 0$$

$$\therefore \left(x + \frac{1}{k}\right)^2 = \frac{1 - k^2}{k^2}$$

$$\therefore x + \frac{1}{k} = \pm \frac{1}{k} \sqrt{1 - k^2}$$

$$\therefore x = \frac{-1 \pm \sqrt{1 - k^2}}{k}$$

i $x^2 - 3kx + 1 = 0$

$$\therefore x^2 - 3kx + \frac{9}{4}k^2 - \left(\frac{9}{4}k^2 - 1\right) = 0$$

$$\therefore \left(x - \frac{3k}{2}\right)^2 - \left(\frac{9}{4}k^2 - 1\right) = 0$$

$$\therefore \left(x - \frac{3k}{2}\right)^2 = \left(\frac{9}{4}k^2 - 1\right)$$

$$\therefore x - \frac{3k}{2} = \pm \sqrt{\frac{9}{4}k^2 - 1}$$

$$\therefore x = \frac{3k \pm \sqrt{9k^2 - 4}}{2}$$

4 a $x^2 - 2x + 3$

$$= x^2 - 2x + 1 + 2$$

$$= (x-1)^2 + 2$$

TP at (1, 2)

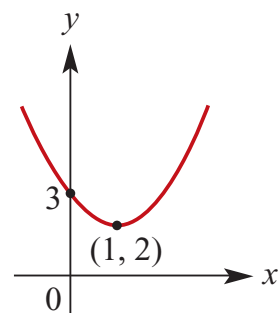

b $x^2 + 4x + 1$
 $= x^2 + 4x + 4 - 3$
 $= (x + 2)^2 - 3$
 TP at $(-2, -3)$

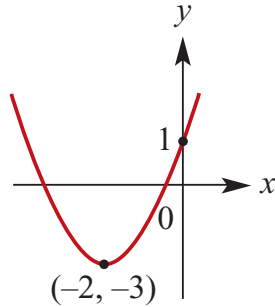

c $x^2 - 3x + 1$
 $= x^2 - 3x + \frac{9}{4} - \frac{5}{4}$
 $= \left(x - \frac{3}{2}\right)^2 - \frac{5}{4}$
 TP at $\left(\frac{3}{2}, -\frac{5}{4}\right)$

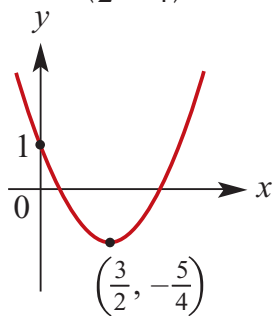

5 a $y = 2x^2 - 2x - 5$
 $= 2\left(x^2 - x - \frac{5}{2}\right)$
 $= 2\left(x^2 - x + \left(\frac{1}{2}\right)^2 - \left(\frac{1}{2}\right)^2 - \frac{5}{2}\right)$
 $= 2\left(\left(x - \frac{1}{2}\right)^2 - \left(\frac{1}{2}\right)^2 - \frac{5}{2}\right)$
 $= 2\left(\left(x - \frac{1}{2}\right)^2 - \frac{11}{4}\right)$
 $= 2\left(\left(x - \frac{1}{2}\right)^2\right) - \frac{11}{2}$
 TP at $\left(\frac{1}{2}, -\frac{11}{2}\right)$

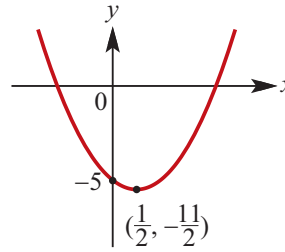

b $y = 4x^2 + 8x + 8$
 $= 4(x^2 + 2x + 2)$
 $= 4(x^2 + 2x + 1 - 1 + 2)$
 $= 4((x + 1)^2 + 1)$
 $= 4(x + 1)^2 + 4$
 TP at $(-1, 4)$

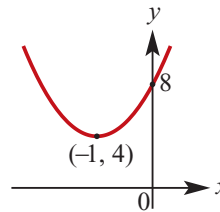

c $y = 3x^2 - 6x - 4$
 $= 3\left(x^2 - 2x - \frac{4}{3}\right)$
 $= 3\left(x^2 - 2x + 1 - 1 - \frac{4}{3}\right)$
 $= 3\left(\left(x - 1\right)^2 - \left(\sqrt{\frac{7}{3}}\right)^2\right)$
 $= 3(x - 1)^2 - 7$
 TP at $(1, -7)$

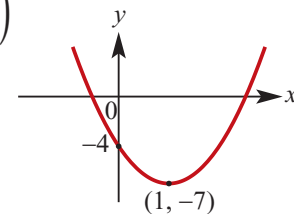

6 a $x^2 - 8x + 12$
 $= x^2 - 8x + 16 - 4$
 $= (x - 4)^2 - 4$

TP at (4, -4)

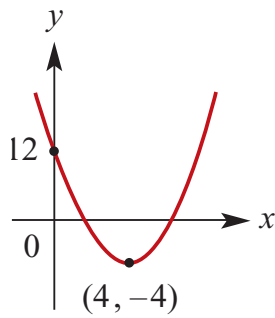

b $x^2 - x - 2$

$$= x^2 - x + \frac{1}{4} - \frac{9}{4}$$

$$= \left(x - \frac{1}{2}\right)^2 - \frac{9}{4}$$

TP at $\left(\frac{1}{2}, -\frac{9}{4}\right)$

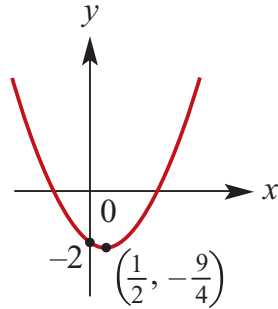

c $2x^2 + 4x - 2$

$$= 2(x^2 + 2x - 1)$$

$$= 2(x^2 + 2x + 1 - 2)$$

$$= 2(x + 1)^2 - 4$$

TP at (-1, -4)

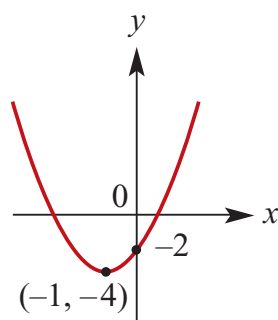

d $-x^2 + 4x + 1$

$$= -(x^2 - 4x - 1)$$

$$= -(x^2 - 4x + 4 - 5)$$

$$= -(x - 2)^2 + 5$$

TP at (2, 5)

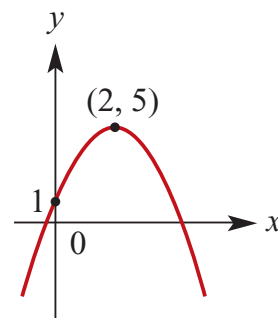

e $-2x^2 - 12x - 12$

$$= -2(x^2 + 6x + 6)$$

$$= -2(x^2 + 6x + 9 - 3)$$

$$= -2(x + 3)^2 + 6$$

TP at (-3, 6)

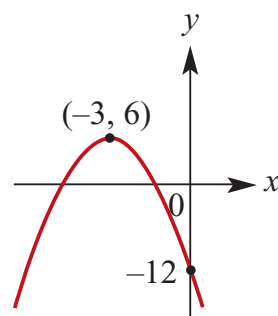

f $3x^2 - 6x + 12$

$$= 3(x^2 - 2x + 4)$$

$$= 3(x^2 - 2x + 1 + 3)$$

$$= 3(x - 1)^2 + 9$$

TP at (1, 9)

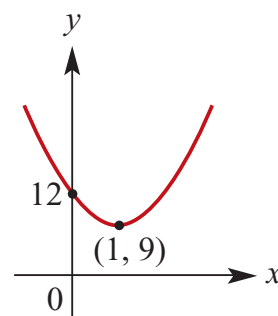

Solutions to Exercise 3F

1 a x -axis intercepts 4 and 10;

x -coordinate of vertex

$$= \frac{1}{2}(4 + 10) = 7$$

b x -axis intercepts 6 and 8;

$$x\text{-coordinate of vertex} = \frac{1}{2}(6 + 8) = 7$$

c x -axis intercepts -6 and 8 ;

x -coordinate of vertex

$$= \frac{1}{2}(-6 + 8) = 1$$

2 a x -axis intercepts a and 6 ;

$$x\text{-coordinate of vertex} = \frac{1}{2}(a + 6) = 2$$

$$\therefore a + 6 = 4, \therefore a = -2$$

b x -axis intercepts a and -4 ;

$$x\text{-coordinate of vertex} = \frac{1}{2}(a - 4) = 2$$

$$\therefore a - 4 = 4, \therefore a = 8$$

c x -axis intercepts a and 0 ;

$$x\text{-coordinate of vertex} = \frac{1}{2}(a + 0) = 2$$

$$\therefore a = 4$$

3 a $y = x^2 - 1$

x -intercepts: $y = x^2 - 1 = 0$

$$\therefore (x - 1)(x + 1) = 0$$

$$\therefore x = 1, -1$$

x -int: $(-1, 0)$ and $(1, 0)$

TP: No x term so $(0, -1)$

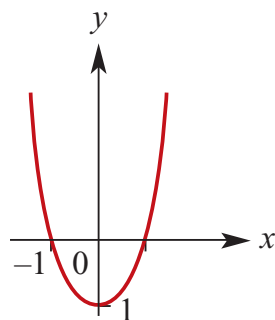

b $y = x^2 + 6x$

x -intercepts: $y = x^2 + 6x = 0$

$$\therefore x(x + 6) = 0$$

$$\therefore x = 0, -6$$

x -int: $(-6, 0)$ and $(0, 0)$

TP: $y = x^2 + 6x$

$$= x^2 + 6x + 9 - 9$$

$$= (x + 3)^2 - 9$$

TP at $(-3, -9)$

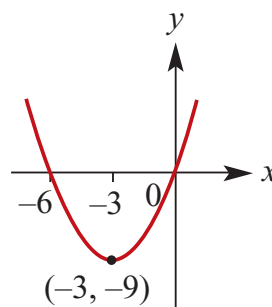

c $y = 25 - x^2$

x -intercepts: $y = 25 - x^2 = 0$

$$\therefore (5 - x)(5 + x) = 0$$

$$\therefore x = 5, -5$$

TP: No x term so $(0, 25)$

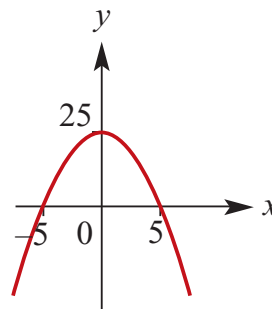

d $y = x^2 - 4$

x -intercepts: $y = x^2 - 4 = 0$

$$\therefore (x - 2)(x + 2) = 0$$

$$\therefore x = 2, -2$$

x -int: $(-2, 0)$ and $(2, 0)$

TP: No x term so $(0, -4)$

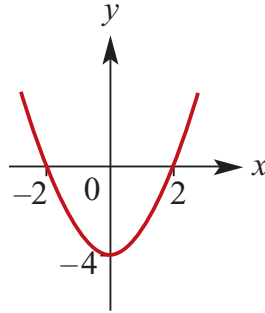

e $y = 2x^2 + 3x$
 x -intercepts: $y = 2x^2 + 3x = 0$
 $\therefore x(2x + 3) = 0$
 x -int: $(-\frac{3}{2}, 0)$ and $(0, 0)$
 TP: $y = 2x^2 + 3x$

$$= 2\left(x^2 + \frac{3}{2}x + \frac{9}{16} - \frac{9}{16}\right)$$

$$= 2\left(x + \frac{3}{4}\right)^2 - \frac{9}{8}$$

TP at $(-\frac{3}{4}, -\frac{9}{8})$

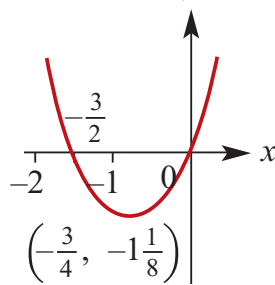

f $y = 2x^2 - 4x$
 x -intercepts: $y = 2x^2 - 4x = 0$
 $\therefore 2x(x - 2) = 0$
 x -int: $(2, 0)$ and $(0, 0)$
 TP: $y = 2x^2 - 4x$

$$= 2(x^2 - 2x + 1 - 1)$$

$$= 2(x - 1)^2 - 2$$

TP at $(1, -2)$

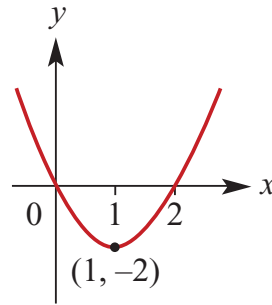

g $y = -2x^2 - 3x$
 x -intercepts: $y = -2x^2 - 3x = 0$
 $\therefore -x(2x + 3) = 0$
 x -int: $(-\frac{3}{2}, 0)$ and $(0, 0)$
 TP: $y = -2x^2 - 3x$

$$= -2\left(x^2 + \frac{3}{2}x + \frac{9}{16} - \frac{9}{16}\right)$$

$$= -2\left(x + \frac{3}{4}\right)^2 + \frac{9}{8}$$

$$= -2\left(x + \frac{3}{4}\right)^2 + \frac{9}{8}$$

TP at $(-\frac{3}{4}, \frac{9}{8})$

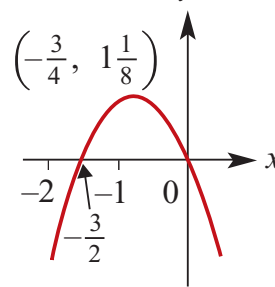

h $y = x^2 + 1$
 No x -intercepts since $y > 0$ for all x
 TP: No x term so $(0, 1)$

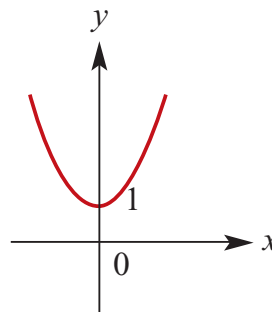

4 a $y = x^2 + 3x - 10$
 x -intercepts: $y = x^2 + 3x - 10 = 0$
 $\therefore (x + 5)(x - 2) = 0$
 x -int: $(-5, 0)$ and $(2, 0)$
 TP: $y = x^2 + 3x - 10$

$$y = x^2 + 3x + \frac{9}{4} - \frac{9}{4} - 10$$

$$y = \left(x + \frac{3}{2}\right)^2 - \frac{49}{4}$$

TP at $\left(-\frac{3}{2}, -\frac{49}{4}\right)$

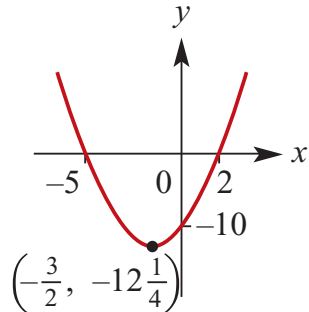

b $y = x^2 - 5x + 4$
 x -intercepts: $y = x^2 - 5x + 4 = 0$
 $\therefore (x - 1)(x - 4) = 0$
 x -int: $(1, 0)$ and $(4, 0)$
 TP: $y = x^2 - 5x + 4$

$$y = x^2 - 5x + \frac{25}{4} - \frac{25}{4} + 4$$

$$y = \left(x - \frac{5}{2}\right)^2 - \frac{9}{4}$$

TP at $\left(\frac{5}{2}, -\frac{9}{4}\right)$

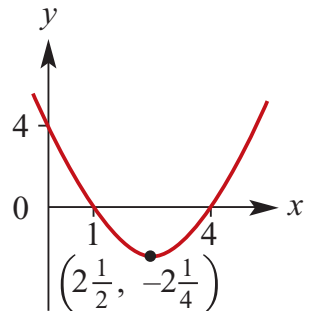

c $y = x^2 + 2x - 3$
 x -intercepts: $y = x^2 + 2x - 3$
 $\therefore (x - 1)(x + 3) = 0$

x -int: $(1, 0)$ and $(-3, 0)$
 TP: $y = x^2 + 2x - 3$
 $y = x^2 + 2x + 1 - 4$
 $y = (x + 1)^2 - 4$
 TP at $(-1, -4)$

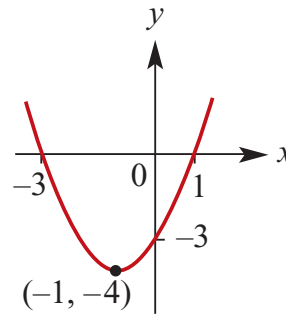

d $y = x^2 + 4x + 3$
 x -intercepts: $y = x^2 + 4x + 3 = 0$
 $\therefore (x + 1)(x + 3) = 0$
 x -int: $(-1, 0)$ and $(-3, 0)$
 TP: $y = x^2 + 4x + 3$

$$y = x^2 + 4x + 4 - 1$$

$$y = (x + 2)^2 - 1$$

TP at $(-2, -1)$

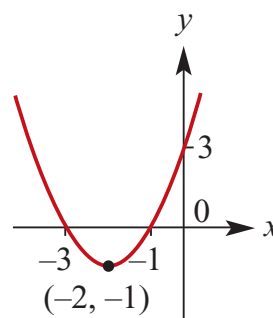

e $y = 2x^2 - x - 1$
 x -intercepts: $y = 2x^2 - x - 1 = 0$
 $\therefore (2x + 1)(x - 1) = 0$
 x -int: $\left(-\frac{1}{2}, 0\right)$ and $(1, 0)$

TP: $y = 2x^2 - x - 1$

$$y = 2\left(x^2 - \frac{x}{2} + \frac{1}{2}\right)$$

$$y = 2\left(x^2 - \frac{x}{2} + \frac{1}{16} - \frac{9}{16}\right)$$

$$y = 2\left(x - \frac{1}{4}\right)^2 - \frac{9}{8}$$

TP at $\left(\frac{1}{4}, -\frac{9}{8}\right)$

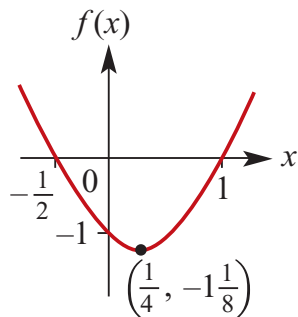

f $y = 6 - x - x^2$

x-intercepts: $y = -(x^2 + x - 6) = 0$

$\therefore -(x+3)(x-2) = 0$

x-int: $(-3, 0)$ and $(2, 0)$

TP: $y = -(x^2 + x - 6)$

$$y = -\left(x^2 + x + \frac{1}{4} - 6 - \frac{1}{4}\right)$$

$$y = -\left(x + \frac{1}{2}\right)^2 + \frac{25}{4}$$

TP at $\left(-\frac{1}{2}, \frac{25}{4}\right)$

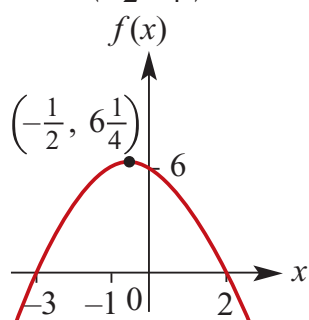

g $y = -x^2 - 5x - 6$

x-intercepts: $y = -(x^2 + 5x + 6) = 0$

$\therefore -(x+3)(x+2) = 0$

x-int: $(-3, 0)$ and $(-2, 0)$

TP: $y = -(x^2 + 5x + 6)$

$$y = -\left(x^2 + 5x + \frac{25}{4} + 6 - \frac{25}{4}\right)$$

$$y = -\left(x + \frac{5}{2}\right)^2 + \frac{1}{4}$$

TP at $\left(-\frac{5}{2}, \frac{1}{4}\right)$

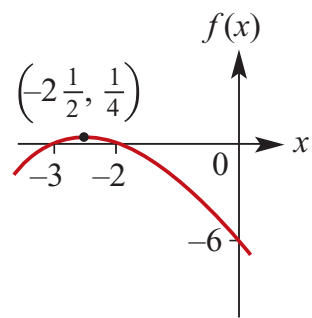

h $y = x^2 - 5x - 24$

x-intercepts: $y = x^2 - 5x - 24 = 0$

$\therefore (x+3)(x-8) = 0$

x-int: $(-3, 0)$ and $(8, 0)$

TP: $y = x^2 - 5x - 24$

$$y = x^2 - 5x + \frac{25}{4} - 24 - \frac{25}{4}$$

$$y = \left(x - \frac{5}{2}\right)^2 - \frac{121}{4}$$

TP at $\left(\frac{5}{2}, -\frac{121}{4}\right)$

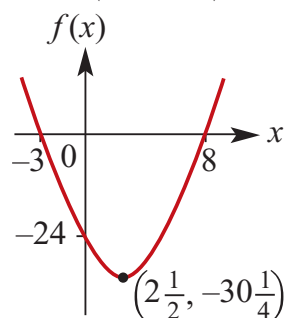

Solutions to Exercise 3G

1 a $x^2 + 2x - 8 = 0$

$\therefore (x + 2)(x - 4) = 0$

$\therefore x = -2, 4$

'Positive coefficient of x^2 ':

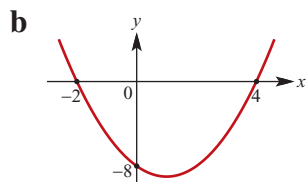

c $x^2 - 2x - 8 \leq 0 \Leftrightarrow -2 \leq x \leq 4$

d $x^2 - 2x - 8 > 0 \Leftrightarrow x > 4 \text{ or } x < -2$

2 a Positive coefficient of x^2

$x \leq -2 \text{ or } x \geq 3$

b Positive coefficient of x^2

$-4 < x < 3$

c Positive coefficient of x^2

$-4 \leq x \leq \frac{1}{2}$

d Positive coefficient of x^2

$x < 2 \text{ or } x > 6$

e Positive coefficient of x^2

$2 < x < 3$

f Negative coefficient of x^2

$\frac{3}{2} \leq x \leq \frac{7}{2}$

g Positive coefficient of x^2

$-\frac{7}{2} < x < 2$

h Positive coefficient of x^2

$-2 \leq x \leq \frac{5}{2}$

i Negative coefficient of x^2

$x < -5 \text{ or } x > \frac{5}{2}$

j Negative coefficient of x^2

$-2 \leq x \leq \frac{7}{2}$

k Negative coefficient of x^2

$x < \frac{2}{5} \text{ or } x > \frac{7}{2}$

l Positive coefficient of x^2

$x \leq \frac{5}{2} \text{ or } x \geq \frac{11}{2}$

3 a Negative coefficient of x^2

$x < -5 \text{ or } x > 5$

b Negative coefficient of y^2

$-\frac{2}{3} \leq y \leq \frac{2}{3}$

c Negative coefficient of y^2

$y > 4 \text{ or } y < -4$

d Negative coefficient of x^2

$-\frac{6}{5} \leq x \leq \frac{6}{5}$

e Negative coefficient of y^2

$y \leq -\frac{1}{4} \text{ or } y \geq \frac{1}{4}$

f Negative coefficient of y^2

$y < -\frac{5}{6} \text{ or } y > \frac{5}{6}$

4 a $x^2 + 2x - 8 = 0$

$\therefore (x + 4)(x - 2) = 0$

$\therefore x = 2, -4$

'Positive coefficient of x^2 ':

$x \leq -2 \text{ or } x \geq 4$

b $x^2 - 5x - 24 = 0$

$$\therefore (x+3)(x-8) = 0$$

$$\therefore x = -3, 8$$

'Positive coefficient of x^2 ':

$$\{x: -3 < x < 8\}$$

c $x - 4x - 12 = 0$

$$\therefore (x+2)(x-6) = 0$$

$$\therefore x = -2, 6$$

'Positive coefficient of x^2 ':

$$\{x: -2 \leq x \leq 6\}$$

d $2x^2 - 3x - 9 = 0$

$$\therefore (2x+3)(x-3) = 0$$

$$\therefore x = -\frac{3}{2}, 3$$

'Positive coefficient of x^2 ':

$$\{x: x < -\frac{3}{2}\} \cup \{x: x > 3\}$$

e $6x^2 + 13x < -6$

$$\therefore 6x^2 + 13x + 6 < 0$$

$$6x^2 + 13x + 6 = 0$$

$$\therefore (3x+2)(2x+3) = 0$$

$$x = -\frac{2}{3}, -\frac{3}{2}$$

'Positive coefficient of x^2 ':

$$\left\{x: -\frac{3}{2} < x < -\frac{2}{3}\right\}$$

f $-x^2 - 5x - 6 = 0$

$$\therefore -(x+2)(x+3) = 0$$

$$\therefore x = -2, -3$$

'Negative coefficient of x^2 ':

$$\{x: -3 \leq x \leq -2\}$$

g $12x^2 + x > 6$

$$\therefore 12x^2 + x - 6 > 0$$

$$12x^2 + x - 6 = 0$$

$$\therefore (4x+3)(3x-2) = 0$$

$$\therefore x = -\frac{3}{4}, \frac{2}{3}$$

'Positive coefficient of x^2 ':

$$\left\{x: x < -\frac{3}{4}\right\} \cup \left\{x: x > \frac{2}{3}\right\}$$

h $10x^2 - 11x \leq -3$

$$\therefore 10x^2 - 11x + 3 \leq 0$$

$$10x^2 - 11x + 3 = 0$$

$$\therefore (5x-3)(2x-1) = 0$$

$$\therefore x = \frac{1}{2}, \frac{3}{5}$$

'Positive coefficient of x^2 ':

$$\left\{x: \frac{1}{2} \leq x \leq \frac{3}{5}\right\}$$

i $x(x-1) \leq 20$

$$\therefore x^2 - x - 20 \leq 0$$

$$x^2 - x - 20 = 0$$

$$\therefore (x-5)(x+4) = 0$$

$$x = -4, 5$$

'Positive coefficient of x^2 ':

$$\{x: -4 \leq x \leq 5\}$$

j $4 + 5p - p^2 = 0$

$$\therefore p = \frac{-5 \pm \sqrt{41}}{-2}$$

'Negative coefficient of x^2 ':

$$\left\{p: \frac{5 - \sqrt{41}}{2} \leq p \leq \frac{5 + \sqrt{41}}{2}\right\}$$

k $3 + 2y - y^2 = 0$

$$\therefore (1+y)(3-y) = 0$$

$$\therefore y = -1, 3$$

'Negative coefficient of x^2 ':

$$\{y: y < -1\} \cup \{y: y > 3\}$$

l $x^2 + 3x \geq -2$

$$\therefore x^2 + 3x + 2 \geq 0$$

$$x^2 + 3x + 2 = 0$$

$$\therefore (x+2)(x+1) = 0$$

$$\therefore x = -2, -1$$

'Positive coefficient of x^2 ':

$$\{x: x \leq -2\} \cup \{x: x \geq -1\}$$

5 a

$$\begin{aligned}
x^2 + 3x - 5 &\geq 0 \\
\Leftrightarrow \left(x + \frac{3}{2}\right)^2 - \frac{29}{4} &\geq 0 \\
\Leftrightarrow \left(x + \frac{3}{2}\right)^2 &\geq \frac{29}{4} \\
\Leftrightarrow x \leq -\frac{3}{2} - \frac{\sqrt{29}}{2} \text{ or } x &\geq -\frac{3}{2} + \frac{\sqrt{29}}{2}
\end{aligned}$$

b $x^2 - 5x + 2 < 0$

$$\begin{aligned}
\Leftrightarrow 2\left(x - \frac{5}{2}\right)^2 - \frac{17}{4} &< 0 \\
\Leftrightarrow \left(x - \frac{5}{2}\right)^2 &< \frac{17}{4} \\
\Leftrightarrow \frac{5}{2} - \frac{\sqrt{17}}{2} < x < \frac{5}{2} + \frac{\sqrt{17}}{2}
\end{aligned}$$

c $2x^2 - 3x - 1 \leq 0$

$$\begin{aligned}
\Leftrightarrow 2\left(x - \frac{3}{4}\right)^2 - \frac{17}{8} &\leq 0 \\
\Leftrightarrow 2\left(x - \frac{3}{4}\right)^2 &\leq \frac{17}{8} \\
\Leftrightarrow \left(x - \frac{3}{4}\right)^2 &\leq \frac{17}{16} \\
\Leftrightarrow \frac{3}{4} - \frac{\sqrt{17}}{4} < x < \frac{3}{4} + \frac{\sqrt{17}}{4}
\end{aligned}$$

d $2x^2 - 3x - 1 \leq 0$

$$\begin{aligned}
\Leftrightarrow -\left(x + \frac{3}{2}\right)^2 + \frac{41}{4} &> 0 \\
\Leftrightarrow \left(x - \frac{3}{4}\right)^2 &< \frac{41}{4} \\
\Leftrightarrow \left(x - \frac{3}{4}\right)^2 &< \frac{41}{16} \\
\Leftrightarrow \frac{3}{4} - \frac{\sqrt{41}}{4} < x < \frac{3}{4} + \frac{\sqrt{41}}{4}
\end{aligned}$$

e $2x^2 + 7x + 1 \leq 0$

$$\begin{aligned}
\Leftrightarrow 2\left(x^2 + \frac{7}{2} + \frac{49}{16} - \frac{49}{16} + \frac{1}{2}\right) &< 0 \\
\Leftrightarrow 2\left(x + \frac{7}{4}\right)^2 - \frac{41}{16} &< 0 \\
\Leftrightarrow \left(x + \frac{7}{4}\right)^2 &< \frac{41}{16} \\
\Leftrightarrow \frac{-7 - \sqrt{41}}{4} < x < \frac{-7 + \sqrt{41}}{4}
\end{aligned}$$

f $2x^2 - 8x + 5 \geq 0$

$$\begin{aligned}
\Leftrightarrow 2\left(x^2 - 4 + 4 - 4 + \frac{5}{2}\right) &\geq 0 \\
\Leftrightarrow 2(x - 2)^2 - \frac{3}{2} &\geq 0 \\
\Leftrightarrow (x - 2)^2 &\geq \frac{3}{2} \\
\Leftrightarrow x \leq \frac{4 - \sqrt{6}}{2} \text{ or } x &\geq \frac{4 + \sqrt{6}}{2}
\end{aligned}$$

6 The square of any real number is zero or positive.

7 The negative of the square of any real number is zero or negative.

8 $x^2 + 2x + 7$

$$\begin{aligned}
&= x^2 + 2x + 1 - 1 + 7 \\
&= (x + 1)^2 + 6
\end{aligned}$$

Since $(x + 1)^2 \geq 0$ for all x
 $(x + 1)^2 + 6 \geq 6$ for all x

9 $-x^2 - 2x - 7$

$$\begin{aligned}
&= -(x^2 + 2x + 1 - 1 + 7) \\
&= -((x + 1)^2 - 6)
\end{aligned}$$

Since $-(x + 1)^2 \leq 0$ for all x
 $-(x + 1)^2 - 6 \leq -6$ for all x

Solutions to Exercise 3H

1 a $a = 2, b = 4$ and $c = -3$

i $b^2 - 4ac = 4^2 - 4(-3)2 = 40$

ii $\sqrt{b^2 - 4ac} = \sqrt{40} = 2\sqrt{10}$

b $a = 1, b = 10$ and $c = 18$

i $b^2 - 4ac = 10^2 - 4(18)1 = 28$

ii $\sqrt{b^2 - 4ac} = \sqrt{28} = 2\sqrt{7}$

c $a = 1, b = 10$ and $c = -18$

i $b^2 - 4ac = 10^2 - 4(-18)1 = 172$

ii $\sqrt{b^2 - 4ac} = \sqrt{172} = 2\sqrt{43}$

d $a = -1, b = 6$ and $c = 15$

i $b^2 - 4ac = 6^2 - 4(15)(-1) = 96$

ii $\sqrt{b^2 - 4ac} = \sqrt{96} = 4\sqrt{6}$

e $a = 1, b = 9$ and $c = -27$

i $b^2 - 4ac = 9^2 - 4(-27)1 = 189$

ii $\sqrt{b^2 - 4ac} = \sqrt{189} = 3\sqrt{21}$

2 a $\frac{2 + 2\sqrt{5}}{2} = 1 + \sqrt{5}$

b $\frac{9 - 3\sqrt{5}}{6} = \frac{3 - \sqrt{5}}{2}$

c $\frac{5 + 5\sqrt{5}}{10} = \frac{1 + \sqrt{5}}{2}$

d $\frac{6 + 12\sqrt{2}}{6} = 1 + 2\sqrt{2}$

3 a $x^2 + 6x = 4$

$\therefore x^2 + 6x - 4 = 0$

$\therefore x = \frac{-6 \pm \sqrt{6^2 - 4(-4)1}}{2}$

$\therefore x = \frac{-6 \pm \sqrt{52}}{2}$

$\therefore x = -3 \pm \sqrt{13}$

b $x^2 - 7x - 3 = 0$

$\therefore x = \frac{7 \pm \sqrt{7^2 - 4(-3)1}}{2}$

$\therefore x = \frac{7 \pm \sqrt{61}}{2}$

c $2x^2 - 5x + 2 = 0$

$\therefore x = \frac{5 \pm \sqrt{5^2 - 4(2)2}}{4}$

$\therefore x = \frac{5 \pm \sqrt{9}}{4}$

$\therefore x = \frac{5 \pm 3}{4} = \frac{1}{2}, 2$

d $2x^2 + 4x - 7 = 0$

$\therefore x = \frac{-4 \pm \sqrt{4^2 - 4(-7)2}}{4}$

$\therefore x = \frac{-4 \pm \sqrt{72}}{4}$

$\therefore x = -1 \pm \frac{6}{4}\sqrt{2}$

$\therefore x = -1 \pm \frac{3}{2}\sqrt{2}$

e $2x^2 + 8x = 1$

$$\therefore 2x^2 + 8x - 1 = 0$$

$$\therefore x = \frac{-8 \pm \sqrt{8^2 - 4(-1)2}}{4}$$

$$\therefore x = -2 \pm \frac{\sqrt{72}}{4}$$

$$\therefore x = -2 \pm \frac{3}{2}\sqrt{2}$$

f $5x^2 - 10x = 1$

$$\therefore 5x^2 - 10x - 1 = 0$$

$$\therefore x = \frac{10 \pm \sqrt{10^2 - 4(-1)5}}{10}$$

$$\therefore x = 1 \pm \frac{\sqrt{120}}{10}$$

$$\therefore x = 1 \pm \frac{\sqrt{30}}{5}$$

g $-2x^2 + 4x - 1 = 0$

$$\therefore x = \frac{-4 \pm \sqrt{4^2 - 4(-1)(-2)}}{-4}$$

$$\therefore x = 1 \pm \frac{\sqrt{8}}{4}$$

$$\therefore x = 1 \pm \frac{\sqrt{2}}{2}$$

h $2x^2 + x = 3$

$$\therefore 2x^2 + x - 3 = 0$$

$$\therefore x = \frac{-1 \pm \sqrt{1^2 - 4(-3)2}}{4}$$

$$\therefore x = \frac{-1 \pm \sqrt{25}}{4}$$

$$\therefore x = \frac{-1 \pm 5}{4} \therefore x = 1, -\frac{3}{2}$$

i $2.5x^2 + 3x + 0.3 = 0$

$$\therefore x = \frac{-3 \pm \sqrt{3^2 - 4(0.3)2.5}}{5}$$

$$\therefore x = \frac{-3 \pm \sqrt{6}}{5}$$

j $-0.6x^2 - 1.3x = 0.1$

$$\therefore -6x^2 - 13x - 1 = 0$$

$$\therefore 6x^2 + 13x + 1 = 0$$

$$\therefore x = \frac{-13 \pm \sqrt{13^2 - 4(1)6}}{12}$$

$$\therefore x = \frac{-13 \pm \sqrt{145}}{12}$$

k $2kx^2 - 4x + k = 0$

$$\therefore x = \frac{4 \pm \sqrt{4^2 - 4(2k)k}}{4k}$$

$$\therefore x = 1 \pm \frac{\sqrt{16 - 8k^2}}{4k}$$

$$\therefore x = \frac{2 \pm \sqrt{4 - 2k^2}}{2k}$$

l $2(1 - k)x^2 - 4kx + k = 0$

$$\therefore x = \frac{4k \pm \sqrt{16k^2 - 8k(1 - k)}}{4(1 - k)}$$

$$\therefore x = \frac{4k \pm \sqrt{24k^2 - 8k}}{4(1 - k)}$$

$$\therefore x = \frac{2k \pm \sqrt{6k^2 - 2k}}{2(1 - k)}$$

4 a $y = x^2 + 5x - 1$

x -axis intercepts:

$$x = \frac{-5 \pm \sqrt{29}}{2}$$

$$x = -\frac{5}{2};$$

$$y = \frac{25}{4} - \frac{25}{2} - 1 = -\frac{29}{4}$$

TP at $(-2.5, -7.25)$

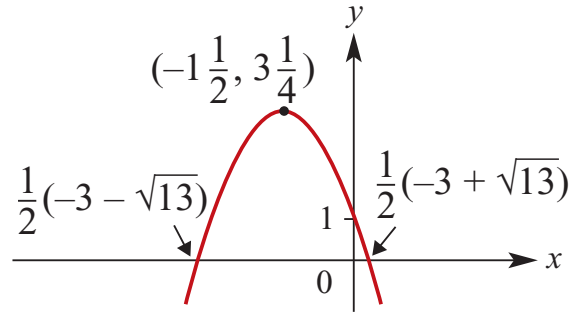
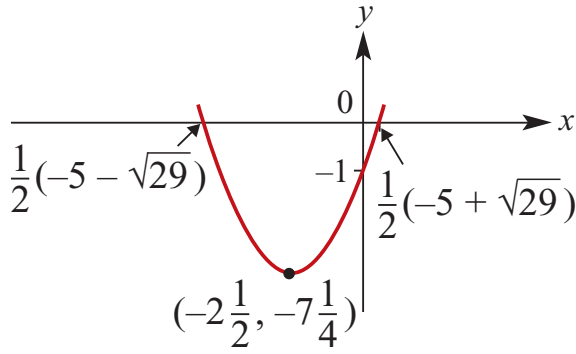

b $y = 2x^2 - 3x - 1$

x-axis intercepts:

$$\therefore x = \frac{3 \pm \sqrt{17}}{4}$$

$$x = \frac{3}{4};$$

$$y = \frac{9}{8} - \frac{9}{4} - 1 = -\frac{17}{8}$$

TP at $(0.75, -2.125)$

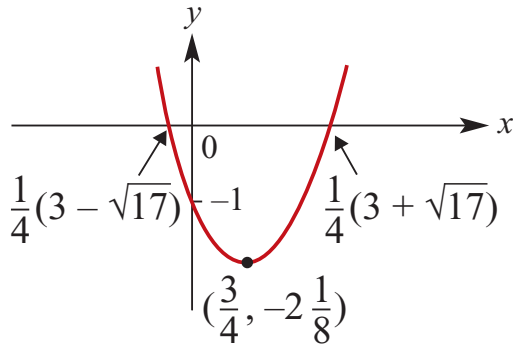

c $y = -x^2 - 3x + 1$

x-axis intercepts:

$$\therefore x = \frac{3 \pm \sqrt{13}}{-2}$$

$$\therefore x = \frac{-3 \pm \sqrt{13}}{2}$$

$$x = -\frac{3}{2};$$

$$y = -\frac{9}{4} + \frac{9}{2} + 1 = \frac{13}{4}$$

TP at $(-1.5, 3.25)$

d $y + 4 = x^2 + 2x$

$$\therefore y = x^2 + 2x - 4$$

x-axis intercepts:

$$\therefore x = \frac{-2 \pm \sqrt{20}}{2}$$

$$\therefore x = -1 \pm \sqrt{5}$$

$$x = -1;$$

$$y = 1 - 2 - 4 = -5$$

TP at $(-1, -5)$

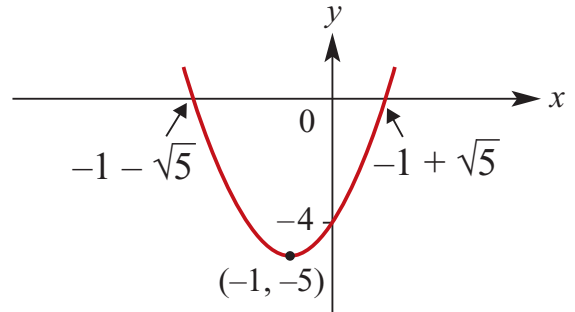

e $y = 4x^2 + 5x + 1$

x-axis intercepts:

$$\therefore x = \frac{-5 \pm \sqrt{25 - 16}}{8}$$

$$\therefore x = \frac{-5 \pm 3}{8}$$

$$\therefore x = -1, -\frac{1}{4}$$

$$x = -\frac{5}{8};$$

$$y = \frac{100}{64} - \frac{25}{8} + 1 = -\frac{9}{16}$$

TP at $(-0.625, -0.5625)$

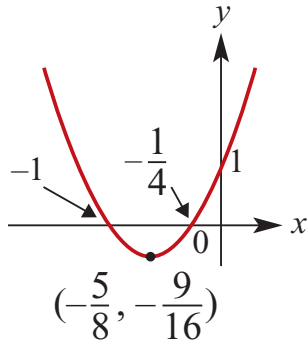

f $y = -3x^2 + 4x - 2$
 x -axis intercepts:
 $\therefore x = \frac{-4 \pm \sqrt{16 - 24}}{-6}$
 This is not defined, so no
 x -intercepts.

$$x = \frac{2}{3};$$

$$y = -\frac{4}{3} + \frac{8}{3} - 2 = -\frac{2}{3}$$

TP at $(\frac{2}{3}, -\frac{2}{3})$

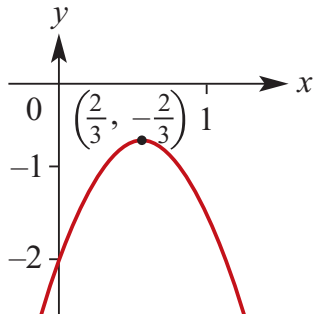

g $y = -x^2 + 5x + 6$ When $y = 0$

$$-x^2 + 5x + 6 = 0$$

$$x^2 - 5x - 6 = 0$$

$$(x - 6)(x + 1) = 0$$

$$x = 6 \text{ or } x = -1$$

When $x = 0, y = 6$

Axis of symmetry: $x = \frac{5}{2}$

Coordinates of turning point $(\frac{5}{2}, \frac{49}{4})$

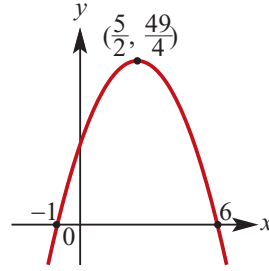

h $y = 4x^2 - 3x + 2$
 $\Delta = 9 - 4 \times 4 \times 2 < 0$

Therefore no x -axis intercepts. Axis
 of symmetry: $x = \frac{3}{8}$

Coordinates of turning point $(\frac{3}{8}, \frac{23}{16})$

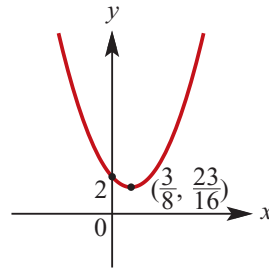

i $y = 3x^2 - x - 4$

When $y = 0,$

$$x = \frac{1 \pm \sqrt{1 - 4 \times 3 \times (-4)}}{6}$$

$$\text{That is } x = \frac{1 \pm 7}{6}$$

$$x = -1 \text{ or } x = \frac{4}{3}$$

Axis of symmetry: $x = \frac{1}{6}$

Coordinates of turning point

$$(\frac{1}{6}, -\frac{49}{12})$$

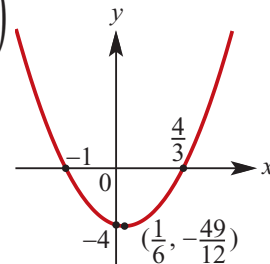

Solutions to Exercise 3I

- 1 a** $x^2 + 2x - 4$;
 $\Delta = 2^2 - 4(-4) = 20$
- b** $x^2 + 2x + 4$;
 $\Delta = 2^2 - 4(4) = -12$
- c** $x^2 + 3x - 4$;
 $\Delta = 3^2 - 4(-4) = 25$
- d** $2x^2 + 3x - 4$;
 $\Delta = 3^2 - 8(-4) = 41$
- e** $-2x^2 + 3x + 4$;
 $\Delta = 3^2 - 4(-2)(4) = 41$
- 2 a** $x^2 - 5x + 2$;
 $\Delta = 5^2 - 4(2) = 17$
 $\Delta > 0$ so graph crosses the x -axis
- b** $-4x^2 + 2x - 1$;
 $\Delta = 2^2 - 4(-4)(-1) = -12$
 $\Delta < 0$ so graph does not cross the x -axis
- c** $x^2 - 6x + 9$;
 $\Delta = 6^2 - 4(9) = 10$
 $\Delta = 0$ so graph touches the x -axis
- d** $-2x^2 - 3x + 8$;
 $\Delta = 3^2 - 4(-2)8 = 73$
 $\Delta > 0$ so graph crosses the x -axis
- e** $3x^2 + 2x + 5$;
 $\Delta = 2^2 - 4(5)(3) = -56$
 $\Delta < 0$ so graph does not cross the x -axis
- f** $-x^2 - x - 1$;
 $\Delta = 1^2 - 4(-1)(-1) = -3$
- $\Delta < 0$ so graph does not cross the x axis
- 3 a** $x^2 + 8x + 7$;
 $\Delta = 8^2 - 4(7) = 36$
 $\Delta > 0$ so the equation has 2 real roots
- b** $3x^2 + 8x + 7$;
 $\Delta = 8^2 - 4(7)(3) = -20$
 $\Delta < 0$ so no real roots
- c** $10x^2 - x - 3$;
 $\Delta = 1^2 - 4(-3)(10) = 121$
 $\Delta > 0$ so the equation has 2 real roots
- d** $2x^2 + 8x - 7$;
 $\Delta = 8^2 - 4(-7)2 = 120$
 $\Delta > 0$ so the equation has 2 real roots
- e** $3x^2 - 8x - 7$;
 $\Delta = 8^2 - 4(-7)3 = 148$
 $\Delta > 0$ so the equation has 2 real roots
- f** $10x^2 - x + 3$;
 $\Delta = 1^2 - 4(10)(3) = -119$
 $\Delta < 0$ so the equation has no real roots
- 4 a** $9x^2 - 24x + 16$;
 $\Delta = 24^2 - 4(9)(16) = 0$
 $\Delta = 0$ so the equation has 1 rational root
- b** $-x^2 - 5x - 6$;
 $\Delta = 5^2 - 4(-6)(-1) = 1$
 $\Delta > 0$ so the equation has 2 rational roots.
- c** $x^2 - x - 4$;

$\Delta = 1^2 - 4(-4) = 17$
 $\Delta > 0$ so the equation has 2 irrational roots, and is not a perfect square

d $25x^2 - 20x + 4;$

$\Delta = 20^2 - 4(25)(4) = 0$
 $\Delta = 0$ so the equation has 1 rational root and is a perfect square.

e $6x^2 - 3x - 2;$

$\Delta = 3^2 - 4(6)(-2) = 57$
 $\Delta > 0$ so the equation has 2 irrational roots and is not a perfect square

f $x^2 + 3x + 2;$

$\Delta = 3^2 - 4(2) = 1$
 $\Delta > 0$ so the equation has 2 rational roots and is not a perfect square

5 a $x^2 - 4mx + 20 = 0$

$\Delta = 16m^2 - 80 = 16(m^2 - 5)$

i If $(m^2 - 5) < 0$, no real solutions:
 $\{m: -\sqrt{5} < m < \sqrt{5}\}$

ii If $(m^2 - 5) = 0$, one real solution:
 $\{m: m = \pm\sqrt{5}\}$

iii If $(m^2 - 5) > 0$, 2 distinct solutions:
 $\{m: m < -\sqrt{5}\} \cup \{m: m > \sqrt{5}\}$

b $mx^2 - 3mx + 3 = 0$

$\Delta = 9m^2 - 12m = 3m(3m - 4)$

i If $\Delta < 0$, no real solutions:
 $\Delta = 0$ at $m = 0, \frac{4}{3}$
 Upright parabola, so
 $\{m: 0 < m < \frac{4}{3}\}$

ii If $\Delta = 0$, one real solution;

$m = 0, \frac{4}{3}$ satisfies this, but there is no solution to the equation if $m = 0$, so $\{m: m = \frac{4}{3}\}$

iii If $(3m^2 - 4) > 0$, 2 distinct solutions:
 $\{m: m < 0\} \cup \{m: m > \frac{4}{3}\}$

c $5x^2 - 5mx - m = 0$

$\Delta = 25m^2 + 20m = 5m(5m + 4)$

i If $5m(5m + 4) < 0$, no real solutions

$\Delta = 0$ at $m = 0, -\frac{4}{5}$
 Quadratic in m is upright:
 $\{m: -\frac{4}{5} < m < 0\}$

ii If $5m(5m + 4) = 0$, one real solution:
 $\{m: m = 0, -\frac{4}{5}\}$

iii If $5m(5m + 4) > 0$, 2 distinct solutions:
 $\{m: m < -\frac{4}{5}\} \cup \{m: m > 0\}$

d $x^2 + 4mx - 4(m - 2) = 0$

$\Delta = 16m + 16(m - 2)$

$= 16(m^2 + m - 2)$

i If $m^2 + m - 2 < 0$, no real solutions:
 $m^2 + m - 2 = (m + 2)(m - 1)$
 Quadratic in m is upright, so
 $\{m: -2 < m < 1\}$

ii If $m^2 + m - 2 = 0$, one real solution:
 $\{m: m = -2, 1\}$

iii If $m^2 + m - 2 > 0$, 2 distinct

solutions:

$$\{m: m < -2\} \cup \{m: m > 1\}$$

6 $mx^2 + (2m + n)x + 2n = 0$

$$\begin{aligned}\Delta &= (2m + n)^2 - 8mn \\ &= 4m^2 + 4mn + n^2 - 8mn \\ &= 4m^2 - 4mn + n^2 \\ &= (2m - n)^2\end{aligned}$$

This is a perfect square for all rational m and n , so the solution is rational also.

7 $px^2 + 2(p + 2)x + p + 7 = 0$

$$\begin{aligned}\Delta &= 4(p + 2)^2 - 4p(p + 7) \\ &= 4p^2 + 16p + 16 - 4p^2 - 28p \\ &= 16 - 12p = 4(4 - 3p)\end{aligned}$$

This equation has no real solution if $\Delta < 0$, i.e. if $p > \frac{4}{3}$

8 $(1 - 2p)x^2 + 8px - (2 + 8p) = 0$

$$\begin{aligned}\Delta &= 64p^2 + 4(1 - 2p)(2 + 8p) \\ &= 64p^2 - 8(2p - 1)(4p + 1) \\ &= 64p^2 - 8(8p^2 - 2p - 1) \\ &= 8(2p + 1)\end{aligned}$$

This equation has one real solution if $\Delta = 0$;

$$2p + 1 = 0 \text{ or } p = -\frac{1}{2}$$

9 a $px^2 - 6x + 9 = 0$

$$\begin{aligned}\Delta &= 36 - 4p^2 \\ \text{One solution} &\Leftrightarrow \Delta = 0 \\ 36 - 4p^2 &= 0\end{aligned}$$

$$36 = 4p^2$$

$$9 = p^2$$

$$p = \pm 3$$

b $2x^2 - 4x + 3 - p = 0$

$$\Delta = 16 - 4 \times 2(3 - p)$$

Two solution $\Leftrightarrow \Delta > 0$

$$16 - 4 \times 2(3 - p) > 0$$

$$8p - 8 > 0$$

$$p > 1$$

c $3x^2 - 2x - p + 1 = 0$

$$\Delta = 4 - 4 \times 3(1 - p)$$

Two solution $\Leftrightarrow \Delta > 0$

$$12p - 8 > 0$$

$$p > \frac{2}{3}$$

d $x^2 - 2x + 2 - p = 0$

$$\Delta = 4 - 4 \times (2 - p)$$

Two solution $\Leftrightarrow \Delta > 0$

$$4p - 4 > 0$$

$$p > 1$$

10 $y = px^2 + 8x + p - 6$

$$\Delta = 64 - 4p(p - 6)$$

$$= 4(-p + 6p + 16)$$

If the graph crosses the x -axis, $\Delta > 0$:

$$\Delta = 0 \text{ when } p = \frac{-6 \pm \sqrt{100}}{-2}$$

$$\therefore p = 3 \pm 5 = -2, 8$$

Inverted quadratic, so $\Delta > 0$ when:

$$\{p: -2 < p < 8\}$$

11 $(p^2 + 1)x^2 + 2pqx + q^2 = 0$

$$\Delta = 4p^2q^2 - 4q^2(p^2 + 1)$$

$$= 4q^2(p^2 - p^2 - 1)$$

$$= -4q^2$$

This is negative for all values of p , and for all non-zero q , so there are no real solutions.

12 a For $x^2 + 4mx + 24m - 44$
 $\Delta = (4m)^2 - 4(24m - 44)$
 $= 16m^2 - 96m + 176$

b $4mx^2 + 4(m - 1)x + m - 2 = 0$ has a solution for all values of m if and only if $\Delta \geq 0$ for all m .

$$16m^2 - 96m + 176$$

$$= 16(m^2 - 6m + 11)$$

$$= 16(m^2 - 6m + 9 + 2)$$

$$= 16(m - 3)^2 + 32 \geq 0 \quad \text{for all } m$$

13 $4mx^2 + 4(m - 1)x + m - 2$

a $\Delta = 16(m - 1)^2 - 4(4m)(m - 2)$
 $= 16m^2 - 32m + 16 - 16m^2 + 32m$
 $= 16$

b Δ is a perfect square and thus the solutions are rational for all m .

14 $4x^2 + (m - 4)x - m = 0$

$$\Delta = (m - 4)^2 - 4(4)(-m)$$

$$= m^2 - 8m + 16 + 16m$$

$$= m^2 + 8m + 16$$

$$= (m + 4)^2$$

$\therefore \Delta$ is a perfect square for all m

15 $x^2 - (m + 2n)x + 2mn = 0$
 $\Delta = (m + 2n)^2 - 4 \times 2mn$
 $= m^2 + 4mn + 4n^2 - 8mn$
 $= m^2 - 4mn + 4n^2$
 $= (m - 2n)^2$

Therefore Δ is a perfect square. The roots of the equation are rational.

16 $\Delta = b^2 - 4(a)(-c) = b^2 + 4ac > 0 \therefore$ the graph of $y = x^2 + bx - c$ where a and c are positive always intersects with the x -axis.

17 $\Delta = b^2 - 4(a)(c) = b^2 - 4ac > 0$ if \therefore the graph of $y = x^2 + bx + c$ where a is negative and c is positive always intersects with the x -axis.

Solutions to Exercise 3J

1 a $y = x - 2 \dots (1)$

$$y = x^2 - x - 6 \dots (2)$$

$$\therefore x^2 - x - 6 = x - 2$$

$$x^2 - 2x - 4 = 0$$

$$\therefore x = \frac{2 \pm \sqrt{20}}{2}$$

$$= \frac{2 \pm 2\sqrt{5}}{2}$$

$$= 1 \pm \sqrt{5}$$

Therefore points of intersection are

$$(1 - \sqrt{5}, -1 - \sqrt{5}) \text{ and}$$

$$(1 + \sqrt{5}, -1 + \sqrt{5})$$

b $x + y = 6 \dots (1)$

$$y = x^2 \dots (2)$$

From (1), $y = 6 - x$

$$\therefore x^2 = 6 - x$$

$$x^2 + x - 6 = 0$$

$$(x + 3)(x - 2) = 0$$

$$\therefore x = 2 \text{ or } x = -3$$

Therefore points of intersection are

$$(2, 4) \text{ and } (-3, 9)$$

c $5x + 4y = 21 \dots (1)$

$$y = x^2 \dots (2)$$

Substitute from (2) in (1),

$$5x + 4x^2 = 21$$

$$4x^2 + 5x - 21 = 0$$

$$(4x - 7)(x + 3) = 0$$

$$\therefore x = \frac{7}{4} \text{ or } x = -3$$

Therefore points of intersection are

$$(-3, 9) \text{ and } \left(\frac{7}{4}, \frac{49}{16}\right)$$

d

$$y = 2x + 1 \dots (1)$$

$$y = x^2 - x + 3 \dots (2)$$

Substitute from (1) in (2),

$$x^2 - x + 3 = 2x + 1$$

$$x^2 - 3x + 2 = 0$$

$$(x - 2)(x - 1) = 0$$

$$\therefore x = 2 \text{ or } x = 1$$

Therefore points of intersection are

$$(2, 5) \text{ and } (1, 3)$$

2 a $y = x^2 + 2x - 8$ and $y = 2 - x$ meet

where $x^2 + 2x - 8 = 2 - x$

$$\therefore x^2 + 3x - 10 = 0$$

$$\therefore (x + 5)(x - 2) = 0$$

$$\therefore x = -5, 2$$

When $x = -5$, $y = 2 - (-5) = 7$

When $x = 2$, $y = 2 - 2 = 0$

Curves meet at $(-5, 7)$ and $(2, 0)$.

b $y = x^2 - x - 3$ and $y = 4x - 7$ meet

where $x^2 - x - 3 = 4x - 7$

$$\therefore x^2 - 5x + 4 = 0$$

$$\therefore (x - 4)(x - 1) = 0$$

$$\therefore x = 4, 1$$

When $x = 1$, $y = 4 - 7 = -3$

When $x = 4$, $y = 16 - 7 = 9$

Curves meet at $(1, -3)$ and $(4, 9)$.

c $y = x^2 + x - 5$ and $y = -x - 2$ meet

where $x^2 + x - 5 = -x - 2$

$$\therefore x^2 + 2x - 3 = 0$$

$$\therefore (x + 3)(x - 1) = 0$$

$$\therefore x = -3, 1$$

When $x = -3$, $y = 3 - 2 = 1$

When $x = 1$, $y = -1 - 2 = -3$

Curves meet at $(-3, 1)$ and $(1, -3)$.

d $y = x^2 + 6x + 6$ and $y = 2x + 3$ meet where $x^2 + 6x + 6 = 2x + 3$
 $\therefore x^2 + 4x + 3 = 0$
 $\therefore (x + 3)(x + 1) = 0$
 $x = -3, -1$
When $x = -3, y = -6 + 3 = -3$
When $x = -1, y = -2 + 3 = 1$
Curves meet at $(-3, -3)$ and $(-1, 1)$.

e $y = -x^2 - x + 6$ and $y = -2x - 2$ meet where $-x^2 - x + 6 = -2x - 2$
 $\therefore -x^2 + x + 8 = 0$
 $\therefore x^2 - x - 8 = 0$
 $\therefore x = \frac{1 \pm \sqrt{1 - 4(8)}}{2}$
 $\therefore x = \frac{1 \pm \sqrt{33}}{2}$
When $x = \frac{1 - \sqrt{33}}{2}, y = -3 + \sqrt{33}$
When $x = \frac{1 + \sqrt{33}}{2}, y = -3 - \sqrt{33}$
Curves meet at $\left(\frac{1 - \sqrt{33}}{2}, -3 + \sqrt{33}\right)$ and $\left(\frac{1 + \sqrt{33}}{2}, -3 - \sqrt{33}\right)$.

f $y = x^2 + x + 6$ and $y = 6x + 8$ meet where $x^2 + x + 6 = 6x + 8$
 $\therefore x^2 - 5x - 2 = 0$
 $\therefore x = \frac{5 \pm \sqrt{25 - 4(-2)}}{2}$
 $\therefore x = \frac{5 \pm \sqrt{33}}{2}$
When $x = \frac{5 - \sqrt{33}}{2}, y = 23 - 3\sqrt{33}$
When $x = \frac{5 + \sqrt{33}}{2}, y = 23 + \sqrt{33}$
Curves meet at $\left(\frac{5 - \sqrt{33}}{2}, 23 - 3\sqrt{33}\right)$ and $\left(\frac{5 + \sqrt{33}}{2}, 23 + 3\sqrt{33}\right)$.

3 If the straight line meets the parabola only once, then the $y_1 = y_2$ quadratic

will produce a perfect square.

a $x - 6x + 8 = -2x + 4$
 $\therefore x^2 - 4x + 4 = 0$
 $\therefore (x - 2)^2 = 0, \therefore x = 2$
Touches at $(2, 0)$.

b $x^2 - 2x + 6 = 4x - 3$
 $\therefore x^2 - 6x + 9 = 0$
 $\therefore (x - 3)^2 = 0, \therefore x = 3$
Touches at $(3, 9)$.

c $2x^2 + 11x + 10 = 3x + 2$
 $\therefore 2x^2 + 8x + 8 = 0$
 $\therefore 2(x + 2)^2 = 0, \therefore x = -2$
Touches at $(-2, -4)$.

d $x^2 + 7x + 4 = -x - 12$
 $\therefore x^2 + 8x + 16 = 0$
 $\therefore (x + 4)^2 = 0, \therefore x = -4$
Touches at $(-4, -8)$.

4 a $y = x^2 - 6x; y = 8 + x$
 $\therefore x^2 - 6x = 8 + x$
 $x^2 - 7x - 9 = 0$
 $(x - 8)(x + 1) = 0$
 $\therefore x = 8, -1$
 $x = 8; y = 8 + 8 = 16$
 $x = -1; y = 8 + 1 = 7$

b $y = 3x^2 + 9x; y = 32 - x$
 $\therefore 3x^2 + 9x = 32 - x$
 $3x^2 + 10x - 32 = 0$
 $(3x + 16)(x - 2) = 0$
 $\therefore x = -\frac{16}{3}, 2$

$x = -\frac{16}{3}; y = 32 + \frac{16}{3} = \frac{112}{3}$
 $x = 2; y = 32 - 2 = 30$

c $y = 5x^2 + 9x; y = 12 - 2x$

$$\therefore 5x^2 + 9x = 12 - 2x$$

$$5x^2 + 11x - 12 = 0$$

$$(5x - 4)(x + 3) = 0$$

$$\therefore x = \frac{4}{5}, -3$$

$$x = \frac{4}{5}; y = 12 - \frac{8}{5} = \frac{52}{5}$$

$$x = -3; y = 12 - (-6) = 18$$

d $y = -3x^2 + 32x; y = 32 - 3x$

$$\therefore -3x^2 + 32x = 32 - 3x$$

$$-3x^2 + 35x - 32 = 0$$

$$3x^2 - 35x + 32 = 0$$

$$(x - 1)(3x - 32) = 0$$

$$x = 1, \frac{32}{3}$$

$$x = 1; y = 32 - 3 = 29$$

$$x = \frac{32}{3}; y = 32 - 32 = 0$$

e $y = 2x^2 - 12; y = 3(x - 4)$

$$\therefore 2x^2 - 12 = 3x - 12$$

$$2x^2 - 3x = 0$$

$$x(2x - 3) = 0$$

$$x = 0, \frac{3}{2}$$

$$x = 0; y = 3(-4) = -12$$

$$x = \frac{3}{2}; y = 3\left(\frac{3}{2} - 4\right) = -\frac{15}{2}$$

f $y = 11x^2; y = 21 - 6x$

$$\therefore 11x^2 + 6x - 21 = 0$$

$$\therefore x = \frac{-6 \pm \sqrt{6^2 - 4(-21)(11)}}{22}$$

$$= \frac{-3 \pm \sqrt{240}}{11} = -3 \pm \frac{4}{11} \sqrt{15}$$

$$x = \frac{-3 - 4\sqrt{15}}{11};$$

$$y = 21 + \frac{6}{11}(3 + 4\sqrt{15}) =$$

$$\frac{249 + 24\sqrt{15}}{11}$$

$$x = \frac{-3 + 4\sqrt{15}}{11};$$

$$y = 21 + \frac{6}{11}(3 - 4\sqrt{15}) =$$

$$\frac{249 - 24\sqrt{15}}{11}$$

Using a calculator: $x = 1.14, y = 14.19;$

$$x = -1.68, y = 31.09$$

5 a If $y = x + c$ is a tangent to the parabola

$$y = x^2 - x - 12, \text{ then}$$

$x^2 - x - 12 = x + c$ must reduce to a quadratic with zero discriminant.

$$x^2 - x - 12 = x + c$$

$$\therefore x^2 - 2x - (12 + c) = 0$$

$$\therefore \Delta = 4 + 4(12 + c)$$

$$= 4c + 52 = 0, \therefore c = -13$$

b i $y = -2x^2 - 6x + 2$

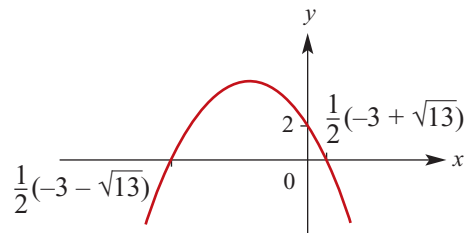

ii If $y = mx + 6$ is a tangent to the parabola,

$$-2x^2 - 6x + 2 = mx + 6$$

$$\therefore -2x^2 - (6 + m)x - 4 = 0$$

$$\therefore 2x^2 + (6 + m)x + 4 = 0$$

For a tangent, $\Delta = 0$:

$$\therefore \Delta = (6 + m)^2 - 4(4)(2) = 0$$

$$\therefore (6 + m)^2 = 32$$

$$\therefore 6 + m = \pm \sqrt{32} = \pm 4\sqrt{2}$$

$$m = -6 \pm 4\sqrt{2}$$

6 a $y = x^2 + 3x$ has as a tangent

$$y = 2x + c$$

$$\Delta = 0 \text{ for } x^2 + 3x = 2x + c$$

$$\therefore x^2 + x - c = 0$$

$$\therefore \Delta = 1 + 4c = 0, \therefore c = -\frac{1}{4}$$

b For two intersections, $\Delta > 0$ so
 $c > -\frac{1}{4}$

7 $y = x$ is a tangent to the parabola

$$y = x^2 + ax + 1$$

$$\therefore x^2 + ax + 1 = x$$

$$\therefore x^2 + (a - 1)x + 1 = 0$$

$$\Delta = (a - 1)^2 - 4 = 0$$

$$\therefore a - 1 = \pm 2$$

$$\therefore a = 1 \pm 2 = -1, 3$$

8 $y = -x$ is a tangent to the parabola

$$y = x^2 + x + b$$

$$\therefore x^2 + x + b = -x$$

$$\therefore x^2 + 2x + b = 0$$

$$\Delta = 4 - 4b = 0$$

$$\therefore b = 1$$

9 A straight line passing through the point

$$(1, -2) \text{ has the form } y - (-2) = m(x - 1)$$

$$\therefore y = m(x - 1) - 2$$

If this line is a tangent to $y = x^2$ then

$$x^2 = m(x - 1) - 2$$

$$\therefore x^2 - m(x - 1) + 2 = 0$$

$$\therefore x^2 - mx + m + 2 = 0$$

$\Delta = 0$ for a tangent here:

$$\Delta = m^2 - 4(m + 2)$$

$$= m^2 - 4m - 8 = 0$$

$$m^2 - 4m - 8 = 0$$

$$\therefore m = \frac{4 \pm \sqrt{16 + 32}}{2}$$

$$\therefore m = 2 \pm \sqrt{12} = 2 \pm 2\sqrt{3}$$

$$\therefore y = (2 \pm 2\sqrt{3})(x - 1) - 2$$

$$y = 2(1 + \sqrt{3})x - 4 - 2\sqrt{3} \text{ and}$$

$$y = 2(1 - \sqrt{3})x - 4 + 2\sqrt{3}$$

Solutions to Exercise 3K

1 $y = ax^2 + c$ passes through (0, 6) and (-1, 2).

$$\therefore a(0)^2 + c = 6, \therefore c = 6$$

$$a(-1)^2 + 6 = 2, \therefore a = -4$$

2 $y = ax^2 + bx + 4$

a $\Delta = b^2 - 16a$

b If the turning point lies on the x axis, $\Delta = 0$.

$$\therefore b^2 - 16a = 0$$

This implies, $a = \frac{b^2}{16}$.

c Turning point when $x = -\frac{b}{2a}$

Therefore,

$$-4 = -\frac{b}{2a} \dots (1)$$

$$a = \frac{b^2}{16} \dots (2)$$

Rearranging(1)

$$a = \frac{b}{8}$$

$$\therefore \frac{b}{8} = \frac{b^2}{16}$$

$$\therefore b = 2 \quad (\text{If } b = 0 \text{ then } a = 0)$$

$$\therefore a = \frac{1}{4}$$

3 a $y = k(x + 2)(x - 6)$

When $x = 1, y = -30$

$$-30 = k(3)(-5)$$

$$k = 2$$

$$\therefore y = 2(x + 2)(x - 6)$$

b $y = a(x - h)^2 + k$

Turning point (-2, 4)

$$\therefore y = a(x + 2)^2 + 4$$

Passes through (3, -46)

$$\therefore -46 = a(25) + 4$$

$$\therefore -50 = a(25)$$

$$\therefore a = -2$$

$$\therefore y = -2(x + 2)^2 + 4$$

c Passes through the points

(1, -2), (0, -3), (-1, -6)

Use $y = ax^2 + bx + c$

Passes through (0, -3),

$$\therefore c = -3$$

$$y = ax^2 + bx - 3$$

When $x = 1, y = -2$

$$\therefore -2 = a + b - 3$$

$$\therefore a + b = 1 \dots (1)$$

When $x = -1, y = -6$

$$\therefore -6 = a + b - 3$$

$$\therefore a - b = -3 \dots (2)$$

Add (1) and (2)

$$2a = -2$$

$$a = -1$$

$$\therefore b = 2$$

$$\therefore y = -x^2 + 2x - 3$$

4 $y = ax^2$ passes through (2, 8).

$$\therefore 8 = a(2)^2, \therefore a = 2$$

5 $y = ax^2 + bx$ passes through (6, 0) and (-1, 4).

$$\therefore a(6)^2 + 6b = 0$$

$$\therefore 36a + 6b = 0, \therefore b = -6a$$

$$a(-1)^2 - 6a(-1) = 4$$

$$\begin{aligned}\therefore 7a &= 4 \\ \therefore a &= \frac{4}{7}; b = -\frac{24}{7}\end{aligned}$$

6 $y = a(x - b)^2 + c$
The vertex is at (1,6) so $y = a(x - 1)^2 + 6$
 $y = a(x - 1)^2 + 6$ passes through (2,4)
 $\therefore a(2 - 1)^2 + 6 = 4$
 $\therefore a = -2; b = 1; c = 6$

7 a $y = a(x - b)^2 + c$
The vertex is at (0,5) so
 $y = (x - 0)^2 + 5$
 $y = ax^2 + 5$
 $y = ax^2 + 5$ passes through (0,4)
 $\therefore a(4)^2 + 5 = 0$
 $\therefore a = -\frac{5}{16}$
 $y = -\frac{5x^2}{16} + 5$

b $y = a(x - b)^2 + c$
The vertex is at (0,0) so $y = ax^2$
 $y = ax^2$ passes through (-3, 9)
 $\therefore a(-3)^2 = 9$
 $\therefore a = 1$
 $y = x^2$

c $y = ax^2 + bx + c$
This is of the form $y = ax(x + 7)$
For (4,4)
 $4 = a(4)(4 + 7)$
 $4 = 44a$
Therefore $a = \frac{1}{11}$

And the rule is $y = \frac{x^2}{11} + \frac{7x}{11}$

d $y = a(x + b)(x + c)$
From x -intercepts, a and b are -1 and -3:
 $y = a(x - 1)(x - 3)$
From y -intercept,

$$\begin{aligned}a(-1)(-3) &= 3, \therefore a = 1 \\ \therefore y &= (x - 1)(x - 3)\end{aligned}$$

e $y = a(x - b)^2 + c$
The vertex is at (-1, 5) so
 $y = a(x + 1)^2 + 5$
 $y = a(x + 1)^2 + 5$ passes through (1, 0)
 $\therefore a(2)^2 + 5 = 0$
 $\therefore a = -\frac{5}{4}$

$$y = -\frac{5}{4}(x + 1)^2 + 5$$

OR $y = -\frac{5}{4}x^2 - \frac{5}{2}x + \frac{15}{4}$

Check with 3rd pt: $y = 0$ at $x = -3$

f $y = a(x - b)^2 + c$
The vertex is at (2, 2) so
 $y = a(x + 2)^2 + 2$
 $y = a(x - 2)^2 + 2$ passes through (0,6)
 $\therefore a(-2)^2 + 2 = 6$
 $\therefore a = 1$

$$y = (x - 2)^2 + 2$$

OR $y = x^2 - 4x + 6$

Check with 3rd pt: $y = 6$ at $x = 4$

8 $y = a(x - b)^2 + c$
The vertex is at (-1, 3) so
 $y = a(x + 1)^2 + 3$
 $y = a(x + 1)^2 + 3$ passes through (3,8)
 $\therefore a(4)^2 + 3 = 8$
 $\therefore 16a = 5, \therefore a = \frac{5}{16}$
 $y = \frac{5}{16}(x + 1)^2 + 3$

9 $y = a(x + b)(x + c)$
From x intercepts, a and b are 6 and -3:
 $y = a(x - 6)(x + 3)$
Using (1, 10):
 $a(1 - 6)(1 + 3) = 10$
 $\therefore -20a = 10, \therefore a = -\frac{1}{2}$

$$\therefore y = -\frac{1}{2}(x-6)(x+3)$$

OR $y = -\frac{1}{2}(x^2 - 3x - 18)$

10 $y = a(x-b)^2 + c$

The vertex is at $(-1, 3)$ so

$$y = a(x+1)^2 + 3$$

$y = a(x+1)^2 + 3$ passes through $(0, 4)$

$$\therefore a + 3 = 4, \therefore a = 1$$

$$y = (x+1)^2 + 3$$

OR $y = x^2 + 2x + 4$

11 The suspension cable forms a parabola:

$$y = a(x-b)^2 + c$$

The vertex is at $(90, 30)$ so

$$y = a(x-90)^2 + 30$$

When $x = 0, y = 75$, so:

$$y = a(-90)^2 + 30 = 75$$

$$\therefore 8100a = 45, \therefore a = \frac{1}{180}$$

$$y = \frac{1}{180}(x-90)^2 + 30$$

$$\therefore y = \frac{1}{180}x^2 - x + 75$$

12 $y = 2(x-b)^2 + c$

$(1, -2) = \text{TP (vertex)} = (b, c)$

$$\therefore y = 2(x-1)^2 - 2$$

OR $y = 2x^2 - 4x$

13 $y = a(x-b)^2 + c$

$(1, -2) = \text{TP (vertex)} = (b, c)$

$$\therefore y = a(x-1)^2 - 2$$

Using the point $(3, 2)$,

$$a(3-1)^2 - 2 = 2$$

$$\therefore 4a - 2 = 2, \therefore a = 1$$

$$\therefore y = (x-1)^2 - 2$$

OR $y = x^2 - 2x - 1$

14 a $y = \frac{1}{3}(x+4)(8-x)$

Squared term is negative, so inverted parabola; must be **A** or **C**.

The x -intercepts must be at 8 and -4 , so **C**.

b $y = x^2 - x + 2$

Positive squared term gives an upright parabola; must be **B** or **D**.

The y -intercept is at $(0, 2)$ so only **B** is possible

c $y = -10 + 2(x-1)^2$

Positive squared term gives an upright parabola; must be **B** or **D**.

Vertex is at $(1, -10)$ so **D**.

d $y = \frac{1}{2}(9-x^2)$

Squared term is negative so inverted parabola; must be **A** or **C**.

Vertex at $(0, \frac{9}{2})$ so **A**.

15 a $ax^2 + 2x + a$

$$= a\left(x^2 + \frac{2}{a}x + 1\right)$$

$$= a\left(x^2 + \frac{2}{a}x + \frac{1}{a^2} - \frac{1}{a^2} + 1\right)$$

$$= a\left(\left(x + \frac{1}{a}\right)^2 - \frac{1}{a^2} + 1\right)$$

$$= a\left(x + \frac{1}{a}\right)^2 - \frac{1}{a} + a$$

b Turning point: $\left(-\frac{1}{a}, a - \frac{1}{a}\right)$

c Perfect square when $a - \frac{1}{a} = 0$

That is, when $a^2 = 1$

$$\therefore a = \pm 1$$

d Two solutions when $1 - a^2 > 0$, That is, $-1 < a < 1$

16 $y = a(x - b)^2 + c$
 $(2, 2) = \text{TP (vertex)} = (b, c)$
 $\therefore y = a(x - 2)^2 + 2$
Using the point $(4, -6)$,
 $a(4 - 2)^2 + 2 = -6$
 $\therefore 4a + 2 = -6 \therefore a = -2$
 $\therefore y = -2(x - 2)^2 + 2$
OR $y = -2x^2 + 8x - 6$

17 (a) has x -intercepts at 0 and 10, so
 $y = a(x - b)(x - c)$
 $b = 0, c = 10$
 $\therefore y = ax(x - 10)$
 $a > 0$ because upright parabola

(b) has x -intercepts at -4 and 10 , so
 $y = a(x - b)(x - c)$
 $b = -4, c = 10$
 $\therefore y = a(x + 4)(x - 10)$
 $a < 0$ because upright parabola

(c) has no x intercepts, so
 $y = a(x - b)^2 + c$
Vertex is at $(6, 6)$ so $b = c = 6$
 $y = a(x - 6)^2 + 6$
 y -intercept is at $(0, 8)$:
 $a(0 - 6)^2 + 6 = 8$
 $\therefore 36a = 2, \therefore a = \frac{1}{18}$
 $y = \frac{1}{18}(x - 6)^2 + 6$

(d) $y = a(x - b)^2 + c$
Vertex is at $(8, 0)$ so $b = 8; c = 0$
 $y = a(x - 8)^2$
 $a < 0$ because inverted parabola

18 (a) $y = ax^2 + x + b$
Using $D = (0, 2), b = 2$
Using $A = (2, 3)$,

$$4a + 2 + 2' = 3$$

$$\therefore a = -\frac{1}{4}$$

$$y = -\frac{1}{4}x^2 + x + 2$$

(b) $y = ax^2 + x + b$
Using $C = (0, -5), b = -5$
Using $B = (2, 1)$,

$$4a + 2 - 5 = 1$$

$$\therefore a = 1$$

$$y = x^2 + x - 5$$

19 $r = at^2 + bt + c$

(1) $t = 5, r = 3 : 25a + 5b + c = 3$
(2) $t = 9, r = 6 : 81a + 9b + c = 6$
(3) $t = 13, r = 5 : 169a + 13b + c = 5$
(2) - (1) gives $56a + 4b = 3$
(3) - (2) gives $88a + 4b = -1$

From these 2 equations, $32a = -4$
so $a = -\frac{1}{8}$

Substitute into $56a + 4b = 3$:

$$-\frac{56}{8} + 4b = 3$$

$$\therefore 4b = 10, \therefore b = \frac{5}{2}$$

Substitute into **(1)**:

$$-\frac{25}{8} + \frac{25}{2} + c = 3$$

$$\therefore c = -\frac{51}{8}$$

$$r = -\frac{1}{8}(t^2 - 20t + 51)$$

$$\therefore r = -\frac{1}{8}t^2 + \frac{5}{2}t - \frac{51}{8}$$

20 a $y = (x - 4)^2 - 3$
Upright parabola, vertex $(4, -3)$ so **B**

b $y = 3 - (x - 4)^2$
 Inverted parabola, vertex (4,3) so **D**

21 a $y = ax^2 + bx + c$
 $(-2, -1): 4a - 2b + c = -1 \dots (1)$
 $(1, 2): a + b + c = 2 \dots (2)$
 $(3, -16): 9a + 3b + c = -16 \dots (3)$
 $(2) - (1)$ gives $3b - 3a = 3$ or
 $b = a + 1$
 $(3) - (2)$ gives $8a + 2b = -18$ or
 $b = -9 - 4a$
 $b = a + 1 = -9 - 4a$
 $\therefore 5a = -10, \therefore a = -2; b = -1$
 Substitute into (1):
 $-8 + 2 + c = -1 \therefore c = 5$
 $y = -2x^2 - x + 5$

b $y = ax^2 + bx + c$
 $(-1, -2): a - b + c = -2 \dots (1)$

$(1, -4): a + b + c = -4 \dots (2)$
 $(3, 10): 9a + 3b + c = 10 \dots (3)$
 $(2) - (1)$ gives $2b = -2$ or $b = -1$
 $(3) - (2)$ gives $8a + 2b = 14$
 $\therefore 8a = 16 \therefore a = 2$

Substitute into (2):
 $2 - 1 + c = -4, \therefore c = -5$
 $y = 2x^2 - x - 5$

c $y = ax^2 + bx + c$
 $(-3, 5): 9a - 3b + c = 5 \dots (1)$
 $(3, 20): 9a + 3b + c = 20 \dots (2)$
 $(5, 57): 25a + 5b + c = 57 \dots (3)$
 $(2) - (1)$ gives $6b = 15$ or $b = \frac{5}{2}$
 $(3) - (2)$ gives $16a + 2b = 37$
 $\therefore 16a + 5 = 37, \therefore a = 2$

Substitute into (2):
 $18 + \frac{15}{2} + c = 20, \therefore c = -\frac{11}{2}$
 $y = 2x^2 + \frac{5}{2}x - \frac{11}{2}$

Solutions to Exercise 3L

- 1 a Width of paddock = x ;
length = $60 - 2x$
 $\therefore A = x(60 - 2x) = 60x - 2x^2$

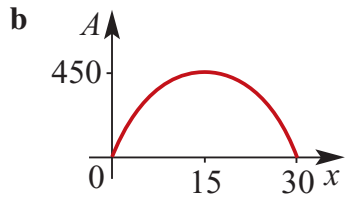

- c Maximum area is at the vertex,
i.e. when $x = 15$ (halfway between
the two x -intercepts).
When $x = 15$,
 $A = 15(60 - 30) = 450 \text{ m}^2$

2 $A = x(10 - x)$; Maximum area = 25 m^2

3 $E = 400(x - x^2)$

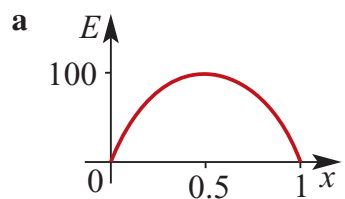

- b Zero efficiency rating when $x = 0$
and 1
- c Maximum efficiency rating is at the
vertex where $x = 0.5$
- d $E \geq 70$ when $400x - 400x^2 - 70 \geq 0$
i.e. $\{x: 0.23 < x < 0.77\}$
- 4 a If $x \text{ cm} =$ length of the rectangle, then
 $2x + 2w = 68$, $\therefore w = 34 - x$
 $A = lw = x(34 - x) = 34x - x^2$

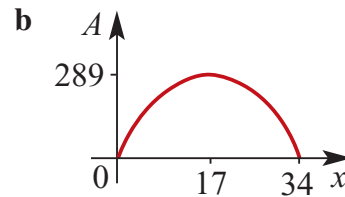

- c Maximum area formed is at the
vertex where $x = 17$:
 $A = 17(34 - 17) = 172 = 289 \text{ cm}^2$

5 a $4x + 10y = 80$

b i $A = 1.64x^2 - 25.6x + 256$

ii 31.22 and 48.78

6 $C = 240h + 100h^2$

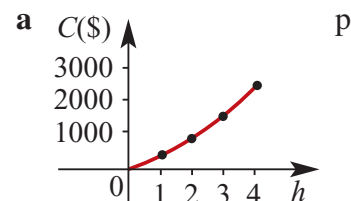

h is most unlikely to be less than zero
in an alpine area, and will be less
than 10, since the highest mountain
on Earth is less high than 10 km
above sea level.

- b C 's maximum value is at the top of
the highest peak in the mountains
(8.848 km for Mt Everest).

c For $h = 2.5 \text{ km}$,
 $C = 240(2.5) + 100(2.5)^2$
 $= 600 + 625 = \$1225$

7 $T = 290(8t - 0.5t^2 - 1.4)$

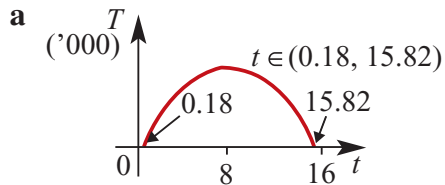

Solving $8t - 0.5t^2 - 1.4 = 0$ with a CAS gives $t = 0.18, 15.82$. So $t \in (0.18, 15.82)$

b At the vertex $t = 8, T = 8874$ units

8 a $d = 1 + \frac{3}{5}x - \frac{1}{50}x^2, x \geq 0$

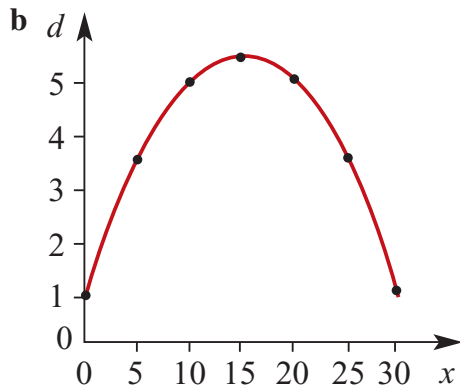

c i Maximum height = 5.5 m

ii When $y = 2, x = 15 \pm 5\sqrt{7}$
($x = 1.9$ m or 28.1 m)

iii y -intercept = 1, so it was struck 1 metre above the ground.

9 The x -intercepts are 0 and 1.5

So $y = ax(x - 1.5)$

A is the point (0.75, 0.6) so:

$$0.6 = a(0.75)(0.75 - 1.5)$$

$$\frac{3}{5} = -\frac{9}{16}a$$

$$\text{So } a = -\frac{16}{9}$$

$$y = -\frac{16}{9}x^2 + \frac{8}{3}x$$

$$a = -\frac{16}{9}, b = \frac{8}{3}, c = 0$$

10 a $s = at^2 + bt + c$

$$900a + 30b + c = 7.2 \dots (1)$$

$$22\,500a + 150b + c = 12.5 \dots (2)$$

$$90\,000a + 300b + c = 6 \dots (3)$$

$$(2) - (1) \text{ gives } 21600a + 120b = 5.3$$

$$(3) - (2) \text{ gives } 67500a + 150b = -6.5$$

Using a CAS, the solution is:

$$a = -\frac{7}{21\,600}; b = \frac{41}{400}; c = \frac{53}{12}$$

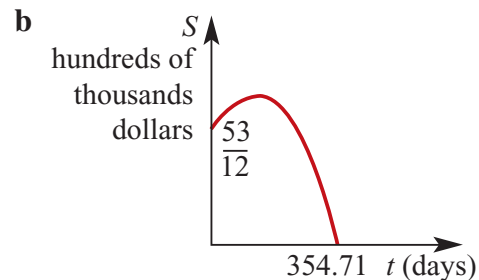

c i $t = 180, s = 12.36$, so spending is estimated at \$1 236 666.

ii $t = 350, s = 0.59259$, so spending is estimated at \$59259

Solutions to Technology-free questions

$$1 \text{ a } x^2 + 9x + \frac{81}{4} = \left(x + \frac{9}{2}\right)^2$$

$$\text{b } x^2 + 18x + 81 = (x + 9)^2$$

$$\text{c } x^2 - \frac{4}{5}x + \frac{4}{25} = \left(x - \frac{2}{5}\right)^2$$

$$\text{d } x^2 + 2bx + b^2 = (x + b)^2$$

$$\text{e } 9x^2 - 6x + 1 = (3x - 1)^2$$

$$\text{f } 25x^2 + 20x + 4 = (5x + 2)^2$$

$$2 \text{ a } -3(x - 2) = -3x + 6$$

$$\text{b } -a(x - a) = -ax + a^2$$

$$\text{c } (7a - b)(7a + b) = 49a^2 - b^2$$

$$\text{d } (x + 3)(x - 4) = x^2 + 3x - 4x - 12 \\ = x^2 - x - 12$$

$$\text{e } (2x + 3)(x - 4) = 2x^2 + 3x - 8x - 12 \\ = 2x^2 - 5x - 12$$

$$\text{f } (x + y)(x - y) = x^2 - y^2$$

$$\text{g } (a - b)(a^2 + ab + b^2) \\ = a^3 - a^2b + a^2b - ab^2 + ab^2 - b^3 \\ = a^3 - b^3$$

$$\text{h } (2x + 2y)(3x + y) = 6x^2 + 6xy + 2xy + 2y^2 \\ = 6x^2 + 8xy + 2y^2$$

$$\text{i } (3a + 1)(a - 2) = 3a^2 + a - 6a - 2 \\ = 3a^2 - 5a - 2$$

j

$$(x + y)^2 - (x - y)^2 \\ = ((x + y) - (x - y))((x + y) + (x - y)) \\ = (2y)(2x) = 4xy$$

$$\text{k } u(v + 2) + 2v(1 - u) \\ = uv + 2u + 2v - 2uv \\ = 2u + 2v - uv$$

$$\text{l } (3x + 2)(x - 4) + (4 - x)(6x - 1) \\ = (3x + 2)(x - 4) + (x - 4)(1 - 6x) \\ = (x - 4)(3x + 2 + 1 - 6x) \\ = (x - 4)(3 - 3x) \\ = -3x^2 + 15x - 12$$

$$3 \text{ a } 4x - 8 = 4(x - 2)$$

$$\text{b } 3x^2 + 8x = x(3x + 8)$$

$$\text{c } 24ax - 3x = 3x(8a - 1)$$

$$\text{d } 4 - x^2 = (2 - x)(2 + x)$$

$$\text{e } au + 2av + 3aw = a(u + 2v + 3w)$$

$$\text{f } 4a^2b^2 - 9a^4 = a^2(4b^2 - 9a^2) \\ = a^2(2b - 3a)(2b + 3a)$$

$$\text{g } 1 - 36x^2a^2 = (1 - 6ax)(1 + 6ax)$$

$$\text{h } x^2 + x - 12 = (x + 4)(x - 3)$$

$$\text{i } x^2 + x - 2 = (x + 2)(x - 1)$$

$$\text{j } 2x^2 + 3x - 2 = (2x - 1)(x + 2)$$

$$\text{k } 6x^2 + 7x + 2 = (3x + 2)(2x + 1)$$

$$\text{l } 3x^2 - 8x - 3 = (3x + 1)(x - 3)$$

m $3x^2 + x - 2 = (3x - 2)(x + 1)$

n $6a^2 - a - 2 = (3a - 2)(2a + 1)$

o $6x^2 - 7x + 2 = (3x - 2)(2x - 1)$

4 a $x^2 - 2x - 15 = 0$

$$(x - 5)(x + 3) = 0$$

$$x = 5 \text{ or } x = -3$$

b $x^2 - 9x = 0$

$$x(x - 9) = 0$$

$$x = 0 \text{ or } x = 9$$

c $2x^2 - 10x + 12 = 0$

$$2(x^2 - 5x + 6) = 0$$

$$(x - 3)(x - 2) = 0$$

$$x = 3 \text{ or } x = 2$$

d $x^2 - 24x - 25 = 0$

$$(x - 25)(x + 1) = 0$$

$$x = 25 \text{ or } x = -1$$

e $3x^2 + 15x + 18 = 0$

$$3(x^2 + 5x + 6) = 0$$

$$(x + 3)(x + 2) = 0$$

$$x = -3 \text{ or } x = -2$$

f $x^2 - 12x + 36 = 0$

$$(x - 6)(x - 6) = 0$$

$$x = 6$$

g $2x^2 - 5x - 3 = 0$

$$2x^2 - 6x + x - 3 = 0$$

$$2x(x - 3) + (x - 3) = 0$$

$$(x - 3)(2x + 1) = 0$$

$$x = 3 \text{ or } x = -\frac{1}{2}$$

h $12x^2 - 8x - 15 = 0$

$$12x^2 - 18x + 10x - 15 = 0$$

$$6x(2x - 3) + 5(2x - 3) = 0$$

$$(6x + 5)(2x - 3) = 0$$

$$x = -\frac{5}{6} \text{ or } x = \frac{3}{2}$$

i $5x^2 + 7x - 12 = 0$

$$5x^2 + 12x - 5x - 12 = 0$$

$$x(5x + 12) - (5x + 12) = 0$$

$$(5x + 12)(x - 1) = 0$$

$$x = 1 \text{ or } x = -\frac{12}{5}$$

5 a $y = 2x^2 + 3$

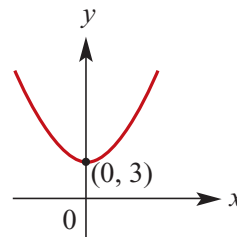

b $y = -2x^2 + 3$

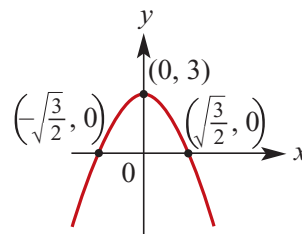

c $y = 2(x - 2)^2 + 3$

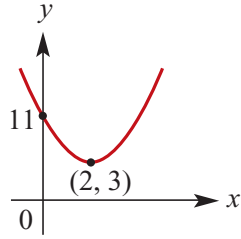

d $y = 2(x + 2)^2 + 3$

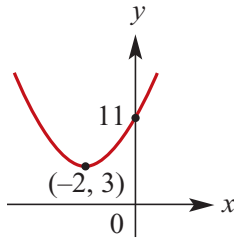

e $y = 2(x - 4)^2 - 3$

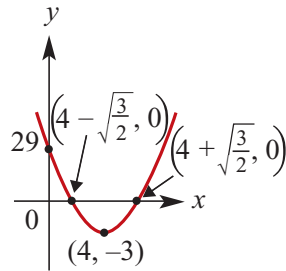

f $y = 9 - 4x^2$

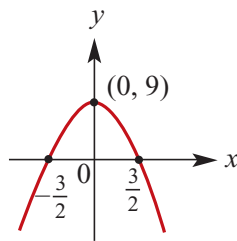

g $y = 3(x - 2)^2$

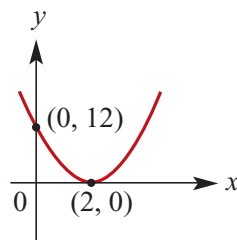

h $y = 2(2 - x)^2 + 3$

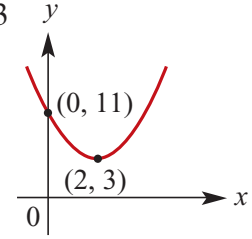

6 a $y = x^2 - 4x - 5$

$$= x^2 - 4x + 4 - 9$$

$$\therefore y = (x - 2)^2 - 9$$

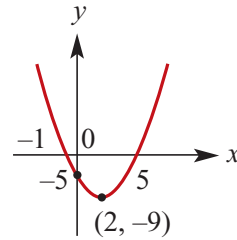

b $y = x^2 - 6x$

$$= x^2 - 6x + 9 - 9$$

$$\therefore y = (x - 3)^2 - 9$$

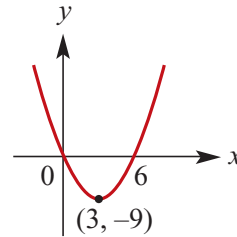

c $y = x^2 - 8x + 4$

$$= x^2 - 8x + 16 - 12$$

$$\therefore y = (x - 4)^2 - 12$$

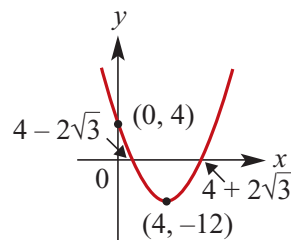

d $y = 2x^2 + 8x - 4$

$$= 2(x^2 + 4x - 2)$$

$$\therefore y = 2(x^2 + 4x + 4 - 6)$$

$$\therefore y = 2(x + 2)^2 - 12$$

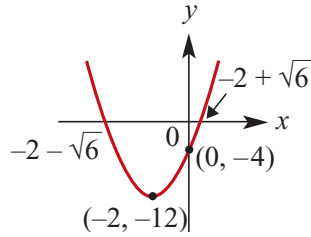

e $y = -3x^2 - 12x + 9$
 $= -3(x^2 + 4x - 3)$
 $= -3(x^2 + 4x + 4 - 7)$
 $\therefore y = -3(x + 2)^2 + 21$

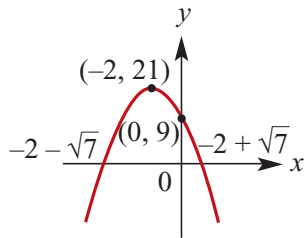

f $y = -x^2 + 4x + 5$
 $\therefore y = -(x^2 - 4x - 5)$
 $\therefore y = -(x^2 - 4x + 4 - 9)$
 $\therefore y = -(x - 2)^2 + 9$

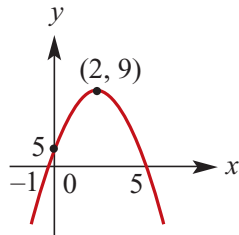

7 i y -intercepts are at $(0, c)$ in each case; x -intercepts are where the factors equal zero.

ii The axis of the symmetry is at
 $x = -\frac{b}{2a}$

iii The turning point is on the axis of symmetry with the y -value for that point.

a $y = x^2 - 7x + 6 = (x - 6)(x - 1)$

i $(0, 6)$, $(6, 0)$ and $(1, 0)$

ii $x = -\frac{b}{2a} = \frac{7}{2}$

iii Turning point at $(\frac{7}{2}, -\frac{25}{4})$

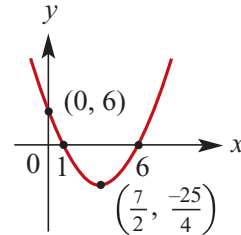

b $y = -x^2 - x + 12$
 $= -(x^2 + x - 12)$
 $= -(x + 4)(x - 3)$

i $(0, 12)$, $(-4, 0)$ and $(3, 0)$

ii $x = -\frac{b}{2a} = -\frac{1}{2}$

iii Turning point at $(-\frac{1}{2}, \frac{49}{4})$

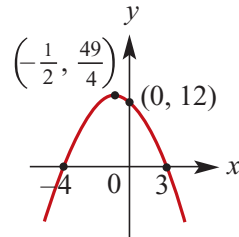

c $y = -x^2 + 5x + 14$
 $= -(x^2 - 5x - 14)$
 $= -(x - 7)(x + 2)$

i $(0, 14)$, $(-2, 0)$ and $(7, 0)$

ii $x = -\frac{b}{2a} = \frac{5}{2}$

iii turning point at $(\frac{5}{2}, \frac{81}{4})$

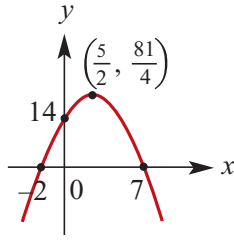

d $y = x^2 - 10x + 16 = (x - 8)(x - 2)$

i $(0, 16), (2, 0)$ and $(8, 0)$

ii $x = -\frac{b}{2a} = 5$

iii turning point at $(5, -9)$

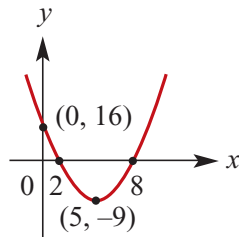

e $y = 2x^2 + x - 15 = (2x - 5)(x + 3)$

i $(0, -15), (\frac{5}{2}, 0)$ and $(-3, 0)$

ii $x = -\frac{b}{2a} = -\frac{1}{4}$

iii Turning point at $(-\frac{1}{4}, -\frac{121}{8})$

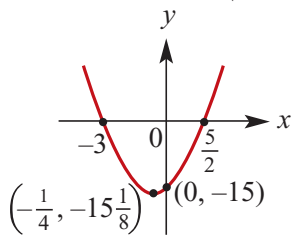

f $y = 6x^2 - 13x - 5 = (3x + 1)(2x - 5)$

i $(0, -5), (\frac{5}{2}, 0)$ and $(-\frac{1}{3}, 0)$

ii $x = -\frac{b}{2a} = \frac{13}{12}$

iii Turning point at $(\frac{13}{12}, -\frac{289}{24})$

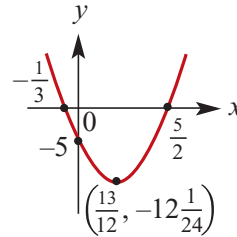

g $y = 9x^2 - 16 = (3x - 4)(3x + 4)$

i $(0, -16), (\frac{4}{3}, 0)$ and $(-\frac{4}{3}, 0)$

ii $x = -\frac{b}{2a} = 0$

iii Turning point at $(0, -16)$

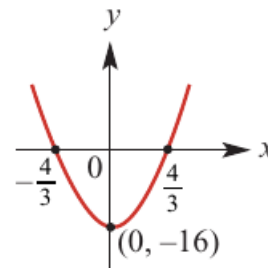

h $y = 4x^2 - 25 = (2x - 5)(2x + 5)$

i $(0, -25), (\frac{5}{2}, 0)$ and $(-\frac{5}{2}, 0)$

ii $x = -\frac{b}{2a} = 0$

iii Turning point at $(0, -25)$

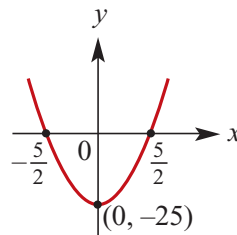

8 $(5p - 1)x^2 - 4x + 2p - 1$

$$\begin{aligned}
\Delta &= 16 - 4(2p - 1)(5p - 1) \\
&= 16 - 4(10p^2 - 7p + 1) \\
&= 16 - 40p^2 + 28p - 4 \\
&= 12 - 40p^2 + 28p \\
&= -4(10p^2 - 7p - 3) \\
&= -4(10p - 3)(p - 1) \\
\Delta = 0 &\Rightarrow p = -\frac{3}{10} \text{ or } p = 1
\end{aligned}$$

9 a $x^2 > x$

$$\Leftrightarrow x^2 - x > 0$$

$$\Leftrightarrow x(x - 1) > 0$$

$$\Leftrightarrow x < 0 \text{ or } x > 1$$

b $(x + 2)^2 \leq 34$

$$\Leftrightarrow (x + 2)^2 - 34 \leq 0$$

$$\Leftrightarrow (x + 2 - \sqrt{34})(x + 2 + \sqrt{34}) \leq 0$$

$$\Leftrightarrow -2 - \sqrt{34} \leq x \leq -2 + \sqrt{34}$$

c $3x^2 + 5x - 2 \leq 0$

$$\Leftrightarrow 3x^2 + 6x - x - 2 \leq 0$$

$$\Leftrightarrow 3x(x + 2) - (x + 2) \leq 0$$

$$\Leftrightarrow (x + 2)(3x - 1) \leq 0$$

$$\Leftrightarrow -2 \leq x \leq \frac{1}{3}$$

d $-2x^2 + 13x \geq 15$

$$\Leftrightarrow -2x^2 + 13x - 15 \geq 0$$

$$\Leftrightarrow -(2x^2 - 13x + 15) \geq 0$$

$$\Leftrightarrow 2x^2 - 13x + 15 \leq 0$$

$$\Leftrightarrow (2x - 3)(x - 5) \leq 0$$

$$\Leftrightarrow \frac{3}{2} \leq x \leq 5$$

10 $x = \frac{-b \pm \sqrt{b^2 - 4ac}}{2a}$

a $x^2 + 6x + 3 = 0$
 $\therefore x = \frac{-6 \pm \sqrt{36 - 12}}{2}$

$$= \frac{-6 \pm 2\sqrt{6}}{2} = -3 \pm \sqrt{6}$$

$x = -0.55, -5.45$ from calculator

b $x^2 + 9x + 12 = 0$
 $\therefore x = \frac{-9 \pm \sqrt{81 - 48}}{2}$

$$= \frac{-9 \pm \sqrt{33}}{2}$$

$x = -1.63, -7.37$ from calculator

c $x^2 - 4x + 2 = 0$
 $\therefore x = \frac{4 \pm \sqrt{16 - 8}}{2}$

$$= 2 \pm \sqrt{2}$$

$x = 3.414, 0.586$ from calculator

d $2x^2 + 7x + 2 = 0$
 $\therefore x = \frac{-7 \pm \sqrt{49 - 16}}{4}$

$$= \frac{-7 \pm \sqrt{33}}{2}$$

$x = -0.314, -3.186$ from calculator

e $2x^2 + 7x + 4 = 0$
 $\therefore x = \frac{-7 \pm \sqrt{49 - 32}}{2}$

$$= \frac{-7 \pm \sqrt{17}}{2}$$

$x = -0.719, -2.7816$ from calculator

f $3x^2 + 9x - 1 = 0$
 $\therefore x = \frac{-9 \pm \sqrt{81 + 12}}{6}$

$$= \frac{-9 \pm \sqrt{93}}{6}$$

$x = -0.107, 3.107$ from calculator

11 $y = a(x - b)(x - c)$

Assume the graph cuts the axis at (0,0)
and (5,0), $b = 0$ and $c = 5$
Using (6, 10): $y = ax(x - 5) = 10$

$$\therefore ax^2 - 5ax - 10 = 0$$

$$36a - 30a - 10 = 0$$

$$6a - 10 = 0$$

$$\therefore a = \frac{5}{3}$$

$$y = \frac{5}{3}x(x - 5)$$

- 12** A parabola has the same shape as
 $y = 3x^2$, but its vertex is at (5,2).
 $y = 3(x - 5)^2 + 2$

13 $(2m - 3)x^2 + (5m - 1)x + (3m - 2) = 0$
 $\Delta = (5m - 1)^2 - 4 \times (2m - 3)(3m - 2)$
 $= 25m^2 - 10m + 1 - 4(6m^2 - 13m + 6)$
 $= m^2 + 42m - 23$
 $= m^2 + 42m + 441 - 441 - 23$
 $= (m + 21)^2 - 464$

$$\Delta > 0 \Leftrightarrow (m - 21)^2 - 464 > 0$$

$$\Leftrightarrow (m + 21 - 4\sqrt{29})(m + 21 + 4\sqrt{29}) > 0$$

$$\Leftrightarrow x < -21 - 4\sqrt{29} \text{ or } m > -21 + 4\sqrt{29}$$

- 14** Let a and b be the numbers.
 $a + b = 30 \therefore b = 30 - a$
 $P = ab = a(30 - a)$
 Maximum occurs when $a = 15$.
 Maximum product is 225

- 15** The vertex is at (1,5).
 $\therefore y = a(x - 1)^2 + 5$
 Using (2, 10):
 $y = a(2 - 1)^2 + 5 = 10$

$$\therefore a = 5$$

$$\therefore y = 5(x - 1)^2 + 5$$

$$\text{OR } y = 5x^2 - 10x + 10$$

- 16 a** $y = 2x + 3$ and $y = x^2$ meet where:

$$x^2 = 2x + 3, \therefore x^2 - 2x - 3 = 0$$

$$\therefore (x - 3)(x + 1) = 0$$

Where $x = 3, y = 9$; where

$x = -1, y = 1$

Curves meet at (3,9) and (-1, 1).

- b** $y = 8x + 11$ and $y = 2x^2$ meet where:

$$2x^2 = 8x + 11$$

$$\therefore x = 2x^2 - 8x - 11 = 0$$

$$\therefore x = \frac{8 \pm \sqrt{64 + 88}}{4}$$

$$\therefore x = 2 \pm \frac{\sqrt{38}}{2}$$

Where $x = 2 - \frac{\sqrt{38}}{2}, y = 27 - 4\sqrt{38}$

Where $x = 2 + \frac{\sqrt{38}}{2}, y = 27 + 4\sqrt{38}$

From calculator: curves meet at
(-1.08, 2.34) and (5.08, 51.66).

- c** $y = 3x^2 + 7x$ and $y = 2$ meet where:

$$3x^2 + 7x = 2$$

$$\therefore 3x^2 + 7x - 2 = 0$$

$$\therefore x = \frac{-7 \pm \sqrt{49 - 24}}{6}$$

$$\therefore x = \frac{-7 \pm \sqrt{73}}{6}$$

Curves meet at $\left(\frac{-7 \pm \sqrt{73}}{6}, 2\right)$.

From calculator: (0.26, 2) and
(-2.62, 2)

- d** $y = 2x^2$ and $y = 2 - 3x$ meet where

$$2x^2 = 2 - 3x$$

$$\therefore 2x^2 + 3x - 2 = 0$$

$$\therefore (2x - 1)(x + 2) = 0, \therefore x = \frac{1}{2}, -2$$

Where $x = \frac{1}{2}$, $y = \frac{1}{2}$; where
 $x = -2$, $y = 8$
 Curves meet at $(\frac{1}{2}, \frac{1}{2})$ and $(-2, 8)$.

17 a Equation is of the form

$$y = k(x + 4)(x - 1)$$

When $x = -1$, $y = -12$

Hence, $-12 = k(3)(-2)$

$$\therefore k = 2$$

$$\therefore y = 2(x + 4)(x - 1)$$

b Equation is of the form

$$y = a(x + 1)^2 + 3$$

When $x = 1$, $y = -5$

Hence, $-5 = a(4) + 3$

$$\therefore a = -2$$

$$\therefore y = -2(x + 1)^2 + 3$$

c Equation is of the form

$$y = ax^2 + bx - 3$$

When $x = 1$, $y = -3$

$$\therefore -3 = a + b - 3 \dots (1)$$

When $x = -1$, $y = 1$

$$\therefore 1 = a - b - 3 \dots (2)$$

Simplifying the equations

$$a + b = 0 \dots (1')$$

$$a - b = 4 \dots (2')$$

Add(1') and (2')

$$2a = 4$$

$$a = 2, b = -2$$

$$\therefore y = 2x^2 - 2x - 3$$

18

$$S = 9.42r^2 + 6(6.28)r = 125.6$$

$$\therefore 9.42r^2 + 37.68r - 125.6 = 0$$

$$\therefore r = \frac{-37.68 \pm \sqrt{37.68^2 + 4(125.6)9.42}}{2(9.42)}$$

$$\therefore r = -2 \pm \frac{\sqrt{6152.4}}{18.84}$$

Since $r > 0$,

$$r = -2 + \frac{\sqrt{6152.4}}{18.84} = 2.16 \text{ m}$$

19 a $2x^2 + mx + 1 = 0$ has exactly one solution where $\Delta = 0$:

$$\Delta = m^2 - 8 = 0, \therefore m^2 = 8$$

$$\therefore m = \pm 2\sqrt{2}$$

b $x^2 - 4mx + 20 = 0$ has real solutions where $\Delta \geq 0$:

$$\Delta = 16m^2 - 80 \geq 0$$

$$\therefore m^2 \geq 5$$

Solution set:

$$\{m: m \leq -\sqrt{5}\} \cap \{m: m \geq \sqrt{5}\}$$

20 $y = x^2 + bx$

a When $y = 0$, $x(x + b) = 0$

$$x = 0 \text{ or } x = -b$$

b Completing the square

$$y = x^2 + bx + \frac{b^2}{4} - \frac{b^2}{4}$$

$$\therefore y = \left(x + \frac{b}{2}\right)^2 - \frac{b^2}{4}$$

The vertex is at $\left(-\frac{b}{2}, -\frac{b^2}{4}\right)$

c $x^2 + bx = x$

$$\text{i } x^2 + (b - 1)x = 0$$

$$\therefore x(x + (b - 1)) = 0$$

$$\therefore x = 0 \text{ or } x = 1 - b$$

The coordinates of the points of intersection are $(0, 0)$ and $(1 - b, 1 - b)$

ii There is one point of intersection

when $b = 1$.

iii There are two points of intersection when $b \neq 1$.

Solutions to multiple-choice questions

1 A $12x^2 + 7x - 12 = (3x + 4)(4x - 3)$

TP is at $(-1, -4)$.

2 C $x^2 - 5x - 14 = 0$
 $\therefore (x - 7)(x + 2) = 0$
 $\therefore x = -2, 7$

8 E $5x^2 - 10x - 2$
 $= 5(x^2 - 2x + 1) - 7$
 $= 5(x - 1)^2 - 7$

3 C $y = 8 + 2x - x^2$
 $= 9 - (x^2 - 2x + 1)$
 $= 9 - (x - 1)^2$
 Maximum value of y is 9 when $x = 1$

9 D If two real roots of $mx^2 + 6x - 3 = 0$ exist, then $\Delta > 0$:
 $\Delta = 6^2 + 12m = 12(m + 3)$
 $m > -3$

4 E $y = 2x^2 - kx + 3$
 If the graph touches the x -axis then $\Delta = 0$:
 $\Delta = (-k)^2 - 24 = 0$
 $\therefore k^2 = 24$
 $\therefore k = \pm \sqrt{24} = \pm 2\sqrt{6}$

10 A $6x^2 - 8xy - 8y^2$
 $= (3x + 2y)(2x - 4y)$

11 B $y = x^2 - ax + \frac{a^2}{4} - \frac{a^2}{4}$
 $y = \left(x - \frac{a}{2}\right) - \frac{a^2}{4}$
 Therefore vertex $\left(\frac{a}{2}, -\frac{a^2}{4}\right)$

5 B $x^2 - 56 = x$
 $\therefore x^2 - x - 56 = 0$
 $\therefore (x - 8)(x + 7) = 0$
 $\therefore x = -7, 8$

12 E $x^2 > b^2$
 $(x - b)(x + b) > 0$
 But $b < 0$ and therefore $-b > 0$
 $(x - b)(x + b) > 0 \Leftrightarrow x > -b$ or $x < b$

6 C $x + 3x - 10$
 $\Delta = 3^2 + 40 = 49$

13 D $\Delta = 4a^2 - 4b$
 One solution when $\Delta = 0$
 $\therefore a^2 = b$
 $\therefore a = \pm \sqrt{b}$

7 E $y = 3x^2 + 6x - 1$
 $= 3x + 6x + 3 - 4$
 $= 3(x + 1)^2 - 4$

Solutions to extended-response questions

1 a The turning point (h, k) is $\left(25, \frac{9}{2}\right)$

$$\therefore y = a(x - 25)^2 + \frac{9}{2}$$

When $x = 0$, $y = 0$

$$\therefore 0 = a(0 - 25)^2 + \frac{9}{2}$$

$$\therefore 0 = 625a + \frac{9}{2}$$

$$\therefore 625a = \frac{-9}{2}$$

$$\therefore a = \frac{-9}{1250}$$

Hence the equation for the parabola is $y = \frac{-9}{1250}(x - 25)^2 + \frac{9}{2}$, for $0 \leq x \leq 50$.
This can also be written as $y = -0.0072x(x - 50)$ [the intercept form].

b

x	0	5	10	15	20	25	30	35	40	45	50
y	0	1.62	2.88	3.78	4.32	4.5	4.32	3.78	2.88	1.62	0

You can find these values using a CAS calculator, or:

$$\begin{aligned} \text{When } x = 10, y &= \frac{-9}{1250}(10 - 25)^2 + \frac{9}{2} \\ &= \frac{-9}{1250} \times 225 + \frac{9}{2} \\ &= \frac{-81}{50} + \frac{225}{50} \\ &= \frac{144}{50} \\ &= \frac{72}{25} \\ &= 2.88 \end{aligned}$$

$$\begin{aligned} \text{When } x = 20, y &= \frac{-9}{1250}(20 - 25)^2 + \frac{9}{2} \\ &= \frac{-9}{1250} \times 25 + \frac{9}{2} \\ &= 4.32 \end{aligned}$$

$$\begin{aligned} \text{When } x = 30, y &= \frac{-9}{1250}(30 - 25)^2 + \frac{9}{2} \\ &= \frac{-9}{1250} \times 25 + \frac{9}{2} \\ &= 4.32 \end{aligned}$$

$$\begin{aligned} \text{When } x = 40, y &= \frac{-9}{1250}(40 - 25)^2 + \frac{9}{2} \\ &= \frac{-9}{1250} \times 225 + \frac{9}{2} \\ &= 2.88 \end{aligned}$$

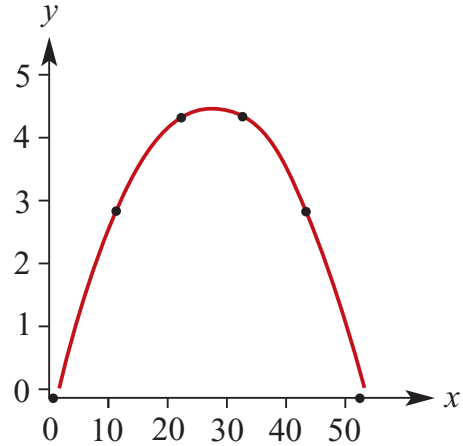

c

$$\begin{aligned} \text{When } y = 3, \quad \frac{-9}{1250}(x - 25)^2 + \frac{9}{2} &= 3 \\ \therefore \quad \frac{-9}{1250}(x - 25)^2 &= \frac{-3}{2} \\ \therefore \quad (x - 25)^2 &= \frac{-3}{2} \times \frac{-1250}{9} = \frac{625}{3} \\ \therefore \quad x - 25 &= \pm \sqrt{\frac{625}{3}} \\ \therefore \quad x &= 25 \pm \frac{25\sqrt{3}}{3} \\ \therefore \quad x &\approx 10.57 \text{ or } x \approx 39.43 \end{aligned}$$

Hence the height of the arch is 3 m above water level approximately 10.57 m and 39.43 m horizontally from A. This can also be solved using a CAS calculator.

$$\begin{aligned} \text{d When } x = 12, y &= \frac{-9}{1250}(12 - 25)^2 + \frac{9}{2} \\ &= \frac{-9}{1250} \times 169 + \frac{9}{2} = 3.2832 \end{aligned}$$

The height of the arch is 3.2832 m at a horizontal distance of 12 m from A.

e The greatest height of the deck above water level, h m, is when

$$\begin{aligned} x + 0.3 &= 15 \text{ and } x - 0.3 = 35 \\ \text{i.e. when } x &= 14.7 \text{ and } x = 35.3 \end{aligned}$$

$$\begin{aligned} \therefore h &= \frac{-9}{1250}(14.7 - 25)^2 + \frac{9}{2} \\ &= 3.736152 \end{aligned}$$

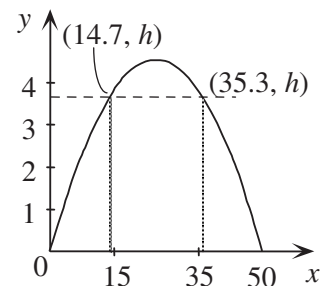

Hence the greatest height of the deck above water level is approximately 3.736 m.

- 2 a** If x cm is the side length of the square then $4x$ cm has been used to form the square, so the perimeter of the rectangle is $P = 12 - 4x$.

Let a cm be the width of the rectangle and $2a$ cm be the length of the rectangle,

$$\text{SO } P = a + a + 2a + 2a = 6a$$

$$\therefore 6a = 12 - 4x$$

$$\therefore a = 2 - \frac{2}{3}x \quad \text{and} \quad 2a = 4 - \frac{4}{3}x$$

Hence the dimensions of the rectangle are $\left(2 - \frac{2}{3}x\right)$ cm \times $\left(4 - \frac{4}{3}x\right)$ cm.

- b** Let A_1 be the area of the square and A_2 be the area of the rectangle.

$$\begin{aligned} \therefore A &= A_1 + A_2 = x^2 + \left(2 - \frac{2}{3}x\right)\left(4 - \frac{4}{3}x\right) \\ &= x^2 + 8 - \frac{8}{3}x - \frac{8}{3}x + \frac{8}{9}x^2 \\ &= \frac{17}{9}x^2 - \frac{16}{3}x + 8 \end{aligned}$$

Hence the combined area of the square and the rectangle in cm^2 is defined by the rule $A = \frac{17}{9}x^2 - \frac{16}{3}x + 8$.

- c** TP occurs when $x = -\frac{b}{2a}$
- $$\begin{aligned} &= \frac{16}{3} \div \frac{34}{9} \\ &= \frac{24}{17} \end{aligned}$$

Minimum occurs when $x = \frac{24}{17}$.

$$\text{When } x = \frac{24}{17}, \quad 4x = \frac{96}{17} \approx 5.65$$

$$\text{and} \quad 12 - 4x = \frac{108}{17} \approx 6.35$$

Hence, the wire needs to be cut into lengths of 5.65 cm and 6.35 cm (correct to 2 decimal places) for the sum of the areas to be a minimum.

- 3 a**

$$V = \text{rate} \times \text{time}$$

$$\text{When } x = 5, \quad V = 0.2 \times 60 = 12$$

$$\text{When } x = 10, \quad V = 0.2 \times 60 \times 5 = 60$$

$$\text{When } x = 0, \quad V = 0$$

$\therefore c = 0$ (y-axis intercept is 0)

$$\therefore V = ax^2 + bx$$

When $x = 5$, $V = 12$, $12 = 25a + 5b$ (1)

When $x = 10$, $V = 60$, $60 = 100a + 10b$ (2)

$2 \times (1)$ $24 = 50a + 10b$ (3)

$(2) - (3)$ $36 = 50a$

$$\therefore a = \frac{36}{50} = \frac{18}{25}$$

Substitute $a = \frac{18}{25}$ in (1) $12 = 25 \times \frac{18}{25} + 5b$

$$\therefore 12 = 18 + 5b$$

$$\therefore 5b = -6$$

$$\therefore b = -\frac{6}{5}$$

Hence, the rule for V in terms of x is $V = \frac{18}{25}x^2 - \frac{6}{5}x$, $x \geq 0$, or $v = 0.72x^2 - 1.2x$

b When $x = 20$ (i.e. a depth of 20 cm),

$$\begin{aligned} V &= \frac{18}{25}(20)^2 - \frac{6}{5}(20) \\ &= \frac{18 \times 400}{25} - 24 \\ &= 18 \times 16 - 24 = 264 \end{aligned}$$

Now $V = \text{rate} \times \text{time}$

$$\begin{aligned} \therefore \text{time} &= \frac{V}{\text{rate}} \\ &= \frac{264}{0.2} = 1320 \text{ minutes} \\ &= 22 \text{ hours} \end{aligned}$$

Water can be pumped into the tank for 22 hours before overflowing.

4 a Let $V_E \text{ m}^3$ be the volume of the embankment.

$$\begin{aligned} V_E &= 120 \times \text{shaded area} \\ &= 120 \left(90x + \frac{1}{2}x^2 + \frac{1}{2}x^2 \right) \\ &= 120x^2 + 10800x, x > 0 \end{aligned}$$

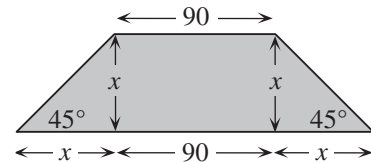

b Let V_C m³ be the volume of the cutting.

$$\begin{aligned} V_C &= 100 \times \text{shaded area} \\ &= 100(50x + x^2 \tan 25^\circ) \\ &\approx 100(50x + 0.466\ 308x^2) \\ &\approx 46.63x^2 + 5000x, x > 0 \end{aligned}$$

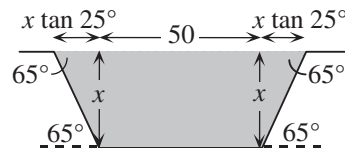

c When $x = 4$, $V_C \approx 46.63 \times 4^2 + 5000 \times 4$
 ≈ 20746.08

Now $V_E = L \times (x^2 + 90x)$, where L m is the length of the embankment.

$$\therefore L = \frac{V_E}{x^2 + 90x}$$

If using soil from the cutting, $V_C = V_E$

$$\begin{aligned} \therefore L &= \frac{V_C}{x^2 + 90x} \\ &= \frac{20746.08}{4^2 + 90 \times 4} \approx 55.18 \end{aligned}$$

Hence, when $x = 4$ m, an embankment 55.18 m long could be constructed from the soil taken from the cutting.

5 a $5x + 2l = 100$

$$\therefore 2l = 100 - 5x$$

$$\therefore l = 50 - \frac{5}{2}x$$

b $A = x \times l$

$$= 50x - \frac{5}{2}x^2$$

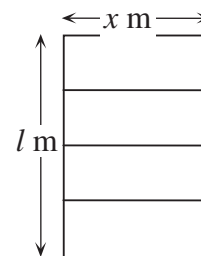

c When $A = 0$, $-\frac{5}{2}x^2 + 50x = 0$

$$\therefore x\left(-\frac{5}{2}x + 50\right) = 0$$

$$\therefore \text{either } x = 0 \text{ or } -\frac{5}{2}x + 50 = 0$$

$$\text{If } -\frac{5}{2}x + 50 = 0, \quad \frac{5}{2}x = 50$$

$$\therefore x = \frac{2 \times 50}{5}$$

$$= 20$$

Turning point is halfway between the x -intercepts, i.e. at $x = 10$.

When $x = 10$,

$$\begin{aligned} A &= -\frac{5}{2} \times 10^2 + 50 \times 10 \\ &= -250 + 500 = 250 \end{aligned}$$

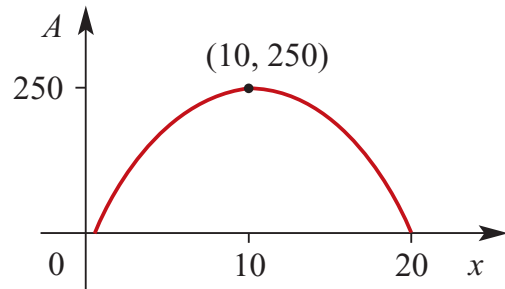

Completing the square may also be used to find the vertex.

d The maximum area is 250 m^2 when x is 10 metres.

6 Given $AP = 1$, $AB = 1 - x$, $AD = x$ and $\frac{AP}{AD} = \frac{AD}{AB}$

then $\frac{1}{x} = \frac{x}{1-x}$

$\therefore 1 - x = x^2$

$\therefore x^2 + x - 1 = 0$

Using the general quadratic formula:

$$x = \frac{-b \pm \sqrt{b^2 - 4ac}}{2a} \quad \text{where } a = 1, b = 1, c = -1$$

$$\begin{aligned} \therefore x &= \frac{-1 \pm \sqrt{1 - 4(1)(-1)}}{2} = \frac{-1 \pm \sqrt{5}}{2} \\ &= \frac{-1 - \sqrt{5}}{2} \text{ or } \frac{-1 + \sqrt{5}}{2} \end{aligned}$$

but $x > 0$, so $x = \frac{-1 + \sqrt{5}}{2}$

7 a Using Pythagoras' theorem

$$\begin{aligned} PA^2 &= 5^2 + x^2 \\ &= x^2 + 25 \end{aligned}$$

$\therefore PA = \sqrt{x^2 + 25}$

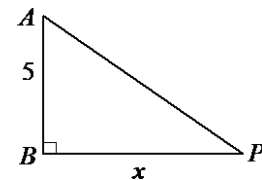

b i $PC = BC - BP$

$$= 16 - x$$

ii Using Pythagoras' theorem

$$\begin{aligned} PD^2 &= (16 - x)^2 + 3^2 \\ &= x^2 - 32x + 256 + 9 \end{aligned}$$

$$\therefore PD = \sqrt{x^2 - 32x + 265}$$

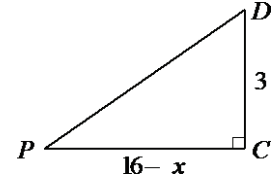

c If $PA = PD$, $\sqrt{x^2 + 25} = \sqrt{x^2 - 32x + 265}$

$$\therefore x^2 + 25 = x^2 - 32x + 265$$

$$\therefore 25 = -32x + 265$$

$$\therefore 32x = 240$$

$$\therefore x = 7.5$$

d If $PA = 2PD$, $\sqrt{x^2 + 25} = 2\sqrt{x^2 - 32x + 265}$

$$\therefore x^2 + 25 = 4(x^2 - 32x + 265)$$

$$\therefore = 4x^2 - 128x + 1060$$

$$\therefore 3x^2 - 128x + 1035 = 0$$

Using the general quadratic formula,

$$x = \frac{128 \pm \sqrt{(-128)^2 - 4(3)(1035)}}{2(3)}$$

$$= \frac{128 \pm \sqrt{3964}}{6}$$

$$= \frac{128 \pm 2\sqrt{991}}{6}$$

$$= \frac{64 \pm \sqrt{991}}{3}$$

$$= 31.82671\dots \text{ or } 10.83994\dots$$

$$\approx 10.840 \text{ (as } 0 \leq x \leq 16)$$

e If $PA = 3PD$, $\sqrt{x^2 + 25} = 3\sqrt{x^2 - 32x + 265}$

$$\therefore x^2 + 25 = 9(x^2 - 32x + 265)$$

$$= 9x^2 - 288x + 2385$$

$$\therefore 8x^2 - 288x + 2360 = 0$$

$$\therefore 8(x^2 - 36x + 295) = 0$$

Using the general quadratic formula,

$$\begin{aligned} x &= \frac{36 \pm \sqrt{(-36)^2 - 4(1)(295)}}{2(1)} \\ &= \frac{36 \pm \sqrt{116}}{2} \\ &= \frac{36 \pm 2\sqrt{29}}{2} = 18 \pm \sqrt{29} \\ &= 23.385\ 16\dots \text{ or } 12.615\ 83\dots \end{aligned}$$

$$\approx 12.615 \text{ (as } 0 \leq x \leq 16)$$

Note: Parts **c**, **d** and **e** can be solved using the CAS calculator. Plot the graphs of $f1 = \sqrt{x^2 + 25}$, $f2 = \sqrt{x^2 - 32x + 265}$, $f3 = 2 \times f2(x)$ and $f4 = 3 \times f2(x)$ for

$x \in [0, 16]$. The points of intersection of $f1$ with each of the other graphs provide the solutions for x .

- 8 a i** Consider AB and CD to be a pair of Cartesian axes with O at the point $(0, 0)$. The first jogger is at the point $(8t, 0)$ at time t . The second jogger is at the point $(0, 10t - 5)$ at time t .

Using Pythagoras' theorem

$$\begin{aligned} y^2 &= (8t)^2 + (10t - 5)^2 \\ &= 64t^2 + 100t^2 - 100t + 25 \end{aligned}$$

$$\therefore y = \sqrt{164t^2 - 100t + 25}$$

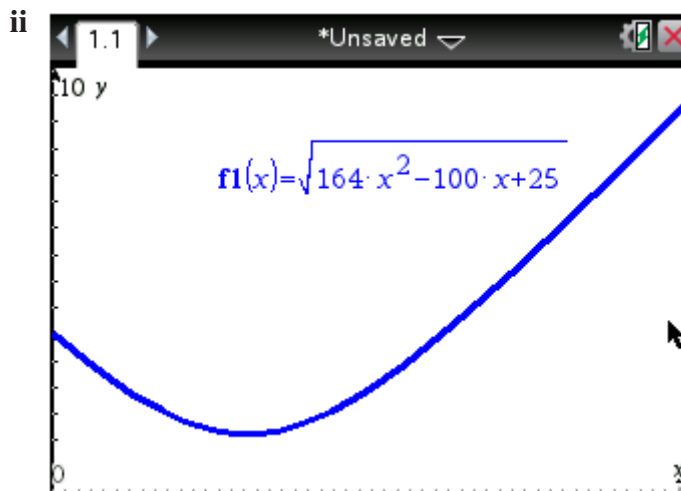
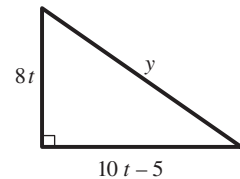

- iii** On a CAS calculator, enter $\text{solve}(\sqrt{164x^2 - 100x + 25} = 4, x)$.

The points of intersection are $\left(\frac{9}{82}, 4\right)$ and $\left(\frac{1}{2}, 4\right)$.

Therefore joggers are 4 km apart after 0.11 hours (1.07 pm), correct to 2 decimal places, and after 0.5 hours (1.30 pm).

Or consider $\sqrt{164t^2 - 100t + 25} = 4$

$\therefore 164t^2 - 100t + 9 = 0$

$\therefore t = \frac{100 \pm \sqrt{(-100)^2 - 4(9)(164)}}{2(164)}$
 $= \frac{100 \pm \sqrt{4096}}{328}$
 $= \frac{100 \pm 64}{328}$
 $= \frac{1}{2} \text{ or } \frac{9}{82}$

iv With the graph from part **ii** on screen

TI: Press **Menu**→**6:Analyze Graph**→**2:Minimum**

CP: Tap **Analysis**→**G-Solve**→**Min**

to yield (0.30487837, 3.12 4752).

Therefore joggers are closest when they are 3.12 km apart after 0.30 hours, correct to 2 decimal places.

Alternatively, the minimum of $\sqrt{164t^2 - 100t + 25}$ occurs when $164t^2 - 100t + 25$ is a minimum.

This occurs when $t = \frac{100}{2 \times 164}$
 $= \frac{25}{82}$ (1.18 pm)

\therefore minimum distance apart $= \frac{20}{\sqrt{41}}$
 $= \frac{20\sqrt{41}}{41}$
 ≈ 3.123 km

b i When $y = 5$, $5 = \sqrt{164t^2 - 100t + 25}$

$\therefore 25 = 164t^2 - 100t + 25$

$\therefore 164t^2 - 100t = 0$

$\therefore 4t(41t^2 - 25t) = 0$

$\therefore t = 0 \text{ or } t = \frac{25}{41}$

ii When $y = 6$, $6 = \sqrt{164t^2 - 100t + 25}$

$\therefore 36 = 164t^2 - 100t + 25$

$\therefore 164t^2 - 100t - 11 = 0$

Using the general quadratic formula,

$$t = \frac{100 \pm \sqrt{(-100)^2 - 4(164)(-11)}}{2(164)}$$

$$= \frac{100 \pm \sqrt{17216}}{328} = \frac{25 \pm 2\sqrt{269}}{82}$$

9 a $BC = x, CD = y, BD = \text{diameter of circle} = 2a$

Using Pythagoras' theorem,

$$BC^2 + CD^2 = BD^2$$

$\therefore x^2 + y^2 = 4a^2$, as required.

b Perimeter = b , but perimeter = $2(x + y)$

$\therefore 2(x + y) = b$

c $2(x + y) = b \qquad \therefore 2x + 2y = b$

$\therefore 2y = b - 2x$

$\therefore y = \frac{1}{2}b - x \qquad (1)$

Substituting (1) into $x^2 + y^2 = 4a^2$ gives

$$x^2 + \left(\frac{1}{2}b - x\right)^2 = 4a^2$$

$\therefore 2x^2 - bx + \frac{1}{4}b^2 - 4a^2 = 0 \qquad (2)$

$\therefore 8x^2 - 4bx + b^2 - 16a^2 = 0$

d Now $x + y > 2a \therefore$ using (1), $x + \left(\frac{1}{2}b - x\right) > 2a$

$\therefore \frac{1}{2}b > 2a$

$\therefore b > 4a$

Considering the discriminant, Δ , of (2)

$$\Delta = (-b)^2 - 4(2)\left(\frac{1}{4}b^2 - 4a^2\right)$$

$$= b^2 - 8\left(\frac{1}{4}b^2 - 4a^2\right)$$

$$= b^2 - 2b^2 + 32a^2$$

$$= 32a^2 - b^2$$

For the inscribed rectangle to exist, $\Delta \geq 0$

$$\therefore 32a^2 - b^2 \geq 0$$

$$\therefore b^2 \leq 32a^2$$

$$\therefore b \leq 4\sqrt{2}a$$

$\therefore 4a < b \leq 4\sqrt{2}a$, as required.

e i Substituting $a = 5$ and $b = 24$ into (2) gives

$$2x^2 - 24x + \left(\frac{1}{4}(24)^2 - 4(5)^2\right) = 0$$

$$\therefore 2x^2 - 24x + 44 = 0$$

$$\therefore x^2 - 12x + 22 = 0$$

Using the general quadratic formula,

$$x = \frac{12 \pm \sqrt{(-12)^2 - 4(1)(22)}}{2(1)}$$

$$= \frac{12 \pm \sqrt{56}}{2}$$

$$= 6 \pm \sqrt{14}$$

Now $y = \frac{1}{2}b - x$

$$= \frac{1}{2}(24) - x = 12 - x$$

When $x = 6 + \sqrt{14}$, $y = 12 - (6 + \sqrt{14})$

When $x = 6 - \sqrt{14}$, $y = 6 - \sqrt{14}$

When $x = 6 + \sqrt{14}$, $y = 6 + \sqrt{14}$

ii If $b = 4\sqrt{2}a$, then (2) gives

$$2x^2 - 4\sqrt{2}ax + \left(\frac{1}{4}(4\sqrt{2}a)^2 - 4a^2\right) = 0$$

$$\therefore 2x^2 - 4\sqrt{2}ax + 8a^2 - 4a^2 = 0$$

$$\therefore 2x^2 - 4\sqrt{2}ax + 4a^2 = 0$$

$$\therefore x^2 - 2\sqrt{2}ax + 2a^2 = 0$$

$$\therefore (x - \sqrt{2}a)^2 = 0$$

$$\begin{aligned} \therefore x &= \sqrt{2a} \\ \therefore y &= \frac{1}{2}b - x \\ &= 2\sqrt{2a} - \sqrt{2a} \\ &= \sqrt{2a} \end{aligned}$$

f If $\frac{b}{a} = 5$, then $b = 5a$ and, from (2):

$$\begin{aligned} 2x^2 - (5a)x + \left(\frac{1}{4}(5a)^2 - 4a^2\right) &= 0 \\ \therefore 2x^2 - 5ax + \left(\frac{25}{4}a^2 - 4a^2\right) &= 0 \\ \therefore 2x^2 - 5ax + \frac{9}{4}a^2 &= 0 \end{aligned}$$

Using the general quadratic formula,

$$\begin{aligned} x &= \frac{5a \pm \sqrt{(-5a)^2 - 4 \times 2 \times \frac{9}{4}a^2}}{2(2)} \\ &= \frac{5a \pm \sqrt{25a^2 - 18a^2}}{4} \\ &= \frac{5a \pm \sqrt{7}a}{4} \end{aligned}$$

$$\begin{aligned} \text{Now } y &= \frac{1}{2}b - x \\ &= \frac{1}{2}(5a) - x \\ &= \frac{5}{2}a - x \end{aligned}$$

$$\text{When } x = \frac{5a \pm \sqrt{7}a}{4}, y = \frac{5}{2}a - \frac{5a \pm \sqrt{7}a}{4}$$

$$\text{When } x = \frac{5a + \sqrt{7}a}{4}, y = \frac{5a - \sqrt{7}a}{4}$$

$$\text{When } x = \frac{5a - \sqrt{7}a}{4}, y = \frac{5a + \sqrt{7}a}{4}$$

g The following program can be input into a CAS calculator to solve equation (2) in part **c** for x and y , given a and $b(a, b \in \mathbb{R})$, correct to 2 decimal places.

TI: In the calculator application press **menu→9:Functions & Programs→1:Program Editor1:New**. Name the program prog1. The following information is shown automatically. Complete the screen as follows: Complete the screen as follows:

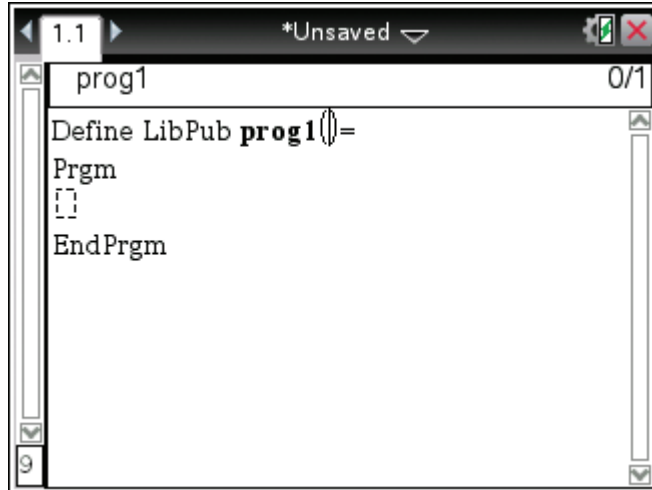

```

Define LibPub prog1 () =
Prgm
setMode(5,2)
setMode(1,16)
Local a,b,w,x,y,z
Request "a = ",a
Request "b = ",b
(b + √(32a^2 - b^2))/4 → x
b/2 - x → y
(b - √(32a^2 - b^2))/4 → w
b/2 - w → z
Disp "x= ",x
Disp "and y= ",y
Disp "OR"
Disp "x=",w
Disp "and y =", z
EndPrgm

```

10 a Equation of curve A is

$$y = (x - h)^2 + 3$$

$$(0, 4): 4 = (0 - h)^2 + 3$$

$$h^2 = 1$$

$$h = 1 \text{ (since } h > 0)$$

$$\text{So } y = (x - 1)^2 + 3$$

$$= x^2 - 2x + 4$$

Giving $b = -2, c = 4$ and $h = 1$

b i The coordinates of P' are $(x, -6 + 4x - x^2)$

ii Let (m, n) be the coordinates of M .

$$\therefore m = x$$

$$\begin{aligned} \text{and } n &= \frac{(x^2 - 2x + 4) + (-6 + 4x - x^2)}{2} \\ &= \frac{2x - 2}{2} = x - 1 \end{aligned}$$

\therefore the coordinates of M are $(x, x - 1)$.

iii The coordinates of M for $x = 0, 1, 2, 3, 4$ are $(0, -1), (1, 0), (2, 1), (3, 2)$ and $(4, 3)$ respectively.

iv $y = x - 1$ is the equation of the straight line on which the points $(0, -1), (1, 0), (2, 1), (3, 2)$ and $(4, 3)$ all lie.

c i $d = (x^2 - 2x + 4) - (-6 + 4x - x^2) = 2x^2 - 6x + 10$

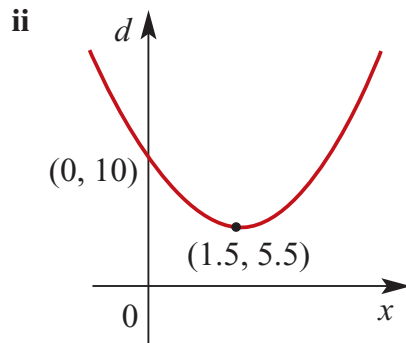

iii

$$\begin{aligned} \text{Consider } 2(x^2 - 3x + 5) &= 2\left(x^2 - 3x + \frac{9}{4} + 5 - \frac{9}{4}\right) \\ &= 2\left(\left(x - \frac{3}{2}\right)^2 + \frac{11}{4}\right) = 2\left(x - \frac{3}{2}\right)^2 + \frac{11}{2} \end{aligned}$$

\therefore minimum value of d is $\frac{11}{2}$ and occurs for $x = \frac{3}{2}$.

11 a Length of path $= \sqrt{(60 + 30)^2 + (30 + 15)^2}$
 $= \sqrt{10\,125}$
 $= 45\sqrt{5}$

b i $y = ax^2 + bx + c$

At $(-20, 45)$, $45 = 400a - 20b + c$ (1)

At $(40, 40)$, $40 = 1600a + 40b + c$ (2)

At $(30, 35)$, $35 = 900a + 30b + c$ (3)

(2) - (1) gives $-5 = 1200a + 60b$ (4)

(2) - (3) gives $5 = 700a + 10b$ (5)

$6 \times (5) - (4)$ gives $35 = 3000a$

$\therefore a = \frac{35}{3000} = \frac{7}{600}$

Substituting $a = \frac{7}{600}$ into (5) gives:

$$\begin{aligned} 5 &= 700\left(\frac{7}{600}\right) + 10b \\ &= \frac{49}{6} + 10b \end{aligned}$$

$\therefore 10b = \frac{-19}{6}$

$\therefore b = \frac{-19}{60}$

Substituting $a = \frac{7}{600}$ and $b = \frac{-19}{60}$ into (1) gives:

$$\begin{aligned} 45 &= 400\left(\frac{7}{600}\right) - 20\left(\frac{-19}{60}\right) + c \\ &= \frac{14}{3} + \frac{19}{3} + c \end{aligned}$$

$\therefore c = 34$

$\therefore y = \frac{7}{600}x^2 - \frac{19}{60}x + 34$

TI: Press **Menu**→**6:Analyze Graph**→**2:Minimum** with $f1=7/600x^2-19/60x+34$,

CP: Tap **Analysis**→**G-Solve**→**Min**

to yield $(13.571521, 31.85, 19)$. Therefore the vertex of the parabola has coordinates $(13.57, 31.85)$, correct to 2 decimal places.

$$\begin{aligned} \text{Or consider } \frac{7}{600}x^2 - \frac{19}{60}x + 34 &= \frac{7}{600}\left(x^2 - \frac{190}{7}x + \frac{20400}{7}\right) \\ &= \frac{7}{600}\left(\left(x - \frac{95}{7}\right)^2 + \frac{133775}{49}\right) \\ &= \frac{7}{600}\left(x - \frac{95}{7}\right)^2 + \frac{5351}{168} \end{aligned}$$

\therefore minimum value is $\frac{5351}{168}$ and this occurs when $x = \frac{95}{7}$.

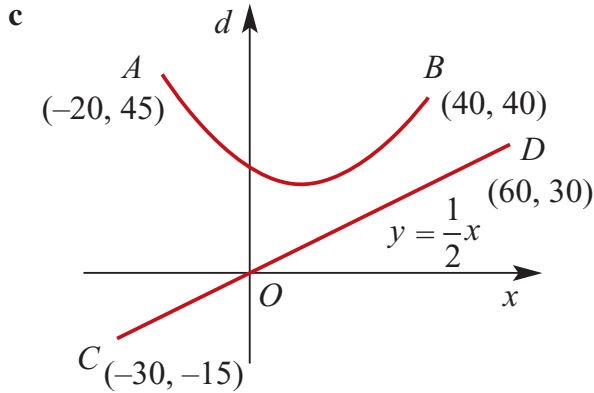

d i The expression $y = (ax^2 + bx + c) - \frac{1}{2}x$ determines the distance, perpendicular to the x -axis, between $y = ax^2 + bx + c$ and $y = \frac{1}{2}x$ at the point x . In this question, it is the distance between the path and the pond.

ii With $fI = 7x^2/600 - 19x/60 + 34 - x/2$

TI: Press **Menu**→**6:Analyze Graph**→**2:Minimum**

CP: Tap **Analysis**→**G-Solve**→**Min**

to yield (35.000 004, 19.708 333). Therefore the minimum value is 19.71 which occurs when $x = 35.00$, correct to 2 decimal places.

$$\begin{aligned} \text{Or consider } \frac{7x^2}{600} - \frac{19x}{60} + 34 - \frac{x}{2} &= \frac{7x^2}{600} - \frac{49x}{60} + 34 \\ &= \frac{7}{600} \left(x^2 - 70x + \frac{20400}{7} \right) \\ &= \frac{7}{600} \left(x^2 - 70x + 1225 + \frac{11825}{7} \right) \\ &= \frac{7}{600} \left((x - 35)^2 + \frac{11825}{7} \right) \\ &= \frac{7}{600} (x - 35)^2 + \frac{473}{24} \end{aligned}$$

∴ minimum value is $\frac{473}{24}$ which occurs when $x = 35$.

Chapter 4 – A gallery of graphs

Solutions to Exercise 4A

1 a $y = \frac{1}{x}$; asymptotes at $x = 0$ and $y = 0$

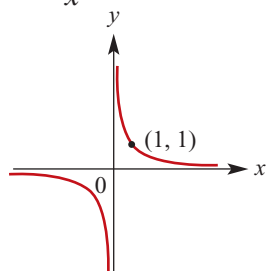

b $y = \frac{2}{x}$; asymptotes at $x = 0$ and $y = 0$

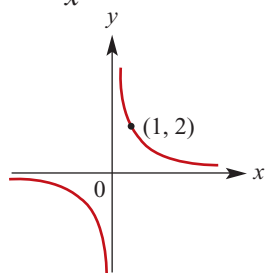

c $y = \frac{1}{2x}$; asymptotes at $x = 0$ and $y = 0$

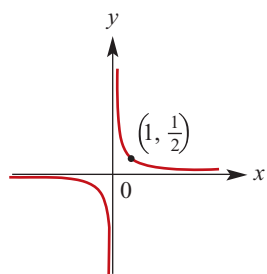

d $y = -\frac{3}{x}$; asymptotes at $x = 0$ and $y = 0$

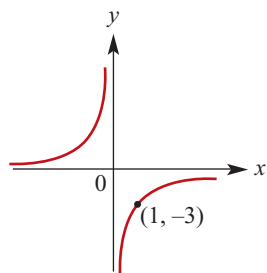

e $y = \frac{1}{x} + 2$; asymptotes at $x = 0$
and $y = 2$ x -intercept where
 $y = \frac{1}{x} + 2 = 0, \therefore x = -\frac{1}{2}$

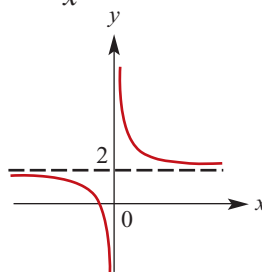

f $y = \frac{1}{x} - 3$; asymptotes at $x = 0$ and
 $y = -3$ x -intercept where
 $y = \frac{1}{x} - 2 = 0, \therefore x = \frac{1}{3}$

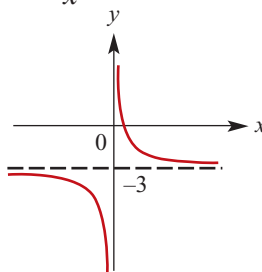

g $y = \frac{2}{x} - 4$; asymptotes at $x = 0$ and
 $y = -4$ x -intercept where
 $y = \frac{2}{x} - 4 = 0, \therefore x = \frac{1}{2}$

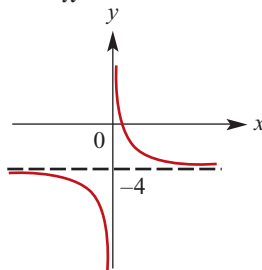

h $y = -\frac{1}{2x} + 5$;
 asymptotes at $x = 0$ and $y = 5$
 x-intercept where
 $y = -\frac{1}{2x} + 5 = 0 \therefore x = 0.1$

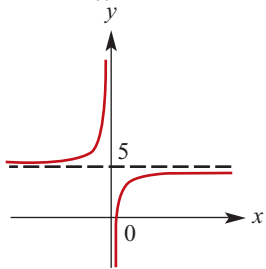

i $y = \frac{1}{x-1}$; asymptotes at $x = 1$ and
 $y = 0$
 y-intercept where $y = \frac{1}{0-1} = -1$

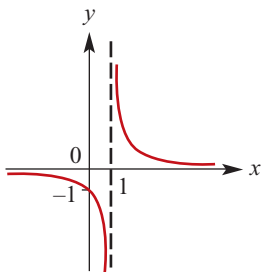

j $y = -\frac{1}{x+2}$;
 Asymptotes at $x = -2$ and $y = 0$
 y-intercept where $y = -\frac{1}{0+2} = -\frac{1}{2}$

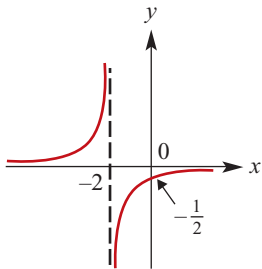

k $y = \frac{1}{x+1} + 3$;
 asymptotes at $x = -1$ and $y = 3$
 x-intercept where
 $y = \frac{1}{x+1} + 3 = 0$

$$\therefore \frac{1}{x+1} = -3$$

$$\therefore x+1 = -\frac{1}{3}$$

$$\therefore x = -\frac{4}{3}$$

y-intercept where
 $y = \frac{1}{0+1} + 3 = 4$

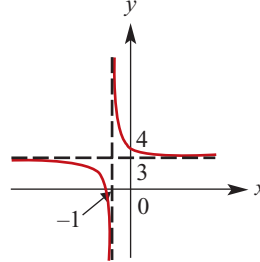

l $y = -\frac{2}{x-3} - 4$;
 asymptotes at $x = 3$ and $y = -4$
 x-intercept where $y = -\frac{2}{x-3} - 4 = 0$

$$\therefore \frac{2}{x-3} = -4$$

$$\therefore x-3 = -\frac{1}{2}$$

$$\therefore x = \frac{5}{2}$$

y-intercept where
 $y = -\frac{2}{0-3} - 4 = -\frac{10}{3}$

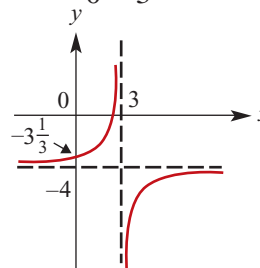

2 Answers given in question 1

- 3 a** The graph of $y = \frac{1}{3x+6}$ can be obtained by translating the graph of $y = \frac{1}{3x}$ two units to the left. The equations of the asymptotes are $x = -2$ and $y = 0$.
When $x = 0, y = \frac{1}{6}$

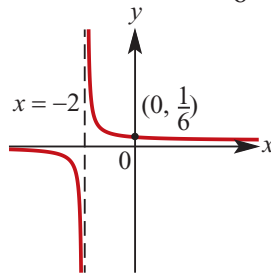

- b** The graph of $y = \frac{3}{2x+4}$ can be obtained by translating the graph of $y = \frac{3}{2x}$ two units to the left. The equations of the asymptotes are $x = -2$ and $y = 0$.
When $x = 0, y = \frac{3}{4}$

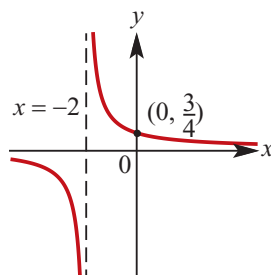

- c** The graph of $y = \frac{-1}{2x+4}$ can be obtained by translating the graph of $y = \frac{-1}{2x}$ two units to the left. The equations of the asymptotes are $x = -2$ and $y = 0$.
When $x = 0, y = -\frac{1}{4}$

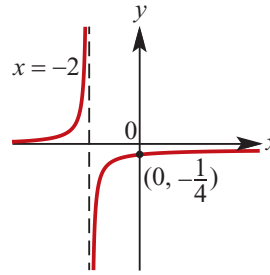

- d** The graph of $y = \frac{1}{2x+1}$ can be obtained by translating the graph of $y = \frac{1}{2x}$ half a unit to the left. The equations of the asymptotes are $x = -\frac{1}{2}$ and $y = 0$.
When $x = 0, y = 1$

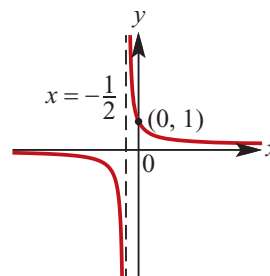

4 a $\frac{1}{3x+1} = \frac{1}{3(x+\frac{1}{3})}$.

Translate the graph of $y = \frac{1}{3x}$ one third of a unit to the left.

When $x = 0, y = 1$

The equations of the asymptotes are

$x = -\frac{1}{3}$ and $y = 0$

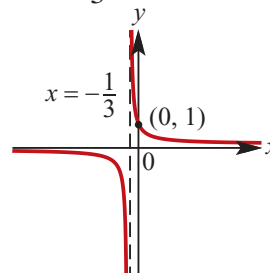

- b** Translate the graph of $y = \frac{1}{3x+1}$ one unit in the negative direction of the y -axis.

When $x = 0, y = 0$

When $y = 0, \frac{1}{3x+1} - 1 = 0$

$$\frac{1}{3x+1} - 1 = 0$$

$$\frac{1}{3x+1} = 1$$

$$3x+1 = 1$$

$$x = 0$$

The equations of the asymptotes are

$x = -\frac{1}{3}$ and $y = -1$.

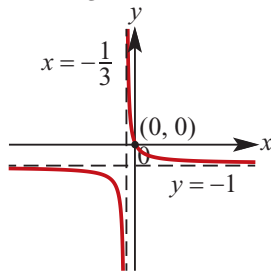

- c** Reflect the graph of $y = \frac{1}{3x+1}$ in the x axis and translate the image, $y = -\frac{1}{3x+1}$ one unit in the negative direction of the y -axis.

When $x = 0, y = -2$

When $y = 0, -\frac{1}{3x+1} - 1 = 0$

$$-\frac{1}{3x+1} - 1 = 0$$

$$-\frac{1}{3x+1} = 1$$

$$3x+1 = -1$$

$$x = -\frac{2}{3}$$

The equation of the asymptotes are

$x = -\frac{1}{3}$ and $y = -1$.

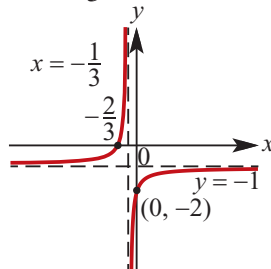

- d** Reflect the graph of $y = \frac{2}{3x+1}$ in the x axis. When $x = 0, y = -2$

The equation of the asymptotes are

$x = -\frac{1}{3}$ and $y = -\frac{1}{3}$.

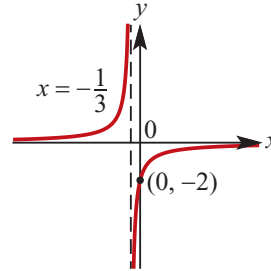

- e** Translate the graph of $y = \frac{-2}{3x+1}$ four units in the negative direction of the y -axis.

When $x = 0, y = -6$

When $y = 0, -\frac{2}{3x+1} - 4 = 0$

$$-\frac{2}{3x+1} - 4 = 0$$

$$-\frac{1}{3x+1} = 2$$

$$6x+2 = -1$$

$$x = -\frac{1}{2}$$

The equation of the asymptotes are

$x = -\frac{1}{3}$ and $y = -4$.

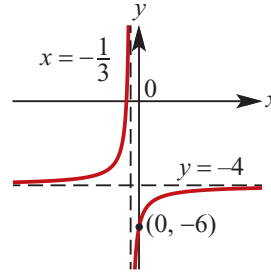

- f** Translate the graph of $y = \frac{-2}{3x+1}$ three units in the positive direction of the y -axis.

When $x = 0, y = 1$

When $y = 0, -\frac{2}{3x+1} + 3 = 0$

$$-\frac{2}{3x+1} + 3 = 0$$

$$\frac{1}{3x+1} = 3$$

$$9x + 3 = 1$$

$$x = -\frac{2}{9}$$

The equation of the asymptotes are

$$x = -\frac{1}{3} \text{ and } y = 3.$$

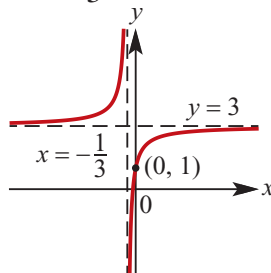

$$\text{g } \frac{2}{3x+2} = \frac{2}{3(x+\frac{2}{3})}$$

Translate the graph of $y = \frac{2}{3x}$ two thirds units in the negative direction of the x -axis and one unit in the negative direction of the y -axis.

$$\text{When } x = 0, y = 0$$

$$\text{When } y = 0, \frac{2}{3x+2} - 1 = 0$$

$$\frac{2}{3x+2} - 1 = 0$$

$$\frac{2}{3x+2} = 1$$

$$3x + 2 = 2$$

$$x = 0$$

The equation of the asymptotes are

$$x = -\frac{2}{3} \text{ and } y = -1.$$

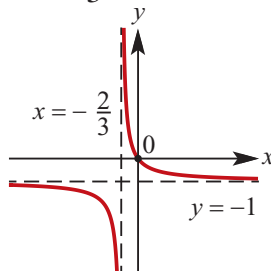

$$\text{h } \frac{3}{3x+4} = \frac{3}{3(x+\frac{4}{3})} = \frac{1}{3x+\frac{4}{3}}$$

Translate the graph of $y = \frac{1}{x}$ four thirds units in the negative direction of the x -axis and one unit in the negative direction of the y -axis.

$$\text{When } x = 0, y = -\frac{3}{4}$$

$$\text{When } y = 0, \frac{3}{3x+4} - 1 = 0$$

$$\frac{3}{3x+4} - 1 = 0$$

$$\frac{3}{3x+4} = 1$$

$$3x + 4 = 3$$

$$x = -\frac{1}{3}$$

The equation of the asymptotes are

$$x = -\frac{4}{3} \text{ and } y = -1.$$

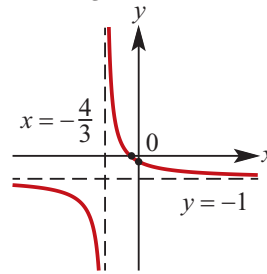

$$5 \text{ RHS} = \frac{4}{x-1} + 1$$

$$= \frac{4+x-1}{x-1}$$

$$= \frac{x+3}{x-1}$$

$$= \text{LHS}$$

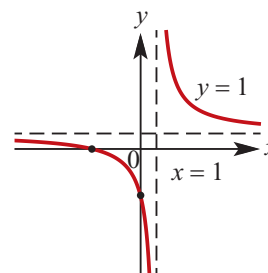

$$\begin{aligned}
 \mathbf{6} \quad \text{RHS} &= \frac{1}{x+1} + 2 \\
 &= \frac{1 + 2(x+1)}{x+1} \\
 &= \frac{2x+3}{x+1} \\
 &= \text{LHS}
 \end{aligned}$$

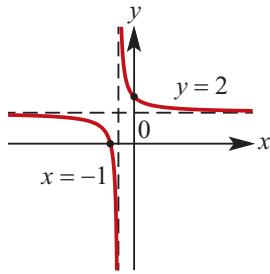

$$\begin{aligned}
 \text{RHS} &= -\frac{1}{x-2} - 2 \\
 &= \frac{-1 - 2(x-2)}{x-2} \\
 \mathbf{7} \quad &= \frac{-1 - 2x + 4}{x-2} \\
 &= \frac{3 - 2x}{x-2} \\
 &= \text{LHS}
 \end{aligned}$$

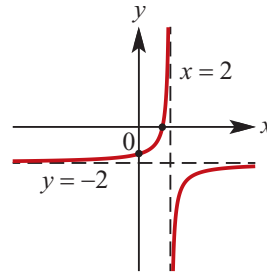

Solutions to Exercise 4B

1 a $y = \frac{1}{(x+3)^2}$
 Asymptotes at $x = -3$ and $y = 0$
 y-intercept where $y = \frac{1}{(0+3)^2} = \frac{1}{9}$

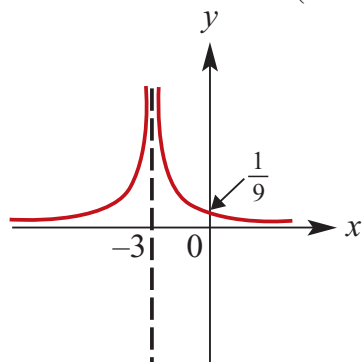

b $y = \frac{1}{x^2} - 4$
 Asymptotes at $x = -3$ and $y = 0$
 x-intercept where $y = \frac{1}{x^2} - 4 = 0$
 $\therefore x^2 = \frac{1}{4}, \therefore x = \pm \frac{1}{2}$

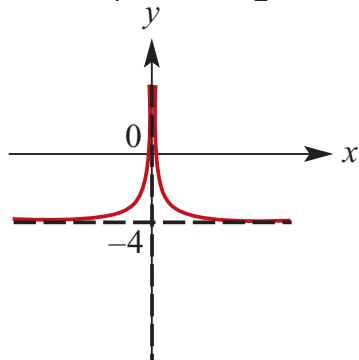

c $y = -\frac{1}{(x-2)^2}$
 Asymptotes at $x = 2$ and $y = 0$
 y-intercept where $y = -\frac{1}{(0-2)^2} = -\frac{1}{4}$

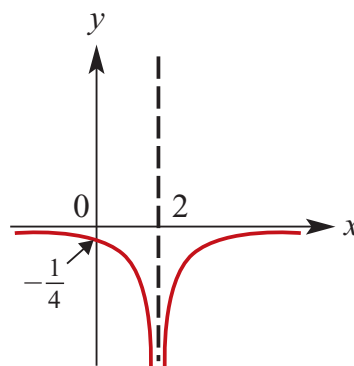

d $y = \frac{1}{(x-1)^2} + 3$
 Asymptotes at $x = 1$ and $y = 3$
 No x-intercepts: $\frac{1}{(x-1)^2} + 3 > 0$ for all x
 y-intercept where $y = \frac{1}{(0-1)^2} + 3 = 4$

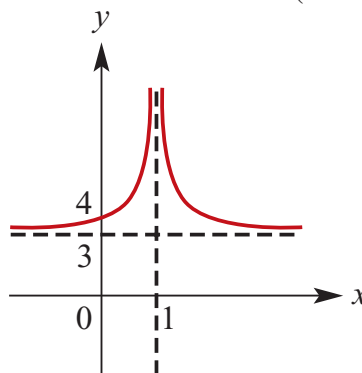

e $y = \frac{1}{2(x+3)^2} - 4$
 Asymptotes at $x = -3$ and $y = -4$
 x-intercepts: $y = \frac{1}{2(x+3)^2} - 4 = 0$
 $\therefore \frac{1}{(x+3)^2} = 8$
 $\therefore x+3 = \pm \frac{1}{4}\sqrt{2}$
 $\therefore x = -3 \pm \frac{1}{4}\sqrt{2}$
 y-intercept at $\frac{1}{2(0+3)^2} - 4 = -\frac{71}{18}$

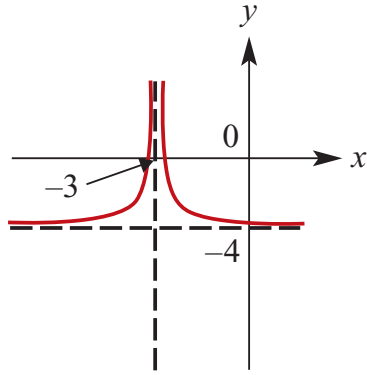

f $y = -\frac{2}{(x-2)^2} + 1$
 Asymptotes at $x = 2$ and $y = 1$
 x-intercepts: $y = -\frac{2}{(x-2)^2} + 1 = 0$
 $\therefore \frac{1}{(x-2)^2} = \frac{1}{2}$
 $\therefore x - 2 = \pm \sqrt{2}$
 $\therefore x = 2 \pm \sqrt{2}$
 y-intercept at $-\frac{2}{(0-2)^2} + 1 = \frac{1}{2}$

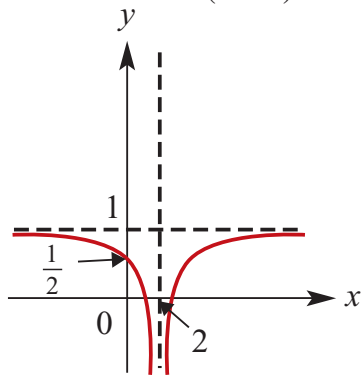

g $y = \frac{3}{(x+3)^2} - 6$
 Asymptotes at $x = -3$ and $y = -6$
 x-intercepts: $y = \frac{3}{(x+3)^2} - 6 = 0$
 $\therefore \frac{1}{(x+3)^2} = 2$
 $\therefore x + 3 = \frac{\pm \sqrt{2}}{2}$
 $\therefore x = -3 \pm \frac{\sqrt{2}}{2}$

y-intercept at $\frac{3}{(0+3)^2} - 6 = -\frac{17}{3}$

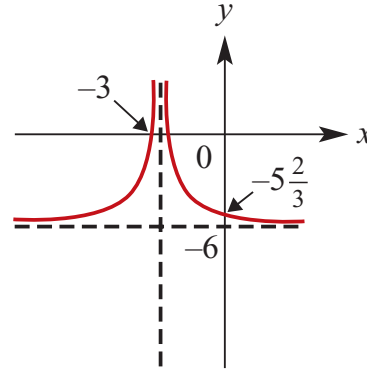

h $y = -\frac{1}{(x-4)^2} + 2$
 Asymptotes at $x = 4$ and $y = 2$
 x-intercepts: $y = -\frac{1}{(x-4)^2} + 2 = 0$
 $\therefore \frac{1}{(x-4)^2} = 2$
 $\therefore x - 4 = \pm \frac{\sqrt{2}}{2}$
 $\therefore x = 4 \pm \frac{\sqrt{2}}{2}$
 y-intercept at $-\frac{1}{(0-4)^2} + 2 = \frac{31}{16}$

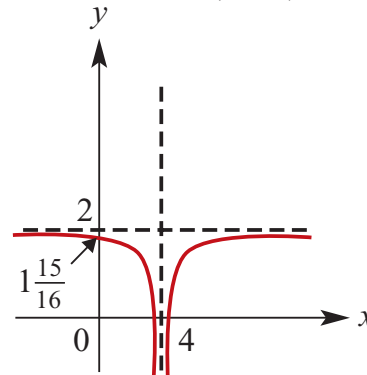

2 Answers given in Question 1.

3 a When $x = 0, y = \frac{1}{36}$
 Asymptotes at $x = -2$ and $y = 0$

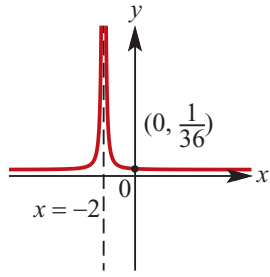

- b** When $x = 0, y = \frac{3}{16}$
Asymptotes at $x = -2$ and $y = 0$

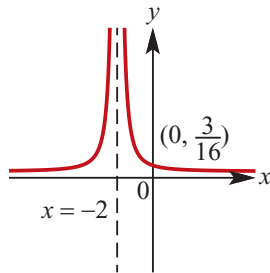

- c** When $x = 0, y = -\frac{1}{16}$
Asymptotes at $x = -2$ and $y = 0$

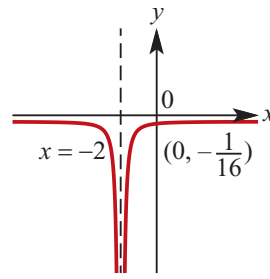

Solutions to Exercise 4C

- 1 a** $y = 2\sqrt{x} + 3$; $\{x: x \geq 0\}$
 No x -intercept; y -intercept at $(0,3)$
 y is defined for $\{y: y \geq 3\}$

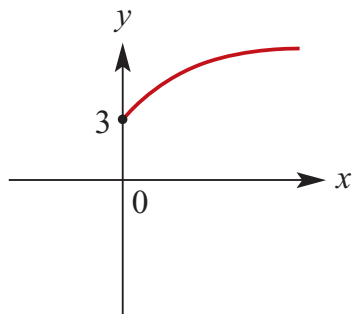

- b** $y = \sqrt{x-2} + 3$; $\{x: x \geq 2\}$
 No axis intercepts
 y is defined for $\{y: y \geq 3\}$
 Starting point at $(2,3)$

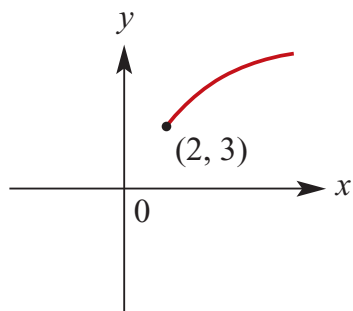

- c** $y = \sqrt{x-2} - 3$; $\{x: x \geq 2\}$
 x intercept where $\sqrt{x-2} - 3 = 0$
 $\therefore \sqrt{x-2} = 3$
 $\therefore x - 2 = 9$
 $\therefore x = 11$
 x -intercept at $(11,0)$; no y -intercept.
 y is defined for $\{y: y \geq -3\}$
 Starting point at $(2, -3)$

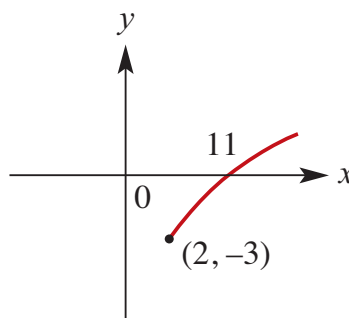

- d** $y = \sqrt{x+2} + 1$; $\{x: x \geq -2\}$
 x -intercept at $(1 + \sqrt{2}, 0)$; no y -intercept.
 y is defined for $\{y: y \geq 1\}$
 Starting point at $(-2, 1)$

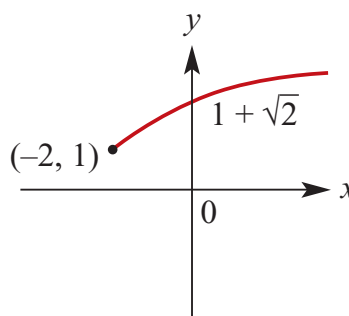

- e** $y = -\sqrt{x+2} + 3$; $\{x: x \geq -2\}$
 y -intercept at $(3 - \sqrt{2}, 0)$
 x -intercept where $-\sqrt{x+2} + 3 = 0$
 $\therefore \sqrt{x+2} = 3$
 $\therefore x + 2 = 9$
 $\therefore x = 7$
 x -intercept at $(7, 0)$
 Starting point at $(-2, 3)$
 y defined for $\{y: y \leq 3\}$

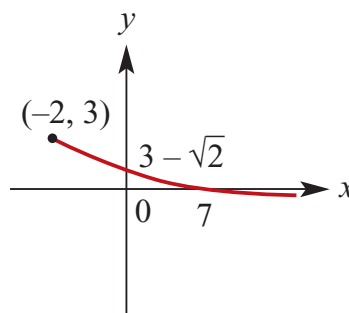

f $y = 2\sqrt{x+2} - 3; \{x: x \geq -2\}$
 y-intercept at $(3 - 2\sqrt{2}, 0)$
 x-intercept where $2\sqrt{x+2} - 3 = 0$
 $\therefore \sqrt{x+2} = \frac{3}{2}$

$\therefore x + 2 = \frac{9}{4}$

$\therefore x = \frac{1}{4}$

x-intercept at $(\frac{1}{4}, 0)$

Starting point at $(-2, -3)$

y defined for $\{y: y \geq -3\}$

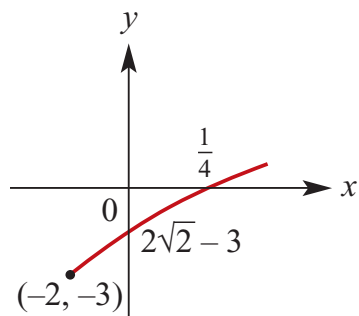

2 a $y = -\sqrt{x-2} + 3; \{x: x \geq 2\}$

No y-intercept;

x-intercept where $-\sqrt{x-2} + 3 = 0$

$\therefore \sqrt{x-2} = 3$

$\therefore x - 2 = 9$

$\therefore x = 11$

x intercept at $(11, 0)$

Starting point at $(2, 3)$

y defined for $\{y: y \leq 3\}$

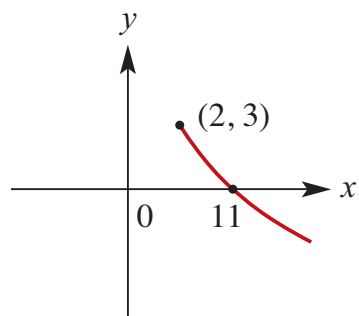

b $y = \sqrt{-(x-4)} - 2; \{x: x \leq 4\}$
 y-intercept at $(0, 0)$

x-intercept where $\sqrt{-(x-4)} - 2 = 0$

$\therefore \sqrt{-(x-4)} = 2$

$\therefore -(x-4) = 4$

$\therefore x = 0$

x-intercept at $(0, 0)$

Starting point at $(4, -2)$

y defined for $\{y: y \geq -2\}$

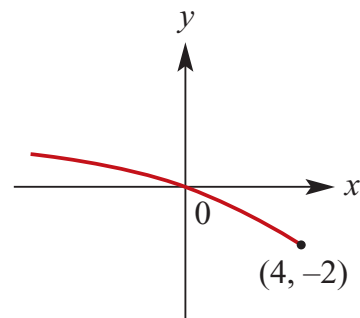

c $y = -2\sqrt{-(x+4)} - 1; \{x: x \leq -4\}$

No axis intercepts.

Starting point at $(-4, -1)$

y defined for $\{y: y \leq -1\}$

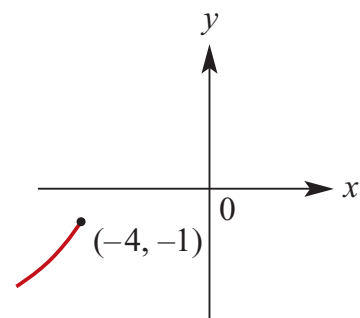

d $y = 2\sqrt{3-x}$

When $x = 0, y = 2\sqrt{3}$

When $y = 0, x = 3$

Starting point at $(3, 0)$

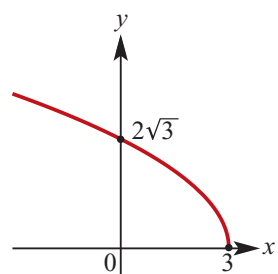

e $y = -2\sqrt{3-x}$

When $x = 0, y = -2\sqrt{3}$

When $y = 0, x = 3$

Starting point at $(3, 0)$

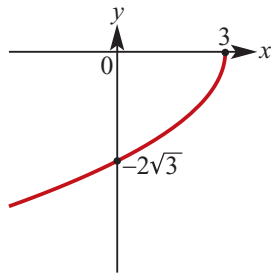

f $y = 4\sqrt{3-x} - 4$

When $x = 0, y = 4\sqrt{3} - 4$

When $y = 0, x = 2$

Starting point at $(3, -4)$

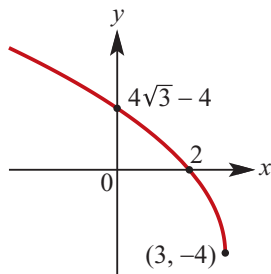

3 a $y = \sqrt{3x}$

y -values $y \geq 0$

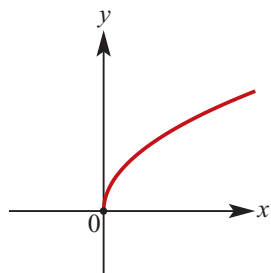

b $y = \sqrt{3(x-1)}$

Graph of $y = \sqrt{3x}$ translated 1 unit in the positive direction of the x -axis.

x -axis intercept is $(1, 0)$ y -values

$y \geq 0$

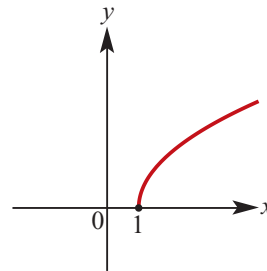

c $y = -\sqrt{2x}$

y -values $y \leq 0$

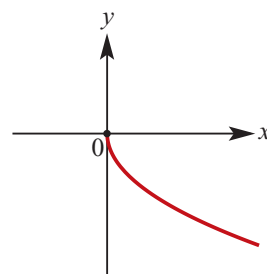

d $y = -\sqrt{2(3-x)}$

The graph of $y = -\sqrt{-2x}$ translated 3 units in the positive direction of the x -axis

x -axis intercept $(3, 0)$

y -axis intercept $(0, \sqrt{6})$

y -values $y \geq 0$

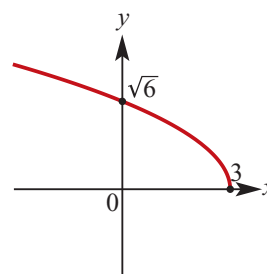

e $y = -2\sqrt{4(2-x)}$

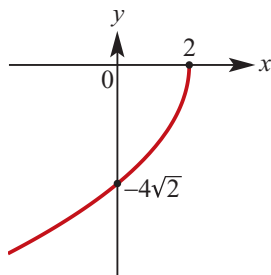

f $y = 4\sqrt{2(3-x)} - 4$

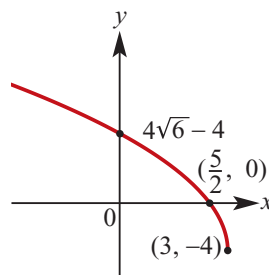

Solutions to Exercise 4D

1 a $C(0, 0), r = 3 \therefore x^2 + y^2 = 9$

b $C(0, 0), r = 4 \therefore x^2 + y^2 = 16$

c $C(1, 3), r = 5$
 $\therefore (x - 1)^2 + (y - 3)^2 = 25$

d $C(2, -4), r = 3$
 $\therefore (x - 2)^2 + (y + 4)^2 = 9$

e $C(-3, 4), r = \frac{5}{2}$
 $\therefore (x + 3)^2 + (y - 4)^2 = \frac{25}{4}$

f $C(-5, -6), r = 4.6$
 $\therefore (x + 5)^2 + (y + 6)^2 = 4.6^2$

2 a $(x - 1)^2 + (y - 3)^2 = 4$
 $C(1, 3), r = \sqrt{4} = 2$

b $(x - 2)^2 + (y + 4)^2 = 5$
 $C(2, -4), r = \sqrt{5}$

c $(x + 3)^2 + (y - 2)^2 = 9$
 $C(-3, 2), r = \sqrt{9} = 3$

d $(x + 5)^2 + (y - 4)^2 = 8$
 $C(-5, 4), r = \sqrt{8} = 2\sqrt{2}$

3 a $x^2 + y^2 = 64$
 x -intercepts at $(\pm 8, 0)$
 y -intercepts at $(0, \pm 8)$

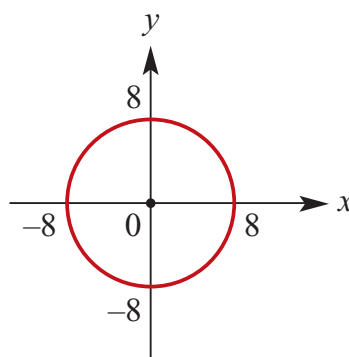

b $x^2 + (y - 4)^2 = 9$
 No x -intercepts,
 y -intercepts at $(0, 1)$ and $(0, 7)$

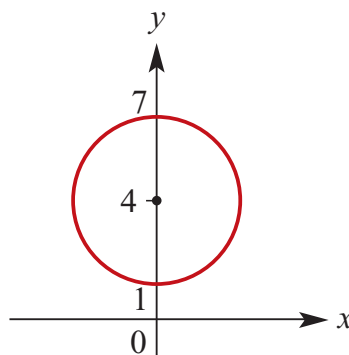

c $(x + 2)^2 + y^2 = 25$
 x -intercepts at $(3, 0)$ and $(-7, 0)$

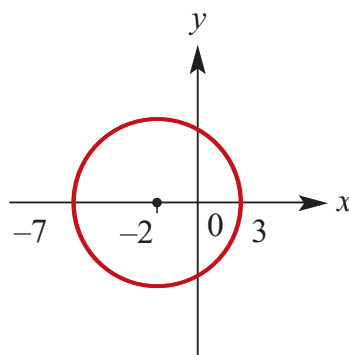

d $(x + 1)^2 + (y - 4)^2 - 169 = 0$
 Centre at $(-1, 4)$, radius 13

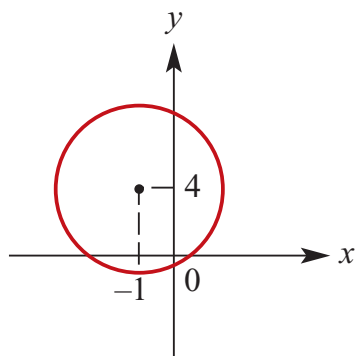

e $(2x - 3)^2 + (2y - 5)^2 = 36$
Centre at $(\frac{3}{2}, \frac{5}{2})$, radius 6

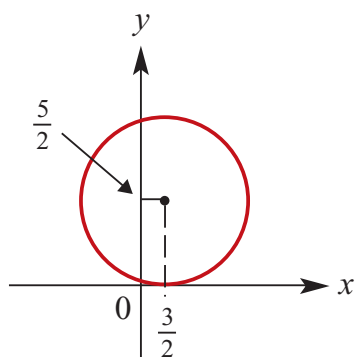

f $(x + 5)^2 + (y - 5)^2 = 36$
Centre at $(-5, 5)$, radius 6
 x -intercepts at $(-5 + \sqrt{11}, 0)$ and $(-5 - \sqrt{11}, 0)$
 y -intercepts at $(5 + \sqrt{11}, 0)$ and $(5 - \sqrt{11}, 0)$

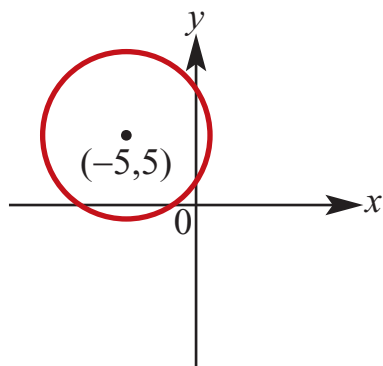

4 a $x^2 + y^2 - 6y - 16 = 0$
 $\therefore x^2 + y^2 - 6y + 9 - 9 - 16 = 0$
 $\therefore x^2 + (y - 3)^2 - 25 = 0$
 $\therefore x^2 + (y - 3)^2 = 25$
 $C(0, 3), r = \sqrt{25} = 5$

b $x^2 + y^2 - 8x + 12y + 10 = 0$
 $\therefore x^2 - 8x + 16 + y^2 + 12y + 36 = 42$
 $\therefore (x - 4)^2 + (y + 6)^2 = 25$

$C(4, -6), r = \sqrt{42}$

c $x^2 + y^2 - 6x + 4y + 9 = 0$
 $\therefore x^2 - 6x + y^2 + 4y + 9 = 0$
 $\therefore x^2 - 6x + 9 + y^2 + 4y + 4 - 4 = 0$

$\therefore (x - 3)^2 + (y + 2)^2 = 0$
 $C(3, -2), r = \sqrt{4} = 2$

d $x^2 + y^2 + 4x - 6y - 12 = 0$
 $\therefore x^2 + 4x + 4 + y^2 - 6y + 9 - 12 - 4 - 9 = 0$
 $\therefore (x + 2)^2 + (y - 3)^2 - 25 = 0$
 $\therefore (x + 2)^2 + (y - 3)^2 = 25$
 $C(-2, 3), r = \sqrt{25} = 5$

e $x^2 + y^2 - 8x + 4y + 1 = 0$
 $\therefore x^2 - 8x + 16 + y^2 + 4y + 4 + 1 - 20 = 0$
 $\therefore (x - 4)^2 + (y + 2)^2 = 19$
 $C(4, -2), r = \sqrt{19}$

f $x^2 + y^2 - x + 4y + 2 = 0$
 $\therefore x^2 - x + \frac{1}{4} + y^2 + 4y + 4 = 2 + \frac{1}{4}$
 $\therefore (x - \frac{1}{2})^2 + (y + 2)^2 = \frac{9}{4}$
 $C(\frac{1}{2}, -2), r = \frac{3}{2}$

- 5 a** $x^2 + y^2 - 6y - 16 = 0$
 $\therefore x^2 + (y - 3)^2 = 25$
 Centre at (0,3), radius 5

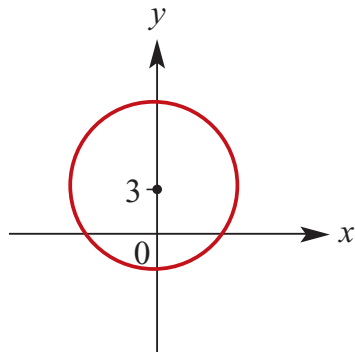

- b** $x^2 + y^2 + 4x - 6y - 3 = 0$
 $\therefore (x + 2)^2 + (y - 3)^2 = 16$
 Centre at (-2, 3), radius 4

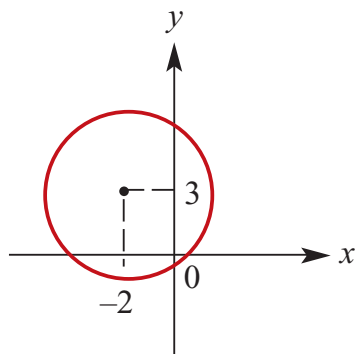

- c** $x^2 + y^2 - 8x + 22y + 27 = 0$
 $\therefore (x - 4)^2 + (y + 11)^2 = 110$
 No axis intercepts
 Centre (4, -11), radius $\sqrt{110}$

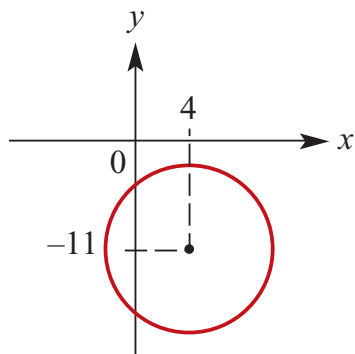

- 6 a** $y = +\sqrt{9 - x^2}$

Starting points at $(\pm 3, 0)$

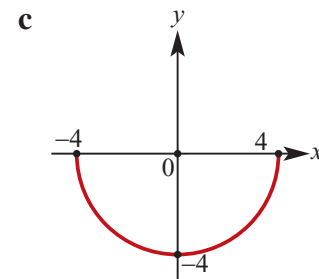
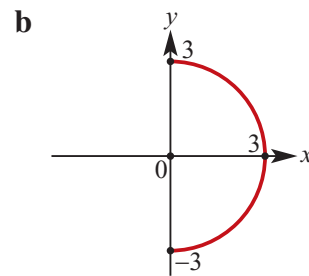
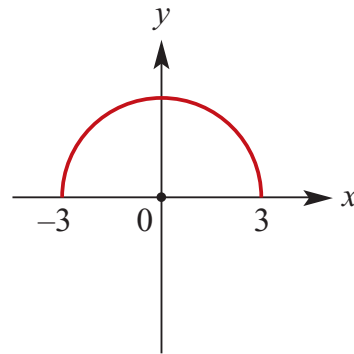

- d** $y = -\sqrt{25 - x^2}$
 Starting points at $(\pm 5, 0)$

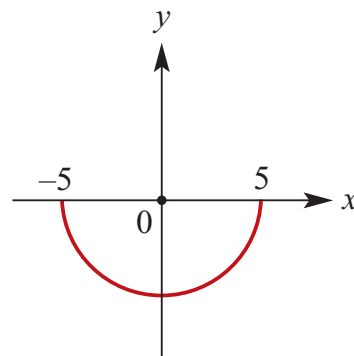

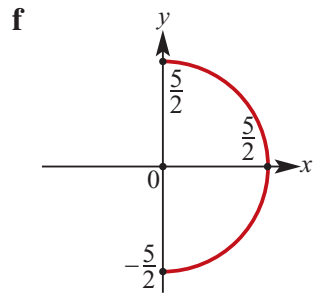
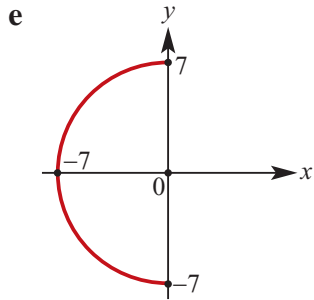

- 7 a** $y = \sqrt{36 - (x - 2)^2}$
 Starting points at $(-4, 0)$ and $(8, 0)$
 Centre at $(2, 0)$

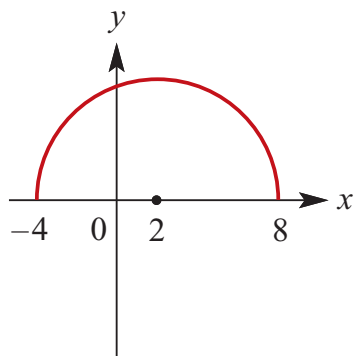

- b** $y - 2 = \sqrt{4 - (x + 2)^2}$
 Starting points at $(-4, 2)$ and $(0, 2)$
 Centre at $(-2, 2)$

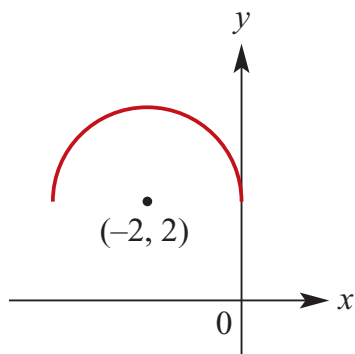

8 a $x^2 + y^2 \leq 4$

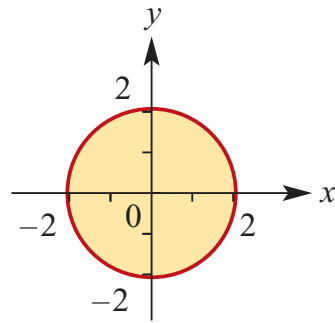

b $x^2 + y^2 > 1$

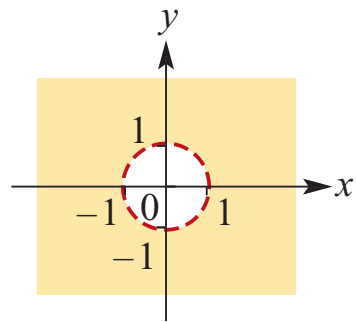

c $x^2 + y^2 \leq 5$

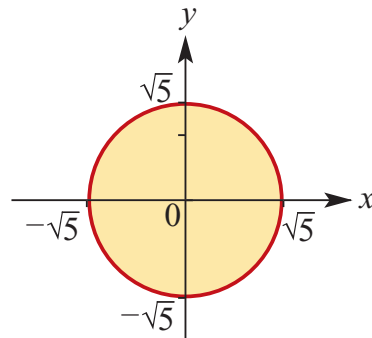

d $x^2 + y^2 > 9$

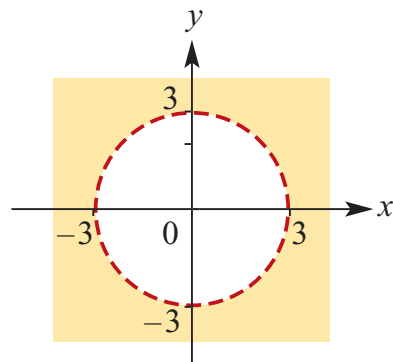

e $x^2 + y^2 \geq 6$

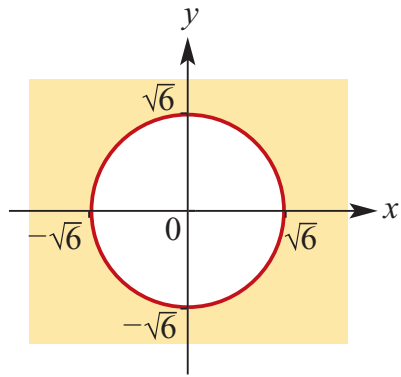

f $x^2 + y^2 < 8$

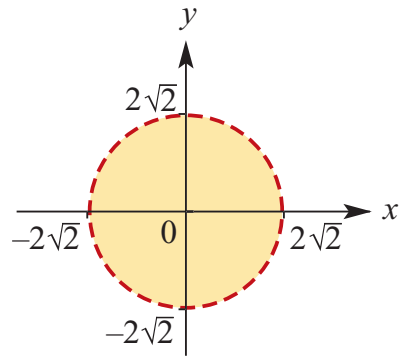

Solutions to Exercise 4E

1 $y = \frac{a}{x} + 3$

Passes through (1, 8)

$$\therefore 8 = a + 3$$

$$\therefore a = 5$$

$$\therefore y = \frac{5}{x} + 3$$

2 $h = 3, k = 4 \therefore y = \frac{a}{x-3} + 4$

Passes through (0, 6)

$$\text{Therefore, } 6 = \frac{a}{-3} + 4$$

$$\therefore a = -6$$

$$\therefore y = -\frac{6}{x-3} + 4$$

3 $y = \frac{a}{x} + k$

When $x = 1, y = 8$

$$\therefore 8 = a + k \dots (1)$$

When $x = -1, y = 7$

$$\therefore 7 = -a + k \dots (2)$$

Add (1) and (2)

$$15 = 2k$$

$$k = \frac{15}{2} \text{ and } a = \frac{1}{2}$$

4 $h = 2, k = -4 \therefore y = \frac{a}{x-2} - 4$

Passes through (0, 4)

$$\text{Therefore, } 4 = \frac{a}{-2} - 4$$

$$\therefore a = -16$$

$$\therefore y = -\frac{16}{x-2} - 4$$

5 $y = a\sqrt{x}$

When $x = 2, y = 8$

$$\therefore 8 = a\sqrt{2}$$

$$\therefore a = \frac{8}{\sqrt{2}} = 4\sqrt{2}$$

6 $y = a\sqrt{x-h}$

When $x = 1, y = 2$

$$\therefore 2 = a\sqrt{1-h} \dots (1)$$

When $x = 10, y = 4$

$$\therefore 4 = a\sqrt{10-h} \dots (2)$$

Divide (2) by (1)

$$2 = \frac{\sqrt{10-h}}{\sqrt{1-h}}$$

$$2\sqrt{1-h} = \sqrt{10-h}$$

Square both sides.

$$4(1-h) = 10-h$$

$$4-4h = 10-h$$

$$3h = -6$$

$$h = -2$$

Substitute in (1)

$$2 = a\sqrt{3}$$

$$a = 2\frac{\sqrt{3}}{3}$$

7 A circle with centre (2,1) has equation:

$$(x-2)^2 + (y-1)^2 = a^2$$

If it passes through (4, -3), then:

$$(4-2)^2 + (-3-1)^2 = a^2$$

$$\therefore 4 + 16 = a^2, \therefore a = \pm 2\sqrt{5}$$

$$(x-2)^2 + (y-1)^2 = 20$$

8 Circle centre (-2, 3) has equation of the form

$$(x+2)^2 + (y-3)^2 = r^2$$

Circle passes through (-3, 3)

Therefore

$$(-3+2)^2 + (3-3)^2 = r^2$$

$$\therefore r = 1 \therefore (x+2)^2 + (y-3)^2 = 1$$

Note: Centre (-2, 3) and passing through (-3, 3) immediately gives you $r = 1$. Think of the horizontal diameter.

9 Again using the simple approach.

The diameter through the circle with centre $(-2, 3)$ and passing through $(2, 3)$ tells us that the radius is 4. Hence the equation is $(x + 2)^2 + (y - 3)^2 = 16$

- 10** A circle with centre $(2, -3)$ has equation:
 $(x - 2)^2 + (y + 3)^2 = a^2$
 If it touches the x -axis, then it must be at $(2, 0)$:
 $\therefore (0 + 3)^2 = a^2, \therefore a = \pm 3$
 $(x - 2)^2 + (y + 3)^2 = 9$

- 11** A circle with centre on the line $y = 4$ has equation: $(x - b)^2 + (y - 4)^2 = a^2$
 If it passes through $(2, 0)$ and $(6, 0)$ then
 $(2 - b)^2 + (0 - 4)^2 = a^2 \dots (1)$
 $(6 - b)^2 + (0 - 4)^2 = a^2 \dots (2)$
 $(2) - (1)$ gives $(6 - b)^2 - (2 - b)^2 = 0$
 $\therefore (36 - 12b + b^2) = (4 - 4b + b^2)$
 $\therefore 32 - 12b = -4b$
 $\therefore 8b = 32, \therefore b = 4$

Substitute into (1):

$$(2 - 4)^2 + (0 - 4)^2 = a^2$$

$$\therefore 4 + 16 = a = 20$$

$$(x - 4)^2 + (y - 4)^2 = 20$$

- 12** It touches the x -axis and has radius 5.
 Let $(a, 5)$ be the centre. It is easy to show it cannot be $(a, -5)$ if it goes through $(0, 8)$.
 We also know that $a^2 + (5 - 8)^2 = 25$.
 $\therefore a = 4$ or $a = -4$

The circle has equation
 $(x - 4)^2 + (y - 5)^2 = 25$ or
 $(x + 4)^2 + (y - 5)^2 = 25$

- 13** The circle has equation of the form
 $x^2 + y^2 + bx + cy + d = 0$
 When $x = 2, y = 0$

$$4 + 2b + d = 0 \dots (1)$$

When $x = -4, y = 0$

$$16 - 4b + d = 0 \dots (2)$$

When $x = 0, y = 2$

$$4 + 2c + d = 0 \dots (3)$$

From (1) and (3)

we see that $c = b$.

Subtract (1) from (2)

$$12 - 6b = 0$$

$$\therefore b = 2 \text{ and } c = 2$$

$$\therefore d = -8$$

The equation is $x^2 + y^2 + 2x + 2y = 8$
 or $(x + 1)^2 + (y + 1)^2 = 10$

- 14 a** $(x - 2)^2 + (y + 2)^2 = 49$

b $y = 3\sqrt{x - 1} - 2$

c $y = \frac{1}{x - 2} + 2$

d $y = -\frac{2}{x - 1} - 2$

e $y = \sqrt{2 - x} + 1$

f $y = \frac{1}{(x - 2)^2} - 3$

Solutions to Technology-free questions

1 a $y = -\frac{3}{x}$; asymptotes at $x = 0$, $y = 0$

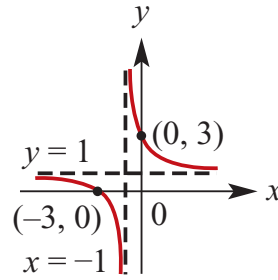
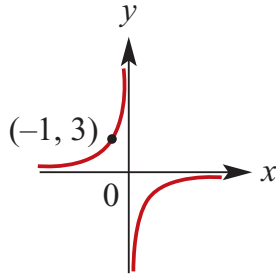

b $y = \frac{2}{x^2}$; asymptotes at $x = 0$, $y = 0$

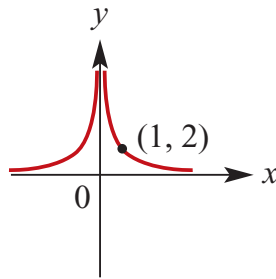

e $y = -\frac{2}{x^2}$; asymptotes at $x = 0$, $y = 0$

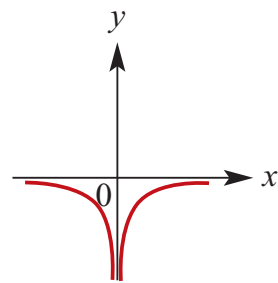

c $y = \frac{1}{x-1}$; asymptotes at $x = 1$, $y = 0$
y-intercept at $(0, -1)$

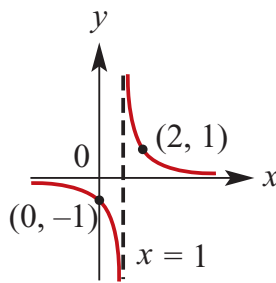

f $y = -\frac{1}{x-1}$; asymptotes at
 $x = 1$, $y = 0$
y-intercept at $(0, 1)$

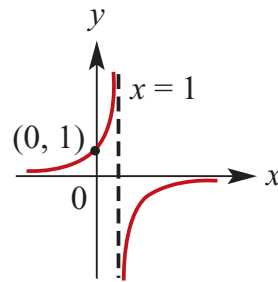

d $y = \frac{2}{x+1} + 1$;
asymptotes at $x = -1$, $y = 1$
x-intercept at $(-3, 0)$
y-intercept at $(0, 3)$

g $y = \frac{4}{2-x} + 3$; asymptotes at
 $x = 2$, $y = 3$
x-intercept: $\frac{4}{2-x} + 3 = 0$
 $\therefore \frac{4}{2-x} = -3$
 $\therefore 4 = -3(2-x)$
 $\therefore 4 = 3x - 6 \therefore x = \frac{10}{3}$
x-intercept at $(\frac{10}{3}, 0)$
y-intercept at $(0, 5)$

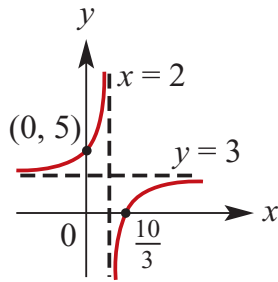

- h** $y = -\frac{3}{x^2} + 1$; asymptotes at $x = 0, y = 1$
 x -intercepts: $y = -\frac{3}{x^2} + 1 = 0$
 $\therefore \frac{3}{x^2} = 1 \therefore x = \pm\sqrt{3}$
 x -intercepts at $(-\sqrt{3}, 0)$ and $(\sqrt{3}, 0)$

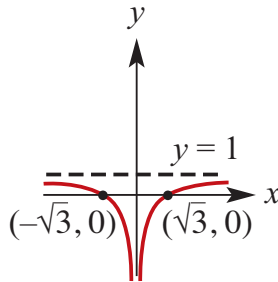

- i** $y = 2\sqrt{x} + 2$
 y -intercept at $(0, 2)$

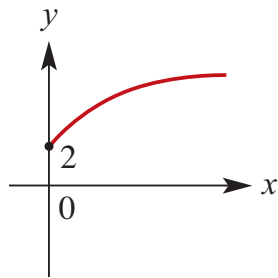

- j** $y = 2\sqrt{x-3} + 2$
Starting point at $(3, 2)$

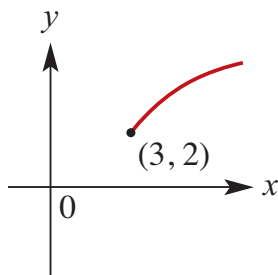

- k** $y = -2\sqrt{x+2} + 2$
Starting point at $(-2, 2)$
 x -intercept: $-2\sqrt{x+2} + 2 = 0$
 $\therefore \sqrt{x+2} = 1$
 $\therefore x + 2 = 1, \therefore x = -1$
 x -intercept at $(-1, 0)$
 y -intercept at $(0, 2 - 2\sqrt{2})$

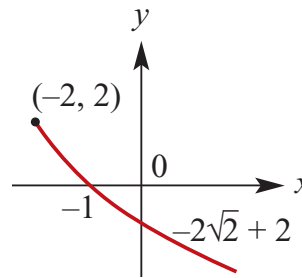

- 2 a** $x^2 + y^2 - 6x + 4y - 12 = 0$
 $\therefore x^2 - 6x + 9 + y^2 + 4y + 4 - 12 = 13$
 $\therefore (x-3)^2 + (y+2)^2 = 5^2$

- b** $x^2 + y^2 - 3x + 5y - 4 = 0$
 $\therefore x^2 - 3x + \frac{9}{4} + y^2 + 5y + \frac{25}{4} = 4 + \frac{34}{4}$
 $\therefore \left(x - \frac{3}{2}\right)^2 + \left(y + \frac{5}{2}\right)^2 = \frac{50}{4}$
 $\therefore \left(x - \frac{3}{2}\right)^2 + \left(y + \frac{5}{2}\right)^2 = \left(\frac{5\sqrt{2}}{2}\right)^2$

- c** $2x^2 + 2y^2 - x + y - 4 = 0$
 $\therefore x^2 + y^2 - \frac{x}{2} + \frac{y}{2} = 2$
 $\therefore x^2 - \frac{x}{2} + \frac{1}{16} + y^2 + \frac{y}{2} + \frac{1}{16} = 2 + \frac{1}{8}$
 $\therefore \left(x - \frac{1}{4}\right)^2 + \left(y + \frac{1}{4}\right)^2 = \frac{17}{8}$
 $\therefore \left(x - \frac{1}{4}\right)^2 + \left(y + \frac{1}{4}\right)^2 = \left(\frac{\sqrt{34}}{4}\right)^2$

d $x^2 + y^2 + 4x - 6y = 0$
 $\therefore x^2 + 4x + 4 + y^2 - 6y + 9 = 13$
 $\therefore (x + 2)^2 + (y - 3)^2 = (\sqrt{13})^2$

e $x^2 + y^2 = 6(x + y)$
 $\therefore x^2 - 6x + 9 + y^2 - 6y + 9 = 18$
 $\therefore (x - 3)^2 + (y - 3)^2 =$
 $(\sqrt{18})^2 = (3\sqrt{2})^2$

f $x^2 + y^2 = 4x - 6y$
 $\therefore x^2 - 4x + 4 + y^2 + 6y + 9 = 13$
 $\therefore (x - 2)^2 + (y + 3)^2 = (\sqrt{13})^2$

3 $x^2 + y^2 - 4x + 6y = 14$
 $\therefore x^2 - 4x + 4 + y^2 + 6y + 9 = 14 + 13$
 $\therefore (x - 2)^2 + (y + 3)^2 = 27$

A diameter must pass through the centre of the circle at $(2, -3)$.

A line connecting $(0,0)$ with $(2, -3)$ has gradient $= -\frac{3}{2}$, hence the equation

$y = -\frac{3x}{2}$ or $3x + 2y = 0$

4 $x^2 + y^2 - 3x + 2y = 26$
 $\therefore x^2 - 3x + \frac{9}{4} + y^2 + 2y + 1 = 26 + \frac{13}{4}$
 $\therefore \left(x - \frac{3}{2}\right)^2 + (y + 1)^2 = \frac{117}{4}$

Centre of circle is at $\left(\frac{3}{2}, -1\right)$.

Diameter of the circle which cuts the x -axis at 45° has gradient $= 1$.

$\therefore y - (-1) = x - \frac{3}{2}$

$y = x - \frac{5}{2}$

Or $2x + 2y = 1$ if the diameter goes below the axis at an angle of -45° . In this case the gradient $= -1$.

5 a $C(3, 4), r = 5$
 $\therefore (x - 3)^2 + (y - 4)^2 = 25$

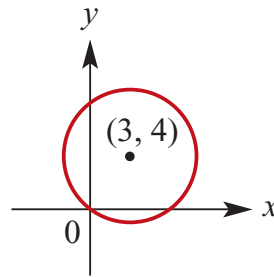

b $C(-1, 0), r = 1$
 $\therefore (x + 1)^2 + y^2 = 1$

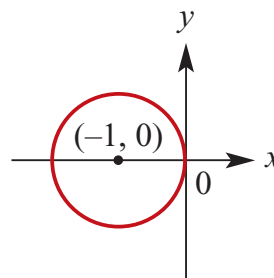

c $C(4, 4), r = 2$
 $\therefore (x - 4)^2 + (y - 4)^2 = 4$

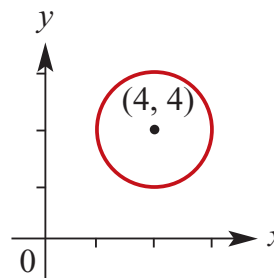

d $C\left(\frac{1}{2}, -\frac{1}{3}\right), r = \frac{1}{6}$
 $\therefore \left(x - \frac{1}{2}\right)^2 + \left(y + \frac{1}{3}\right)^2 = \frac{1}{36}$

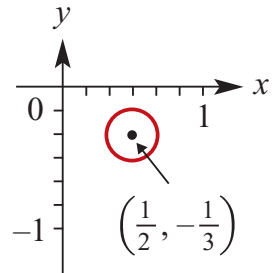

6

$$x^2 + y^2 + 4x - 6y = 23$$

$$x^2 + 4x + 4 + y^2 - 6y + 9 = 23 + 4 + 9$$

$$(x + 2)^2 + (y - 3)^2 = 36$$

Centre: $(-2, 3)$ Radius: 6

7 $x^2 + y^2 - 2x - 4y = 20$
 $\therefore x^2 - 2x + 1 + y^2 - 4y + 4 = 25$
 $\therefore (x - 1)^2 + (y - 2)^2 = 5^2$

Length cut off on the x -axis and y -axis =
distance between x - and y -intercepts:

$y = 0: \therefore (x - 1)^2 + (0 - 2)^2 = 5^2$
 $\therefore (x - 1)^2 = 21, \therefore x = 1 \pm \sqrt{21}$
 x -axis length = $2\sqrt{21}$
 $x = 0: \therefore (0 - 1)^2 + (y - 2)^2 = 5^2$
 $\therefore (y - 2)^2 = 24, \therefore y = 2 \pm 2\sqrt{6}$
 y -axis length = $4\sqrt{6}$

8 a $y = \sqrt{9 - x^2}$
 x -intercepts at $(-3, 0)$ and $(3, 0)$
 y -intercept at $(0, 3)$

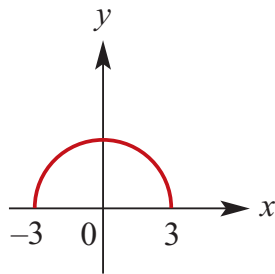

b $y = -\sqrt{16 - (x + 1)^2}$

Starting points at $(-5, 0)$ and $(3, 0)$
 y -intercept at $(0, -\sqrt{15})$, centre at $(-1, 0)$

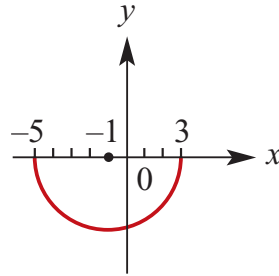

c $y - 2 = -\sqrt{1 - x^2}$
No x -intercepts, y -intercept at $(0, 1)$
Centre at $(0, 2)$

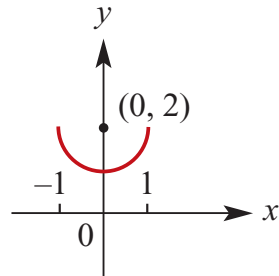

d $y + 3 = \sqrt{4 - (x + 2)^2}$
No x -intercepts, y -intercept at $(0, -3)$
Centre at $(-2, 3)$

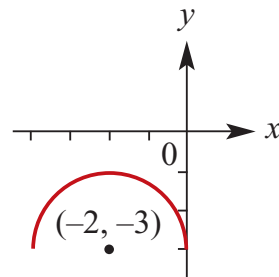

Solutions to multiple-choice questions

- 1 E** $(x - a)^2 + (y - b)^2 = 36$
 Centre on the x -axis so $b = 0$
 Using $(6,6)$: $(6 - a)^2 + 6^2 = 36$
 $\therefore a = 6$
- 2 B** $y = 5 - \frac{1}{3x - 5}$ has asymptotes at
 $y = 5$ and $3x - 5 = 0$
 $\therefore x = \frac{5}{3}$
- 3 E** $y = \frac{5}{x^2} + 3$
 If $x = \frac{a}{2}$,
 $y = \frac{5}{(a/2)^2} + 3 = \frac{20}{a^2} + 3$
- 4 A** $(x - a)^2 + (y - b)^2 = c^2$
 y -axis is an axis of symmetry so
 $a = 0$ Using $(0,0)$:
 $(-b)^2 = c^2, \therefore b = c; c > 0$
 Using $(0,4)$:
 $(4 - b)^2 = b^2, \therefore b = 2$
 $\therefore x^2 + (y - 2)^2 = 4$
- 5 A** $y = 5 + \frac{1}{(x - 2)^2}$ has asymptotes
 at $y = 5$ and $x = 2$
- 6 D** $(x - 5)^2 + (y + 2)^2 = 9$
 $C(5, -2), r = \sqrt{9} = 3$
- 7 D** $y = -2\sqrt{x} + 3; x \geq 0$
 $-2\sqrt{x} \leq 0 \therefore y \leq 3$
- 8 C** Circle end points at $(-2, 8)$ and
 $(6,8)$;
 centre is at $x = \frac{-2 + 6}{2} = 2$ and
 $y = 8$.
 Radius $= 6 - 2 = 4$
 $(x - 2)^2 + (y - 8)^2 = 4^2$
- 9 E** Only $y^2 = 16 - x^2$ has the general
 form with $(x - a)^2 + (y - b)^2 = c^2$
- 10 B** **A** is a full circle, **B** is correct, **C**
 isn't circular, and **D** and **E** are
 negatives.

Solutions to extended-response questions

1 a The circle has centre (10, 0) and radius 5 and therefore has the equation $(x - 10)^2 + y^2 = 25$.

b The line with equation $y = mx$ meets the circle with equation $(x - 10)^2 + y^2 = 25$.

Therefore x satisfies the equation $(x - 10)^2 + (mx)^2 = 25$

Expanding and rearranging gives $x^2 - 20x + 100 + m^2x^2 = 25$

and therefore $(1 + m^2)x^2 - 20x + 75 = 0$

c The discriminant is $\Delta = 400 - 4 \times 75 \times (1 + m^2)$
 $= 400 - 300(1 + m^2)$
 $= 100 - 300m^2$

As the line is a tangent to the circle, there is only one point of contact and hence only one solution to the equation obtained in part **b**. Therefore the discriminant = 0, which implies

$$m = \pm \frac{1}{\sqrt{3}} = \pm \frac{\sqrt{3}}{3}$$

d When $m^2 = \frac{1}{3}$, the equation $(1 + m^2)x^2 - 20x + 75 = 0$ becomes

$$\frac{4}{3}x^2 - 20x + 75 = 0$$

Multiplying both sides of the equation by 3 gives

$$4x^2 - 60x + 225 = 0$$

The left-hand side is a perfect square and hence

$$(2x - 15)^2 = 0$$

The solution is $x = \frac{15}{2}$

The y -coordinate is given by substituting into $y = mx = \pm \frac{\sqrt{3}}{3}x$.

$$y = \pm \frac{\sqrt{3}}{3} \times \frac{15}{2}$$
$$= \pm \frac{5\sqrt{3}}{2}$$

The coordinates of P are $\left(\frac{15}{2}, \pm \frac{5\sqrt{3}}{2}\right)$.

$$\begin{aligned}
 \text{e Distance of } P \text{ from the origin} &= \sqrt{\left(\frac{15}{2}\right)^2 + \left(\frac{5\sqrt{3}}{2}\right)^2} \\
 &= \frac{1}{2} \sqrt{225 + 75} \\
 &= 5\sqrt{3}
 \end{aligned}$$

2 a The circle has centre the origin and radius 4.

Hence the equation is $x^2 + y^2 = 16$.

b i The general form for a straight line is $y = mx + c$.

When $x = 8$, $y = 0$, hence $0 = 8m + c$ and $c = -8m$.

So the tangents have equations of the form $y = mx - 8m$

ii As in Question 1, consider when the line with equation $y = mx - 8m$ meets the circle $x^2 + y^2 = 16$.

Substitute for y : $(mx - 8m)^2 + x^2 = 16$

Expand and collect like terms to obtain

$$(m^2 + 1)x^2 - 16m^2x + 64m^2 - 16 = 0$$

There will be a tangent when the discriminant is equal to 0, i.e. when there is only one solution.

$$\begin{aligned}
 \Delta &= 256m^4 - 4(m^2 + 1)(64m^2 - 16) \\
 &= 256m^4 - 4(64m^4 + 48m - 16) \\
 &= -4(48m^2 - 16) \\
 &= 64(-3m^2 + 1)
 \end{aligned}$$

Thus there is a tangent if $3m^2 = 1$

i.e.
$$m = \pm \frac{1}{\sqrt{3}} = \pm \frac{\sqrt{3}}{3}$$

Since $y = mx - 8m$, is the equations of the tangents

$$y = \frac{\sqrt{3}}{3}x - \frac{8\sqrt{3}}{3}$$

and
$$y = -\frac{\sqrt{3}}{3}x + \frac{8\sqrt{3}}{3}$$

- 3 a** The gradient of $OP = \frac{4}{3}$.
- b** The tangent is perpendicular to the radius and therefore has gradient of $-\frac{3}{4}$.
- c** The equation of the tangent is given by
- $$y - 4 = -\frac{3}{4}(x - 3)$$

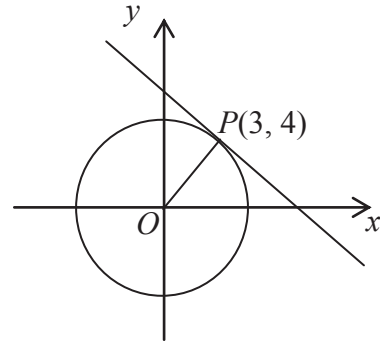

Therefore $4y - 16 = -3x + 9$
and $4y + 3x = 25$

- d** The coordinates of A are $(\frac{25}{3}, 0)$ and the coordinates of B are $(0, \frac{25}{4})$.

$$\begin{aligned} AB^2 &= \left(\frac{25}{3}\right)^2 + \left(\frac{25}{4}\right)^2 \\ &= 625\left(\frac{1}{9} + \frac{1}{16}\right) = 625 \times \frac{25}{9 \times 16} \end{aligned}$$

Therefore $AB = \frac{25 \times 5}{12} = \frac{125}{12}$

- 4 a i** The radius has gradient $\frac{y_1}{x_1}$.
- ii** The tangent is perpendicular to radius, so using $m_1, m_2 = -1$, it has the gradient $-\frac{x_1}{y_1}$.

b The equation of the tangent is given by $y - y_1 = -\frac{x_1}{y_1}(x - x_1)$

Multiply both sides by y_1 $yy_1 - y_1^2 = -x_1x + x_1^2$

Therefore $yy_1 + x_1x = x_1^2 + y_1^2$

But (x_1, y_1) is a point on the circle and hence $x_1^2 + y_1^2 = a^2$

This gives $x_1x + y_1y = a^2$

- c** If $x_1 = y_1$ and $a = 4$, then $x_1^2 + y_1^2 = a^2$ becomes $2x_1^2 = 16$.

Thus $x_1 = \pm 2\sqrt{2}$

The equations of the tangents are $\sqrt{2}x + \sqrt{2}y = 8$ and

$-\sqrt{2}x - \sqrt{2}y = 8$ or $\sqrt{2}x + \sqrt{2}y = -8$.

- 5 a Note that the triangle is equilateral, and that $AX = AY = XB = YC = CZ = ZB$, as these line segments are equal tangents from a point.

Let these equal lengths be b .

$$\begin{aligned} \text{Then } AZ^2 &= AB^2 - BZ^2 \\ &= 4b^2 - b^2 = 3b^2 \end{aligned}$$

(Pythagoras' theorem in triangle AZB)

$$\text{Therefore } AZ = \sqrt{3}b$$

$$\text{The gradient of line } BA = -\frac{1}{\sqrt{3}}$$

$$\text{and the gradient of } CA = \frac{1}{\sqrt{3}}.$$

Note also that triangle BZA is similar to triangle AXO .

$$\text{Therefore } \frac{OX}{AX} = \frac{BZ}{AZ}$$

$$\text{Therefore } \frac{a}{b} = \frac{b}{\sqrt{3}b} = \frac{1}{\sqrt{3}} \quad \text{and} \quad b = \sqrt{3}a$$

For line BA : when $x = -a$, $y = \sqrt{3}a$ and, using the form $y = mx + c$,

$$\sqrt{3}a = -\frac{1}{\sqrt{3}} \times -a + c$$

$$\therefore c = \sqrt{3}a - \frac{a}{\sqrt{3}}$$

$$= \frac{2\sqrt{3}a}{3}$$

Therefore the equation of line BA is $y = -\frac{\sqrt{3}}{3}x + \frac{2\sqrt{3}a}{3}$

$$\text{For line } CA: \quad y = \frac{\sqrt{3}}{3}x - \frac{2\sqrt{3}a}{3}$$

- b The circumcentre has centre O and radius OA . But, from the equation of BA , A has coordinates $(2a, 0)$. Hence the equation of the circle is $x^2 + y^2 = 4a^2$.

- 6 a If (a, a) lies on the line $y = x$ and on the curve with equation $y = \sqrt{x-b} + c$,

$$\text{then} \quad a = \sqrt{a-b} + c$$

$$\text{Subtract } c \text{ from both sides and square} \quad (a-c)^2 = a-b$$

$$\text{Expand and rearrange} \quad a^2 - 2ac + c^2 = a-b$$

$$a^2 - (2c+1)a + c^2 + b = 0$$

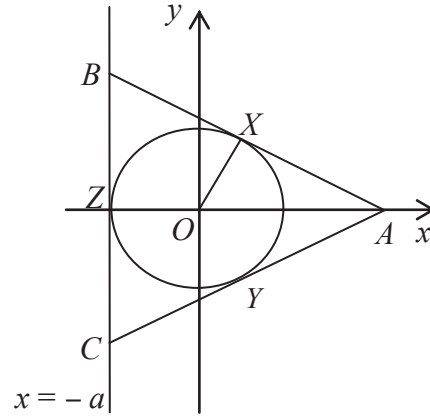

- b i** The line meets the curve at one point if the discriminant of the quadratic in a is zero.

$$\begin{aligned}\Delta &= (2c + 1)^2 - 4(c^2 + b) \\ &= 4c^2 + 4c + 1 - 4c^2 - 4b \\ &= 4c - 4b + 1\end{aligned}$$

If the discriminant is zero, $c = \frac{4b - 1}{4}$

- ii** Solving the equation $x = \sqrt{x} - \frac{1}{4}$ will give the required coordinates.

Squaring both sides of $x + \frac{1}{4} = \sqrt{x}$ gives $x^2 + \frac{1}{2}x + \frac{1}{16} = x$

and rearranging gives $x^2 - \frac{1}{2}x + \frac{1}{16} = 0$

$$\left(x - \frac{1}{4}\right)^2 = 0$$

Therefore $x = \frac{1}{4}$

and $y = \frac{1}{4}$

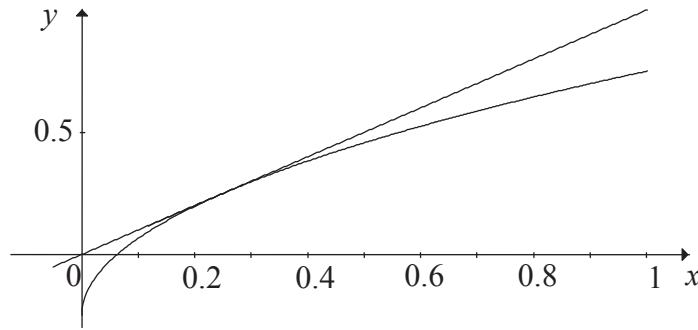

- c i** From the above, we know that the line with equation $y = x$ is tangent to the curve with equation $y = \sqrt{x} - \frac{1}{4}$.

Hence if $-\frac{1}{4} < k < 0$, the line will cross the curve twice.

- ii** If $k = 0$ or $k < -\frac{1}{4}$, the line will cross the curve once.

- iii** It will not meet the curve if $k > 0$.

- 7 a** From the graphs of $y = kx$ and $y = \sqrt{x} - 1$, it is clear that if $k \leq 0$, the line $y = kx$ can only cut the curve once.

For two solutions, consider the equation: $kx = \sqrt{x} - 1$

$$\begin{aligned}\Delta &= (2k - 1)^2 - 4k^2 \\ &= 4k^2 - 4k + 1 - 4k^2 \\ &= -4k + 1\end{aligned}$$

Thus for two solutions, $-4k + 1 > 0$, i.e. $k < \frac{1}{4}$, and $k > 0$.

Hence $0 < k < \frac{1}{4}$.

- b** There is one solution when $k = \frac{1}{4}$ or $k \leq 0$.

Chapter 5 – Functions and relations

Solutions to Exercise 5A

- 1 $A = \{1, 2, 3, 5, 7, 11, 15\}$
 $B = \{7, 11, 25, 30, 32\}$
 $C = \{1, 7, 11, 25, 30\}$
 $A \cap B$ means must be in both A and B
 $A \cup B$ means must be in either or any
 $A \setminus B$ means in A but not B

- a $A \cap B = \{7, 11\}$
b $A \cap B \cap C = \{7, 11\}$
c $A \cup C = \{1, 2, 3, 5, 7, 11, 15, 25, 30\}$
d $A \cup B = \{1, 2, 3, 5, 7, 11, 15, 25, 30, 32\}$
e $A \cup B \cup C = \{1, 2, 3, 5, 7, 11, 15, 25, 30, 32\}$
f $(A \cap B) \cup C = \{1, 7, 11, 25, 30\}$

- 2 a $A \setminus B = \{1, 2, 3, 5, 15\}$
b $B \setminus A = \{25, 30, 32\}$
c $A \setminus C = \{2, 3, 5, 15\}$
d $C \setminus A = \{25, 30\}$

- 3 a $[-3, 4)$

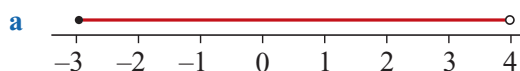

- b $(-\infty, 3]$

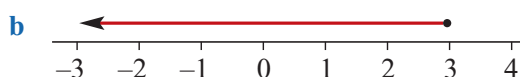

- c $[-2, -1]$

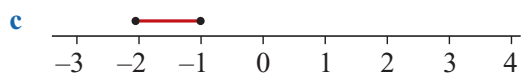

- d $(-2, \infty)$

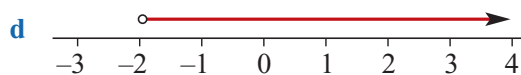

- e $(-2, 3)$

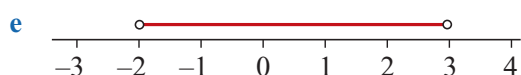

- f $(-2, 4]$

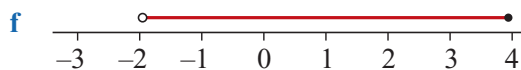

- 4 a $(-2, 1]$

- b $[-3, 3]$

- c $[-3, 2)$

- d $(-1, 2)$

- 5 a $\{x: -1 \leq x \leq 2\} = [-1, 2]$

- b $\{x: -4 < x \leq 2\} = (-4, 2]$

- c $\{y: 0 < y < \sqrt{2}\} = (0, \sqrt{2})$

- d $\{y: -\frac{\sqrt{3}}{2} < y \leq \frac{1}{\sqrt{2}}\} = \left(-\frac{\sqrt{3}}{2}, \frac{1}{\sqrt{2}}\right]$

- e $\{x: x > -1\} = (-1, \infty)$

- f $\{x: x \leq -2\} = (-\infty, -2]$

- g $\mathbb{R} = (-\infty, \infty)$

- h $\mathbb{R}^+ \cup \{0\} = [0, \infty)$

- i $\mathbb{R}^- \cup \{0\} = (-\infty, 0]$

6 $B = \{7, 11, 25, 30, 32\}$

a $(-2, 10] \cap B = \{7\}$

b $(3, \infty) \cap B = \{7, 11, 25, 30, 32\} = B$

c $(2, \infty) \cup B = (2, \infty)$

d $(25, \infty) \cap B = \{30, 32\}$

7 a $[-2, 5], [3, 4], [-2, 5] \cap [3, 4]$

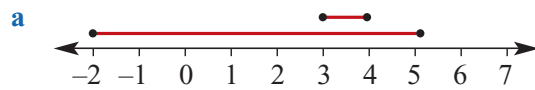

b $[-2, 5], \mathbb{R} \setminus [-2, 5]$

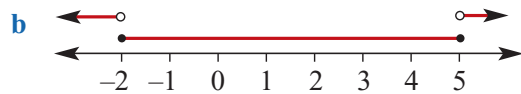

c $[3, \infty), (-\infty, 7], [3, \infty) \cap (-\infty, 7]$

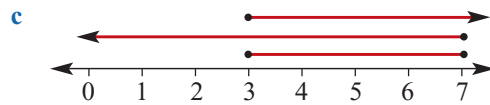

d $[-2, 3], \mathbb{R} \setminus [-2, 3]$

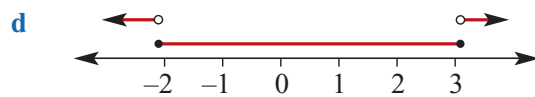

8 a $(-\infty, -2) \cup (-2, \infty)$

b $(-\infty, 3) \cup (3, \infty)$

c $(-\infty, 4) \cup (4, \infty)$

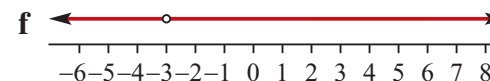
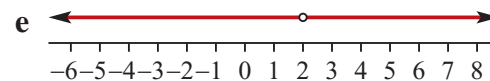
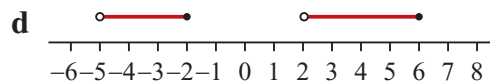
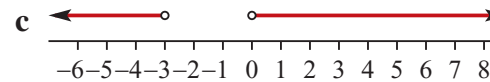
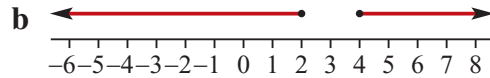
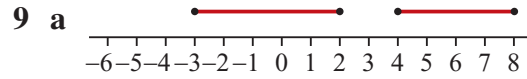

10 a $(-6, -3)$

b \emptyset

c $[-6, 0]$

d $[-1, 2]$

e $\{1\}$

f $(-10, -1]$

Solutions to Exercise 5B

- 1 a Domain = $\{-3, -1, -6, 1\}$;
Range = $\{-4, -1, 7, 5\}$

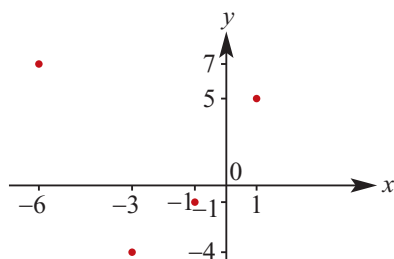

- b Domain = $\{-4, -6\}$; Range = $\{-1, 1, 7, 8\}$

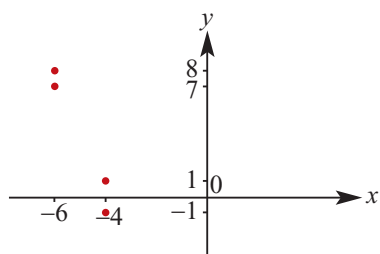

- c Domain = $[-2, 2]$
Range = $[-2, 2]$

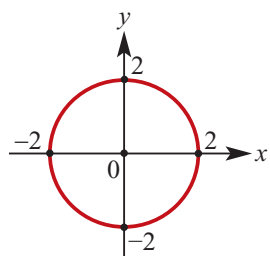

- d Domain = $[0, \infty)$
Range = $(-\infty, 6]$

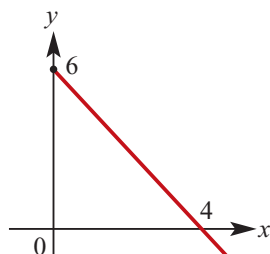

- e Domain = $[-1, 2]$
Range = $[-5, -2]$

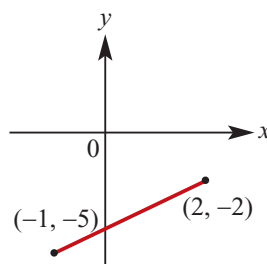

- f Domain = $[-4, 1]$
Range = $[-5, 5]$

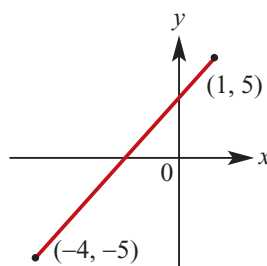

- 2 a Domain = $[-2, 2]$; Range = $[-1, 2]$

- b Domain = $[-2, 2]$; Range = $[-2, 2]$

- c Domain = \mathbb{R} ; Range = $[-1, \infty)$

- d Domain = \mathbb{R} ; Range = $(-\infty, 4]$

- 3 a $x^2 + 6x + 10 = x^2 + 6x + 9 - 9 + 10$
 $= (x - 3)^2 + 1$

$$y = (x + 3)^2 + 1$$

$$\text{Range} = [1, \infty)$$

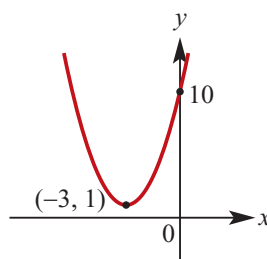

b

$$\begin{aligned}
 -x^2 - 4x - 6 &= -(x^2 + 4x + 6) \\
 &= -[x^2 + 4x + 4 - 4 + 6] \\
 &= -(x + 2)^2 - 2
 \end{aligned}$$

$$\begin{aligned}
 y &= -(x + 2)^2 - 2 \\
 \text{Range} &= (-\infty, -2]
 \end{aligned}$$

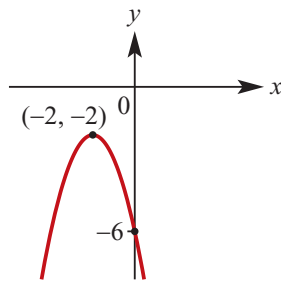

c

$$\begin{aligned}
 2x^2 - 4x + 6 &= 2(x^2 - 2x + 3) \\
 &= 2[x^2 - 2x + 1 - 1 + 3] \\
 &= 2(x - 1)^2 + 4 \\
 y &= 2(x - 1)^2 + 4 \\
 \text{Range} &= [4, \infty)
 \end{aligned}$$

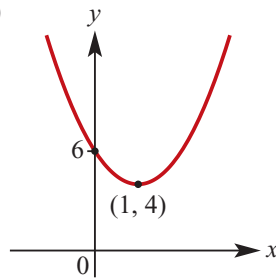

4 a $y = x + 1; x \in [2, \infty); \text{Range} = [3, \infty)$

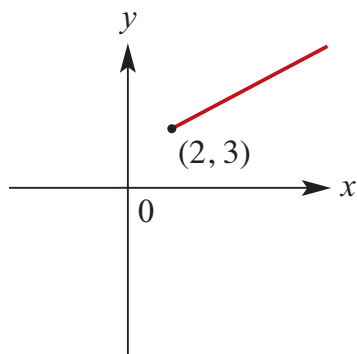

b $y = -x + 1; x \in [2, \infty);$
 $\text{Range} = (-\infty, -1]$

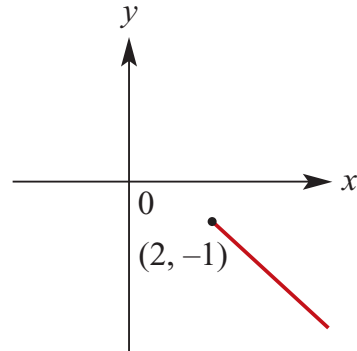

c $y = 2x + 1; x \in [-4, \infty);$
 $\text{Range} = [-7, \infty)$

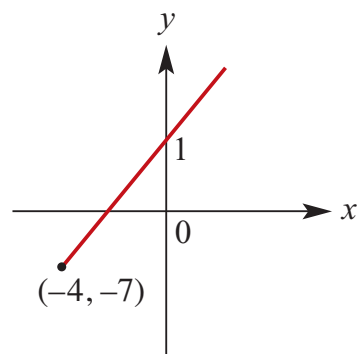

d $y = 3x + 2; x \in (-\infty, 3);$
 $\text{Range} = (-\infty, 11)$

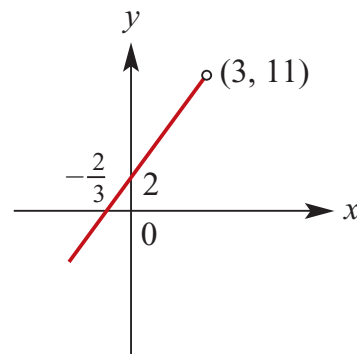

e $y = x + 1; x \in (-\infty, 3);$
 $\text{Range} = (-\infty, 4]$

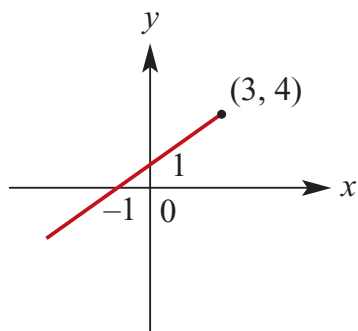

f $y = -3x - 1; x \in [-2, 6];$
Range = $[-19, 5]$

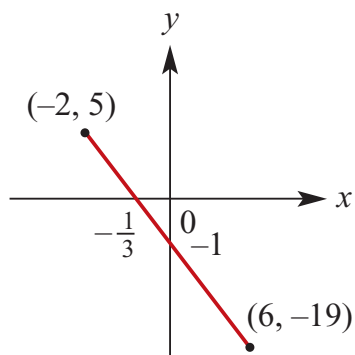

g $y = -3x - 1; x \in [-5, -1];$
Range = $[2, 14]$

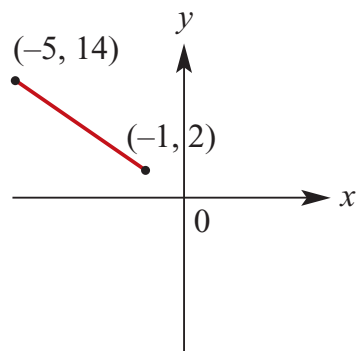

h $y = 5x - 1; x \in (-2, 4);$
Range = $(-11, 19)$

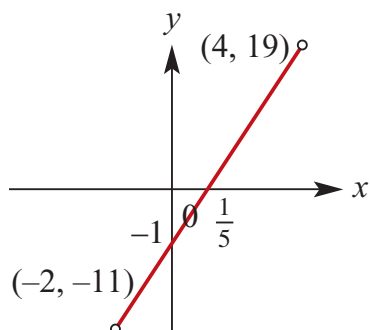

5 a $y = x^2 + 3, x \in [-1, 1]$
Range = $[3, 4]$

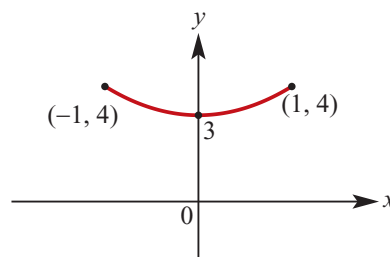

b $y = x^2 + 4, x \in [-2, 1]$
Range = $[4, 8]$

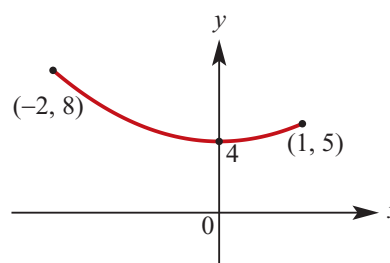

c $y = x^2 - 4, x \in [-1, 2]$
Range = $[-4, 0]$

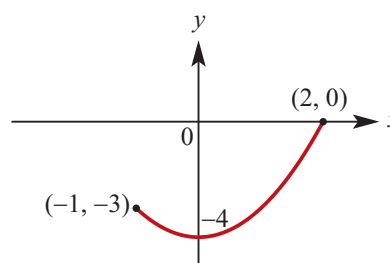

d $y = 2x^2 + 1, x \in [-2, 3]$
Range = $[1, 19]$

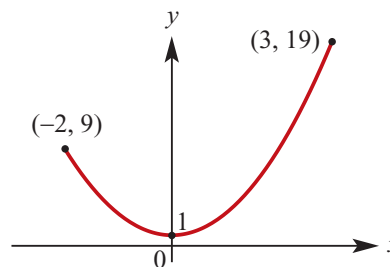

6 a $\{(x, y) : y = x^2 + 1\};$
Range = $[1, \infty)$

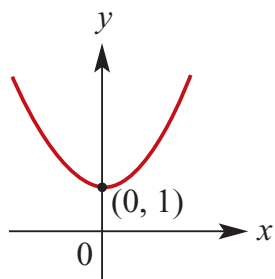

b $\{(x, y): y = x^2 + 2x + 1\};$
Range = $[0, \infty)$

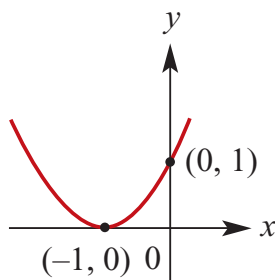

c $\{(x, y): y = 4 - x^2; x \in [-2, 2]\};$
Range = $[0, 4]$

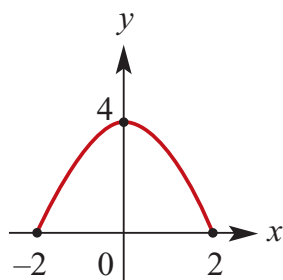

d $\{(x, y): y = x^2 + 2x + 3\};$
Range = $[2, \infty)$

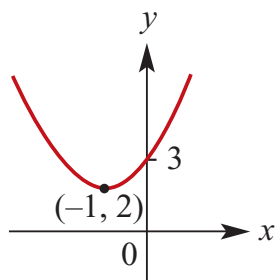

e $\{(x, y): y = -x^2 + 2x + 3\};$
Range = $(-\infty, 4]$

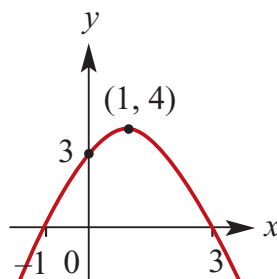

f $\{(x, y): y = x^2 - 2; x \in [-1, 2]\};$
Range = $[-2, 2]$

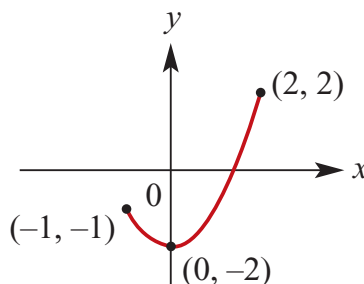

g $\{(x, y): y = 2x^2 - 3x + 6\};$
Range = $[\frac{39}{8}, \infty)$

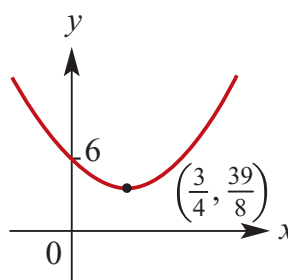

h $\{(x, y): y = 6 - 3x + x^2\};$
Range = $[\frac{15}{4}, \infty)$

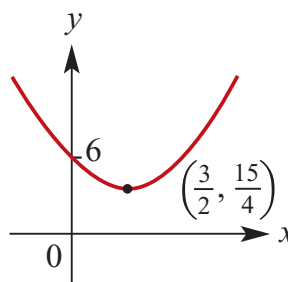

7 a $\{(x, y): x^2 + y^2 = 9\}$
Max. Domain = $[-3, 3]$

Range = $[-3, 3]$

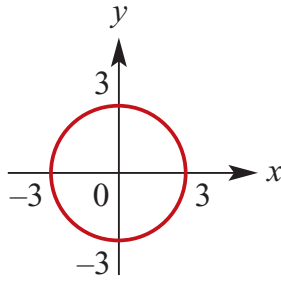

- b** $\{(x, y) : (x - 2)^2 + (y - 3)^2 = 16\}$
 Max. Domain = $[-2, 6]$
 Range = $[-1, 7]$

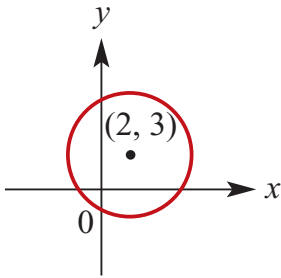

- c** $\{(x, y) : (2x - 1)^2 + (2y - 4)^2 = 1\}$
 Max. Domain = $[0, 1]$
 Range = $[\frac{3}{2}, \frac{5}{2}]$

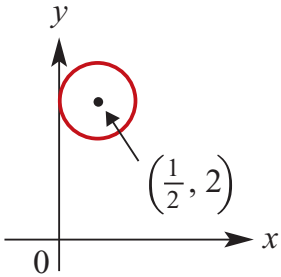

- d** $\{(x, y) : y = \sqrt{25 - x^2}\}$
 Max. Domain = $[-5, 5]$
 Range = $[0, 5]$

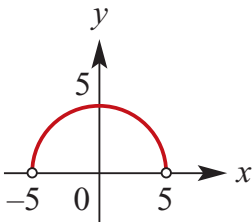

- e** $\{(x, y) : y = -\sqrt{25 - x^2}\}$
 Max. Domain = $[-5, 5]$,

Range = $[-5, 0]$

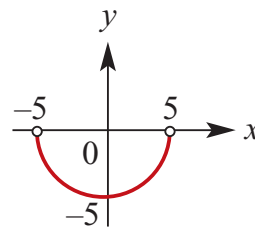

- f** $(x, y) : y = -\sqrt{25 - (x - 2)^2}$
 Max. Domain = $[-3, 7]$
 Range = $[-5, 0]$

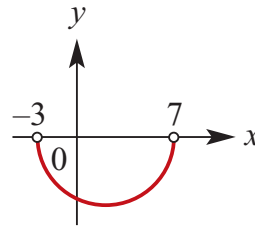

- 8 a** Domain = $\mathbb{R} \setminus \{\frac{5}{2}\}$; Range = $\mathbb{R} \setminus \{3\}$

When $x = 0, y = -\frac{2}{5} + 3 = \frac{13}{5}$

When $y = 0$

$$\frac{2}{2x - 5} + 3 = 0$$

$$\frac{2}{2x - 5} = -3$$

$$2 = -3(2x - 5)$$

$$2 = -6x + 15$$

$$x = \frac{13}{6}$$

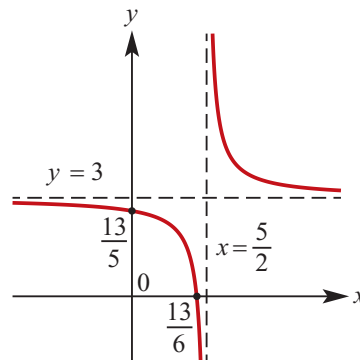

- b** Domain = $[\frac{5}{2}, \infty)$

Range = $\mathbb{R}^+ \cup \{0\}$

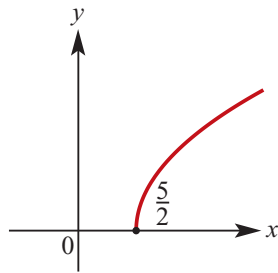

f Domain = $(-\infty, 2]$; Range = $[0, \infty)$

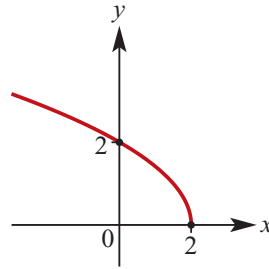

c $y = \sqrt{5 - 2x} = \sqrt{-(2x - 5)}$
 Domain = $(-\infty, \frac{5}{2}]$
 Range = $\mathbb{R}^+ \cup \{0\}$

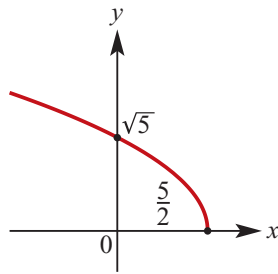

9 a Domain = $[0, \infty)$
 Range = \mathbb{R}

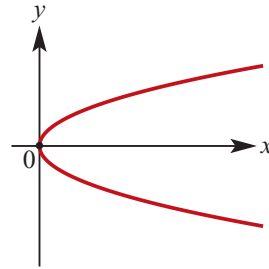

d $y = \sqrt{4 - (x - 5)^2}$
 Squaring gives:
 $y^2 = 4 - (x - 5)^2$
 $(x - 5)^2 + y^2 = 4$ This last equation is that of a circle of radius 2 and centre (5, 0).
 It is the 'top half' of the circle.
 Domain = $[3, 7]$; Range = $[0, 2]$

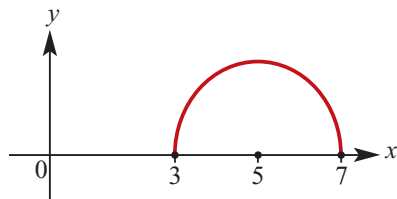

b Domain = $[1, \infty)$
 Range = \mathbb{R}

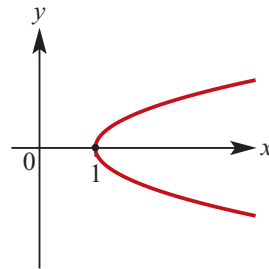

c Domain = $[-1, \infty)$
 Range = \mathbb{R}

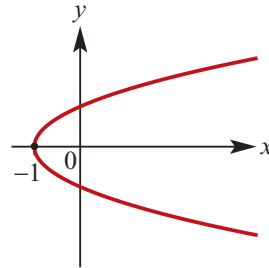

e Domain = $\mathbb{R} \setminus \{\frac{5}{2}\}$; Range = $(0, \infty)$

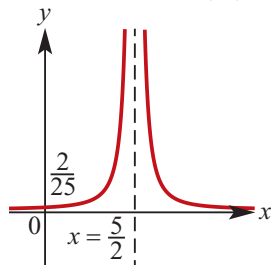

d Domain = $[1, \infty)$
 Range = \mathbb{R}

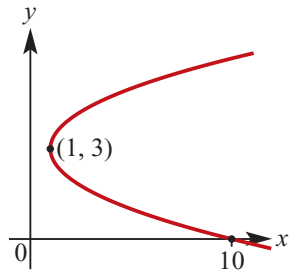

Solutions to Exercise 5C

- 1 a** $\{(0, 1), (0, 2), (1, 2), (2, 3), (3, 4)\}$ is not a function because it is 1–many;
 $(0, 1)$ and $(0, 2)$ Domain = $\{0, 1, 2, 3\}$;
 Range = $\{1, 2, 3, 4\}$

- b**
 $\{(-2, -1), (-1, -2), (0, 2), (1, 4), (2, -5)\}$
 is a function because it is 1–1;
 Domain = $\{-2, -1, 0, 1, 2\}$;
 Range = $\{-5, -2, -1, 2, 4\}$

- c** Not a function;
 Domain = $\{-1, 0, 3, 5\}$;
 Range = $\{1, 2, 4, 6\}$

- d** $\{(1, 3), (2, 3), (4, 3), (5, 3), (6, 3)\}$ is a function because it is many–1;
 Domain = $\{1, 2, 4, 5, 6\}$;
 Range = $\{3\}$

- 2 a** $y = x^2; x \in [0, 4]$; Range = $[0, 16]$;
 function because 1–1 relation

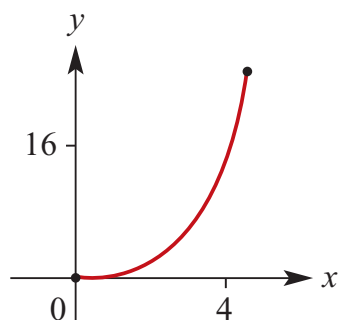

a function
 Domain = $[0, 4]$
 Range = $[0, 16]$

- b** $\{(x, y) : x^2 + y^2 = 4\}; x \in [0, 2]$;
 Range = $[-2, 2]$; not a function
 because
 1–many relation

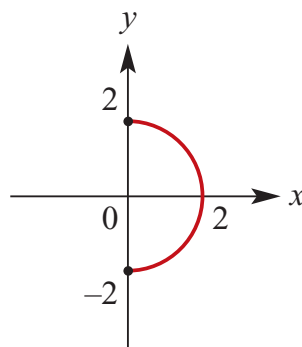

not a function
 Domain = $[0, 2]$
 Range = $[-2, 2]$

- c** $\{(x, y) : 2x + 8y = 16; x \in [0, \infty)\}$;
 Range = $(-\infty, 2]$; function because
 1–1 relation

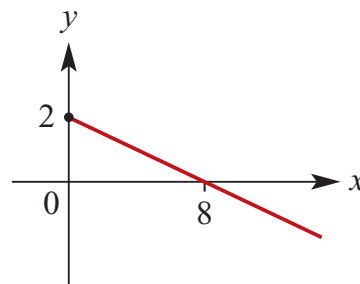

A function
 Domain = $[0, \infty)$
 Range = $(-\infty, 2]$

- d** $y = \sqrt{x}; x \in \mathbb{R}^+$, function because
 1–1
 relation; Range = \mathbb{R}^+ or $(0, \infty)$

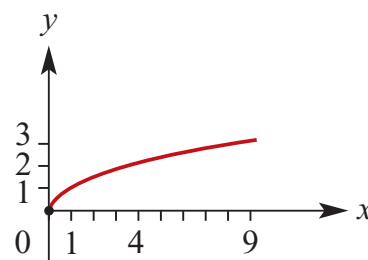

a function
 Domain = $\{x : x \geq 0\}$
 Range = $\{y : y \geq 0\}$

- e** $\{(x, y) : y = \frac{1}{x^2}; x \in \mathbb{R} \setminus \{0\}\}$;
function because many \rightarrow 1 relation;
Range = \mathbb{R}^+ or $(0, \infty)$

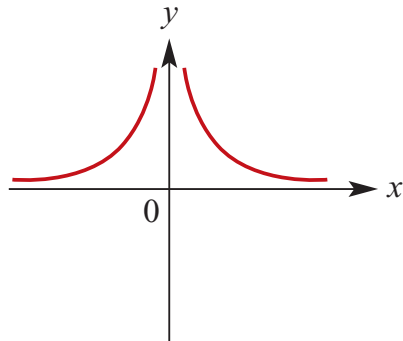

a function

Domain = $\mathbb{R} \setminus \{0\}$
Range = \mathbb{R}^+

- f** $\{(x, y) : y = \frac{1}{x}; x \in \mathbb{R}^+\}$; function
because 1 \rightarrow 1 relation; Range = \mathbb{R}^+
or $(0, \infty)$
Domain = \mathbb{R}^+

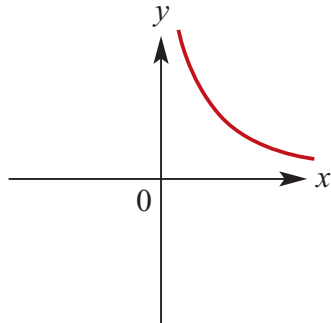

- g** $y = x^2; x \in [-1, 4]$; Range = $[0, 16]$;
function because many \rightarrow 1 relation

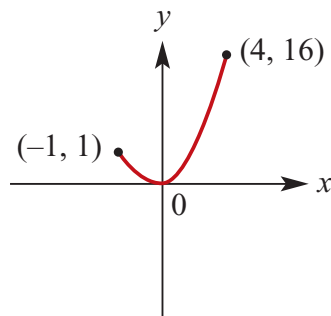

- h** $\{(x, y) : x = y^2; x \in \mathbb{R}^+\}$;

Range = $\mathbb{R} \setminus \{0\}$; not a function
because 1 \rightarrow many relation

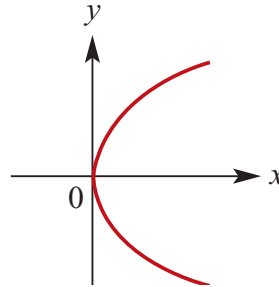

- 3 a** $\{(x, y) : y = 3x + 2\}$ can be expressed
as $f: \mathbb{R} \rightarrow \mathbb{R}, f(x) = 3x + 2$

- b** $\{(x, y) : 2y + 3x = 12\}$
 $2y + 3x = 12$

$$\therefore 2y = 12 - 3x$$

$$\therefore y = 6 - \frac{3x}{2}$$

$$f: \mathbb{R} \rightarrow \mathbb{R}, f(x) = 6 - \frac{3x}{2}$$

- c** $\{(x, y) : y = 2x + 3, x \geq 0\}$
can be expressed as
 $f: \mathbb{R}^+ \cup \{0\} \rightarrow \mathbb{R}, f(x) = 2x + 3$

- d** $y = 5x + 6, -1 \leq x \leq 2$ can be
expressed as
 $f: [-1, 2] \rightarrow \mathbb{R}, f(x) = 5x + 6$

- e** $y + x^2 = 25, -5 \leq x \leq 5$
 $\therefore y = 25 - x^2$ can be expressed as
 $f: [-5, 5] \rightarrow \mathbb{R}, f(x) = 25 - x^2$

- f** $y = 5x - 7, 0 \leq x \leq 1$ can be
expressed as
 $f: [0, 1] \rightarrow \mathbb{R}, f(x) = 5x - 7$

- 4 a** $\{(x, -2) : x \in \mathbb{R}\}$ is a function
because it is many \rightarrow 1; Domain = \mathbb{R} ,
Range = $\{-2\}$

b $\{(3, y) : y \in \mathbb{Z}\}$ is not a function because it is $1 \rightarrow \text{many}$; Domain = $\{3\}$, Range = \mathbb{Z}

c $y = -x + 3$ is a function because it is $1 \rightarrow 1$; Domain = \mathbb{R} , Range = \mathbb{R}

d $y = x^2 + 5$ is a function because it is $\text{many} \rightarrow 1$; Domain = \mathbb{R} , Range = $[5, \infty)$

e $\{(x, y) : x^2 + y^2 = 9\}$ is not a function because it is $\text{many} \rightarrow \text{many}$; Domain = $[-3, 3]$, Range = $[-3, 3]$

5 a $f(x) = 2x - 3$

i $f(0) = 2(0) - 3 = -3$

ii $f(4) = 2(4) - 3 = 5$

iii $f(-1) = 2(-1) - 3 = -5$

iv $f(6) = 2(6) - 3 = 9$

v $f(x - 1) = 2(x - 1) - 3 = 2x - 5$

vi $f\left(\frac{1}{a}\right) = \frac{2}{a} - 3$

b $g(x) = \frac{4}{x}$

i $g(1) = \frac{4}{1} = 4$

ii $g(-1) = \frac{4}{-1} = -4$

iii $g(3) = \frac{4}{3}$

iv $g(2) = \frac{4}{2} = 2$

c $g(x) = (x - 2)^2$

i $g(4) = (4 - 2)^2 = 4$

ii $g(-4) = (-4 - 2)^2 = 36$

iii $g(8) = (8 - 2)^2 = 36$

iv $g(a) = (a - 2)^2$

d $f(x) = 1 - \frac{1}{x}$

i $f(1) = 1 - \frac{1}{1} = 0$

ii $f(1 + a) = 1 - \frac{1}{1 + a}$
 $= \frac{1 + a - 1}{1 + a} = \frac{a}{a + 1}$

iii $f(1 - a) = 1 - \frac{1}{1 - a}$
 $= \frac{1 - a - 1}{1 - a}$
 $= -\frac{a}{1 - a} = \frac{a}{a - 1}$

iv $f\left(\frac{1}{a}\right) = 1 - \frac{1}{1/a} = 1 - a$

6 $f(x) = 2x + 1$

a $f(2) = 2 \times 2 + 1 = 5$ and $f(t) = 2t + 1$

b $f(x) = 6$

$$2x + 1 = 6$$

$$2x = 5$$

$$x = \frac{5}{2}$$

c $f(x) = 0$

$$2x + 1 = 0$$

$$2x = -1$$

$$x = -\frac{1}{2}$$

d $f(t) = t$

$$2t + 1 = t$$

$$t = -1$$

e $f(x) \geq x$

$$2x + 1 \geq x$$

$$x \geq -1$$

f $f(x) \leq 3x$

$$2x + 1 \leq 3x$$

$$-x \leq -1$$

$$x \geq 1$$

7 a $f(x) = 5x - 2 = 3$

$$\therefore 5x = 5, \therefore x = 1$$

b $f(x) = \frac{1}{x} = 6$

$$\therefore 1 = 6x, x = \frac{1}{6}$$

c $f(x) = x^2 = 9$

$$\therefore x = \pm\sqrt{9} = \pm 3$$

d $f(x) = (x + 1)(x - 4) = 0$

$$\therefore x = -1, 4$$

e $f(x) = x^2 - 2x = 3$

$$\therefore x^2 - 2x - 3 = 0$$

$$\therefore (x - 3)(x + 1) = 0$$

$$\therefore x = -1, 3$$

f $f(x) = x^2 - x - 6 = 0$

$$\therefore (x - 3)(x + 2) = 0$$

$$\therefore x = -2, 3$$

8 $g(x) = x^2 + 2x$ and

$$h(x) = 2x^3 - x^2 + 6$$

a $g(-1) = (-1)^2 + 2(-1) = -1$

$$g(2) = (2)^2 + 2(2) = 8$$

$$g(-2) = (-2)^2 + 2(-2) = 0$$

b $h(-1) = 2(-1)^3 - (-1)^2 + 6 = 3$

$$h(2) = 2(2)^3 - (2)^2 + 6 = 18$$

$$h(-2) = 2(-2)^3 - (-2)^2 + 6 = -14$$

c i $g(-3x) = (-3x)^2 + 2(-3x) = 9x^2 - 6x$

ii $g(x - 5) = (x - 5)^2 + 2(x - 5) = x^2 - 8x + 15$

iii $h(-2x) = 2(-2x)^3 - (-2x)^2 + 6 = -16x^3 - 4x^2 + 6$

iv $g(x + 2) = (x + 2)^2 + 2(x + 2) = x^2 + 6x + 8$

v $h(x^2) = 2(x^2)^3 - (x^2)^2 + 6 = 2x^6 - x^4 + 6$

9 $f(x) = 2x^2 - 3$

a $f(2) = 2(2)^2 - 3 = 5$
 $f(-4) = 2(-4)^2 - 3 = 29$

b The Range of f is $[-3, \infty)$

10 $f(x) = 3x + 1$

a The image of 2 = $3(2) + 1 = 7$

b The pre-image of 7: $3x + 1 = 7$
so $3x = 6$ and $x = 2$

c $\{x: f(x) = 2x\}$:
 $3x + 1 = 2x, \therefore x = -1$

11 $f(x) = 3x^2 + 2$

a The image of 0 = $3(0)^2 + 2 = 2$

b The pre-image(s) of 5:
 $3x^2 + 2 = 5$
 $\therefore 3x^2 = 3, \therefore x = \pm 1$

c $\{x: f(x) = 11\}$
 $\therefore 3x^2 + 2 = 11$
 $\therefore 3x^2 = 9$
 $\therefore x^2 = 3, \therefore x = \pm \sqrt{3}$

12 $f(x) = 7x + 6$ and $g(x) = 2x + 1$

a $\{x: f(x) = g(x)\}$
 $\therefore 7x + 6 = 2x + 1$
 $\therefore 5x = -5, \therefore x = -1$

b $\{x: f(x) > g(x)\}$
 $\therefore 7x + 6 > 2x + 1$
 $\therefore 5x > -5, \therefore x > -1$

c $\{x: f(x) = 0\}$
 $\therefore 7x + 6 = 0$
 $\therefore 7x = -6, \therefore x = -\frac{6}{7}$

13 a $f: [-1, 2] \rightarrow \mathbb{R}, f(x) = x^2$
Range = $[0, 4]$

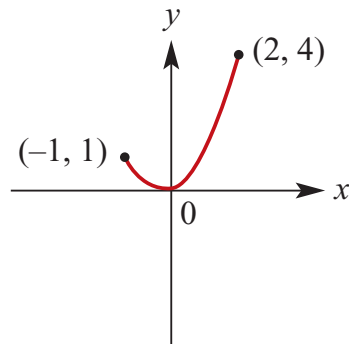

b $f: [-2, 2] \rightarrow \mathbb{R}, f(x) = x^2 + 2x$
Range = $[-1, 8]$

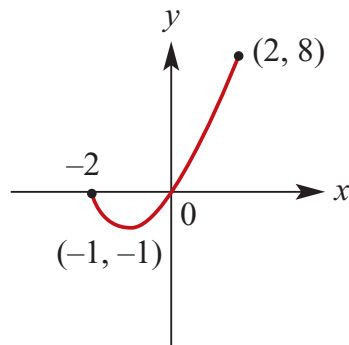

c $f: (0, 3] \rightarrow \mathbb{R}, f(x) = \frac{1}{x}$
Range = $[\frac{1}{3}, \infty)$

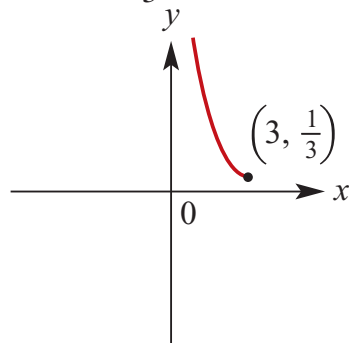

d $f: \mathbb{R} \rightarrow \mathbb{R}, f(x) = x^2 - 2x + 3$
Range = $[2, \infty)$

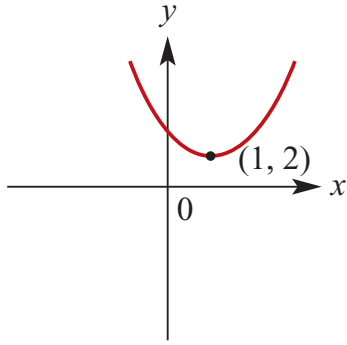

e $f: (1, 6) \rightarrow \mathbb{R}, f(x) = x^2 - 4x + 6$
 Range = $[2, 18)$

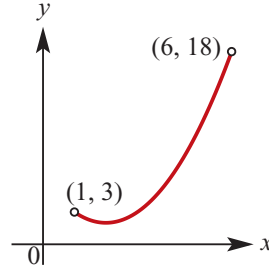

f $f: [-3, 6] \rightarrow \mathbb{R}, f(x) = x^2 - 2x + 1$
 Range = $[0, 25]$

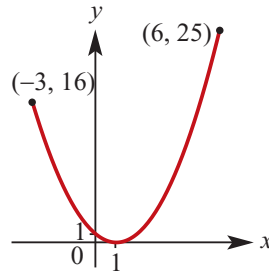

Solutions to Exercise 5D

- 1 a** Not 1 – 1: (2, 4), (4, 4) both have image = 4
- b** $\{(1, 3), (2, 4), (3, 6), (7, 9)\}$ is 1 – 1
- c** Not 1 – 1: $(-x)^2 = x^2$
- d** $\{(x, y): y = 3x + 1\}$ is 1 – 1
- e** $f(x) = x^3 + 1$ is 1 – 1
- f** Not 1 – 1: $1 - x^2 = 1 - (-x)^2$
- g** $y = x^2, x \geq 0$ is 1 – 1 because $x \geq 0$
- 2 a** Is a function but isn't 1 – 1 (many \rightarrow 1)
- b** Isn't a function: 1 – many
- c** Is a 1 – 1 function
- d** Is a function but isn't 1 – 1 (many – 1)
- e** Isn't a function: 1 – many
- f** Is a function but isn't 1 – 1 (many \rightarrow 1)
- g** Is a 1 – 1 function
- h** Isn't a function: many – many
- 3 a** $y = 7 - x$,
Max. Domain \mathbb{R} , Range \mathbb{R}
- b** $y = 2\sqrt{x}$
Max. Domain $[0, \infty)$, Range $[0, \infty)$
- c** $y = x^2 + 1$,
Max. Domain \mathbb{R} , Range $[1, \infty)$
- d** $y = -\sqrt{9 - x^2}$,
Max. Domain $[-3, 3]$ because $9 - x^2 \geq 0$,
Range $[-3, 0]$
- e** $y = \frac{1}{\sqrt{x}}$,
Max. Domain \mathbb{R}^+ , Range \mathbb{R}^+
(Different from **b** because you can't have $\frac{1}{0}$.)
- f** $y = 3 - 2x^2$,
Max. Domain \mathbb{R} , Range $(-\infty, 3]$
- g** $y = \sqrt{x - 2}$,
Max. Domain $[2, \infty)$ because $x - 2 \geq 0$,
Range $[0, \infty)$
- h** $y = \sqrt{2x - 1}$,
Max. Domain $[\frac{1}{2}, \infty)$ because $2x - 1 \geq 0$,
Range $[0, \infty)$
- i** $y = \sqrt{3 - 2x}$,
Max. Domain $(-\infty, \frac{3}{2}]$ because $3 - 2x \geq 0$,
Range $[0, \infty)$
- j** $y = \frac{1}{2x - 1}$,
Max. Domain $\mathbb{R} \setminus \{\frac{1}{2}\}$ because $2x - 1 \neq 0$,
Range $\mathbb{R} \setminus \{0\}$ because $\frac{1}{2x - 1} \neq 0$

k $y = \frac{1}{(2x-1)^2} - 3$,
 Max. Domain $\mathbb{R} \setminus \{\frac{1}{2}\}$ because
 $2x - 1 \neq 0$,
 Range $(-3, \infty)$ because $\frac{1}{(2x-1)^2} > 0$

l $y = \frac{1}{2x-1} + 2$,
 Max. Domain $\mathbb{R} \setminus \{\frac{1}{2}\}$ because
 $2x - 1 \neq 0$,
 Range $\mathbb{R} \setminus \{2\}$ because $\frac{1}{2x-1} \neq 0$

- 4 a** Domain = $[4, \infty)$; Range = $[0, \infty)$
b Domain = $(-\infty, 4]$; Range = $[0, \infty)$
c Domain = $[2, \infty)$; Range = $[3, \infty)$
d Domain = $\mathbb{R} \setminus \{4\}$; Range = $\mathbb{R} \setminus \{0\}$
e Domain = $\mathbb{R} \setminus \{4\}$; Range = $\mathbb{R} \setminus \{3\}$
f Domain = $\mathbb{R} \setminus \{-2\}$; Range = $\mathbb{R} \setminus \{-3\}$

5 a $f(x) = 3x + 4$;
 Max. Domain \mathbb{R} , Range \mathbb{R}

b $g(x) = x^2 + 2$,
 Max. Domain \mathbb{R} , Range $[2, \infty)$

c $y = -\sqrt{16 - x^2}$,
 Max. Domain $[-4, 4]$ because
 $16 - x^2 \geq 0$,
 Range $[-4, 0]$

d $y = \frac{1}{x+2}$,
 Max. Domain $\mathbb{R} \setminus \{-2\}$ because
 $x + 2 \neq 0$,
 Range $\mathbb{R} \setminus \{0\}$ because $\frac{1}{x+2} \neq 0$

6 $\{(x, y) : y^2 = -x + 2, x \leq 2\}$ is a one → many relation. Split in two:

$\{f : (-\infty, 2], f(x) = \sqrt{2 - x}\}$, Range $[0, \infty)$

$\{f : (-\infty, 2], f(x) = -\sqrt{2 - x}\}$, Range $(-\infty, 0]$

7 a $\{f : \mathbb{R} \rightarrow \mathbb{R}; f(x) = x^2 - 2\}$

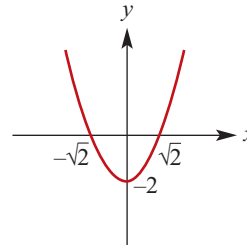

b $\{f : [0, \infty) \rightarrow \mathbb{R}; f(x) = x^2 - 2\}$ and
 $\{f : (-\infty, 0] \rightarrow \mathbb{R}; f(x) = x^2 - 2\}$

8 $f_1 : [1, \infty) \rightarrow \mathbb{R}, f_1(x) = x^2 - 2x + 4$
 $f_2 : (-\infty, 1] \rightarrow \mathbb{R}, f_2(x) = x^2 - 2x + 4$

9 $f_1 : (2, \infty) \rightarrow \mathbb{R}, f_1(x) = \frac{1}{(x-2)^2}$
 $f_2 : (-\infty, 2) \rightarrow \mathbb{R}, f_2(x) = \frac{1}{(x-2)^2}$

10 a Domain = $[-2, 2]$

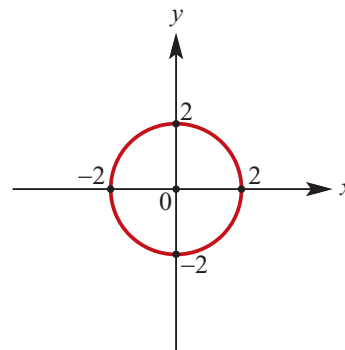

b $f_1 : [0, 2] \rightarrow \mathbb{R}, f_1(x) = \sqrt{4 - x^2}$
 $f_2 : [0, 2] \rightarrow \mathbb{R}, f_2(x) = -\sqrt{4 - x^2}$

c $f_1 : [-2, 0] \rightarrow \mathbb{R}, f_1(x) = \sqrt{4 - x^2}$
 $f_2 : [-2, 0] \rightarrow \mathbb{R}, f_2(x) = -\sqrt{4 - x^2}$

Solutions to Exercise 5E

- 1 a $h(x) = x, x \geq 0$ and $h(x) = -x, x < 0$;
Range = $[0, \infty)$

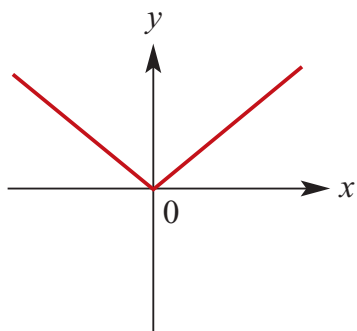

- b $h(x) = x - 1, x \geq 1$ and $h(x) = 1 - x, x < 1$; Range = $[0, \infty)$

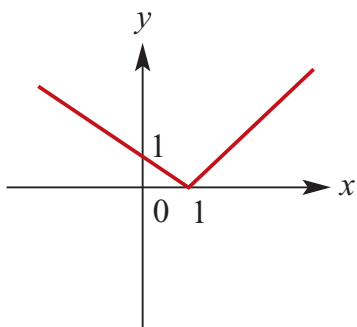

- c $h(x) = -x, x \geq 0$ and $h(x) = x, x < 0$;
Range = $(-\infty, 0]$

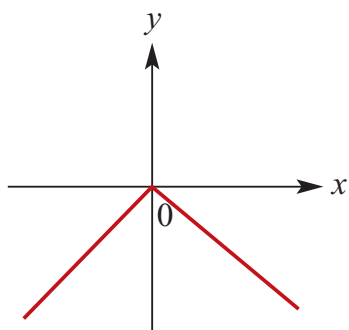

- d $h(x) = 1 + x, x \geq 0$ and $h(x) = 1 - x, x < 0$; Range = $[1, \infty)$

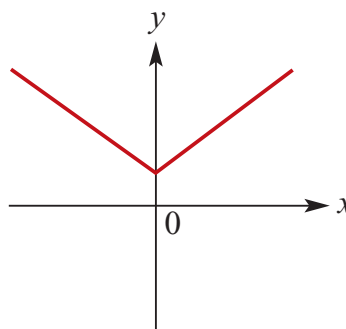

- e $h(x) = x, x \geq 1$ and
 $h(x) = 2 - x, x < 1$;
Range = $[1, \infty)$

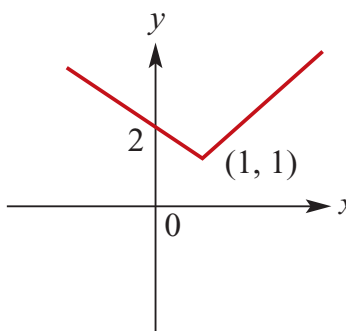

- 2 a $f(x) = \frac{2}{3}x + 3, x < 0$
 $f(x) = x + 3, 0 \leq x \leq 1$
 $f(x) = -2x + 6, x > 1$
Axis intercepts at $(-\frac{9}{2}, 0)$, $(0, 3)$ and $(3, 0)$

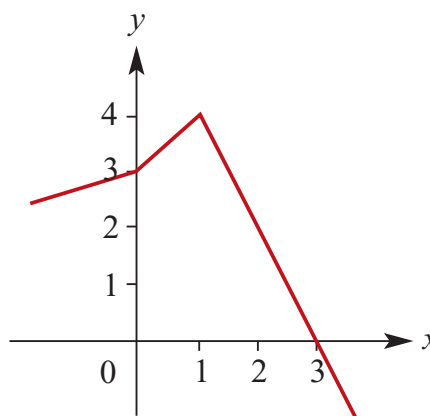

- b Range = $(-\infty, 4]$

- 3** $g(x) = -x - 3, x < 1$
 $g(x) = x - 5, 1 \leq x \leq 5$
 $g(x) = 3x - 15, x > 5$
 Axis intercepts at $(-3, 0)$, $(0, -3)$
 and $(5, 0)$

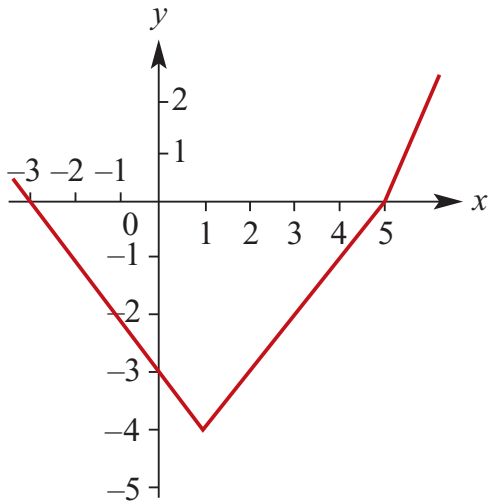

- 4 a** $h(x) = x^2 + 1, x \geq 0$
 $h(x) = 1 - x, x < 0$

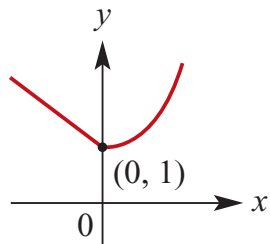

- b** Range = $[1, \infty)$

- 5 a** $f(x) = -x + 3, x < -3$
 $f(x) = x^2 - 9, -3 \leq x \leq 3$
 $f(x) = x - 3, x > 3$

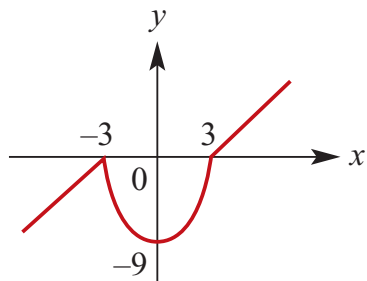

- b** Range = \mathbb{R}

- 6 a** Range = $(-\infty, 0) \cup (2, \infty)$

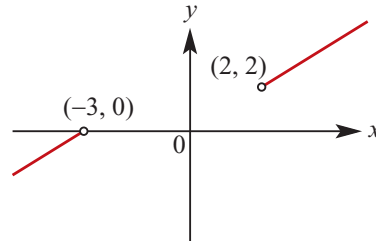

- b** Range = $\mathbb{R} \setminus \{0\}$

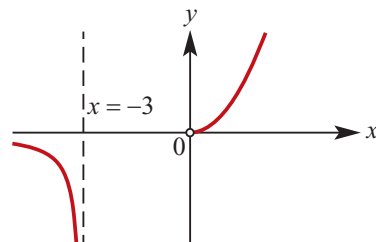

- c** Range = $(-\infty, 5]$

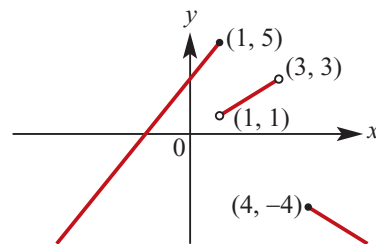

- d** Range = $\mathbb{R} \setminus [0, 1]$

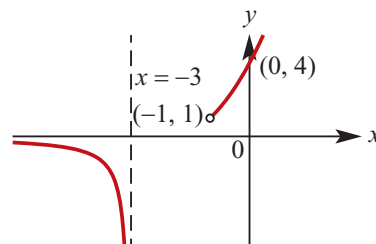

- 7 a** $f(x) = \frac{1}{x}, x > 1$
 $f(x) = x, x \leq 1$

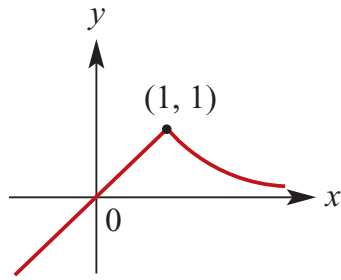

b Range = $(-\infty, 1]$

8 Line connecting $(-3, 0)$ and $(-1, 2)$ has
 gradient = $\frac{2-0}{-1-(-3)} = 1$
 Using $(-3, 0)$: $y - 0 = 1(x - -3)$
 $\therefore y = x + 3$ for $[-3, -1]$

Line connecting $(-1, 2)$ and $(2, -1)$ has
 gradient = $\frac{-1-2}{2-(-1)} = -1$

Using $(-1, 2)$: $y - 2 = -1(x - -1)$
 $\therefore y = 1 - x$ for $[-1, 2]$

Line connecting $(2, -1)$ and $(4, -2)$ has
 gradient = $\frac{-2-(-1)}{4-2} = -\frac{1}{2}$

Using $(2, -1)$: $y + 1 = -\frac{1}{2}(x - 2)$

$\therefore y = -\frac{x}{2}$ for $[2, 4]$

$$f(x) = \begin{cases} x + 3; & -3 \leq x < -1 \\ 1 - x; & -1 \leq x < 2 \\ -\frac{x}{2}; & 2 \leq x \leq 4 \end{cases}$$

Solutions to Exercise 5F

1 a $L(C) = 0.002C + 25; -273 \leq C \leq 1000$

Most metals will melt at over 1000 degrees and $C = -273$ is absolute zero.

b i $L(30) = (0.002)30 + 25 = 25.06$ cm

ii $L(16) = (0.002)16 + 25 = 25.032$ cm

iii $L(100) = (0.002)100 + 25 = 25.20$ cm

iv $L(500) = (0.002)500 + 25 = 26.00$ cm

2 a $f(x) = a + bx$

$$f(4) = -1 \quad \therefore a + 4b = -1$$

$$f(8) = 1 \quad \therefore a + 8b = 1$$

$$\underline{\hspace{1.5cm} \therefore 4b = 2}$$

$$\therefore b = \frac{1}{2}; a = -3$$

b $f(x) = 0, \therefore \frac{x}{2} - 3 = 0$

$$\therefore x = 6$$

3 If (fx) is parallel to $g(x) = 2 - 5x$ then the gradient of $f(x) = -5$ and

$$f(x) = -5x + c$$

$$f(0) = 7, \therefore c = 7$$

$$f(x) = -5x + 7$$

4 $f(x) = ax + b$

$$f(-5) = -12 \quad \therefore -5a + b = -12$$

$$f(7) = 6 \quad \therefore 7a + b = 6$$

$$\underline{\hspace{1.5cm} \therefore 12a = 18}$$

a i $f(0) = b = -\frac{9}{2}$

ii $f(1) = \frac{3}{2} - \frac{9}{2} = -3$

b $f(x) = \frac{1}{2}(3x - 9) = 0$
 $\therefore 3x - 9 = 0, \therefore x = 3$

5 $f(x) = a(x - b)(x - c)$

$$f(2) = f(4) = 0 \text{ so } b = 2, c = 4$$

If 7 is maximum then $a < 0$; Max.

occurs halfway between 2 and 4, i.e. at $x = 3$:

$$f(x) = a(3 - 2)(3 - 4) = 7 -$$

$$\therefore a = -7$$

$$\therefore f(x) = -7(x - 2)(x - 4)$$

OR $f(x) = -7x^2 + 42x - 56$

6 $f(x) = x^2 - 6x + 16$

$$= x^2 - 6x + 9 + 7$$

$$= (x - 3)^2 + 7$$

Range of $f = [7, \infty)$

7 $f: \mathbb{R} \rightarrow \mathbb{R}, f(x) = m(x - p)(x - q)$

$$f(4) = f(5) = 0, \text{ so } p = 4, q = 5$$

$$f(0) = 2, \text{ so } mpq = 2 \text{ and } m = 0.1$$

$$f(x) = 0.1(x - 4)(x - 5)$$

$$= 0.1(x^2 - 9x + 20)$$

$$= 0.1x^2 - 0.9x + 2$$

$$a = 0.1, b = -0.9, c = 2$$

OR Use $f(0) = 2$ so $c = 2$:

$$f(4) = 0, \text{ so } 16a + 4b + 2 = 0$$

$$f(5) = 0, \text{ so } 25a + 9b + 2 = 0$$

and use simultaneous equations or matrices.

8 $f(x) = ax^2 + bx + c$
 $f(0) = 10$ so $c = 10$
Max. value = 18 at $x = -\frac{b}{2a}$:
 $f\left(-\frac{b}{2a}\right) = 18$

$$= a\left(-\frac{b}{2a}\right)^2 + b\left(-\frac{b}{2a}\right) + 10$$

$$= \frac{b^2}{4a} - \frac{b^2}{2a} + 10$$

$$= -\frac{b^2}{4a} + 10$$

$\therefore -\frac{b^2}{4a} = 8$
 $\therefore b^2 = -32a \dots (1)$
 $f(1) = 0$
 $\therefore a + b + 10 = 0$
 $\therefore b = -10 - a$
 $\therefore b^2 = (10 + a)^2 \dots (2)$
Equate (1) and (2):
 $\therefore (10 + a)^2 = -32a$
 $\therefore a^2 + 20a + 100 = -32a$
 $\therefore a^2 + 52a + 100 = 0$
 $\therefore (a + 50)(a + 2) = 0$
 $\therefore a = -2, -50$
If $a = -2, b = -8$; if $a = -50, b = 40$
 $\therefore f(x) = -2x^2 - 8x + 10$
 $g(x) = -50x^2 + 40x + 10$
OR $f(x) = -2(x - 1)(x + 5)$
 $g(x) = -10(5x + 1)(x - 1)$

9 a $f(x) = 3x^2 - 5x - k$
 $f(x) > 1$ for all real x
So $f(x) - 1 > 0$ for all real x
 $3x^2 - 5x - (k + 1) > 0$ for all real x .
Then there are two real solutions to the equation $3x^2 - 5x - (k + 1) = 0$,

so $\Delta < 0$.
 $\therefore 12k < -37$
 $\therefore k < -\frac{37}{12}$
 < 0 if $k < -\frac{37}{12}$

b $a > 0$ so the curve is an upright parabola, so the vertex is the minimum value which occurs at $x = -\frac{b}{2a}$
For $a = 3$ and $b = -5, x = \frac{5}{6}$
 $f\left(\frac{5}{6}\right) = 3\left(\frac{5}{6}\right)^2 - 5\left(\frac{5}{6}\right) - k = 0$
 $\therefore \frac{25}{12} - \frac{25}{6} - k = 0$
 $\therefore k = -\frac{25}{12}$

Solutions to Exercise 5G

1 a $\{(3, 1), (6, -2), (5, 4), (1, 7)\}$
 Domain = $\{3, 6, 5, 1\}$; Range
 = $\{1, -2, 4, 7\}$

b $\{(3, 2), (6, -1), (-5, 4), (7, 1), (-4, 6)\}$
 Domain = $\{3, 6, -5, 7, -4\}$
 Range = $\{-1, 1, 2, 4, 6\}$

c $\{(3, 3), (-4, -2), (-1, -1), (1, -8)\}$
 Domain = $\{3, 1, -1, -4\}$
 Range = $\{3, -2, -1, -8\}$

d
 $\{(3, 1), (-7, -10), (-6, -7), (8, 2), (4, 11)\}$
 Domain = $\{3, -7, -6, 8, 4\}$
 Range = $\{1, -10, -7, 2, 11\}$

2 a $f: \mathbb{R} \rightarrow \mathbb{R}, f(x) = 6 - 2x$ has inverse:
 $x = 6 - 2y, \therefore y = 3 - \frac{x}{2}$
 $\therefore f^{-1}(x) = 3 - \frac{x}{2}$
 Domain = \mathbb{R} , Range = \mathbb{R}

b $f: [1, 5] \rightarrow \mathbb{R}, f(x) = 3 - x$ has
 inverse:
 $x = 3 - y, \therefore y = 3 - x$
 $\therefore f^{-1}(x) = 3 - x$
 Domain = $[-2, 2]$ (Range of f),
 Range = $[1, 5]$ (Domain of f)

c $f: \mathbb{R}^+ \rightarrow \mathbb{R}, f(x) = x + 4$ has inverse:
 $x = y + 4, \therefore y = x - 4$
 $\therefore f^{-1}(x) = x - 4$
 Domain = $(4, \infty)$ (Range of f),
 Range = \mathbb{R}^+ (Domain of f)

d $f: (-\infty, 4] \rightarrow \mathbb{R}, f(x) = x + 4$ has
 inverse:
 $f^{-1}(x) = x - 4$
 Domain = $(-\infty, 8]$ (Range of f),

Range = $(-\infty, 4)$ (Domain of f)

e $f: [-1, 7] \rightarrow \mathbb{R}, f(x) = 16 - 2x$
 $x = 16 - 2y$
 $\therefore 2y = 16 - x$
 $\therefore y = 8 - \frac{x}{2}$

$\therefore f^{-1}(x) = 8 - \frac{x}{2}$
 Domain = $[2, 18]$ (Range of f),
 Range = $[-1, 7]$ (Domain of f)

3 a $f: [0, \infty) \rightarrow \mathbb{R}, f(x) = x^2$
 $x = y^2, \therefore y = \sqrt{x}$
 $\therefore f^{-1}(x) = \sqrt{x}$
 Domain = $[0, \infty)$ (Range of f),
 Range = $[0, \infty)$ (Domain of f)

b $f: [2, \infty) \rightarrow \mathbb{R}, f(x) = (x - 2)^2 + 3$
 $x = (y - 2)^2 + 3$
 $\therefore (y - 2)^2 = x - 3$
 $\therefore y - 2 = \sqrt{x - 3}$
 $\therefore y = \sqrt{x - 3} + 2$
 $\therefore f^{-1}(x) = \sqrt{x - 3} + 2$
 Domain = $[3, \infty)$ (Range of f),
 Range = $[2, \infty)$ (Domain of f)

c $f: (-\infty, 4] \rightarrow \mathbb{R}, f(x) = (x - 4)^2 + 6$
 $x = (y - 4)^2 + 6$
 $\therefore x - 6 = (y - 4)^2$
 $\therefore y - 4 = -\sqrt{x - 6}$
 This time we need the negative
 square root because of the Domain
 of f , which is restricted to the
 left-hand side of the graph.
 $\therefore y = 4 - \sqrt{x - 6}$
 $\therefore f^{-1}(x) = 4 - \sqrt{x - 6}$

Domain = $[6, \infty)$ (Range of f),
 Range = $(-\infty, 4]$ (Domain of f)

d $f: [0, 1] \rightarrow \mathbb{R}, f(x) = \sqrt{1-x}$
 $x = \sqrt{1-y}$

$\therefore x^2 = 1 - y$

$\therefore y = 1 - x^2$

$\therefore f^{-1}(x) = 1 - x^2$

Domain = $[0, 1]$ (Range of f),
 Range = $[0, 1]$ (Domain of f)

e $f: [0, 4] \rightarrow \mathbb{R}, f(x) = \sqrt{16-x^2}$
 $x = \sqrt{16-y^2}$

$\therefore x^2 = 16 - y^2$

$\therefore y^2 = 16 - x^2$

$\therefore y = \sqrt{16 - x^2}$

$\therefore f^{-1}(x) = \sqrt{16 - x^2}$

Domain = $[0, 4]$ (Range of f),
 Range = $[0, 4]$ (Domain of f)

f $f: [0, \infty) \rightarrow \mathbb{R}, f(x) = (x+4)^2 + 6$
 $x = (y+4)^2 + 6$

$\therefore x - 6 = (y+4)^2$

$\therefore y + 4 = \sqrt{x-6}$

$\therefore y = \sqrt{x-6} - 4$

$\therefore f^{-1}(x) = \sqrt{x-6} - 4$

Domain = $[22, \infty)$ (Range of f),
 Range = $[0, \infty)$ (Domain of f)

4 a

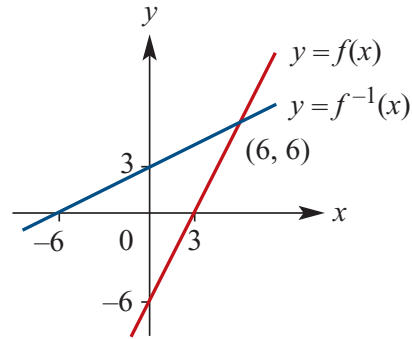

b $f(x) = f^{-1}(x)$ when $2x - 6 = \frac{x}{2} + 3$

$\therefore \frac{3x}{2} = \therefore 9, x = 6$

When $x = 6, y = 6$ so $(6, 6)$

5 a $f: [0, \infty) \rightarrow \mathbb{R}, f(x) = x^2$

$\therefore f^{-1}(x) = \sqrt{x}$

Positive roots because Domain of f is positive.

$y = f(x)$ (red curve);

$y = f^{-1}(x)$ (blue curve)

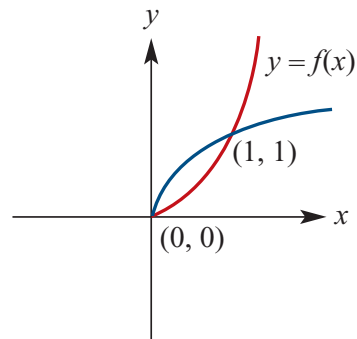

b $f(x) = f^{-1}(x)$ where $x^2 = \sqrt{x}$

$\therefore x^4 = x, \therefore x^4 - x = 0$

$\therefore x(x^3 - 1) = 0$

$\therefore x = 0, 1$

i.e. at $(0, 0)$ and $(1, 1)$

6 $f: \mathbb{R} \rightarrow \mathbb{R}, f(x) = ax + b, a, b \neq 0$

$f(1) = 2, \therefore a + b = 2$

$f^{-1}(x) = \frac{x-b}{a}$

$$f^{-1}(1) = \frac{1-b}{a} = 3$$

$$\therefore 1 - b = 3a$$

$$\therefore 3a + b = 1$$

$$\frac{a + b = 2}{}$$

$$\therefore 2a = -1$$

$$\therefore a = -\frac{1}{2}; b = \frac{5}{2}$$

7 $f: (-\infty, a] \rightarrow \mathbb{R}, f(x) = \sqrt{a-x}$

a $x = \sqrt{a-y}$

$$\therefore x^2 = a - y, \therefore y = a - x^2$$

$$f^{-1}(x) = a - x^2, x \geq 0 \text{ (to match Range of } f)$$

b At $x = 1: \sqrt{a-x} = a - x^2$

$$\therefore \sqrt{a-1} = a - 1$$

$$\therefore a - 1 = (a - 1)^2$$

$$\therefore a^2 - 2a + 1 - a + 1 = 0$$

$$\therefore a^2 - 3a + 2 = 0$$

$$\therefore (a - 2)(a - 1) = 0$$

$$\therefore a = 1, 2$$

Solutions to Exercise 5H

1 $C = 0.15n + 45$ where n is the number of calls

$$2 \text{ a } C = \begin{cases} 1.2 & 0 < m \leq 20 \\ 2 & 20 < m \leq 50 \\ 3 & 50 < m \leq 150 \end{cases}$$

b

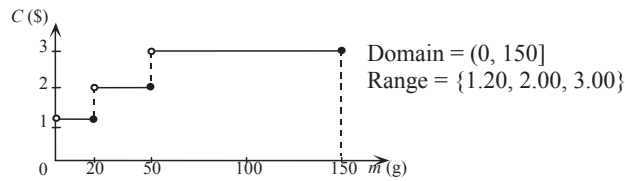

3 a $C_1 = 0.25x + 64$
 $C_2 = 89$

b $0.25x + 64 = 89$
implies $0.25x = 25$
 $\therefore x = 100$

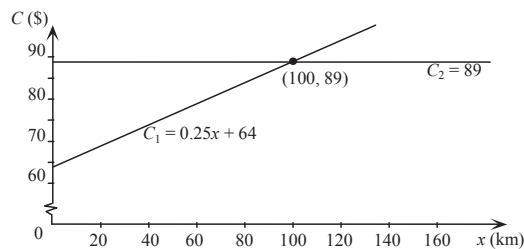

c Method 2 is cheaper than Method 1 if more than 100 km per day is travelled.

4 a Length = $(50 - x)$ cm

b $A(x) = x(50 - x)$

c $0 \leq x \leq 50$

d Maximum area = 625 cm^2 when $x = 25$

5 a i $A = (8 + x)y - x^2$

ii $P = y + (8 + x) + (y - x) + x + x + 8 = 2x + 2y + 16$

b i

If $P = 64$, $64 = 2x + 2y + 16$

$\therefore 48 = 2(x + y)$

$\therefore 24 = x + y$

$\therefore y = 24 - x$

When $y = 24 - x$,

$A = (8 + x)(24 - x) - x^2$

$= 192 + 16x - 2x^2$

ii We know $y = 24 - x$

$\therefore x < 24$

Also $y - x > 0$, i.e. $24 - 2x > 0$

$\therefore x < 12$

The allowable values for x are

$\{x: 0 < x < 12\}$.

iii Turning point is at $x = \frac{-b}{2a}$

and $a = -2, b = 16 \therefore x = \frac{-16}{-4}$

$= 4$

When $x = 4$, $A = 192 + 16(4) - 2(4)^2$
 $= 192 + 64 - 32 = 224$

When $x = 0$, $A = 192$

When $x = 12$, $A = 192 + 16(12) - 2(12)^2$
 $= 192 + 192 - 288 = 96$

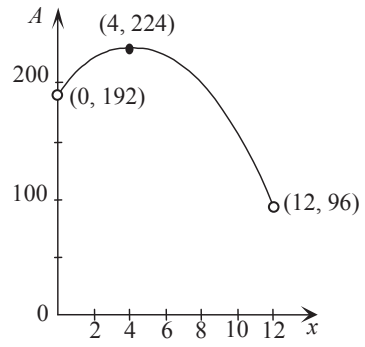

- iv** The maximum area occurs at the Turning point and is 224 cm^2 .

Solutions to Technology-free questions

1 a $[-2, 4)$

b $[-2, 4]$

c $[1, 8]$

d $(-1, 6]$

e $(-4, -2] \cup (1, 5]$

f $(-4, -2] \cup (2, \infty)$

g $(-\infty, -3] \cup (1, \infty)$

2 a $f(3) = 2 - 6(3) = -16$

b $f(-4) = 2 - 6(-4) = 26$

c $f(x) = 2 - 6x = 6$

$$\therefore -6x = 4$$

$$\therefore x = -\frac{2}{3}$$

3 $f: [-1, 6] \rightarrow \mathbb{R}, f(x) = 6 - x$

a

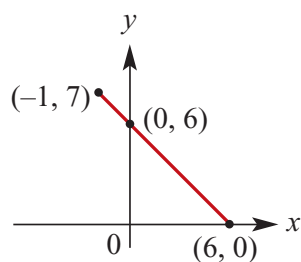

b Range of $f = [0, 7]$

4 a $\{(x, y): 3x + y = 6\}; \text{Range} = \mathbb{R}$

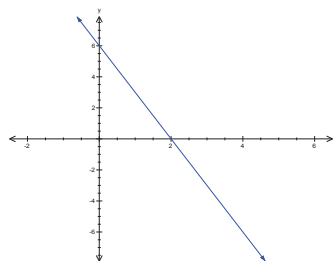

b $\{(x, y): y = 3x - 2; x \in [-1, 2]\};$

Range = $[-5, 4]$

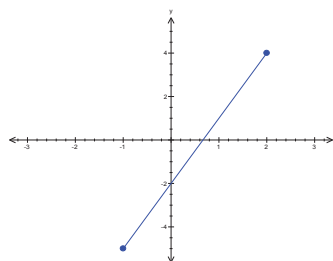

c $\{(x, y) : y = x^2; x \in [-2, 2]\}$;
Range = $[0, 4]$

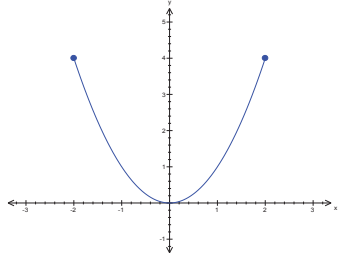

d $\{(x, y) : y = 9 - x^2\}$;
Range = $(-\infty, 9]$

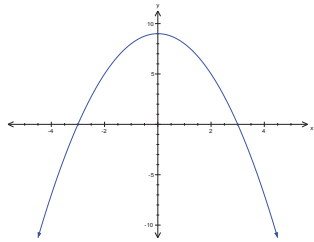

e $\{(x, y) : y = x^2 + 4x + 6\}$;
Range = $[2, \infty)$

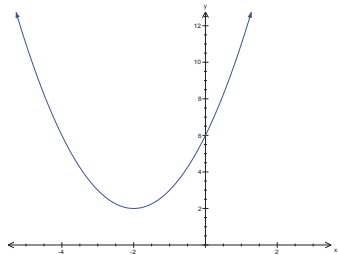

f $\{(1, 2)(3, 4)(2, -6)\}$;
Range = $\{-6, 2, 4\}$

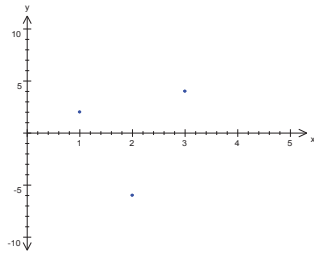

g $f : \mathbb{R} \rightarrow \mathbb{R}, f(x) = (x - 2)^2$
Range = $[0, \infty)$

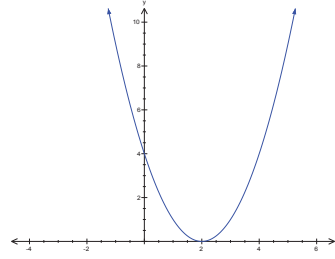

h $f : \mathbb{R} \setminus \{0\} \rightarrow \mathbb{R}, f(x) = \frac{1}{x} + 2$
Range = $\mathbb{R} \setminus \{2\}$

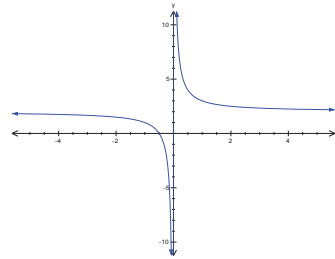

i $\left(x - \frac{1}{2}\right)^2 + (y + 2)^2 = 9$
Range = $[-5, 1]$

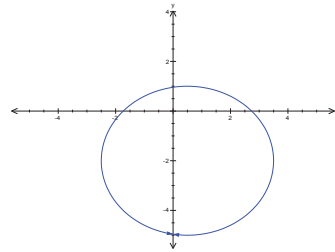

j $f : [-1, 3] \rightarrow \mathbb{R}, f(x) = x$
Range = $[-1, 3]$

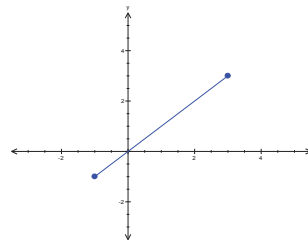

5 a $f(x) = \frac{a}{x} + b$
 $f(1) = \frac{3}{2}, \therefore f(1) = a + b = \frac{3}{2}$

$$\begin{aligned} \therefore b &= \frac{3}{2} - a \\ f(2) &= 9, \therefore f(2) = \frac{a}{2} + b = 9 \\ \therefore \frac{a}{2} + \left(\frac{3}{2} - a\right) &= 9 \\ \therefore \frac{3}{2} - \frac{a}{2} &= 9 \\ \therefore 3 - a &= 18 \\ \therefore a &= -15; b = \frac{33}{2} \end{aligned}$$

b Implied Domain of f is $\mathbb{R} \setminus \{0\}$.

6 $f: [0, 2] \rightarrow \mathbb{R}, f(x) = 2x - x^2$

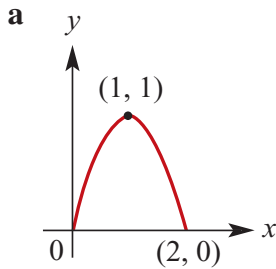

b Range = $[0, 1]$

7 $f(x) = ax + b$

$$f(5) = 10, \therefore 5a + b = 10$$

$$f(1) = -2 \therefore a + b = -2$$

$$\therefore \frac{4a}{4} = 12$$

$$a = 3, b = -5$$

8 $f(x) = ax^2 + bx + c$

$$f(0) = 0, \therefore c = 0$$

$$f(4) = 0, \therefore 16a + 4b = 0$$

$$\therefore 4a + b = 0$$

$$f(-2) = -6 \therefore 4a - 2b = -6$$

$$\therefore 3b = 6$$

$$\therefore b = 2; 4a = -2$$

$$a = -\frac{1}{2}, b = 2, c = 0$$

9 a $y = \frac{1}{x-2}$;

$$\text{implied Domain} = \mathbb{R} \setminus \{2\}$$

b $f(x) = \sqrt{x-2}$;

$$\text{implied Domain} = [2, \infty)$$

c $y = \sqrt{25-x^2}$;

$$\text{implied Domain} = [-5, 5] \text{ since } 25 - x^2 \geq 0$$

d $f(x) = \frac{1}{2x-1}$;

$$\text{implied Domain} = \mathbb{R} \setminus \left\{\frac{1}{2}\right\}$$

e $g(x) = \sqrt{100-x^2}$;

$$\text{implied Domain} = [-10, 10]$$

f $h(x) = \sqrt{4-x}$;

$$\text{implied Domain} = (-\infty, 4]$$

10 a $y = x^2 + 2x + 3$ is many $\rightarrow 1$ (full parabola)

b $f: [2, \infty) \rightarrow \mathbb{R}, f(x) = (x-2)^2$ is $1 \rightarrow 1$ since we only have the right side of the parabola.

c $f(x) = 3x + 2$ is $1 \rightarrow 1$ (oblique line)

d $f(x) = \sqrt{x-2}$ is $1 \rightarrow 1$ (half-parabola only)

e $f(x) = \frac{1}{x-2}$ is $1 \rightarrow 1$ (rectangular hyperbola)

f $f: [-1, \infty) \rightarrow \mathbb{R}, f(x) = (x+2)^2$ is $1 \rightarrow 1$ since we only have part of the right side of the parabola (vertex at $x = -2$).

g $f: [-3, 5] \rightarrow \mathbb{R}, f(x) = 3x - 2$ is $1 \rightarrow 1$ (oblique line)

h $f(x) = 7 - x^2$ is many $\rightarrow 1$ (full

parabola)

i $f(x) = \frac{1}{(x-2)^2}$ is many $\rightarrow 1$ (full truncus)

j $h(x) = \frac{1}{x-2} + 4$ is 1 $\rightarrow 1$ (rectangular hyperbola)

11 a $f(x) = \begin{cases} 3x - 1; & x \in [0, \infty) \\ x^2; & x \in [-3, 0) \\ 9; & x \in (-\infty, -3) \end{cases}$

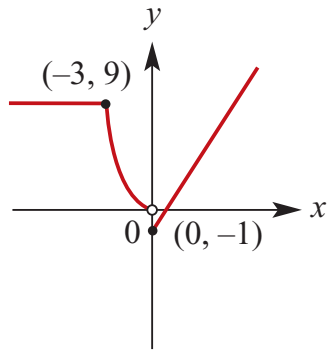

b $h(x) = \begin{cases} 1 - 2x; & x \in [0, \infty) \\ x^2; & x \in [-3, 0) \\ -x^2; & x \in (-\infty, -3) \end{cases}$

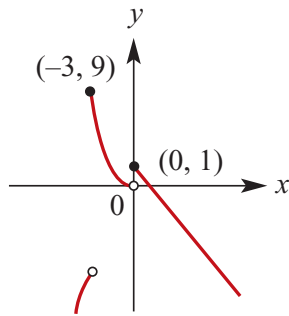

12 a Range = $[0, 4]$

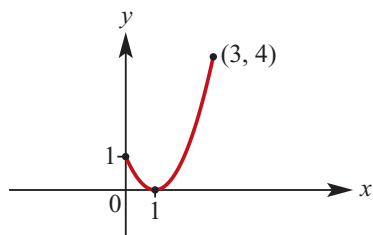

b Range = $[1, 10]$

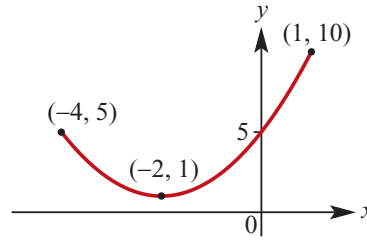

c Range = $[\frac{1}{81}, 1]$

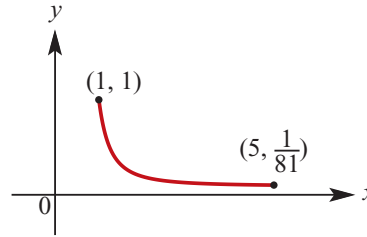

d Range = $[-6, 3]$

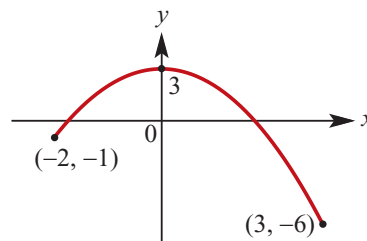

13 a Domain = $[1, \infty)$; Range = $[0, \infty)$

b Domain = $(-\infty, 1]$; Range = $[0, \infty)$

c Domain = $[0, \infty)$; Range = $(-\infty, 1]$

14 a Domain = $\mathbb{R} \setminus \{1\}$; Range = $\mathbb{R} \setminus \{0\}$

b Domain = $\mathbb{R} \setminus \{-1\}$; Range = $\mathbb{R} \setminus \{0\}$

c Domain = $\mathbb{R} \setminus \{1\}$; Range = $\mathbb{R} \setminus \{3\}$

15 a Domain = $[-1, 1]$; Range = $[0, 1]$

b Domain = $[-3, 3]$; Range = $[0, 3]$

c Domain = $[-1, 1]$; Range = $[3, 4]$

16 a $f: [-1, 5] \rightarrow \mathbb{R}, f(x) = 3x - 2$

Range of $f = [-5, 13]$

= Domain of inverse

$$x = 3y - 2$$

$$\therefore 3y = x + 2$$

$$\therefore y = \frac{x + 2}{3}$$

$$\therefore f^{-1}(x) = \frac{x + 2}{3}$$

Domain = $[-5, 13]$

b $f: [-2, \infty) \rightarrow \mathbb{R}, f(x) = \sqrt{x + 2} + 2$

Range of $f = [2, \infty)$

= Domain of inverse

$$x = \sqrt{y + 2} + 2$$

$$\therefore x - 2 = \sqrt{y + 2}$$

$$\therefore y + 2 = (x - 2)^2$$

$$\therefore f^{-1}(x) = (x - 2)^2 - 2$$

or (or $x^2 - 4x + 2$)

Domain = $[2, \infty)$

c $f: [-1, \infty) \rightarrow \mathbb{R}, f(x) = 3(x + 1)^2$

Range of $f = [0, \infty)$

= Domain of inverse

$$x = 3(y + 1)^2$$

$$\therefore (y + 1)^2 = \frac{x}{3}$$

$$\therefore y + 1 = \sqrt{\frac{x}{3}}$$

$$\therefore f^{-1}(x) = \sqrt{\frac{x}{3}} - 1$$

Domain = $[0, \infty)$

d $f: (-\infty, 1) \rightarrow \mathbb{R}, f(x) = (x - 1)^2$

Range of $f = (0, \infty)$

= Domain of inverse

$$x = (y - 1)^2$$

$$\therefore -\sqrt{x} = y - 1$$

$$\therefore f^{-1}(x) = 1 - \sqrt{x}$$

Domain = $(0, \infty)$

We need the negative root here

because $f(x)$ is the left side of the parabola.

17 $f(x) = 2x + 5$

a $f(p) = 2p + 5$

b $f(p + h) = 2p + 2h + 5$

c $f(p + h) - f(p)$
 $= (2p + 2h + 5) - (2p + 5) = 2h$

d $f(p + 1) - f(p)$
 $= (2p + 2 + 5) - (2p + 5) = 2$

18 $f(x) = 3 - 2x$

$$f(p + 1) - f(p)$$

$$= (3 - 2(p + 1)) - (3 - 2p)$$

$$= 3 - 2p - 2 - 3 + 2p$$

$$= -2$$

19 a $f(x) = -2x^2 + x - 2$

$$= -2\left(x^2 - \frac{x}{2} + 1\right)$$

$$= -2\left(x^2 - \frac{x}{2} + \frac{1}{16} + \frac{15}{16}\right)$$

$$= -2\left(x - \frac{1}{4}\right)^2 - \frac{15}{8}$$

Range of $f = \left(-\infty, -\frac{15}{8}\right]$

b $f(x) = 2x^2 - x + 4$

$$= 2\left(x^2 - \frac{x}{2} + 2\right)$$

$$= 2\left(x^2 - \frac{x}{2} + \frac{1}{16} + \frac{31}{16}\right)$$

$$= 2\left(x - \frac{1}{4}\right)^2 + \frac{31}{8}$$

Range of $f = \left[\frac{31}{8}, \infty\right)$

c $f(x) = -x^2 + 6x + 11$

$$= -(x^2 - 6x - 11)$$

$$= -(x^2 - 6x + 9 - 20)$$

$$= -(x - 3)^2 + 20$$

Range of $f = (-\infty, 20]$

d $g(x) = -2x^2 + 8x - 5$

$$= -2\left(x^2 - 4x + \frac{5}{2}\right)$$

$$= -2\left(x^2 - 4x + 4 - \frac{3}{2}\right)$$

$$= -2(x - 2)^2 + 3$$

Range of $g = (-\infty, 3]$

20 $f: [-1, 6] \rightarrow \mathbb{R}, f(x) = 5 - 3x$

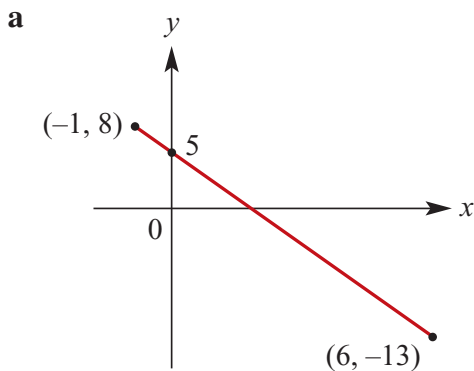

b Range of $f = [-13, 8]$

21 a $f: [-1, 8] \rightarrow \mathbb{R}, f(x) = (x - 2)^2$

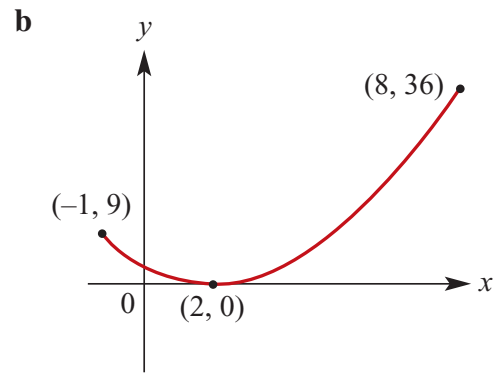

c Range of $f = [0, 36]$

22 a $x^2 + y^2 = 9$
 Circle: radius 3, centre (0, 0)
 Implied Domain = $[-3, 3]$,
 Range = $[-3, 3]$

b $(x - 2)^2 + y^2 = 1$
 Circle: radius 1, centre (2, 0)
 Implied Domain = $[1, 3]$,
 Range = $[-1, 1]$

c $(2x - 1)^2 + (2y - 1)^2 = 1$
 Circle: radius $\frac{1}{2}$, centre $\left(\frac{1}{2}, \frac{1}{2}\right)$
 Implied Domain = $[0, 1]$,
 Range = $[0, 1]$

d $(x - 4)^2 + y^2 = 25$
 Circle: radius 5, centre (4, 0)
 Implied Domain = $[-1, 9]$,
 Range = $[-5, 5]$

e $(y - 2)^2 + x^2 = 16$
 Circle: radius 4, centre (0, 2)
 Implied Domain = $[-4, 4]$,
 Range = $[-2, 6]$

23 Domain of the function f is $\{1, 2, 3, 4\}$

a $f(x) = 2x$ so Range = $\{2, 4, 6, 8\}$

b $f(x) = 5 - x$ so Range = $\{1, 2, 3, 4\}$

c $f(x) = x^2 - 4$ so Range =
 $\{-3, 0, 5, 12\}$

d $f(x) = \sqrt{x}$ so Range = $\{1, \sqrt{2}, \sqrt{3}, 2\}$

Solutions to multiple-choice questions

- 1 B** $f(x) = 10x^2 + 2$
 $\therefore f(2a) = 10(2a)^2 + 2$
 $= 40a^2 + 2$
- 2 E** Maximal Domain of $f(x) = \sqrt{3x+5}$
 is $[-\frac{5}{3}, \infty)$
- 3 D** Maximal Domain of $f(x) = \sqrt{6-2x}$
 is $[-\infty, 3]$
- 4 B** Range of $x^2 + y^2 > 9$ is *all* numbers
 outside the circle $x^2 + y^2 = 9$
 Hence Range is \mathbb{R} .
- 5 E** Range is $[1, 5]$
- 6 C** For $f(x) = 7x - 6, f^{-1}(x)$:
 $x = 7y - 6$
 $x + 6 = 7y$
 $\therefore y = \frac{x+6}{7}$
- 7 E** For $f: (a, b] \rightarrow \mathbb{R}, f(x) = 3 - x$
 Max. value of Range $> 3 - a$
 Min. value of Range $= 3 - b$
- 8 B** **B** is correct.
- A** $f(x) = 9 - x^2$ is $1 \rightarrow 1$ over $x \geq 0$
- B** $f(x) = \sqrt{9 - x^2}$ is many $\rightarrow 1$ for
 implied Domain $[-3, 3]$.
- C** $f(x) = 1 - 9x$ is a line and $1 \rightarrow 1$
- D** $f(x) = \sqrt{x}$ is $1 \rightarrow 1$
- E** $f(x) = \frac{9}{x}$ is $1 \rightarrow 1$ if Domain is
 $\mathbb{R}/\{0\}$
- 9 D** $y = \frac{2}{x} + 3$ is reflected in the x -axis:
 $y = -\frac{2}{x} - 3$
 and then in the y -axis:
 $y = -\frac{2}{-x} - 3 = \frac{2}{x} - 3$
- 10 C** For $f: [-1, 5) \rightarrow \mathbb{R}, f(x) = x^2$
 Min. value at $(0, 0)$;
 $f(-1) = 1; f(5) = 25$;
 the Range is $[0, 25)$.
- 11 D** **D** is correct.
- A** $y = x^2 - x$ is a many $\rightarrow 1$ function
- B** $y = \sqrt{4 - x^2}$ is a many $\rightarrow 1$
 function
- C** $y = 3, x > 0$ is a many $\rightarrow 1$
 function
- D** $x = 3$ is a $1 \rightarrow$ many relation
- E** $y = 3x$ is a $1 \rightarrow 1$ function

Solutions to extended-response questions

1 a For the first coach, $d = 80t$ for $0 \leq t \leq 4$

$$d = 320 \text{ for } 4 < t \leq 4\frac{3}{4}$$

$$d = 320 + 80\left(t - 4\frac{3}{4}\right) \text{ for } 4\frac{3}{4} < t \leq 7\frac{1}{4}$$

$$= 320 + 80t - 380 = 80t - 60$$

i.e. for the first coach, $d = \begin{cases} 80t & 0 \leq t \leq 4 \\ 320 & 4 < t \leq 4\frac{3}{4} \\ 80t - 60 & 4\frac{3}{4} < t \leq 7\frac{1}{4} \end{cases}$ Range: $[0, 520]$

For the second coach, $v = \frac{d}{t}$

$$= \frac{520}{5\frac{1}{2}} = \frac{1040}{11}$$

$$\therefore d = 520 - \frac{1040}{11}t, 0 \leq t \leq 5\frac{1}{2}, \text{ Range: } [0, 520]$$

b The point of intersection of the two graphs yields the time at which the two coaches pass and where this happens.

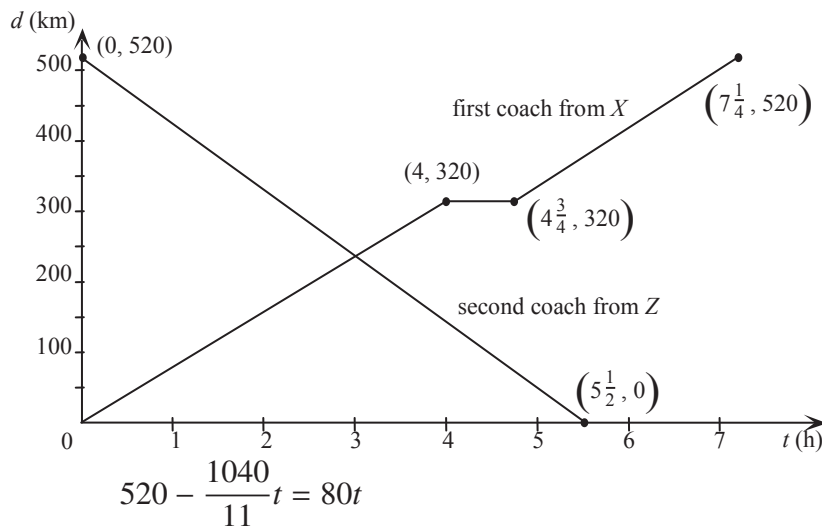

$$\therefore 520 = \frac{1920t}{11}$$

$$\therefore t = \frac{520 \times 11}{1920} = \frac{143}{48}$$

When $t = \frac{143}{48}$, $d = \frac{143}{48}$

$$= \frac{80 \times 11440}{48} = 238\frac{1}{3}$$

i.e. the two coaches pass each other $238\frac{1}{3}$ km from X.

2 a $P = \frac{1}{2}n, n \leq 200, n \in \mathbb{Z}$

b Domain = $\{n: n \in \mathbb{Z}, 0 \leq n \leq 200\}$

Range = $\{\frac{n}{2}: n \in \mathbb{Z}, 0 \leq n \leq 200\}$

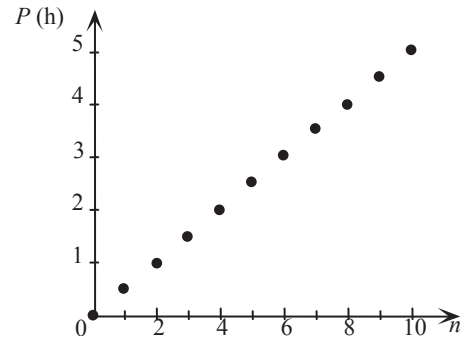

3 a i $C(n) = 5n + 1000, n > 0$

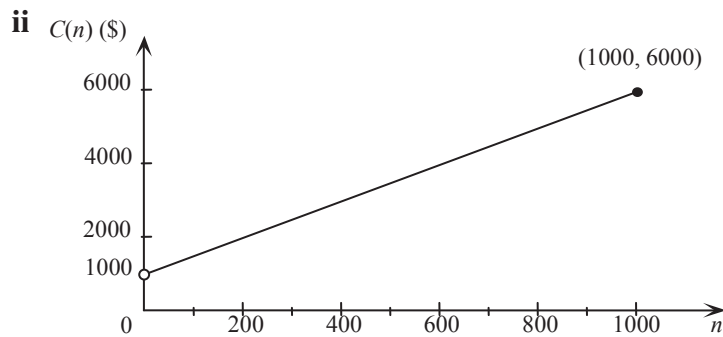

b i $P(n) = 15n - C(n)$

$$= 15n - (5n + 1000)$$

$$= 10n - 1000, n > 0$$

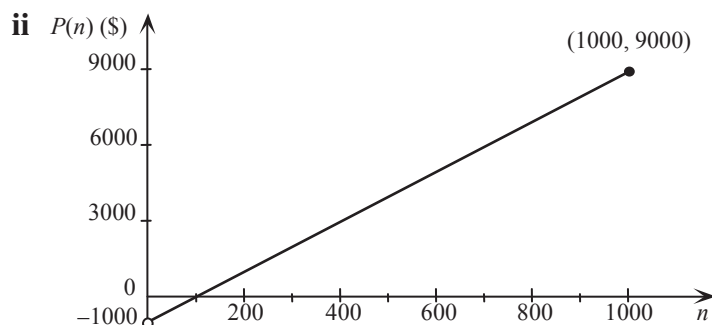

4 $V = 8000 - 0.05 \times 8000 \times n = 8000 - 400n, n \geq 0$

5 a $R = \text{price of ticket} \times \text{number of tickets sold}$

$$= (15 + x)(50\,000 - 2500x)$$

$$= 2500(x + 15)(20 - x), 0 \leq x \leq 20$$

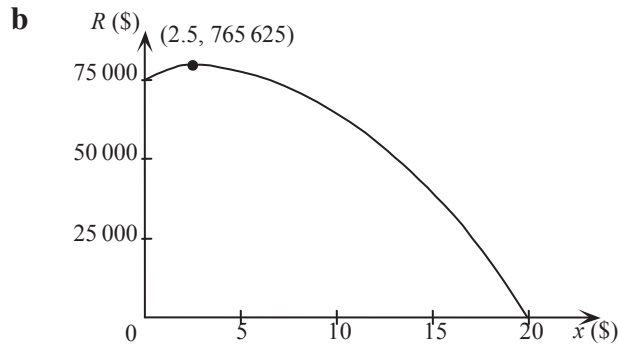

x -intercepts occur when $R = 0 \quad \therefore x = -15 \text{ or } 20$ (but $x \geq 0$, so $x = 20$)

R -intercept occurs when $x = 0 \quad \therefore R = 750\,000$

Turning point occurs when $x = \frac{-15 + 20}{2} = 2.5$

When $x = 2.5$, $R = 2500(2.5 + 15)(20 - 2.5) = 765\,625$

c The price which will maximise the revenue is \$ 17.50 (i.e. when $x = 2.5$).

This assumes that price can be increased by other than dollar amounts.

6 a $BE = CD = x$, as $BCDE$ is a rectangle.

$AB = AE = BE = x$,

as ABE is an equilateral triangle.

$DE = BC$, as $BCDE$ is a rectangle.

Perimeter of pentagon

$$= 3x + 2BC = a$$

$$\therefore BC = \frac{1}{2}(a - 3x)$$

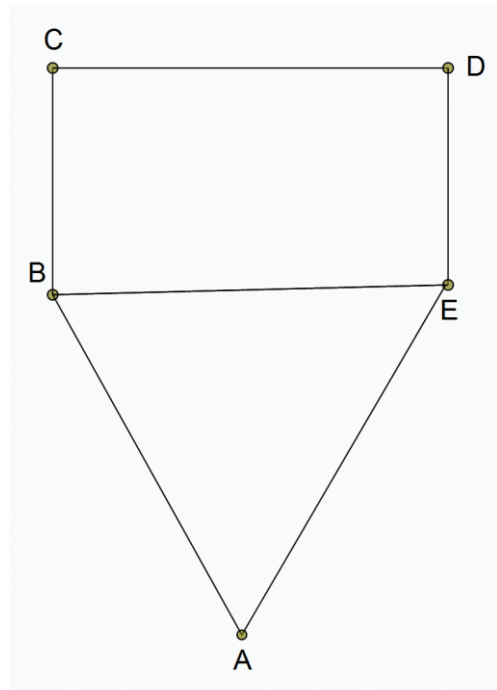

$$\begin{aligned}
A(x) &= \text{area of rectangle} + \text{area of triangle} \\
&= \text{length} \times \text{width} + \frac{1}{2} \text{base} \times \text{height} \\
&= x \times \frac{1}{2}(a - 3x) + \frac{1}{2}x \times \sqrt{x^2 - \left(\frac{1}{2}x\right)^2} \\
&= \frac{ax}{2} - \frac{3x^2}{2} + \frac{x}{2} \sqrt{x^2 \left(1 - \frac{1}{4}\right)} = \frac{ax}{2} - \frac{3x^2}{2} + \frac{x^2 \sqrt{3}}{4} \\
&= \frac{2ax - 6x^2 + x^2 \sqrt{3}}{4} \\
&= \frac{x}{4}(2a - (6 - \sqrt{3})x)
\end{aligned}$$

b From geometry: $x > 0$

Also $BC > 0$

So $a - 3x > 0$

Giving $x < \frac{a}{3}$

Therefore allowable values for x are $\{x: 0 < x < \frac{a}{3}\}$.

c Maximum area occurs when $x = \frac{0 + \frac{2a}{6 - \sqrt{3}}}{2} = \frac{a}{6 - \sqrt{3}}$

$$\begin{aligned}
\text{When } x = \frac{a}{6 - \sqrt{3}}, \quad A(x) &= \frac{a}{4(6 - \sqrt{3})} \left(2a - \frac{(6 - \sqrt{3})a}{6 - \sqrt{3}} \right) \\
&= \frac{a^2}{4(6 - \sqrt{3})}
\end{aligned}$$

i.e. the maximum area is $\frac{a^2}{4(6 - \sqrt{3})} \text{ cm}^2$.

7 a i $d(x) = AP + PD$

$$= \sqrt{AB^2 + BP^2} + \sqrt{PC^2 + CD^2}$$

$$= \sqrt{5^2 + x^2} + \sqrt{(16 - x)^2 + 3^2}$$

$$= \sqrt{x^2 + 25} + \sqrt{x^2 - 32x + 265}$$

ii $0 \leq BO \leq BC \quad \therefore 0 \leq x \leq 16$

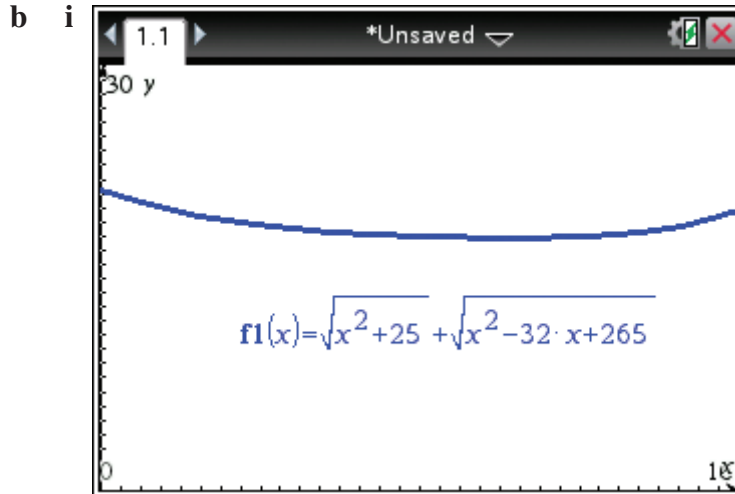

- ii On a CAS calculator, sketch the graphs of $f1 = \sqrt{x^2 + 25} + \sqrt{x^2 - 32x + 265}$ and $f2 = 20$. The point of intersection is $(1.5395797, 20)$. Therefore $d(x) = 20$ when $x \approx 1.54$.
Alternatively, enter **solve** $(\sqrt{x^2 + 25} + \sqrt{x^2 - 32x + 265} = 20, x)$ to find $x = \frac{80 \pm 25\sqrt{7}}{9} \approx 1.54, 16.24$
However, $0 \leq x \leq 16$, just one answer of 1.54.

- iii Repeat b ii using $f2 = 19$. The points of intersection are $(3.3968503, 19)$ and $(15.041245, 19)$. Therefore $d(x) = 19$ when $x \approx 3.40$ or $x \approx 15.04$.
Alternatively, enter **solve** $(\sqrt{x^2 + 25} + \sqrt{x^2 - 32x + 265} = 19, x)$ to find $x = \frac{1936 \pm 19\sqrt{4141}}{210} \approx 15.04, 3.40$

- c i with $f1 = \sqrt{x^2 + 25} + \sqrt{x^2 - 32x + 265}$
TI: Press **Menu** \rightarrow **6:Analyze Graph** \rightarrow **2:Minimum**
CP: Tap **Analysis** \rightarrow **G-Solve** \rightarrow **Min**
to yield $(9.9999998, 17.88544)$. Therefore the minimum value of $d(x)$ is 17.89 when $x \approx 10.00$.

- ii Range = $[17.89, 21.28]$. Exact answer is $[8\sqrt{5}, 5 + \sqrt{265}]$.

- 8 a On a CAS calculator, sketch the graphs of $f1 = (x + 1)(6 - x)$ and $f2 = 2x$.
Points of intersection are $(-1.372\ 281, -2.744\ 563)$ and $(4.372\ 281\ 3, 8.744\ 562\ 6)$.
The coordinates of A and B are $(4.37, 8.74)$ and $(-1.37, -2.74)$ respectively, correct to 2 decimal places.

Or consider $(x + 1)(6 - x) = 2x$

$$\begin{aligned} \therefore -x^2 + 5x + 6 &= 2x \\ \therefore x^2 - 3x - 6 &= 0 \\ \therefore x^2 - 3x + \frac{9}{4} - \frac{33}{4} &= 0 \\ \therefore \left(x - \frac{3}{2}\right)^2 - \left(\frac{\sqrt{33}}{2}\right)^2 &= 0 \\ \therefore \left(x - \frac{3}{2} + \frac{\sqrt{33}}{2}\right)\left(x - \frac{3}{2} - \frac{\sqrt{33}}{2}\right) &= 0 \\ \therefore x = \frac{3 \pm \sqrt{33}}{2} \quad \text{and} \quad y = 3 \pm \sqrt{33} \end{aligned}$$

yielding $A\left(\frac{3 + \sqrt{33}}{2}, 3 + \sqrt{33}\right), B\left(\frac{3 - \sqrt{33}}{2}, 3 - \sqrt{33}\right)$

b i $d(x) = (x + 1)(6 - x) - 2x$

$$\begin{aligned} &= 6x + 6 - x^2 - x - 2x \\ &= -x^2 + 3x + 6 \end{aligned}$$

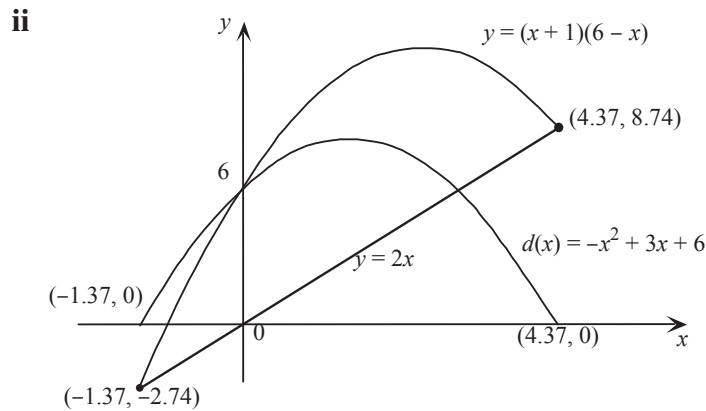

c i with $f1 = -x^2 + 3x + 6$,
TI: Press **Menu** → **6:Analyze Graph** → **3:Maximum**
CP: Tap **Analysis** → **G-Solve** → **Max**
to yield $(1.5000015, 8.25)$.
Therefore the maximum value of $d(x)$ is 8.25.

ii Range = $[0, 8.25]$

$$\begin{aligned}
 \mathbf{d} \quad d(x) &= (x + 1)(6 - x) - 5x \\
 &= 6x + 6 - x^2 - x - 5x \\
 &= -x^2 + 6
 \end{aligned}$$

The maximum value of $d(x)$ is 6 and the Range is $[0, 6]$.

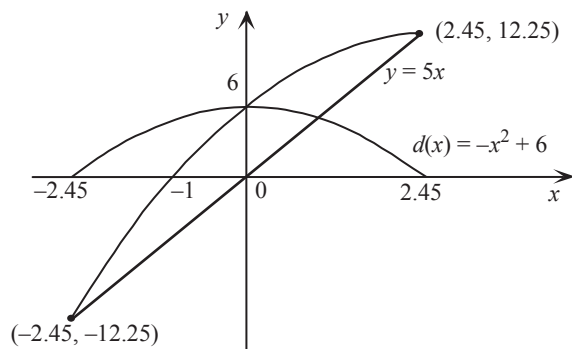

Chapter 6 – Polynomials

Solutions to Exercise 6A

1 $P(x) = x^3 - 3x^2 - 2x + 1$

a $P(1) = 1 - 3 - 2 + 1 = -3$

b $P(-1) = (-1)^3 - 3(-1)^2 - 2(-1) + 1$
 $= -1 - 3 + 2 + 1$
 $= -1$

c $P(2) = (2)^3 - 3(2)^2 - 2(2) + 1$
 $= 8 - 12 - 4 + 1$
 $= -7$

d $P(-2) = (-2)^3 - 3(-2)^2 - 2(-2) + 1$
 $= -8 - 12 + 4 + 1$
 $= -15$

b $P(1) = (1)^3 + 4(1)^2 - 2(1) + 6$
 $= 9$

c $P(2) = (2)^3 + 4(2)^2 - 2(2) + 6$
 $= 26$

d $P(-1) = (-1)^3 + 4(-1)^2 - 2(-1) + 6$
 $= -1 + 4 + 2 + 6$
 $= 11$

e $P(a) = (a)^3 + 4(a)^2 - 2(a) + 6$
 $= a^3 + 4a^2 - 2a + 6$

f $P(2a) = (2a)^3 + 4(2a)^2 - 2(2a) + 6$
 $= 8a^3 + 16a^2 - 4a + 6$

2 $P(x) = 8x^3 - 4x^2 - 2x + 1$

a $P\left(\frac{1}{2}\right) = 8\left(\frac{1}{2}\right)^3 - 4\left(\frac{1}{2}\right)^2 - 2\left(\frac{1}{2}\right) + 1$
 $= 8 \times \frac{1}{8} - 4 \times \frac{1}{4} - 2 \times \frac{1}{2} + 1$
 $= 0$

b $P\left(-\frac{1}{2}\right) = 8\left(-\frac{1}{2}\right)^3 - 4\left(-\frac{1}{2}\right)^2 - 2\left(-\frac{1}{2}\right) + 1$
 $= 8 \times \left(-\frac{1}{8}\right) - 4 \times \frac{1}{4} + 2 \times \frac{1}{2} + 1$
 $= 0$

3 $P(x) = x^3 + 4x^2 - 2x + 6$

a $P(0) = (0)^3 + 4(0)^2 - 2(0) + 6$
 $= 6$

4 a $P(x) = x^3 + 5x^2 - ax - 20$ and
 $P(2) = 0$

$$\therefore 2^3 + 5 \times (2)^2 - 2a - 20 = 0$$
$$\therefore 8 - 2a = 0$$
$$\therefore a = 4$$

b $P(x) = 2x^3 + ax^2 - 5x - 7$ and
 $P(3) = 68$

$$\therefore 2 \times 3^3 + a \times (3)^2 - 5 \times 3 - 7 = 68$$
$$\therefore 9a = 36$$
$$\therefore a = 4$$

c $P(x) = x^4 + x^3 - 2x + c$ and $P(1) = 6$
 $\therefore 1 + 1 - 2 + c = 6$

$$\therefore c = 6$$

d $P(x) = 3x^6 - 5x^3 + ax^2 + bx + 10$ and
 $P(-1) = P(2) = 0$

$$P(-1) = 0 \text{ implies } a - b = -18 \dots (1)$$

$$P(2) = 0 \text{ implies } 4a + 2b = -162 \text{ and}$$

$$\text{thus } 2a + b = -81 \dots (2)$$

Add equations (1) and (2)

$$3a = -99$$

$$\text{Hence } a = -33$$

$$\text{Substitute in (1) to find } b = -15$$

e Let $P(x) = x^5 - 3x^4 + ax^3 + bx^2 + 24x - 36$

$$P(3) = P(1) = 0$$

$$P(3)$$

$$= 3^5 - 3 \times 3^4 + 3^3a + 3^2b + 24 \times 3 - 36$$

$$= 243 - 243 + 27a + 9b + 72 - 36$$

$$= 9(3a + b + 4)$$

$$P(1)$$

$$= 1^5 - 3 \times 1^4 + 1^3a + 1^2b + 24 \times 1 - 36$$

$$= 1 - 3 + a + b + 24 - 36$$

$$= a + b - 14$$

We have the simultaneous equations

$$3a + b = -4 \dots (1)$$

$$a + b = 14 \dots (2)$$

Subtract equation (1) from equation

(2)

$$2a = -18$$

$$\therefore a = -9 \text{ and } b = 23.$$

5 $f(x) = x^3 - 2x^2 + x, g(x) = 2 - 3x$ and
 $h(x) = x^2 + x$

a $f(x) + g(x) = x^3 - 2x^2 + x + 2 - 3x$
 $= x^3 - 2x^2 - 2x + 2$

b $f(x) + h(x) = x^3 - 2x^2 + x + x^2 + x$
 $= x^3 - x^2 + 2x$

c $f(x) - g(x) = x^3 - 2x^2 + x - (2 - 3x)$
 $= x^3 - 2x^2 + 4x - 2$

d $3f(x) = 3(x^3 - 2x^2 + x)$
 $= 3x^3 - 6x^2 + 3x$

e

$$f(x)g(x) = (x^3 - 2x^2 + x)(2 - 3x)$$

$$= 2(x^3 - 2x^2 + x) - 3x(x^3 - 2x^2 + x)$$

$$= -3x^4 + 8x^3 - 7x^2 + 2x$$

f

$$g(x)h(x) = (2 - 3x)(x^2 + x)$$

$$= 2(x^2 + x) - 3x(x^2 + x)$$

$$= -3x^3 - x^2 + 2x$$

g

$$f(x) + g(x) + h(x) = x^3 - 2x^2 + x + 2 - 3x + x^2 + x$$

$$= x^3 - x^2 - x + 2$$

h

$$f(x)h(x) = (x^3 - 2x^2 + x)(x^2 + x)$$

$$= x^3(x^2 + x) - 2x^2(x^2 + x) + x(x^2 + x)$$

$$= x^5 - x^4 - x^3 + x^2$$

6 a $(x - 2)(x^2 - 2x + 3)$

$$= x(x^2 - 2x + 3) - 2(x^2 - 2x + 3)$$

$$= x^3 - 2x^2 + 3x - 2x^2 + 4x - 6$$

$$= x^3 - 4x^2 + 7x - 6$$

b $(x - 4)(x^2 - 2x + 3)$

$$= x(x^2 - 2x + 3) - 4(x^2 - 2x + 3)$$

$$= x^3 - 2x^2 + 3x - 4x^2 + 8x - 12$$

$$= x^3 - 6x^2 + 11x - 12$$

c $(x - 1)(2x^2 - 3x - 4)$

$$= x(2x^2 - 3x - 4) - 1(2x^2 - 3x - 4)$$

$$= 2x^3 - 3x^2 - 4x - 2x^2 + 3x + 4$$

$$= x^3 - 5x^2 - x + 4$$

$$\begin{aligned}
 \text{d } (x-2)(x^2+bx+c) \\
 &= x(x^2+bx+c) - 2(x^2+bx+c) \\
 &= x^3+bx^2+cx - 2x^2 - 2bx - 2c \\
 &= x^3 + (b-2)x^2 + (c-2b)x - 2c
 \end{aligned}$$

$$\begin{aligned}
 \text{e } (2x+1)(x^2-4x-3) \\
 &= 2x(x^2-4x-3) + (x^2-4x-3) \\
 &= 2x^3 - 8x^2 - 6x + x^2 - 4x - 3 \\
 &= 2x^3 - 7x^2 - 10x - 3
 \end{aligned}$$

$$\begin{aligned}
 \text{7 a } (x+1)(x^2+bx+c) \\
 &= x(x^2+bx+c) + (x^2+bx+c) \\
 &= x^3+bx^2+cx + x^2+bx+c \\
 &= x^3 + (b+1)x^2 + (c+b)x + c
 \end{aligned}$$

b Equating coefficients

$$b+1 = -7 \text{ (coefficients of } x^2)$$

$$\therefore b = -8$$

Note that $c = 12$. Also as a check

note that: $c + b = 4$ (coefficients of x)

$$\therefore c = 12$$

$$\begin{aligned}
 \text{c } x^3 - 7x^2 + 4x + 12 \\
 &= (x+1)(x^2 - 8x + 12) \\
 &= (x+1)(x-6)(x-2)
 \end{aligned}$$

$$\begin{aligned}
 \text{8 } x^2 + 6x - 2 &= (x-b)^2 + c \\
 &= x^2 - 2bx + b^2 + c \\
 \text{Equating coefficients} \\
 -2b &= 6 \text{ and } b^2 + c = -2. \\
 \therefore b &= -3 \text{ and } c = -11.
 \end{aligned}$$

9 a We know that

$$(a+b)^4 = a^4 + 4a^3b + 6a^2b^2 + 4ab^3 + b^4$$

$$(a+b)^5 = (a+b)(a+b)^4$$

$$= a(a^4 + 4a^3b + 6a^2b^2 + 4ab^3 + b^4)$$

$$+ b(a^4 + 4a^3b + 6a^2b^2 + 4ab^3 + b^4)$$

$$= a^5 + 5a^4b + 10a^3b^2 + 10a^2b^3 + 5ab^4 + b^5$$

b

$$(a+b)^6 = (a+b)(a+b)^5$$

$$= a^6 + 6a^5b + 15a^4b^2 + 20a^3b^3 + 15a^2b^4 + 6ab^5 + b^6$$

10 We know that

$$(a+b)^4 = a^4 + 4a^3b + 6a^2b^2 + 4ab^3 + b^4$$

a Let $a = x$ and $b = -y$

$$(x-y)^4 = (x+(-y))^4$$

$$= x^4 + 4x^3(-y) + 6x^2(-y)^2 + 4x(-y)^3 + (-y)^4$$

$$= x^4 - 4x^3y + 6x^2y^2 - 4xy^3 + y^4$$

b Let $a = 2x$ and $b = y$

$$(2x+y)^4$$

$$= (2x)^4 + 4(2x)^3y + 6(2x)^2y^2 + 4(2x)y^3 + y^4$$

$$= 16x^4 + 32x^3y + 24x^2y^2 + 8xy^3 + y^4$$

Solutions to Exercise 6B

$$\begin{array}{r}
 x^2 + 2x + \frac{3}{x-1} \\
 \mathbf{1 \ a} \quad x-1 \overline{) x^3 + x^2 - 2x + 3} \\
 \underline{x^3 - x^2} \\
 2x^2 - 2x \\
 \underline{2x^2 - 2x} \\
 0
 \end{array}$$

$$\begin{array}{r}
 2x^2 - x - 3 + \frac{6}{x+1} \\
 \mathbf{b} \quad x+1 \overline{) 2x^3 + x^2 - 4x + 3} \\
 \underline{2x^3 + 2x^2} \\
 -x^2 - 4x \\
 \underline{-x^2 - x} \\
 -3x + 3 \\
 \underline{-3x - 3} \\
 6
 \end{array}$$

$$\begin{array}{r}
 3x^2 - 10x + 22 - \frac{43}{x+2} \\
 \mathbf{c} \quad x+2 \overline{) 3x^3 - 4x^2 + 2x + 1} \\
 \underline{3x^3 + 6x^2} \\
 -10x^2 + 2x \\
 \underline{-10x^2 - 20x} \\
 22x + 1 \\
 \underline{22x + 44} \\
 -43
 \end{array}$$

$$\begin{array}{r}
 2x^2 + 3x + 10 + \frac{28}{x-3} \\
 \mathbf{d} \quad x-3 \overline{) 2x^3 - 3x^2 + x - 2} \\
 \underline{2x^3 - 6x^2} \\
 3x^2 + x \\
 \underline{3x^2 - 9x} \\
 10x - 2 \\
 \underline{10x - 30} \\
 28
 \end{array}$$

$$\begin{array}{r}
 x^2 - x + 4 - \frac{8}{x+1} \\
 \mathbf{2 \ a} \quad x+1 \overline{) x^3 + 0x^2 + 3x - 4} \\
 \underline{x^3 + x^2} \\
 -x^2 + 3x \\
 \underline{-x^2 - x} \\
 4x - 4 \\
 \underline{4x + 4} \\
 -8
 \end{array}$$

$$\begin{array}{r}
 2x^2 - 8x + 49 - \frac{181}{x+4} \\
 \mathbf{b} \quad x+4 \overline{) 2x^3 + 0x^2 + 17x + 15} \\
 \underline{2x^3 + 8x^2} \\
 -8x^2 + 17x \\
 \underline{-8x^2 - 32x} \\
 49x + 15 \\
 \underline{49x + 196} \\
 -181
 \end{array}$$

$$\begin{array}{r} x^2 + x - 3 + \frac{11}{x+4} \\ \text{c } x+3 \overline{)x^3 + 4x^2 + 0x + 2} \\ \underline{x^3 + 3x^2} \\ x^2 + 0x \\ \underline{x^2 + 3x} \\ -3x + 2 \\ \underline{-3x - 9} \\ 11 \end{array}$$

$$\begin{array}{r} x^2 - 2x - 6 \\ \text{c } x-3 \overline{)x^3 - 5x^2 + 0x + 18} \\ \underline{x^3 - 3x^2} \\ -2x^2 + 0x \\ \underline{-2x^2 + 6x} \\ -6x + 18 \\ \underline{-6x + 18} \\ 0 \end{array}$$

$$\begin{array}{r} x^2 - x + 4 + \frac{8}{x-2} \\ \text{d } x-2 \overline{)x^3 - 3x^2 + 6x + 0} \\ \underline{x^3 - 2x^2} \\ -x^2 + 6x \\ \underline{-x^2 + 2x} \\ 4x + 0 \\ \underline{4x - 8} \\ 8 \end{array}$$

$$\begin{array}{r} 3x^2 - x - 6 \\ \text{d } x-2 \overline{)3x^3 - 7x^2 - 4x + 12} \\ \underline{-x^3 - 6x^2} \\ -x^2 - 4x \\ \underline{-x^2 + 2x} \\ -6x + 12 \\ \underline{-6x + 12} \\ 0 \end{array}$$

$$\begin{array}{r} x^2 - 2x + 5 \\ \text{3 a } x+1 \overline{)x^3 - x^2 + 3x + 5} \\ \underline{x^3 + x^2} \\ -2x^2 + 3x \\ \underline{-2x^2 - 2x} \\ 5x + 5 \\ \underline{5x + 5} \\ 0 \end{array}$$

$$\begin{array}{r} x^2 + 0x - 3 \\ \text{4 a } x+2 \overline{)x^3 + 2x^2 - 3x + 1} \\ \underline{x^3 + 2x^2} \\ 0x^2 - 3x \\ \underline{0x^2 + 0x} \\ -3x + 1 \\ \underline{-3x - 6} \\ 7 \end{array}$$

Quotient = $x^2 - 3$, Remainder = 7

$$\begin{array}{r} 2x^2 - 2x - 6 \\ \text{b } x+4 \overline{)2x^3 + 6x^2 - 14x - 24} \\ \underline{2x^3 + 8x^2} \\ -2x^2 - 14x \\ \underline{-2x^2 - 8x} \\ -6x - 24 \\ \underline{-6x - 24} \\ 0 \end{array}$$

$$\begin{array}{r} x^2 + 2x + 15 \\ \text{b } x-5 \overline{)x^3 - 3x^2 + 5x - 4} \\ \underline{x^3 - 5x^2} \\ 2x^2 + 5x \\ \underline{2x^2 - 10x} \\ 15x - 4 \\ \underline{15x - 75} \\ 71 \end{array}$$

Quotient = $x^2 + 2x + 15$,

Remainder = 71

$$\begin{array}{r} 2x^2 - 3x + 0 \\ \text{c } x + 1 \overline{) 2x^3 - x^2 - 3x - 7} \\ \underline{2x^3 + 2x^2} \\ -3x^2 - 3x \\ \underline{-3x^2 - 3x} \\ 0x - 7 \\ \underline{0x + 0} \\ -7 \end{array}$$

Quotient = $2x^2 - 3x$,
Remainder = -7

$$\begin{array}{r} 5x^2 + 20x + 77 \\ \text{d } x - 4 \overline{) 5x^3 + 0x^2 - 3x + 7} \\ \underline{5x^3 - 20x^2} \\ 20x^2 - 3x \\ \underline{20x^2 - 80x} \\ 77x + 7 \\ \underline{77x - 308} \\ 315 \end{array}$$

Quotient = $5x^2 + 20x + 77$,
Remainder = 315

$$\begin{array}{r} \frac{1}{2}x^2 + \frac{7}{4}x - \frac{3}{8} - \frac{103}{8(2x+5)} \\ \text{5 a } 2x + 5 \overline{) x^3 + 6x^2 + 8x + 11} \\ \underline{2x^3 + \frac{5}{2}x^2} \\ \frac{7}{2}x^2 + 8x \\ \underline{\frac{7}{2}x^2 + \frac{35}{4}x} \\ -\frac{3}{4}x + 11 \\ \underline{-\frac{3}{8}x - \frac{15}{8}} \\ \frac{103}{8} \end{array}$$

$$\begin{array}{r} x^2 + 2x - 3 - \frac{2}{2x+1} \\ \text{b } 2x + 1 \overline{) 2x^3 + 5x^2 - 4x - 5} \\ \underline{2x^3 + x^2} \\ 4x^2 - 4x \\ \underline{4x^2 + 2x} \\ -6x - 5 \\ \underline{-6x - 3} \\ -2 \end{array}$$

$$\begin{array}{r} x^2 + 2x - 15 \\ \text{c } 2x - 1 \overline{) 2x^3 + 3x^2 - 32x + 15} \\ \underline{2x^3 - x^2} \\ 4x^2 - 32x \\ \underline{4x^2 - 2x} \\ -30x + 15 \\ \underline{-30x + 15} \\ 0 \end{array}$$

$$\begin{array}{r} \frac{1}{3}x^2 - \frac{8}{9}x - \frac{8}{27} + \frac{19}{27(3x-1)} \\ \text{d } 3x - 1 \overline{) x^3 - 3x^2 + 0x + 1} \\ \underline{x^3 - \frac{1}{3}x^2} \\ -\frac{8}{3}x^2 + 0x \\ \underline{-\frac{8}{3}x^2 + \frac{8}{9}x} \\ -\frac{8}{9}x + 1 \\ \underline{-\frac{8}{9}x + \frac{8}{27}} \\ \frac{19}{27} \end{array}$$

6 a Using equating coefficients.

$$\begin{aligned} x^3 + 2x^2 + 5x + 1 &= (x - 1)(x^2 + 3x + 8) + 9. \\ \therefore \frac{x^3 + 2x^2 + 5x + 1}{x - 1} &= x^2 + 3x + 8 + \frac{9}{x - 1} \\ \therefore a &= 9. \end{aligned}$$

b Using equating coefficients.

$$\begin{aligned} 2x^3 - 2x^2 + 5x + 3 &= (2x - 1)\left(x^2 - \frac{x}{2} + \frac{9}{4}\right) + \frac{21}{4}. \\ \therefore \frac{2x^3 - 2x^2 + 5x + 3}{2x - 1} &= x^2 - \frac{x}{2} + \frac{9}{4} + \frac{21}{4(2x - 1)} \end{aligned}$$

$$\therefore a = \frac{21}{4}.$$

$$\begin{array}{r} 2x - 6 \\ 7 \text{ a } x^2 + 0x - 2 \overline{) 2x^3 - 6x^2 - 4x + 12} \\ \underline{2x^3 + 0x^2 - 4x} \\ -6x^2 + 0x + 12 \\ \underline{-6x^2 + 0x + 12} \\ 0 \end{array}$$

$$\begin{array}{r} x - 6 \\ \text{b } x^2 + 0x + 1 \overline{) x^3 - 6x^2 + x - 8} \\ \underline{x^3 + 0x^2 + x} \\ -6x^2 + 0x - 8 \\ \underline{-6x^2 + 0x - 6} \\ -2 \end{array}$$

$$\begin{array}{r} 2x - 6 \\ \text{c } x^2 + 0x - 2 \overline{) 2x^3 - 6x^2 - 4x + 54} \\ \underline{2x^3 + 0x^2 - 4x} \\ -6x^2 + 0x + 54 \\ \underline{-6x^2 + 0x + 12} \\ 42 \end{array}$$

$$\begin{array}{r} x^2 - 4x + 2 \\ \text{d } x^2 + 2x - 1 \overline{) x^4 - 2x^3 - 7x^2 + 7x + 5} \\ \underline{x^4 + 2x^3 - x^2} \\ -4x^3 - 6x^2 + 7x \\ \underline{-4x^3 - 8x^2 + 4x} \\ 2x^2 + 3x + 5 \\ \underline{2x^2 + 4x - 2} \\ -x + 7 \end{array}$$

$$\begin{array}{r} x^2 - 3x + 7 \\ \text{e } x^2 + 2x - 1 \overline{) x^4 - x^3 + 0x^2 + 7x + 2} \\ \underline{x^4 + 2x^3 - x^2} \\ -3x^3 + x^2 + 7x \\ \underline{-3x^3 - 6x^2 + 3x} \\ 7x^2 + 4x + 2 \\ \underline{7x^2 + 14x - 7} \\ -10x + 9 \end{array}$$

$$\begin{array}{r} x^2 + x - \frac{3}{2} \\ \text{f } 2x^2 - x + 4 \overline{) 2x^4 + x^3 + 0x^2 + 13x + 10} \\ \underline{2x^4 - x^3 + 4x^2} \\ 2x^3 - 4x^2 + 13x \\ \underline{2x^3 - x^2 + 4x} \\ -3x^2 + 9x + 10 \\ \underline{-3x^2 + \frac{3}{2}x - 6} \\ \frac{15}{2}x + 16 \end{array}$$

Solutions to Exercise 6C

Use the Remainder Theorem.

1 a $P(x) = x^3 - x^2 - 3x + 1$

Divide by $x - 1$: remainder = $P(1)$
 $= 1^3 - 1^2 - 3(1) + 1 = -2$

b $P(x) = x^3 - 3x^2 + 4x - 1$

Divide by $x + 2$: remainder = $P(-2)$
 $= (-2)^3 - 3(-2)^2 + 4(-2) - 1 = -29$

c $P(x) = 2x^3 - 2x^2 + 3x + 1$

Divide by $x - 2$: remainder = $P(2)$
 $= 2(2)^3 - 2(2)^2 + 3(2) + 1 = 15$

d $P(x) = x^3 - 2x + 3$

Divide by $x + 1$: remainder = $P(-1)$
 $= (-1)^3 - 2(-1) + 3 = 4$

e $P(x) = x^3 + 2x - 5$

Divide by $x - 2$: remainder = $P(2)$
 $= (2)^3 + 2(2) - 5 = 7$

f $P(x) = 2x^3 + 3x^2 + 3x - 2$

Divide by $x + 2$: remainder = $P(-2)$
 $= 2(-2)^3 + 3(-2)^2 + 3(-2) - 2 = -12$

g $P(x) = 6 - 5x + 9x^2 + 10x^3$

Divide by $2x + 3$: remainder = $P(-\frac{3}{2})$
 $= 6 - 5\left(-\frac{3}{2}\right) + 9\left(-\frac{3}{2}\right)^2$
 $+ 10\left(-\frac{3}{2}\right)^3 = 0$

h $P(x) = 10x^3 - 3x^2 + 4x - 1$

Divide by $2x + 1$: remainder
 $= P\left(-\frac{1}{2}\right)$
 $= 10\left(-\frac{1}{2}\right)^3 - 3\left(-\frac{1}{2}\right)^2$
 $+ 4\left(-\frac{1}{2}\right) - 1 = -5$

i $P(x) = 108x^3 - 27x^2 - 1$

Divide by $3x + 1$: remainder = $P(-\frac{1}{3})$

$= 108\left(-\frac{1}{3}\right)^3 - 27\left(-\frac{1}{3}\right)^2 - 1 = -8$

2 a $P(x) = x^3 + ax^2 + 3x - 5$

Remainder -3 when divided by $x - 2$

$\therefore P(2) = 8 + 4a + 6 - 5 = -3$

$\therefore 4a = -12$

$\therefore a = -3$

b $P(x) = x^3 + x^2 - 2ax + a^2$

Remainder 8 when divided by $x - 2$

$\therefore P(2) = 8 + 4 - 4a + a = 8$

$\therefore a - 4a = -4$

$\therefore (a - 2)^2 = 0$

$\therefore a = 2$

c $P(x) = x^3 - 3x^2 + ax + 5$

Remainder 17 when divided by $x - 3$

$\therefore P(3) = 27 - 27 + 3a + 5 = 17$

$\therefore 3a = 12$

$\therefore a = 4$

d $P(x) = x^3 + x^2 + ax + 8$

Remainder 0 when divided by $x - 1$

$\therefore P(1) = 1 + 1 + a + 8 = 0$

$\therefore a = -10$

Use the Factor Theorem.

3 a $P(x) = x^3 - x^2 + x - 1$

$\therefore P(1) = 1 - 1 + 1 - 1 = 0$

Therefore $P(x)$ is exactly divisible by $x - 1$

b $P(x) = x^3 + 3x^2 - x - 3$

$\therefore P(1) = 1 + 3 - 1 - 3 = 0$

Therefore $P(x)$ is exactly divisible by $x - 1$

c $P(x) = 2x^3 - 3x^2 - 11x + 6$
 $\therefore P(-2) = -16 - 12 + 22 + 6 = 0$
Therefore $P(x)$ is exactly divisible by $x + 2$

d $P(x) = 2x^3 - 13x^2 + 27x - 18$
 $\therefore P\left(\frac{3}{2}\right) = \frac{27}{4} - \frac{117}{4} + \frac{81}{2} - 18 = 0$
Therefore $P(x)$ is exactly divisible by $2x - 3$

4 a $P(x) = x^3 - 4x^2 + x + m$
 $P(3) = 27 - 36 + 3 + m = 0$
 $\therefore m = 6$

b $P(x) = 2x^3 - 3x^2 - (m + 1)x - 30$
 $P(5) = 250 - 75 - 5(m + 1) - 30 = 0$
 $\therefore 5(m + 1) = 145$
 $\therefore m + 1 = 29, \therefore m = 28$

c $P(x) = x^3 - (m + 1)x^2 - x + 30$
 $P(-3) = -27 - 9(m + 1) + 3 + 30 = 0$
 $\therefore 9(m + 1) = 6$
 $\therefore m + 1 = \frac{2}{3}, \therefore m = -\frac{1}{3}$

5 a $2x^3 + x^2 - 2x - 1$
 $= x^2(2x + 1) - (2x + 1)$
 $= (2x + 1)(x^2 - 1)$
 $= (2x + 1)(x + 1)(x - 1)$

b $x^3 + 3x^2 + 3x + 1$
 $= (x + 1)^3$

c $P(x) = 6x^3 - 13x^2 + 13x - 6$
 $P(1) = 6 - 13 + 13 - 6 = 0$
 $(x - 1)$ is a factor.
Long division or calculator:

$P(x) = (x - 1)(6x^2 - 7x + 6)$
No more factors since $\Delta < 0$ for the quadratic term.

d $P(x) = x^3 - 21x + 20$
 $P(1) = 1 - 21 + 20 = 0$
 $(x - 1)$ is a factor.
Long division or calculator:
 $P(x) = (x - 1)(x^2 + x - 20)$
 $\therefore P(x) = (x - 1)(x - 4)(x + 5)$

e $P(x) = 2x^3 + 3x^2 - 1$
 $P(-1) = -2 + 3 - 1 = 0$
 $(x + 1)$ is a factor.
Long division or calculator:
 $P(x) = (x + 1)(2x^2 + x - 1)$
 $\therefore P(x) = (x + 1)(x + 1)(2x - 1)$
 $= (2x - 1)(x + 1)^2$

f $P(x) = x^3 - x^2 - x + 1$
 $= x^2(x - 1) - (x - 1)$
 $= (x - 1)(x^2 - 1)$
 $= (x + 1)(x - 1)^2$

g $P(x) = 4x^3 + 3x - 38$
 $P(2) = 32 + 6 - 38 = 0$
 $(x - 2)$ is a factor.
Long division or calculator:
 $P(x) = (x - 2)(4x^2 + 8x + 19)$
No more factors since $\Delta < 0$ for the quadratic term.

h $P(x) = 4x^3 + 4x^2 - 11x - 6$
 $P(-2) = -32 + 16 + 22 - 6 = 0$
 $(x + 2)$ is a factor.
Long division or calculator:
 $P(x) = (x + 2)(4x^2 - 4x - 3)$
 $= (x + 2)(2x + 1)(2x - 3)$

6 Let $P(x) = (1 + x)^4$. Then

$P(-2) = (-2)^4 = 1$
The remainder is 1.

7 a $P(x) = 2x^3 - 7x^2 + 16x - 15$

Note that $P(x) = 0$ has no integer solutions. Check this by using the factor theorems.

The factor of 2 to be considered is 2

The factors of 15 to be considered are $\pm 3, \pm 5, \pm 15, \pm 1$.

The values to check using the factor theorem are $\pm \frac{3}{2}, \pm \frac{5}{2}, \pm \frac{15}{2}, \pm \frac{1}{2}$

Then using the factor theorem.

$P(\frac{3}{2}) = 0$. No need to try another. We can factorise since we know $2x - 3$ is a factor.

Using the equating coefficients method we find:

$$P(x) = (2x - 3)(x^2 - 2x + 5)$$

b $P(x) = 2x^3 - 7x^2 + 8x + 5$

Note that $P(x) = 0$ has no integer solutions. Check this by using the factor theorems.

The factor of 2 to be considered is 2

The factors of 5 to be considered are $\pm 5, \pm 1$.

The values to check using the factor theorem are $\pm \frac{5}{2}, \pm \frac{1}{2}$

Then using the factor theorem.

$P(\frac{5}{2}) \neq 0$ but $P(-\frac{1}{2}) = 0$. No need to try another. We can factorise since we know $2x + 1$ is a factor.

Using the equating coefficients method we find:

$$P(x) = (2x + 1)(x^2 - 2x + 5)$$

c $P(x) = 2x^3 - 3x^2 - 12x - 5$

Note that $P(x) = 0$ has no integer

solutions. Check this by using the factor theorems.

The factor of 2 to be considered is 2

The factors of -5 to be considered are $\pm 5, \pm 1$.

The values to check using the factor theorem are $\pm \frac{5}{2}, \pm \frac{1}{2}$

Then using the factor theorem.

$P(\frac{5}{2}) \neq 0$ but $P(-\frac{1}{2}) = 0$. No need to try another. We can factorise since we know $2x + 1$ is a factor.

Using the equating coefficients method we find:

$$P(x) = (2x + 1)(x^2 - 2x - 5)$$

d $P(x) = 2x^3 - x^2 - 8x - 3$

Note that $P(x) = 0$ has no integer solutions. Check this by using the factor theorems.

The factor of 2 to be considered is 2

The factors of -3 to be considered are $\pm 3, \pm 1$.

The values to check using the factor theorem are $\pm \frac{3}{2}, \pm \frac{1}{2}$

Then using the factor theorem.

$P(\frac{1}{2}) \neq 0$ but $P(-\frac{3}{2}) = 0$. No need to try another. We can factorise since we know $2x + 3$ is a factor.

Using the equating coefficients method we find:

$$P(x) = (2x + 3)(x^2 - 2x - 1)$$

8 Sum/difference of two cubes:

$$x^3 + y^3 = (x + y)(x^2 - xy + y^2)$$

$$x^3 - y^3 = (x - y)(x^2 + xy + y^2)$$

a $x^3 - 1 = (x - 1)(x^2 + x + 1)$

b $x^3 + 64 = (x + 4)(x^2 - 4x + 16)$

$$\text{c } 27x^3 - 1 = (3x - 1)(9x^2 + 3x + 1)$$

$$\text{d } 64x^3 - 125 = (4x - 5)(16x^2 + 20x + 25)$$

$$\text{e } 1 - 125x^3 = (1 - 5x)(1 + 5x + 25x^2)$$

$$\text{f } 8 + 27x^3 = (2 + 3x)(4 - 6x + 9x^2)$$

$$\text{g } 64m^3 - 27n^3 = (4m - 3n)(16m^2 + 12mn + 9n^2)$$

$$\text{h } 27b^3 + 8a^3 = (3b + 2a)(9b^2 - 6ab + 4a^2)$$

9 a $P(x) = x^3 + x^2 - x + 2$
 $P(-2) = -8 + 4 + 2 + 2 = 0$
 $\therefore P(x) = (x + 2)(x^2 - x + 1)$
 No more factors since $\Delta < 0$, for the quadratic term.

b $P(x) = 3x^3 - 7x^2 + 4$
 $P(1) = 3 - 7 + 4 = 0$
 $\therefore P(x) = (x - 1)(3x^2 - 4x - 4)$
 $= (x - 1)(3x + 2)(x - 2)$

c $P(x) = x^3 - 4x^2 + x + 6$
 $P(-1) = -1 - 4 - 1 + 6 = 0$
 $\therefore P(x) = (x + 1)(x - 5x + 6)$
 $= (x + 1)(x - 2)(x - 3)$

d $P(x) = 6x^3 + 17x^2 - 4x - 3$
 $P(-3) = -162 + 153 + 12 - 3 = 0$
 $\therefore P(x) = (x + 3)(6x^2 - x - 1)$
 $= (x + 3)(3x + 1)(2x - 1)$

10 $P(x) = x^3 + ax^2 - x + b$
 $P(x)$ is divisible by $x - 1$ and $x + 3$:
 $P(1) = 1 + a - 1 + b = 0$
 $\therefore a + b = 0$
 $P(-3) = -27 + 9a + 3 + b = 0$

$$\therefore 9a + b = 24$$

$$a = 3, b = -3$$

$$\text{So } P(x) = x^3 + 3x^2 - x - 3$$

$$= x^2(x + 3) - (x + 3)$$

$$= (x + 3)(x^2 - 1)$$

$$= (x + 3)(x - 1)(x + 1)$$

11 a $P(x) = x^n - a^n$

$$P(a) = a^n - a^n = 0$$

By the Factor Theorem, $(x - a)$ is a factor of $P(x)$

b $Q(x) = x^n + a^n$

i If $(x + a)$ is a factor of $Q(x)$, then
 $Q(-a) = (-a)^n + a^n$,
 which is zero if n is an odd number.

ii If $(x + a)$ is a factor of $P(x)$, then
 $P(-a) = (-a)^n - a^n$,
 which is zero if n is an even number.

12 a $P(x) = (x - 1)(x - 2)Q(x) + ax + b$

$$P(1) = a + b = 2$$

$$P(2) = 2a + b = 3$$

$$a = b = 1$$

b i If $P(x)$ is a cubic with x^3 coefficient = 1:
 $P(x) = (x - 1)(x - 2)(x + c) + x + 1$
 Since -1 is a solution to $P(1) = 0$:

$$P(-1) = (-2)(-3)(-1 + c) - 1 + 1 = 0$$

$$\therefore c = 1$$

$$P(x) = (x - 1)(x - 2)(x + 1) + x + 1$$

$$= (x + 1)((x - 1)(x - 2) + 1)$$

$$= (x + 1)(x^2 - 3x + 2 + 1)$$

$$= (x + 1)(x^2 - 3x + 3)$$

$$= x^3 - 2x^2 + 3$$

$$\text{ii } P(x) = (x + 1)(x^2 - 3x + 3)$$

includes a quadratic where $\Delta < 0$,
so $x = -1$ is the only real solution

to $P(x) = 0$

Solutions to Exercise 6D

1 a $(x-1)(x+2)(x-4) = 0$
 $x = 1, -2, 4$

b $(x-4)(x-4)(x-6) = 0$
 $x = 4, 6$

c $(2x-1)(x-3)(3x+2) = 0$
 $x = \frac{1}{2}, 3, -\frac{2}{3}$

d $x(x+3)(2x-5) = 0$
 $x = 0$ or $x = -3$ or $x = \frac{5}{2}$

2 a $x^3 - 2x^2 - 8x = 0$
 $\therefore x(x^2 - 2x - 8) = 0$
 $\therefore x(x+2)(x-4) = 0$
 $x = -2, 0, 4$

b $x^3 + 2x^2 - 11x = 0$
 $\therefore x(x^2 + 2x - 11) = 0$
 $\therefore x(x+1-2\sqrt{3})(x+1+2\sqrt{3}) = 0$
 $x = 0, -1 \pm 2\sqrt{3}$

c $x^3 - 3x^2 - 40x = 0$
 $\therefore x(x^2 - 3x - 40) = 0$
 $\therefore x(x-8)(x+5) = 0$
 $x = -5, 0, 8$

d $x^3 + 2x^2 - 16x = 0$
 $\therefore x(x^2 + 2x - 16) = 0$
 $\therefore x(x+1-\sqrt{17})(x+1+\sqrt{17}) = 0$
 $x = 0, -1 \pm \sqrt{17}$

3 a $x^3 - x^2 + x - 1 = 0$
 $\therefore x^2(x-1) + (x-1) = 0$
 $\therefore (x-1)(x^2+1) = 0$
 $x = 1$; no other real solutions since $\Delta < 0$ for the quadratic term.

b $x^3 + x^2 + x + 1 = 0$
 $\therefore x^2(x+1) + (x+1) = 0$
 $\therefore (x+1)(x^2+1) = 0$
 $x = -1$; no other real solutions since $\Delta < 0$ for the quadratic term.

c $x^3 - 5x^2 - 10x + 50 = 0$
 $\therefore x^2(x-5) - 10(x-5) = 0$
 $\therefore (x-5)(x^2-10) = 0$
 $\therefore (x-5)(x-\sqrt{10})(x+\sqrt{10}) = 0$
 $x = 5, \pm\sqrt{10}$

d $x^3 - ax^2 - 16x + 16a = 0$
 $\therefore x^2(x-a) - 16(x-a) = 0$
 $\therefore x^2(x-a)(x-16) = 0$
 $\therefore (x-a)(x-4)(x+4) = 0$
 $x = a, \pm 4$

4 a $x^3 - 19x + 30 = 0$
 $P(2) = 8 - 38 + 30 = 0$
 $\therefore P(x) = (x-2)(x^2 + 2x - 15) = 0$
 $= (x-2)(x-3)(x+5) = 0$
 $x = -5, 2, 3$

b $P(x) = 3x^3 - 4x^2 - 13x - 6 = 0$
 $P(-1) = -3 - 4 + 13 - 6 = 0$
 $\therefore P(x) = (x+1)(3x^2 - 7x - 6) = 0$
 $= (x+1)(3x+2)(x-3) = 0$
 $x = -1, -\frac{2}{3}, 3$

c $x^3 - x^2 - 2x + 2 = 0$
 $\therefore x^2(x-1) - 2(x-1) = 0$
 $\therefore (x-1)(x^2-2) = 0$
 $\therefore (x-1)(x-\sqrt{2})(x+\sqrt{2}) = 0$
 $x = 1, \pm\sqrt{2}$

d $P(x) = 5x^3 + 12x^2 - 36x - 16 = 0$

$$P(2) = 40 + 48 - 72 - 16 = 0$$

$$\therefore P(x) = (x - 2)(5x + 22x + 8) = 0$$

$$= (x - 2)(5x + 2)(x + 4) = 0$$

$$x = -4, -\frac{2}{5}, 2$$

e $P(x) = 6x^3 - 5x^2 - 2x + 1 = 0$
 $P(1) = 6 - 5 - 2 + 1 = 0$
 $\therefore P(x) = (x - 1)(6x^2 + x - 1) = 0$
 $= (x - 1)(3x - 1)(2x + 1) = 0$
 $x = -\frac{1}{2}, \frac{1}{3}, 1$

f $P(x) = 2x^3 - 3x^2 - 29x - 30 = 0$
 $P(-2) = -16 - 12 + 58 - 30 = 0$
 $\therefore P(x) = (x + 2)(2x^2 - 7x - 15) = 0$
 $= (x + 2)(2x + 3)(x - 5) = 0$
 $x = -2, -\frac{3}{2}, 5$

5 a $P(x) = x^3 + x^2 - 24x + 36 = 0$
 $P(2) = 8 + 4 - 48 + 36 = 0$
 $\therefore P(x) = (x - 2)(x + 3x - 18) = 0$
 $= (x - 2)(x - 3)(x + 6) = 0$
 $x = -6, 2, 3$

b $P(x) = 6x^3 + 13x^2 - 4 = 0$
 $P(-2) = -48 + 52 - 4 = 0$
 $\therefore P(x) = (x + 2)(6x + x - 2) = 0$
 $= (x + 2)(2x - 1)(3x + 2) = 0$
 $x = -2, -\frac{2}{3}, \frac{1}{2}$

c $P(x) = x^3 - x^2 - 2x - 12 = 0$
 $P(3) = 27 - 9 - 6 - 12 = 0$
 $\therefore P(x) = (x - 3)(x^2 + 2x + 4) = 0$
 $x = 3$; no other real solutions since $\Delta < 0$ for the quadratic term.

d $P(x) = 2x^3 + 3x^2 + 7x + 6 = 0$
 $P(-1) = -2 + 3 - 7 + 6 = 0$

$$\therefore P(x) = (x + 1)(2x^2 + x + 6) = 0$$

$$x = -1$$
; no other real solutions since $\Delta < 0$ for the quadratic term.

e $P(x) = x^3 - x^2 - 5x - 3 = 0$
 $P(3) = 27 - 9 - 15 - 3 = 0$
 $\therefore P(x) = (x - 3)(x^2 + 2x + 1) = 0$
 $= (x - 3)(x + 1)^2 = 0$
 $x = -1, 3$

f $P(x) = x^3 + x^2 - 11x - 3 = 0$
 $P(3) = 27 + 9 - 33 - 3 = 0$
 $\therefore P(x) = (x - 3)(x^2 + 4x + 1) = 0$
 $= (x - 3)(x + 2 - \sqrt{3})(x + 2 + \sqrt{3}) = 0$
 $= 0$
 $x = 3, -2 \pm \sqrt{3}$

6 a $2x^3 = 16x$
 $\therefore 2x^3 - 16x = 0$
 $\therefore 2x(x^2 - 8) = 0$
 $\therefore 2x(x - 2\sqrt{2})(x + 2\sqrt{2}) = 0$
 $x = 0, \pm 2\sqrt{2}$

b $2(x - 1)^3 = 32$
 $\therefore (x - 1)^3 = 16$
 $x - 1 = 2\sqrt[3]{2}$
 $x = 1 + 2\sqrt[3]{2}$

c $x^3 + 8 = 0$
 $\therefore (x + 2)(x^2 - 2x + 4) = 0$
 $x = -2$; no other real solutions since $\Delta < 0$ for the quadratic term

d $2x^3 + 250 = 0$
 $\therefore 2(x^3 + 125) = 0$
 $\therefore 2(x + 5)(x^2 - 5x + 25) = 0$
 $x = -5$; no other real solutions since $\Delta < 0$ for the quadratic term.

$$\begin{aligned}
 \mathbf{e} \quad 1000 &= \frac{1}{x^3} \\
 \therefore 1000x^3 &= 1 \\
 \therefore (10x)^3 &= 1 \\
 \therefore 10x &= 1, \therefore x = \frac{1}{10}
 \end{aligned}$$

$$\begin{aligned}
 \mathbf{7 a} \quad 2x^3 - 22x^2 - 250x + 2574 \\
 &= 2(x-9)(x^2 - 2x - 143) \\
 &= 2(x-9)(x-13)(x+11)
 \end{aligned}$$

$$\begin{aligned}
 \mathbf{b} \quad 2x^3 + 27x^2 + 52x - 33 \\
 &= (x+3)(2x^2 + 15x - 11) \\
 &= (x+3)(2x^2 + 21x - 11) \\
 &= (x+3)(2x-1)(x+11)
 \end{aligned}$$

$$\begin{aligned}
 \mathbf{c} \quad 2x^3 - 9x^2 - 242x + 1089 \\
 &= (x-11)(2x^2 + 13x - 99) \\
 &= (x-11)(2x-9)(x+11)
 \end{aligned}$$

$$\begin{aligned}
 \mathbf{d} \quad 2x^3 + 51x^2 + 304x - 165 \\
 &= (x+11)(2x^2 + 29x - 15) \\
 &= (x+11)(2x-1)(x+15)
 \end{aligned}$$

Solutions to Exercise 6E

1 a $y = (x + 2)^3 - 1$

Stationary point of inflection at $(-2, -1)$

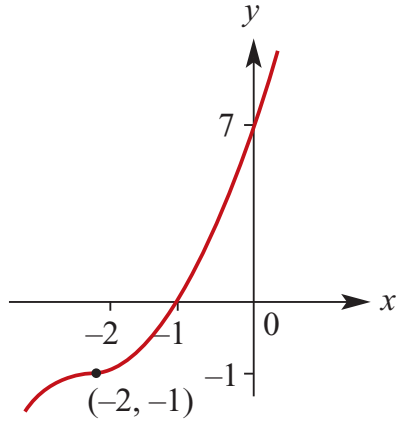

b $y = (x - 1)^3 - 1$

Stationary point of inflection at $(1, -1)$

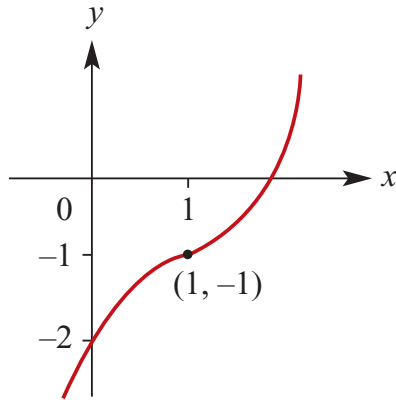

c $y = (x + 3)^3 + 2$

Stationary point of inflection at $(-3, 2)$

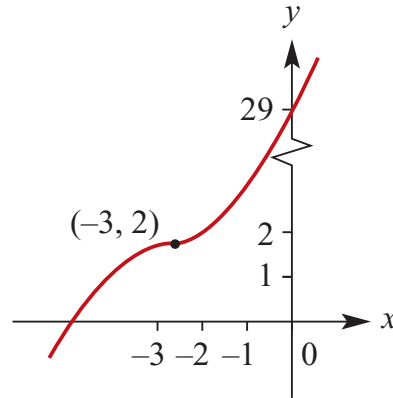

d $y = (x - 2)^3 + 5$

Stationary point of inflection at $(2, 5)$

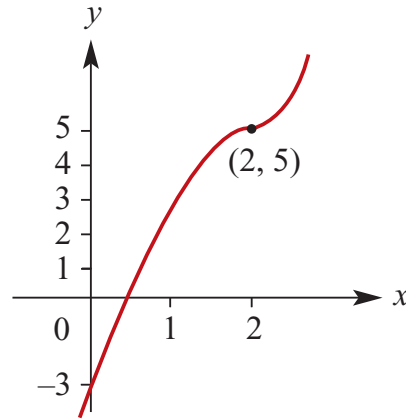

e $y = (x + 2)^3 - 5$

Stationary point of inflection at $(-2, -5)$

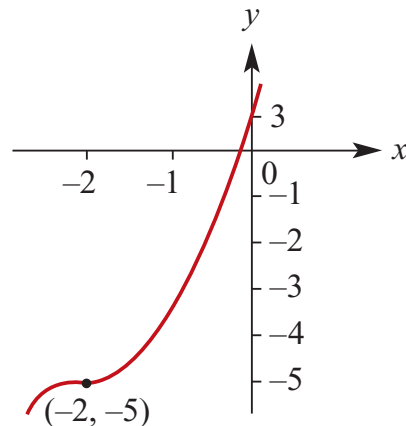

2 a $y = 2x^3 + 3$

Stationary point of inflection at $(0, 3)$

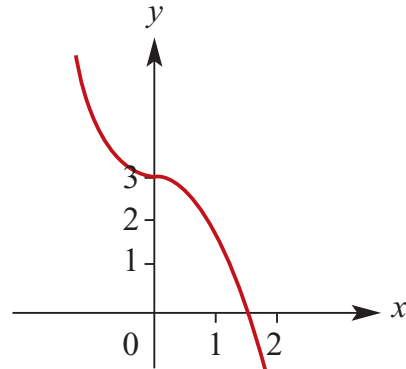
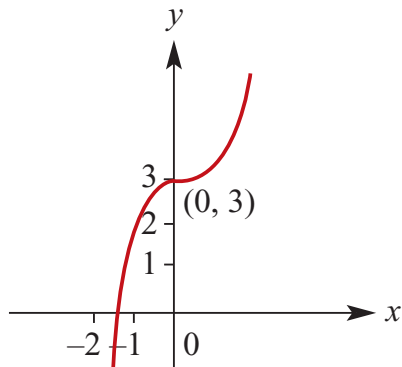

e $y = (3 - x)^3$

Stationary point of inflection at $(3, 0)$

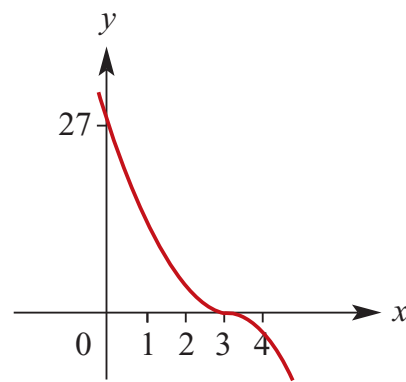

b $y = 2(x - 3)^3 + 2$

Stationary point of inflection at $(3, 2)$

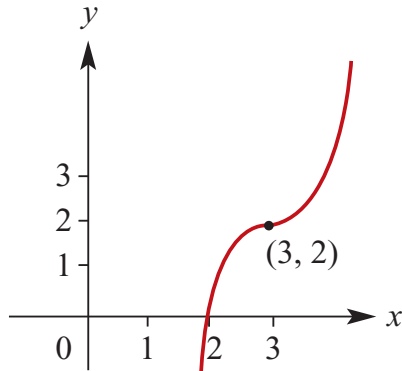

f $y = -2(x + 1)^3 + 1$

Stationary point of inflection at $(-1, 1)$

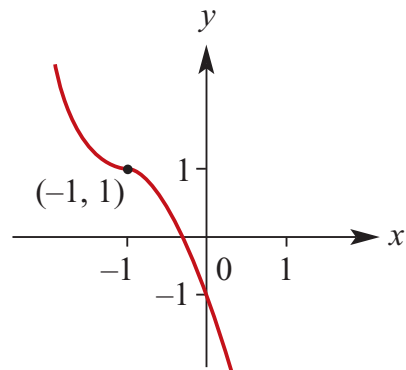

c $3y = x^3 - 5$

Stationary point of inflection at $(0, -\frac{5}{3})$

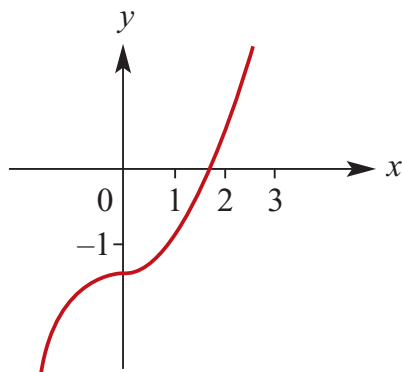

g $y = \frac{1}{2}(x - 3)^3 + 2$

Stationary point of inflection at $(3, 2)$

d $y = 3 - x^3$

Stationary point of inflection at $(0, 3)$

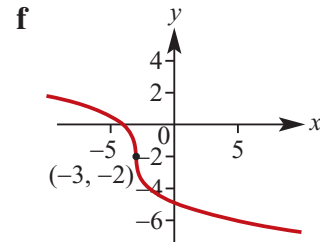
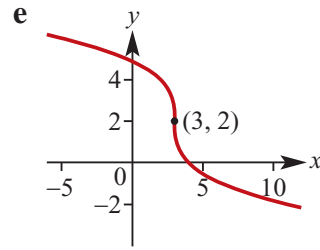
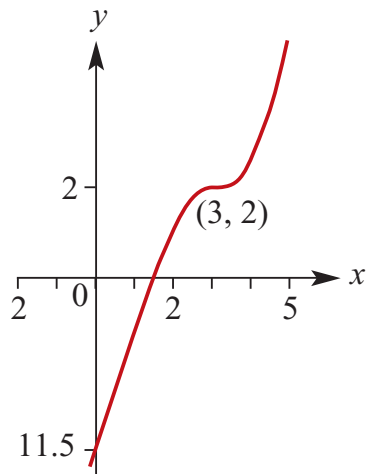

3 a

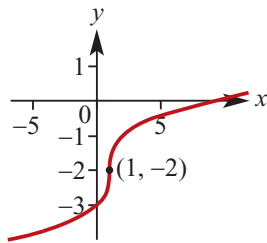

b

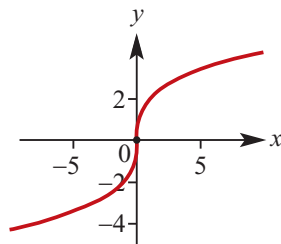

c

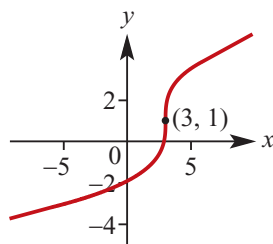

d

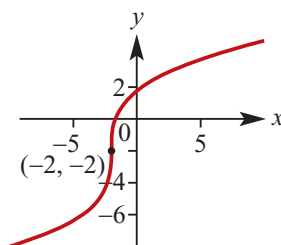

4 a Let $y = f^{-1}(x)$

Then

$$x = 2y^3 + 3$$

$$y^3 = \frac{x-3}{2}$$

$$y = \sqrt[3]{\frac{x-3}{2}}$$

$$\therefore f^{-1}(x) = \sqrt[3]{\frac{x-3}{2}}$$

Maximal domain = \mathbb{R}

b Let $y = f^{-1}(x)$

Then

$$x = 3y^{\frac{1}{3}}$$

$$y^{\frac{1}{3}} = \frac{x}{3}$$

$$y = \frac{x^3}{27}$$

$$\therefore f^{-1}(x) = \frac{x^3}{27}$$

Maximal domain = \mathbb{R}

c Let $y = f^{-1}(x)$

Then

$$x = 2(y + 1)^3 + 1$$

$$(y + 1)^3 = \frac{x - 1}{2}$$

$$y + 1 = \sqrt[3]{\frac{x - 1}{2}}$$

$$y = \sqrt[3]{\frac{x - 1}{2}} - 1$$

$$\therefore f^{-1}(x) = \sqrt[3]{\frac{x - 1}{2}} - 1$$

Maximal domain = \mathbb{R}

d Let $y = f^{-1}(x)$

Then

$$x = 2(y + 3)^{\frac{1}{3}} - 2$$

$$(y + 3)^{\frac{1}{3}} = \frac{x + 2}{2}$$

$$y + 3 = \frac{(x + 2)^3}{8}$$

$$y = \frac{(x + 2)^3}{8} - 3$$

$$\therefore f^{-1}(x) = \frac{(x + 2)^3}{8} - 3$$

Maximal domain = \mathbb{R}

e Let $y = f^{-1}(x)$

Then

$$x = -2(y - 1)^{\frac{1}{3}} + 4$$

$$(y - 1)^{\frac{1}{3}} = \frac{x - 4}{-2}$$

$$y - 1 = -\frac{(x - 4)^3}{8}$$

$$y = 1 - \frac{(x - 4)^3}{8}$$

$$\therefore f^{-1}(x) = 1 - \frac{(x - 4)^3}{8}$$

Maximal domain = \mathbb{R}

f Let $y = f^{-1}(x)$

Then

$$x = -2(y + 2)^{\frac{1}{3}} - 1$$

$$(y + 2)^{\frac{1}{3}} = \frac{x + 1}{-2}$$

$$y + 2 = -\frac{(x + 1)^3}{8}$$

$$y = -2 - \frac{(x + 1)^3}{8}$$

$$\therefore f^{-1}(x) = -2 - \frac{(x + 1)^3}{8}$$

Maximal domain = \mathbb{R}

Solutions to Exercise 6F

1 a $y = x(x - 1)(x - 3)$

Axis intercepts: $(0, 0)$, $(1, 0)$ and $(3, 0)$

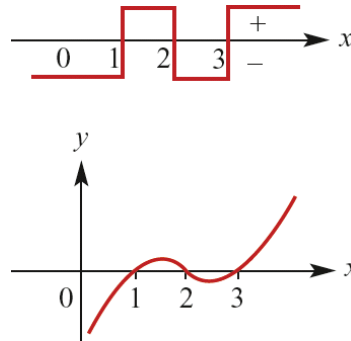
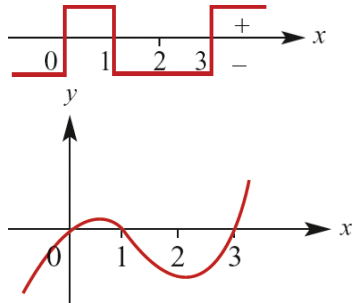

b $y = (x - 1)(x + 1)(x + 2)$

Axis intercepts: $(-2, 0)$, $(-1, 0)$, $(1, 0)$ and $(0, 6)$

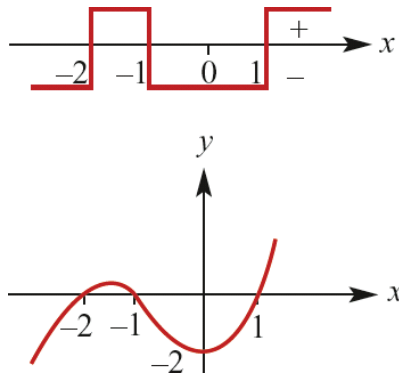

2 a $y = x^3 - 9x = x(x - 3)(x + 3)$

Axis intercepts: $(0, 0)$, $(-3, 0)$ and $(3, 0)$

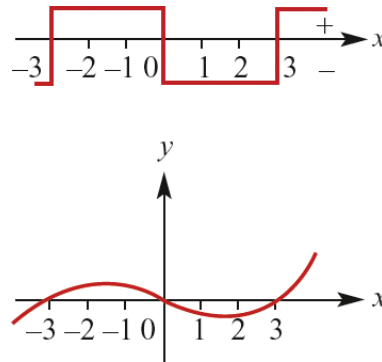

c $y = (2x - 1)(x - 2)(x + 3)$

Axis intercepts: $(-3, 0)$, $(\frac{1}{2}, 0)$, $(2, 0)$ and $(0, 6)$

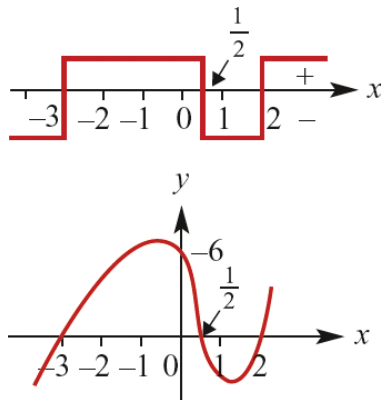

b $y = x^3 - 4x^2 - 3x + 18$

$\therefore y = (x - 3)^2(x + 2)$

Axis intercepts: $(-2, 0)$, $(3, 0)$ and $(0, 18)$

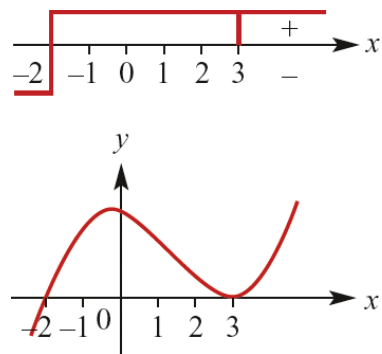

d $y = (x - 1)(x - 2)(x - 3)$

Axis intercepts: $(1, 0)$, $(2, 0)$, $(3, 0)$ and $(0, 6)$

c $y = -x^3 + x^2 + 3x - 3$

$\therefore y = (1 - x)(x^2 - 3)$

$= (1 - x)(x - \sqrt{3})(x + \sqrt{3})$

Axis intercepts:

$(1, 0)$, $(-\sqrt{3}, 0)$, $(\sqrt{3}, 0)$ and $(0, -3)$

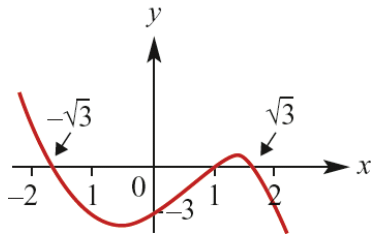
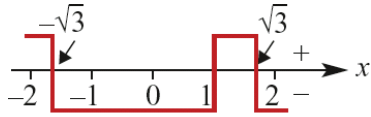

d $y = 3x^3 - 4x^2 - 13x - 6$
 $\therefore y = (3x + 2)(x + 1)(x - 3)$
 Axis intercepts: $(-1, 0)$, $(-\frac{2}{3}, 0)$, $(3, 0)$
 and $(0, 1)$

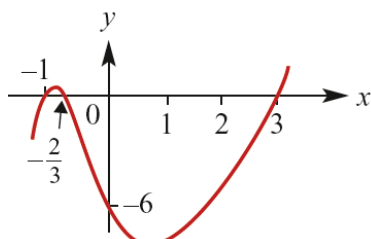

e $y = 6x^3 - 5x^2 - 2x + 1$
 $y = (x - 1)(3x - 1)(2x + 1)$
 Axis intercepts: $(-\frac{1}{2}, 0)$, $(\frac{1}{3}, 0)$, $(1, 0)$
 and $(0, 1)$

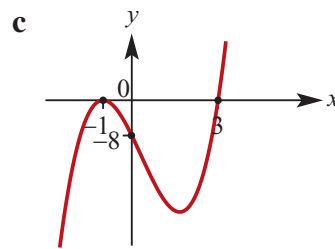
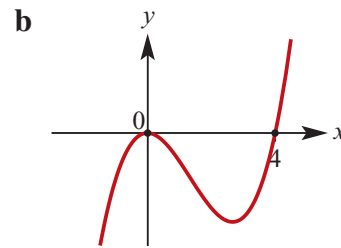
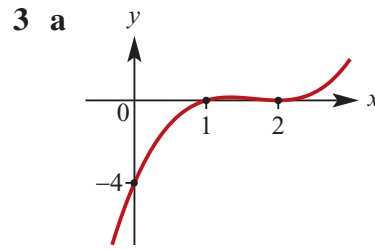
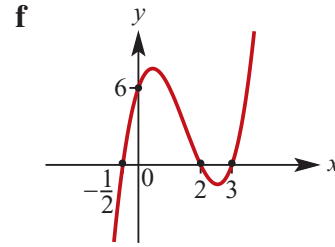
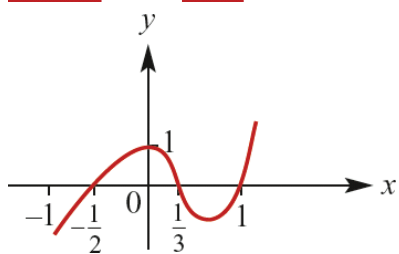
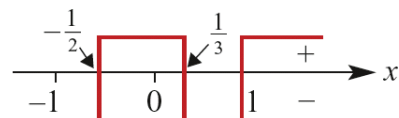

d $y = x^3 + x^2 = x^2(x + 1)$
 Axis intercepts: $(0, 0)$ and $(-1, 0)$

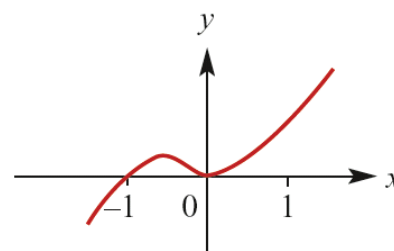
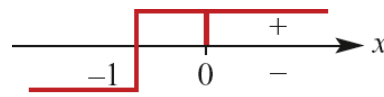

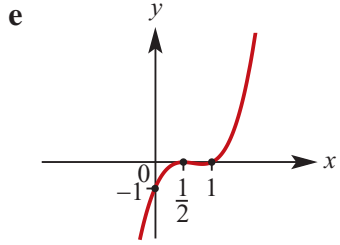

f $y = x^3 - 5x^2 + 7x - 3$
 $\therefore y = (x - 1)^2(x - 3)$
 Axis intercepts: $(1, 0)$, $(3, 0)$ and $(0, -3)$

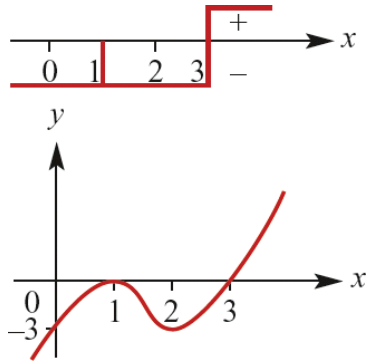

4 a

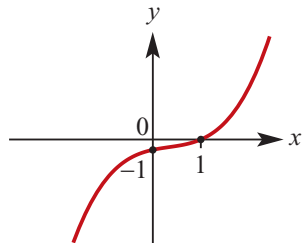

b

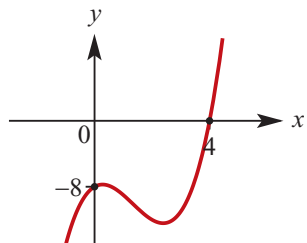

5 a $y = -4x^3 - 12x^2 + 37x - 15$
 Intercepts: $(-5, 0)$, $(\frac{1}{2}, 0)$, $(\frac{2}{3}, 0)$ and $(0, -15)$
 Max. : $(1.02, 6.01)$
 Min. : $(-3.02, -126.01)$

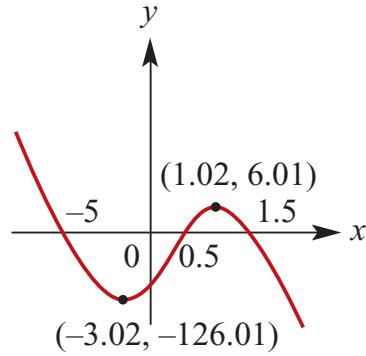

b $y = -4x^3 + 19x - 15$
 Intercepts: $(-\frac{5}{2}, 0)$, $(1, 0)$, $(\frac{3}{2}, 0)$ and $(0, -15)$
 Max. : $(1.26, 0.94)$
 Min. : $(-1.26, -30.94)$

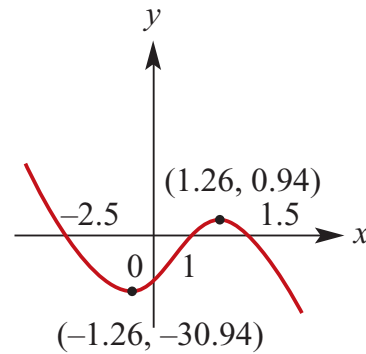

c $y = -4x^3 + 0.8x^2 + 19.8x - 18$
 Intercepts: $(-2.5, 0)$, $(1.2, 0)$, $(1.5, 0)$ and $(0, -18)$
 Max. : $(1.35, 0.35)$
 Min. : $(-1.22, -33.70)$

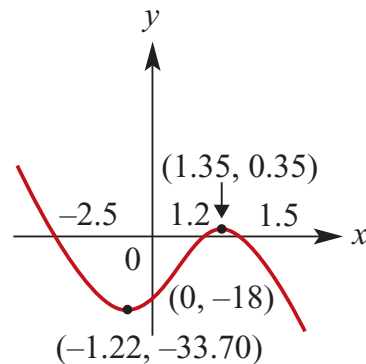

d $y = 2x^3 + 11x^2 + 15x$
 Intercepts: $(-3, 0)$, $(-\frac{5}{2}, 0)$, and $(0, 0)$

Max : $(-2.76, 0.34)$
 Min : $(-0.91, -6.05)$

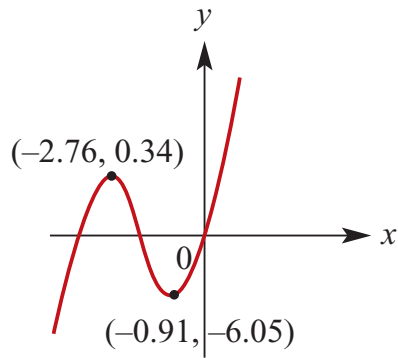

f $y = 2x^3 + 6x^2 + 6$
 Intercepts: $(-3.28, 0)$ and $(0, 6)$
 Max : $(-2, 14)$
 Min : $(0, 6)$

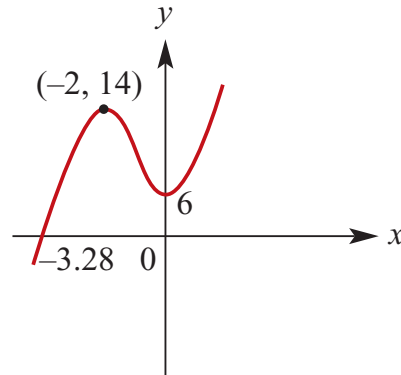

e $y = 2x^3 + 6x^2$
 Intercepts: $(-3, 0)$ and $(0, 0)$
 Max : $(-2, 8)$
 Min : $(0, 0)$

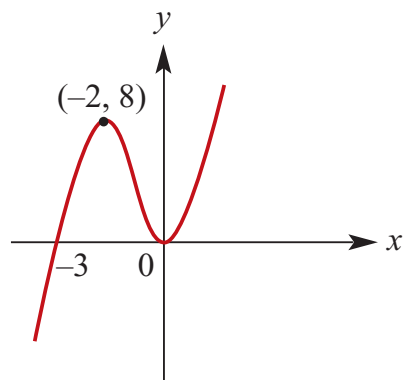

6 $f(x) = x^3 - x^2 - 5x - 3$
 $= (x - 3)(x^2 + 2x + 1)$
 $= (x - 3)(x + 1)^2$
 $f(x)$ cuts the axis at $x = 3$ and touches the axis at the repeated root $x = -1$.

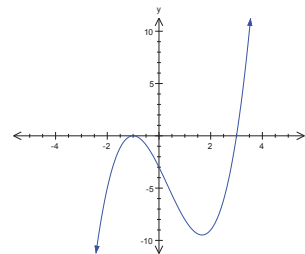

Solutions to Exercise 6G

1 a $(x - 1)(x + 2)(x - 3) \leq 0$

Arrange in order from left to right:

$$(x + 2)(x - 1)(x - 3) \leq 0$$

Upright cubic, so $f(x) \leq 0$ for:

$$\{x : x \leq -2\} \cup \{x : 1 \leq x \leq 3\}$$

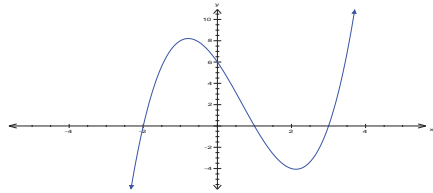

b $(x + 1)(x + 2)(x - 4) \geq 0$

Arrange in order from left to right:

$$(x + 2)(x + 1)(x - 4) \geq 0$$

Upright cubic so $f(x) \leq 0$ for:

$$\{x : x \geq 4\} \cup \{x : -2 \leq x \leq -1\}$$

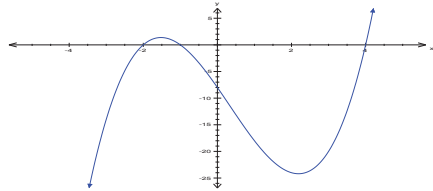

c $(x - 1)(x - 2)^2 < 0$

Upright cubic, so $f(x) < 0$ for

$$\{x : x < 1\}$$

Repeated root at $x = 2$ means that the graph is positive or zero for all other x .

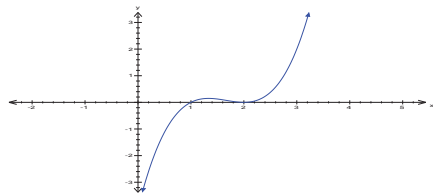

d $x(x + 2)(x - 3) > 0$

Arrange in order from left to right:

$$(x + 2)x(x - 3) > 0$$

Upright cubic, so $f(x) > 0$ for:

$$\{x : x > 3\} \cup \{x : -2 < x < 0\}$$

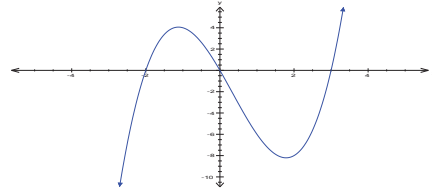

e $(x - 1)^3 + 8 \leq 0$

Translation of $y = x^3$ which is an increasing function for all x .

$$\therefore (x - 1)^3 \leq -8$$

$$\therefore x - 1 \leq -2, \therefore x \leq -1$$

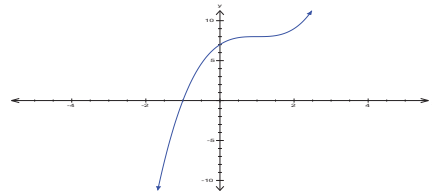

f $x^3 - 1 \geq 0$

Translation of $y = x^3$ which is an increasing function for all x .

$$\therefore x^3 \geq 1, \therefore x \geq 1$$

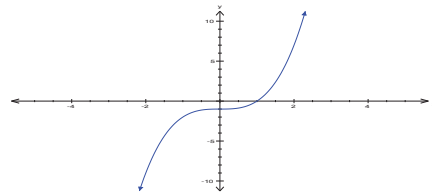

g $x^2(x - 4) > 0$

Repeated root at $(0,0)$ so $f(x) > 0$ only for $\{x : x > 4\}$

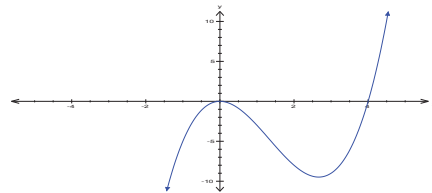

h $(x + 3)(x^2 + 2x + 5) \leq 0$

The quadratic expression has no real roots so there is only one x -axis intercept at $x = -3$.

The cubic is upright so $f(x) \leq 0$ only for $\{x : x \leq -3\}$

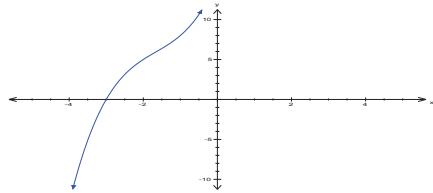

2 a $x^3 > 4x$

$$\Leftrightarrow x^3 - 4x > 0$$

$$\Leftrightarrow x(x^2 - 4) > 0$$

$$\Leftrightarrow x(x - 2)(x + 2) > 0$$

$$\Leftrightarrow x \in (2, \infty) \cup (-2, 0)$$

Since coefficient of x^3 is positive

b

$$x^3 < 5x^2$$

$$\Leftrightarrow x^3 - 5x^2 < 0$$

$$\Leftrightarrow x^2(x - 5) < 0$$

$$\Leftrightarrow x \in (-\infty, 0) \cup (0, 5)$$

Since coefficient of x^3

is positive and 'double root' when $x = 0$

c

$$x^3 + 4x \leq 4x^2$$

$$\Leftrightarrow x^3 - 4x^2 + 4x \leq 0$$

$$\Leftrightarrow x(x^2 - 4x + 4) \leq 0$$

$$\Leftrightarrow x(x - 2)^2 \leq 0$$

$$\Leftrightarrow x \in (-\infty, 0] \cup \{2\}$$

Since coefficient of x^3

is positive and 'double root' when $x = 2$

d $x^3 > 9x$

$$\Leftrightarrow x^3 - 9x > 0$$

$$\Leftrightarrow x(x^2 - 9) > 0$$

$$\Leftrightarrow x(x - 3)(x + 3) > 0$$

$$\Leftrightarrow x \in (3, \infty) \cup (-3, 0)$$

Since coefficient of x^3 is positive

e $x^3 - 6x^2 + x \geq 6$

$$\Leftrightarrow x^3 - 6x^2 + x - 6 \geq 0$$

$$\Leftrightarrow x^2(x - 6) + x - 6 \geq 0$$

$$\Leftrightarrow (x - 6)(x^2 + 1) \geq 0$$

$$\Leftrightarrow x - 6 > 0$$

$$\Leftrightarrow x \in (6, \infty)$$

f $2x^3 - 6x^2 - 4x < -12$

$$\Leftrightarrow 2x^3 - 6x^2 - 4x + 12 < 0$$

$$\Leftrightarrow 2x^2(x - 3) - 4(x - 3) < 0$$

$$\Leftrightarrow (x - 3)(2x^2 - 4) < 0$$

$$\Leftrightarrow 2(x - 3)(x^2 - 2) < 0$$

$$\Leftrightarrow (x - 3)(x - \sqrt{2})(x + \sqrt{2}) < 0$$

$$\Leftrightarrow x \in (-\infty, -\sqrt{2}) \cup (\sqrt{2}, 3)$$

Since coefficient of x^3 is positive

Solutions to Exercise 6H

1 a $y = a(x - 3)^3 + 1$

When $x = 4, y = 12$ $12 = a(4 - 3)^2 + 1$

$\therefore a = 11$

b $y = a(x - 2)(x + 3)(x - 1)$

When $x = 3, y = 24$

$24 = a(3 - 2)(3 + 3)(3 - 1)$

$\therefore a = 2$

c $y = ax^3 + bx$

When $x = 1, y = 16$

When $x = 2, y = 40$

$16 = a + b \dots (1)$

$40 = 8a + 2b \dots (2)$

Multiply (1) by 2 and subtract from (2)

$8 = 6a$

$\therefore a = \frac{4}{3}$

$\therefore b = \frac{44}{3}$

2 a Equation is of the form

$y = -a(x + 2)^3$.

$x = 0, y = -1$:

$-1 = -8a$, so $a = \frac{1}{8}$

So $y = -\frac{1}{8}(x + 2)^3$

b Equation is of the form

$y = -a(x - 3)^3 + 2$

$x = 5, y = 0$: $0 = -8a + 2$, so $a = \frac{1}{4}$

$\therefore y = 2 - \frac{1}{4}(x - 3)^3$

3 The graph has a repeated root at (2, 0)

and cuts (0, 0), $\therefore y = ax(x - 2)^2$

Using (3, 6): $3a(3 - 2) = 6$

$\therefore a = 2$

$\therefore y = 2x(x - 2)^2$

4 Repeated root at $x = -4$, cuts at (0, 0)

$\therefore y = ax(x + 4)^2$

Using (-3, 6): $-3a(-3 + 4)^2 = 6$

$\therefore -3a = 6$

$\therefore a = -2$

$\therefore y = -2x(x + 4)^2$

5 $y = a(x - 1)(x - 3)(x + 1)$

When $x = 0, y = -6$

$\therefore -6 = a(-1)(-3)(1)$

$\therefore a = -2$

$y = -2(x - 1)(x - 3)(x + 1)$

6 $f(x) = (x^2 + a)(x - 3)$

$f(6) = 216$

$\therefore 216 = (36 + a)(3)$

$\therefore 72 = 36 + a$

$\therefore a = 36$

7 a $y = a(x - h)^3 + k$

Stationary point of inflection at (3, 2),

so $h = 3$.

Using (3, 2): $k = 2$

Using (0, -25):

$a(-3)^3 + 2 = -25$

$\therefore 27a = -27$

$\therefore a = 1$

$\therefore y = (x - 3)^3 + 2$

b $y = ax^3 + bx^2$

$\therefore y = x^2(ax + b)$

Using (1, 5):

$$a + b = 5$$

$$\therefore b = 0$$

Using (-3, -1):

$$9(-3a + b) = -1$$

$$\therefore y = ax^3 + cx$$

$$\therefore \begin{array}{r} 3a - b = \frac{1}{9} \\ a + b = 5 \end{array}$$

$$\text{and } 8a + 2c = 3 \therefore 4a + c = 1.5$$

$$\text{Using (1, 0.75): } \begin{array}{r} a + c = 0.75 \\ 3a = 0.75 \end{array}$$

$$\begin{array}{r} \hline 4a = \frac{46}{9} \end{array}$$

$$\therefore a = 0.25$$

$$\therefore c = 0.5$$

$$\therefore y = \frac{1}{4}x^3 + \frac{1}{2}x = \frac{1}{4}x(x^2 + 2)$$

$$\therefore a = \frac{23}{18}; b = \frac{67}{18}$$
$$y = \frac{1}{18}(23x^3 + 67x^2)$$

c $y = ax^3$

Using (1, 5): $a(1)^3 = 5, \therefore a = 5$

$$y = 5x^3$$

8 a Graph has axis intercepts at (0,0) and ($\pm 2, 0$):

$$y = ax(x - 2)(x + 2)$$

Using (1, 1):

$$a(1 - 2)(1 + 2) = 1$$

$$\therefore -3a = 1$$

$$\therefore a = -\frac{1}{3}$$

$$y = -\frac{1}{3}x(x - 2)(x + 2)$$

OR $y = -\frac{1}{3}x^3 + \frac{4}{3}x$

b $y = ax^3 + bx^2 + cx$

Using (2, 3): $8a + 4b + 2c = 3$

Using (-2, -3):
$$\begin{array}{r} -8a + 4b - 2c = -3 \\ \hline 8b = 0 \end{array}$$

9 $y = ax^3 + bx^2 + cx + d$

Use CAS calculator **Solve** function.

a (0, 270)(1, 312)(2, 230)(3, 0)

$$y = -4x^3 - 50x^2 + 96x + 270$$

b (-2, -406)(0, 26)(1, 50)(2, -22)

$$y = 4x^3 - 60x^2 + 80x + 26$$

c (-2, -32)(2, 8)(3, 23)(8, 428)

$$y = x^3 - 2x^2 + 6x - 4$$

d (1, -1)(2, 10)(3, 45)(4, 116)

$$y = 2x^3 - 3x$$

e (-3, -74)(-2, -23)(-1, -2)(1, -2)

$$y = 2x^3 - 3x^2 - 2x + 1$$

f (-3, -47)(-2, -15)(1, -3)(2, -7)

$$y = x^3 - 3x^2 - 2x + 1$$

g (-4, 25)(-3, 7)(-2, 1)(1, -5)

$$y = -x^3 - 3x^2 - 2x + 1$$

Solutions to Exercise 6I

1 a $y = (x + 2)^4 - 1$; vertex at $(-2, -1)$

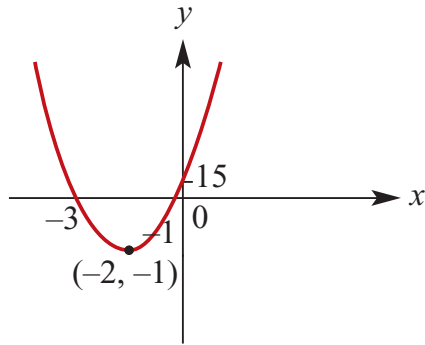

b $y = (x - 1)^4 - 1$; vertex at $(1, -1)$

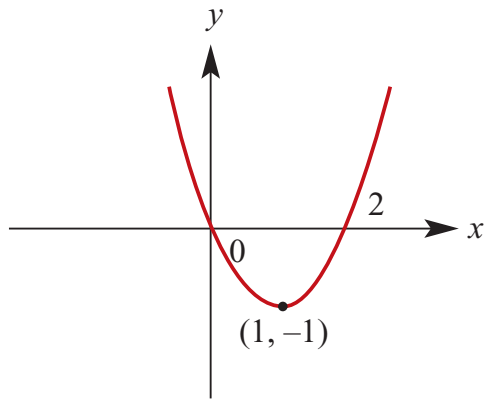

c $y = (x + 3)^4 + 2$; vertex at $(-3, 2)$

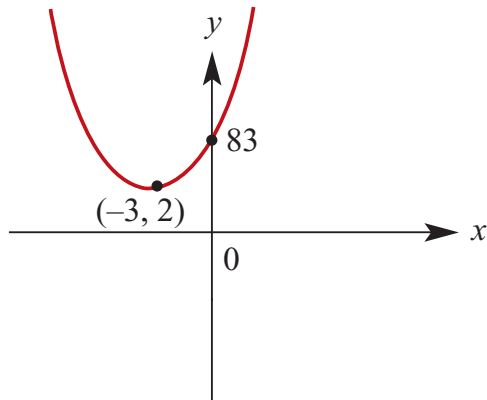

d $y = (x - 2)^4 + 5$; vertex at $(2, 5)$

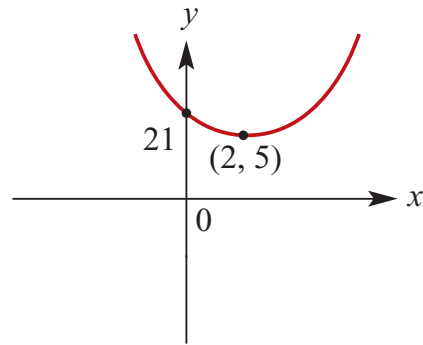

e $y = (x + 2)^4 - 5$; vertex at $(-2, -5)$

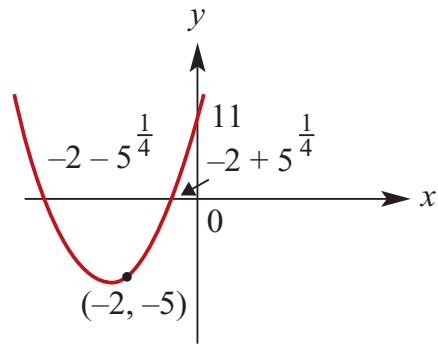

2 a $y = 2x^4 + 3$; vertex at $(0, 3)$

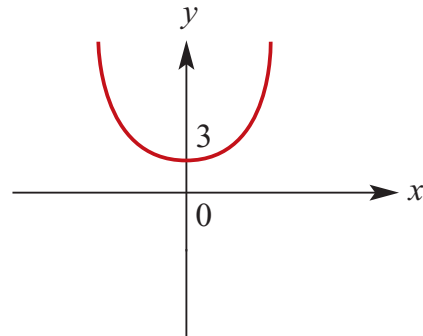

b $y = 2(x - 3)^4 + 2$; vertex at $(3, 2)$

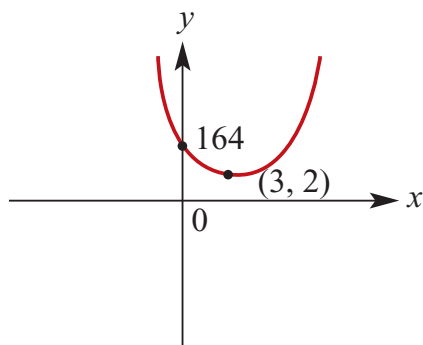

c $y = x^4 - 16$; vertex at $(0, -16)$

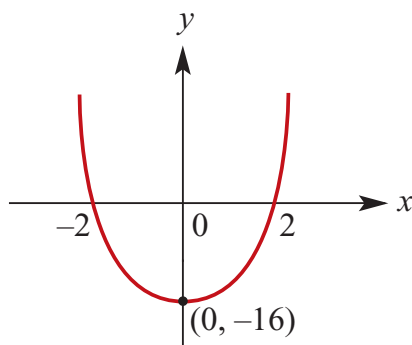

d $y = 16 - x^4$; vertex at $(0, 16)$

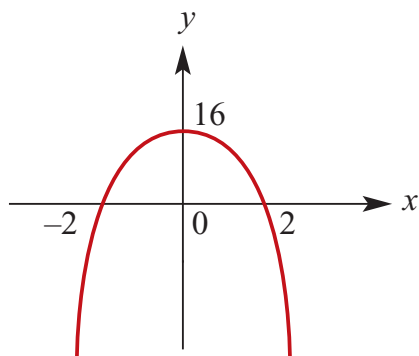

e $y = (3 - x)^4$; vertex at $(3, 0)$

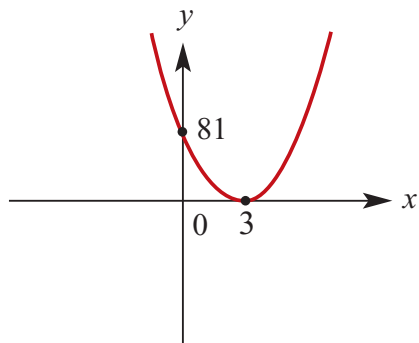

f $y = -2(x + 1)^4 + 1$; vertex at $(-1, 1)$

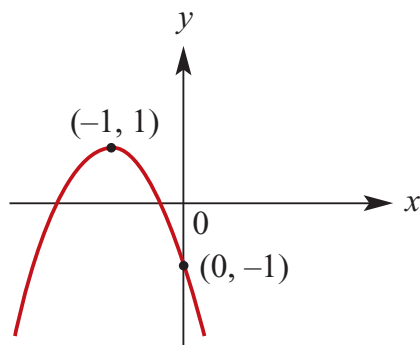

3 a $x^4 - 27x = 0$

$$\therefore x(x^3 - 27) = 0$$

$$\therefore x(x - 3)(x^2 + 3x + 9) = 0$$

$x = 0, 3$; quadratic has no real solutions

b $(x^2 - x - 2)(x^2 - 2x - 15) = 0$

$$\therefore (x - 2)(x + 1)(x - 5)(x + 3) = 0$$

$x = -3, -1, 2, 5$

c $x^4 + 8x = 0$

$$\therefore x(x^3 + 8) = 0$$

$$\therefore x(x + 2)(x^2 - 2x + 4) = 0$$

$x = 0, -2$; quadratic has no real solutions

d $x^4 - 6x^3 = 0$

$$\therefore x^3(x - 6) = 0$$

$x = 0, 6$

e $x^4 - 9x^2 = 0$

$$\therefore x^2(x^2 - 9) = 0$$

$$\therefore x^2(x - 3)(x + 3) = 0$$

$x = 0, \pm 3$

f $81 - x^4 = 0$

$$\therefore x^4 - 81 = 0$$

$$\therefore (x^2 - 9)(x^2 + 9) = 0$$

$$\therefore (x - 3)(x + 3)(x^2 + 9) = 0$$

$x = \pm 3$; quadratic has no real solutions

g $x^4 - 16x^2 = 0$
 $\therefore x^2(x^2 - 16) = 0$
 $\therefore x^2(x - 4)(x + 4) = 0$
 $x = 0, \pm 4$

h $x^4 - 7x^3 + 12x^2 = 0$
 $\therefore x^2(x^2 - 7x + 12) = 0$
 $\therefore x^2(x - 3)(x - 4) = 0$
 $x = 0, 3, 4$

i $x^4 - 9x^3 + 20x^2 = 0$
 $\therefore x^2(x^2 - 9x + 20) = 0$
 $\therefore x^2(x - 4)(x - 5) = 0$
 $x = 0, 4, 5$

j $(x^2 - 4)(x^2 - 9) = 0$
 $\therefore (x - 2)(x + 2)(x - 3)(x + 3) = 0$
 $x = \pm 2, \pm 3$

k $(x - 4)(x^2 + 2x + 8) = 0$
 $x = 4$; quadratic has no real solutions

l $(x + 4)(x^2 + 2x - 8) = 0$
 $\therefore (x + 4)(x - 2)(x + 4) = 0$
 $\therefore (x + 4)^2(x - 2) = 0$
 $x = -4, 2$

4 a $y = x^4 - 125x$
 $\therefore y = x(x^3 - 125)$
 x -intercepts: $(0, 0)$ and $(5, 0)$
 TP: $(3.15, -295.24)$

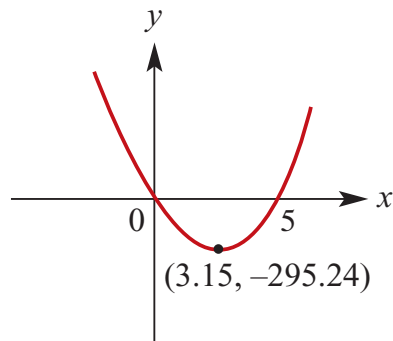

b $y = (x^2 - x - 20)(x^2 - 2x - 24)$
 $= (x - 5)(x + 4)(x + 4)(x - 6)$
 $= (x - 5)(x + 4)^2(x - 6)$
 x -intercepts: $(-4, 0)$, $(5, 0)$ and $(6, 0)$
 TPs: $(-4, 0)$, $(0.72, 503.5)$ and $(5.53, -22.62)$

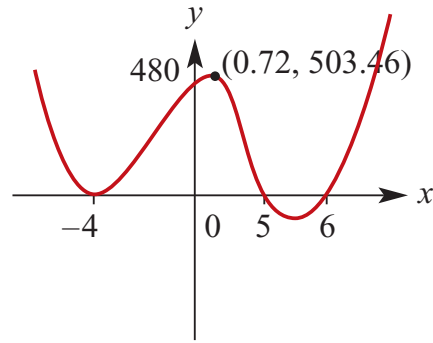

c $y = x^4 + 27x$
 x intercepts: $(0, 0)$ and $(-3, 0)$
 TP: $(-1.89, -38.27)$

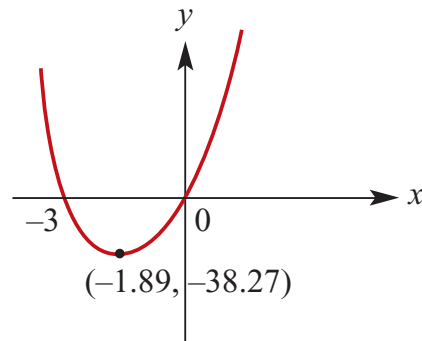

d $y = x^4 - 4x^3$
 x -intercepts: $(0, 0)$ and $(4, 0)$
 TP: $(3, -27)$

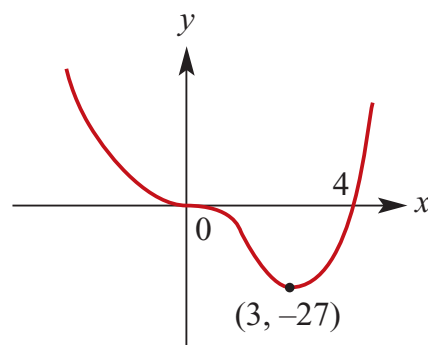

e $y = x^4 - 25x^2$
 $= x^2(x^2 - 25)$
 $= x^2(x - 5)(x + 5)$
 x-intercepts: $(0, 0)$, $(-5, 0)$ and $(5, 0)$
 TPs: $(0, 0)$, $(-3.54, -156.25)$ and $(3.54, -156.25)$

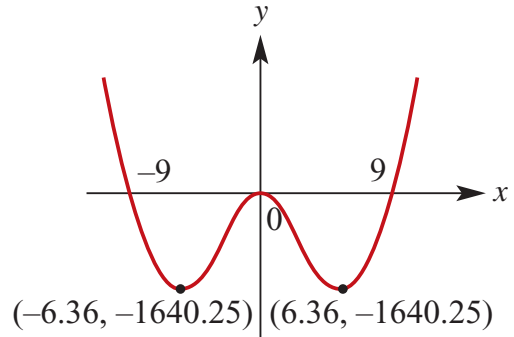
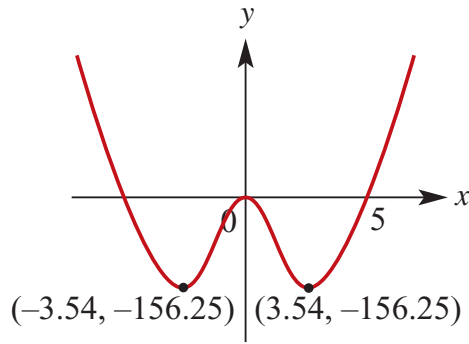

h $y = x^4 - 7x^3 + 12x^2$
 $= x^2(x^2 - 7x + 12)$
 $= x^2(x - 3)(x - 4)$
 x-intercepts: $(0, 0)$, $(3, 0)$ and $(4, 0)$
 TPs: $(0, 0)$, $(1.68, 8.64)$ and $(3.57, -3.12)$

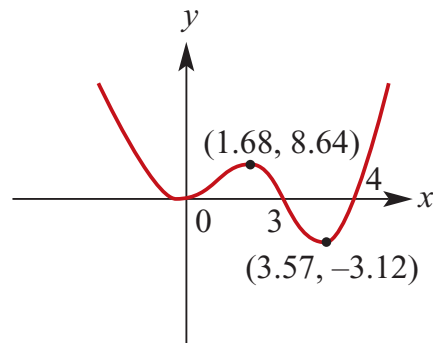

f $y = 16 - x^4$
 $= (4 - x^2)(4 + x^2)$
 $= (2 - x)(2 + x)(4 + x^2)$
 x-intercepts: $(-2, 0)$ and $(2, 0)$
 TP: $(0, 16)$

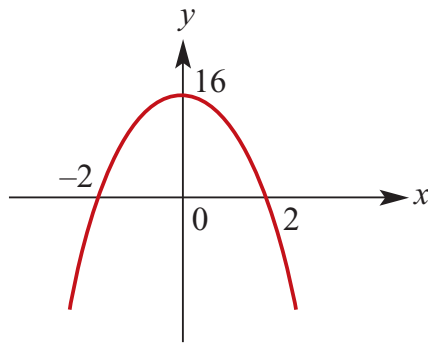

i $y = x^4 - 9x^3 + 20x^2$
 $= x^2(x^2 - 9x + 20)$
 $= x^2(x - 4)(x - 5)$
 x-intercepts: $(0, 0)$, $(4, 0)$ and $(5, 0)$
 TPs: $(0, 0)$, $(2.20, 24.39)$ and $(4.55, -5.12)$

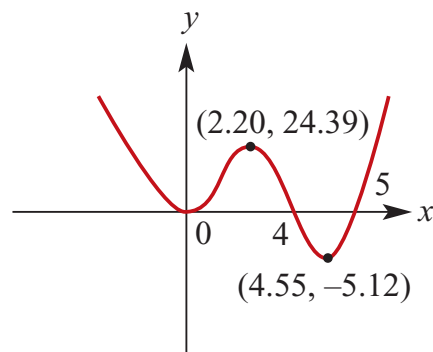

g $y = x^4 - 81x^2$
 $= x^2(x^2 - 81)$
 $= x^2(x - 9)(x + 9)$
 x-intercepts: $(0, 0)$, $(-9, 0)$ and $(9, 0)$
 TPs: $(0, 0)$, $(-6.36, -1640.25)$ and $(6.36, -1640.25)$

- j** $y = (x^2 - 16)(x^2 - 25)$
 $= (x - 4)(x + 4)(x - 5)(x + 5)$
 x-intercepts: $(-5, 0)$, $(-4, 0)$, $(4, 0)$
 and $(5, 0)$
 TPs: $(0, 400)$, $(-4.53, -20.25)$ and
 $(4.53, -20.25)$

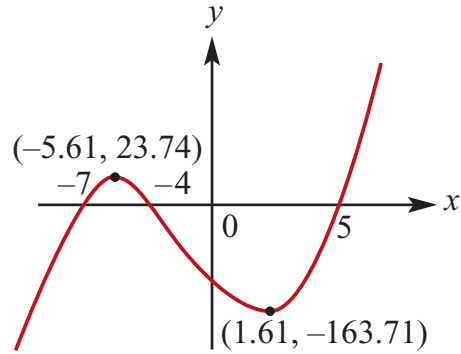
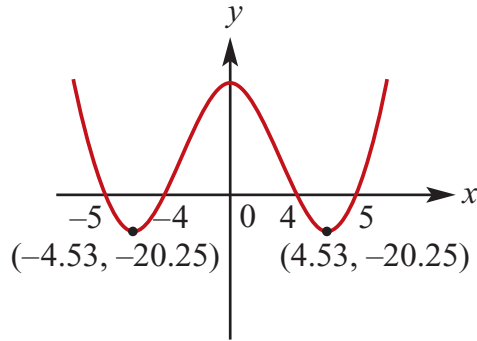

- k** $y = (x - 2)(x^2 + 2x + 10)$ x-intercept:
 $(2, 0)$

Quadratic has no real solutions.
 No Turning points, as shown by
 reference to a CAS graph.

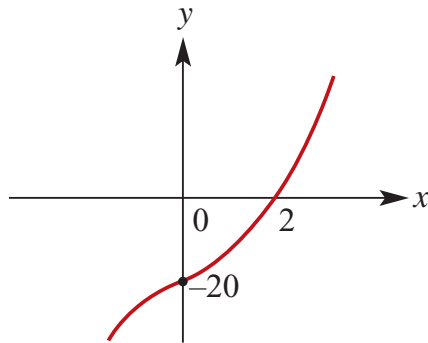

- l** $y = (x + 4)(x^2 + 2x - 35)$
 $= (x + 4)(x + 7)(x - 5)$
 x-intercepts: $(-7, 0)$, $(-4, 0)$ and $(5, 0)$
 TPs: $(-5.61, 23.74)$ and
 $(1.61, -163.71)$

5 a $f(x) = 5x^2 - 3x^2$
 $\therefore f(-x) = 5(-x)^2 - 3(-x)^2$
 $= 5x^2 - 3x^2$
 $= f(x)$

$\therefore f(x)$ is even.

b $f(x) = 7x^{11} - x^3 + 2x$
 $\therefore f(-x) = 7(-x)^{11} - (-x)^3 + 2(-x)$
 $= -7x^{11} + x^3 - 2x$
 $= -f(x)$
 $\therefore f(x)$ is odd.

c $f(x) = x^4 - 3x^2 + 2$
 $\therefore f(-x) = (-x)^4 - 3(-x)^2 + 2$
 $= x^4 - 3x^2 + 2$
 $= f(x)$
 $\therefore f(x)$ is even.

d $f(x) = x^5 - 4x^3$
 $\therefore f(-x) = (-x)^5 - 4(-x)^3$
 $= -x^5 + 4x^3$
 $= -f(x)$
 $\therefore f(x)$ is odd.

6 a

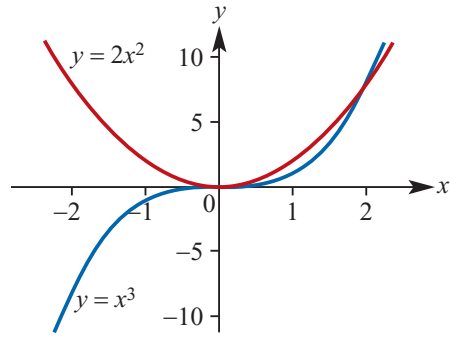

b $f(x) = g(x)$

$$x^3 = 2x^2$$

$$x^3 - 2x^2 = 0$$

$$x^2(x - 2) = 0$$

$$x = 0 \text{ or } x = 2$$

c $f(x) \leq g(x)$

$$\Leftrightarrow x^3 \leq 2x^2$$

$$\Leftrightarrow x^2(x - 2) \leq 0$$

$$\Leftrightarrow x \in (-\infty, 2]$$

7 a

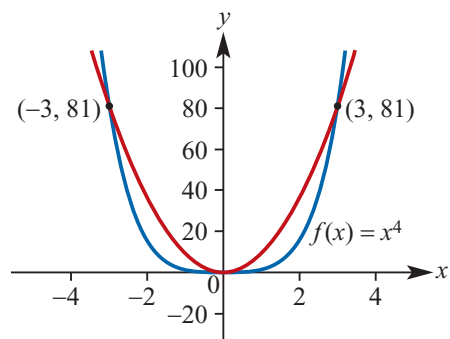

b $f(x) = g(x)$

$$x^4 = 9x^2$$

$$x^4 - 9x^2 = 0$$

$$x^2(x^2 - 9) = 0$$

$$x^2(x - 3)(x + 3) = 0$$

$$x = -3 \text{ or } x = 3 \text{ or } x = 0$$

c $f(x) \leq g(x)$

$$\Leftrightarrow x^4 \leq 9x^2$$

$$\Leftrightarrow x^2(x^2 - 9) \leq 0$$

$$\Leftrightarrow x^2(x - 3)(x + 3) \leq 0$$

$$\Leftrightarrow x \in [-3, 3]$$

8 a

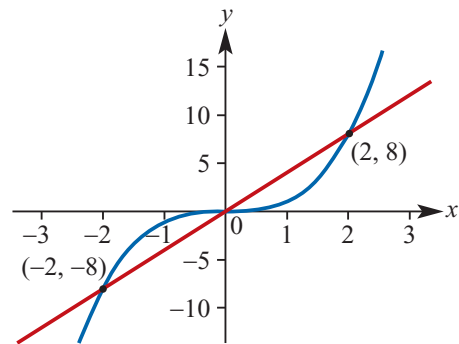

b

$$f(x) = g(x)$$

$$x^3 = 4x$$

$$x^3 - 4x = 0$$

$$x(x^2 - 4) = 0$$

$$x(x - 2)(x + 2) = 0$$

$$x = -2 \text{ or } x = 2 \text{ or } x = 0$$

c $f(x) \leq g(x)$

$$\Leftrightarrow x^3 \leq 4x$$

$$\Leftrightarrow x(x^2 - 4) \leq 0$$

$$\Leftrightarrow x \in (-\infty, -2] \cup [0, 2]$$

Solutions to Exercise 6J

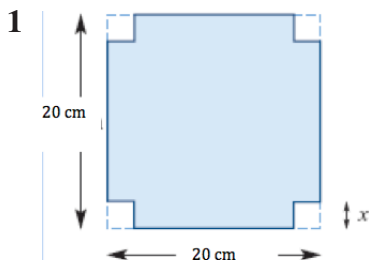

a $20 - 2x$

b $V = x(20 - 2x)^2$

c When $x = 5$,
 $V = 5(20 - 2 \times 5)^2 = 500$

d $x(20 - 2x)^2 = 500$

$$4x(100 - 20x + x^2) = 500$$

$$100x - 20x^2 + x^3 = 125$$

$$x^3 - 20x^2 + 100x - 125 = 0$$

We know that $x - 5$ is a factor

Hence

$$(x - 5)(x^2 - 15x + 25) = 0$$

$$(x - 5)\left(x^2 - 15x + \left(\frac{15}{2}\right)^2 - \left(\frac{15}{2}\right)^2 + 25\right) = 0$$

$$(x - 5)\left(x - \frac{15}{2}\right)^2 - \frac{125}{4} = 0$$

$$(x - 5)\left(x - \frac{15}{2} - \frac{5\sqrt{5}}{2}\right)\left(x - \frac{15}{2} + \frac{5\sqrt{5}}{2}\right) = 0$$

The required other value is

$$x = \frac{15 - 5\sqrt{5}}{2}$$

2 a $l = 12 - 2x$ $w = 10 - 2x$

b $V = \text{length} \times \text{width} \times \text{height}$

$$= (12 - 2x)(10 - 2x)x$$

$$= 4x(6 - x)(5 - x)$$

c

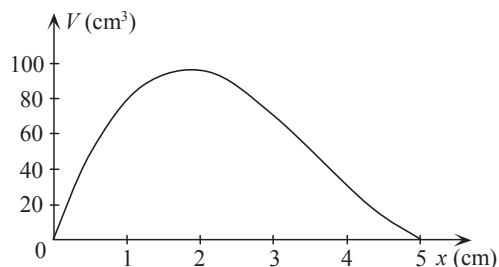

d When $x = 1$,

$$V = (12 - 2(1))(10 - 2(1))(1)$$

$$= 10 \times 8$$

$$= 80$$

Or select **1:Value** from the **F5 Math** menu of the CAS calculator.

e On the CAS calculator, sketch the graphs of $Y_1 = 4X(6 - X)(5 - X)$ and $Y_2 = 50$.

The points of intersection are (0.50634849, 50) and (3.5608171, 50).

Therefore $V = 50$ when $x = 0.51$ or $x = 3.56$, correct to 2 decimal places.

f With $f1 = 4x \times (6 - x)(5 - x)$

TI: Press **Menu** \rightarrow **6:**

Analyze Graph \rightarrow **3:Maximum**

CP: Tap **Analysis** \rightarrow **G-Solve** \rightarrow

Max

to yield (1.810745, 96.770576).

Therefore the maximum volume is 96.77 cm^3 and occurs when $x = 1.81$, correct to 2 decimal places.

Alternatively, type

TI:

fMax($4x \times (6 - x)(5 - x)$, x , **0**, **5**)

CP:

fMax($4x \times (6 - x)(5 - x)$, x , **0**, **5**)

to give the maximum when

$x = \frac{11 - \sqrt{31}}{3} \approx 1.81$; then
maximum volume is 96.77 cm^3 .

3 a Surface area $x^2 + 4xh$

b $x^2 + 4xh = 75$
 $\therefore h = \frac{75 - x^2}{4x}$

c $V = x^2h = \frac{x(75 - x^2)}{4}$

d i When $x = 2$, $V = \frac{71}{2}$

ii When $x = 5$, $V = \frac{125}{2}$

iii When $x = 8$, $V = 22$

e It is given that $x = 4$ is a solution of the equation:

$$\frac{x(75 - x^2)}{4} = 59$$

Rearranging we have:

5 $x(75 - x^2) = 236$

$$x^3 - 75x + 236 = 0$$

$$(x - 4)(x^2 + 4x - 59) = 0$$

$$(x - 4)(x^2 + 4x + 4 - 63) = 0$$

$$(x - 4)((x + 2)^2 - 63) = 0$$

$$(x - 4)(x + 2 - 3\sqrt{7})(x + 2 + 3\sqrt{7}) = 0$$

The required solution is $x = 3\sqrt{7} - 2$

4 The base is a right-angled triangle
($5x$, $12x$, $13x$)

a The sum of all the lengths of the prisms edges is 180 cm

$$\therefore 2(5x + 12x + 13x) + 3h = 180$$

$$\therefore 60x + 3h = 180$$

$$\therefore h = \frac{180 - 60x}{3} = 60 - 20x$$

b The area of the base is $30x^2$.

$$\therefore V = 30x^2(60 - 20x) = 600x^2(3 - x)$$

c When $x = 3$, $V = 0$

d

$$600x^2(3 - x) = 1200$$

$$x^2(3 - x) = 2$$

$$3x^2 - x^3 = 2$$

$$x^3 - 3x^2 + 2 = 0$$

$$(x - 1)(x^2 - 2x - 2) = 0$$

$$(x - 1)(x^2 - 2x + 1 - 3) = 0$$

$$(x - 1)((x - 1)^2 - 3) = 0$$

$$(x - 1)((x - 1 - \sqrt{3})(x - 1 + \sqrt{3})) = 0$$

Required solutions $x = 1 + \sqrt{3}$ and
 $x = 1$

5 a Using Pythagoras' theorem,

$$x^2 + h^2 = 8^2$$

$$x = \sqrt{64 - h^2}$$

b $V = \frac{1}{3}\pi x^2 h$

$$= \frac{1}{3}\pi(64 - h^2)h$$

c

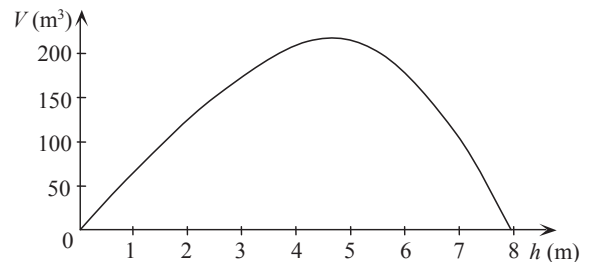

d Domain = $\{h : 0 < h < 8\}$

e When $h = 4$,
$$V = \frac{1}{3}\pi(64 - 4^2)(4)$$
$$= 64\pi$$

Alternatively, choose **1:Value** from the **F5 Math** menu of the CAS calculator to yield

$$V = 201.06193$$

$$\approx 64\pi$$

f On the CAS calculator, sketch the graphs of $f1 = \frac{1}{3}\pi(64 - x^2) \times x$ and $f2 = 150$. The points of intersection are (2.4750081, 150) and (6.4700086, 0.150). Therefore $V = 150$ when $h = 2.48$ or $h = 6.47$, correct to 2 decimal places.

g With $f1 = \frac{1}{3}\pi(64 - x^2) \times x$,
TI: Press Menu →
6:Analyze Graph → 3:Maximum
CP: Tap Analysis → G – Solve → Max
 to yield (4.6187997, 206.37006).
 Therefore the maximum volume is 206.37 m^3 and occurs when $h = 4.62$, correct to 2 decimal places.
 Alternatively, use
fMax($\frac{1}{3}\pi(64 - x^2) \times x, x, 0, 8$)
 to give the maximum when
 $h = \frac{8\sqrt{3}}{3} \approx 4.62$; then maximum volume is 206.37 m^3 .

6 a $x + x + h = 160$
 $2x + h = 160$
 $h = 160 - 2x$

b

$$V = x \times x \times h$$

$$= x^2(160 - 2x)$$

When $V = 0$, $x^2 = 0$ or $160 - 2x = 0$
 $\therefore x = 0$ or $160 = 2x$
 $\therefore x = 80$

c \therefore Domain $V = \{x : 0 < x < 80\}$

d

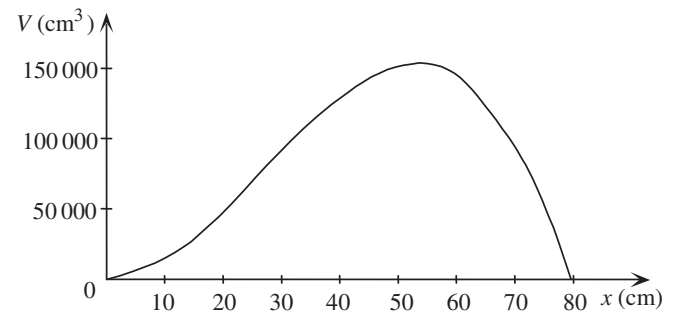

e On the CAS calculator, sketch the graphs of $f1 = x^2(160 - 2x)$ and $f2 = 50\,000$. The points of intersection are (20.497586, 50000) and (75.629199, 50000). Therefore $V = 50\,000$ when $x = 20.50$ or $x = 75.63$, correct to 2 decimal places.

f With $f1 = x^2(160 - 2x)$,
TI: Press Menu →
6:Analyze Graph → 3:Maximum
CP: Tap Analysis → G – Solve → Max to yield (53.333336, 151703.7).
 Therefore the maximum volume is $151\,704 \text{ cm}^3$ (to the nearest cm^3).
 Alternatively, use
fMax($x^2(160 - 2x), x, 0, 80$)
 to give the maximum when
 $h = \frac{160}{3} \approx 53\frac{1}{3}$; then maximum volume is 151703.7 cm^3 .

Solutions to Exercise 6K

See The TI Calculator Appendix for how to complete with a spreadsheet application on the calculator.

- 1 a The formula for the spreadsheet for solving $x^3 - x - 1 = 0$ in the interval $[1, 2]$ is shown.

	A	B	C	D	E
7	Step 1	1	2	=0.5*(B7+C7)	=0.5*(C7+D7)
8	Step 2	=IF((B7^3-B7-1)*(D7^3-D7-1)<=0,B7,D7)	=IF(B8=B7,D7,C7)	=0.5*(B8+C8)	=0.5*(C8+D8)
9	Step 3	=IF((B8^3-B8-1)*(D8^3-D8-1)<=0,B8,D8)	=IF(B9=B8,D8,C8)	=0.5*(B9+C9)	=0.5*(C9+D9)
10	Step 4	=IF((B9^3-B9-1)*(D9^3-D9-1)<=0,B9,D9)	=IF(B10=B9,D9,C9)	=0.5*(B10+C10)	=0.5*(C10+D10)
11	Step 5	=IF((B10^3-B10-1)*(D10^3-D10-1)<=0,B10,D10)	=IF(B11=B10,D10,C10)	=0.5*(B11+C11)	=0.5*(C11+D11)
12	Step 6	=IF((B11^3-B11-1)*(D11^3-D11-1)<=0,B11,D11)	=IF(B12=B11,D11,C11)	=0.5*(B12+C12)	=0.5*(C12+D12)
13	Step 7	=IF((B12^3-B12-1)*(D12^3-D12-1)<=0,B12,D12)	=IF(B13=B12,D12,C12)	=0.5*(B13+C13)	=0.5*(C13+D13)
14	Step 8	=IF((B13^3-B13-1)*(D13^3-D13-1)<=0,B13,D13)	=IF(B14=B13,D13,C13)	=0.5*(B14+C14)	=0.5*(C14+D14)
15	Step 9	=IF((B14^3-B14-1)*(D14^3-D14-1)<=0,B14,D14)	=IF(B15=B14,D14,C14)	=0.5*(B15+C15)	=0.5*(C15+D15)
16	Step 10	=IF((B15^3-B15-1)*(D15^3-D15-1)<=0,B15,D15)	=IF(B16=B15,D15,C15)	=0.5*(B16+C16)	=0.5*(C16+D16)

The first 10 steps are shown here.

	A	B	C	D	E
7	Step 1	1	2	1.5	1.75
8	Step 2	1	1.5	1.25	1.375
9	Step 3	1.25	1.5	1.375	1.4375
10	Step 4	1.25	1.375	1.3125	1.3438
11	Step 5	1.3125	1.375	1.3438	1.3594
12	Step 6	1.3125	1.34375	1.3281	1.3359
13	Step 7	1.3125	1.328125	1.3203	1.3242
14	Step 8	1.3203125	1.328125	1.3242	1.3262
15	Step 9	1.32421875	1.328125	1.3262	1.3271
16	Step 10	1.32421875	1.3261719	1.3252	1.3257

Answer: 1.32

We go through the first few steps for this question. We now return to the function $f(x) = x^3 - x - 1$ and finding the solution of the equation $x^3 - x - 1 = 0$.

- Step 1** We start with the interval $[1, 2]$, since we know the solution lies in this interval.

$$f(1) = -1 < 0 \text{ and } f(2) = 5 > 0.$$

$$\frac{1+2}{2} = 1.5.$$

Since $f(1.5) = 0.875 > 0$, we now know the solution is between 1 and 1.5.

- Step 2** Choose 1.5 as the new left endpoint. Therefore the second interval is $[1, 1.5]$.

$$\frac{1+1.5}{2} = 1.25 \text{ and } f(1.25) = -0.296875 > 0.$$

- Step 3** Choose 1.25 as the new left endpoint. Thus the third interval is $[1.25, 1.5]$.

$$\text{Now } \frac{1.25+1.5}{2} = 1.375 \text{ and } f(1.375) = 0.224069 < 0.$$

- Step 4** Choose 1.375 as the new left endpoint. Thus the fourth interval is $[1.25, 1.375]$.

At this point we know that the solution is in the interval $[1.25, 1.375]$.

b

	A	B	C	D	E
7	Step 1	1	3	2	2.5
8	Step 2	1	2	1.5	1.75
9	Step 3	1	1.5	1.25	1.375
10	Step 4	1	1.25	1.125	1.1875
11	Step 5	1.125	1.25	1.1875	1.2188
12	Step 6	1.125	1.1875	1.1563	1.1719
13	Step 7	1.15625	1.1875	1.1719	1.1797
14	Step 8	1.15625	1.171875	1.1641	1.168
15	Step 9	1.15625	1.1640625	1.1602	1.1621
16	Step 10	1.16015625	1.1640625	1.1621	1.1631
17	Step 11	1.162109375	1.1640625	1.1631	1.1636
18	Step 12	1.163085938	1.1640625	1.1636	1.1638
19	Step 13	1.163574219	1.1640625	1.1638	1.1639
20	Step 14	1.163818359	1.1640625	1.1639	1.164
21	Step 15	1.16394043	1.1640625	1.164	1.164
22	Step 16	1.164001465	1.1640625	1.164	1.164
23	Step 17	1.164031982	1.1640625	1.164	1.1641

Answer: 1.164

- c** There are two solutions in the interval $[1, 2]$. Care must be taken. First apply the bisection method in $[1, 1.3]$ and then in $[1.3, 2]$

	A	B	C	D	E
7	Step 1	1	1.3	1.15	1.225
8	Step 2	1	1.15	1.075	1.1125
9	Step 3	1.075	1.15	1.1125	1.1313
10	Step 4	1.1125	1.15	1.1313	1.1406
11	Step 5	1.1125	1.13125	1.1219	1.1266
12	Step 6	1.121875	1.13125	1.1266	1.1289
13	Step 7	1.121875	1.1265625	1.1242	1.1254
14	Step 8	1.121875	1.1242188	1.123	1.1236
15	Step 9	1.123046875	1.1242188	1.1236	1.1239
16	Step 10	1.123632813	1.1242188	1.1239	1.1241
17	Step 11	1.123925781	1.1242188	1.1241	1.1241
18	Step 12	1.123925781	1.1240723	1.124	1.124
19	Step 13	1.123999023	1.1240723	1.124	1.1241
20	Step 14	1.123999023	1.1240356	1.124	1.124
21	Step 15	1.124017334	1.1240356	1.124	1.124
22	Step 16	1.124026489	1.1240356	1.124	1.124
23	Step 17	1.124026489	1.1240311	1.124	1.124

	A	B	C	D	E
7	Step 1	1.3	2	1.65	1.825
8	Step 2	1.3	1.65	1.475	1.5625
9	Step 3	1.3	1.475	1.3875	1.4313
10	Step 4	1.3875	1.475	1.4313	1.4531
11	Step 5	1.43125	1.475	1.4531	1.4641
12	Step 6	1.43125	1.453125	1.4422	1.4477
13	Step 7	1.4421875	1.453125	1.4477	1.4504
14	Step 8	1.44765625	1.453125	1.4504	1.4518
15	Step 9	1.450390625	1.453125	1.4518	1.4524
16	Step 10	1.450390625	1.4517578	1.4511	1.4514
17	Step 11	1.450390625	1.4510742	1.4507	1.4509
18	Step 12	1.450732422	1.4510742	1.4509	1.451
19	Step 13	1.45090332	1.4510742	1.451	1.451
20	Step 14	1.45098877	1.4510742	1.451	1.4511
21	Step 15	1.451031494	1.4510742	1.4511	1.4511
22	Step 16	1.451031494	1.4510529	1.451	1.451
23	Step 17	1.451042175	1.4510529	1.451	1.4511

Answers: 1.124 and 1.451

d

	A	B	C	D	E
7	Step 1	2	3	2.5	2.75
8	Step 2	2	2.5	2.25	2.375
9	Step 3	2	2.25	2.125	2.1875
10	Step 4	2.125	2.25	2.1875	2.2188
11	Step 5	2.125	2.1875	2.1563	2.1719
12	Step 6	2.125	2.15625	2.1406	2.1484
13	Step 7	2.140625	2.15625	2.1484	2.1523
14	Step 8	2.1484375	2.15625	2.1523	2.1543
15	Step 9	2.1484375	2.1523438	2.1504	2.1514
16	Step 10	2.150390625	2.1523438	2.1514	2.1519
17	Step 11	2.150390625	2.1513672	2.1509	2.1511
18	Step 12	2.150878906	2.1513672	2.1511	2.1512
19	Step 13	2.150878906	2.151123	2.151	2.1511
20	Step 14	2.150878906	2.151001	2.1509	2.151
21	Step 15	2.150878906	2.1509399	2.1509	2.1509
22	Step 16	2.150909424	2.1509399	2.1509	2.1509

Answer: 2.151

e

	A	B	C	D	E
7	Step 1	-2	-1	-1.5	-1.25
8	Step 2	-2	-1.5	-1.75	-1.625
9	Step 3	-1.75	-1.5	-1.625	-1.5625
10	Step 4	-1.75	-1.625	-1.6875	-1.6563
11	Step 5	-1.75	-1.6875	-1.7188	-1.7031
12	Step 6	-1.75	-1.71875	-1.7344	-1.7266
13	Step 7	-1.75	-1.734375	-1.7422	-1.7383
14	Step 8	-1.75	-1.7421875	-1.7461	-1.7441
15	Step 9	-1.75	-1.7460938	-1.748	-1.7471
16	Step 10	-1.748046875	-1.7460938	-1.7471	-1.7466
17	Step 11	-1.748046875	-1.7470703	-1.7476	-1.7473
18	Step 12	-1.748046875	-1.7475586	-1.7478	-1.7477
19	Step 13	-1.747802734	-1.7475586	-1.7477	-1.7476
20	Step 14	-1.747680664	-1.7475586	-1.7476	-1.7476
21	Step 15	-1.747680664	-1.7476196	-1.7477	-1.7476
22	Step 16	-1.747680664	-1.7476501	-1.7477	-1.7477

Answer -1.75

Solutions to Technology-free questions

1 a $y = (x - 1)^3 - 2$

Stationary point of inflection at

$(1, -2)$

x-intercept at $(1 + \sqrt[3]{2}, 0)$

y-intercept at $(0, -3)$

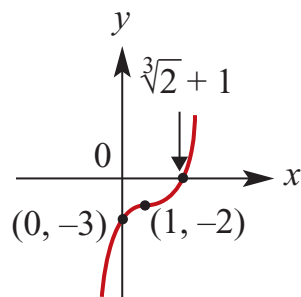

b $y = (2x - 1)^3 + 1$

Stationary point of inflection at $(\frac{1}{2}, 1)$

Axis intercept at $(0, 0)$

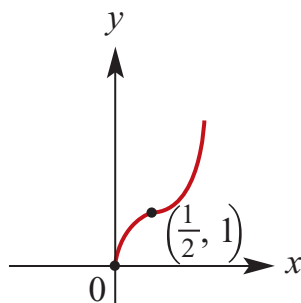

c $y = 3(x - 1)^3 - 1$

Stationary point of inflection at

$(1, -1)$

x-intercept at $(1 + \sqrt[3]{\frac{1}{3}}, 0)$

y-intercept at $(0, -4)$

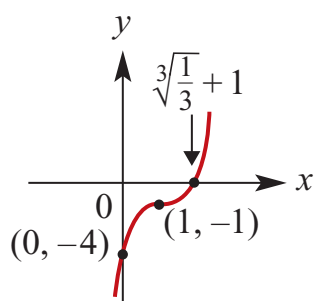

d $y = -3x^3$

Stationary point of inflection at $(0, 0)$

Axis intercept at $(0, 0)$

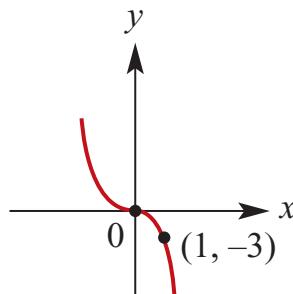

e $y = -3x^3 + 1$

Stationary point of inflection at $(0, 1)$

x-intercept at $(\sqrt[3]{\frac{1}{3}}, 0)$

y-intercept at $(0, 1)$

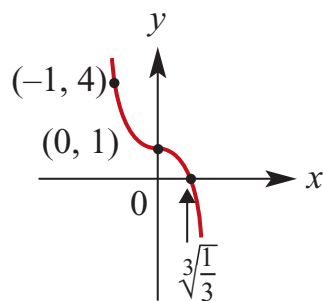

f $y = -3(x - 2)^3 + 1$

Stationary point of inflection at $(2, 1)$

x-intercept at $(2 + \sqrt[3]{\frac{1}{3}}, 0)$

y-intercept at $(0, 25)$

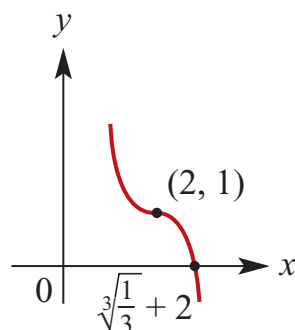

g $y = 4(x + 2)^3 - 3$

Stationary point of inflection at

$(-2, -3)$

x-intercept at $(-2 + \sqrt[3]{\frac{3}{4}}, 0)$
 y-intercept at $(0, 29)$

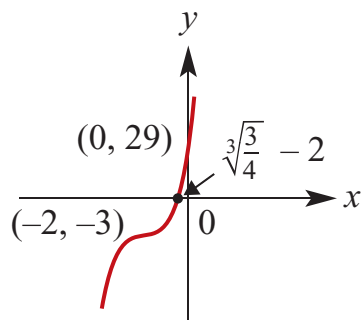

h $y = 1 - 3(x + 2)^3$
 Stationary point of inflection at $(-2, 1)$

x-intercept at $(-2 + \sqrt[3]{\frac{1}{3}}, 0)$
 y-intercept at $(0, -23)$

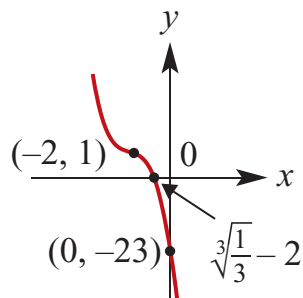

2 a $y = (x - 1)^4$
 Turning point at $(1, 0)$
 y-intercept at $(0, 1)$, x-intercept at $(1, 0)$

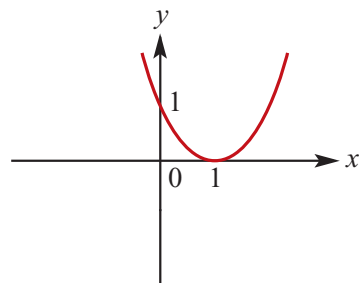

b $y = (2x - 1)^4 + 1$
 Turning point at $(\frac{1}{2}, 1)$
 y-intercept at $(0, 2)$, no x-intercept

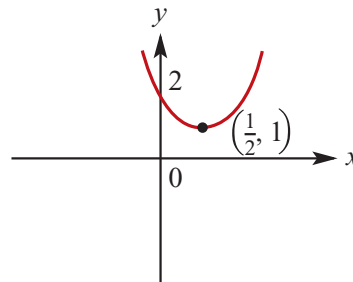

c $y = (x - 1)^4 - 1$
 Turning point at $(1, -1)$
 y-intercept at $(0, 0)$,
 x-intercept at $(0, 0)$ and $(2, 0)$

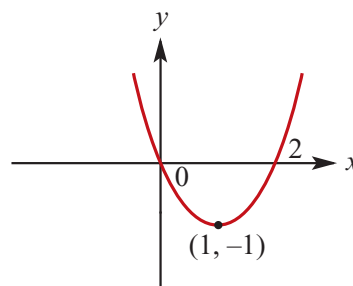

d $y = -2x^4$
 Turning point and axis intercept at $(0, 0)$

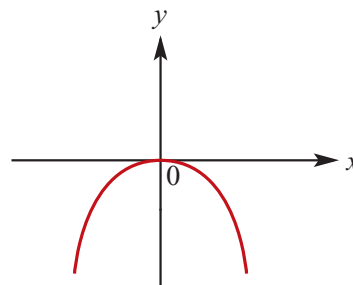

e $y = -3x^4 + 1$
 Turning point at $(0, 1)$
 x-intercepts at $(\pm \sqrt[4]{\frac{1}{3}}, 0)$
 y-intercept at $(0, 1)$

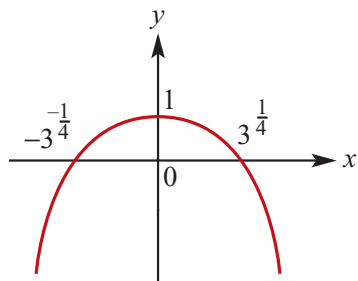

- f** $y = -(x - 2)^4 + 1$
 Turning point at $(2, 1)$
 y-intercept at $(0, -15)$
 x-intercept $(1, 0)$ and $(3, 0)$

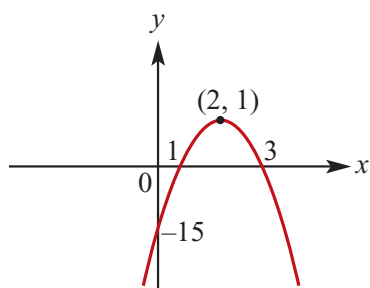

- g** $y = 2(x + 1)^4 - 3$
 Turning point at $(-1, -3)$
 x-intercepts at $(-1 \pm \sqrt[4]{\frac{3}{2}}, 0)$
 y-intercept at $(0, 1)$

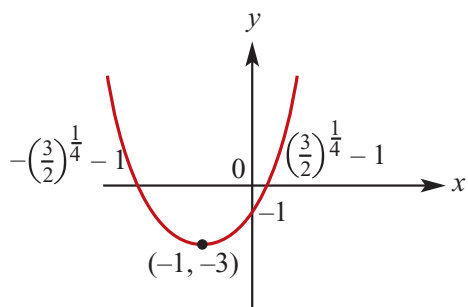

- h** $y = 1 - 2(x + 2)^4$
 Turning point at $(-2, 1)$
 x-intercepts at $(-2 \pm \sqrt[4]{\frac{1}{2}}, 0)$
 y-intercept at $(0, -31)$

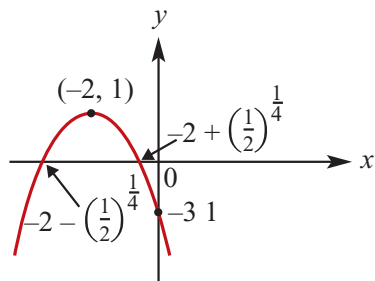

3 a $2x^3 + 3x^2 = 11x + 6$

$$2x^3 + 3x^2 - 11x - 6 = 0$$

$$(2x + 1)(x^2 + x - 6) = 0$$

$$(2x + 1)(x + 3)(x - 2) = 0$$

$$x = -\frac{1}{2} \text{ or } x = -3 \text{ or } x = 2$$

b $x^2(5 - 2x) = 4$

$$5x^2 - 2x^3 - 4 = 0$$

$$2x^3 - 5x^2 + 4 = 0$$

$$(x - 2)(2x^2 - x - 2) = 0$$

$$x = 2 \text{ or } 2x^2 - x - 2 = 0$$

$$x = 2 \text{ or } x = \frac{1 \pm \sqrt{17}}{4}$$

c $x^3 - 7x^2 + 4x + 12 = 0$

$$(x - 6)(x^2 - x - 2) = 0$$

$$(x - 6)(x - 2)(x + 1) = 0$$

$$x = 6 \text{ or } x = 2 \text{ or } x = -1$$

4 a $P(x) = 6x^3 + 5x^2 - 17x - 6$

$$P(-2) = 6(-8) + 5(4) - 17(-2) - 6 = 0$$

So $x + 2$ is a factor of $P(x)$.

$$P\left(\frac{3}{2}\right) = 6\left(\frac{27}{8}\right) + 5\left(\frac{9}{4}\right) - 17\left(\frac{3}{2}\right) - 6 = 0$$

So $2x - 3$ is a factor of $P(x)$.

$$\therefore P(x) = (x + 2)(2x - 3)(ax + b)$$

$$= (ax + b)(2x^2 + x - 6)$$

Matching coefficients with $P(x)$:

$$2a = 6, \therefore a = 3$$

$$-6b = -6, \therefore b = 1$$

So the other factor is $3x + 1$.

b $P(x) = 2x^3 - 3x^2 - 11x + 6 = 0$
 $P(-2) = 0$, so $(x + 2)$ is a factor.
 $P(3) = 0$, so $(x - 3)$ is a factor.
 $P(x) = (ax + b)(x + 2)(x - 3)$

$$= (ax + b)(x^2 - x - 6)$$

Matching coefficients with $P(x)$:

$$a = 2$$

$$-6b = 6, \therefore b = -1$$

$$\therefore P(x) = (2x - 1)(x + 2)(x - 3)$$

$$x = -2, \frac{1}{2}, 3$$

c $x^3 + x^2 - 11x - 3 = 8$
 $\therefore P(x) = x^3 + x^2 - 11x - 11 = 0$
 $P(-1) = 0$, so $(x + 1)$ is a factor.
 $\therefore P(x) = x^2(x + 1) - 11(x + 1) = 0$
 $= (x + 1)(x^2 - 11) = 0$
 $x = -1, \pm\sqrt{11}$

d i $P(x) = 3x^3 + 2x^2 - 19x + 6$
 $P\left(\frac{1}{3}\right) = \frac{3}{27} + \frac{2}{9} - \frac{19}{3} + 6 = 0$
 so $(3x - 1)$ is a factor.

ii $P(2) = 24 + 8 - 38 + 6 = 0$
 so $(x - 2)$ is a factor.
 $P(x) = (ax + b)(x - 2)(3x - 1)$
 $= (ax + b)(3x^2 - 7x + 2)$
 Matching coefficients:
 $a = 1, b = 3$
 $\therefore P(x) = (x + 3)(x - 2)(3x - 1)$

5 a $f(x) = x^3 - kx^2 + 2kx - k - 1$
 $\therefore f(1) = 1 - k + 2k - k - 1 = 0$
 By the Factor Theorem, $f(x)$ is divisible by $x - 1$.

$$\begin{array}{r} x^2 + (1 - k)x + (k + 1) \\ x - 1 \overline{) x^3 - kx^2 + 2kx - k - 1} \\ \underline{x^3 - x^2} \\ (1 - k)x^2 + 2kx \\ \underline{(1 - k)x^2 - (1 - k)x} \\ (k + 1)x - (k + 1) \\ \underline{(k + 1)x - (k + 1)} \\ 0 \end{array}$$

$$f(x) = (x - 1)(x^2 + (1 - k)x + k + 1)$$

6 $P(x) = x^3 + ax^2 - 10x + b$
 $P(x)$ is divisible by $Q(x) = x^2 + x - 12$
 $Q(x) = (x - 3)(x + 4)$, so
 $P(3) = P(-4) = 0$
 $P(3) = 27 + 9a - 30 + b = 0$
 $\therefore 9a + b = 3$
 $P(-4) = -64 + 16a + 40 + b = 0$
 $\therefore 16a + b = 24$
 $\therefore 7a = 21$
 $\therefore a = 3; b = -24$

7 Arrange in left-to-right order first.

a $y = (x + 4)(x + 2)(3 - x)$
 Inverted cubic.
 Axis intercepts: $(-4, 0)$, $(-2, 0)$, $(3, 0)$
 and $(0, 24)$

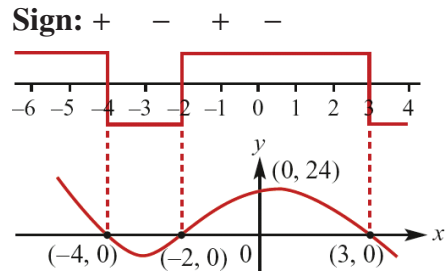

b $y = (x + 3)(x - 2)(x - 4)$
 Upright cubic.
 Axis intercepts: $(-3, 0)$, $(2, 0)$, $(4, 0)$
 and $(0, 24)$

Sign: + - + -

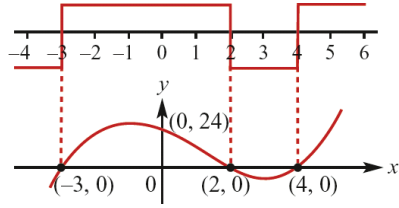

c $y = 6x^3 + 13x^2 - 4$
 Upright cubic.
 $y(-2) = -48 + 52 - 4 = 0$
 So $(x + 2)$ is a factor.
 $\therefore y = (x + 2)(6x^2 + x - 2)$

$= (x + 2)(3x + 2)(2x - 1)$
 Axis intercepts:
 $(-2, 0)$, $(-\frac{2}{3}, 0)$, $(\frac{1}{2}, 0)$ and $(0, -4)$
 Sign: + - + -

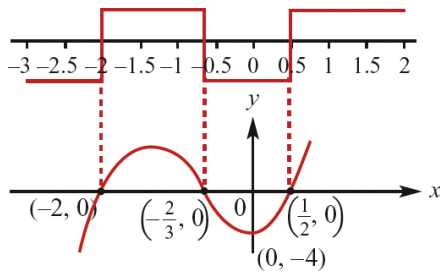

d $y = x^3 + x^2 - 24x + 36$
 Upright cubic.
 $y(2) = 8 + 4 - 48 + 36 = 0$
 So $(x - 2)$ is a factor.
 $\therefore y = (x - 2)(x^2 + 3x - 18)$
 $= (x + 6)(x - 2)(x - 3)$
 Axis intercepts: $(-6, 0)$, $(2, 0)$, $(3, 0)$
 and $(0, 36)$
 Sign: + - + -

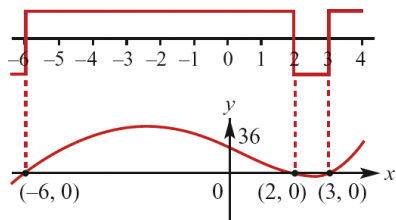

8 a $P(x) = x^3 + 4x^2 - 5x + 1$.
 Remainder after division by

$(x + 6) = P(-6) = -41$

b $P(x) = 2x^3 - 3x^2 + 2x + 4$.
 Remainder after division by
 $(x - 2) = P(2) = 12$

c $P(x) = 3x^3 + 2x + 4$.
 Remainder after division by
 $(3x - 1) = P(\frac{1}{3}) = \frac{43}{9}$

9 $y = a(x + 2)(x - 1)(x - 5)$ accounts for
 the x intercepts.

At $x = 0$, $y = a(2)(-1)(-5) = -4$
 $\therefore a = -\frac{2}{5}$

$y = -\frac{2}{5}(x + 2)(x - 1)(x - 5)$

10 Cubic passes through the origin and
 touches the x -axis at $(-4, 0)$

$\therefore y = ax(x + 4)^2$

Using $(5, 10)$:

$5a(5 + 4)^2 = 10$, $\therefore a = \frac{2}{81}$

$\therefore y = \frac{2}{81}x(x + 4)^2$

11 a $f(x) = 2x^3 + ax^2 - bx + 3$
 $f(1) = 2 + a - b + 3 = 0$

$\therefore b - a = 5 \dots (1)$

$f(2) = 16 + 4a - 2b + 3 = 15$

$\therefore 4a - 2b = -4$

$\therefore b - 2a = 2 \dots (2)$

$(1) - (2)$ gives $a = 3$, $b = 8$

b $f(x) = 2x^3 + 3x^2 - 8x + 3$
 $= (x - 1)(2x^2 + 5x - 3)$
 $= (x - 1)(2x - 1)(x + 3)$

12 a $(x - 3)^2(x + 4) \leq 0$

$$\Leftrightarrow x + 4 \leq 0 \text{ or } x = 3$$

$$\Leftrightarrow x \leq -4 \text{ or } x = 3$$

b $-(x + 3)(x + 4)(x - 2) \geq 0$

$$\Leftrightarrow (x + 3)(x + 4)(x - 2) \leq 0$$

$$\Leftrightarrow x \in (-\infty, -4] \cup [-3, 2]$$

c $x^3 - 4x^2 + x + 6 < 0$

$$\Leftrightarrow (x + 1)(x^2 - 5x + 6) < 0$$

$$\Leftrightarrow (x + 1)(x - 3)(x - 2) < 0$$

$$\Leftrightarrow x \in (-\infty, -1) \cup (2, 3)$$

13 $f(x) = x^3$

a Dilation by a factor of 2 from x -axis:

$$y = 2x^3$$

Translation 1 unit in positive x and 3 units in positive y :

$$y = 2(x - 1)^3 + 3$$

b Reflection in x -axis:

$$y = -x^3$$

Translation 1 unit in negative x and 2 units in positive y :

$$y = -(x + 1)^3 + 2$$

c Dilation by a factor of $\frac{1}{2}$ from y -axis:

$$y = (2x)^3$$

Translation $\frac{1}{2}$ unit in negative x and 2 units in negative y :

$$y = (2(x + \frac{1}{2}))^3 - 2$$

$$= (2x + 1)^3 - 2$$

Solutions to multiple-choice questions

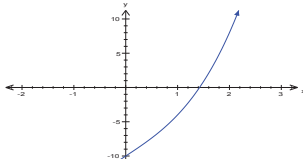
- 1 B** $P(x) = x^3 + 3x^2 + x - 3$
 $\therefore P(-2) = (-2)^3 + 3(-2)^2 + (-2) - 3$
 $= -1$
- 2 D** $P(x) = (x - a)^2(x - b)(x - c)$,
 $a > b > c$
 Graph of $y = P(x)$ is an upright quartic with a repeated root at $x = a$, so $P(x) < 0$ only between c and b .
- 3 A** $y = x^3$
 Dilation $\times 2$ from y -axis: $y = \left(\frac{x}{2}\right)^3$
 reflection in the y -axis: $y = \left(-\frac{x}{2}\right)^3$
 translation of 4 units in negative direction of y -axis:
 $y = \left(-\frac{x}{2}\right)^3 - 4 = -\frac{x^3}{8} - 4$
- 4 D** $y = x^3 + 5x - 10$
- 
- $y = 0$ lies between 1 and 2
- 5 A** $P(x) = x^4 + ax^2 - 4$
 $P(x) = 0$ if $x = -a \pm \sqrt{\frac{a^2}{4} + 4}$
 If $P(x) = 0$ when $x = \pm\sqrt{2}$, then
 $a = 0$
- 6 C** $P(x) = x^3 + ax^2 + bx - 9$
 $P(x) = 0$ has zeros at $x = 1$ and $x = -3$.
 $\therefore P(1) = 1 + a + b - 9 = 0$
 $\therefore a + b = 8 \dots (1)$
 $P(-3) = -27 + 9a - 3b - 9 = 0$
 $\therefore 9a - 3b = 36$
 $\therefore 3a - b = 12 \dots (2)$
(1) + (2) gives:
 $4a = 20$
 $\therefore a = 5; b = 3$
- 7 B** $P(x) = ax^3 + 2x^2 + 5$ is divisible by $x + 1$
 $\therefore P(-1) = -a + 2 + 5 = 0$
 $\therefore a = 7$
- 8 B** $P(x) = x^3 + 2x^2 - 5x + d$
 $\frac{P(x)}{x - 2}$ has a remainder of 10
 $\therefore P(2) = 10$
 $P(2) = 8 + 8 - 10 + d = 10$
 $\therefore d = 4$
- 9 D** The diagram shows an inverted cubic with a repeated root at $x = b$ and a single root at $x = a$.
 $\therefore y = -(x - a)(x - b)^2$
- 10 B** The graph of $y = -f(x)$ is a reflection in the x -axis. The graph of $y = 1 - f(x)$ is then a translation up by 1 unit. Only the graph in **B** satisfies these two features.

Solutions to extended-response questions

1 a $V = \pi r^2 h$

$$r + h = 6$$

$$\therefore V = \pi r^2(6 - r)$$

b $0 \leq r \leq 6$

c $V(3) = 27\pi$

d $\pi r^2(6 - r) = 27\pi$

$$6r^2 - r^3 - 27 = 0$$

$$r^3 - 6r^2 + 27 = 0$$

$$(r - 3)(r^2 - 3r - 9) = 0$$

$$\Leftrightarrow r = 3 \text{ or } r = \frac{3 \pm 3\sqrt{5}}{2}$$

In the context of the question

$$r = 3 \text{ or } r = \frac{3 + 3\sqrt{5}}{2}$$

2 a At $t = 900$, all the energy is used up.

The point with coordinates $(900, 0)$ is the vertex of the parabola.

Equation of the parabola is $v = a(t - 900)^2 + 0$

$$= a(t - 900)^2$$

When $t = 0$, $v = 25$

$$\therefore 25 = a(0 - 900)^2$$

$$\therefore a = \frac{25}{810\,000}$$

$$= \frac{1}{32\,400}$$

$$\therefore v = \frac{1}{32\,400}(t - 900)^2$$

b $s = vt$ and $v = \frac{1}{32\,400}(t - 900)^2$

$$\therefore s = \frac{t}{32\,400}(t - 900)^2$$

(Remember, t is the time in which all energy is used up; v is constant for a given t .)

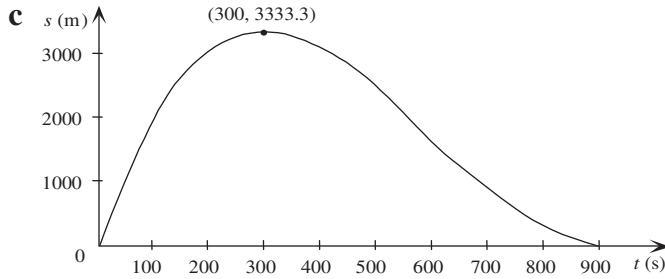

d The maximum distance the t axis can travel is $3\frac{1}{3}$ km, so a proposal to place power sources at 3.5 km intervals is not feasible.

e If the power sources are at 2 km intervals, v_{\max} and v_{\min} are given for values of t at which $s = 2000$. From the graph, when $s = 2000$, $t_1 \approx 105$ and $t_2 \approx 560$.

$$\text{When } t_1 = 105, v_{\max} \approx \frac{2000}{105}$$

$$\approx 19$$

$$\text{When } t_2 = 560, v_{\min} = \frac{2000}{560}$$

$$\approx 3.6$$

Hence, the maximum and minimum speeds recommended for drivers are approximately 19 m/s and 3.6 m/s respectively.

3 a The 'flat spot' is the point of inflexion $\therefore (h, k) = (5, 10)$

$$\text{Hence } R - 10 = a(x - 5)^3$$

b At $(0, 0)$, $0 - 10 = a(0 - 5)^3$

$$\therefore -10 = -125a$$

$$\therefore a = \frac{10}{125} = \frac{2}{25}$$

$$\therefore R - 10 = \frac{2}{25}(x - 5)^3$$

c If $(h, k) = (7, 12)$, then $R - 12 = a(x - 7)^3$

$$\text{At } (0, 0), \quad 0 - 12 = a(0 - 7)^3$$

$$\therefore -12 = -343a \quad \therefore a = \frac{12}{343}$$

$$\therefore R - 12 = \frac{12}{343}(x - 7)^3$$

4 a Area of net = length \times width

$$\begin{aligned}
 &= (l + w + l + w) \times \left(\frac{w}{2} + h + \frac{w}{2} \right) \\
 &= 2(l + w)(w + h) \\
 &= 2(35 + 20)(20 + 23) \\
 &= 2 \times 55 \times 43 \\
 &= 4730
 \end{aligned}$$

The area of the net is 4730 cm².

b Let V = volume of the box $\therefore V = h \times l \times w$ (1)

Now $2(l + w)(w + h) = 4730$ and $h = l$ (2)

$$\therefore 2(l + w)(l + w) = 4730$$

$$\therefore (l + w)^2 = 2365$$

$$\therefore l + w = \sqrt{2365} \text{ (as } l > 0, w > 0 \text{)}$$

$$\therefore w = \sqrt{2365} - l \text{ (3)}$$

Substitute (2) and (3) in (1)

$$V = l \times l \times (\sqrt{2365} - l)$$

$$\therefore V = l^2(\sqrt{2365} - l)$$

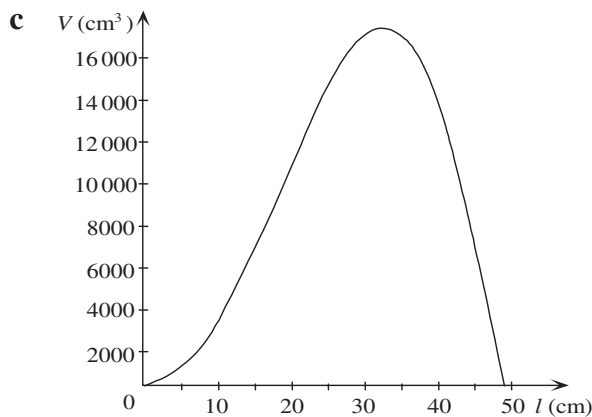

d i On the CAS calculator, sketch $f1 = x^2(\sqrt{2365} - x)$ and $f2 = 14\,000$. Points of intersection are (23.694127, 14 000) and (39.787591, 14 000). Therefore the volume is 14 000 cm³ when $l = 23.69$ or $l = 39.79$.

ii Repeat **d i** using $f2 = 10\,000$. The points of intersection are (18.096981, 10 000) and (43.296841, 10 000). Therefore the volume is 1 litre when $l = 43.3$ or $l = 18.1$, correct to 1 decimal place..

e With $f1 = x^2(\sqrt{2365} - x)$,

TI: Press **Menu** → **6:Analyze Graph** → **3:Maximum**

CP: Tap **Analysis** → **G-Solve** → **Max**

to yield (32.420846, 17038.955). The maximum volume is 17039 cm^3 (to the nearest cm^3) and occurs when $l \approx 32.42$.

5 a TI: Press **Menu** → **1: Actions** → **1: Define** then type $f(x) = a \times x^3 + b \times x^2 + c \times x + d$ followed by ENTER.

Now type the following then press ENTER

solve ($f(0) = 15.8$ and $f(10) = 14.5$ and $f(15) = 15.6$ and $f(20) = 15$, $\{a, b, c, d\}$)

CP: Tap **Action** → **Command** → **Define** then type $f(x) = a \times x^3 + b \times x^2 + c \times x + d$ followed by EXE.

Now type the following then press EXE

solve ($\{f(0) = 15.8, f(10) = 14.5, f(15) = 15.6, f(20) = 15\}, \{a, b, c, d\}$)

The screen gives $a = -0.00287$, $b = 0.095$, $c = -0.793$ and $d = 15.80$.

b i With $f1 = 0.00287x^3 + 0.095x^2 - 0.793x + 15.8$

TI: Press **Menu** → **6:Analyze Graph** → **2:Minimum**

CP: Tap **Analysis** → **G-Solve** → **Min**

to get (5.59, 13.83) as the coordinates of the point closest to the ground.

ii **TI:** In a Calculator page type $f1(0)$ followed by ENTER

CP: Tap **Analysis** → **G-Solve** → **y-Cal** and input 0 for the x -value to get (0, 15.8) as the point furthest from the ground.

- 6 a The length of the box (in cm) = $96 - 4x = 4(24 - x)$.
The width of the box (in cm) = $48 - 2x = 2(24 - x)$.
The height of the box (in cm) = x .
Therefore $V = 4(24 - x) \times 2(24 - x) \times x = 8x(24 - x)^2$

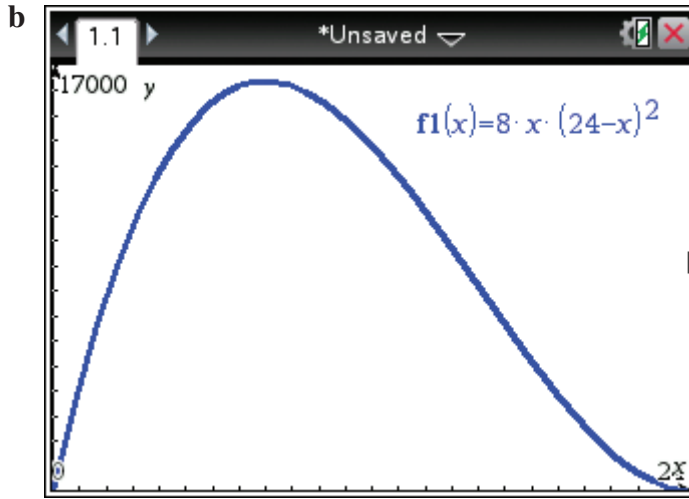

- i The domain of V is $\{x : 0 < x < 24\}$.
- ii With $f1 = 8x \times (24 - x)^2$,
TI: Press **Menu** → **6:Analyze Graph** → **3:Maximum**
CP: Tap **Analysis** → **G-Solve** → **Max** to yield (8.000002, 16 384).
The maximum volume is 16384 cm^3 (to the nearest cm^3) and occurs when $x \approx 8.00$.
- c The volume of the box, when $x = 10$, is $V = 8 \times 10(24 - 10)^2 = 15\,680 \text{ cm}^3$
- d The volume is a maximum when $x = 5$. When $x = 5$, $V = 14\,440$.
- e The volume is a minimum when $x = 15$. When $x = 15$, $V = 9\,720$.

Chapter 7 – Transformations

Solutions to Exercise 7A

1 a $(-3, 4) \rightarrow (-3 + 2, 4 - 3) = (-1, 1)$

b $(-3, 4) \rightarrow (-3 - 2, 4 + 4) = (-5, 8)$

c $(-3, 4) \rightarrow (-3 - 3, 4 - 2) = (-6, 2)$

d $(-3, 4) \rightarrow (-3 - 4, 4 + 5) = (-7, 9)$

e $(-3, 4) \rightarrow (-3 - 2, 4 - 1) = (-5, 3)$

2 a $g(x) = \frac{1}{x-2} - 1$

b $g(x) = \frac{1}{(x-4)^2} + 3$

c $g(x) = (x+2)^2 - 3$

d $g(x) = (x-4)^2 - 2$

e $g(x) = \sqrt{x-2} - 1$

3 $y = f(x) = \frac{1}{x}$

a $y = f(x-1) = \frac{1}{x-1}$
 Asymptotes at $x = 1$ and $y = 0$
 y-intercept: $y = \frac{1}{0-1} = -1$
 No x-intercept because $y = 0$ is an asymptote.

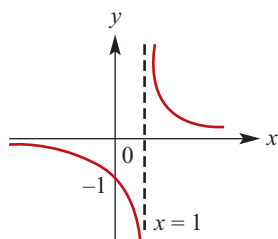

b $y = f(x) + 1 = \frac{1}{x} + 1$
 Asymptotes at $x = 0$ and $y = 1$
 x intercept: $y = \frac{1}{x} + 1 = 0$

$\therefore \frac{1}{x} = -1, \therefore x = -1$

No y intercept because $y = 0$ is an asymptote

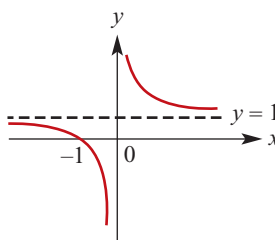

c $y = f(x+3) = \frac{1}{x+3}$
 Asymptotes at $x = -3$ and $y = 0$
 y-intercept: $y = \frac{1}{0+3} = \frac{1}{3}$
 No x-intercept because $y = 0$ is an asymptote.

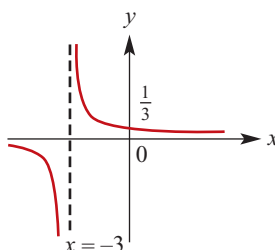

d $y = f(x) - 3 = \frac{1}{x} - 3$
 Asymptotes at $x = 0$ and $y = -3$
 x-intercept: $y = \frac{1}{x} - 3 = 0$
 $\therefore \frac{1}{x} = 3, \therefore x = \frac{1}{3}$
 No y-intercept because $x = 0$ is an asymptote.

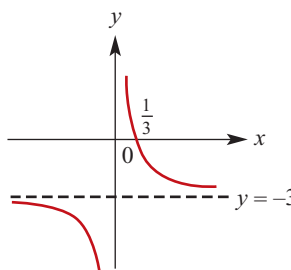

e $y = f(x+1) = \frac{1}{x+1}$

Asymptotes at $x = -1$ and $y = 0$
 y -intercept: $y = \frac{1}{0+1} = 1$
 No x -intercept because $y = 0$ is an asymptote.

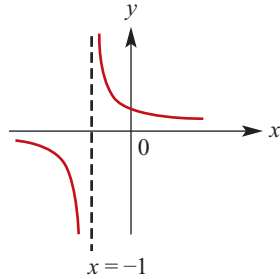

f $y = f(x) - 1 = \frac{1}{x} - 1$
 Asymptotes at $x = 0$ and $y = -1$
 x -intercept: $y = \frac{1}{x} - 1 = 0$
 $\therefore \frac{1}{x} = 1, \therefore x = 1$
 No y -intercept because $x = 0$ is an asymptote.

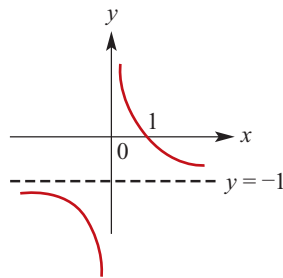

4 $y = f(x) = x^2$

a $y = f(x-1) = (x-1)^2$
 x -intercept: $(x-1)^2 = 0, \therefore x = 1$
 y -intercept: $f(0-1) = 1$
 $y = (x-1)^2 = 0, x = 1$

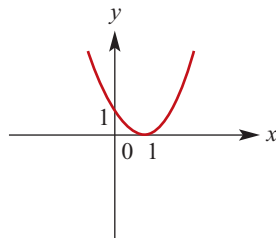

b $y = f(x) + 1 = x^2 + 1$

No x -intercept because $f(x+1) > 0$ for all real x .
 y -intercept: $f(0) + 1 = 1$

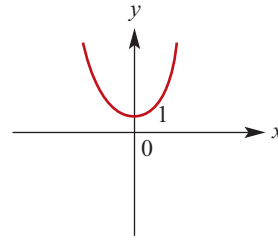

c $y = f(x+3) = (x+3)^2$
 x -intercept: $(x+3)^2 = 0, \therefore x = -3$
 y -intercept: $f(0+3) = 3^2 = 9$

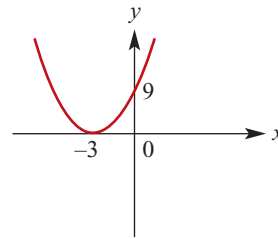

d $y = f(x) - 3 = x^2 - 3$
 x -intercepts:
 $y = f(x) - 3 = 0, \therefore x^2 - 3 = 0$
 $\therefore x^2 = 3, \therefore x = \pm\sqrt{3}$
 y -intercept: $f(0) - 3 = -3$

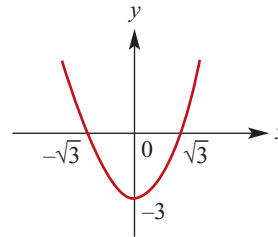

e $y = f(x+1) = (x+1)^2$
 x -intercept: $(x+1)^2 = 0, \therefore x = -1$
 y -intercept: $f(0+1) = 1^2 = 1$

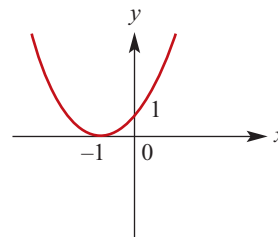

f $y = f(x) - 1 = x^2 - 1$
 x -intercepts:
 $y = f(x) - 3 = 0, \therefore x^2 - 3 = 0$
 $\therefore x^2 = 1, \therefore x = \pm 1$
 y -intercept: $f(0) - 1 = -1$

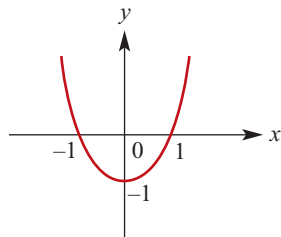

5 $y = f(x) = x^2$

a $y = f(x - 1) + 2 = (x - 1)^2 + 2$
 No x -intercepts because
 $f(x - 1) + 2 > 0$ for all real x .
 y -intercept:
 $f(0 - 1) + 1 = (-1)^2 + 2 = 3$

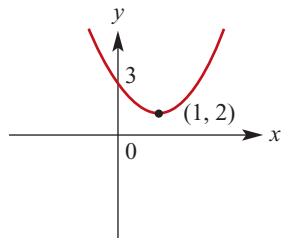

b $y = f(x - 3) + 1 = (x - 3)^2 + 1$
 No x -intercepts because
 $f(x - 3) + 1 > 0$ for all real x .
 y -intercept:
 $f(0 - 3) + 1 = (-3)^2 + 1 = 10$

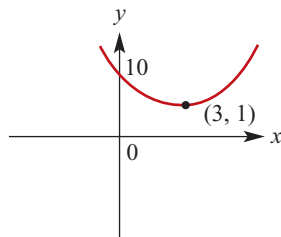

c $y = f(x + 3) - 5 = (x + 3)^2 - 5$
 x -intercepts: $y = f(x + 3) - 5 = 0$

$\therefore (x + 3)^2 - 5 = 0$
 $\therefore (x + 3)^2 = 5$
 $\therefore x + 3 = \pm \sqrt{5}, \therefore x = -3 \pm \sqrt{5}$
 y -intercept: $f(0 + 3) - 5 = 9 - 5 = 4$

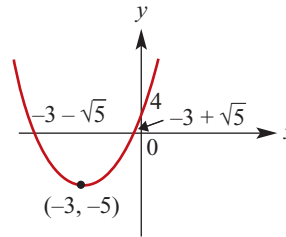

d $y = f(x + 1) - 3 = (x + 1)^2 - 3$
 x -intercepts: $y = f(x + 1) - 3 = 0$
 $\therefore (x + 1)^2 - 3 = 0$
 $\therefore (x + 1)^2 = 3$
 $\therefore x + 1 = \pm \sqrt{3}, \therefore x = -1 \pm \sqrt{3}$
 y -intercept: $f(0 + 1) - 3 = 1 - 3 = -2$

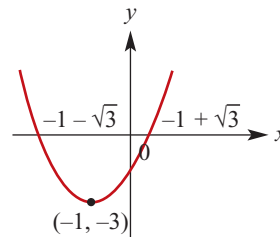

e $y + 2 = f(x + 1), \therefore y = f(x + 1) - 2$
 $y = f(x + 1) - 2 = (x + 1)^2 - 2$
 x -intercepts: $y = f(x + 1) - 2 = 0$
 $\therefore (x + 1)^2 - 2 = 0$
 $\therefore (x + 1)^2 = 2$
 $\therefore x + 1 = \pm \sqrt{2}, x = -1 \pm \sqrt{2}$
 y -intercept: $f(0 + 1) - 2 = 1 - 2 = -1$

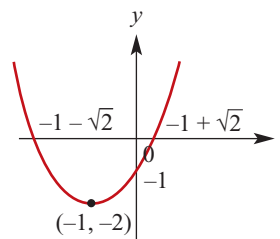

f $y = f(x - 5) - 1 = (x - 5)^2 - 1$
 x -intercepts: $y = f(x - 5) - 1 = 0$

$$\therefore (x - 5)^2 - 1 = 0$$

$$\therefore (x - 5)^2 = 1$$

$$\therefore x - 5 = \pm 1$$

$$\therefore x = 5 \pm 1 = 4; 6$$

y-intercept:

$$f(0 - 5) - 1 = (-5)^2 - 1 = 24$$

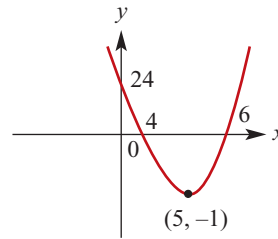

Solutions to Exercise 7B

1 a $(-2, -3) \rightarrow (-2, 3)$

b $(-2, -3) \rightarrow (2, -3)$

c $(-2, -3) \rightarrow (-2, -12)$

d $(-2, -3) \rightarrow (-8, -3)$

2 a $y = x^2$

i A dilation of factor $\frac{1}{2}$ from the y -axis

$$\therefore y = \left(\frac{x}{0.5}\right)^2 = 4x^2$$

ii A dilation of factor 5 from the y -axis

$$\therefore y = \left(\frac{x}{5}\right)^2 = \frac{x^2}{25}$$

iii A dilation of factor $\frac{2}{3}$ from the x -axis

$$\therefore y = \frac{2}{3}(x)^2 = \frac{2x^2}{3}$$

iv A dilation of factor 4 from the x -axis

$$\therefore y = 4(x)^2 = 4x^2$$

v A reflection in the x -axis

$$\therefore y = -(x)^2 = -x^2$$

vi A reflection in the y -axis

$$\therefore y = (-x)^2 = x^2$$

b $y = \frac{1}{x^2}$

i A dilation of factor $\frac{1}{2}$ from the y -axis

$$\therefore y = \left(\frac{0.5}{x}\right)^2 = \frac{1}{4x^2}$$

ii A dilation of factor 5 from the y -axis

$$\therefore y = \left(\frac{5}{x}\right)^2 = \frac{25}{x^2}$$

iii A dilation of factor $\frac{2}{3}$ from the x -axis

$$\therefore y = \frac{2}{3}\left(\frac{1}{x^2}\right) = \frac{2}{3x^2}$$

iv A dilation of factor 4 from the x -axis

$$\therefore y = \frac{4}{x^2}$$

v A reflection in the x -axis

$$\therefore y = -\frac{1}{x^2}$$

vi A reflection in the y -axis

$$\therefore y = \left(-\frac{1}{x}\right)^2 = \frac{1}{x^2}$$

c $y = \frac{1}{x}$

i A dilation of factor $\frac{1}{2}$ from the y -axis

$$\therefore y = \frac{0.5}{x} = \frac{1}{2x}$$

ii A dilation of factor 5 from the y -axis

$$\therefore y = \frac{5}{x}$$

iii A dilation of factor $\frac{2}{3}$ from the x -axis

$$\therefore y = \frac{2}{3}\left(\frac{1}{x}\right) = \frac{2}{3x}$$

iv A dilation of factor 4 from the

x -axis
 $\therefore y = \frac{4}{x}$

v A reflection in the x -axis

$$\therefore y = -\frac{1}{x}$$

vi A reflection in the y -axis

$$\therefore y = \frac{1}{-x} = -\frac{1}{x}$$

d $y = \sqrt{x}$

i A dilation of factor $\frac{1}{2}$ from the y -axis

$$\therefore y = \sqrt{\frac{x}{0.5}} = \sqrt{2x}$$

ii A dilation of factor 5 from the y -axis

$$\therefore y = \sqrt{\frac{x}{5}}$$

iii A dilation of factor $\frac{2}{3}$ from the x -axis

$$\therefore y = \frac{2}{3}\sqrt{x}$$

iv A dilation of factor 4 from the x -axis

$$\therefore y = 4\sqrt{x}$$

v A reflection in the x -axis

$$\therefore y = -\sqrt{x}$$

vi A reflection in the y -axis

$$\therefore y = \sqrt{-x}; x \leq 0$$

3 a $y = 3\sqrt{x}$

Starting point at (0,0)

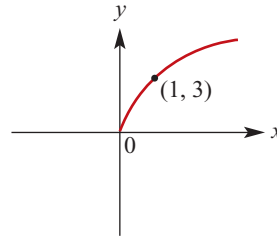

b $y = -\frac{1}{x}$

Asymptotes at $x = 0$ and $y = 0$

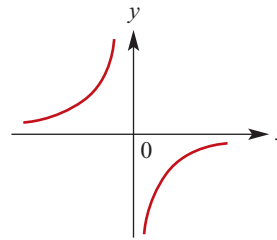

c $y = \frac{3}{x}$

Asymptotes at $x = 0$ and $y = 0$

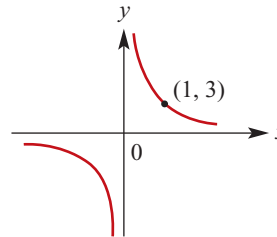

d $y = \frac{1}{2x}$

Asymptotes at $x = 0$ and $y = 0$

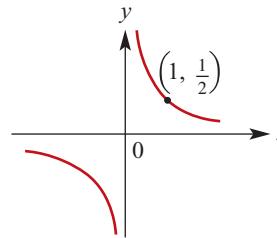

e $y = \sqrt{3x}$

Starting point at (0,0)

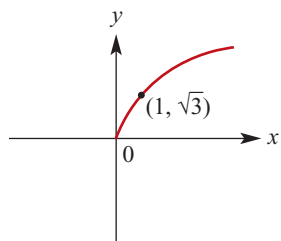

f $y = \frac{3}{2x}$
 Asymptotes at $x = 0$ and $y = 0$

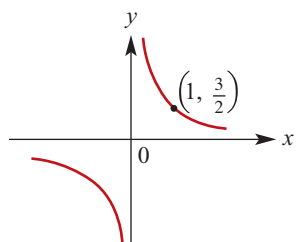

Solutions to Exercise 7C

- 1 a** Translation of 2 units in the positive direction of the x -axis:

$$y = \sqrt{x} \text{ becomes } y = \sqrt{x-2}$$

followed by a dilation of factor 3

$$\text{from the } x\text{-axis: } y = 3\sqrt{x-2}$$

- b** Translation of 3 units in the negative direction of the x -axis:

$$y = \sqrt{x} \text{ becomes } y = \sqrt{x+3}$$

followed by a reflection in the x -axis:

$$y = -\sqrt{x+3}$$

- c** Reflection in the x -axis:

$$y = \sqrt{x} \text{ becomes } y = -\sqrt{x}$$

followed by a dilation of factor 3

$$\text{from the } x\text{-axis: } y = -3\sqrt{x}$$

- d** Reflection in the x -axis: $y = -\sqrt{x}$

followed by a dilation of factor 2

from the y -axis:

$$y = -\sqrt{\frac{x}{2}}$$

- e** Dilation of factor 2 from the x -axis:

$$y = 2\sqrt{x}$$

followed by a translation of 2 units in the positive direction of the x -axis:

$$y = 2\sqrt{x-2}$$

and 3 units in the negative direction

$$\text{of the } y\text{-axis: } y = 2\sqrt{x-2} - 3$$

- f** Dilation of factor 2 from the y -axis:

$$y = \sqrt{\frac{x}{2}}$$

followed by a translation of 2 units in the negative direction of the x -axis:

$$y = \sqrt{\frac{x+2}{2}}$$

and 3 units in the negative direction of the y -axis:

$$y = \sqrt{\frac{x+2}{2}} - 3$$

2 $y = \frac{1}{x}$

- a** Translation of 2 units in the positive direction of the x -axis:

$$y = \frac{1}{x} \text{ becomes } y = \frac{1}{x-2}$$

followed by a dilation of factor 3

$$\text{from the } x\text{-axis: } y = \frac{3}{x-2}$$

- b** Translation of 3 units in the negative direction of the x -axis: $y = \frac{1}{x+3}$

followed by a reflection in the x -axis:

$$y = -\frac{1}{x+3}$$

- c** Reflection in the x -axis: $y = -\frac{1}{x}$

followed by a dilation of factor 3

$$\text{from the } x\text{-axis: } y = -\frac{3}{x}$$

- d** Reflection in the x -axis: $y = -\frac{1}{x}$

followed by a dilation of factor 2

$$\text{from the } y\text{-axis: } y = -\frac{2}{x}$$

- e** Dilation of factor 2 from the x -axis:

$$y = \frac{2}{x}$$

followed by a translation of 2 units in the positive direction of the x -axis:

$$y = \frac{2}{x-2}$$

and 3 units in the negative direction

$$\text{of the } y\text{-axis: } y = \frac{2}{x-2} - 3$$

f Dilation of factor 2 from the y -axis:

$$y = \frac{2}{x}$$

followed by a translation of 2 units in the negative direction of the x -axis:

$$y = \frac{2}{x+2}$$

and 3 units in the negative direction

of the y -axis: $y = \frac{2}{x+2} - 3$

3 a $(x, y) \rightarrow (x+2, 3y)$

Let $(x, y) \rightarrow (x', y')$.

Then $x' = x+2$ and $y' = 3y$.

Hence $x = x' - 2$ and $y = \frac{y'}{3}$.

The curve $y = x^{\frac{1}{3}}$ maps to the curve

$$\frac{y'}{3} = (x' - 2)^{\frac{1}{3}}$$

That is, $y = 3(x - 2)^{\frac{1}{3}}$

b $(x, y) \rightarrow (x-3, -y)$

Let $(x, y) \rightarrow (x', y')$.

Then $x' = x-3$ and $y' = -y$.

Hence $x = x' + 3$ and $y = -y'$.

The curve $y = x^{\frac{1}{3}}$ maps to the curve

$$-y' = (x' + 3)^{\frac{1}{3}}$$

That is, $y = -(x+3)^{\frac{1}{3}}$

c $(x, y) \rightarrow (-x, 3y)$

Let $(x, y) \rightarrow (x', y')$.

Then $x' = -x$ and $y' = 3y$.

Hence $x = -x'$ and $y = \frac{y'}{3}$.

The curve $y = x^{\frac{1}{3}}$ maps to the curve

$$\frac{y'}{3} = (-x')^{\frac{1}{3}}$$

That is, $y = -3x^{\frac{1}{3}}$

d $(x, y) \rightarrow (2x, -y)$

Let $(x, y) \rightarrow (x', y')$.

Then $x' = 2x$ and $y' = -y$.

Hence $x = \frac{x'}{2}$ and $y = -y'$.

The curve $y = x^{\frac{1}{3}}$ maps to the curve

$$-y = \left(\frac{x'}{2}\right)^{\frac{1}{3}}$$

That is, $y = -\left(\frac{x}{2}\right)^{\frac{1}{3}}$

e $(x, y) \rightarrow (x+2, 2y-3)$

Let $(x, y) \rightarrow (x', y')$.

Then $x' = x+2$ and $y' = 2y-3$.

Hence $x = x' - 2$ and $y = \frac{y'+3}{2}$.

The curve $y = x^{\frac{1}{3}}$ maps to the curve

$$\frac{y'+3}{2} = (x'-2)^{\frac{1}{3}}$$

That is, $y = 2(x-2)^{\frac{1}{3}} - 3$

f $(x, y) \rightarrow (2x-2, y-3)$

Let $(x, y) \rightarrow (x', y')$.

Then $x' = 2x-2$ and $y' = y-3$.

Hence $x = \frac{x'+2}{2}$ and $y = y'+3$.

The curve $y = x^{\frac{1}{3}}$ maps to the curve

$$y'+3 = \left(\frac{x'+2}{2}\right)^{\frac{1}{3}}$$

That is, $y = \left(\frac{x+2}{2}\right)^{\frac{1}{3}} - 3$

Solutions to Exercise 7D

1 a i Write $y' = 2(x' - 1)^2 + 3$

$$\therefore \frac{y' - 3}{2} = (x' - 1)^2$$

Choose $x = x' - 1$ and $y = \frac{y' - 3}{2}$

$$\therefore x' = x + 1 \text{ and } y' = 2y + 3$$

In summary,

A dilation of factor 2 from the x -axis, then a translation of 1 unit in the positive direction of the x -axis and 3 units in the positive direction of the y -axis

ii Write $y' = -(x' + 1)^2 + 2$

$$\therefore -y' + 2 = (x' + 1)^2$$

Choose $x = x' + 1$ and $y = -y' + 2$

$$\therefore x' = x - 1 \text{ and } y' = -y + 2$$

In summary,

A reflection in the x -axis, then a translation of 1 unit in the negative direction of the x -axis and 2 units in the positive direction of the y -axis

iii Write $y' = (2x' + 1)^2 - 2$

$$\therefore y' + 2 = (2x' + 1)^2$$

Choose $x = 2x' + 1$ and $y = y' + 2$

$$\therefore x' = \frac{x - 1}{2} = \frac{x}{2} - \frac{1}{2} \text{ and}$$

$$y' = y - 2$$

In summary,

A dilation of factor $\frac{1}{2}$ from the y -axis, then a translation of $\frac{1}{2}$ unit in the negative direction of the x -axis and 2 units in the negative direction of the y -axis

b i Write $y' = \frac{2}{x' + 3}$

$$\therefore \frac{y'}{2} = \frac{1}{x' + 3}$$

Choose $x = x' + 3$ and $y = \frac{y'}{2}$

$$\therefore x' = x - 3 \text{ and } y' = 2y$$

In summary,

A dilation of factor 2 from the x -axis, then a translation of 3 units in the negative direction of the x -axis

ii Write $y' = \frac{1}{x' + 3} + 2$

$$\therefore \frac{y' - 2}{1} = \frac{1}{x' + 3}$$

Choose $x = x' + 3$ and $y = y' - 2$

$$\therefore x' = x - 3 \text{ and } y' = y + 2$$

In summary,

A translation of 3 units in the negative direction of the x -axis and 2 units in the positive direction of the y -axis

iii Write $y' = \frac{1}{x' - 3} - 2$

$$\therefore y' + 2 = \frac{1}{x' - 3}$$

Choose $x = x' - 3$ and $y = y' + 2$

$$\therefore x' = x + 3 \text{ and } y' = y - 2$$

In summary,

A translation of 3 units in the positive direction of the x -axis and 2 units in the negative direction of the y -axis

c i Write $y' = \sqrt{x' + 3} + 2$

$$\therefore y' - 2 = \sqrt{x' + 3}$$

Choose $x = x' + 3$ and $y = y' - 2$

$$\therefore x' = x - 3 \text{ and } y' = y + 2$$

In summary,

A translation of 3 units in the negative direction of the x -axis and 2 units in the negative direction of the y -axis

d Write $y' = 2\sqrt{3x'}$

$$\therefore \frac{y'}{2} = \sqrt{3x'}$$

Choose $x = 3x'$ and $y = \frac{y'}{2}$

$$\therefore x' = \frac{1}{3}x \text{ and } y' = 2y$$

In summary,

A dilation of factor $\frac{1}{3}$ from the y -axis,
then a dilation of factor 2 from the
 x -axis

e Write $y' = -\sqrt{x'} + 2$

$$\therefore -y' + 2 = \sqrt{x'}$$

Choose $x = x'$ and $y = -y' + 2$

$$\therefore x' = x \text{ and } y' = -y + 2y$$

In summary,

A reflection in the x -axis, then a
translation of 2 units in the positive
direction of the y -axis

2 a Write $y' = \frac{1}{x'^2}$ and $\frac{y+7}{5} = \frac{1}{(x-3)^2}$

Choose $y' = \frac{y+7}{5}$ and $x' = x-3$

$$\therefore (x, y) \rightarrow \left(x-3, \frac{y+7}{5}\right)$$

b Write $y' = (x')^2$ and $y-5 = (3x+2)^2$

Choose $y' = y-5$ and $x' = 3x+2$

$$\therefore (x, y) \rightarrow (3x+2, y-5)$$

c Write $y' = (x')^2$ and

$$-y+7 = 3(3x+1)^2$$

Choose $y' = \frac{-y+7}{3}$ and $x' = 3x+1$

$$\therefore (x, y) \rightarrow \left(3x+1, -\frac{y-7}{3}\right)$$

d Write $y' = \sqrt{x'}$ and $\frac{y}{2} = \sqrt{-(x-4)}$

Choose $y' = \frac{y}{2}$ and $x' = \sqrt{-(x-4)}$

$$\therefore (x, y) \rightarrow \left(-(x-4), \frac{y}{2}\right)$$

e Write $y' = -\sqrt{x'} + 6$ and

$$\frac{y-3}{2} = \sqrt{-(x-4)}$$

Choose $-y' + 6 = \frac{y-3}{2}$ and

$$x' = \sqrt{-(x-4)}$$

$$\therefore (x, y) \rightarrow \left(-(x-4), \frac{15-y}{2}\right)$$

Solutions to Exercise 7E

$$1 \quad \mathbf{X} + \mathbf{Y} = \begin{bmatrix} 1 \\ -2 \end{bmatrix} + \begin{bmatrix} 3 \\ 0 \end{bmatrix} = \begin{bmatrix} 4 \\ -2 \end{bmatrix}$$

$$2\mathbf{X} = \begin{bmatrix} 2 \\ -4 \end{bmatrix}$$

$$4\mathbf{Y} + \mathbf{X} = \begin{bmatrix} 12 \\ 0 \end{bmatrix} + \begin{bmatrix} 1 \\ -2 \end{bmatrix} = \begin{bmatrix} 13 \\ -2 \end{bmatrix}$$

$$\mathbf{X} - \mathbf{Y} = \begin{bmatrix} 1 \\ -2 \end{bmatrix} - \begin{bmatrix} 3 \\ 0 \end{bmatrix} = \begin{bmatrix} -2 \\ -2 \end{bmatrix}$$

$$-3\mathbf{A} = -3 \begin{bmatrix} 1 & -1 \\ 2 & 3 \end{bmatrix} = \begin{bmatrix} -3 & 3 \\ -6 & -9 \end{bmatrix}$$

$$\begin{aligned} -3\mathbf{A} + \mathbf{B} &= \begin{bmatrix} -3 & 3 \\ -6 & -9 \end{bmatrix} + \begin{bmatrix} 4 & 0 \\ -1 & 2 \end{bmatrix} \\ &= \begin{bmatrix} 1 & 3 \\ -7 & -7 \end{bmatrix} \end{aligned}$$

$$2 \quad 2\mathbf{A} = 2 \begin{bmatrix} 1 & -1 \\ 0 & 2 \end{bmatrix} = \begin{bmatrix} 2 & -2 \\ 0 & 4 \end{bmatrix}$$

$$-3\mathbf{A} = -3 \begin{bmatrix} 1 & -1 \\ 0 & 2 \end{bmatrix} = \begin{bmatrix} -3 & 3 \\ 0 & -6 \end{bmatrix}$$

$$-6\mathbf{A} = -6 \begin{bmatrix} 1 & -1 \\ 0 & 2 \end{bmatrix} = \begin{bmatrix} -6 & 6 \\ 0 & -12 \end{bmatrix}$$

$$3 \quad \mathbf{a} \quad 2\mathbf{A} = 2 \begin{bmatrix} 3 & 2 \\ -2 & -2 \end{bmatrix} = \begin{bmatrix} 6 & 4 \\ -4 & -4 \end{bmatrix}$$

$$\mathbf{b} \quad 3\mathbf{B} = 3 \begin{bmatrix} 0 & -3 \\ 4 & 1 \end{bmatrix} = \begin{bmatrix} 0 & -9 \\ 12 & 3 \end{bmatrix}$$

$$\mathbf{c} \quad 2\mathbf{A} + 3\mathbf{B} = \begin{bmatrix} 6 & -5 \\ 8 & -1 \end{bmatrix}$$

$$\begin{aligned} \mathbf{d} \quad 3\mathbf{B} - 2\mathbf{A} &= \begin{bmatrix} 0 & -9 \\ 12 & 3 \end{bmatrix} - \begin{bmatrix} 6 & 4 \\ -4 & -4 \end{bmatrix} \\ &= \begin{bmatrix} -6 & -13 \\ 16 & 7 \end{bmatrix} \end{aligned}$$

$$4 \quad \mathbf{a} \quad \mathbf{P} + \mathbf{Q} = \begin{bmatrix} 1 & 0 \\ 0 & 3 \end{bmatrix} + \begin{bmatrix} -1 & 1 \\ 2 & 0 \end{bmatrix} = \begin{bmatrix} 0 & 1 \\ 2 & 3 \end{bmatrix}$$

$$\mathbf{b} \quad \mathbf{P} + 3\mathbf{Q} = \begin{bmatrix} 1 & 0 \\ 0 & 3 \end{bmatrix} + \begin{bmatrix} -3 & 3 \\ 6 & 0 \end{bmatrix} = \begin{bmatrix} -2 & 3 \\ 6 & 3 \end{bmatrix}$$

$$\begin{aligned} \mathbf{c} \quad 2\mathbf{P} - \mathbf{Q} + \mathbf{R} &= \begin{bmatrix} 2 & 0 \\ 0 & 6 \end{bmatrix} - \begin{bmatrix} -1 & 1 \\ 2 & 0 \end{bmatrix} \\ &\quad + \begin{bmatrix} 0 & 4 \\ 1 & 1 \end{bmatrix} \\ &= \begin{bmatrix} 3 & 3 \\ -1 & 7 \end{bmatrix} \end{aligned}$$

$$5 \quad 2\mathbf{A} - 3\mathbf{X} = \mathbf{B}$$

$$\therefore 2\mathbf{A} - \mathbf{B} = 3\mathbf{X}$$

$$\therefore \mathbf{X} = \frac{1}{3}(2\mathbf{A} - \mathbf{B})$$

$$= \frac{1}{3} \left(2 \begin{bmatrix} 3 & 1 \\ -1 & 4 \end{bmatrix} - \begin{bmatrix} 0 & -10 \\ -2 & 17 \end{bmatrix} \right)$$

$$= \frac{1}{3} \begin{bmatrix} 6 & 12 \\ 0 & -9 \end{bmatrix}$$

$$= \begin{bmatrix} 2 & 4 \\ 0 & -3 \end{bmatrix}$$

$$3\mathbf{A} + 2\mathbf{Y} = 2\mathbf{B}$$

$$\therefore 2\mathbf{Y} = 2\mathbf{B} - 3\mathbf{A}$$

$$\therefore \mathbf{Y} = \frac{1}{2}(2\mathbf{B} - 3\mathbf{A})$$

$$= \frac{1}{2} \left(2 \begin{bmatrix} 0 & -10 \\ -2 & 17 \end{bmatrix} - 3 \begin{bmatrix} 3 & 1 \\ -1 & 4 \end{bmatrix} \right)$$

$$= \frac{1}{2} \begin{bmatrix} -9 & -23 \\ -1 & 22 \end{bmatrix}$$

$$= \begin{bmatrix} -\frac{9}{2} & -\frac{23}{2} \\ -\frac{1}{2} & 11 \end{bmatrix}$$

$$\begin{aligned}
\mathbf{6} \quad \mathbf{AX} &= \begin{bmatrix} 1 & -2 \\ -1 & 3 \end{bmatrix} \begin{bmatrix} 2 \\ -1 \end{bmatrix} = \begin{bmatrix} 4 \\ -5 \end{bmatrix} \\
\mathbf{BX} &= \begin{bmatrix} 3 & 0 \\ 0 & 1 \end{bmatrix} \begin{bmatrix} 2 \\ -1 \end{bmatrix} = \begin{bmatrix} 6 \\ -1 \end{bmatrix} \\
\mathbf{IX} &= \begin{bmatrix} 1 & 0 \\ 0 & 1 \end{bmatrix} \begin{bmatrix} 2 \\ -1 \end{bmatrix} = \begin{bmatrix} 2 \\ -1 \end{bmatrix} \\
\mathbf{AI} &= \begin{bmatrix} 1 & -2 \\ -1 & 3 \end{bmatrix} \begin{bmatrix} 1 & 0 \\ 0 & 1 \end{bmatrix} = \begin{bmatrix} 1 & -2 \\ -1 & 3 \end{bmatrix} \\
\mathbf{IB} &= \begin{bmatrix} 1 & 0 \\ 0 & 1 \end{bmatrix} \begin{bmatrix} 3 & 2 \\ 1 & 1 \end{bmatrix} = \begin{bmatrix} 3 & 2 \\ 1 & 1 \end{bmatrix} \\
\mathbf{AB} &= \begin{bmatrix} 1 & -2 \\ -1 & 3 \end{bmatrix} \begin{bmatrix} 3 & 0 \\ 0 & 1 \end{bmatrix} = \begin{bmatrix} 3 & -2 \\ -3 & 3 \end{bmatrix} \\
\mathbf{BA} &= \begin{bmatrix} 3 & 0 \\ 0 & 1 \end{bmatrix} \begin{bmatrix} 1 & -2 \\ -1 & 3 \end{bmatrix} = \begin{bmatrix} 3 & -6 \\ -1 & 3 \end{bmatrix} \\
\mathbf{A}^2 &= \begin{bmatrix} 1 & -2 \\ -1 & 3 \end{bmatrix} \begin{bmatrix} 1 & -2 \\ -1 & 3 \end{bmatrix} = \begin{bmatrix} 3 & -8 \\ -4 & 11 \end{bmatrix} \\
\mathbf{B}^2 &= \begin{bmatrix} 3 & 0 \\ 0 & 1 \end{bmatrix} \begin{bmatrix} 3 & 0 \\ 0 & 1 \end{bmatrix} = \begin{bmatrix} 9 & 0 \\ 0 & 1 \end{bmatrix}
\end{aligned}$$

$$\begin{aligned}
\mathbf{7} \quad \mathbf{AX} &= \begin{bmatrix} 2 & -1 \\ -1 & 4 \end{bmatrix} \begin{bmatrix} 1 \\ -2 \end{bmatrix} = \begin{bmatrix} 4 \\ -9 \end{bmatrix} \\
\mathbf{BX} &= \begin{bmatrix} -3 & 0 \\ 0 & 2 \end{bmatrix} \begin{bmatrix} 1 \\ -2 \end{bmatrix} = \begin{bmatrix} -3 \\ -4 \end{bmatrix} \\
\mathbf{CX} &= \begin{bmatrix} 1 & 3 \\ -2 & 1 \end{bmatrix} \begin{bmatrix} 1 \\ -2 \end{bmatrix} = \begin{bmatrix} -5 \\ -4 \end{bmatrix} \\
\mathbf{AC} &= \begin{bmatrix} 2 & -1 \\ -1 & 4 \end{bmatrix} \begin{bmatrix} 1 & 3 \\ -2 & 1 \end{bmatrix} = \begin{bmatrix} 4 & 5 \\ -9 & 1 \end{bmatrix} \\
\mathbf{CB} &= \begin{bmatrix} 1 & 3 \\ -2 & 1 \end{bmatrix} \begin{bmatrix} -3 & 0 \\ 0 & 2 \end{bmatrix} = \begin{bmatrix} -3 & 6 \\ 6 & 2 \end{bmatrix} \\
\mathbf{AB} &= \begin{bmatrix} 2 & -1 \\ -1 & 4 \end{bmatrix} \begin{bmatrix} -3 & 0 \\ 0 & 2 \end{bmatrix} = \begin{bmatrix} -6 & -2 \\ 3 & 8 \end{bmatrix} \\
\mathbf{BA} &= \begin{bmatrix} -3 & 0 \\ 0 & 2 \end{bmatrix} \begin{bmatrix} 2 & -1 \\ -1 & 4 \end{bmatrix} = \begin{bmatrix} -6 & 3 \\ -2 & 8 \end{bmatrix} \\
\mathbf{A}^2 &= \begin{bmatrix} 2 & -1 \\ -1 & 4 \end{bmatrix} \begin{bmatrix} 2 & -1 \\ -1 & 4 \end{bmatrix} = \begin{bmatrix} 5 & -6 \\ -6 & 17 \end{bmatrix} \\
\mathbf{B}^2 &= \begin{bmatrix} -3 & 0 \\ 0 & 2 \end{bmatrix} \begin{bmatrix} -3 & 0 \\ 0 & 2 \end{bmatrix} = \begin{bmatrix} 9 & 0 \\ 0 & 4 \end{bmatrix}
\end{aligned}$$

Solutions to Exercise 7F

1 a $\det \mathbf{A} = 2(2) - 3(1) = 1$

b $\mathbf{A}^{-1} = \begin{bmatrix} 2 & -1 \\ -3 & 2 \end{bmatrix}$

c $\det \mathbf{B} = (-2)2 - (-2)3 = 2$

d $\mathbf{B}^{-1} = \frac{1}{2} \begin{bmatrix} 2 & 2 \\ -3 & -2 \end{bmatrix} = \begin{bmatrix} 1 & 1 \\ -\frac{3}{2} & -1 \end{bmatrix}$

2 a $\det \begin{bmatrix} 3 & -1 \\ 4 & -1 \end{bmatrix} = 1$; $\text{Inv} = \begin{bmatrix} -1 & 1 \\ -4 & 3 \end{bmatrix}$

b $\det \begin{bmatrix} 3 & 1 \\ -2 & 4 \end{bmatrix} = 14$; $\text{Inv} = \begin{bmatrix} \frac{2}{7} & -\frac{1}{14} \\ \frac{1}{7} & \frac{3}{14} \end{bmatrix}$

c $\det \begin{bmatrix} 1 & 0 \\ 0 & k \end{bmatrix} = k$; $\text{Inv} = \begin{bmatrix} 1 & 0 \\ 0 & \frac{1}{k} \end{bmatrix}$

3 a $\mathbf{A} = \begin{bmatrix} 2 & 1 \\ 0 & -1 \end{bmatrix}$

$$\det \begin{bmatrix} 2 & 1 \\ 0 & -1 \end{bmatrix} = -2$$

$$\mathbf{A}^{-1} = -\frac{1}{2} \begin{bmatrix} -1 & -1 \\ 0 & 2 \end{bmatrix} = \begin{bmatrix} \frac{1}{2} & \frac{1}{2} \\ 0 & 1 \end{bmatrix}$$

$$\mathbf{B} = \begin{bmatrix} 1 & 0 \\ 3 & 1 \end{bmatrix}$$

$$\det \begin{bmatrix} 1 & 0 \\ 3 & 1 \end{bmatrix} = 1$$

$$\mathbf{B}^{-1} = \begin{bmatrix} 1 & 0 \\ -3 & 1 \end{bmatrix}$$

b $\mathbf{AB} = \begin{bmatrix} 2 & 1 \\ 0 & -1 \end{bmatrix} \begin{bmatrix} 1 & 0 \\ 3 & 1 \end{bmatrix} = \begin{bmatrix} 5 & 1 \\ -3 & -1 \end{bmatrix}$

$$\det \begin{bmatrix} 5 & 1 \\ -3 & -1 \end{bmatrix} = -2$$

Therefore

$$(\mathbf{AB})^{-1} = -\frac{1}{2} \begin{bmatrix} -1 & -1 \\ 3 & 5 \end{bmatrix} = \begin{bmatrix} \frac{1}{2} & \frac{1}{2} \\ -\frac{3}{2} & -\frac{5}{2} \end{bmatrix}$$

c $\mathbf{B}^{-1}\mathbf{A}^{-1} = \begin{bmatrix} 1 & 0 \\ -3 & 1 \end{bmatrix} \begin{bmatrix} \frac{1}{2} & \frac{1}{2} \\ 0 & 1 \end{bmatrix}$

$$= \begin{bmatrix} \frac{1}{2} & \frac{1}{2} \\ -\frac{3}{2} & -\frac{5}{2} \end{bmatrix}$$

$$= (\mathbf{AB})^{-1}$$

4 a $\mathbf{A} = \begin{bmatrix} 4 & 3 \\ 2 & 1 \end{bmatrix}$ so $\det \mathbf{A} = 4(1)$
 $-3(2) = -2$

$$\mathbf{A}^{-1} = -\frac{1}{2} \begin{bmatrix} 1 & -3 \\ -2 & 4 \end{bmatrix} = \begin{bmatrix} -\frac{1}{2} & \frac{3}{2} \\ 1 & -2 \end{bmatrix}$$

b $\mathbf{AX} = \begin{bmatrix} 4 & 3 \\ 2 & 1 \end{bmatrix} \begin{bmatrix} w & x \\ y & z \end{bmatrix} = \begin{bmatrix} 3 & 4 \\ 1 & 6 \end{bmatrix}$

$$\mathbf{AX} = \begin{bmatrix} 3 & 4 \\ 1 & 6 \end{bmatrix}$$

$$\mathbf{A}^{-1}\mathbf{AX} = \mathbf{A}^{-1} \begin{bmatrix} 3 & 4 \\ 1 & 6 \end{bmatrix}$$

$$\mathbf{IX} = \begin{bmatrix} -\frac{1}{2} & \frac{3}{2} \\ 1 & 2 \end{bmatrix} \begin{bmatrix} 3 & 4 \\ 1 & 6 \end{bmatrix}$$

$$\mathbf{X} = \begin{bmatrix} 0 & 7 \\ 1 & -8 \end{bmatrix}$$

c $\mathbf{YA} = \begin{bmatrix} a & b \\ c & d \end{bmatrix} \begin{bmatrix} 4 & 3 \\ 2 & 1 \end{bmatrix} = \begin{bmatrix} 3 & 4 \\ 1 & 6 \end{bmatrix}$

$$\mathbf{YAA}^{-1} = \begin{bmatrix} 3 & 4 \\ 1 & 6 \end{bmatrix} \mathbf{A}^{-1}$$

$$\mathbf{YI} = \begin{bmatrix} 3 & 4 \\ 1 & 6 \end{bmatrix} \begin{bmatrix} -\frac{1}{2} & \frac{3}{2} \\ 1 & -2 \end{bmatrix}$$

$$\mathbf{Y} = \begin{bmatrix} \frac{5}{2} & \frac{7}{2} \\ \frac{11}{2} & -\frac{21}{2} \end{bmatrix}$$

$$5 \text{ a } \mathbf{AX} + \mathbf{B} = \mathbf{C}$$

$$\mathbf{AX} = \mathbf{C} - \mathbf{B}$$

$$\mathbf{A}^{-1}\mathbf{AX} = \mathbf{A}^{-1}(\mathbf{C} - \mathbf{B})$$

$$\mathbf{IX} = \mathbf{A}^{-1}(\mathbf{C} - \mathbf{B})$$

$$\mathbf{A}^{-1} = \frac{1}{16} \begin{bmatrix} 6 & -2 \\ -1 & 3 \end{bmatrix}$$

$$\mathbf{C} - \mathbf{B} = \begin{bmatrix} -1 & 5 \\ 0 & 4 \end{bmatrix}$$

$$\mathbf{X} = \frac{1}{16} \begin{bmatrix} 6 & -2 \\ -1 & 3 \end{bmatrix} \begin{bmatrix} -1 & 5 \\ 0 & 4 \end{bmatrix}$$

$$= \frac{1}{16} \begin{bmatrix} -6 & 22 \\ 1 & 7 \end{bmatrix}$$

$$= \begin{bmatrix} \frac{3}{8} & \frac{11}{8} \\ \frac{1}{16} & \frac{7}{16} \end{bmatrix}$$

$$5 \text{ b } \mathbf{YA} + \mathbf{B} = \mathbf{C}$$

$$\mathbf{YA} = \mathbf{C} - \mathbf{B}$$

$$\mathbf{YAA}^{-1} = (\mathbf{C} - \mathbf{B})\mathbf{A}^{-1}$$

$$\mathbf{YI} = (\mathbf{C} - \mathbf{B})\mathbf{A}^{-1}$$

$$\mathbf{A}^{-1} = \frac{1}{16} \begin{bmatrix} 6 & -2 \\ -1 & 3 \end{bmatrix}$$

$$\mathbf{C} - \mathbf{B} = \begin{bmatrix} -1 & 5 \\ 0 & 4 \end{bmatrix}$$

$$\mathbf{Y} = \frac{1}{16} \begin{bmatrix} -1 & 5 \\ 0 & 4 \end{bmatrix} \begin{bmatrix} 6 & -2 \\ -1 & 3 \end{bmatrix} =$$

$$\begin{bmatrix} -\frac{11}{16} & \frac{17}{16} \\ -\frac{1}{4} & \frac{3}{4} \end{bmatrix}$$

Solutions to Exercise 7G

$$1 \text{ a } \begin{bmatrix} 2 & -3 \\ 5 & 4 \end{bmatrix} \begin{bmatrix} -1 \\ 2 \end{bmatrix} = \begin{bmatrix} -8 \\ 3 \end{bmatrix}$$

$$1 \text{ b } \begin{bmatrix} -3 & -1 \\ -1 & 3 \end{bmatrix} \begin{bmatrix} a \\ b \end{bmatrix} = \begin{bmatrix} -3a - b \\ 3b - a \end{bmatrix}$$

$$2 \begin{bmatrix} 2 & -1 \\ -4 & 3 \end{bmatrix} \begin{bmatrix} 1 \\ 0 \end{bmatrix} = \begin{bmatrix} 2 \\ -4 \end{bmatrix}$$

$$\begin{bmatrix} 2 & -1 \\ -4 & 3 \end{bmatrix} \begin{bmatrix} 0 \\ 1 \end{bmatrix} = \begin{bmatrix} -1 \\ 3 \end{bmatrix}$$

$$\begin{bmatrix} 2 & -1 \\ -4 & 3 \end{bmatrix} \begin{bmatrix} 3 \\ 2 \end{bmatrix} = \begin{bmatrix} 4 \\ -6 \end{bmatrix}$$

$$3 \text{ a } \begin{bmatrix} 2 & -1 \\ 1 & 1 \end{bmatrix} \begin{bmatrix} 1 \\ 0 \end{bmatrix} = \begin{bmatrix} 2 \\ 1 \end{bmatrix}$$

$$\begin{bmatrix} 2 & -1 \\ 1 & 1 \end{bmatrix} \begin{bmatrix} -1 \\ 2 \end{bmatrix} = \begin{bmatrix} -4 \\ 1 \end{bmatrix}$$

$$3 \text{ b } \begin{bmatrix} -2 & 0 \\ 0 & 1 \end{bmatrix} \begin{bmatrix} 1 \\ 0 \end{bmatrix} = \begin{bmatrix} -2 \\ 0 \end{bmatrix}$$

$$\begin{bmatrix} -2 & 0 \\ 0 & 1 \end{bmatrix} \begin{bmatrix} -1 \\ 2 \end{bmatrix} = \begin{bmatrix} 2 \\ 2 \end{bmatrix}$$

$$3 \text{ c } \begin{bmatrix} 2 & 3 \\ 3 & -1 \end{bmatrix} \begin{bmatrix} 1 \\ 0 \end{bmatrix} = \begin{bmatrix} 2 \\ 3 \end{bmatrix}$$

$$\begin{bmatrix} 2 & 3 \\ 3 & -1 \end{bmatrix} \begin{bmatrix} -1 \\ 2 \end{bmatrix} = \begin{bmatrix} 4 \\ -5 \end{bmatrix}$$

4 a Dilation of factor 3 from the x -axis

$$\begin{bmatrix} 1 & 0 \\ 0 & 3 \end{bmatrix} \begin{bmatrix} 6 \\ 7 \end{bmatrix} = \begin{bmatrix} 6 \\ 21 \end{bmatrix}$$

b Dilation of factor 2 from the y -axis

$$\begin{bmatrix} 2 & 0 \\ 0 & 1 \end{bmatrix} \begin{bmatrix} 6 \\ 7 \end{bmatrix} = \begin{bmatrix} 12 \\ 7 \end{bmatrix}$$

c Reflection in the x -axis

$$\begin{bmatrix} 1 & 0 \\ 0 & -1 \end{bmatrix} \begin{bmatrix} 6 \\ 7 \end{bmatrix} = \begin{bmatrix} 6 \\ -7 \end{bmatrix}$$

d Reflection in the y -axis

$$\begin{bmatrix} -1 & 0 \\ 0 & 1 \end{bmatrix} \begin{bmatrix} 6 \\ 7 \end{bmatrix} = \begin{bmatrix} -6 \\ 7 \end{bmatrix}$$

e Reflection in the line $y = x$

$$\begin{bmatrix} 0 & 1 \\ 1 & 0 \end{bmatrix} \begin{bmatrix} 6 \\ 7 \end{bmatrix} = \begin{bmatrix} 7 \\ 6 \end{bmatrix}$$

$$5 \text{ a } \begin{bmatrix} a & b \\ c & d \end{bmatrix} \begin{bmatrix} 1 \\ -2 \end{bmatrix} = \begin{bmatrix} -4 \\ 5 \end{bmatrix}$$

$$\begin{bmatrix} a & b \\ c & d \end{bmatrix} \begin{bmatrix} 3 \\ 4 \end{bmatrix} = \begin{bmatrix} 18 \\ 5 \end{bmatrix}$$

$$\therefore a - 2b = -4; \quad c - 2d = 5$$

$$3a + 4b = 18; \quad 3c + 4d = 5$$

$$\frac{5a}{5a} = 10; \quad \frac{5c}{5c} = 15$$

$$\begin{bmatrix} a & b \\ c & d \end{bmatrix} = \begin{bmatrix} 2 & 3 \\ 3 & -1 \end{bmatrix}$$

$$5 \text{ c } \begin{bmatrix} a & b \\ c & d \end{bmatrix} \begin{bmatrix} 1 \\ 0 \end{bmatrix} = \begin{bmatrix} 1 \\ 1 \end{bmatrix}$$

$$\begin{bmatrix} a & b \\ c & d \end{bmatrix} \begin{bmatrix} 0 \\ 1 \end{bmatrix} = \begin{bmatrix} 2 \\ 2 \end{bmatrix}$$

$$\therefore a = 1; c = 1; b = 2; d = 2$$

$$\begin{bmatrix} a & b \\ c & d \end{bmatrix} = \begin{bmatrix} 1 & 2 \\ 1 & 2 \end{bmatrix}$$

6 Reflection in x -axis = $\mathbf{A} = \begin{bmatrix} 1 & 0 \\ 0 & -1 \end{bmatrix}$

Dilation $\times 2$ from x -axis = $\mathbf{B} = \begin{bmatrix} 1 & 0 \\ 0 & 2 \end{bmatrix}$

$$\mathbf{BA} = \begin{bmatrix} 1 & 0 \\ 0 & 2 \end{bmatrix} \begin{bmatrix} 1 & 0 \\ 0 & -1 \end{bmatrix} = \begin{bmatrix} 1 & 0 \\ 0 & -2 \end{bmatrix}$$

7 a Reflection in the line $x = 0$ $\begin{bmatrix} -1 & 0 \\ 0 & 1 \end{bmatrix}$

b Reflection in the line $y = x$ $\begin{bmatrix} 0 & 1 \\ 1 & 0 \end{bmatrix}$

c Reflection in the line

$$y = -x \begin{bmatrix} 0 & -1 \\ -1 & 0 \end{bmatrix}$$

d Dilation of 2 from the x -axis $\begin{bmatrix} 1 & 0 \\ 0 & 2 \end{bmatrix}$

e Dilation of $\frac{1}{2}$ from the origin $\begin{bmatrix} 1 & 0 \\ 0 & \frac{1}{2} \end{bmatrix}$

f Dilation of 3 from the y -axis $\begin{bmatrix} 3 & 0 \\ 0 & 1 \end{bmatrix}$

8 a Dilation of factor 2 from the

x -axis: $\begin{bmatrix} 1 & 0 \\ 0 & 2 \end{bmatrix}$

Reflection in the line

$$y = -x: \begin{bmatrix} 0 & -1 \\ -1 & 0 \end{bmatrix}$$

$$T = \begin{bmatrix} 0 & -1 \\ -1 & 0 \end{bmatrix} \begin{bmatrix} 1 & 0 \\ 0 & 2 \end{bmatrix}$$

$$= \begin{bmatrix} 0 & -2 \\ -1 & 0 \end{bmatrix}$$

b $T(3, 2) = \begin{bmatrix} 0 & -2 \\ -1 & 0 \end{bmatrix} \begin{bmatrix} 3 \\ 2 \end{bmatrix} = \begin{bmatrix} -4 \\ -3 \end{bmatrix}$

c $\begin{bmatrix} 0 & -2 \\ -1 & 0 \end{bmatrix} \begin{bmatrix} a \\ b \end{bmatrix} = \begin{bmatrix} 6 \\ 2 \end{bmatrix}$

$$\therefore -2b = 6, \therefore b = -3$$

$$-a = 2, \therefore a = -2$$

9 $\mathbf{A} = \begin{bmatrix} 2 & 0 \\ 0 & 1 \end{bmatrix}$

$$\mathbf{A}^{-1} = \begin{bmatrix} \frac{1}{2} & 0 \\ 0 & 1 \end{bmatrix}$$

$$\mathbf{C} = \begin{bmatrix} 3 \\ 4 \end{bmatrix}$$

$$\mathbf{AX} + \mathbf{C} = \mathbf{X}', \text{ so } \mathbf{X} = \mathbf{A}^{-1}(\mathbf{X}' - \mathbf{C})$$

$$\mathbf{X} = \begin{bmatrix} \frac{1}{2} & 0 \\ 0 & 1 \end{bmatrix} \begin{bmatrix} x' - 3 \\ y' - 4 \end{bmatrix} = \begin{bmatrix} \frac{1}{2}(x' - 3) \\ y' - 4 \end{bmatrix}$$

$$\therefore x = \frac{1}{2}(x' - 3); y = y' - 4$$

10 $\begin{bmatrix} a & b \\ c & d \end{bmatrix} \begin{bmatrix} 1 \\ 3 \end{bmatrix} = \begin{bmatrix} -2 \\ -3 \end{bmatrix}$ and

$$\begin{bmatrix} a & b \\ c & d \end{bmatrix} \begin{bmatrix} 2 \\ 4 \end{bmatrix} = \begin{bmatrix} -3 \\ -11 \end{bmatrix}$$

$$a + 3b = -2; c + 3d = -3$$

$$2a + 4b = -3; 2c + 4d = -11$$

$$\text{These give } a = -\frac{1}{2}, b = -\frac{1}{2},$$

$$c = -\frac{21}{2}, d = \frac{5}{2}$$

$$T = \frac{1}{2} \begin{bmatrix} -1 & -1 \\ -21 & 5 \end{bmatrix}$$

Solutions to Exercise 7H

$$1 \quad \mathbf{T} = \begin{bmatrix} 3 & 0 \\ 0 & -2 \end{bmatrix} \therefore \mathbf{T}^{-1} = \begin{bmatrix} \frac{1}{3} & 0 \\ 0 & -\frac{1}{2} \end{bmatrix}$$

$$\mathbf{TX} = \mathbf{X}', \therefore \mathbf{x} = \mathbf{T}^{-1}\mathbf{x}'$$

$$\begin{bmatrix} x \\ y \end{bmatrix} = \begin{bmatrix} \frac{1}{3} & 0 \\ 0 & -\frac{1}{2} \end{bmatrix} \begin{bmatrix} x' \\ y' \end{bmatrix}$$

$$= \begin{bmatrix} \frac{1}{3}x' \\ -\frac{1}{2}y' \end{bmatrix}$$

$y = x^2 + x + 2$ maps onto:

$$-\frac{1}{2}y = \left(\frac{x}{3}\right)^2 + \frac{x}{3} + 2$$

$$\therefore y = -\frac{2x^2}{9} - \frac{2x}{3} - 4$$

$$2 \quad \mathbf{T} = \begin{bmatrix} 4 & 0 \\ 0 & -2 \end{bmatrix} \therefore \mathbf{T}^{-1} = \begin{bmatrix} \frac{1}{4} & 0 \\ 0 & -\frac{1}{2} \end{bmatrix}$$

$$\mathbf{TX} = \mathbf{X}', \therefore \mathbf{x} = \mathbf{T}^{-1}\mathbf{x}'$$

$$\begin{bmatrix} x \\ y \end{bmatrix} = \begin{bmatrix} \frac{1}{4} & 0 \\ 0 & -\frac{1}{2} \end{bmatrix} \begin{bmatrix} x' \\ y' \end{bmatrix} = \begin{bmatrix} \frac{1}{4}x' \\ -\frac{1}{2}y' \end{bmatrix}$$

$y = x^3 + 2x$ maps onto:

$$-\frac{1}{2}y = \left(\frac{x}{4}\right)^3 + \frac{2x}{4}$$

$$\therefore y = -\frac{x^3}{32} - x$$

$$3 \quad \mathbf{T} = \begin{bmatrix} 0 & 2 \\ -3 & 0 \end{bmatrix} \therefore \mathbf{T}^{-1} = \begin{bmatrix} 0 & -\frac{1}{3} \\ \frac{1}{2} & 0 \end{bmatrix}$$

$$\mathbf{TX} = \mathbf{X}', \therefore \mathbf{x} = \mathbf{T}^{-1}\mathbf{x}'$$

$$\begin{bmatrix} x \\ y \end{bmatrix} = \begin{bmatrix} 0 & -\frac{1}{3} \\ \frac{1}{2} & 0 \end{bmatrix} \begin{bmatrix} x' \\ y' \end{bmatrix} \\ = \begin{bmatrix} -\frac{1}{3}y' \\ \frac{1}{2}x' \end{bmatrix}$$

$y = 2x + 3$ maps onto:

$$\frac{1}{2}x = 2\left(-\frac{1}{3}y\right) + 3$$

$$\therefore 3x = -4y + 18$$

$$\therefore y = \frac{-3x + 18}{4}$$

$$4 \quad \mathbf{T} = \begin{bmatrix} 0 & 4 \\ -2 & 0 \end{bmatrix} \therefore \mathbf{T}^{-1} = \begin{bmatrix} 0 & -\frac{1}{2} \\ \frac{1}{4} & 0 \end{bmatrix}$$

$$\mathbf{TX} = \mathbf{X}', \therefore \mathbf{x} = \mathbf{T}^{-1}\mathbf{x}'$$

$$\begin{bmatrix} x \\ y \end{bmatrix} = \begin{bmatrix} 0 & -\frac{1}{2} \\ \frac{1}{4} & 0 \end{bmatrix} \begin{bmatrix} x' \\ y' \end{bmatrix} \\ = \begin{bmatrix} -\frac{1}{2}y' \\ \frac{1}{4}x' \end{bmatrix}$$

$y = -2x + 4$ maps onto:

$$\frac{1}{4}x = y + 4$$

$$\therefore y = \frac{x}{4} - 4$$

$$5 \quad \mathbf{T}(\mathbf{X} + \mathbf{B}) = \mathbf{X}', \text{ where } \mathbf{T} = \begin{bmatrix} 0 & -2 \\ 1 & 0 \end{bmatrix}$$

$$\therefore \mathbf{T}^{-1} = \begin{bmatrix} 0 & 1 \\ -\frac{1}{2} & 0 \end{bmatrix} \mathbf{B} = \begin{bmatrix} -1 \\ 2 \end{bmatrix}$$

$$\therefore \mathbf{T}^{-1}\mathbf{T}(\mathbf{X} + \mathbf{B}) = \mathbf{T}^{-1}\mathbf{X}'$$

$$\text{So } \mathbf{X} = \mathbf{T}^{-1}\mathbf{X}' - \mathbf{B}$$

$$\begin{bmatrix} x \\ y \end{bmatrix} = \begin{bmatrix} 0 & 1 \\ -\frac{1}{2} & 0 \end{bmatrix} \begin{bmatrix} x' \\ y' \end{bmatrix} - \begin{bmatrix} -1 \\ 2 \end{bmatrix}$$

$$= \begin{bmatrix} y' \\ -\frac{1}{2}x' \end{bmatrix}$$

$y = -2x + 6$ maps onto:

$$-\frac{x}{2} - 2 = -2(y + 1) + 6$$

$$\therefore x + 4 = 4y + 4 - 12$$

$$\therefore y = \frac{x}{4} + 3$$

6 $\mathbf{TX} + \mathbf{B} = \mathbf{X}'$, where $\mathbf{T} = \begin{bmatrix} 0 & -2 \\ 1 & 0 \end{bmatrix}$

$$\therefore \mathbf{T}^{-1} = \begin{bmatrix} 0 & 1 \\ -\frac{1}{2} & 0 \end{bmatrix} \mathbf{B} = \begin{bmatrix} -1 \\ 2 \end{bmatrix}$$

$\mathbf{TX} + \mathbf{B} = \mathbf{X}'$, so $\mathbf{X} = \mathbf{T}^{-1}(\mathbf{X}' - \mathbf{B})$

$$\begin{bmatrix} x \\ y \end{bmatrix} = \begin{bmatrix} 0 & 1 \\ -\frac{1}{2} & 0 \end{bmatrix} \begin{bmatrix} x' + 1 \\ y' - 2 \end{bmatrix}$$

$$= \begin{bmatrix} y' - 2 \\ -\frac{1}{2}x' - \frac{1}{2} \end{bmatrix}$$

$y = -2x + 6$ maps onto:

$$-\frac{x}{2} - \frac{1}{2} = -2(y - 2) + 6$$

$$\therefore x + 1 = 4y - 8 - 12$$

$$\therefore y = \frac{x + 21}{4}$$

7 $\mathbf{TX} + \mathbf{B} = \mathbf{X}'$, where $\mathbf{T} = \begin{bmatrix} 2 & 0 \\ 0 & 3 \end{bmatrix}$

$$\therefore \mathbf{T}^{-1} = \begin{bmatrix} \frac{1}{2} & 0 \\ 0 & \frac{1}{3} \end{bmatrix} \mathbf{B} = \begin{bmatrix} -2 \\ 2 \end{bmatrix}$$

$\mathbf{TX} + \mathbf{B} = \mathbf{X}'$

$$\therefore \mathbf{T}^{-1}(\mathbf{TX}) = \mathbf{T}^{-1}(\mathbf{X}' - \mathbf{B})$$

$$\therefore \mathbf{X} = \mathbf{T}^{-1}(\mathbf{X}' - \mathbf{B})$$

$$\begin{bmatrix} x \\ y \end{bmatrix} = \begin{bmatrix} \frac{1}{2} & 0 \\ 0 & \frac{1}{3} \end{bmatrix} \begin{bmatrix} x' + 2 \\ y' - 2 \end{bmatrix}$$

$$= \begin{bmatrix} \frac{1}{2}x' + 1 \\ \frac{1}{3}(y' - 2) \end{bmatrix}$$

$y = -2x^3 + 6x$ maps onto:

$$\frac{1}{3}(y - 2) = -2\left(\frac{x}{2} + 1\right)^3 + 6\left(\frac{x}{2} + 1\right)$$

$$\therefore y - 2 = -6\left(\frac{x}{2} + 1\right)^3 + 9x + 18$$

$$\therefore y = -\frac{3x^3}{4} - \frac{9x^2}{2} - 9x - 6 + 9x + 20$$

$$= -\frac{3x^3}{4} - \frac{9x^2}{2} + 14$$

Solutions to Technology-free questions

- 1 a Dilation of factor 4 from the x -axis:

$$\begin{bmatrix} 1 & 0 \\ 0 & 4 \end{bmatrix} \begin{bmatrix} -1 \\ 3 \end{bmatrix} = \begin{bmatrix} -1 \\ 12 \end{bmatrix}$$

- b Dilation of factor 3 from the y -axis:

$$\begin{bmatrix} 3 & 0 \\ 0 & 1 \end{bmatrix} \begin{bmatrix} -1 \\ 3 \end{bmatrix} = \begin{bmatrix} -3 \\ 3 \end{bmatrix}$$

- c Reflection in the x -axis:

$$\begin{bmatrix} 1 & 0 \\ 0 & -1 \end{bmatrix} \begin{bmatrix} -1 \\ 3 \end{bmatrix} = \begin{bmatrix} -1 \\ -3 \end{bmatrix}$$

- d Reflection in the y -axis:

$$\begin{bmatrix} -1 & 0 \\ 0 & 1 \end{bmatrix} \begin{bmatrix} -1 \\ 3 \end{bmatrix} = \begin{bmatrix} 1 \\ 3 \end{bmatrix}$$

- e Reflection in the line $y = x$:

$$\begin{bmatrix} 0 & 1 \\ 1 & 0 \end{bmatrix} \begin{bmatrix} -1 \\ 3 \end{bmatrix} = \begin{bmatrix} 3 \\ -1 \end{bmatrix}$$

2 a $y = \frac{1}{x} + 3$

Asymptotes at $x = 0$ and $y = 3$

x -intercept: $y = \frac{1}{x} + 3 = 0$

$\therefore \frac{1}{x} = -3, \therefore x = -\frac{1}{3}$

No y -intercept because $x = 0$ is an asymptote.

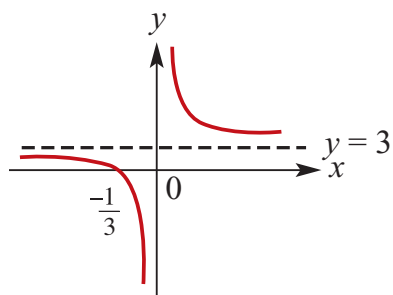

b $y = \frac{1}{x^2} - 3$

Asymptotes at $x = 0$ and $y = -3$

x -intercept: $y = \frac{1}{x^2} - 3 = 0$

$$\therefore \frac{1}{x^2} = 3, \therefore x = \pm \frac{1}{\sqrt{3}}$$

No y -intercept because $x = 0$ is an asymptote.

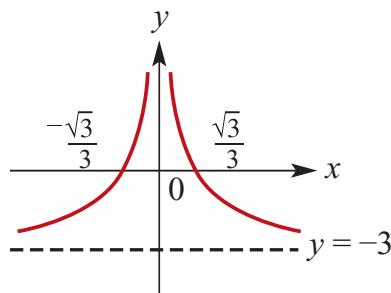

c $y = \frac{1}{(x+2)^2}$

Asymptotes at $x = -2$ and $y = 0$

y -intercept: $y = \frac{1}{2^2} - 3 = -\frac{11}{4}$

No x -intercept because $y = 0$ is an asymptote.

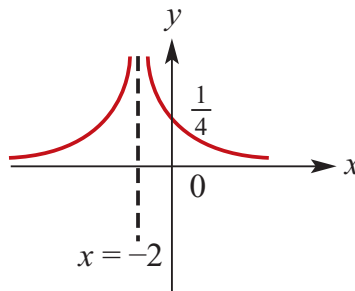

d $y = \sqrt{x-2}$

No asymptotes, starting point at $(2, 0)$.

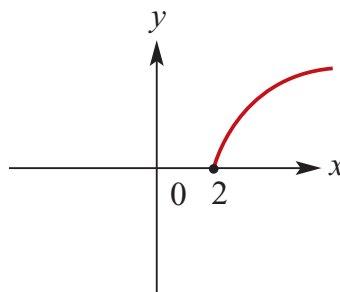

e $y = \frac{1}{x-1}$

Asymptotes at $x = 1$ and $y = 0$

y-intercept: $y = \frac{1}{0-1} = -1$
 No x-intercept because $y = 0$ is an asymptote.

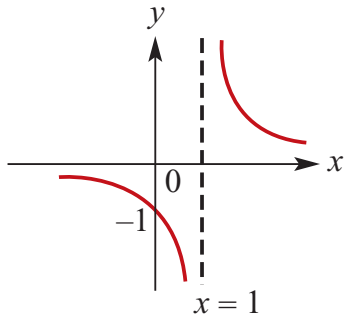

f $y = \frac{1}{x} - 4$
 Asymptotes at $x = 0$ and $y = -4$
 x-intercept: $y = \frac{1}{x} - 4 = 0$
 $\therefore \frac{1}{x} = 4, \therefore x = \frac{1}{4}$
 No y-intercept because $x = 0$ is an asymptote.

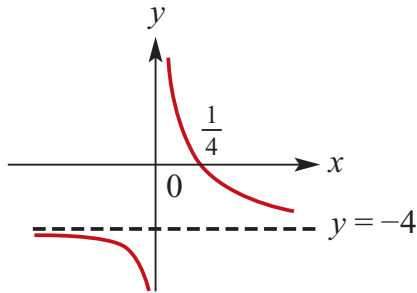

g $y = \frac{1}{x+2}$
 Asymptotes at $x = -2$ and $y = 0$
 y-intercept: $y = \frac{1}{0+2} = \frac{1}{2}$
 No x-intercept because $y = 0$ is an asymptote.

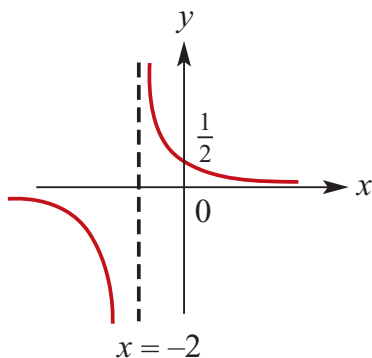

h $y = \frac{1}{x-3}$
 Asymptotes at $x = 3$ and $y = 0$
 y-intercept: $y = \frac{1}{0-3} = -\frac{1}{3}$
 No x-intercept because $y = 0$ is an asymptote.

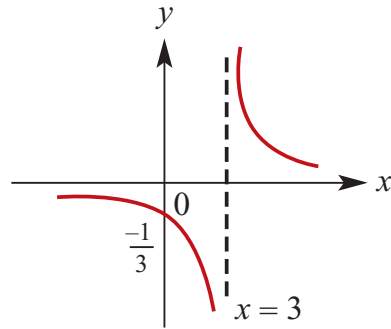

i $f(x) = \frac{1}{(x-3)^2}$
 Asymptotes at $x = 3$ and $y = f(x) = 0$
 y-intercept: $f(0) = \frac{1}{(0-3)^2} = \frac{1}{9}$
 No x-intercept because $y = 0$ is an asymptote.

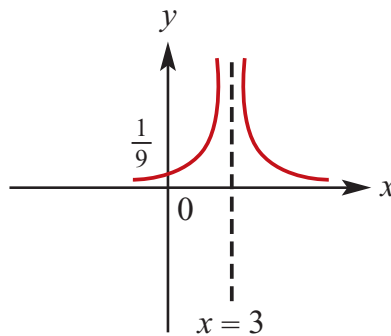

j $f(x) = \frac{1}{(x+4)^2}$
 Asymptotes at $x = -4$ and $y = f(x) = 0$
 y-intercept: $f(0) = \frac{1}{(0+4)^2} = \frac{1}{16}$
 No x-intercept because $y = 0$ is an asymptote.

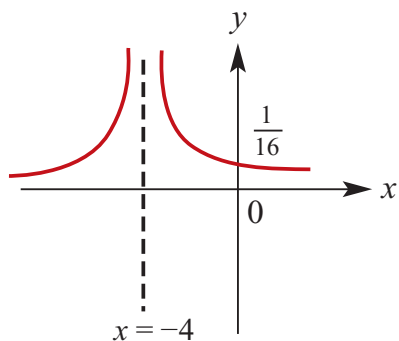

- k** $f(x) = \frac{1}{x-1} + 1$
 Asymptotes at $x = 1$ and $y = f(x) = 1$
 x -intercept: $y = \frac{1}{x-1} + 1 = 0$
 $\therefore \frac{1}{x-1} = -1, \therefore x = 0$
 y -intercept is also at $(0,0)$.

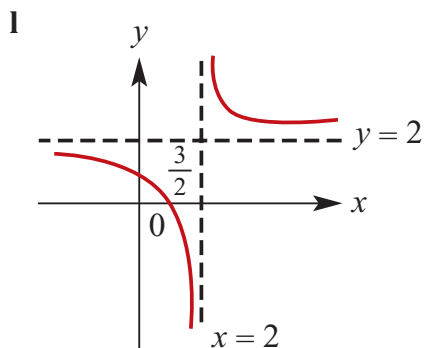
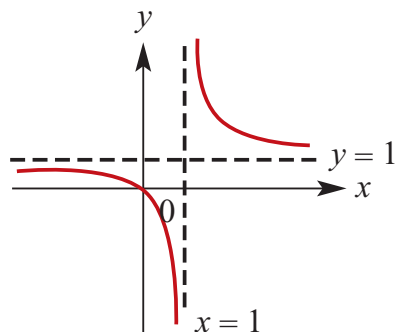

- 3 a** $y = \frac{1}{x^2} + 1$
 Asymptotes at $x = 0$ and $y = 1$
 No x -intercept since $y > 1$ for all real x .
 No y -intercept since $x = 0$ is an asymptote.

Range is $(1, \infty)$.

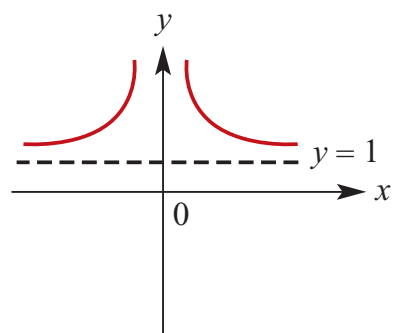

- b** $y = \frac{3}{x^2}$
 Asymptotes at $x = 0$ and $y = 0$
 No x -intercept since $y > 0$ for all real x .
 No y -intercept since $x = 0$ is an asymptote.
 Range is $(0, \infty)$.

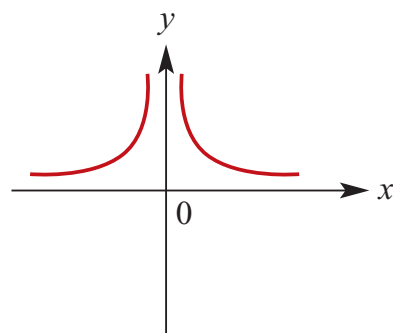

- c** $y = \frac{1}{(x-1)^2}$
 Asymptotes at $x = 1$ and $y = 0$
 No x -intercept since $y > 0$ for all real x .
 y -intercept at $y = \frac{1}{(0-1)^2} = 1$
 Range is $(0, \infty)$.

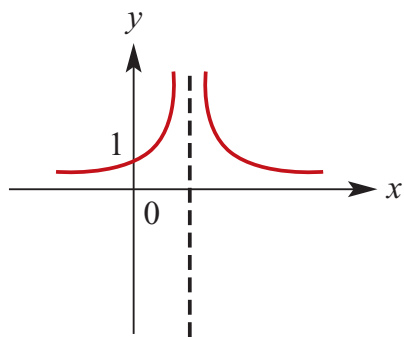

d $y = \frac{1}{x^2} - 4$

Asymptotes at $x = 0$ and $y = -4$
 x -intercept where $y = \frac{1}{x^2} - 4 = 0$

$$\therefore \frac{1}{x^2} = 4$$

$$\therefore x^2 = \frac{1}{4}$$

$$\therefore x = \pm \frac{1}{2}$$

No y -intercept since $x = 0$ is an asymptote.

Range is $(-4, \infty)$.

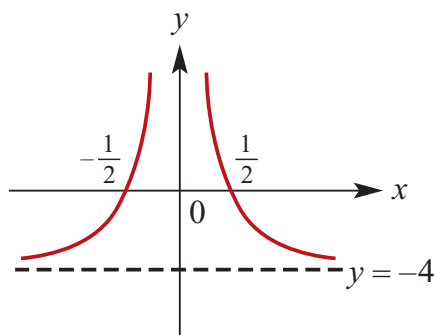

4 $\begin{bmatrix} 1 & 0 \\ 0 & 2 \end{bmatrix} \begin{bmatrix} x \\ y \end{bmatrix} + \begin{bmatrix} 2 \\ 3 \end{bmatrix} = \begin{bmatrix} x' \\ y' \end{bmatrix}, x = x' - 2,$
 $y = \frac{y' - 3}{2}$

5 a i $(x, y) \rightarrow (x - 1, 3y + 2)$

ii $(x, y) \rightarrow (x - 2, -2y + 3)$

iii $(x, y) \rightarrow \left(\frac{x-1}{3}, y-1\right)$

b i $(x, y) \rightarrow (x - 2, 4y)$

ii $(x, y) \rightarrow (x - 6, y - 12)$

iii $(x, y) \rightarrow (x + 3, 4y - 5)$

c i $(x, y) \rightarrow (x + 4, y + 2)$

ii $(x, y) \rightarrow \left(\frac{x}{2}, 2y\right)$

iii $(x, y) \rightarrow (x, -2y + 3)$

6 $\begin{bmatrix} 3 & 0 \\ 0 & 1 \end{bmatrix} \begin{bmatrix} x \\ y \end{bmatrix} + \begin{bmatrix} -2 \\ 3 \end{bmatrix} = \begin{bmatrix} x' \\ y' \end{bmatrix}, x = \frac{x' + 2}{3},$
 $y = y' - 3$

Solutions to multiple-choice questions

1 C $(1, 7) \rightarrow (1, 10) \rightarrow (1, -10)$

2 D $(4, -3) \rightarrow (4, 1) \rightarrow (-4, 1)$

3 A $3a - 1 = 8$ and $b + 2 = 8$
 $\therefore a = 3$ and $b = 6$

4 B $3a - 1 = a$ and $2b + 2 = b$
 $\therefore a = \frac{1}{2}$ and $b = -2$
(Needs to be changed)

5 E 1st matrix is reflection in y-axis:
 $(1, 0)$ becomes $(-1, 0)$, $(0, 1)$ stays put

and $(1, 1)$ becomes $(-1, 1)$.

2nd matrix: $\begin{bmatrix} 0 & -1 \\ -2 & 1 \end{bmatrix}$ maps $(-1, 0)$
onto $(0, 2)$, $(0, 1)$ onto $(-1, 1)$ and
 $(-1, 1)$ onto $(-1, 3)$.

6 D $(x, y) \rightarrow (3x, 2y)$. $\therefore x' = 3x$ and
 $y' = 2y$

7 B $(x, y) \rightarrow (x, 2y) \rightarrow (2y, x)$.
 $\therefore x' = 2y$ and $y' = x$

8 C $(x, y) \rightarrow (x, 2y) \rightarrow (x, -2y)$.
 $\therefore x' = x$ and $y' = -2y$

Solutions to extended-response questions

1 a $f(x) + k = x^2 + k$

Consider the equations:

$$y = x$$

$$y = x^2 + k$$

Solving simultaneously

$$x = x^2 + k$$

$$x^2 - x + k = 0 \dots (1)$$

For $y = x$ to be a tangent to $y = x^2 + k$ the discriminant of the quadratic in equation (1) is zero. That is $\Delta = 0$

$$\therefore 1 - 4k = 0$$

$$\therefore k = \frac{1}{4}$$

b $f(x - h) = (x - h)^2$

Consider the equations:

$$y = x$$

$$y = (x - h)^2$$

Solving simultaneously

$$x = (x - h)^2$$

$$x = x^2 - 2xh + h^2$$

$$x^2 - 2xh - x - h^2 = 0$$

$$x^2 - (1 + 2h)x + h^2 = 0 \dots (1)$$

For $y = x$ to be a tangent to $y = (x - h)^2$ the discriminant of the quadratic in equation (1) is zero. That is $\Delta = 0$

$$(1 + 2h)^2 - 4h^2 = 0$$

$$1 + 4h + 4h^2 - 4h^2 = 0$$

$$1 + 4h = 0$$

$$h = -\frac{1}{4}$$

2 a $7(1 + h)^2 = 8$

$$\therefore 1 + h = \pm \sqrt{8}$$

$$\therefore h = -1 \pm 2\sqrt{2}$$

$$\begin{aligned}
 \mathbf{b} \quad & \text{Let } g(x) = f(ax) \\
 & = (ax)^2 \\
 & = a^2x^2
 \end{aligned}$$

$$\text{Now } g(1) = 8, \therefore a^2 = 8$$

$$\therefore a = \pm 2\sqrt{2}$$

$$\begin{aligned}
 \mathbf{c} \quad & y = ax^2 + bx \\
 & = a\left(x^2 + \frac{b}{a}x\right) \\
 & = a\left(x^2 + \frac{b}{a}x + \frac{b^2}{4a^2} - \frac{b^2}{4a^2}\right) \\
 & = a\left(x^2 + \frac{b}{a}x + \frac{b^2}{4a^2}\right) - \frac{b^2}{4a} \\
 & = a\left(x + \frac{b}{2a}\right)^2 - \frac{b^2}{4a}
 \end{aligned}$$

The vertex has coordinates $(1, 8)$, $\therefore \frac{-b}{2a} = 1$ and $\frac{-b^2}{4a} = 8$.

Substituting $\frac{-b}{2a} = 1$ into $\frac{-b^2}{4a} = 8$ gives

$$\frac{b}{2} = 8$$

$$\therefore b = 16$$

Substituting $b = 16$ into $\frac{-b}{2a} = 1$ gives

$$\frac{-16}{2a} = 1$$

$$a = -8$$

$$\begin{aligned}
 \mathbf{3 a} \quad & g(x) = x^2 + 4x - 6 \\
 & g(x) + k = 0
 \end{aligned}$$

$$x^2 + 4x - 6 + k = 0$$

$$\text{One solution when } \Delta = 0 \quad \Delta = 0$$

$$16 - 4(k - 6) = 0$$

$$16 - 4k + 24 = 0$$

$$40 - 4k = 0$$

$$k = 10$$

b $x^2 + 4x - 6 = 0$

$$x^2 + 4x + 4 - 4 - 6 = 0$$

$$(x + 2)^2 - 10 = 0$$

$$(x + 2)^2 = 10$$

$$x = -2 \pm \sqrt{10}$$

i For two positive solutions $h > 2 + \sqrt{10}$

ii for two negative solutions $h < 2 - \sqrt{10}$

iii One positive and one negative $2 - \sqrt{10} < h < 2 + \sqrt{10}$

4 a $f(x - 2) = (x - 5)(x + 2)(x - 7)$

$$f(x - 2) = 0$$

$$(x - 5)(x + 2)(x - 7) = 0$$

$$x = 5 \text{ or } x = -2 \text{ or } x = 7$$

b $f(x + 2) = (x - 1)(x + 6)(x - 3)$

$$f(x + 2) = 0$$

$$(x - 1)(x + 6)(x - 3) = 0$$

$$x = 1 \text{ or } x = -6 \text{ or } x = 3$$

c Since $x = 0$ is a solution of $f(x) + k = 0$

$$f(x) + k = 0$$

$$60 + k = 0$$

$$k = -60$$

$$f(x) - 60 = 0$$

$$(x - 3)(x + 4)(x - 5) - 60 = 0$$

$$x^3 - 4x^2 - 17x = 0$$

$$x(x^2 - 4x - 17) = 0$$

$$x(x^2 - 4x + 4 - 21) = 0$$

$$x((x - 2)^2 - 21) = 0$$

$$x(x - 2 + \sqrt{21})(x - 2 - \sqrt{21}) = 0$$

$$x = 0 \text{ or } x = 2 - \sqrt{21} \text{ or } x = 2 + \sqrt{21}$$

d $f(x - h) = 0$ has a solution when $x = 0$

$$\therefore (-h - 3)(-h + 4)(-h - 5) = 0 \therefore h = -3 \text{ or } h = 4 \text{ or } h = -5$$

e The solutions of $f(x - h) = 0$ are $h + 3$, $h + 5$ and $h - 4$
 $\therefore -5 < h < -3$

Chapter 8 – Revision of chapters 1–7

Solutions to Technology-free questions

1 a Vertices $A(-2, 1), B(3, -4), C(5, 7)$

$$\text{Coordinates of M} = \left(\frac{-2+3}{2}, \frac{1+(-4)}{2} \right)$$

$$= \left(\frac{1}{2}, -\frac{3}{2} \right)$$

$$\text{Coordinates of N} = \left(\frac{-2+5}{2}, \frac{1+7}{2} \right)$$

$$= \left(\frac{3}{2}, 4 \right)$$

b Gradient of MN = $\frac{4 - \left(-\frac{3}{2}\right)}{\frac{3}{2} - \frac{1}{2}}$

$$= \frac{11}{2}$$

Gradient of BC = $\frac{7 - (-4)}{5 - 3}$

$$= \frac{11}{2}$$

$\therefore BC \parallel MN$

2 $P(x) = 8x^3 + 4x - 3$

a $P\left(-\frac{1}{2}\right) = 8 \times \left(-\frac{1}{2}\right)^3 + 4\left(-\frac{1}{2}\right) - 3$

$$= -1 - 2 - 3$$

$$= -6$$

b $P(2) = 8 \times (2)^3 + 4(2) - 3$

$$= 64 + 8 - 3$$

$$= 69$$

c $Q(x) = P(x + 1)$

$$= 8 \times (x + 1)^3 + 4(x + 1) - 3$$

$$= 64 + 8 - 3$$

$$= 69$$

$$Q(-2) = 8 \times (-2 + 1)^3 + 4(-2 + 1) - 3$$

$$= -8 - 4 - 3$$

$$= -15$$

3 $g(x) = 3x^2 - 4$

a $g(2a) = 3(2a)^2 - 4 = 12a^2 - 4$

b $g(a - 1) = 3(a - 1)^2 - 4$

$$= 3(a^2 - 2a + 1) - 4$$

$$= 3a^2 - 6a - 1$$

c $g(a + 1) - g(a - 1)$

$$= 3(a + 1)^2 - 4 - (3(a - 1)^2 - 4)$$

$$= 3((a^2 + 2a + 1) - (a^2 - 2a + 1))$$

$$= 12a$$

4 $f(x) = 4 - 5x$ and $g(x) = 7 + 2x$

a $f(2) + f(3) = -6 + (-11) = -17$

$$f(2 + 3) = f(5) = -21$$

$$\therefore f(2) + f(3) \neq f(2 + 3)$$

b $f(x) = g(x)$

$$4 - 5x = 7 + 2x$$

$$-3 = 7x$$

$$x = -\frac{3}{7}$$

c $f(x) \geq g(x)$

$$4 - 5x \geq 7 + 2x$$

$$-3 \geq 7x$$

$$x \leq -\frac{3}{7}$$

d $f(2k) = g(3k)$

$$4 - 5(2k) = 7 + 2(3k)$$

$$4 - 10k = 7 + 6k$$

$$-3 = 16k$$

$$k = -\frac{3}{16}$$

5 $x + y = 5 \dots (1)$

$$(x + 1)^2 + (y + 1)^2 = 25 \dots (2)$$

From equation (1) $y = 5 - x$

Substitute in equation (2)

$$(x + 1)^2 + (6 - x)^2 = 25$$

$$x^2 + 2x + 1 + 36 - 12x + x^2 = 25$$

$$2x^2 - 10x + 37 = 25$$

$$2x^2 - 10x + 12 = 0$$

$$x^2 - 5x + 6 = 0$$

$$(x - 3)(x - 2) = 0$$

$$x = 3 \text{ or } x = 2$$

From equation (1)

When $x = 3, y = 2$ and when

$$x = 2, y = 3$$

6 $A(0, -5), B(-1, 2), C(4, 7), D(5, 0)$

$$AB = \sqrt{(7 - 2)^2 + (4 - (-1))^2}$$

$$= \sqrt{25 + 25}$$

$$= 5\sqrt{2}$$

$$BC = \sqrt{(2 - (-5))^2 + (-1 - 0)^2}$$

$$= \sqrt{49 + 1}$$

$$= 5\sqrt{2}$$

$$CD = \sqrt{(0 - 7)^2 + (5 - 4)^2}$$

$$= \sqrt{49 + 1}$$

$$= 5\sqrt{2}$$

$$DA = \sqrt{(5 - 0)^2 + (0 - (-5))^2}$$

$$= \sqrt{25 + 25}$$

$$= 5\sqrt{2}$$

This is sufficient to prove $ABCD$ is a rhombus.

7 a $y = x^2 + 4x - 9$

$$= x^2 + 4x + 4 - 4 - 9$$

$$= (x + 2)^2 - 13$$

b $y = x^2 - 3x - 11$

$$= x^2 - 3x + \frac{9}{4} - \frac{9}{4} - 11$$

$$= \left(x - \frac{3}{2}\right)^2 - \frac{53}{4}$$

c $y = 2x^2 - 3x + 11$

$$= 2 \left[x^2 - \frac{3}{2}x + \frac{11}{2} \right]$$

$$= 2 \left[x^2 - \frac{3}{2}x + \frac{9}{16} - \frac{9}{16} + \frac{11}{2} \right]$$

$$= 2 \left[\left(x - \frac{3}{4}\right)^2 + \frac{79}{16} \right]$$

$$= 2 \left(x - \frac{3}{4}\right)^2 + \frac{79}{8}$$

8 a $y = 4x + 1 \dots (1)$

$$y = x^2 + 3x - 9 \dots (2)$$

Substitute in equation (2) from equation 1

$$4x + 1 = x^2 + 3x - 9$$

$$\therefore 0 = x^2 - x - 10$$

$$\therefore x^2 - x - 10 = 0$$

$$\therefore x^2 - x + \frac{1}{4} - \frac{1}{4} - 10 = 0$$

$$\therefore \left(x - \frac{1}{2}\right)^2 = \frac{41}{4}$$

$$x = \frac{1}{2} \pm \frac{\sqrt{41}}{2}$$

$$x = \frac{1 \pm \sqrt{41}}{2}$$

From equation (1)

$$\text{When } x = \frac{1 + \sqrt{41}}{2}$$

$$y = 2 + 2\sqrt{41} + 1 = 3 + 2\sqrt{41}$$

$$\text{When } x = \frac{1 - \sqrt{41}}{2}$$

$$y = 2 - 2\sqrt{41} + 1 = 3 - 2\sqrt{41}$$

b $y = 2x + 2 \dots (1)$

$$y = x^2 - 2x + 6 \dots (2)$$

Substitute in equation (2) from equation 1

$$2x + 2 = x^2 - 2x + 6 \text{ From}$$

$$\therefore 0 = x^2 - 4x + 4$$

$$\therefore x^2 - 4x + 4 = 0$$

$$\therefore (x - 2)^2 = 0$$

$$x = 2$$

equation (1)

$$\text{When } x = 2, y = 6$$

c $y = -3x + 2 \dots (1)$

$$y = x^2 + 5x + 18 \dots (2)$$

$$-3x + 2 = x^2 + 5x + 18 \text{ From}$$

$$\therefore 0 = x^2 + 8x + 16$$

$$\therefore x^2 + 8x + 16 = 0$$

$$\therefore (x + 4)^2 = 0$$

$$\therefore x = -4$$

equation (1)

$$\text{When } x = -4, y = 14$$

9 a $x^2 + 3x - 5 > 0$

Consider

$$x^2 + 3x - 5 = 0$$

$$x^2 + 3x + \frac{9}{4} - \frac{9}{4} - 5 = 0$$

$$\left(x + \frac{3}{2}\right)^2 = \frac{29}{4}$$

$$x + \frac{3}{2} = \pm \frac{\sqrt{29}}{2}$$

$$x = \frac{-3 \pm \sqrt{29}}{2}$$

The coefficient of x^2 is positive.

Therefore $x^2 + 3x - 5 > 0$ if and only

if

$$x \in \left(-\infty, \frac{-3 - \sqrt{29}}{2}\right) \cup$$

$$\left(\frac{-3 + \sqrt{29}}{2}, \infty\right)$$

b $2x^2 - 5x - 5 \geq 0$

Consider

$$2\left(x^2 - \frac{5}{2}x - \frac{5}{2}\right) = 0$$

$$x^2 - \frac{5}{2}x - \frac{5}{2} = 0$$

$$x^2 - \frac{5}{2}x + \frac{25}{16} - \frac{25}{16} - \frac{5}{2} = 0$$

$$\left(x - \frac{5}{4}\right)^2 = \frac{65}{16}$$

$$x - \frac{5}{4} = \pm \frac{\sqrt{65}}{4}$$

$$x = \frac{5 \pm \sqrt{65}}{4}$$

The coefficient of x^2 is positive.

Therefore $2x^2 - 5x - 5 \geq 0$ if and only if

$$x \in \left(-\infty, \frac{5 - \sqrt{65}}{4}\right] \cup \left[\frac{5 + \sqrt{65}}{4}, \infty\right)$$

c $(x - 3)^2(x + 4) \geq 0$
 $(x - 3)^2 \geq 0$ for all x .
 $\therefore (x - 3)^2(x + 4) \geq 0 \Leftrightarrow x + 4 \geq 0$
 $\Leftrightarrow x \geq -4$

That is $(x - 3)^2(x + 4) \geq 0$ if and only if $x \in [-4, \infty)$

d $(x - 3)(x + 4)(2x - 1) \leq 0$
The coefficient of x^3 is positive.
Therefore $(x - 3)(x + 4)(2x - 1) \leq 0$
if and only if $x \in \left[\frac{1}{2}, 3\right] \cup (-\infty, -4]$

e $(x - 2)^3 - 8 \leq 0$
 $\Leftrightarrow (x - 2)^3 \leq 8$
 $\Leftrightarrow x - 2 \leq 2$
 $\Leftrightarrow x \leq 4$

10 a $\mathbb{R} \setminus \{\frac{5}{2}\}$

b $(-\infty, 5]$

c \mathbb{R}

d $\mathbb{R} \setminus \{2\}$

e \mathbb{R}

f $\mathbb{R} \setminus \{\frac{2}{3}\}$

11 Let $P(x) = 3x^3 + x^2 + px + 24$
 $P(-4) = 0$ by the factor theorem.

Hence

$$3(-4)^3 + (-4)^2 + (-4)p + 24 = 0$$

$$-192 + 16 - 4p + 24 = 0$$

$$-4p = 152$$

$$\therefore p = -38$$

$$\therefore P(x) = 3x^3 + x^2 - 38x + 24$$

$$3x^3 + x^2 - 38x + 24 = (x + 4)(3x^2 + bx + 6)$$

since $x + 4$ is a factor.

By equating coefficients of x^2

$$1 = 12 + b, \therefore b = -11$$

$$P(x) = (x + 4)(3x^2 - 11x + 6)$$

$$= (x + 4)(3x - 2)(x - 3)$$

12

$$5x^3 - 3x^2 + ax + 7 = (x + 2)Q_1(x) + R \dots (1)$$

$$4x^3 + ax^2 + 7x - 4 = (x + 2)Q_2(x) + 2R \dots (2)$$

Multiply (1) by 2 and subtract (1) from the result.

$$6x^3 - (6 + a)x^2 + (2a - 7)x + 18 =$$

$$(x + 2)(2Q_1 - Q_2)$$

When $x = -2$

$$6(-2)^3 - (6 + a)(-2)^2 + (2a - 7)(-2) + 18 = 0$$

$$\therefore -48 - 24 - 4a - 4a + 14 + 18 = 0$$

$$\therefore -8a = 40$$

$$\therefore a = -5$$

Substitute in (1)

$$5x^3 - 3x^2 - 5x + 7 = (x + 2)Q_1(x) + R$$

Substitute $x = -2$

$$R = 5(-2)^3 - 3(-2)^2 - 5(-2) + 7 = -35$$

13 a $f : [1, 2] \rightarrow \mathbb{R}, f(x) = x^2$
 Domain of $f = [1, 2]$
 Range of $f = [1, 4]$
 Let $y = x^2$
 Interchange x and y .
 $x = y^2$
 Choose $y = \sqrt{x}$, (range of f)
 $\therefore f^{-1} : [1, 4] \rightarrow \mathbb{R}, f^{-1}(x) = \sqrt{x}$

b $h : [-1, 2] \rightarrow \mathbb{R}, f(x) = 2 - x$
 Domain of $h = [-1, 2]$
 Range of $h = [0, 3]$
 Let $y = 2 - x$
 Interchange x and y .
 $x = 2 - y$
 $y = 2 - x$
 $\therefore h^{-1} : [0, 3] \rightarrow \mathbb{R}, h^{-1}(x) = 2 - x$

c $g : \mathbb{R}^{-1} \rightarrow \mathbb{R}, g(x) = x^2 - 4$
 Domain of $g = (-\infty, 0)$
 Range of $g = (-4, \infty]$
 Let $y = x^2 - 4$
 Interchange x and y .
 $x = y^2 - 4$
 $y = -\sqrt{x+4}$ (range of g)
 $\therefore g^{-1} : [0, 3] \rightarrow \mathbb{R}, g^{-1}(x) = -\sqrt{x+4}$

d $f : (-\infty, 2] \rightarrow \mathbb{R}, f(x) = \sqrt{2-x} + 3$
 Domain of $f = (-\infty, 2]$
 Range of $f = [3, \infty]$
 Let $y = \sqrt{2-x} + 3$
 Interchange x and y .
 $x = \sqrt{2-y} + 3$
 $y = -(x-3)^2 + 2$
 $\therefore f^{-1} : [3, \infty) \rightarrow \mathbb{R},$
 $f^{-1}(x) = -(x-3)^2 + 2$

e $f : \mathbb{R} \rightarrow \mathbb{R}, f(x) = (x-2)^3 + 8$
 Domain of $f = \mathbb{R}$
 Range of $f = \mathbb{R}$
 Let $y = (x-2)^3 + 8$

Interchange x and y .

$$x = (y-2)^3 + 8$$

$$y = (x-8)^{\frac{1}{3}} + 2$$

$$\therefore f^{-1} : \mathbb{R} \rightarrow \mathbb{R},$$

$$f^{-1}(x) = (x-8)^{\frac{1}{3}} + 2$$

14 Let b be the cost of a Bob's burger.
 Let f be the cost of a regular fries.

a $\therefore 3b + 2f = 18.20$

b If $b = 4.2$
 $3 \times 4.20 + 2f = 18.20$
 $\therefore 2f = 18.20 - 12.60$
 $\therefore f = 2.80$

The cost of regular fries is \$2.80

15 $4x + ky = 7$ and $y = 3 - 4x$ The gradient of the line $4x + ky = 7$ is $-\frac{4}{k}$
 The gradient of the line $y = 3 - 4x$ is -4

a If the lines are parallel, $-\frac{4}{k} = -4$
 Hence $k = 1$

b If the lines are perpendicular
 $-\frac{4}{k} \times -4 = -1$
 $k = -16$

16 Line ℓ_1 has x -axis intercept $(5, 0)$ and y -axis intercept $(0, -2)$.

a Gradient of $\ell_1 = \frac{-2-0}{0-5} = \frac{2}{5}$

b Line ℓ_2 is perpendicular to line ℓ_1
 Hence gradient of ℓ_2 is $-\frac{5}{2}$
 The line ℓ_2 has equation of the form
 $y = -\frac{5}{2}x + c$

When $x = 1, y = 6 \therefore 6 = -\frac{5}{2} + c$ and hence

$$c = \frac{17}{2} \text{ and } y = -\frac{5}{2}x + \frac{17}{2}$$

Rearranging as required

$$5x + 2y - 17 = 0$$

17 a $ax^2 + 2x + a$

$$= a\left(x^2 + \frac{2}{a}x + 1\right)$$

$$= a\left(x^2 + \frac{2}{a}x + \frac{1}{a^2} - \frac{1}{a^2} + 1\right)$$

$$= a\left(\left(x + \frac{1}{a}\right)^2 + \frac{a^2 - 1}{a^2}\right)$$

$$= a\left(x + \frac{1}{a}\right)^2 + \frac{a^2 - 1}{a}$$

b $\left(-\frac{1}{a}, \frac{a^2 - 1}{a}\right)$

c Perfect square when $\frac{a^2 - 1}{a} = 0$.
That is when $a = \pm 1$

d There are two solutions
when $\frac{a^2 - 1}{a} < 0$
That is, when $a \in (-1, 1)$.

18 a $y = 1 + \frac{1}{2+x}$

When $x = 0, y = \frac{3}{2}$ When

$$y = 0, 1 + \frac{1}{2+x} = 0$$

That is, $\frac{1}{2+x} = -1$ which implies
 $x = -3$

The horizontal asymptote has
equation $y = 1$

The vertical asymptote has equation
 $x = -2$

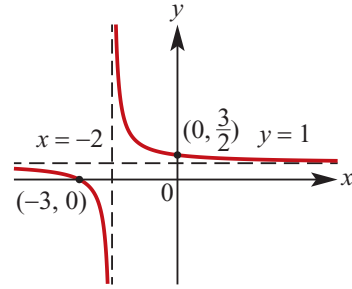

b $A\left(0, \frac{3}{2}\right), B(-3, 0)$

c $y = \frac{1}{2}x + \frac{3}{2}$

d The midpoint
 $\left(\frac{0 + (-3)}{2}, \frac{\frac{3}{2} + 0}{2}\right) = \left(-\frac{3}{2}, \frac{3}{4}\right)$

e Gradient of line $AB = \frac{\frac{3}{2} - 0}{0 - (-3)} = \frac{1}{2}$
Gradient of a line perpendicular to
 AB is -2 .

Therefore using the general form

$y - y_1 = m(x - x_1)$ we have

$$y - \frac{3}{4} = -2\left(x + \frac{3}{2}\right)$$

That is,

$$y = -2x - \frac{9}{4}$$

Solutions to multiple-choice questions

1 B $y = x^2 - ax$

$$= x^2 - ax + \left(\frac{a}{2}\right)^2 - \left(\frac{a}{2}\right)^2$$

$$= \left(x - \frac{a}{2}\right)^2 - \frac{a^2}{4}$$

2 D $\Delta = 4a^2 - 4b = 0$

$$a^2 = b$$

$$a = \sqrt{b} \text{ or } a = -\sqrt{b}$$

But a and b are positive constants.

Therefore $a = \sqrt{b}$

3 C Gradients are the same when

$$\frac{2-m}{3} = \frac{-2}{m+2}$$

$$\frac{m-2}{3} = \frac{2}{m+2}$$

$$m^2 - 4 = 6$$

$$m = \pm \sqrt{10}$$

4 A $3x - 2y = -6$

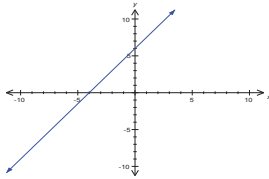

5 D Only $(1, 2)$ is on the line $y = 3x - 1$

6 D $x^3 - 8 = x^3 - 2^3$

$$= (x - 2)(x^2 + 2x + 4)$$

7 C $2x^2 - 5x - 12 = (2x + a)(x - b)$

$$a - 2b = -5; ab = 12$$

$$a = 3, b = 4; f(x) = (2x + 3)(x - 4)$$

8 C $P(x) = 4x^3 - 5x + 5$

$$P\left(-\frac{3}{2}\right) = -1$$

9 C $x^2 + y^2 + 6x - 2y + 6 = 0$

$$\therefore x^2 + 6x + 9 + y^2 - 2y + 1 = 10 - 6$$

$$\therefore (x + 3)^2 + (y - 1)^2 = 2^2$$

Radius = 2

10 A $2x + 4y - 6 = 0$

$$\therefore 4y = -2x + 6$$

$$\therefore y = -\frac{1}{2}x + \frac{3}{2}$$

Gradient = $-\frac{1}{2}$

11 E $2x + 4y = 3$

$$\therefore 4y = -2x + 3$$

$$\therefore y = -\frac{1}{2}x + \frac{3}{4}$$

Line has gradient $= -\frac{1}{2}$, so
 perpendicular has gradient $m = 2$.
 Using $(1, 2)$: $y - 2 = 2(x - 1)$
 $\therefore y = 2x$

12 B $P(x) = x^3 + ax^2 - x - 6$

If $x - 3$ is a factor of

$P(x)$ then $P(3) = 0$:

$$P(3) = 27 + 9a - 3 - 6 = 0$$

$$\therefore 9a + 18 = 0, \therefore a = -2$$

13 A $P(x) = x^3 + 8x^2 + 9x - 18$

$$P(1) = 1 + 8 + 9 - 18 = 0$$

$$\therefore P(x) = (x - 1)(x^2 + 9x + 18)$$

$$= (x - 1)(x + 6)(x + 3)$$

14 E

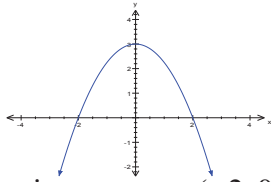

x -intercepts at $(-2, 0)$ and $(2, 0)$, so

$$y = a(x - 2)(x + 2)$$

$$\therefore y = a(x^2 - 4)$$

Using y -intercept at $(0, 3)$, $a = -\frac{3}{4}$

$$\therefore y = -\frac{3}{4}(x - 2)(x + 2)$$

OR $4y = -3(x - 2)(x + 2)$

15 B Perpendicular lines have gradients which multiply to -1

$$\therefore -3m = -1, \therefore m = \frac{1}{3}$$

16 D $f(x) = x^2 - 1$

$$\therefore f(x - 1) = ((x - 1)^2 - 1)$$

$$= x^2 - 2x + 1 - 1$$

$$= x^2 - 2x$$

17 D $y = x^2 + kx + k + 8$ touches the

x -axis. Therefore it is a perfect square and $\Delta = 0$:

$$\Delta = k^2 - 4(k + 8)$$

$$= k^2 - 4k - 32$$

$$= (k - 8)(k + 4)$$

$$\Delta = 0 \text{ when } k = -4 \text{ or } 8$$

18 E $P(x) = 3x^3 - 4x - k$

If $P(x)$ is divisible by $x - k$, then

$$P(k) = 0: P(k) = 3k^3 - 4k - k = 0$$

$$= 3k^3 - 5k = 0$$

Remainder when $P(x)$ is divided by $x + k$:

$$P(-k) = -3k^3 + 4k - k$$

$$= -3k^3 + 3k$$

$$3k^3 - 5k = 0, \therefore -3k^3 + 5k = 0$$

$$\therefore P(-k) = 0 - 2k$$

19 B TP of $y = a(x - b)^2 + c$ is at (b, c)

20 D $y = 3 + 4x - x^2$

meets $y = k$ only once.

$$\therefore -x^2 + 4x + (3 - k) = 0 \text{ has } \Delta = 0:$$

$$\Delta = 16 + 4(3 - k) = 0$$

$$\therefore 3 - k = -4, \therefore k = 7$$

21 E Midpoint of $(12, 7)$ and $(-3, 5)$ is:

$$\left(\frac{12 - 3}{2}, \frac{7 + 5}{2}\right) = \left(\frac{9}{2}, 6\right)$$

22 D X is at (a, b) : $(7, -3) = \left(\frac{5+a}{2}, \frac{4+b}{2}\right)$
 $5 + a = 14, \therefore a = 9$
 $4 + b = -6, \therefore b = -10$

23 B $y = x^2 + 1$
 $\text{dom } [-2, 1] \rightarrow \text{range } [1, 5]$

24 D $x^3 + 2x - 8 = 0$
 Use calculator:

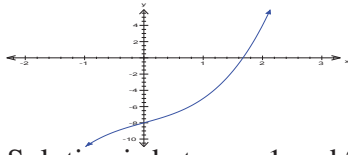

Solution is between 1 and 2.

25 D $f(x) = x(x - 2)$
 $\therefore f(-3) = (-3)(-5) = 15$

26 A $x^2 + y^2 - 11x - 10y + 24 = 0$
 Circle cuts the y -axis at M and N so
 $x = 0$
 $y^2 - 10y + 24 = 0$
 $\therefore y^2 - 10y + 25 = 1$
 $\therefore y - 5 = \pm 1$
 $\therefore y = 4; 6$

Distance between M and N is 2

27 B Distance between $(-4, -3)$ and $(-5, -10)$
 $= \sqrt{(-4 - (-5))^2 + (-3 - (-10))^2}$
 $= \sqrt{1 + 49} = 5\sqrt{2}$

28 D $y = x^2 + 4x - 3$ cuts the line
 $y = 4 - 2x$ at
 $x^2 + 4x - 3 = 4 - 2x$
 $\therefore x^2 + 6x - 7 = 0$
 $\therefore (x + 7)(x - 1) = 0$

$x = -7, y = 18$ and $x = 1, y = 2$
 Distance between $(-7, 18)$ and $(1, 2)$
 $= \sqrt{(-7 - 1)^2 + (18 - 2)^2}$
 $= \sqrt{8^2 + 16^2} = \sqrt{320}$

29 D $\{(x, y): y \leq 2x + 3\}$
A $(1, 4): 4 < 5$ \checkmark
B $(-1, 1): 1 = 1$ \checkmark
C $\left(\frac{1}{2}, 3\frac{1}{2}\right): 3\frac{1}{2} < 4$ \checkmark
D $\left(-\frac{1}{2}, 2\frac{1}{2}\right): 2\frac{1}{2} > 2$ **X**
E $(2, 5): 5 < 7$ \checkmark

30 B $y = k + 2x - x^2$
 If the graph touches the x -axis then
 $\Delta = 0$:
 $\Delta = 4 + 4k = 0, \therefore k = -1$

31 C Perpendicular lines have gradients which multiply to -1 :
 $kx + y - 4 = 0, \therefore y = 4 - kx$
 $x - 2y + 3 = 0, \therefore y = \frac{x + 3}{2}$
 $\therefore (-k)\left(\frac{1}{2}\right) = -1, \therefore k = 2$

32 A $y = x^2 + k$ and $y = x$
 $\therefore x^2 + k = x$
 $\therefore x^2 - x + k = 0$

For 1 solution $\Delta = 0$:
 $\Delta = 1 - 4k = 0, \therefore k = \frac{1}{4}$

33 C Circle with centre at $(-4, 2)$:
 $\therefore (x + 4)^2 + (y - 2)^2 = r^2$
 Circle touches the y -axis so $r = 4$:
 $\therefore x^2 + 8x + 16 + y^2 - 4y + 4 = 16$
 $\therefore x^2 + 8x + y^2 - 4y + 4 = 0$

34 A $2x - y + 3 = 0$ has gradient = 2.
If $ax + 3y - 1 = 0$ is parallel, its
gradient = 2

$$\therefore 3y = 1 - ax$$

$$\therefore y = \frac{1 - ax}{3}$$

$$\therefore -\frac{a}{3} = 2, \therefore a = -6$$

35 B $f(x) = \sqrt{4 - x^2}$ has max. dom.
[-2, 2]

36 C $f(x) = 2x^2 + 3x + 4$

$$= 2\left(x^2 + \frac{3}{2}x + 2\right)$$

$$= 2\left(x + \frac{3}{4} + \frac{9}{16} + \frac{23}{16}\right)$$

$$= 2\left(x + \frac{3}{4}\right)^2 + \frac{23}{8}$$

$$\text{Range} = \left[\frac{23}{8}, \infty\right)$$

37 D $P(x) = x^3 - kx^2 - 10kx + 25$
 $P(2) = 8 - 4k - 20k + 25 = 9$
 $\therefore 24k = 24, \therefore k = 1$

38 E $f(x) = x^2 - 7x + k$
 $f(k) = k^2 - 7k + k = -9$
 $\therefore k^2 - 6k + 9 = 0$
 $\therefore (k - 3)^2 = 0, \therefore k = 3$
 $\therefore f(x) = x^2 - 7x + 3$
 $\therefore f(-1) = 1 + 7 + 3 = 11$

39 E $2xy - x^2 - y^2$
 $= -(x^2 - 2xy + y^2)$
 $= -(x - y)^2$

40 C $x^2 - x - 12 \leq 0$
 $\therefore (x - 4)(x + 3) \leq 0$

Upright parabola so $-3 \leq x \leq 4$

41 C $f(x) = \frac{1}{2}x(x - 1)$
 $\therefore f(x) - f(x + 1)$
 $= \frac{1}{2}x(x - 1) - \frac{1}{2}x(x + 1)$
 $= \frac{x}{2}((x - 1) - (x + 1))$
 $= \frac{x}{2}(-2) = -x$

42 C $2x^2 - 2 \leq 0$
 $\therefore x^2 \leq 1, \therefore -1 \leq x \leq 1$

43 A $f(x) = -2\left(\left(x - \frac{1}{2}\right)^2 - 3\right)$
 $= 6 - 2\left(x - \frac{1}{2}\right)^2$
Inverted parabola so max. value = 6

Solutions to extended-response questions

1 a $x^2 + y^2 + bx + cy + d = 0$

At $(-4, 5)$, $16 + 25 - 4b + 5c + d = 0$

$$\therefore 4b - 5c - d = 41 \quad (1)$$

At $(-2, 7)$, $4 + 49 - 2b + 7c + d = 0$

$$\therefore 2b - 7c - d = 53 \quad (2)$$

At $(4, -3)$, $16 + 9 + 4b - 3c + d = 0$

$$\therefore -4b + 3c - d = 25 \quad (3)$$

b TI: Press **Menu**→**3:Algebra**→**7:Solve System of Equations**→**1:Solve System of Equations**

Change the number of equations to 3 and change the variables to b,c, d

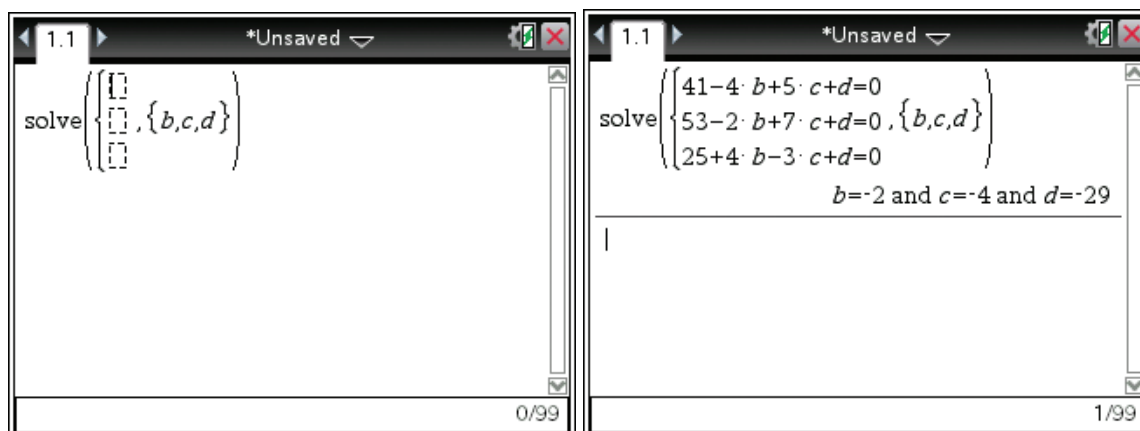

Type the equations from part a into the empty boxes then ENTER to yield $b = -2, c = -4$ and $d = -29$

CP: Type **solve** (**{41 - 4 × b + 5 × c + d = 0, 53 - 2 × b + 7 × c + d = 0, 25 + 4 × b - 3 × c + d = 0}**, **{b,c,d}**) then EXE

Therefore the equation of the circle is $x^2 + y^2 - 2x - 4y - 29 = 0$

2 a $x^2 + y^2 + bx + cy = 0$ (1)

At $(4, 4)$, $16 + 16 + 4b + 4c = 0$

$$\therefore 32 + 4b + 4c = 0$$

$$\therefore 4c = -4b - 32$$

$$\therefore c = -b - 8 \quad (2)$$

b To find the x -axis intercept, let $y = 0$ in equation (1),

$$\begin{aligned} \therefore x^2 + bx &= 0 \\ \therefore x(x + b) &= 0 \\ \therefore x = 0 \text{ or } x &= -b \end{aligned}$$

c i To find the y -axis intercept, let $x = 0$ in equation (1),

$$\begin{aligned} \therefore y^2 + cy &= 0 \\ \therefore y(y + c) &= 0 \\ \therefore y(y - b - 8) &= 0 \quad \text{from (2)} \\ \therefore y = 0 \text{ or } y &= b + 8 \end{aligned}$$

ii The circle touches the y -axis when there is one y -axis intercept, i.e. when $b + 8 = 0$, or $b = -8$.

3 a For $f(x) = \sqrt{a - x}$, the maximal domain is $x \leq a$.

b At the point of intersection, $\sqrt{a - x} = x$

$$\begin{aligned} \therefore a - x &= x^2 \\ \therefore x^2 + x - a &= 0 \end{aligned}$$

Using the general quadratic formula, $x = \frac{-1 \pm \sqrt{1 + 4a}}{2}$.

Since the range of $f(x)$ is $[0, \infty)$, the point of intersection of the graphs of $y = f(x)$

and $y = x$ is $\left(\frac{-1 + \sqrt{1 + 4a}}{2}, \frac{-1 + \sqrt{1 + 4a}}{2}\right)$.

c When $\left(\frac{-1 + \sqrt{1 + 4a}}{2}, \frac{-1 + \sqrt{1 + 4a}}{2}\right) = (1, 1)$,

$$\frac{-1 + \sqrt{1 + 4a}}{2} = 1$$

$$\therefore -1 + \sqrt{1 + 4a} = 2$$

$$\therefore \sqrt{1 + 4a} = 3$$

$$\therefore 1 + 4a = 9$$

$$\therefore 4a = 8$$

$$\therefore a = 2$$

d When $\left(\frac{-1 + \sqrt{1 + 4a}}{2}, \frac{-1 + \sqrt{1 + 4a}}{2}\right) = (2, 2)$,

$$\frac{-1 + \sqrt{1 + 4a}}{2} = 2$$

$$\therefore -1 + \sqrt{1 + 4a} = 4$$

$$\therefore \sqrt{1 + 4a} = 5$$

$$\therefore 1 + 4a = 25$$

$$\therefore 4a = 24$$

$$\therefore a = 6$$

e When $\left(\frac{-1 + \sqrt{1 + 4a}}{2}, \frac{-1 + \sqrt{1 + 4a}}{2}\right) = (c, c)$,

$$\frac{-1 + \sqrt{1 + 4a}}{2} = c$$

$$\therefore -1 + \sqrt{1 + 4a} = 2c$$

$$\therefore \sqrt{1 + 4a} = 2c + 1$$

$$\therefore 1 + 4a = (2c + 1)^2$$

$$\therefore 1 + 4a = 4c^2 + 4c + 1$$

$$\therefore 4a = 4c^2 + 4c$$

$$\therefore a = c^2 + c$$

4 a $C = 3500 + 10.5x$

b $I = 11.5x$

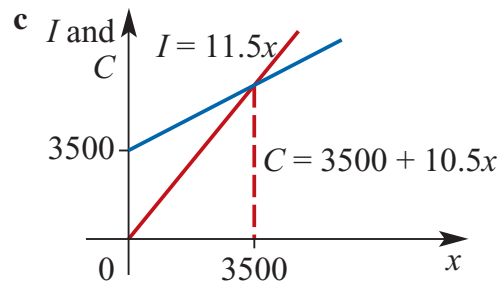

d $I = C$

$$\therefore 11.5x = 3500 + 10.5x$$

$$\therefore x = 3500$$

e $P = I - C$
 $= 11.5x - (3500 + 10.5x)$
 $= x - 3500$
 $P = \text{profit}$

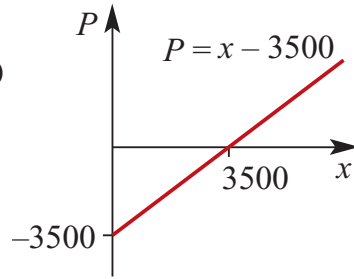

f $P = 2000$
 $\therefore x - 3500 = 2000 \quad \therefore x = 5500$
 5500 plates must be sold for a profit of \$2000 to be made.

5 a $V = 45\,000 + 40m$

b $45\,000 + 40m = 55\,000$

$\therefore m = \frac{10\,000}{40} = 250$

$250 \text{ min} = 4\text{h } 10 \text{ min}$

The pool will reach its maximum capacity after 4 hours 10 minutes.

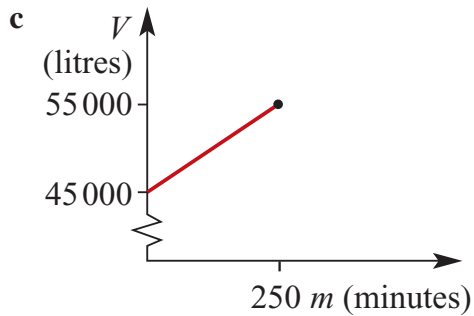

6 a When $t = 10$, $V = 20 \times 10 = 200$ litres.

b For uniform rate, the gradient of the graph is given by the rate.

Hence, $a = 20$

When $t = 10$, $V = 200$ and $b = 15$

Thus $V = bt + c$ gives

$$200 = 15 \times 10 + c, \therefore c = 50$$

and
$$V = \begin{cases} 20t & 0 \leq t \leq 10 \\ 15t + 50 & 10 < t \leq \frac{190}{3} \end{cases}$$

Note: $d = \frac{190}{3}$ as $15t + 50 = 1000$

$$\Rightarrow 15t = 950$$

$$\Rightarrow t = \frac{190}{3}$$

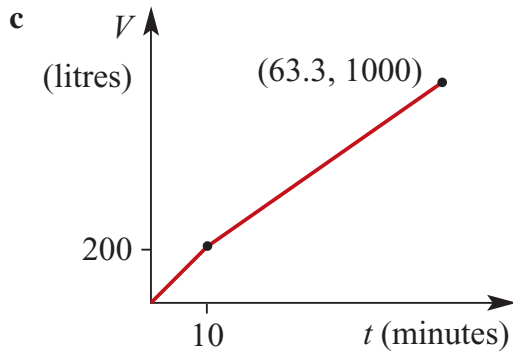

7 a For rectangle, length = $3x$ cm, width = $2x$ cm, area = $6x^2$ cm²

b Side length of square = $\frac{1}{4}(42 - 10x)$

$$= \frac{1}{2}(21 - 5x) \text{ cm}$$

$$\text{Area of square} = \left(\frac{1}{2}(21 - 5x)\right)^2$$

$$= (10.5 - 2.5x)^2 \text{ cm}^2$$

c $0 \leq 10x \leq 42$

$$\therefore 0 \leq x \leq 4.2$$

$$\begin{aligned}
 \text{d} \quad A_T &= 6x^2 + (10.5 - 2.5x)^2 \\
 &= 6x^2 + \frac{25}{4}x^2 - \frac{105}{2}x + \frac{441}{4} \\
 &= \frac{49}{4}x^2 - \frac{105}{2}x + \frac{441}{4} \\
 &= \frac{49}{4} \left(x^2 - \frac{4}{49} \times \frac{105}{2}x + \frac{4}{49} \times \frac{441}{4} \right) \\
 &= \frac{49}{4} \left(x^2 - \frac{30}{7}x + \left(\frac{15}{7} \right)^2 - \frac{225}{49} + \frac{441}{49} \right) \\
 \therefore A_T &= \frac{49}{4} \left(x - \frac{15}{7} \right)^2 + \frac{49}{4} \times \frac{216}{49} \\
 \therefore A_T &= \left(\frac{49}{4} \left(x - \frac{15}{7} \right)^2 + 54 \right) \text{cm}^2, \text{ or } : A = (12.25x^2 - 52.5x + 110.25) \text{cm}^2
 \end{aligned}$$

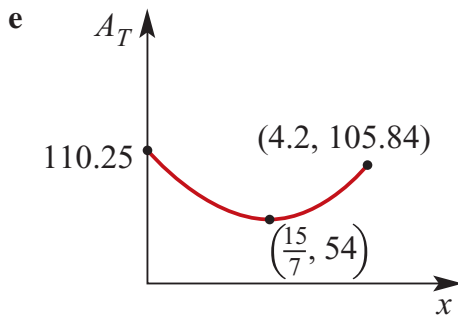

f Maximum total area = 110.25 cm² (area of rectangle equals zero)

$$\begin{aligned}
 \text{g} \quad & \frac{49}{4}x^2 - \frac{105}{2}x + \frac{441}{4} = 63 \\
 \therefore & \frac{49}{4}x^2 - \frac{105}{2}x + \frac{441}{4} - \frac{252}{4} = 0 \\
 \therefore & \frac{49}{4}x^2 - \frac{105}{2}x + \frac{189}{4} = 0 \\
 \therefore & 49x^2 - 210x + 189 = 0 \\
 \therefore & 7(7x^2 - 30x + 27) = 0 \\
 \therefore & 7(7x - 9)(x - 3) = 0 \\
 \therefore & x = \frac{9}{7} \text{ or } x = 3
 \end{aligned}$$

When $x = \frac{9}{7}$, the rectangle has dimensions $3x = \frac{27}{7} \approx 3.9$ and $2x = \frac{18}{7} \approx 2.6$,
 i.e. 3.9 cm \times 2.6 cm, and the square has dimensions $\frac{1}{2} \left(21 - 5 \times \frac{9}{7} \right) = \frac{51}{7} \approx 7.3$,
 i.e. 7.3 cm \times 7.3 cm.

When $x = 3$, the rectangle has dimensions $3x = 9$ and $2x = 6$,
 i.e. $9 \text{ cm} \times 6 \text{ cm}$, and the square has dimensions $\frac{1}{2}(21 - 5 \times 3) = 3$,
 i.e. $3 \text{ cm} \times 3 \text{ cm}$.

8 $y = -\frac{1}{10}(x + 10)(x - 20), x \geq 0$

a When $x = 0$, $y = -\frac{1}{10}(10)(-20)$
 $= 20\text{m}$, the height at the point of projection.

b When $y = 0$, $x = 20 \text{ m}$, the horizontal distance travelled, ($x \neq -10$ as $x \geq 0$).

c $y = -\frac{1}{10}(x^2 - 10x - 200)$
 $= -\frac{1}{10}(x^2 - 10x + 25 - 225)$
 $= -\frac{1}{10}(x - 5)^2 + 22.5$

When $x = 5$, $y = 22.5 \text{ m}$, the maximum height reached by the stone.

9 a If height = $x \text{ cm}$, width = $(x + 2) \text{ cm}$, length = $2(x + 2) \text{ cm}$

$$\begin{aligned} A &= 2x(x + 2) + 2x \times 2(x + 2) + 2(x + 2) \times 2(x + 2) \\ &= 2x^2 + 4x + 4x^2 + 8x + 4x^2 + 16x + 16 \\ &= 10x^2 + 28x + 16 \end{aligned}$$

b i When $x = 1$, $A = 10(1)^2 + 28(1) + 16$
 $= 10 + 28 + 16$
 $= 54 \text{ cm}^2$

ii When $x = 2$, $A = 10(2)^2 + 28(2) + 16$
 $= 40 + 56 + 16$
 $= 112 \text{ cm}^2$

$$\begin{aligned}
 \mathbf{c} \quad & 10x^2 + 28x + 16 = 190 \\
 \therefore & 10x^2 + 28x - 174 = 0 \\
 \therefore & 2(5x^2 + 14x - 87) = 0 \\
 \therefore & (5x + 29)(x - 3) = 0 \\
 \therefore & x = \frac{-29}{5} \text{ or } 3 \\
 \text{But } x > 0, & \quad \therefore x = 3 \text{ cm}
 \end{aligned}$$

$$\mathbf{d} \quad A = 10x^2 + 28x + 16$$

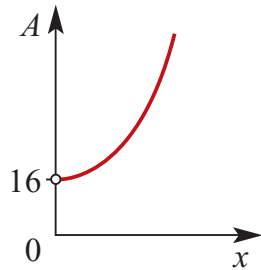

$$\begin{aligned}
 \mathbf{e} \quad V &= 2(x + 2)x(x + 2) \\
 &= 2x(x + 2)^2 \\
 &= 2x(x^2 + 4x + 4) \\
 &= 2x^3 + 8x^2 + 8x
 \end{aligned}$$

$$\mathbf{f} \quad 2x^3 + 8x^2 + 8x = 150$$

$$\therefore 2x^3 + 8x^2 + 8x - 150 = 0$$

$$P(0) = -150 \qquad \neq 0$$

$$\begin{aligned}
 P(1) &= 2(1)^3 + 8(1)^2 + 8(1) - 150 \\
 &= -132 \qquad \neq 0
 \end{aligned}$$

$$\begin{aligned}
 P(2) &= 2(2)^3 + 8(2)^2 + 8(2) - 150 \\
 &= 16 + 32 + 16 - 150 \\
 &= -86 \qquad \neq 0
 \end{aligned}$$

$$\begin{aligned}
 P(3) &= 2(3)^3 + 8(3)^2 + 8(3) - 150 \\
 &= 54 + 72 + 24 - 150 \\
 &= 0
 \end{aligned}$$

$\therefore (x - 3)$ is a factor of $2x^3 + 8x^2 + 8x - 150$

When $V = 150$, $x = 3$

$$\begin{array}{r}
 2x^2 + 14x + 50 \\
 x - 3 \overline{) 2x^3 + 8x^2 + 8x - 150} \\
 \underline{2x^3 - 6x^2} \\
 14x^2 + 8x - 150 \\
 \underline{14x^2 - 42x} \\
 50x - 150 \\
 \underline{50x - 150} \\
 0
 \end{array}$$

$$\therefore 2x^3 + 8x^2 + 8x - 150 = (x - 3)(2x^2 + 14x + 50)$$

$$\text{But } 2x^2 + 14x + 50 \neq 0$$

$$\begin{aligned}
 \text{as } \Delta &= 196 - 400 \\
 &= -204 < 0
 \end{aligned}$$

$$\therefore x = 3$$

g The answer can be found using a CAS calculator.

Input $Y_1 = 2X^3 + 8X^2 + 8X$ and $Y_2 = 1000$.

The point of intersection is (6.6627798, 1000). Therefore the volume of the block is 1000 cm^3 when $x = 6.66$, correct to 2 decimal places.

10 a i $A = 10y + (y - x)x$
 $= 10y + yx - x^2$

ii $P = 2y + 20 + 2x$
 $= 2(y + 10 + x)$

b i If $P = 100$

$$100 = 2(y + 10 + x)$$

$$\therefore 50 = y + 10 + x$$

$$\therefore y = 40 - x$$

$$\begin{aligned} \therefore A &= (10 + x)(40 - x) - x^2 \\ &= 400 + 30x - x^2 - x^2 \\ &= 400 + 30x - 2x^2 \end{aligned}$$

ii $A = -2(x^2 - 15x - 200)$
 $= -2\left(x^2 - 15x + \frac{225}{4} - 200 - \frac{225}{4}\right)$

$$\begin{aligned} \therefore A &= -2\left(\left(x - \frac{15}{2}\right)^2 - \frac{1025}{4}\right) \\ &= -2\left(x - \frac{15}{2}\right)^2 + \frac{1025}{2} \end{aligned}$$

$$\begin{aligned} \therefore \text{maximum possible area} &= \frac{1025}{2} \text{ m}^2 \\ &= 512.5 \text{ m}^2 \end{aligned}$$

iii $A > 0$ and $y > 0$ and $x \geq 0$ and $y - x \geq 0$

Considering the last inequality,

$$y \geq x$$

\therefore

$$40 - x \geq x$$

\therefore

$$x \leq 20$$

As $x \geq 0$, the largest possible domain is

$$0 \leq x \leq 20.$$

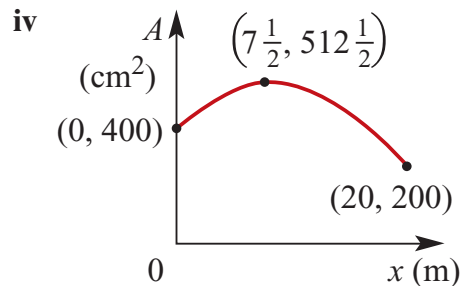

11 a Let: $A_T(\text{m}^2)$ be the total area of the window.

$$\begin{aligned}A_T &= (2x + y)(3x + 2y) \\ &= 6x^2 + 7xy + 2y^2\end{aligned}$$

b Let $A_W(\text{m}^2)$ be the total area of the dividing wood.

$$\begin{aligned}A_W &= xy + xy + xy + xy + xy + xy + xy + y^2 + y^2 \\ &= 7xy + 2y^2\end{aligned}$$

c i Area of glass, $A_G = 1.5$

$$\therefore 6x^2 = 1.5$$

$$\therefore x^2 = \frac{3}{2} \times \frac{1}{6} = \frac{1}{4}$$

$$\therefore x = \frac{1}{2} \text{ or } 0.5 \text{ (as } x \geq 0\text{)}$$

ii Area of wood, $A_w = 1$

$$\therefore 7xy + 2y^2 = 1$$

$$\text{As } x = \frac{1}{2}, 7 \times \frac{1}{2} \times y + 2y^2 - 1 = 0$$

$$\therefore 2y^2 + \frac{7}{2}y - 1 = 0$$

$$\therefore 4y^2 + 7y - 2 = 0$$

$$\therefore (4y - 1)(y + 2) = 0$$

$$\therefore y = \frac{1}{4} \text{ or } y = -2$$

$$\text{But } y > 0, \quad \therefore y = \frac{1}{4} = 0.25$$

12 a $h(3) = -4.9(3)^2 + 30(3) + 5$

$$= -4.9(9) + 90 + 5$$

$$= -44.1 + 95 = 50.9$$

The drop will be at a height of 50.9 m after 3 seconds.

$$\mathbf{b} \quad -4.9t^2 + 30t + 5 = 5$$

$$\therefore -4.9t^2 + 30t = 0$$

$$\therefore t(30 - 4.9t) = 0$$

$$\therefore t = 0 \quad \text{or} \quad 30 - 4.9t = 0$$

$$\therefore 4.9t = 30$$

$$\therefore t \approx 6.12$$

The drop will be back at the spout height after approximately 6.12 seconds.

$$\begin{aligned} \mathbf{c} \text{ Turning point at } x &= \frac{-b}{2a} \\ &= \frac{-30}{2(-4.9)} = \frac{300}{98} \\ &= \frac{150}{49} \\ &\approx 3.06 \end{aligned}$$

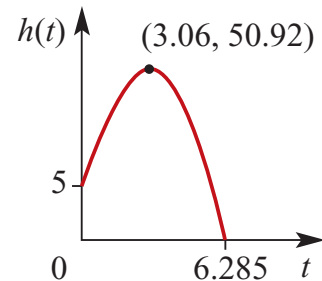

$$\begin{aligned} h\left(\frac{150}{49}\right) &= -4.9\left(\frac{150}{49}\right)^2 + 30\left(\frac{150}{49}\right) + 5 \\ &= \frac{2495}{49} \approx 50.92 \end{aligned}$$

$$\begin{aligned} \mathbf{d} \text{ When } h(t) = 0, \quad t &= \frac{-30 \pm \sqrt{(30)^2 - 4(-4.9)(5)}}{2(-4.9)} \\ &= \frac{-30 \pm \sqrt{900 + 98}}{-9.8} \\ &\approx \frac{-30 \pm 31.59}{-9.8} \\ &\approx \frac{-61.59}{-9.8} \text{ or } \frac{1.59}{-9.8} \approx 6.285 \text{ or } -0.162 \end{aligned}$$

$$\text{But as } t \geq 0 \quad t = 6.285$$

It will take a drop of water 6.285 seconds to hit the ground.

13 a height = 7 cm, breadth = x cm, length = $(x + 5)$ cm

$$\begin{aligned} \mathbf{b} \quad V &= 7x(x + 5) \\ &= 7x^2 + 35x \end{aligned}$$

$$\begin{aligned}
 \text{c } S &= 7x + 7x + 7(x + 5) + 7(x + 5) + x(x + 5) \\
 &= 14x + 14x + 70 + x^2 + 5x \\
 &= x^2 + 33x + 70
 \end{aligned}$$

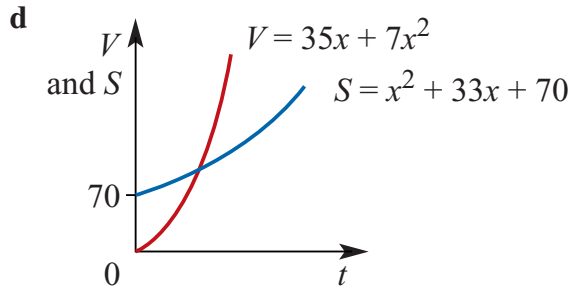

$$\text{e Let } S = V, \therefore x^2 + 33x + 70 = 7x^2 + 35x$$

$$\therefore 6x^2 + 2x - 70 = 0$$

$$\begin{aligned}
 \therefore x &= \frac{-2 \pm \sqrt{4 - 4(6)(-70)}}{12} \\
 &= \frac{-2 \pm \sqrt{1684}}{12} \\
 &= \frac{-2 \pm 41.0366}{12} \\
 &= -3.59, 3.25
 \end{aligned}$$

$$\text{But } x \geq 0$$

$\therefore V = S$ when $x = 3.25$, correct to 2 decimal places.

$$\text{f Let } S = 500, \therefore x^2 + 33x + 70 = 500$$

$$\therefore x^2 + 33x - 430 = 0$$

$$\therefore (x - 10)(x + 43) = 0$$

$$\therefore x = 10 \text{ or } x = -43$$

$$\text{But } x \geq 0, \therefore x = 10$$

$$\text{14 a Midpoint of } AC = \left(\frac{1+7}{2}, \frac{3+7}{2} \right) = (4, 5)$$

$$\text{Gradient of } AC = \frac{7-3}{7-1} = \frac{4}{6} = \frac{2}{3}$$

$$\text{Gradient of a line perpendicular to } AC = \frac{-1}{\frac{2}{3}} = \frac{-3}{2}$$

Equation of perpendicular bisector of AC

$$y - 5 = \frac{-3}{2}(x - 4) = \frac{-3x}{2} + 6$$

$$\therefore 2y + 3x = 22$$

- b i** When $x = 0, y = 11$
 $\therefore B$ has coordinates $(0, 11)$

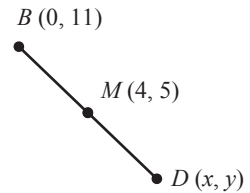

- ii** $x = 2 \times 4 - 0 = 8$
 $y = 2 \times 5 - 11 = -1$
 D has coordinates $(8, -1)$

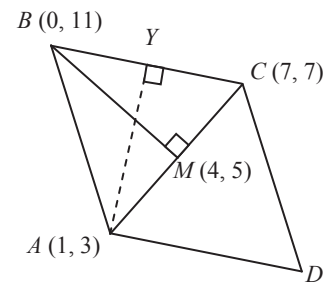

c Area = length $AC \times$ length BM

$$= \sqrt{6^2 + 4^2} \times \sqrt{4^2 + 6^2}$$

$$= \sqrt{52} \times \sqrt{52}$$

$$= 52 \text{ units}^2$$

d Area $\triangle ABC = \frac{1}{2}$ area of the rhombus

$$= 26 \text{ units}^2$$

$$\text{Area } \triangle ABC = \frac{1}{2} BC \times AY$$

So $AY = \frac{2 \times 26}{BC}$

$$= \frac{52}{\sqrt{7^2 + 4^2}}$$

$$= \frac{52}{\sqrt{65}}$$

$$\approx 6.45$$

The length of AY (the perpendicular distance of A from BC) ≈ 6.45 units.

15 a Let x hours be the time for the first journey, $\therefore V = \frac{300}{x}$.

The time for the second journey = $(x - 2)$ hours

$$\therefore V + 5 = \frac{300}{x - 2}$$

$$\therefore \frac{300}{x} + 5 = \frac{300}{x - 2}$$

$$\therefore \left(\frac{300}{x} + 5\right)(x - 2) = 300$$

$$\therefore 300 + 5x - \frac{600}{x} - 10 = 300$$

$$\therefore 5x^2 - 600 - 10x = 0$$

$$\therefore 5x^2 - 10x - 600 = 0$$

$$\therefore 5(x^2 - 2x - 120) = 0$$

$$\therefore (x - 12)(x + 10) = 0$$

$$\therefore x = 12 \text{ or } x = -10$$

But $x \geq 0$, $\therefore x = 12$

$$\therefore V = \frac{300}{12} = 25$$

The speed of the train travelling at the slower speed is 25 km/h.

b Let t_A minutes be the time it takes tap A to fill the tank, and t_B minutes be the time it takes tap B to fill the tank. $t_B = t_A + 15$

When the taps are running together, it takes $33\frac{1}{3}$ minutes to fill the tank.

Let R_A units/min be the rate of flow of tap A, and R_B units/min be the rate of flow of tap B.

$$\text{Volume to be filled} = \frac{100}{3}R_A + \frac{100}{3}R_B$$

$$R_A = \frac{\text{volume to be filled}}{t_A}$$

$$R_B = \frac{\text{volume to be filled}}{t_B}$$

Let V be the volume to be filled.

$$V = \frac{100}{3} \times \frac{V}{t_A} + \frac{100}{3} \times \frac{V}{t_B}$$

$$\therefore \frac{3}{100} = \frac{1}{t_A} + \frac{1}{t_A + 15}$$

$$\therefore 3(t_A + 15)t_A = 100(t_A + 15) + 100t_A$$

$$\therefore 3t_A^2 + 45t_A = 200t_A + 1500$$

$$\text{i.e. } 3t_A^2 - 155t_A - 1500 = 0$$

$$t_A = \frac{155 \pm \sqrt{42025}}{6}$$

$$\therefore = \frac{155 \pm 205}{6} = 60 \text{ or } \frac{-25}{3}$$

Tap A takes 60 minutes to fill the tank by itself.

Tap B takes 75 minutes to fill the tank by itself.

c Let x cm be the length of a side of a square tile.

Let A be the floor area of the hall.

$$\text{Then } A = 200x^2$$

$$\text{and } A = 128(x + 1)^2$$

$$\therefore 200x^2 = 128x^2 + 256x + 128$$

$$\therefore 72x^2 - 256x - 128 = 0$$

$$\therefore 8(9x^2 - 32x - 16) = 0$$

$$\therefore 8(9x + 4)(x - 4) = 0$$

$$\therefore x = \frac{-4}{9} \text{ or } x = 4$$

$$\text{But } x \geq 0, \therefore x = 4$$

The smaller tiles are (4×4) cm² and the larger tiles are (5×5) cm².

16 a $4(x + 2x + h) = 400$

$$\therefore 3x + h = 100$$

$$\therefore h = 100 - 3x$$

b $V = x \times 2x \times h$

$$= 2x^2(100 - 3x)$$

c When $V = 0$, $2x^2(100 - 3x) = 0$

$$\therefore x = 0 \text{ or } x = \frac{100}{3}$$

Now $V > 0$, $\therefore 0 < x < \frac{100}{3}$

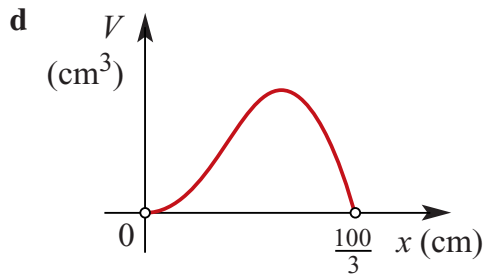

e i On a CAS calculator, set $f1=2x^2(100-3x)$ and $f2=30\,000$. The points of intersection are $(18.142, 30\,000)$ and $(25.852, 30\,000)$, correct to 3 decimal places. Thus volume is $30\,000 \text{ cm}^3$ when $x = 18.142$ or $x = 25.852$, correct to 3 decimal places.

ii Repeat e i, using $f2 = 20\,000$. Volume is $20\,000 \text{ cm}^3$ when $x = 12.715$ or $x = 29.504$, correct to 3 decimal places.

f TI: Press **Menu** \rightarrow **6:Analyze Graph** \rightarrow **3:Maximum**

CP: Tap **Analysis** \rightarrow **G-Solve** \rightarrow **Max**

g i $S = 2(x \times 2x + x \times h + 2x \times h)$

$$= 2(2x^2 + x(100 - 3x) + 2x(100 - 3x))$$

$$= 2(2x^2 + 100x - 3x^2 + 200x - 6x^2)$$

$$= 2(300x - 7x^2)$$

$$= 600x - 14x^2$$

ii On a CAS calculator, sketch $f_1 = 600x - 14x^2$.

TI: Press **Menu** → 6: **Analyze Graph** 3: **Maximum**

CP: Tap **Analysis** → **G-Solve** → **Max**

h Sketch $f_1 = 600x - 14x^2$ and $f_2 = 2x^2(100 - 3x)$ on a CAS calculator. The points of intersection are (3.068, 1708.802) and (32.599, 4681.642). Therefore $S = V$ when $x \approx 3.068$ or $x \approx 32.599$.

17 a **TI:** Press **Menu** → 1: **Actions** → 1: **Define** then type $f(x) = a \times x^3 + b \times x^2 + c \times x + d$ followed by ENTER.

Now type the following then press ENTER

solve ($f(0)=0$ and $f(100)=33$ and $f(50)=57$ and $f(150) = -15$, $\{a, b, c, d\}$)

CP: Tap **Action** → **Command** → **Define** then type $f(x) = a \times x^3 + b \times x^2 + c \times x + d$ followed by EXE.

Now type the following then press EXE

solve ($\{f(0)=0, f(100)=33, f(50)=57, f(150) = -15\}, \{a, b, c, d\}$)

The screen gives $a = \frac{19}{250\,000} = 7.6 \times 10^{-5}$, $b = -\frac{69}{2500} = 0.0276$, $c = \frac{233}{100} = 2.33$ and $d = 0$.

Therefore the function which passes through the given points is

$$y = (7.6 \times 10^{-5})x^3 - 0.0276x^2 + 2.33x.$$

b $y = (7.6 \times 10^{-5})x^3 - 0.0276x^2 + 2.33x + 5$

c On a CAS calculator, sketch $f_1 = 19/250\,000x^3 - 69/2500x^2 + 2.33x$.

TI: Press **Menu** → 6: **Analyze Graph** → 3: **Maximum**

CP: Tap **Analysis** → **G-Solve** → **Max**

which yields (54.461038, 57.31899). The largest deviation from the x -axis is 57.31 metres, perpendicular to the x -axis and correct to 2 decimal places.

18 a The equation of BC is $y = \frac{3}{4}x - 4$

b The equation of AD is $y - 6 = -\frac{4}{3}(x - 5) = -\frac{4}{3}x + \frac{20}{3}$

$$\therefore y = -\frac{4}{3}x + \frac{38}{3} \text{ or } 3y + 4x = 38$$

c D is on the lines $y = \frac{3}{4}x - 4$ and $3y + 4x = 38$

Substituting $y = \frac{3}{4}x - 4$ into $3y + 4x = 38$ gives

$$3\left(\frac{3}{4}x - 4\right) + 4x = 38$$

$$\therefore \frac{9}{4}x - 12 + 4x = 38$$

$$\therefore \frac{25}{4}x = 50$$

$$\therefore 25x = 200$$

$$\therefore x = 8$$

$$\therefore y = \frac{3}{4}(8) - 4$$

$$= 6 - 4$$

$$= 2$$

The coordinates of D are $(8, 2)$.

d Length of $AD = \sqrt{(8 - 5)^2 + (6 - 2)^2}$
 $= \sqrt{25}$
 $= 5$ units

e Area of $\triangle ABC = 2 \times$ area of $\triangle ABD$
 $= 2 \times \frac{1}{2} \times BD \times AD$
 $= \sqrt{(8 - 0)^2 + (2 - (-4))^2} \times 5$
 $= 5 \sqrt{64 + 36}$
 $= 5 \sqrt{100}$
 $= 50$ square units

19 a i $2y + 6x + 4x = 500$

$$\therefore y + 5x = 250$$

$$\therefore y = 5(50 - x)$$

$$\begin{aligned}
 \text{ii } V &= x \times x \times y \\
 &= x^2 \times 5(50 - x) \\
 &= 5x^2(50 - x)
 \end{aligned}$$

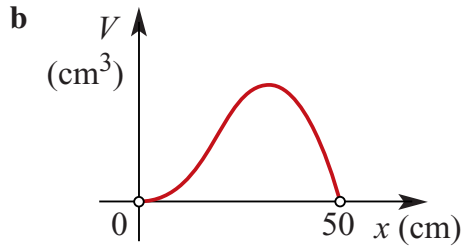

c Domain = $(0, 50)$

d Sketch $f_1=5x^2(50-x)$ and $f_2=25\,000$ on a CAS calculator. The points of intersection are $(11.378\,052, 25\,000)$ and $(47.812\,838, 25\,000)$.
Therefore $V = 25\,000$ for $x = 11.38$ and $x = 47.81$, correct to 2 decimal places.

e **TI:** Press **Menu** → **6:Analyze Graph** → **3:Maximum**

CP: Tap **Analysis** → **G-Solve** → **Max**

to yield the coordinates $(33.333\,331, 92\,592.593)$. Therefore the maximum volume is $92\,592.59\text{ cm}^3$ when $x = 33.33$, correct to 2 decimal places.

When $x = 33.333\dots$, $y = 5(50 - 33.333\dots) \approx 83.33$.

Chapter 9 – Probability

Solutions to Exercise 9A

- 1 Toss of a coin: sample space = $\{H, T\}$
- 2 Die rolled: sample space = $\{1, 2, 3, 4, 5, 6\}$
- 3 a 52 cards
- b 4 suits
- c Spades, hearts, diamonds, clubs
- d Hearts, diamonds = red; spades, clubs = black
- e 13 cards in each suit.
- f ‘Picture cards’ are Jack, Queen, King and Ace
- g 4 aces
- h 16 ‘picture cards’
- 4 a $\{0, 1, 2, 3, 4, 5\}$
- b $\{0, 1, 2, 3, 4, 5, 6\}$
- c $\{0, 1, 2, 3\}$
- 5 a $\{0, 1, 2, 3, 4, 5 \dots\}$
- b $\{0, 1, 2, 3, 4, 5 \dots 41\}$
- c $\{1, 2, 3, 4, 5 \dots\}$
- 6 a ‘An even number’ in die roll = $\{2, 4, 6\}$
- b ‘More than two female students’ = $\{FFF\}$
- c ‘More than four aces’ = $\{\}$ or \emptyset
- 7 $\varepsilon = \{1, 2, 3, \dots, 20\}$, $n(\varepsilon) = 20$
- a Let A be the event the number is divisible by 2.
 $A = \{2, 4, \dots, 20\}$, $n(A) = 10$,
 $\Pr(A) = \frac{n(A)}{n(\varepsilon)} = \frac{10}{20} = \frac{1}{2}$
- b Let B be the event the number is divisible by 3.
 $B = \{3, 6, \dots, 18\}$, $n(B) = 6$,
 $\Pr(B) = \frac{n(B)}{n(\varepsilon)} = \frac{6}{20} = \frac{3}{10}$
- c Let C be the event the number is divisible by both 2 and 3.
 $C = \{6, 12, 18\}$, $n(C) = 3$,
 $\Pr(C) = \frac{n(C)}{n(\varepsilon)} = \frac{3}{20}$
- 8 $\varepsilon = \{1, 2, 3, \dots, 15\}$, $n(\varepsilon) = 15$
- a Let A be the event the number is less than 5.
 $A = \{1, 2, 3, 4\}$, $n(A) = 4$,
 $\Pr(A) = \frac{n(A)}{n(\varepsilon)} = \frac{4}{15}$
- b Let B be the event the number is greater than or equal to 6.
 $B = \{6, 7, \dots, 15\}$, $n(B) = 10$,
 $\Pr(B) = \frac{n(B)}{n(\varepsilon)} = \frac{10}{15} = \frac{2}{3}$
- c Let C be the event the number is a

number from 5 to 8 inclusive.

$$C = \{5, 6, 7, 8\}, n(C) = 4,$$

$$\Pr(C) = \frac{n(C)}{n(\varepsilon)} = \frac{4}{15}$$

- 9 a** 13 clubs: $\Pr(\clubsuit) = \frac{13}{52} = \frac{1}{4}$
- b** 26 red cards: $\Pr(\text{red}) = \frac{26}{52} = \frac{1}{2}$
- c** 16 picture cards: $\Pr(\text{picture}) = \frac{16}{52} = \frac{4}{13}$
- d** a red picture card $\Pr(\text{red picture}) = \frac{8}{52} = \frac{2}{13}$

- 10 a** 36 cards < 10 : $\Pr(< 10) = \frac{36}{52} = \frac{9}{13}$
- b** 40 cards ≤ 10 : $\Pr(\leq 10) = \frac{40}{52} = \frac{10}{13}$
- c** Even number = $\{2, 4, 6, 8, 10\}$ so 20 evens: $\Pr(\text{even}) = \frac{20}{52} = \frac{5}{13}$
- d** 4 aces: $\Pr(\text{ace}) = \frac{4}{52} = \frac{1}{13}$

- 11 a** $\Pr(\text{29 November}) = \frac{1}{365}$
- b** $\Pr(\text{November}) = \frac{30}{365} = \frac{6}{73}$
- c** 30 days between 15 January and 15 February, not including either day:
 $\therefore \Pr = \frac{6}{73}$
- d** 90 (non-leap) days in the first three months of the year: $\therefore \Pr = \frac{90}{365} = \frac{18}{73}$

12 $\varepsilon = \{A_1, U, S, T, R, A_2, L, I, A_3\}$, $n(\varepsilon) = 9$

a $\Pr(\{T\}) = \frac{1}{9}$

b $\Pr(\text{an A is drawn}) = \Pr(\{A_1, A_2, A_3\}) = \frac{3}{9} = \frac{1}{3}$

c Let V be the event a vowel is drawn
 $V = \{A_1, A_2, A_3, U, I\}$, $n(V) = 5$
 $\Pr(V) = \frac{5}{9}$

d Let C be the event a consonant is drawn
 $C = \{S, T, R, L\}$, $n(C) = 4$
 $\Pr(C) = \frac{4}{9}$

13 $\Pr(1) + \Pr(2) + \Pr(3) + \Pr(5) + \Pr(6) + \Pr(4) = 1$
 $\therefore \frac{1}{12} + \frac{1}{6} + \frac{1}{8} + \frac{1}{6} + \frac{1}{8} + \Pr(4) = 1$
 $\frac{2 + 4 + 3 + 4 + 3}{24} + \Pr(4) = 1$
 $\therefore \Pr(4) = 1 - \frac{16}{24} = 1 - \frac{2}{3} = \frac{1}{3}$

14 $\Pr(1) = 0.2$, $\Pr(3) = 0.1$, $\Pr(4) = 0.3$
 $\Pr(1) + \Pr(3) + \Pr(4) = 0.6$
 $\therefore \Pr(2) = 1 - 0.6 = 0.4$

15 a $\Pr(1) = \frac{1}{3}$

b $\Pr(1) = \frac{1}{8}$

c $\Pr(1) = \frac{1}{4}$

16 $\varepsilon = \{M, T, W, Th, F, Sa, Su\}$ $n(\varepsilon) = 7$

a $\Pr(\text{Born on Wednesday}) = \frac{1}{7}$

b $\Pr(\text{Born on a weekend}) =$
 $\Pr(\{\text{Sa, Su}\}) = \frac{2}{7}$

$\Pr(\text{Not born on a weekend}) = 1 - \frac{2}{7} =$
 $\frac{5}{7}$

17 $n(\varepsilon) = 52$

a $n(\text{Club}) = 13$
 $\Pr(\text{Club}) = \frac{13}{52} = \frac{1}{4}$
 $\Pr(\text{Not Club}) = 1 - \frac{1}{4} = \frac{3}{4}$

b $n(\text{Red}) = 26$
 $\Pr(\text{Red}) = \frac{26}{52} = \frac{1}{2}$
 $\Pr(\text{Not Red}) = 1 - \frac{1}{2} = \frac{1}{2}$

c Picture cards are Kings, Queens and
 Jacks
 $n(\text{Picture Card}) = 12$
 $\Pr(\text{Picture Card}) = \frac{12}{52} = \frac{3}{13}$
 $\Pr(\text{Not Red}) = 1 - \frac{3}{13} = \frac{10}{13}$

d $n(\text{Red Picture}) = 6$
 $\Pr(\text{Red Picture}) = \frac{6}{52} = \frac{3}{26}$

$\Pr(\text{Not Red}) = 1 - \frac{3}{26} = \frac{23}{26}$

18 $\varepsilon = \{1, 2, 3, 4\}$

$\Pr(1) = \Pr(2) = \Pr(3) = x$ and
 $\Pr(4) = 2x.$

$\therefore x + x + x + 2x = 1$

$\therefore x = \frac{1}{5}$

$\therefore \Pr(1) = \Pr(2) = \Pr(3) = \frac{1}{5}$ and

$\Pr(4) = \frac{2}{5}$

19 $\varepsilon = \{1, 2, 3, 4, 5, 6\}$

a $\Pr(2) = \Pr(3) = \Pr(4) = \Pr(5) = x,$
 $\Pr(6) = 2x$ and $\Pr(1) = \frac{x}{2}.$
 $\therefore x + x + x + x + 2x + \frac{x}{2} = 1$

$\therefore \frac{13x}{2} = 1 \therefore x = \frac{2}{13}$

$\therefore \Pr(2) = \Pr(3) = \Pr(4) = \Pr(5) = \frac{2}{13}$

$\Pr(6) = \frac{4}{13}$ and $\Pr(1) = \frac{1}{13}$

b $\frac{9}{13}$

Solutions to Exercise 9B

1 a $\Pr(\text{head}) = \frac{34}{100} = \frac{17}{50} = 0.34$

b $\Pr(\text{ten}) = \frac{20}{200} = \frac{1}{10} = 0.10$

c $\Pr(\text{two heads}) = \frac{40}{150} = \frac{4}{15}$

d $\Pr(\text{three sixes}) = \frac{1}{200}$ or 0.005

2 a 20 trials is far too few to obtain reliable data.

b $\Pr(\text{two heads}) = \frac{1}{4}$, $\Pr(\text{one head}) = \frac{1}{2}$, $\Pr(\text{no heads}) = \frac{1}{4}$

c Results may resemble **b**, but could be anything with such a small sample.

d 100 trials is certainly better. For example, with 95% confidence limits, the number of (H, H) results over 20 trials would be between 1 and 9. Over 100 trials we would expect between 16 and 34.

e To find the probabilities exactly would require an infinite number of trials.

3 Die 1 shows $\Pr(6) = \frac{78}{500} = 0.156$

Die 2 shows $\Pr(6) = \frac{102}{700} = 0.146$

Die 1 has a higher observed probability of throwing a 6.

4 Total number of balls = 400; 340 red and 60 black.

Proportion of red = $\frac{340}{400} = \frac{17}{20} = 0.85$

b Proportion of red in sample = $\frac{48}{60} = \frac{4}{5} = 0.8$

c Proportion of red in sample = $\frac{54}{60} = \frac{9}{10} = 0.9$

d Expected number of red balls = $0.85 \times 60 = 51$

5 Estimate of probability = $\frac{890}{2000} = \frac{89}{200} = 0.445$

6 a Area of blue section = $\frac{\pi(1)^2}{4} = \frac{\pi}{4} \approx 0.7855$
Area of square = $1 \times 1 = 1$.
Proportion of square that is blue = $\frac{\pi}{4} \approx 0.7855$

b Probability of hitting the blue region = $\frac{\pi}{4} \approx 0.7855$

7 Area of board = $\pi(14)^2 = 196\pi$
Area of shaded region = $\pi(14)^2 - \pi(7)^2$
 $= 196\pi - 49\pi$
 $= 147\pi$

Probability that the dart will hit the shaded area = $\frac{147}{196} = \frac{3}{4}$

8 a $\Pr(\text{Red section}) = \frac{120}{360} = \frac{1}{3}$

b $\Pr(\text{Yellow section}) = \frac{60}{360} = \frac{1}{6}$

$$\mathbf{c} \quad \text{Pr(Not Yellow section)} = 1 - \frac{1}{6} = \frac{5}{6}$$

$$\mathbf{9} \quad \text{Area of square} = 1 \text{ m}^2.$$

$$\text{Area of circle} = \pi \times 0.4^2 = 0.16\pi$$

$$\mathbf{a} \quad \text{Probability of hitting the shaded part} \\ = 0.16\pi$$

$$\mathbf{b} \quad \text{Probability of hitting the unshaded} \\ \text{part} = 0.84\pi$$

$$\mathbf{10} \quad \mathbf{a} \quad \mathbf{i} \quad \text{Area of square} = x^2$$

$$\mathbf{ii} \quad \text{Area of larger circle}$$

$$= \pi\left(\frac{x}{2}\right)^2 = \frac{1}{4}\pi x^2$$

$$\mathbf{iii} \quad \text{Area of smaller circle}$$

$$= \pi\left(\frac{x}{4}\right)^2 = \frac{1}{16}\pi x^2$$

$$\mathbf{b} \quad \mathbf{i} \quad \text{Probability of landing inside the} \\ \text{smaller circle} = \frac{\frac{1}{16}\pi x^2}{x^2} = \frac{\pi}{16}$$

$$\mathbf{ii} \quad \text{Probability of landing inside the} \\ \text{smaller circle} = \frac{(\frac{1}{4} - \frac{1}{16})\pi x^2}{x^2} = \frac{3\pi}{16}$$

$$\mathbf{iii} \quad \text{Probability of land-} \\ \text{ing in the outer shaded}$$

$$\text{region} = \frac{x^2 - \frac{1}{4}\pi x^2}{x^2} = 1 - \frac{\pi}{4}$$

Solutions to Exercise 9C

1 $\varepsilon = \{HH, HT, TH, TT\}$

a $\Pr(\text{No heads}) = \Pr(\{TT\}) = \frac{1}{4}$.

b $\Pr(\text{More than one tail}) = \Pr(\{TT\}) = \frac{1}{4}$.

2 a $\Pr(\text{First toss is a head}) = \frac{1}{2}$

b $\Pr(\text{Second toss is a head}) = \frac{1}{2}$

c $\Pr(\text{Both tosses are heads}) = \frac{1}{4}$

3 Sample space =

$\{2, 3, 4, 5, 6, 7, 8, 9, 10, 11, 12\}$

There is only 1 way of getting 2 or 12,
2 ways of getting 3 or 11, 3 ways of
getting 4 or 10 etc.

a $\Pr(\text{even}) = \Pr(2) + \Pr(4) + \Pr(6)$
 $+ \Pr(8) + \Pr(10) + \Pr(12)$
 $= \frac{1 + 3 + 5 + 5 + 3 + 1}{36}$
 $= \frac{1}{2}$

b $\Pr(3) = \frac{2}{36} = \frac{1}{18}$

c $\Pr(< 6) = \Pr(2) + \Pr(3)$
 $+ \Pr(4) + \Pr(5)$
 $= \frac{1 + 2 + 3 + 4}{36}$
 $= \frac{10}{36} = \frac{5}{18}$

4 Sample space =

$\{2, 3, 4, 5, 6, 7, 8, 9, 10, 11, 12\}$

a $\Pr(10) = \frac{3}{36} = \frac{1}{12}$

b $\Pr(\text{odd}) = \Pr(3) + \Pr(5) + \Pr(7)$
 $+ \Pr(9) + \Pr(11)$
 $= \frac{2 + 4 + 6 + 4 + 2}{36}$
 $= \frac{1}{2}$

c $\Pr(\leq 7) = \frac{1 + 2 + 3 + 4 + 5 + 6}{36}$
 $= \frac{21}{36} = \frac{7}{12}$

5 $\varepsilon =$

$\{HHH, HHT, HTH, THH, TTH, THT, HTT, TTT\}$

a $\Pr(\text{exactly one tail}) =$
 $\Pr(\{HHT, HTH, THH\}) = \frac{3}{8}$

b $\Pr(\text{exactly two tails}) =$
 $\Pr(\{HTT, TTH, THT\}) = \frac{3}{8}$

c $\Pr(\text{exactly three tails}) = \Pr(\{TTT\}) =$
 $\frac{1}{8}$

d $\Pr(\text{no tails}) = \Pr(\{HHH\}) = \frac{1}{8}$

6 $\varepsilon =$

$\{HHH, HHT, HTH, THH, TTH, THT, HTT, TTT\}$

a $\Pr(\text{the third toss is a head}) =$
 $\Pr(\{HHH, HTH, THH, TTH\}) = \frac{1}{2}$

b $\Pr(\text{second and third tosses are heads}) =$

$$\Pr(\{HHH, THH\}) = \frac{1}{4}$$

c Pr(at least one head and one tail) =

$$\Pr(\{HHT, HTH, THH, TTH, THT, HTT, \}) = \frac{3}{4}$$

7 12 equally likely outcomes:

$$\begin{aligned} \Pr(\text{even}, H) &= \Pr(2, H) + \Pr(4, H) \\ &\quad + \Pr(6, H) \\ &= \frac{3}{12} = \frac{1}{4} \end{aligned}$$

8 a

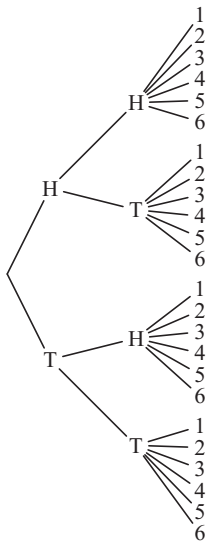

b i

$$\begin{aligned} \Pr(2 \text{ heads and a } 6) &= \Pr(\{(H, H, 6)\}) \\ &= \frac{1}{24} \end{aligned}$$

ii

$$\begin{aligned} \Pr(1 \text{ head, } 1 \text{ tail and an even number}) &= \Pr(\{(H, T, 6), (H, T, 4), (H, T, 2), \\ &\quad (T, H, 6), (T, H, 4), (T, H, 2)\}) \\ &= \frac{6}{24} \\ &= \frac{1}{4} \end{aligned}$$

iii Pr(2 tails and an odd number)

$$\begin{aligned} &= \Pr(\{(T, T, 1), (T, T, 3), (T, T, 5)\}) \\ &= \frac{3}{24} \\ &= \frac{1}{8} \end{aligned}$$

iv Pr(an odd number on the die)

$$= \frac{1}{2}$$

9 a

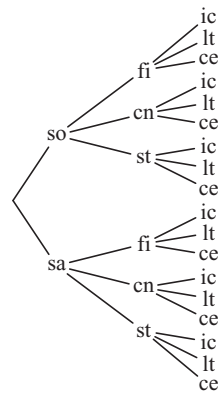

b i

$$\begin{aligned} \Pr(\text{soup, fish and lemon tart}) &= \Pr(\{(so, fi, it)\}) \\ &= \frac{1}{18} \end{aligned}$$

ii Pr(fish)

$$= \frac{1}{3}$$

iii

Pr(salad and chicken)

$$\begin{aligned} &= \Pr(\{(sa, c, lt), (sa, c, ic), (sa, c, ce)\}) \\ &= \frac{3}{18} \\ &= \frac{1}{6} \end{aligned}$$

iv Pr(no lemon tart)

$$\begin{aligned} &= 1 - \frac{1}{3} \\ &= \frac{2}{3} \end{aligned}$$

c This increases the number of choices for the entree to 3 and the dessert 4. There are $3 \times 3 \times 4 = 36$ choices.

d i Pr(soup, fish and lemon tart)

$$\begin{aligned} &= \Pr(\{(so, fi, it)\}) \\ &= \frac{1}{36} \end{aligned}$$

ii Pr(all courses)

$$= \frac{1}{2}$$

iii Pr(only two courses)

$$\begin{aligned} &= \frac{12}{36} \\ &= \frac{1}{3} \end{aligned}$$

iv Pr(only the main courses)

$$\begin{aligned} &= \frac{3}{36} \\ &= \frac{1}{12} \end{aligned}$$

b i $\Pr(5) = \frac{4}{25}$

ii $\Pr(\text{different}) = 1 - \Pr(\text{same}) = 1 - \frac{1}{5} = \frac{4}{5}$

iii $\Pr(\text{second number two more than first number}) = \frac{3}{25}$

10 a (1, 1)(2, 1)(3, 1)(4, 1)(5, 1)
(1, 2)(2, 2)(3, 2)(4, 2)(5, 2)
(1, 3)(2, 3)(3, 3)(4, 3)(5, 3)
(1, 4)(2, 4)(3, 4)(4, 4)(5, 4)
(1, 5)(2, 5)(3, 5)(4, 5)(5, 5)

Solutions to Exercise 9D

- 1 $\mathcal{E} = \{1, 2, 3, 4, 5, 6, 7, 8, 9, 10\}$,
 $A = \{1, 2, 3, 4\}$, $B = \{2, 4, 6\}$.

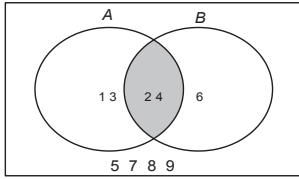

- a $A \cup B = \{1, 2, 3, 4, 6\}$
 b $A \cap B = \{2, 4\}$
 c $A' = \{5, 6, 7, 8, 9, 10\}$
 d $A \cap B' = \{1, 3\}$
 e $(A \cap B)' = \{1, 3, 5, 6, 7, 8, 9, 10\}$
 f $(A \cup B)' = \{5, 7, 8, 9, 10\}$

- 2 $\mathcal{E} = \{1, 2, 3, 4, 5, 6, 7, 8, 9, 10, 11, 12\}$
 $A = \{\text{multiples of four}\}$
 $B = \{\text{even numbers}\}$

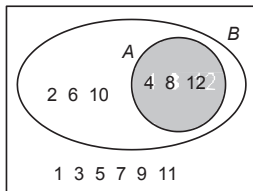

- a $A' = \{1, 2, 3, 5, 6, 7, 9, 10, 11\}$
 b $B' = \{1, 3, 5, 7, 9, 11\}$
 c $A \cup B = \{2, 4, 6, 8, 10, 12\}$
 d $(A \cup B)' = B' = \{1, 3, 5, 7, 9, 11\}$
 e $A' \cap B' = B' = \{1, 3, 5, 7, 9, 11\}$

- 3 $\mathcal{E} = \{\text{MATHEICS}\}$, $A = \{\text{ATIC}\}$, $B = \{\text{TASE}\}$

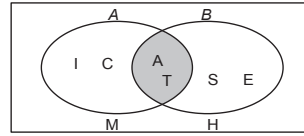

- a $A' = \{E, H, M, S, \}$
 b $B' = \{C, H, I, M\}$
 c $A \cup B = \{A, C, E, I, S, T\}$
 d $(A \cup B)' = \{H, M\}$
 e $A' \cup B' = \{C, E, H, I, M, S\}$
 f $A' \cap B' = \{H, M\}$

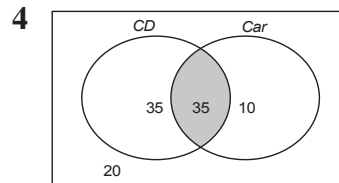

$\mathcal{E} = 100$ students

- a 20 students own neither a car nor smart phone.
 b 45 students own either but not both.
 5 $\mathcal{E} = \{1, 2, 3, 4, 5, 6\}$;
 $A = \{2, 4, 6\}$, $B = \{3\}$
 a $(A \cup B) = \{2, 3, 4, 6\}$
 $\therefore \Pr(A \cup B) = \frac{2}{3}$
 b $(A \cap B) = \{\}$
 $\therefore \Pr(A \cap B) = 0$
 c $A' = \{1, 3, 5\}$
 $\therefore \Pr(A') = \frac{1}{2}$

d $B' = \{1, 2, 4, 5, 6\} \therefore \Pr(B') = \frac{5}{6}$

6 $\varepsilon = \{1, 2, 3, 4, 5, 6, 7, 8, 9, 10, 11, 12\};$
 $A = \{2, 4, 6, 8, 10, 12\}, B = \{3, 6, 9, 12\}$

a $\Pr(A) = \frac{6}{12} = \frac{1}{2}$

b $\Pr(B) = \frac{4}{12} = \frac{1}{3}$

c $\{A \cap B\} = \{6, 12\}, \therefore \Pr(A \cap B) = \frac{1}{6}$
 $\Pr(A \cup B) = \Pr(A) + \Pr(B) - \Pr(A \cap B)$
 $= \frac{2}{3}$

7

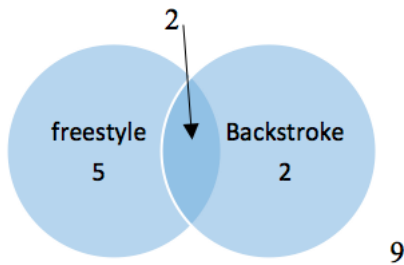

a $\Pr(\text{Swims freestyle}) = \frac{7}{18}$

b $\Pr(\text{Swims backstroke}) = \frac{4}{18} = \frac{1}{9}$

c $\Pr(\text{Swims freestyle and backstroke}) = \frac{2}{18} = \frac{2}{9}$

d $\Pr(\text{is on the swimming team}) = \frac{9}{18} = \frac{1}{2}$

8 $A = \{1, 2, 3, 4, 6, 12\}$ and $B = \{2, 3, 5, 7\}$

a $\Pr(A) = \frac{6}{20} = \frac{3}{5}$

b $\Pr(B) = \frac{4}{20} = \frac{1}{5}$

c $\Pr(A \cap B) = \frac{2}{20} = \frac{1}{10}$

d $\Pr(A \cup B) = \frac{8}{20} = \frac{2}{5}$

9 $\Pr(A) = 0.5, \Pr(B) = 0.4,$ and
 $\Pr(A \cap B) = 0.2.$
 $\Pr(A \cup B) = 0.5 + 0.4 - 0.2 = 0.7$

10 $\Pr(A) = 0.35, \Pr(B) = 0.24,$ and
 $\Pr(A \cap B) = 0.12.$
 $\Pr(A \cup B) = 0.35 + 0.24 - 0.12 = 0.47$

11 $\Pr(A) = 0.28, \Pr(B) = 0.45,$ and $A \subset B$

a $\Pr(A \cap B) = \Pr(B) = 0.28$

b
 $\Pr(A \cup B) = \Pr(A) + \Pr(B) - \Pr(A \cap B)$
 $= 0.28 + 0.45 - 0.28$
 $= 0.45$

12 $\Pr(A) = 0.58, \Pr(B) = 0.45,$ and $B \subset A$

a $\Pr(A \cap B) = \Pr(B) = 0.45$

b
 $\Pr(A \cup B) = \Pr(A) + \Pr(B) - \Pr(A \cap B)$
 $= 0.45 + 0.58 - 0.45$
 $= 0.58$

13 $\Pr(A) = 0.3, \Pr(B) = 0.4,$ and $A \cap B = \emptyset$

a $\Pr(A \cap B) = 0$

b

$$\begin{aligned}\Pr(A \cup B) &= \Pr(A) + \Pr(B) - \Pr(A \cap B) \\ &= 0.3 + 0.4 - 0 \\ &= 0.7\end{aligned}$$

$$\begin{aligned}\Pr(A \cup B) &= \Pr(A) + \Pr(B) - \Pr(A \cap B) \\ 0.63 &= 0.24 + 0.44 - \Pr(A \cap B) \\ \therefore \Pr(A \cap B) &= 0.05\end{aligned}$$

14 $\Pr(A) = 0.08, \Pr(B) = 0.15,$ and
 $A \cap B = \emptyset$

a $\Pr(A \cap B) = 0$

b

$$\begin{aligned}\Pr(A \cup B) &= \Pr(A) + \Pr(B) - \Pr(A \cap B) \\ &= 0.08 + 0.15 - 0 \\ &= 0.23\end{aligned}$$

15 $\Pr(A) = 0.3, \Pr(B) = 0.4,$ and
 $A \cup B = 0.5$

$$\begin{aligned}\Pr(A \cup B) &= \Pr(A) + \Pr(B) - \Pr(A \cap B) \\ 0.5 &= 0.3 + 0.4 - \Pr(A \cap B)\end{aligned}$$

$$\therefore \Pr(A \cap B) = 0.2$$

16 $\Pr(A) = 0.24, \Pr(B) = 0.44,$ and
 $A \cup B = 0.63$

17 $\Pr(A) = 0.3, \Pr(B) = 0.4,$ and
 $A \cap B' = 0.2$

$$\begin{aligned}\Pr(A \cup B') &= \Pr(A) + \Pr(B') - \Pr(A \cap B') \\ &= 0.3 + 0.6 - 0.2 \\ &= 0.7\end{aligned}$$

18 $\Pr(\text{Soccer}) = 0.18, \Pr(\text{Tennis}) = 0.25$
and $\Pr(\text{Soccer and Tennis}) = 0.11$

$$\begin{aligned}\Pr(\text{Soccer or Tennis}) &= 0.18 + 0.25 - 0.11 \\ &= 0.32\end{aligned}$$

19 $\Pr(\text{Chinese}) = 0.22, \Pr(\text{French}) = 0.35$
and $\Pr(\text{Chinese and French}) = 0.14$

a

$$\begin{aligned}\Pr(\text{Chinese or French}) &= 0.22 + 0.35 - 0.14 \\ &= 0.43\end{aligned}$$

b Probability of exactly one of these languages

$$= \Pr(C \cup F) - \Pr(C \cap F) = 0.29$$

Solutions to Exercise 9E

- 1 $\Pr(A) = 0.6$, $\Pr(A \cap B) = 0.4$,
 $\Pr(A' \cap B) = 0.1$

	B	B'	
A	$\Pr(A \cap B)$ = 0.4	$\Pr(A \cap B')$ = 0.2	$\Pr(A)$ = 0.6
A'	$\Pr(A' \cap B)$ = 0.1	$\Pr(A' \cap B')$ = 0.3	$\Pr(A')$ = 0.4
	$\Pr(B) = 0.5$	$\Pr(B') = 0.5$	1

- a $\Pr(A \cap B') = 0.2$
 b $\Pr(B) = 0.5$
 c $\Pr(A' \cap B') = 0.3$
 d $\Pr(A \cup B) = 1 - 0.3 = 0.7$

- 2 $\Pr(A') = 0.25$, $\Pr(A' \cap B) =$
 0.12 , $\Pr(B) = 0.52$:

	B	B'	
A	$\Pr(A \cap B)$ = 0.4	$\Pr(A \cap B')$ = 0.35	$\Pr(A)$ = 0.75
A'	$\Pr(A' \cap B)$ = 0.12	$\Pr(A' \cap B')$ = 0.13	$\Pr(A')$ = 0.25
	$\Pr(B) = 0.52$	$\Pr(B') = 0.48$	1

- a $\Pr(A) = 0.75$
 b $\Pr(A \cap B) = 0.4$
 c $\Pr(A \cup B) = 1 - 0.13 = 0.87$
 d $\Pr(B') = 0.48$

- 3 $\Pr(C \cup D) = 0.85$
 $\therefore \Pr(C' \cap D') = 0.15$, $\Pr(C) = 0.45$
 and $\Pr(D') = 0.37$:

	D	D'	
C	$\Pr(C \cap D)$ = 0.23	$\Pr(C \cap D')$ = 0.22	$\Pr(C)$ = 0.45
C'	$\Pr(C' \cap D)$ = 0.4	$\Pr(C' \cap D')$ = 0.15	$\Pr(C')$ = 0.55
	$\Pr(D) = 0.63$	$\Pr(D') = 0.37$	1

- a $\Pr(D) = 0.63$
 b $\Pr(C \cap D) = 0.23$
 c $\Pr(C \cap D') = 0.22$
 d $\Pr(C' \cup D') = 1 - 0.23 = 0.77$

- 4 $\Pr(E \cup F) = 0.7$
 $\therefore \Pr(E' \cap F') = 0.3$
 $\Pr(E \cap F) = 0.15$, $\Pr(E') = 0.55$:

	F	F'	
E	$\Pr(E \cap F)$ = 0.15	$\Pr(E \cap F')$ = 0.3	$\Pr(E)$ = 0.45
E'	$\Pr(E' \cap F)$ = 0.25	$\Pr(E' \cap F')$ = 0.3	$\Pr(E')$ = 0.55
	$\Pr(F) = 0.4$	$\Pr(F') = 0.6$	1

- a $\Pr(E) = 0.45$
 b $\Pr(F) = 0.4$
 c $\Pr(E' \cap F) = 0.25$
 d $\Pr(E' \cup F) = 1 - 0.3 = 0.7$

- 5 $\Pr(A) = 0.8$, $\Pr(B) = 0.7$,
 $\Pr(A' \cap B') = 0.1$:

	B	B'	
A	$\Pr(A \cap B)$ $= 0.6$	$\Pr(A \cap B')$ $= 0.2$	$\Pr(A)$ $= 0.8$
A'	$\Pr(A' \cap B)$ $= 0.1$	$\Pr(A' \cap B')$ $= 0.1$	$\Pr(A')$ $= 0.2$
	$\Pr(B) = 0.7$	$\Pr(B') = 0.3$	1

- a $\Pr(A \cup B) = 1 - 0.1 = 0.9$
b $\Pr(A \cap B) = 0.6$
c $\Pr(A' \cap B) = 0.1$
d $\Pr(A \cup B') = 1 - 0.1 = 0.9$

- 6 $\Pr(G) = 0.85$, $\Pr(L) = 0.6$,
 $\Pr(L \cup G) = 0.5$:

	L	L'	
G	$\Pr(G \cap L)$ $= 0.5$	$\Pr(G \cap L')$ $= 0.35$	$\Pr(G)$ $= 0.85$
G'	$\Pr(G' \cap L)$ $= 0.1$	$\Pr(G' \cap L')$ $= 0.05$	$\Pr(G')$ $= 0.15$
	$\Pr(L) = 0.6$	$\Pr(L') = 0.4$	1

- a $\Pr(G \cup L) = 1 - 0.05 = 0.95$, so 95%
favoured at least one proposition.
b $\Pr(G' \cap L') = 0.05$, so 5% favoured
neither proposition

7 a

	C	C'	
A	$\Pr(A \cap C)$ $= \frac{4}{52}$	$\Pr(A \cap C')$ $= \frac{12}{52}$	$\Pr(A)$ $= \frac{16}{52}$
A'	$\Pr(A' \cap C)$ $= \frac{9}{52}$	$\Pr(A' \cap C')$ $= \frac{27}{52}$	$\Pr(A')$ $= \frac{36}{52}$
	$\Pr(C) = \frac{13}{52}$	$\Pr(C') = \frac{39}{52}$	1

- b i $\Pr(A) = \frac{16}{52} = \frac{4}{13}$ (all picture
cards)
ii $\Pr(C) = \frac{13}{52} = \frac{1}{4}$ (all hearts)
iii $\Pr(A \cap C) = \frac{4}{52} = \frac{1}{13}$ (picture
hearts)
iv $\Pr(A \cup C) = \frac{25}{52}$ (all hearts or
pictures)
v $\Pr(A \cup C') = \frac{43}{52}$ (all club,
diamond and spades or pictures)

- 8 $\Pr(M \cap F) = \frac{1}{6}$ or $\frac{10}{60}$
 $\Pr(M) = \frac{3}{10} = \frac{18}{60}$
 $\Pr(F') = \frac{7}{15} = \frac{28}{60}$

	F	F'	
M	$\Pr(M \cap F)$ $= \frac{10}{60}$	$\Pr(M \cap F')$ $= \frac{8}{60}$	$\Pr(M)$ $= \frac{18}{60}$
M'	$\Pr(M' \cap F)$ $= \frac{22}{60}$	$\Pr(M' \cap F')$ $= \frac{20}{60}$	$\Pr(M')$ $= \frac{42}{60}$
	$\Pr(F) = \frac{32}{60}$	$\Pr(F') = \frac{28}{60}$	60

a $\Pr(F) = \frac{32}{60} = \frac{8}{15}$

b $\Pr(M') = \frac{42}{60} = \frac{7}{10}$

c $\Pr(M \cap F') = \frac{8}{60}$ or $\frac{2}{15}$

d $\Pr(M' \cap F') = \frac{20}{60}$ or $\frac{1}{3}$

9 $\Pr(F) = 0.65$

$\Pr(W) = 0.72$

$\Pr(W' \cap F') = 0.2$

	F	F'	
W	$\Pr(W \cap F)$ $= 0.57$	$\Pr(W \cap F')$ $= 0.15$	$\Pr(W)$ $= 0.72$
W'	$\Pr(W' \cap F)$ $= 0.08$	$\Pr(W' \cap F')$ $= 0.2$	$\Pr(W')$ $= 0.28$
	$\Pr(F) = 0.65$	$\Pr(F') = 0.35$	1

a $\Pr(W \cup F) = 1 - 0.2 = 0.8$

b $\Pr(W \cap F) = 0.57$

c $\Pr(W') = 0.28$

d $\Pr(W' \cap F) = 0.08$

10 $\Pr(H \cap N') = 0.05$

$\Pr(H' \cap N) = 0.12$

$\Pr(N') = 0.19$

	N	N'	
H	$\Pr(H \cap N)$ $= 0.69$	$\Pr(H \cap N')$ $= 0.05$	$\Pr(H)$ $= 0.74$
H'	$\Pr(H' \cap N)$ $= 0.12$	$\Pr(H' \cap N')$ $= 0.14$	$\Pr(H')$ $= 0.26$
	$\Pr(N) = 0.81$	$\Pr(N') = 0.19$	1

a $\Pr(N) = 0.81$

b $\Pr(H \cap N) = 0.69$

c $\Pr(N) = 0.74$

d $\Pr(H \cup N) = 1 - 0.14 = 0.86$

11 $\Pr(B) = \frac{40}{60} = \frac{2}{3}$
 $\Pr(S) = \frac{32}{60} = \frac{8}{15}$
 $\Pr(B' \cap S') = 0$

	B	B'	
S	$\Pr(S \cap B)$ $= \frac{12}{60}$	$\Pr(S \cap B')$ $= \frac{20}{60}$	$\Pr(S)$ $= \frac{32}{60}$
S'	$\Pr(S' \cap B)$ $= \frac{28}{60}$	$\Pr(S' \cap B')$ $= 0$	$\Pr(S')$ $= \frac{28}{60}$
	$\Pr(B) = \frac{40}{60}$	$\Pr(B') = \frac{20}{60}$	60

a $\Pr(B' \cap S') = 0$

b $\Pr(B \cup S) = 1$

c $\Pr(B \cap S) = \frac{12}{60} = \frac{1}{5} = 0.2$

d $\Pr(B' \cap S) = \frac{20}{60} = \frac{1}{3}$

12 $\Pr(H) = \frac{35}{50} = 0.7$

$\Pr(S) = \frac{38}{50} = 0.76$

$\Pr(H' \cap S') = \frac{6}{50} = 0.12$

	H	H'	
S	$\Pr(S \cap H)$ $= \mathbf{0.58}$	$\Pr(S \cap H')$ $= \mathbf{0.18}$	$\Pr(S)$ $= 0.76$
S'	$\Pr(S' \cap H)$ $= \mathbf{0.12}$	$\Pr(S' \cap H')$ $= 0.12$	$\Pr(S')$ $= \mathbf{0.24}$
	$\Pr(H)$ $= 0.7$	$\Pr(H')$ $= \mathbf{0.3}$	1

a $\Pr(H \cup S) = 1 - 0.12 = 0.88$

b $\Pr(H \cap S) = 0.58$

c $\Pr(H' \cap S) + \Pr(H \cap S')$
 $= 0.12 + 0.18$
 $= 0.3$

d $\Pr(H \cap S') = 0.12$

Solutions to Exercise 9F

1 $A = \{6\}$, $B = \{3, 4, 5, 6\}$

$\therefore A \cap B = \{6\}$

$$\begin{aligned} \Pr(A|B) &= \frac{\Pr(A \cap B)}{\Pr(B)} \\ &= \frac{1}{6} \div \frac{4}{6} = \frac{1}{4} \end{aligned}$$

2

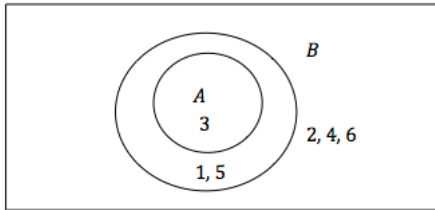

$$\Pr(A|B) = \frac{1}{3}$$

3

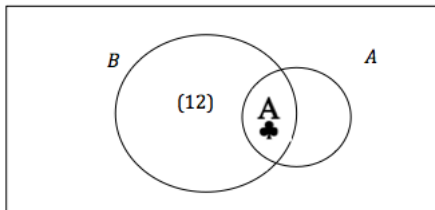

$$\Pr(A|B) = \frac{1}{13}$$

4



$$\Pr(\text{Violin}|\text{Piano}) = \frac{7}{19}$$

5 $\Pr(\text{Double six} | \text{A double}) = \frac{1}{6}$

6 a $\Pr(\text{iPad} | \text{iPhone}) = \frac{4}{17}$

b $\Pr(\text{iPhone} | \text{iPad}) = \frac{4}{7}$

7 $\Pr(\text{Think yes} | \text{Male}) = \frac{35}{60} = \frac{7}{12}$

8 a $\Pr(\text{Prefers sport}) = \frac{375}{500} = \frac{3}{4}$

b $\Pr(\text{Prefers sport} | \text{Male}) = \frac{225}{500} = \frac{9}{20}$

9

\cap	S	A	R	O	T
F	42	61	22	12	137
NF	88	185	98	60	431
Tot	130	246	120	72	568

a $\Pr(S) = \frac{130}{568} = \frac{65}{284}$

b $\Pr(F) = \frac{137}{568}$

c
$$\begin{aligned} \Pr(F|S) &= \frac{\Pr(F \cap S)}{\Pr(S)} \\ &= \frac{42}{568} \div \frac{130}{568} \\ &= \frac{42}{130} = \frac{21}{65} \end{aligned}$$

d
$$\begin{aligned} \Pr(F|A) &= \frac{\Pr(F \cap A)}{\Pr(A)} \\ &= \frac{61}{568} \div \frac{246}{568} = \frac{61}{246} \end{aligned}$$

10 $\Pr(A) = 0.6$, $\Pr(B) = 0.3$, $\Pr(B|A) = 0.1$

a $\Pr(A \cap B) = \Pr(B|A) \times \Pr(A) = 0.06$

$$\begin{aligned} \text{b } \Pr(A|B) &= \frac{\Pr(A \cap B)}{\Pr(B)} \\ &= \frac{0.06}{0.3} = 0.2 \end{aligned}$$

$$\begin{aligned} \text{11 a } \Pr(B|A) &= \frac{\Pr(A \cap B)}{\Pr(A)} \\ &= \frac{0.4}{0.7} = \frac{4}{7} \end{aligned}$$

$$\begin{aligned} \text{b } \Pr(A \cap B) &= \Pr(A|B) \times \Pr(B) \\ &= 0.6(0.5) = 0.3 \end{aligned}$$

$$\begin{aligned} \text{c } \Pr(A|B) &= \frac{\Pr(A \cap B)}{\Pr(B)} \\ \therefore \Pr(B) &= \frac{\Pr(A \cap B)}{\Pr(A|B)} \\ &= \frac{0.3}{0.44} = \frac{15}{22} \end{aligned}$$

$$\begin{aligned} \text{12 } \Pr(A) = 0.5, \Pr(B) = 0.4, \Pr(A \cup B) = 0.7 \\ \Pr(A \cap B) + \Pr(A \cup B) = \Pr(A) + \Pr(B) \end{aligned}$$

\cap	B	B'		
A	0.2	0.3	0.5	$\Pr(A)$
A'	0.2	0.3	0.5	$\Pr(A')$
	0.4	0.6	1	
	$\Pr(B)$	$\Pr(B')$		

$$\text{a } \Pr(A \cap B) = 0.5 + 0.4 - 0.7 = 0.2$$

$$\text{b } \Pr(A|B) = \frac{0.2}{0.4} = 0.5$$

$$\text{c } \Pr(B|A) = \frac{0.2}{0.5} = 0.4$$

$$\begin{aligned} \text{13 } \Pr(A) = 0.6, \Pr(B) = 0.54, \\ \Pr(A \cap B') = 0.4 \end{aligned}$$

\cap	B	B'		
A	0.2	0.4	0.6	$= \Pr(A)$
A'	0.34	0.06	0.4	$= \Pr(A')$
	0.54	0.46	1	
	$= \Pr(B)$	$= \Pr(B')$		

$$\text{a } \Pr(A \cap B) = 0.2$$

$$\begin{aligned} \text{b } \Pr(A|B) &= \frac{\Pr(A \cap B)}{\Pr(B)} \\ &= \frac{0.2}{0.54} = \frac{10}{27} \end{aligned}$$

$$\begin{aligned} \text{c } \Pr(B|A) &= \frac{\Pr(A \cap B)}{\Pr(A)} \\ &= \frac{0.2}{0.6} = \frac{1}{3} \end{aligned}$$

$$\text{14 } \Pr(A) = 0.4, \Pr(B) = 0.5, \Pr(A|B) = 0.6$$

$$\text{a } \Pr(A \cap B) = \Pr(A|B) \times \Pr(B) = 0.3$$

$$\begin{aligned} \text{b } \Pr(B|A) &= \frac{0.3}{0.4} \\ &= \frac{3}{4} = 0.75 \end{aligned}$$

$$\text{15 } \Pr(H) = 0.6, \Pr(W|H) = 0.8$$

$$\begin{aligned} \therefore \Pr(H \cap W) &= \Pr(W|H) \times \Pr(H) \\ &= 0.8(0.6) = 0.48 \end{aligned}$$

$$\Pr(W|H') = 0.4$$

$$\begin{aligned} \therefore \Pr(H' \cap W) &= \Pr(W|H') \times \Pr(H') \\ &= 0.4^2 = 0.16 \end{aligned}$$

\cap	W	W'		
H	0.48	0.12	0.6	$\Pr(H)$
H'	0.16	0.24	0.4	$\Pr(H')$
	0.64	0.36	1	
	$\Pr(W)$	$\Pr(W')$		

$$\Pr(H' \cap W) = 0.16 = 16\%$$

16 $\Pr(C) = 0.15, \Pr(F) = 0.08,$

$$\begin{aligned} \Pr(C \cap F) &= 0.03 \\ \Pr(F|C) &= \frac{\Pr(C \cap F)}{\Pr(C)} \\ &= \frac{0.03}{0.15} = \frac{1}{5} \end{aligned}$$

17 (with replacement)

a $\left(\frac{1}{4}\right)^2 = \frac{1}{16}$

b $\Pr(A, A) = \left(\frac{1}{13}\right)^2 = \frac{1}{169}$

c $\Pr(R, B) = \left(\frac{1}{2}\right)^2 = \frac{1}{4}$

d $\Pr(P, P) = \left(\frac{4}{13}\right)^2 = \frac{16}{169}$

18 (without replacement)

a $\left(\frac{13}{52}\right)\left(\frac{12}{51}\right) = \frac{1}{17}$

b $\Pr(A, A) = \left(\frac{4}{52}\right)\left(\frac{3}{51}\right) = \frac{1}{221}$

c $\Pr(R, B) = \left(\frac{26}{52}\right)\left(\frac{26}{51}\right) = \frac{13}{51}$

d $\Pr(P, P) = \left(\frac{16}{52}\right)\left(\frac{15}{51}\right) = \frac{20}{221}$

19 $\Pr(W) = 0.652, \Pr(A|W) = 0.354$

$$\begin{aligned} \Pr(A \cap W) &= \Pr(A|W) \times \Pr(W) \\ &= 0.231 \end{aligned}$$

20 $\varepsilon = 28, G = 15, B = 14 = (6G + 8G')$

$\therefore B' = (9G + 5G')$

a $\Pr(G) = \frac{15}{28}$

b $\Pr(B) = \frac{14}{28} = \frac{1}{2}$

c $\Pr(B') = 1 - \frac{1}{2} = \frac{1}{2}$

d $\Pr(B|G) = \frac{\Pr(G \cap B)}{\Pr(G)}$
 $= \frac{6}{28} \div \frac{15}{28} = \frac{2}{5}$

e $\Pr(G|B) = \frac{\Pr(G \cap B)}{\Pr(B)}$
 $= \frac{6}{28} \div \frac{14}{28} = \frac{3}{7}$

f $\Pr(B|G') = \frac{\Pr(G' \cap B)}{\Pr(G')}$
 $= \frac{8}{28} \div \frac{13}{28} = \frac{8}{13}$

g $\Pr(B' \cap G') = \frac{5}{28}$

h $\Pr(B \cap G) = \frac{6}{28} = \frac{3}{14}$

21 a $\Pr(R) = 0.85$

b $\Pr(L|R) = 0.60$

c $\Pr(L \cap R) = \Pr(L|R) \times \Pr(R) = 0.51$

d $\Pr(L) = 0.51$ since L is a subset of R .

22 $U =$ 'students who prefer not to wear a uniform'

$E =$ 'students in Yr 11'

$E' =$ 'students in Yr 12'

$\Pr(U|E) = 0.25 = \frac{1}{4}$

$\Pr(U|E') = 0.40 = \frac{2}{5}$

$\Pr(E) = 320/600 = \frac{8}{15}$

$$\begin{aligned}\Pr(U \cap E) &= \Pr(U|E) \times \Pr(E) \\ &= \left(\frac{8}{15}\right)\frac{1}{4} = \frac{2}{15}\end{aligned}$$

$$\begin{aligned}\Pr(U \cap E') &= \Pr(U|E') \Pr(E') \\ &= \left(\frac{7}{15}\right)\frac{2}{5} = \frac{14}{75}\end{aligned}$$

$$\begin{aligned}\therefore \Pr(U) &= \Pr(U \cap E') + \Pr(U \cap E) \\ &= \frac{2}{15} + \frac{14}{75} = \frac{24}{75} = 32\%\end{aligned}$$

However, these are students who prefer *not* to wear uniform.

Students in favour are therefore 68%.

$$23 \quad \Pr(B \cap G) = 0.4\left(\frac{4}{9}\right) = 0.178$$

$$\Pr(B \cap G') = 0.35\left(\frac{5}{9}\right) = 0.194$$

$$\Pr(B' \cap G) = 0.6\left(\frac{4}{9}\right) = 0.267$$

$$\Pr(B' \cap G') = 0.65\left(\frac{5}{9}\right) = 0.361$$

\cap	B	B'	
G	0.178	0.267	0.444
G'	0.194	0.361	0.556
	0.372	0.628	1

$$a \quad i \quad \Pr(G) = \frac{400}{900} = 0.444$$

$$ii \quad \Pr(B|G) = 0.40 \text{ (40\%)}$$

$$iii \quad \Pr(B|G') = 0.35 \text{ (35\%)}$$

$$\begin{aligned}iv \quad \Pr(B \cap G) &= \Pr(B|G) \times \Pr(G) \\ &= 0.4(0.444) = 0.178\end{aligned}$$

$$\begin{aligned}v \quad \Pr(B \cap G') &= \Pr(B|G') \times \Pr(G') \\ &= 0.35\left(\frac{500}{900}\right) \cong 0.194\end{aligned}$$

$$b \quad \Pr(B) = \frac{335}{900} \cong 0.372$$

$$\begin{aligned}c \quad i \quad \Pr(G|B) &= \frac{\Pr(B \cap G)}{\Pr(B)} \\ &= \frac{0.178}{0.372} \cong 0.478\end{aligned}$$

$$\begin{aligned}ii \quad \Pr(G|B') &= \frac{\Pr(B' \cap G)}{\Pr(B')} \\ &= \frac{0.267}{0.628} = 0.425\end{aligned}$$

$$24 \quad N': 12\% \text{ of } 480 = D;$$

$$N: 5\% \text{ of } 620 = D$$

$$\begin{aligned}a \quad i \quad \Pr(N) &= \frac{620}{620 + 480} \\ &\approx 0.564\end{aligned}$$

$$ii \quad \Pr(D|N) = 0.05 \text{ (5\%)}$$

$$iii \quad \Pr(D|N') = 0.12 \text{ (= 12\%)}$$

$$\begin{aligned}iv \quad \Pr(D \cap N) &= \Pr(D|N) \times \Pr(N) \\ &= 0.05(0.563) \\ &= 0.0282\end{aligned}$$

v

$$\begin{aligned}\Pr(D \cap N') &= \Pr(D|N') \times \Pr(N') \\ &= 0.12(0.437) \approx 0.052\end{aligned}$$

$$b \quad 12\%(480) + 5\%(620) = \frac{89}{1100} = 0.081$$

$$\begin{aligned}c \quad \Pr(N|D) &= \frac{\Pr(D \cap N)}{\Pr(D)} \\ &= \frac{0.028}{0.081} \approx 0.35\end{aligned}$$

$$25 \quad B1 = 3M, 3M'; B2 = 3M, 2M'; \\ B3 = 2M, 1M'$$

$$a \quad \Pr(M \cap B1) = \frac{1}{3}\left(\frac{1}{2}\right) = \frac{1}{6}$$

b $\Pr(M) = \Pr(M \cap B1) + \Pr(M \cap B2)$ **26** $A, B \neq \emptyset$

$$\begin{aligned}
 &+ \Pr(M \cap B3) \\
 &= \frac{1}{3}\left(\frac{1}{2}\right) + \frac{1}{3}\left(\frac{3}{5}\right) + \frac{1}{3}\left(\frac{2}{3}\right) \\
 &= \frac{1}{6} + \frac{1}{5} + \frac{2}{9} = \frac{53}{90}
 \end{aligned}$$

c $\Pr(B1|M) = \frac{\Pr(M \cap B1)}{\Pr(M)}$

$$= \frac{1}{6} \div \frac{53}{90} = \frac{15}{53}$$

a $\Pr(A|B) = 1$

$$\therefore \Pr(A \cap B) = \Pr(B)$$

$\therefore B$ is a subset of A , i.e. $B \subseteq A$

b $\Pr(A|B) = 0$

$\therefore A$ and B are mutually exclusive or

$$A \cap B = \emptyset$$

c $\Pr(A|B) = \frac{\Pr(A)}{\Pr(B)}$

$$\therefore \Pr(A \cap B) = \Pr(A)$$

$\therefore A$ is a subset of B , i.e. $A \subseteq B$

Solutions to Exercise 9G

- 1 Do you think private individuals should be allowed to carry guns?

	Male	Female	
Yes	35	30	65
No	25	10	35
Total	60	40	100

Pr(male and support guns) = 0.35;
 Pr(male) \times Pr(support guns) = 0.65 \neq 0.35;
 therefore not independent

2

	Male	Female	Total
Sport	225	150	375
Music	75	50	125
Total	300	200	500

Pr(male and prefer sport) = 0.45;
 Pr(male) \times Pr(prefer sport) = 0.45;
 therefore independent

3

Type of accident	Speeding		Total
	Yes	No	
Serious	42	61	103
Minor	88	185	273
Total	130	246	376

Pr(speeding and serious) \approx 0.074;
 Pr(speeding) \times Pr(serious) = 0.055 \neq 0.074;
 therefore not independent

- 4 $\varepsilon = \{1, 2, 3, 4, 5, 6, 7, 8, 9, 10, 11, 12\}$

$$A = \{1, 2, 3, 4, 5, 6\},$$

$$B = \{1, 3, 5, 7, 9, 11\},$$

$$C = \{4, 6, 8, 9\}$$

$$\therefore \Pr(A) = \frac{1}{2}, \Pr(B) = \frac{1}{2}, \Pr(C) = \frac{1}{3}$$

a $A \cap B = \{1, 3, 5\}$

$$\therefore \Pr(A \cap B) = \frac{1}{4}$$

$\Pr(A) \Pr(B) = \frac{1}{4}$ so A and B are independent.

b $A \cap C = \{4, 6\}$

$$\therefore \Pr(A \cap C) = \frac{1}{6}$$

$\Pr(A) \Pr(C) = \frac{1}{6}$ so A and C are independent.

c $B \cap C = \{9\}$

$$\therefore \Pr(B \cap C) = \frac{1}{12}$$

$\Pr(B) \Pr(C) = \frac{1}{6}$ so B and C are not independent.

5 $\Pr(A \cap B)$

= Pr(even number and square number)

$$= \Pr(\{4\}) = \frac{1}{6}$$

$$\Pr(A) = \frac{3}{6} = \frac{1}{2}$$

and $\Pr(B) = \Pr(\{1, 4\}) = \frac{2}{6} = \frac{1}{3}$

$$\therefore \Pr(A \cap B) = \Pr(A) \times \Pr(B)$$

6 $\Pr(A) = 0.3, \Pr(B) = 0.1,$

$$\Pr(A \cap B) = 0.1$$

$\Pr(A) \Pr(B) = 0.03 \neq 0.1$, so A and B are not independent.

- 7 $\Pr(A) = 0.6, \Pr(B) = 0.7$, and A and B are independent

a $\Pr(A|B) = \Pr(A) = 0.6$

b $\Pr(A \cap B) = \Pr(A) \Pr(B)$

$$= 0.6(0.7) = 0.42$$

$$\begin{aligned} \text{c } \Pr(A \cap B) &= \Pr(A) + \Pr(B) \\ &\quad - \Pr(A \cap B) \\ \Pr(A \cup B) &= 0.6 + 0.7 - 0.42 = 0.88 \end{aligned}$$

$$\begin{aligned} \text{8 } \Pr(A \cap B) &= \Pr(A) \Pr(B) \\ &= 0.5(0.2) = 0.1 \\ \Pr(A \cup B) &= \Pr(A) + \Pr(B) - \Pr(A \cap B) \\ &= 0.5 + 0.2 - 0.1 = 0.6 \end{aligned}$$

9

Blood group	O	A	B	AB
Pr	0.5	0.35	0.1	0.05

- a $\Pr(A) = 0.35$
- b $\Pr(A, B) = 0.35(0.1) = 0.035$
- c $\Pr(A, A) = 0.35^2 = 0.1225$
- d $\Pr(O, AB) = 0.05(0.5) = 0.025$

10 $N = 165$:

	<i>H</i>	<i>N</i>	<i>L</i>
<i>M</i>	88	22	10
<i>F</i>	11	22	12

- a $\Pr(N) = \frac{44}{165} = \frac{4}{15}$
- b $\Pr(F \cap H) = \frac{11}{165} = \frac{1}{15}$
- c $\Pr(F \cup H) = \Pr(F) + \Pr(H) - \Pr(F \cap H)$
 $= \frac{45 + 99 - 11}{165} = \frac{133}{165}$
- d $\Pr(F|L) = \frac{\Pr(F \cap L)}{\Pr(L)}$
 $= \frac{12}{165} \div \frac{22}{165} = \frac{6}{11}$

$$\begin{aligned} \text{e } \Pr(L|F) &= \frac{\Pr(F \cap L)}{\Pr(F)} \\ &= \frac{12}{165} \div \frac{45}{165} = \frac{4}{15} \end{aligned}$$

F and *L* are not independent. If they were, then

$$\begin{aligned} \Pr(L|F) &= \Pr(L) \Pr(L) \\ &= \frac{45}{165} = \frac{3}{11} \neq \frac{4}{15} \end{aligned}$$

11 $\Pr(A) = \frac{20}{36} = \frac{5}{9}$
 $\Pr(B) = \frac{9}{36} = \frac{1}{4}$
 $\Pr(A \cap B) = \frac{5}{36} = \Pr(A) \Pr(B)$
 $\therefore A$ and B are independent.

12 $\Pr(W) = 0.4$, $\Pr(M) = 0.5$
 $\Pr(W|M) = 0.7 = \frac{\Pr(W \cap M)}{\Pr(M)}$

a $\Pr(W \cap M) = \Pr(W|M) \times \Pr(M)$
 $= 0.7(0.5) = 0.35$

b $\Pr(M|W) = \frac{\Pr(W \cap M)}{\Pr(W)}$
 $= \frac{0.35}{0.4} = \frac{7}{8}$ or 0.875

13 $N = 65$:

	<i>T</i>	<i>F</i>	<i>S</i>
<i>L</i>	13	4	1
<i>M</i>	8	10	3
<i>H</i>	2	16	8

- a $\Pr(L) = \frac{18}{65}$
- b $\Pr(S) = \frac{12}{65}$
- c $\Pr(T) = \frac{23}{65}$

$$\mathbf{d} \quad \Pr(M) = \frac{21}{65}$$

$$\mathbf{e} \quad \Pr(L \cap F) = \frac{4}{65}$$

$$\mathbf{f} \quad \Pr(T \cap M) = \frac{8}{65}$$

$$\mathbf{g} \quad \Pr(L|F) = \frac{4}{30} = \frac{2}{15}$$

$$\mathbf{h} \quad \Pr(I|M) = \frac{8}{21}$$

Income is not independent of age,

e.g.:

$$\Pr(L \cap F) = \frac{4}{65} = 0.0615, \text{ but}$$

$$\Pr(L) \Pr(F) = \left(\frac{18}{65}\right)\left(\frac{30}{65}\right) = 0.128$$

You would not expect middle managers' income to be independent of age.

14 $N = 150$:

	G	G'
F	48	16
F'	24	62

$$\mathbf{a} \quad \mathbf{i} \quad \Pr(G|F) = \frac{48}{64} = \frac{3}{4} = 0.75$$

$$\mathbf{ii} \quad \Pr(G \cap F) = \frac{48}{150} = 0.32$$

$$\mathbf{iii} \quad \Pr(G \cup F) = \frac{88}{150} = \frac{44}{75} = 0.587$$

$$\mathbf{b} \quad \Pr(G) \Pr(F) = \left(\frac{48 + 24}{150}\right)\left(\frac{48 + 16}{150}\right) \\ = \left(\frac{72}{150}\right)\left(\frac{64}{150}\right) = 0.2048$$

$$\Pr(G) \Pr(F) \neq \Pr(G \cap F)$$

$\therefore G$ and F are not independent.

c G and F not mutually exclusive:

$$\Pr(G \cap F) \neq 0$$

Solutions to Exercise 9H

- 1** We know the answer is $\frac{1}{8}$. Binomial with $p = \frac{1}{2}$ and $n = 3$. Simulate with random integers 0 and 1 with your calculator.

- 2** Binomial, $n = 5$ and $p = \frac{1}{2}$. It can be simulated with using random integers 0 and 1 with your calculator in a .
 $\Pr(X \geq 3)$:

X	3	4	5
$\Pr(X = x)$	0.3125	0.15625	0.03125

One in every two simulations would be expected to give this result.

- 3** Binomial, $n = 10$ and $p = 0.2$
 $\Pr(X \geq 5) = 0.032793$:
 Simulate with random integers 1-5.
 Choose one value to be correct for each question.
- 4** There are many possibilities here, but simplest would be to use a random number table, where each football card is given a number from 0 to 9.
 (The average number of purchases needed is exactly given by:

$$1 + \frac{10}{9} + \frac{10}{8} + \frac{10}{7} + \dots + \frac{10}{2} + \frac{10}{1} \approx 29.3)$$

This is known as the 'Collector's Problem'

- 5 a** Every player plays a match in the first round

$$\Pr(\text{playing 1 match}) = 1$$

Shaun has a 50% chance of winning the first (i.e. playing the second), so

$$\Pr(\text{playing 2 matches}) = 0.5$$

Then he has a probability of 0.5×0.5 of winning two matches (i.e. playing a third), so

$$\begin{aligned} \Pr(\text{playing 3 matches}) \\ = 0.5 \times 0.5 = 0.25 \end{aligned}$$

The value of playing a game is 1

\therefore

$$\begin{aligned} E(\text{number of matches}) &= 1 \times 1 + 1 \times 0.5 + 1 \times 0.25 \\ &= 1.75 \end{aligned}$$

- b** Repeating the above for the probability of winning of .7

$$\Pr(\text{playing 1 match}) = 1$$

$$\Pr(\text{playing 2 matches}) = 0.7$$

$$\Pr(\text{playing 3 matches})$$

$$= 0.7 \times 0.7 = 0.49$$

\therefore

$$\begin{aligned} E(\text{number of matches}) &= 1 \times 1 + 1 \times 0.7 + 1 \times 0.49 \\ &= 2.19 \end{aligned}$$

Solutions to Technology-free questions

1 a Six ways of getting 7

$$\therefore \Pr(7) = \frac{6}{36} = \frac{1}{6}$$

b $\Pr(7') = 1 - \frac{1}{6} = \frac{5}{6}$

2 $\Pr(O) = 0.993$

$$\therefore \Pr(O') = 1 - 0.993 = 0.007$$

3 a $\Pr(\text{divisible by } 3) = \frac{100}{300} = \frac{1}{3}$

b $\Pr(\text{divisible by } 4) = \frac{75}{300} = \frac{1}{4}$

c $\Pr(\text{divisible by } 3 \text{ or by } 4)$
 $= \frac{1}{3} + \frac{1}{4} - \Pr(\text{divisible by } 12)$
 $= \frac{7}{12} - \frac{25}{300} = \frac{1}{2}$

4 30 R, 20 B

$$\therefore \Pr(R) = 0.6$$

a $\Pr(R, R) = 0.6^2 = 0.36$

b No replacement:

$$\Pr(R, R) = \left(\frac{3}{5}\right)\left(\frac{29}{49}\right) = \frac{87}{245}$$

5 $A = \{1, 3, 5, 7, 9\}$, $B = \{1, 4, 9\}$

If $A + B = C$,

$C = \{2, 5, 10, 4, 7, 12, 6, 9, 14, 8, 11,$

$16, 10, 13, 18\}$

Of these, only $\{6, 9, 12, 18\}$ are divisible by 3.

$$\Pr(\text{sum divisible by } 3) = \frac{4}{15}$$

6 a $\epsilon = \{156, 165, 516, 561, 615, 651\}$

b $\Pr(> 400) = \frac{4}{6} = \frac{2}{3}$

c $\Pr(\text{even}) = \frac{2}{6} = \frac{1}{3}$

7 STATISTICIAN has 5 vowels and 7 consonants.

a $\Pr(\text{vowel}) = \frac{5}{12}$

b $\Pr(T) = \frac{3}{12} = \frac{1}{4}$

8 $\Pr(I) = 0.6$, $\Pr(J) = 0.1$, $\Pr(D) = 0.3$

a $\Pr(I, J, I) = 0.6(0.1)0.6$
 $= 0.036$

b $\Pr(D, D, D) = 0.3^3 = 0.027$

c $\Pr(I, D, D) + \Pr(J, D, D) +$
 $\Pr(D, I, D) + \Pr(D, J, D) +$
 $\Pr(D, D, I) + \Pr(D, D, J)$
 $= 3(0.6 + 0.1)(0.3^2)$
 $= 0.189$

d $\Pr(J') = 0.9$
 $\therefore \Pr(J', J', J') = 0.9^3 = 0.729$

9 $\Pr(R) = \frac{1}{3}$, $\Pr(B) = \frac{2}{3}$

a $\Pr(R, R, R) = \left(\frac{1}{3}\right)^3 = \frac{1}{27}$

b $\Pr(B, R, B) = \frac{2}{3}\left(\frac{1}{3}\right)\left(\frac{2}{3}\right) = \frac{4}{27}$

c $\Pr(R, B, B) + \Pr(B, R, B) +$

$$\begin{aligned} & \Pr(B, B, R) \\ &= 3 \left(\frac{4}{27} \right) = \frac{4}{9} \end{aligned}$$

d $\Pr(\geq 2B) = \Pr(B, B, B) + \Pr(2B)$

$$= \left(\frac{2}{3} \right)^3 + \frac{4}{9} = \frac{20}{27}$$

10 $\Pr(A) = 0.6, \Pr(B) = 0.5$

If A and B are mutually exclusive,

$$\Pr(A \cap B) = 0$$

By definition,

$$\begin{aligned} \Pr(A \cap B) &= \Pr(A) + \Pr(B) - \Pr(A \cup B) \\ &= 1.1 > 0 \end{aligned}$$

This is impossible, so they cannot be mutually exclusive.

11

\cap	B	B'	
A	0.1	0.5	0.6
A'	0.4	0	0.4
	$\Pr(B) = 0.5$	$\Pr(B') = 0.5$	1

a $\Pr(A \cap B') = 0.5$

b $\Pr(A' \cap B') = 0$

c $\Pr(A \cup B) = \Pr(A) + \Pr(B) - \Pr(A \cap B)$
 $= 0.6 + 0.5 - 0.1$
 $= 1$

12 a $\frac{7}{18}$

b $\frac{1}{2}$

13 $\Pr(B) = \frac{1}{3} \therefore \Pr(B') = \frac{2}{3}$

a $\Pr(A|B') = \frac{\Pr(A \cap B')}{\Pr(B')} = \frac{3}{7}$

$$\therefore \Pr(A \cap B') = \frac{3}{7} \left(\frac{2}{3} \right) = \frac{2}{7}$$

$$\Pr(A|B) = \frac{\Pr(A \cap B)}{\Pr(B)} = \frac{2}{3}$$

$$\therefore \Pr(A \cap B) = \frac{2}{3} \left(\frac{1}{3} \right) = \frac{2}{9}$$

b $\Pr(A) = \frac{2}{9} + \frac{2}{7} = \frac{32}{63}$

c $\Pr(B'|A) = \frac{\Pr(A \cap B')}{\Pr(A)}$
 $= \frac{2}{7} \div \frac{32}{63} = \frac{9}{16}$

14

Pr	O	N	U	Tot
H	0.1	0.08	0.02	0.2
H'	0.15	0.45	0.2	0.8
Tot	0.25	0.53	0.22	1

a $\Pr(H) = 0.2$

b $\Pr(H|O) = \frac{\Pr(H \cap O)}{\Pr(O)}$
 $= \frac{0.1}{0.25} = 0.4$

15 $\Pr(A) = 0.3, \Pr(B) = 0.6, \Pr(A \cap B) = 0.2$

a $\Pr(A \cup B) = \Pr(A) + \Pr(B) - \Pr(A \cap B) = 0.7$

\cap	B	B'	
A	0.2	0.1	0.3
A'	0.4	0.3	0.7
	0.6	0.4	1

b $\Pr(A' \cap B') = 0.3$

c $\Pr(A|B) = \frac{\Pr(A \cap B)}{\Pr(B)}$
 $= \frac{0.2}{0.6} = \frac{1}{3}$

$$\begin{aligned} \mathbf{d} \quad \Pr(B|A) &= \frac{\Pr(A \cap B)}{\Pr(A)} \\ &= \frac{0.2}{0.3} = \frac{2}{3} \end{aligned}$$

$$\mathbf{16 a} \quad \Pr(A|B) = \frac{\Pr(A \cap B)}{\Pr(B)}$$

If $\Pr(A|B) = 1$, then $\frac{\Pr(A \cap B)}{\Pr(B)} = 1$

$$\therefore \Pr(A \cap B) = \Pr(B)$$

$\therefore B$ is a subset of A .

$$\mathbf{b} \quad \Pr(A|B) = \frac{\Pr(A \cap B)}{\Pr(B)}$$

If $\Pr(A|B) = 0$, then $\frac{\Pr(A \cap B)}{\Pr(B)} = 0$

$$\therefore \Pr(A \cap B) = 0$$

$\therefore A$ and B are mutually exclusive or disjoint.

$$\mathbf{c} \quad \Pr(A|B) = \frac{\Pr(A \cap B)}{\Pr(B)}$$

If $\Pr(A|B) = \Pr(A)$, then

$$\frac{\Pr(A \cap B)}{\Pr(B)} = \Pr(A)$$

$$\therefore \Pr(A \cap B) = \Pr(A) \Pr(B)$$

$\therefore A$ and B are independent.

Solutions to multiple-choice questions

1 B $\Pr(< 50) = 1 - \Pr(\geq 50)$
 $= 1 - 0.7 = 0.3$

2 C $\Pr(G) = 1 - \Pr(G')$
 $= 1 - 0.7 = 0.3$

3 A 4 Ts in 10
 $\therefore \Pr(T) = \frac{2}{5}$

4 C $\Pr(C) = 1 - \Pr(C')$
 $= 1 - \frac{18}{25} = \frac{7}{25}$

5 D $\Pr(J \cup \spadesuit) = \frac{16}{52} = \frac{4}{13}$

6 A Area outside circle $= 16 - \pi(1.5)^2 \text{ m}^2$
 $\therefore \Pr = 1 - \frac{2.25\pi}{16} \cong 0.442$

7 D $\Pr(\text{Head and a six}) = \frac{1}{2} \times \frac{1}{6} = \frac{1}{12}$

8 E $\Pr(A) = 0.35$, $\Pr(A \cap B) = 0.18$,
 $\Pr(B) = 0.38$
 $\Pr(A \cup B) = 0.35 + 0.38 - 0.18$
 $= 0.55$

9 A $\Pr(A \cup B) = \Pr(A) + \Pr(B) - \Pr(A \cap B)$
 $= 0.47 + 0.28 - 0.28 = 0.47$

10 B $\Pr(B) = 0.32$
 $\Pr(F) = 0.57$
 $\Pr(F \cap B) = 0.11$

	<i>B</i>	<i>B'</i>	
<i>F</i>	0.11	0.46	0.57
<i>F'</i>	0.21	0.22	0.43
	0.32	0.68	1

11 B $\Pr(G) = \frac{3}{10} = \frac{9}{30}$,

$\Pr(M) = \frac{2}{3} = \frac{20}{30}$,

$\Pr(G' \cap M) = \frac{7}{15} = \frac{14}{30}$,

	<i>M</i>	<i>M'</i>	
<i>G</i>	$\Pr(G \cap M) = \frac{6}{30}$	$\Pr(G \cap M) = \frac{3}{30}$	$= \frac{9}{30}$
<i>G'</i>	$\Pr(G' \cap M) = \frac{14}{30}$	$\Pr(G' \cap M) = \frac{7}{30}$	$= \frac{21}{30}$
	$\Pr(M) = \frac{20}{30}$	$\Pr(M') = \frac{10}{30}$	1

$\Pr(G' \cap M') = \frac{7}{30}$

12 B
 13 A

14 E $\Pr(A|B) = \frac{\Pr(A \cap B)}{\Pr(B)}$
 $= \frac{8}{21} \div \frac{4}{7} = \frac{2}{3}$

15 C $\Pr(G, G) = 0.6(0.7) = 0.42$

16 A $\Pr(G, G) + \Pr(G, G')$
 $= 0.42 + (0.4)^2$
 $= 0.58$

17 B $\Pr(A \cap B) = \Pr(A) \Pr(B)$
 $= 0.35(0.46) = 0.161$

$\Pr(A \cup B) = \Pr(A) + \Pr(B)$
 $- \Pr(A \cap B)$
 $= 0.35 + 0.46 - 0.161$
 $= 0.649$

18 D The reliability
 $= 0.85 + 0.95 - 0.85 \times 0.95$
 $= 0.9925$

Solutions to extended-response questions

- 1 Let A = number of days it takes to build scenery.
Let B = number of days it takes to paint scenery.
Let C = number of days it takes to print programs.

- a Pr(building and painting scenery together taking exactly 15 days)

$$\begin{aligned} &= \Pr(A = 7) \times \Pr(B = 8) + \Pr(A = 8) \times \Pr(B = 7) \\ &= \frac{3}{10} \times \frac{1}{10} + \frac{4}{10} \times \frac{3}{10} \\ &= \frac{3 + 12}{100} \\ &= 0.15 \end{aligned}$$

- b Pr(all 3 tasks taking exactly 22 days)

$$\begin{aligned} &= \Pr(A = 6) \times \Pr(B = 8) \times \Pr(C = 8) + \Pr(A = 7) \times \Pr(B = 7) \times \Pr(C = 8) + \\ &\quad \Pr(A = 7) \times \Pr(B = 8) \times \Pr(C = 7) + \Pr(A = 8) \times \Pr(B = 6) \times \Pr(C = 8) + \\ &\quad \Pr(A = 8) \times \Pr(B = 7) \times \Pr(C = 7) + \Pr(A = 8) \times \Pr(B = 8) \times \Pr(C = 6) \\ &= \frac{3 \times 1 \times 2 + 3 \times 3 \times 2 + 3 \times 1 \times 4 + 4 \times 6 \times 2 + 4 \times 3 \times 4 + 4 \times 1 \times 4}{1000} \\ &= \frac{6 + 18 + 12 + 48 + 48 + 16}{1000} \\ &= \frac{148}{1000} \\ &= 0.148 \end{aligned}$$

- 2 a For bowl A , $\Pr(2 \text{ apples}) = \frac{3}{8} \times \frac{2}{7} = \frac{3}{28}$
For bowl B , $\Pr(2 \text{ apples}) = \frac{7}{8} \times \frac{6}{7} = \frac{3}{4}$

- b For bowl A , $\Pr(2 \text{ apples with replacement}) = \frac{3}{8} \times \frac{3}{8} = \frac{9}{64}$
For bowl B , $\Pr(2 \text{ apples with replacement}) = \frac{7}{8} \times \frac{7}{8} = \frac{49}{64}$

- c Let A be the event that bowl A is chosen.

Then

$$\begin{aligned} \Pr(A|2 \text{ apples}) &= \frac{\Pr(A \cap 2 \text{ apples without replacement})}{\Pr(2 \text{ apples without replacement})} \\ &= \frac{\frac{1}{2} \times \frac{3}{28}}{\frac{1}{2} \left(\frac{3}{28} + \frac{21}{28} \right)} = \frac{\frac{3}{28}}{\frac{3+21}{28}} \\ &= \frac{3}{24} = \frac{1}{8} = 0.125 \end{aligned}$$

d

$$\begin{aligned} \Pr(A|2 \text{ apples}) &= \frac{\Pr(A \cap 2 \text{ apples with replacement})}{\Pr(2 \text{ apples with replacement})} \\ &= \frac{\frac{1}{2} \times \frac{9}{64}}{\frac{1}{2} \left(\frac{9}{64} + \frac{49}{64} \right)} \\ &= \frac{9}{58} \\ &\cong 0.125 \end{aligned}$$

3 a $\frac{4}{5}$

b $\Pr(\text{running the day after}) = \frac{4}{5} \times \frac{4}{5} + \frac{1}{5} \times \frac{1}{4} = 0.69$

c $\Pr(\text{running exactly twice in the next three days}) =$

4 a The following structure is assumed.

$$\Pr(\text{Player winning 1 match}) = 0.5$$

$$\Pr(\text{Player winning 2 matches}) = 0.5 \times 0.5$$

$$\Pr(\text{Player winning 3 matches}) = 0.5 \times 0.5 \times 0.5$$

$$\Pr(\text{Player winning 4 matches}) = 0.5 \times 0.5 \times 0.5 \times 0.5$$

$$\begin{aligned} \therefore \text{expected number of matches} &= 0.5 \times 1 + 0.5^2 \times 2 + 0.5^3 \times 3 + 0.5^4 \times 4 \\ &= \frac{13}{8} \end{aligned}$$

b If probability of winning is 0.7, expected number of matches

$$= 0.7 \times 1 + 0.7^2 \times 2 + 0.7^3 \times 3 + 0.7^4 \times 4$$

$$= \frac{18347}{5000}$$

$$\approx 3.7$$

Simulation

a Use $\text{int}(\text{rand}() \cdot 2 + 1)$

If 1 occurs, a win is recorded. If 2 occurs, a loss is recorded. Sequence stops as soon as 2 is obtained. In the example to the right, the player plays 2 matches.

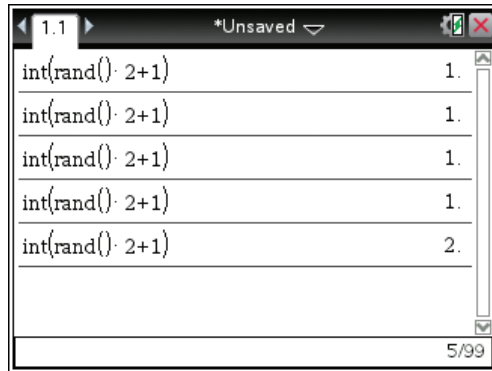

Formula	Result
$\text{int}(\text{rand}() \cdot 2 + 1)$	1.
$\text{int}(\text{rand}() \cdot 2 + 1)$	1.
$\text{int}(\text{rand}() \cdot 2 + 1)$	1.
$\text{int}(\text{rand}() \cdot 2 + 1)$	1.
$\text{int}(\text{rand}() \cdot 2 + 1)$	2.

b Use $\text{int}(\text{rand} * 10 + 1)$

If a digit 1 – 7 inclusive is obtained, a win is recorded. If 8 or 9 or 10 is obtained, a loss is recorded. In the example to the right, the player plays 5 matches.

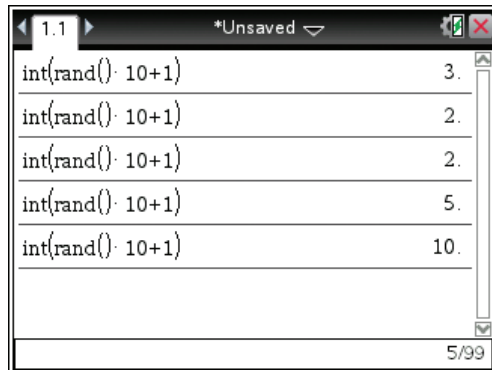

Formula	Result
$\text{int}(\text{rand}() \cdot 10 + 1)$	3.
$\text{int}(\text{rand}() \cdot 10 + 1)$	2.
$\text{int}(\text{rand}() \cdot 10 + 1)$	2.
$\text{int}(\text{rand}() \cdot 10 + 1)$	5.
$\text{int}(\text{rand}() \cdot 10 + 1)$	10.

5 a Theoretical answer

For teams *A* and *B*,

$$\begin{aligned} \text{probability of winning} &= \frac{1}{2} \times \frac{1}{2} + \frac{1}{2} \times \frac{1}{2} \times \frac{1}{2} \\ &= \frac{1}{4} + \frac{1}{8} \\ &= \frac{3}{8} \text{ or } 0.73 \end{aligned}$$

For teams *C* and *D*,

$$\text{probability of winning} = \frac{1}{2} \times \frac{1}{2} \times \frac{1}{2} = \frac{1}{8} \text{ or } 0.125$$

Simulation

TI: The following program simulates the final series and assigns equal probability of winning to each of the two teams in any game. It displays the winner of each game, and lastly the winner of the series.

```

prog5
Define LibPub prog5()=
Prgm
Local w,x,y,z
Disp "Game 1"
randInt(1,2)→x
If x=1 Then
Disp "A wins"
EndIf
If x=2 Then
Disp "B wins"
EndIf
Disp "Press ENTER to continue"
Disp "Game 2"
randInt(1,2)→y
If y=1 Then
Disp "C wins"
EndIf
If y=2 Then
Disp "D wins"
EndIf
Disp "Press ENTER to continue"
Disp "Game 3"

```

```

prog5
randInt(1,2)→z
If x=1 and z=1 Then
Disp "B wins"
EndIf
If x=2 and z=1 Then
Disp "A wins"
EndIf
If y=1 and z=2 Then
Disp "C wins"
EndIf
If y=2 and z=2 Then
Disp "D wins"
EndIf
Disp "Press ENTER to continue"
Disp "Game 4"
randInt(1,2)→w
If x=1 and w=1 or x=2 and z=1 and w=2 Then
Disp "A wins"
EndIf
If x=2 and w=1 or x=1 and z=1 and w=2 Then
Disp "B wins"
EndIf

```

```

If y=1 and z=2 and w=2 Then
  Disp "C wins"
EndIf
If y=2 and z=2 and w=2 Then
  Disp "D wins"
EndIf
0/99 EndPrgm

```

b Simulation

TI: The following program uses a simulation of 100 final series to estimate the probability of each team winning a final series. The estimated probabilities are displayed.

```

prog6
Define LibPub prog6()=
Prgm
Local a,b,c,d,n,w,x,y,z
0→a
0→b
0→c
0→d
For n,1,100
randInt(1,2)→x
randInt(1,2)→y
randInt(1,2)→z
randInt(1,2)→w
If x=1 and w=1 or x=2 and z=1 and w=2 Then
a+1→a
ElseIf x=2 and w=1 or x=1 and z=1 and w=2 Then
b+1→b
ElseIf y=1 and z=2 and w=2 Then
c+1→c
ElseIf y=2 and z=2 and w=2 Then
d+1→d
EndIf
EndFor
0/99

Disp "Pr(A wins) =",  $\frac{a}{100}$ 
Disp "Pr(B wins) =",  $\frac{b}{100}$ 
Disp "Pr(C wins) =",  $\frac{c}{100}$ 
Disp "Pr(D wins) =",  $\frac{d}{100}$ 
0/99 EndPrgm

```

Chapter 10 – Counting Methods

Solutions to Exercise 10A

1 a $8 + 3 = 11$

b $3 + 2 + 7 = 12$

c $22 + 14 + 1 = 37$

d $10 + 3 + 12 + 4 = 29$

2 a $3 \times 4 \times 5 = 60$ meals

b $10 \times 10 \times 5 = 500$ meals

c $5 \times 7 \times 10 = 350$ meals

d $8^3 = 512$ meals

3 Four choices of entrée, eight of main course and four of dessert.

a $4 \times 8 \times 4 = 128$ meals

b $128 + \text{no entrée: } 128 + 8 \times 4 = 160$ meals

4 $3 + 7 + 10 = 20$ choices

5 $S_1: 2 \times M, 3 \times L, 4 \times S = 9$ choices

$S_2: 2 \times H, 3 \times G, 2 \times A = 7$ choices

Total choices = $9 \times 7 = 63$ choices

6 M to B : 3 airlines or 3 buses

M to S : 4 airlines \times 5 buses.

Total choices = $3 + 3 + 4 \times 5 = 26$

7 $5(C) \times 3(T) \times 4(I) \times 2(E) \times 2(A) = 240$ choices

8 Possible codes = $(26)(10^4) = 260000$

9 No. of plates = $(26^3)(10^3) = 17\,576\,000$

10 2 (dot or dash) + 4 (2 digits) +
 8 (3 digits) + 16 (4 digits) = 30

Solutions to Exercise 10B

1 a $3! = 3 \times 2 \times 1 = 6$

b $5! = 5 \times 4 \times 3 \times 2 \times 1 = 120$

c $7! = 7 \times 6 \times 5 \times 4 \times 3 \times 2 \times 1 = 5040$

d $2! = 2 \times 1 = 2$

e $0! = 1$

f $1! = 1$

2 a $\frac{5!}{3!} = \frac{5 \times 4 \times 3 \times 2 \times 1}{3 \times 2 \times 1} = (5)(4) = 20$

b $\frac{9!}{7!} = (9)(8) = 72$

c $\frac{3!}{0!} = \frac{6}{1} = 6$

d $\frac{8!}{6!} = (8)(7) = 56$

e $\frac{5!}{0!} = \frac{120}{1} = 120$

f $\frac{10!}{7!} = (10)(9)(8) = 720$

3 $5! = 120$ ways

4 $7! = 5040$ ways

5 $4! = 24$ ways

6 $6! = 720$ ways

7 $\frac{10!}{7!} = 720$ ways

8 $\frac{8!}{5!} = 336$ ways

9 TROUBLE:

a All letters used = $7! = 5040$ ways

b Three letters only = $\frac{7!}{4!} = 210$ ways

10 PANIC:

a All letters used = $5! = 120$ ways

b Four letters only = $\frac{5!}{1!} = 120$ ways

11 COMPLEX:

a No re-use: $\frac{7!}{3!} = 840$ ways

b Re-use: $7^4 = 2401$ ways

12 NUMBER:

a No re-use: $\frac{6!}{3!}(3\text{-letter}) + \frac{6!}{2!}(4\text{-letter})$
 $= 120 + 360 = 480$ codes

b Re-use: $6^3 + 6^4 = 1512$ codes

13 $\epsilon = \{3, 4, 5, 6, 7\}$, no re-use:

a $\frac{5!}{2!} = 60$ 3-digit numbers

b Even 3-digit numbers: must end in 4 or 6, so 2 possibilities only for last digit. 4 possibilities then for 1st digit and 3 for 2nd digit.

$\therefore 4 \times 3 \times 2 = 24$ possible even numbers.

c Numbers > 700 :
 3-digit numbers must begin with 7
 $\therefore 4 \times 3 = 12$
 4-digit numbers: $\frac{5!}{1!} = 120$
 5-digit numbers: $5! = 120$
 Total = 252 numbers

c > 7000 : 4-digit numbers must begin
 with 7 or 8: $2 \times \frac{5!}{2!} = 120$
 5-digit numbers: $\frac{6!}{1!} = 720$
 6-digit numbers: $6! = 720$
 Total = 1560 numbers

14 $\epsilon = \{3, 4, 5, 6, 7, 8\}$, no re-use:

a 2-digit + 3-digit: $\frac{6!}{4!} + \frac{6!}{3!} = 150$

b 6-digit even: $3 \times 5! = 360$

15 4 boys, 2 girls:

a No restrictions: $6! = 720$ ways

b 2 ways for girls at end $\times 4!$ for boys
 $= 48$ ways

Solutions to Exercise 10C

1 a $(V, C), (V, S), (C, S) = 3$

b $(J, G), (J, W), (G, W) = 3$

c $(T, W), (T, J), (T, P), (W, J), (W, P), (J, P) = 6$

d $(B, G, R), (B, G, W), (B, R, W), (G, R, W) = 4$

2 a ${}^5C_3 = \frac{5 \times 4 \times 3 \times 2 \times 1}{3 \times 2 \times 1 \times 2 \times 1} = 10$

b ${}^5C_2 = \frac{5 \times 4 \times 3 \times 2 \times 1}{2 \times 1 \times 3 \times 2 \times 1} = 10$

c ${}^7C_4 = \frac{7 \times 6 \times 5 \times 4 \times 3 \times 2 \times 1}{4 \times 3 \times 2 \times 1 \times 3 \times 2 \times 1} = 35$

d ${}^7C_3 = \frac{7 \times 6 \times 5 \times 4 \times 3 \times 2 \times 1}{3 \times 2 \times 1 \times 4 \times 3 \times 2 \times 1} = 35$
a = b, c = d

3 a ${}^7C_3 = \frac{20 \times 19}{2} = 190$

b ${}^{100}C_{99} = 100$

c ${}^{100}C_2 = \frac{100 \times 99}{2} = 4950$

d ${}^{250}C_{248} = \frac{250 \times 249}{2} = 31\,125$

4 a $\binom{6}{3} = \frac{6 \times 5 \times 4 \times 3 \times 2 \times 1}{3 \times 2 \times 1 \times 3 \times 2 \times 1} = 20$

b $\binom{7}{1} = \frac{7 \times 6 \times 5 \times 4 \times 3 \times 2 \times 1}{1 \times 6 \times 5 \times 4 \times 3 \times 2 \times 1} = 7$

c $\binom{8}{2} = \frac{8 \times 7 \times 6 \times 5 \times 4 \times 3 \times 2 \times 1}{2 \times 1 \times 6 \times 5 \times 4 \times 3 \times 2 \times 1} = 28$

d $\binom{50}{48} = \frac{50 \times 49}{2} = 1225$

5 $\binom{13}{7} = \frac{13 \times 12 \times 11 \times 10 \times 9 \times 8}{6 \times 5 \times 4 \times 3 \times 2 \times 1} = 1716$

6 $\binom{25}{3} = \frac{25 \times 24 \times 23}{3 \times 2 \times 1} = 2300$

7 $\binom{52}{7} = \frac{52 \times 51 \times 50 \times 49 \times 48 \times 47 \times 46}{7 \times 6 \times 5 \times 4 \times 3 \times 2 \times 1} = 133\,784\,560$

8 $\binom{45}{6} = \frac{45 \times 44 \times 43 \times 42 \times 41 \times 40}{6 \times 5 \times 4 \times 3 \times 2 \times 1} = 8\,145\,060$

9 $\binom{3}{4} \binom{4}{2} = \left(\frac{3 \times 2 \times 1}{1 \times 2 \times 1} \right) \left(\frac{4 \times 3 \times 2 \times 1}{2 \times 1 \times 2 \times 1} \right) = 18$

10 a $\binom{30}{8} = \frac{30 \times 29 \times 28 \times 27 \times 26 \times 25 \times 24 \times 23}{8 \times 7 \times 6 \times 5 \times 4 \times 3 \times 2 \times 1} = 5\,852\,925$

b Choose 2 men first:

$$\binom{10}{2} = \frac{10 \times 9}{2} = 45$$

6 women: $\binom{20}{6}$

$$= \frac{20 \times 19 \times 18 \times 17 \times 16 \times 15}{720}$$

$$= 38\,760$$

$$\text{Total} = 45 \times 38\,760 = 1\,744\,200$$

c $5F: \binom{6}{5} = 6$

d 5 any: $\binom{11}{5} =$

$$\frac{11 \times 10 \times 9 \times 8 \times 7 \times 6}{6 \times 5 \times 4 \times 3 \times 2 \times 1} = 462$$

e $\geq 4F = n(4F + 1M) + n(5F)$

$$= 75 + 6 = 81$$

11 $2\heartsuit: \binom{13}{2} = \frac{13 \times 12}{2} = 78$

$5\spadesuit: \binom{13}{5} = \frac{13 \times 12 \times 11 \times 10 \times 9}{120}$

$$= 1287$$

7-card hands of $5\spadesuit, 2\heartsuit = 1287 \times 78$

$$= 100\,386$$

12 a Without restriction:

$$\binom{12}{5} = \frac{12 \times 11 \times 10 \times 9 \times 8}{120} = 792$$

b $3W + 2M: \binom{8}{3} \binom{4}{2} = (56)(6) = 336$

13 $6F, 5M, 5$ positions:

a $2F + 3M: \binom{6}{2} \binom{5}{3} = (15)(10) = 150$

b $4F + 1M: \binom{6}{4} \binom{5}{1} = (15)(5) = 75$

14 $15T, 12F, 10$ selections:

a Unrestricted: $\binom{27}{10} = 8\,436\,285$

b $10T$ only: $\binom{15}{10} = 3003$

c $10F$ only: $\binom{12}{10} = 66$

d $5T + 5F: \binom{12}{5} \binom{15}{5} = 2\,378\,376$

15 $6F, 4M, 5$ positions:

$$3F + 2M \binom{6}{3} \binom{4}{2} = (20)(6) = 120$$

$$4F + 1M \binom{6}{4} \binom{4}{1} = (15)(4) = 60$$

$$5F \text{ only: } \binom{6}{5} = 6$$

$$\text{Total} = 186$$

16 Each of the five times she can choose or refuse

$$\therefore \text{Total choices} = 2^5 = 32$$

17 Total choices

$$= \binom{8}{0} + \binom{8}{1} + \binom{8}{2} + \cdots + \binom{8}{8}$$

$$= 2^8 = 256$$

19 6 fruits, must choose ≥ 2 :

$$\text{choices} = \binom{6}{2} + \binom{6}{3} + \cdots + \binom{6}{6}$$

$$= 2^6 - 7 = 57$$

18 Total colours (cannot choose no colours)

$$= \binom{5}{1} + \binom{5}{2} + \cdots + \binom{5}{5}$$

$$= 2^5 - 1 = 31$$

20 6 people, 2 groups:

a n (two equal groups) $= \binom{6}{3} = 20$

b n (2 unequal groups) $= \binom{6}{1} + \binom{6}{2} = 21$

Solutions to Exercise 10D

1 $\epsilon = \{1, 2, 3, 4, 5, 6\}$

4 digits, no repetitions; number being even or odd depends only on the last digit.

There are 3 odd and 3 even numbers, so:

a $\Pr(\text{even}) = 0.5$

b $\Pr(\text{odd}) = 0.5$

2 COMPUTER:

$\Pr(\text{1st letter vowel}) = \frac{3}{8} = 0.375$

3 HEART; 3 letters chosen:

a $\Pr(H1\text{st}) = \frac{1}{5} = 0.2$

b $\Pr(H) = 1 - \Pr(H')$
 $= \left(1 - \left(\frac{4}{5}\right)\left(\frac{3}{4}\right)\left(\frac{2}{3}\right)\right)$
 $= 1 - \frac{2}{5} = 0.6$

c $\Pr(\text{both vowels}) = 3 \left(\frac{2}{5}\right)\left(\frac{1}{4}\right) = 0.3$
 (Multiply by 3 because the consonant could be in any of the 3 positions.)

4 There are $6! = 720$ ways of filling the 6 seats, but only $2 \binom{3}{2} 4! = 144$ have end places with women.

$\therefore \Pr = \frac{144}{720} = 0.2$

5 7W, 6M, team of 7:

$\binom{13}{7} = 1716$ possible teams

$3W + 4M : \binom{7}{3} \binom{6}{4} = (35)(15) = 525$

$2W + 5M : \binom{7}{2} \binom{6}{5} = (21)(6) = 126$

$1W + 6M : \binom{7}{1} \binom{6}{6} = 7$

658 arrangements with more men than women

$\therefore \Pr = \frac{658}{1716} = \frac{329}{858}$

6 8 possible combinations, so there are a total of $2^8 - 1 = 255$ possible sandwiches.

a $2^7 = 128$ including H
 $\therefore \Pr(H) = \frac{128}{255} = 0.502$

b $\binom{8}{3} = 56$ have 3 ingredients
 $\therefore \Pr = \frac{56}{255}$

c $\binom{8}{3} + \binom{8}{4} + \binom{8}{5} + \dots + \binom{8}{8}$
 $= 219$ contain ≥ 3 ingredients
 $\therefore \Pr = \frac{219}{255} = \frac{73}{85}$

7 5W, 6R, 7B, no replacement:

a $\Pr(R, R, R) = \frac{6}{18} \times \frac{5}{17} \times \frac{4}{16} = \frac{5}{204}$

b There are exactly $\binom{18}{15} = 816$

selections.

$\binom{5}{1} \binom{6}{1} \binom{7}{1} = 210$ have all 3 colours.

$\therefore \Pr(\text{all different colours})$
 $= \frac{210}{816} = \frac{35}{136}$

8 $\epsilon = \{0, 1, 2, 3, 4, 5, 6, 7\}$
 4 four-digit number (with no repetitions)
 $= \frac{8}{4}! = 1680$ possible numbers, but any
 beginning with zero must be taken out,
 and there are $\frac{7}{4}! = 210$ of these.
 $\therefore 1470$ numbers

a,b It is easier to find the probability of
 an odd number first. Begin with the
 last digit: 4 odd numbers. Then look
 at the first digit: cannot have zero, so
 6 numbers. Then there are 6 choices
 for the second digit and 5 choices for
 the first.

Total choices $= 6 \times 6 \times 5 \times 4 = 720$.
 So $\Pr(\text{odd}) = \frac{720}{1170} = \frac{24}{49}$
 Then $\Pr(\text{even}) = 1 - \frac{24}{49} = \frac{25}{49}$

c $\Pr(< 4000)$: must begin with 1, 2 or
 3.
 Since there are no other restrictions,
 $\Pr(< 4000) = \frac{3}{7}$

d $\frac{\Pr(< 4000 | > 3000)}{\Pr(3000 < N < 4000)}$
 $\frac{\Pr(N > 3000)}{\Pr(3000 < N < 4000)}$
 For $N > 3000$ it cannot begin with 1
 or 2: $\therefore 6$ possibilities
 3 other numbers are unrestricted
 $\therefore \text{total } (N > 3000) = 6 \left(\frac{7!}{4!}\right) = 1260$
 For $3000 < N < 4000$ it must begin
 with 3, so $\frac{7!}{4!} = 210$ satisfy this
 restriction.
 $\therefore \frac{\Pr(3000 < N < 4000)}{\Pr(N > 3000)} = \frac{210}{1260}$
 $= \frac{1}{6}$

9 5R, 2B, 3G, 4 picks,

$\binom{10}{4} = 210$ selections:

a $\Pr(G', G', G', G') =$
 $\left(\frac{7}{10}\right)\left(\frac{6}{9}\right)\left(\frac{5}{8}\right)\left(\frac{4}{7}\right) = \frac{1}{6}$

b $\Pr(\geq 1G) = 1 - \Pr(\text{No } G) = \frac{5}{6}$

c $\Pr(\geq 1G \cap \geq 1R)$:
 $N(G + R + B + B) = \binom{3}{1}\binom{5}{1}\binom{2}{2} = 15$

$N(G + R + R + B) = \binom{3}{1}\binom{5}{2}\binom{2}{1} = 60$

$N(G + G + R + B) = \binom{3}{2}\binom{5}{1}\binom{2}{1} = 30$

$N(G + G + R + R) = \binom{3}{2}\binom{5}{2} = 30$

$N(G + G + G + R) = \binom{3}{3}\binom{5}{1} = 5$

$N(G + R + R + R) = \binom{3}{1}\binom{5}{3} = 30$

Total = 170
 $\therefore \Pr(\geq 1G \cap \geq 1R) = \frac{17}{21}$

d $\frac{\Pr(\geq 1R | \geq 1G)}{\Pr(\geq 1G)} = \frac{17}{21} \div \frac{5}{6} = \frac{34}{35}$

10 52 cards, 5 selections, no replacement:

a $\Pr(A', A', A', A', A') =$
 $\left(\frac{48}{52}\right)\left(\frac{47}{51}\right)\left(\frac{46}{50}\right)\left(\frac{45}{49}\right)\left(\frac{44}{48}\right) = 0.659$

b $\Pr(\geq 1A) = 1 - 0.659 = 0.341$

c $\binom{52}{5}$ hands, $\binom{51}{4}$ contain $A\spadesuit$

$$\begin{aligned} \therefore \Pr(A\spadesuit) &= \frac{51 \times 50 \times 49 \times 48}{52 \times 51 \times 50 \times 49 \times 48} \\ &= \frac{4 \times 3 \times 2 \times 1}{5 \times 4 \times 3 \times 2 \times 1} \\ &= \frac{5}{52} \cong 0.096 \end{aligned}$$

d $\Pr(A\spadesuit | \geq 1A) = \Pr(A\spadesuit) \div \Pr(\geq 1A)$

$$= \frac{5}{52} \div 0.341 \cong 0.282$$

(You cannot simply say that the ace is equally likely to be any of the 4 ($\Pr = \frac{1}{4}$) because there could be more than one ace, hence $\Pr > \frac{1}{4}$.)

11 $5W, 4M, 3$ selections, no replacement:

a $\Pr(W, W, W) = \left(\frac{5}{9}\right)\left(\frac{4}{8}\right)\left(\frac{3}{7}\right) = \frac{5}{42}$

b $\Pr(\geq 1W) = 1 - \Pr(M, M, M)$

$$\begin{aligned} &= 1 - \left(\frac{4}{9}\right)\left(\frac{3}{8}\right)\left(\frac{2}{7}\right) \\ &= \frac{20}{21} \end{aligned}$$

c $\Pr(2M | \geq 1M) = \frac{\Pr(2M)}{1 - \Pr(W, W, W)}$

$$\Pr(2M): \binom{9}{3} = \frac{9 \times 8 \times 7}{6} = 84$$

selections;

$$\binom{4}{2}\binom{5}{1} = 30 \text{ have } 2M$$

$$\therefore \Pr(2M) = \frac{30}{84} = \frac{15}{42}$$

$$\Pr(2M | \geq 1M) = \frac{15}{42} \div \frac{37}{42} = \frac{15}{37}$$

Solutions to Exercise 10E

1 a $x^4 + 8x^3 + 24x^2 + 32x + 16$

b $16x^4 + 32x^3 + 24x^2 + 8x + 1$

c $16x^4 - 96x^3 + 216x^2 - 216x + 81$

d $27x^3 - 27x^2 + 9x - 1$

e $16x^4 - 32x^3 + 24x^2 - 8x + 1$

f $-32x^5 + 80x^4 - 80x^3 + 40x^2 - 10x + 1$

g $-243x^5 + 405x^4 - 270x^3 + 90x^2 - 15x + 1$

h $16x^4 - 96x^3 + 216x^2 - 216x + 81$

Solutions to Technology-free questions

1 a ${}^{1000}C_{998} = \frac{1000 \times 999}{2} = 499\,500$

b ${}^{1000000}C_{99999} = 1\,000\,000$

c ${}^{100000}C_1 = 1\,000\,000$

2 Integers 100 to 999 with 3 different digits:

9 ways of choosing the 1st, 9 ways of choosing the 2nd, 8 ways of choosing the 3rd = $9 \times 9 \times 8 = 648$

3 1, 2, 3, 4, 5, 6, 3 digits, no replacement
 $= \frac{6!}{3!} = 120$

4 n brands, 4 sizes, 2 scents = $8n$ types

5 9000 integers from 1000 to 9999:

$$N(5' + 7') = 7(1\text{st}) \times 8^3(2\text{nd to 4th})$$

$$= 3584$$

$\therefore 9000 - 3584 = 5416$ have at least one 5 or 7

6 50M, 30W, choose 2M, 1 W:

$$\binom{50}{2} \binom{30}{1} = 36750 \text{ committees.}$$

7 Choose 2 V from 5, 2C from 21, no replacement:

$$\binom{5}{2} \binom{21}{2} = 2100 \text{ possible choices.}$$

Each can be arranged in $4!$ ways
 $= 2100 \times 24 = 50400$ possible words

8 a 3 toppings from 5, no replacement
 $= \binom{5}{3} = 10$

b 5 toppings can be present or not
 $= 2^5 = 32$

9 7 people to be arranged, always with A and B with exactly one of the others between them:

Arrange (A, X, B) in a block of 3. This can be either (A, X, B) or (B, X, A), and X could be any one of 5 other people.

\therefore 10 possibilities for this block.

There are 4 other people, plus this block, who can be arranged in $5!$ ways.

\therefore Total $N = 10 \times 5!$

$$= 1200 \text{ arrangements}$$

10 OLYMPICS: 31 letters chosen:

a All letters equally likely

$$\therefore \Pr(\text{O, X, X}) = \frac{1}{8}$$

b $\Pr(Y') = \frac{7}{8} \left(\frac{6}{7} \right) \frac{5}{6} = \frac{5}{8}$

$$\therefore \Pr(Y) = \frac{3}{8}$$

c $N(\text{O} \cap \text{I})$ has $3!$ arrangements of O, I, X

$$\Pr(\text{O, I, X}) = \frac{1}{8} \left(\frac{1}{7} \right) \frac{6}{6} = \frac{1}{56}$$

$$\therefore \Pr(\text{both chosen}) = \frac{6}{56} = \frac{3}{28}$$

Solutions to multiple-choice questions

1 E $\binom{8}{1}\binom{3}{1}\binom{4}{1} = 96$

2 D $\binom{3}{1}M \times (\binom{5}{1}L + \binom{3}{1}S) = 24$

3 A 10 people, so possible arrangements
 $= 10!$

4 D 2 letters, 4 digits, no replacement:
 $= \left(\frac{26!}{24!}\right)\left(\frac{10!}{6!}\right) = 3276000$

5 C ${}^{21}C_3 = \frac{21!}{3!18!}$

6 B 52 cards, 6 chosen, no replacement:
 ${}^{52}C_6$

7 C 12 DVDs, 3 chosen, no replays:
 ${}^{12}C_3 = 220$

8 A 10G, 14B, 2 of each:
 ${}^{10}C_2 \times {}^{14}C_2$

9 E METHODS:
 $\Pr(\text{vowel 1st}) = \frac{2}{7}$

10 E 4M, 4F, choose 4:
 $\binom{8}{4} = 70$ teams

$$N(3W, 1M) = \binom{4}{3}\binom{4}{1} = 16$$

$$\therefore \Pr(3W, 1M) = \frac{16}{70} = \frac{8}{35}$$

Solutions to extended-response questions

- 1 a 1, 2, 3, 4, ..., 9 Even digits: 2, 4, 6, 8 Odd digits: 1, 3, 5, 7, 9

The multiplication principle gives

$$5 \times 4 \times 4 \times 3 \times 3 \times 2 \times 2 \times 1 \times 1 = 2880 \text{ ways.}$$

- b The digits 1 and 2 are considered as a block.

The block can be organised in $2! = 2 \times 1$ ways, i.e. 12 21

There are 8 objects to arrange $\boxed{12} 3 4 5 6 7 8 9$

\therefore 8! arrangements

Total number of arrangements = $8! \times 2! = 80640$.

- 2 a Three people can be seated in $10 \times 9 \times 8 = 720$ ways in 10 chairs.

- b Two end chairs can be occupied in $3 \times 2 = 6$ ways. This leaves 8 chairs for the remaining person to choose from, i.e. $6 \times 8 = 48$ ways of choosing a seat.

- c If two end seats are empty it leaves 8 chairs to occupy: $8 \times 7 \times 6 = 336$ ways

- 3 a The odd digits are 1, 3, 5, 7, 9.

The number three-digit numbers which can be formed = $5 \times 4 \times 3 = 60$,

i.e. there are 60 different three-digit numbers formed from the odd digits, using each digit only once.

- b The numbers greater than 350.

Case 1: Consider numbers greater than or equal to 500.

The first digit can be chosen in 3 ways (it must be 5, 7 or 9). The second digit can be chosen in 4 ways, and the third digit in 3 ways.

There are $3 \times 4 \times 3 = 36$ such numbers.

Case 2: Consider numbers greater than 350 but less than 500.

The first digit can be chosen in one way. It must be 3. The second digit can be chosen in 3 ways (it must be 5, 7 or 9) and the third digit in 3 ways.

There are $1 \times 3 \times 3 = 9$ numbers.

Therefore a total of 45 numbers are greater than 350.

- 4 a There are ${}^{10}C_4 = 210$ ways of choosing a committee of 4 from 10 people.

- b there are two men and two women to be selected, there are ${}^5C_2 \times {}^5C_2$ ways of doing this. That is, there are 100 ways of forming the committee.

- c When a man is on a committee his wife can't be on it.

Method 1

- If there are 4 men on the committee, then the condition is satisfied.
There are 5 ways of choosing such a committee.
- If there are 4 women on the committee, then the condition is satisfied.
There are 5 ways of choosing such a committee.
- If there are three men on the committee, then the other place can be chosen in 2 ways.
There are $2 \times {}^5C_3 = 2 \times 10 = 20$ ways having this situation.
- If there are two men on the committee, then the other two places can be chosen in 3C_2 ways.
There are ${}^5C_2 \times {}^3C_2 = 10 \times 3 = 30$ ways having this situation.
- If there is one man on the committee, then the other three places can be chosen in 4C_3 ways.
There are ${}^5C_1 \times {}^4C_3 = 5 \times 4 = 20$ ways having this situation.

Therefore the total number of ways = $5 + 5 + 20 + 30 + 20 = 80$.

Method 2

Another way of considering this is with order.

The first person can be chosen in 10 ways.

The second in 8 (as the partner is also ruled out).

The third in 6 and the fourth in 4 ways.

This gives $10 \times 8 \times 6 \times 4 = 1920$ ways, but here order has been considered, and so divide by $4! = 24$ to give $\frac{1920}{24} = 80$.

- 5 a There are ${}^{15}C_4 = 1365$ ways of selecting the batteries.
- b There are ${}^{10}C_4 = 210$ ways of selecting 10 charged batteries.
- c Having at least one flat battery = total number – none flat
- $$= 1365 - 210$$
- $$= 1155$$

- 6 a** There are ${}^{18}C_4 = 3060$ ways of selecting the lollies.
- b** There are ${}^{11}C_4 = 330$ ways of choosing the lollies with no mints.
- c** There are ${}^{11}C_2 \times 7C_2 = 1155$ ways having two mints and two jubes.

7 Division 1

The number of ways of choosing 6 winning numbers from 45

$$= {}^{45}C_6$$

$$= 8\,145\,060$$

$$\therefore \text{probability of winning Division 1} = \frac{1}{8\,145\,060}$$

$$= 1.2277\dots \times 10^{-7}$$

$$\approx 1.228 \times 10^{-7}$$

Division 2

There are 6 winning numbers, 2 supplementary numbers, and 37 other numbers

\therefore number of ways of obtaining 5 winning numbers and a supplementary

$$= {}^6C_5 \times {}^2C_1 \times {}^{37}C_0$$

$$= 6 \times 2$$

$$= 12$$

$$\therefore \text{probability of winning Division 2} = \frac{12}{8\,145\,060}$$

$$= 1.4732\dots \times 10^{-6}$$

$$\approx 1.473 \times 10^{-6}$$

Division 3

Number of ways of obtaining 5 winning numbers and no supplementary

$$= {}^6C_5 \times {}^2C_0 \times {}^{37}C_1$$

$$= 6 \times 37$$

$$= 222$$

$$\therefore \text{probability of winning Division 3} = \frac{222}{8\,145\,060}$$

$$= 2.7255\dots \times 10^{-5}$$

$$\approx 2.726 \times 10^{-5}$$

Division 4

Number of ways of obtaining 4 winning numbers

$$= {}^6C_4 \times {}^{39}C_2$$

$$= 15 \times 741$$

$$= 11\,115$$

$$\begin{aligned} \therefore \text{probability of winning Division 4} &= \frac{11\,115}{8\,145\,060} \\ &= 0.001\,364\,6\dots \\ &\approx 1.365 \times 10^{-3} \end{aligned}$$

Division 5

Number of ways of obtaining 3 winning numbers and at least one supplementary

$$= {}^6C_3 \times 2C_1 \times 37C_2 + {}^6C_3 \times 2C_2 \times 37C_1$$

$$= 20 \times 2 \times 666 + 20 \times 37$$

$$= 27\,380$$

$$\begin{aligned} \therefore \text{probability of winning Division 5} &= \frac{27\,380}{8\,145\,060} \\ &= 0.003\,3615\dots \\ &\approx 3.362 \times 10^{-3} \end{aligned}$$

8 a Spot 6

The number of ways of selecting 6 numbers from 80

$$= {}^{80}C_6$$

$$= 300\,500\,200$$

20 numbers are winning numbers

The number of ways of selecting 6 numbers from 20

$$= {}^{20}C_6$$

$$= 38\,760$$

$$\begin{aligned} \therefore \text{probability of winning with Spot 6} &= \frac{38\,760}{300\,500\,200} \\ &= 1.2898\dots \times 10^{-4} \\ &\approx 1.290 \times 10^{-4} \end{aligned}$$

b Spot5

The probability of winning with Spot = $\frac{{}^{20}C_5}{{}^{80}C_5}$

$$\begin{aligned} &= \frac{15504}{24\,040\,016} \\ &= 6.4492 \dots \times 10^{-4} \\ &\approx 6.449 \times 10^{-4} \end{aligned}$$

Chapter 11 – Discrete probability distributions

Solutions to Exercise 11A

- 1 a Not a prob. function, $\sum \text{Pr} \neq 1$
 b Not a prob. function, $\sum \text{Pr} \neq 1$
 c Prob. function: $\sum \text{Pr} = 1$ and $0 \leq p \leq 1$ for all p
 d Not a prob. function, $\sum \text{Pr} \neq 1$
 e Not a prob. function because $p(3) < 0$

- 2 a $\text{Pr}(X = 2)$
 b $\text{Pr}(X > 2)$
 c $\text{Pr}(X \geq 2)$
 d $\text{Pr}(X < 2)$
 e $\text{Pr}(X \geq 2)$
 f $\text{Pr}(X > 2)$
 g $\text{Pr}(X \leq 2)$
 h $\text{Pr}(X \geq 2)$
 i $\text{Pr}(X \leq 2)$
 j $\text{Pr}(X \geq 2)$
 k $\text{Pr}(2 < X < 5)$

- 3 a $\text{Pr}(X = 2): \{2\}$
 b $\text{Pr}(X > 2): \{3, 4, 5\}$
 c $\text{Pr}(X \geq 2): \{2, 3, 4, 5\}$
 d $\text{Pr}(X < 2): \{0, 1\}$

- e $\text{Pr}(X \leq 2): \{0, 1, 2\}$
 f $\text{Pr}(2 \leq X \leq 5): \{2, 3, 4, 5\}$
 g $\text{Pr}(2 < X \leq 5): \{3, 4, 5\}$
 h $\text{Pr}(2 \leq X < 5): \{2, 3, 4\}$
 i $\text{Pr}(2 < X < 5): \{3, 4\}$

- 4 a 0.2
 b 0.5
 c 0.3
 d 0.35
 e 0.9

5

x	1	2	3	4	5
$\text{Pr}(X = x)$	k	$2k$	$3k$	$4k$	$5k$

- a $\sum \text{Pr} = 15k = 1$
 $\therefore k = \frac{1}{15}$
 b $\text{Pr}(2 \leq X \leq 4) = \frac{9k}{15k} = \frac{3}{5}$

6

r	0	1	2	3	4	5	6	7
p	.09	.22	.26	.21	.13	.06	.02	.01

- a $\text{Pr}(X > 4) = 0.06 + 0.02 + 0.01 = 0.09$
 b $\text{Pr}(X \geq 2) = 0.26 + 0.13 + 0.21 + 0.09 = 0.69$

7

y	.2	.3	.4	.5	.6	.7	.8	.9
p	.08	.13	.09	.19	.2	.03	.1	.18

a $\Pr(Y \leq 0.50)$
 $= 0.08 + 0.13 + 0.09 + 0.19$
 $= 0.49$

b $\Pr(Y > 0.50) = 1 - 0.49 = 0.51$

c $\Pr(0.30 \leq Y \leq 0.80)$
 $= 1 - (0.08 + 0.18)$
 $= 0.74$

8

x	1	2	3	4	5	6
p	0.10	0.13	0.17	0.27	0.20	0.13

a $\Pr(X > 3) = 0.27 + 0.2 + 0.13 = 0.6$

b $\Pr(3 < X < 6) = 0.27 + 0.20 = 0.47$

c
 $\Pr(X \geq 4 | X \geq 2) = \frac{\Pr(X \geq 4)}{\Pr(X \geq 2)}$
 $= \frac{0.27 + 0.20 + 0.13}{1 - 0.1}$
 $= \frac{0.60}{0.9} = \frac{2}{3}$

9 a $\{(H, H, H), (H, H, T), (H, T, H), (H, T, T), (T, H, H), (T, H, T), (T, T, H), (T, T, T)\}$

b $\Pr(X = 2) = \frac{3}{8}$

c

x	0	1	2	3
$\Pr(X = x)$	$\frac{1}{8}$	$\frac{3}{8}$	$\frac{3}{8}$	$\frac{1}{8}$

d $\Pr(X \leq 2) = 1 - \frac{1}{8} = \frac{7}{8}$

e $\Pr(X \leq 1 | X \leq 2) = \frac{\Pr(X \leq 1)}{\Pr(X \leq 2)}$
 $= \frac{1}{2} \div \frac{7}{8} = \frac{4}{7}$

10 a $Y = \{2, 3, 4, 5, 6, 7, 8, 9, 10, 11, 12\}$

b $\Pr(Y = 7) = \frac{6}{36} = \frac{1}{6}$

c

y	$\Pr(Y = y)$	y	$\Pr(Y = y)$
2	$\frac{1}{36}$	8	$\frac{5}{36}$
3	$\frac{1}{18}$	9	$\frac{1}{9}$
4	$\frac{1}{12}$	10	$\frac{1}{12}$
5	$\frac{1}{9}$	11	$\frac{1}{18}$
6	$\frac{5}{36}$	12	$\frac{1}{6}$
7	$\frac{1}{6}$		

11 a $X = \{1, 2, 3, 4, 5, 6\}$

b $\Pr(X = 4) = \frac{7}{36}$

c (1, 1) gives $X = 1$;
 (1, 2), (2, 1), (2, 2) give $X = 2$;
 (1, 3), (3, 1), (2, 3), (3, 2), (3, 3) give
 $X = 3$, etc.

x	1	2	3	4	5	6
p	$\frac{1}{36}$	$\frac{1}{12}$	$\frac{5}{36}$	$\frac{7}{36}$	$\frac{1}{4}$	$\frac{11}{36}$

12 a

y	-3	-2	1	3
$\Pr(Y = y)$	$\frac{1}{8}$	$\frac{3}{8}$	$\frac{3}{8}$	$\frac{1}{8}$

b $\Pr(Y \leq 1) = 1 - \Pr(Y = 3) = \frac{7}{8}$

Solutions to Exercise 11B

$$\begin{aligned} 1 \quad \Pr(2M, 3W) &= ({}^{12}C_2) \times ({}^{18}C_3) \div {}^{30}C_5 \\ &= \frac{66 \times 816}{142\,506} \approx 0.378 \end{aligned}$$

$$\begin{aligned} 2 \quad \Pr(P) &= ({}^4C_0)({}^{16}C_3) \div {}^{20}C_3 \\ &= \frac{84}{71} \approx 0.491 \end{aligned}$$

3 7G, 8B, 3 caught:

$$\begin{aligned} \Pr(G, G, G) &= ({}^8C_0)({}^7C_3) \div {}^{15}C_3 = \frac{1}{13} \\ \therefore \Pr(\geq 1B) &= 1 - \frac{1}{13} = \frac{12}{13} \end{aligned}$$

4 10T, 15T', 5 caught:

$$\begin{aligned} \Pr(3T, 2T') &= ({}^{10}C_3)({}^{15}C_2) \div {}^{25}C_5 \\ &= \frac{420}{1771} \approx 0.237 \end{aligned}$$

5 10N, 10N', choose 6:

$$\Pr(\geq 2N) = 1 - \{\Pr(0N) + \Pr(1N)\}:$$

$$\Pr(0) = ({}^{10}C_0)({}^{10}C_6) \div {}^{20}C_6$$

$$= \frac{7}{1292} \approx 0.0054$$

$$\Pr(1) = ({}^{10}C_1)({}^{10}C_5) \div {}^{20}C_6$$

$$= \frac{21}{323} \approx 0.0650$$

$$\therefore \Pr(\geq 2N) \approx 0.930$$

6 10M, 8F, 6 chosen:

$$\Pr(1F) = ({}^{10}C_5)({}^8C_1) \div {}^{18}C_6$$

$$= \frac{24}{221} \approx 0.109$$

No reason for suspicion here. You would need a much smaller probability, indicating an unlikely chance, to be concerned.

Solutions to Exercise 11C

1 Binomial, $n = 6, p = 0.3$:

a $\Pr(X = 3) = {}^6C_3(0.3)^3(0.7)^3 = 0.185$

b $\Pr(X = 4) = {}^6C_4(0.3)^4(0.7)^2 = 0.060$

2 Binomial, $n = 10, p = 0.1$:

a $\Pr(X = 2) = {}^{10}C_2(0.1)^2(0.9)^8 = 0.194$

b $\Pr(X = 2) = 0.194$

$\Pr(X = 1) = {}^{10}C_1(0.1)(0.9)^9 = 0.387$

$\Pr(X = 0) = 0.9^{10} = 0.349$

$\therefore \Pr(X \leq 2) = 0.349 + 0.387 + 0.194$
 $= 0.930$

3 Binomial, $n = 10, p = \frac{1}{6}$, CAS calculator:

a $\Pr(X = 10) = 0.137$

b $\Pr(X < 10) = 0.446$

c $\Pr(X \geq 10) = 1 - 0.446 = 0.554$

4 Binomial, $n = 7, p = 0.35$:

a $\Pr(R, R, R, R', R', R', R')$
 $= (0.35)^3(0.65)^4 = 0.00765 \approx 0.008$

b $\Pr(R = 3) = {}^7C_3(0.35)^3(0.65)^4$
 $= 0.268$

c $\Pr(R \geq 3) = \Pr(R = 3) + \Pr(R = 4)$
 $+ \Pr(R = 5) + \Pr(R = 6)$
 $+ \Pr(R = 7)$
 $= 0.468$

5 Binomial, $n = 7, p = \frac{1}{6}$

a $\Pr(2 \text{ only on 1 st}) = \left(\frac{1}{6}\right)\left(\frac{5}{6}\right)^6 = 0.056$

b $\Pr(2) = {}^7C_1\left(\frac{1}{6}\right)\left(\frac{5}{6}\right)^6 = 0.391$

6 Binomial, $n = 100, p = 0.5$, CAS calculator:

$\Pr(G > 60) = 0.018$

7 Binomial, $n = 5, p = 0.1$:

a $\Pr(X = 0) = (0.9)^5 = 0.590$

$\Pr(X = 1) = {}^5C_1(0.1)(0.9)^4 = 0.328$

$\Pr(X = 2) = {}^5C_2(0.1)^2(0.9)^3 = 0.0729$

$\Pr(X = 3) = {}^5C_3(0.1)^3(0.9)^2 = 0.0081$

$\Pr(X = 4) = {}^5C_4(0.1)^4(0.9) = 0.00045$

$\Pr(X = 5) = (0.1)^5 = 0.00001$

b Zero is the most probable number.

8 Binomial, $n = 3, p = 0.48$:

$\Pr(F, F, F) = 0.48^3 = 0.1106$

$\Pr(M, M, M) = 0.52^3 = 0.1406$

$\therefore \Pr(\geq 1 \text{ of each}) = 1 - (0.1406 + 0.1106)$
 $= 0.749$

9 Binomial, $n = 100, p = 0.3$, CAS calculator: $\Pr(X \geq 40) = 0.021$

10 Binomial, $n = 100, p = 0.8$, CAS calculator: $\Pr(X \leq 80) = 0.540$

11 Binomial, $n = 4, p = 0.25$:

$$\Pr(X \geq 1) = 1 - \left(\frac{3}{4}\right)^4 = \frac{175}{256}$$

12 Binomial, $n = 4, p = 0.003$:

a $\Pr(X = 0) = (0.997)^4 = 0.9880$

b $\Pr(X = 1) = 4(0.997)^3 \times (0.003)$
 $= 0.0119$
 $\therefore \Pr(X \leq 1) = 0.9999$

c $\Pr(X = 4) = 0.003^4 = 8.1 \times 10^{-11}$

13 Binomial, $n = 15, p = 0.5$, CAS calculator:

a $\Pr(X \geq 10) = 0.151$

b $\Pr(X \geq 10 \cup X \leq 5) = 0.302$

14 Binomial, $n = 10, p = 0.04$:

$$\Pr(X \geq 2) = 1 - \Pr(X = 0 \text{ or } 1)$$

$$= 1 - (0.96^{10} + 10(0.96)^9(0.04))$$

$$= 0.058$$

So the percentage is 5.8%.

$\Pr(X \geq 6) < 10^{-5}$, so 6 defectives in a batch of 10 would indicate that the machines aren't working properly.

15 Binomial, $n = 10, p = \frac{1}{4}$

a i $\Pr(X \geq 3) = 0.474$

ii $\Pr(X \geq 4) = 0.224$

iii $\Pr(X \geq 5) = 0.078$

b 6 or more would be enough.

$\Pr(X \geq 6) = 0.020$ so there would be a 98% probability that any such

student was not guessing. Even 5 or more seems reasonable with a 92% chance of not guessing.

16 Binomial, $n = 20, p = \frac{1}{4}$, CAS calculator: $\Pr(\text{pass}) = \Pr(X \geq 10) = 0.014$

17 Binomial, $n = 20, p = 0.3$

x	$\Pr(X = x)$	x	$\Pr(X = x)$
0	0.028	6	0.037
1	0.121	7	0.009
2	0.233	8	0.001
3	0.267	9	< 0.001
4	0.2	10	< 0.001
5	0.103		

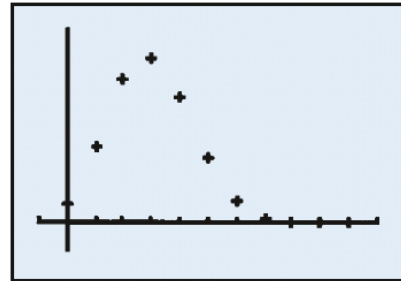

18 Binomial, $n = 15$, and $p = 0.6$

x	$\Pr(X = x)$	x	$\Pr(X = x)$
0	< 0.001	8	0.177
1	< 0.001	9	0.207
2	< 0.001	10	0.186
3	0.002	11	0.127
4	0.007	12	0.064
5	0.024	13	0.022
6	0.061	14	0.003
7	0.118	15	< 0.001

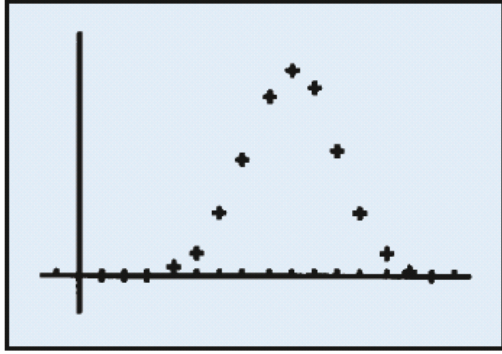

$$\begin{aligned} \Pr(S = 1) &= n \left(\frac{1}{6}\right) \left(\frac{5}{6}\right)^{n-1} \\ &= \frac{n}{5} \left(\frac{5}{6}\right)^n \\ \therefore \left(\frac{n}{5} + 1\right) \left(\frac{5}{6}\right)^n &< 0.1 \end{aligned}$$

n	19	20	21	22	23
Pr(at most 1)	0.15	0.13	0.11	0.098	0.08
Pr(more than 1)	0.85	0.87	0.89	0.902	0.92

\therefore 22 rolls needed

19 Binomial, $n = \text{unknown}$ and $p = \frac{1}{2}$

- a** $\Pr(H \geq 1) = 1 - \Pr(H = 0)$
 If $\Pr(H = 0) < 0.05$, then $0.5^n < 0.05$
 $\therefore 2^n > 20$, $\therefore n > 4.322$
 \therefore 5 tosses needed

- b** $\Pr(H > 1)$: we know
 $\Pr(H = 0) = 0.5^n$
 $\Pr(H = 1) = n \cdot 0.5^n$
 $\therefore (n + 1)0.5^n < 0.05$

n	5	6	7	8	g
Pr(at most 1)	0.188	0.11	0.06	0.04	0.52
Pr(more than 1)	0.813	0.89	0.94	0.96	0.98

\therefore 8 tosses needed

20 Binomial, $n = \text{unknown}$ and $p = \frac{1}{6}$

- a** $\Pr(S \geq 1) = 1 - \Pr(S = 0)$:
 If $\Pr(S = 0) < 0.1$, then $\left(\frac{5}{6}\right)^n < 0.1$
 $\therefore (1.2)^n > 10$ $\therefore n > 12.6$
 \therefore 13 rolls needed

- b** $\Pr(S > 1)$: we know
 $\Pr(S = 0) = \left(\frac{5}{6}\right)^n$

21 Binomial, $n = \text{unknown}$ and $p = 0.1$

- a** $\Pr(A \geq 1) = 1 - \Pr(A = 0)$:
 If $\Pr(A = 0) < 0.2$, then $0.9^n < 0.2$
 $\therefore \left(\frac{10}{9}\right)^n > 5$, $\therefore n > 15.3$
 \therefore 16 serves needed

- b** $\Pr(A > 1)$: we know $\Pr(A = 0) = 0.9^n$
 $\Pr(A = 1) = n(0.1)(0.9)^{n-1}$

$$\begin{aligned} &= \frac{n}{10}(0.9)^{n-1} \\ \therefore 0.9^n + \frac{n}{10}(0.9)^{n-1} &< 0.2 \end{aligned}$$

n	26	27	28	29	30
Pr(at most 1)	0.251	0.23	0.22	0.199	0.18
Pr(more than 1)	0.749	0.77	0.78	0.801	0.82

\therefore 29 serves needed

22 Binomial, $n = \text{unknown}$ and $p = 0.05$

- a** $\Pr(W \geq 1) = 1 - \Pr(W = 0)$
 If $\Pr(W = 0) < 0.1$, then $0.95^n < 0.1$
 $\therefore \left(\frac{20}{19}\right)^n > 10$, $\therefore n > 44.9$
 \therefore 45 games needed

b As for **a**: $0.95^n < 0.05$, $\therefore \left(\frac{20}{19}\right)^n > 20$
 $\therefore n > 58.4$
 $\therefore 59$ games needed

23 Binomial, $n = 5$ and $p = 0.7$

a $\Pr(X = 3) = {}^5C_3(0.7)^3(0.3)^2$
 $= 0.3087$

b $\Pr(X = 3|X \geq 1) = \frac{\Pr(X = 3)}{\Pr(X \geq 1)}$
 $\Pr(X \geq 1) = 1 - \Pr(X = 0) = 0.99757$
 $\therefore \Pr(X = 3|X \geq 1) = \frac{0.3087}{0.9976}$
 $= 0.3095$

24 Binomial, $n = 10$ and $p = 0.2$
 $X =$ number of Fridays chosen

a $\Pr(X = 2) = {}^{10}C_2(0.8)^8(0.2)^2$
 $= 0.3020$

b $\Pr(X \geq 2) = 1 - \Pr(X < 2)$
 $= 1 - (0.1074 + 0.2684)$
 $= 0.6242$

c $\Pr(X = 3|X \geq 2) = \frac{\Pr(X = 3)}{\Pr(X \geq 2)}$
 $\Pr(X = 3) = {}^{10}C_3(0.8)^7(0.2)^3$
 $= 0.2013$
 $\therefore \Pr = 0.3225$

Solutions to Technology-free questions

1

x	0	1	2	3	4
$\Pr(X = x)$.12	.25	.43	.12	.08

a $\Pr(X \leq 3) = 1 - 0.08 = 0.92$

b $\Pr(X \geq 2) = 0.43 + 0.12 + 0.08$
 $= 0.63$

c $\Pr(1 \leq X \leq 3) = 0.25 + 0.43 + 0.12$
 $= 0.80$

2

x	1	2	3	4	Total
$\Pr(X = x)$	0.25	0.28	0.30	0.17	1

3 Four marbles are 1 and two are 2, two chosen, no replacement, $X = \{2, 3, 4\}$

$X = 2$ only if both = 1;

$$\Pr = \binom{4}{6} \binom{3}{5} = \frac{2}{5}$$

$X = 4$ only if both = 2;

$$\Pr = \binom{2}{6} \binom{1}{5} = \frac{1}{15}$$

$$X = 3: \Pr = 1 - \left(\frac{1}{15} + \frac{2}{5} \right) = \frac{8}{15}$$

x	2	3	4
$\Pr(X = x)$	$\frac{2}{5}$	$\frac{8}{15}$	$\frac{1}{15}$

4 $\{1, 2, 3, 6, 7, 9\}$ 2 chosen, replacement, $X = \text{sum}$.

a

1st choice \ 2nd choice	1	2	3	6	7	9
1	2	3	4	7	8	10
2	3	4	5	8	9	11
3	4	5	6	9	10	12
6	7	8	9	12	13	15
7	8	9	10	13	14	16
9	10	11	12	15	16	18

b $X = \{2, 3, 4, 5, 6, 7, 8, 9, 10, 11, 12, 13, 14, 15, 16, 18\}$

c Each pair is equally likely with

$$\Pr = \frac{1}{36}$$

2 can only be (1, 1)

$$\Pr(2) = \frac{1}{36}$$

3 can be (1, 2) or (2, 1)

$$\Pr(3) = \frac{1}{18}$$

4 can be (1, 3), (3, 1) or (2, 2)

$$\Pr(4) = \frac{1}{12}$$

5 can be (2, 3) or (3, 2)

$$\Pr(5) = \frac{1}{18}$$

6 can only be (3, 3)

$$\Pr(6) = \frac{1}{36}$$

7 can be (1, 6) or (6, 1)

$$\Pr(7) = \frac{1}{18}$$

8 can be (2, 6), (6, 2),
(1, 7) or (7, 1)

$$\Pr(8) = \frac{1}{9}$$

9 can be (3, 6), (6, 3),
(2, 7) or (7, 2)

$$\Pr(9) = \frac{1}{9}$$

10 can be (3, 7), (7, 3),
(1, 9) or (9, 1)

$$\Pr(10) = \frac{1}{9}$$

11 can be (2, 9) or (9, 2)

$$\Pr(11) = \frac{1}{18}$$

12 can be (3, 9), (9, 3) or (6, 6)

$$\Pr(12) = \frac{1}{12}$$

13 can be (6, 7) or (7, 6)

$$\Pr(13) = \frac{1}{18}$$

$$\begin{aligned}
 14 \text{ can only be } (7, 7) & \quad \Pr(14) = \frac{1}{36} \\
 15 \text{ can be } (6, 9) \text{ or } (9, 6) & \quad \Pr(15) = \frac{1}{18} \\
 16 \text{ can be } (7, 9) \text{ or } (9, 7) & \quad \Pr(16) = \frac{1}{18} \\
 18 \text{ can only be } (9, 9) & \quad \Pr(18) = \frac{1}{36}
 \end{aligned}$$

$$\begin{aligned}
 \mathbf{a} \quad \Pr(X = 3) &= {}^7C_3 (0.25)^3 (0.75)^4 \\
 &= 0.173
 \end{aligned}$$

$$\begin{aligned}
 \mathbf{b} \quad \Pr(X < 3) &= 0.75^7 + 7(0.75)^6(0.25) \\
 &\quad + 21(0.75)^5(0.25)^2 \\
 &= 0.756
 \end{aligned}$$

5 Binomial, $n = 4$ and $p = 0.25$:

$$\begin{aligned}
 \mathbf{a} \quad \Pr(X \geq 3) &= 4(0.25)^3(0.75) + (0.25)^4 \\
 &= 0.051
 \end{aligned}$$

$$\begin{aligned}
 \mathbf{b} \quad \Pr(X \leq 3) &= 1 - \Pr(X = 4) \\
 &= 1 - 0.25^4 = 0.996
 \end{aligned}$$

$$\mathbf{c} \quad \Pr(X \leq 2) = 1 - 0.051 = 0.949$$

6 Binomial, $n = 3$ and $p = \frac{1}{4}$:

$$\mathbf{a} \quad \Pr(X = 2) = 3\left(\frac{1}{4}\right)^2\left(\frac{3}{4}\right) = \frac{9}{64}$$

$$\mathbf{b} \quad \Pr(X \geq 1) = 1 - \left(\frac{3}{4}\right)^3 = \frac{37}{64}$$

7 Binomial, $n = 4$ and $p = \frac{1}{3}$:

$$\mathbf{a} \quad \Pr(X = 0) = \left(\frac{2}{3}\right)^4 = \frac{16}{81}$$

$$\mathbf{b} \quad \Pr(X = 1) = {}^4C_1 \left(\frac{2}{3}\right)^3 \left(\frac{1}{3}\right) = \frac{32}{81}$$

$$\mathbf{c} \quad \Pr(X > 1) = 1 - \frac{16 + 32}{81} = \frac{11}{27}$$

8 Binomial, $n = 7$ and $p = \frac{1}{4}$:

9 Binomial, $n = 15$, $p = 0.01p\%$

$$\mathbf{a} \quad \Pr(X = 15) = \left(\frac{p}{100}\right)^{15}$$

$$\begin{aligned}
 \mathbf{b} \quad \text{Since } \Pr(\text{fail}) &= 100 - p \text{ and} \\
 {}^{15}C_1 &= 15 \\
 \Pr(X = 14) &= 15 \left(1 - \frac{p}{100}\right) \left(\frac{p}{100}\right)^{14}
 \end{aligned}$$

$$\begin{aligned}
 \mathbf{c} \\
 \Pr(X = 13) &= {}^{15}C_2 \left(1 - \frac{p}{100}\right)^2 \left(\frac{p}{100}\right)^{13} \\
 &= 105 \left(1 - \frac{p}{100}\right)^2 \left(\frac{p}{100}\right)^{13} \\
 \Pr(13 \leq X \leq 15) &= \left(\frac{p}{100}\right)^{15} + 15 \left(1 - \frac{p}{100}\right) \left(\frac{p}{100}\right)^{14} \\
 &\quad + 105 \left(1 - \frac{p}{100}\right)^2 \left(\frac{p}{100}\right)^{13}
 \end{aligned}$$

10 Binomial, $n = 3$, $p = \frac{3}{5}$:

$$\begin{aligned}
 \mathbf{a} \quad \Pr(X \geq 1) &= 1 - \Pr(X = 0) \\
 &= 1 - \left(\frac{2}{5}\right)^3 = \frac{117}{125}
 \end{aligned}$$

$$\begin{aligned}
 \mathbf{b} \quad \text{For } m \text{ games, } \Pr(X = 1) &= \\
 {}^mC_1 \left(\frac{3}{5}\right) \left(\frac{2}{5}\right)^{m-1} & \\
 \text{and } \Pr(X = 2) &= {}^mC_2 \left(\frac{3}{5}\right)^2 \left(\frac{2}{5}\right)^{m-2}
 \end{aligned}$$

Since $\Pr(X = 2) = 3 \times \Pr(X = 1)$,

$${}^m\mathbf{C}_2 \left(\frac{3}{5}\right)^2 \left(\frac{2}{5}\right)^{m-2} = 3 {}^m\mathbf{C}_1 \left(\frac{3}{5}\right) \left(\frac{2}{5}\right)^{m-1}$$

Cancel out all denominators as both

$$= 5^m$$

$$\frac{9}{2} m(m-1) 2^{m-2} = 9m 2^{m-1}$$

$$\therefore \frac{m-1}{4} 2^{m-2} = 2^{m-2}$$

$$\therefore m-1 = 4$$

$$\therefore m = 5$$

Solutions to multiple-choice questions

1 B

x	0	1	2	3	4
$\Pr(X = x)$	k	$2k$	$3k$	$2k$	k

$$\sum \Pr = 9k = 1$$

$$\therefore k = \frac{1}{9}$$

2 A $\Pr(X \geq 5) = 0.14 + 0.10$
 $= 0.24$

3 C Only 2 apples, so $\{0, 1, 2\}$

4 A Only the coin toss = yes/no

5 E Binomial, $n = 6$ and $p = 0.48$:
 $\Pr(X = 3) = {}^6C_3(0.48)^3(0.52)^3$

6 C $\Pr(L \geq 1) = 1 - \Pr(L = 0)$
 $= 1 - (0.77)^9$

7 A Binomial, $n = 10$ and $p = 0.2$
 Expect a skewed graph with mean

and mode $X = 2$.

Only **A** fits; **B** has $p = 0.5$, **C** has $p = 0.8$, **D** is not a probability function and **E** does not tail to zero.

8 D Binomial, $n = 60$ and $p = 0.5$:
 $\Pr(X \geq 30) = 0.857$

9 B Binomial, $n = 10$ and $p = 0.1$:
 $\Pr(X = 3) + \Pr(X = 4)$
 $= {}^{10}C_3(0.9)^7(0.1)^3 + {}^{10}C_4(0.9)^6(0.1)^4$
 $= 0.0574 + 0.0112$
 $= 0.0686$

10 E $\Pr(X \geq 1) = 1 - \Pr(X = 0)$

$$\therefore 0.9^n < 0.1$$

$$\left(\frac{10}{9}\right)^n > 10$$

$$n > 21.9$$

22 games will be needed

Solutions to extended-response questions

1 $\Pr(A|B) = 0.6, \Pr(A|B') = 0.1, \Pr(B) = 0.4$

$X = 4$ if A and B both occur

$X = 3$ if A occurs but not B

$X = 2$ if B occurs but not A

$X = 1$ if neither A nor B occurs

$$\therefore \Pr(X = 4) = \Pr(A \cap B)$$

$$\Pr(X = 3) = \Pr(A \cap B')$$

$$\Pr(X = 2) = \Pr(B \cap A')$$

$$\Pr(X = 1) = \Pr(A' \cap B')$$

$$\begin{aligned} \text{Also } \Pr(A \cap B) &= \Pr(A|B) \times \Pr(B) \\ &= 0.6 \times 0.4 = 0.24 \end{aligned}$$

$$\begin{aligned} \Pr(A \cap B') &= \Pr(A|B') \times \Pr(B') \\ &= 0.1 \times 0.6 = 0.06 \end{aligned}$$

	A	A'	
B	$\Pr(A \cap B) = 0.24$	$\Pr(A' \cap B) = 0.16$	$\Pr(B) = 0.4$
B'	$\Pr(A \cap B') = 0.06$	$\Pr(A' \cap B') = 0.54$	$\Pr(B') = 0.6$
	$\Pr(A) = 0.3$	$\Pr(A') = 0.7$	

a Therefore the probability distribution is given by

x	1	2	3	4
$\Pr(X = x)$	0.54	0.16	0.06	0.24

$$\begin{aligned} \text{b } \Pr(X \geq 2) &= \Pr(X = 2) + \Pr(X = 3) + \Pr(X = 4) \\ &= 1 - \Pr(X = 1) \\ &= 0.46 \end{aligned}$$

2 a i Since X is the random variable of a discrete probability distribution, the sum of the probabilities is 1, therefore $k + 0.9 = 1$
which implies $k = 0.1$

$$\text{ii } \Pr(X > 3) = \Pr(X = 4) + \Pr(X = 5) + \Pr(X = 6) + \Pr(X = 7)$$

$$\text{Thus } \Pr(X > 3) = 0.2 + 0.3 + 0.1 + 0 = 0.6$$

$$\begin{aligned} \text{iii } \Pr(X > 4 | X > 3) &= \frac{\Pr(X > 4)}{\Pr(X > 3)} \\ &= \frac{0.4}{0.6} = \frac{2}{3} \end{aligned}$$

b i The probability of hitting exactly 4 particular houses

$$= (0.4)^4(0.6)^6 = 0.0012$$

ii Let Y be the number of houses for which the paper boy hits the front step 3 or 4 times. Then Y is a binomial distribution with

$$\begin{aligned} \Pr(Y = 4) &= {}^{10}C_4(0.4)^4(0.6)^6 \\ &= 0.2508 \text{ (correct to 4 decimal places)} \end{aligned}$$

3 a The bag contains 3 blue cards and 2 white cards.

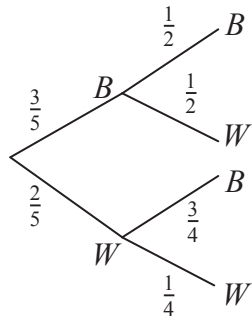

The result is to be BW or WB .

$$\begin{aligned} \text{Probability of different colours} &= \frac{3}{5} \times \frac{1}{2} + \frac{2}{5} \times \frac{3}{4} \\ &= \frac{3}{5} \end{aligned}$$

b If the cards are different colours, then the two coins are tossed once. If the cards are the same colour, the two coins are tossed twice.

Let X be the number of heads achieved. Then X can take values 0, 1, 2, 3 or 4.

$$\text{i } \Pr(X = 0) = \frac{3}{5} \times \left(\frac{1}{2}\right)^2 + \frac{2}{5} \times \left(\frac{1}{2}\right)^4 = \frac{3}{20} + \frac{1}{40} = \frac{7}{40}$$

$$\begin{aligned} \text{ii } \Pr(X = 2) &= \frac{3}{5} \times \left(\frac{1}{2}\right)^2 + \frac{2}{5} \times {}^4C_2 \left(\frac{1}{2}\right)^4 \\ &= \frac{3}{20} + \frac{3}{20} \\ &= \frac{3}{10} \end{aligned}$$

c A is the event ‘two cards of the same colour are drawn’, and B is the event ‘ $X \geq 2$ ’.

i $\Pr(A \cup B) = \Pr(A) + \Pr(B) - \Pr(A \cap B)$

$$= \frac{2}{5} + \Pr(B) - \Pr(A \cap B)$$

$$\Pr(B) = \Pr(X \geq 2) = \Pr(X = 2) + \Pr(X = 3) + \Pr(X = 4)$$

$$= \frac{3}{10} + \frac{2}{5} \times {}^4C_3 \left(\frac{1}{2}\right)^4 + \frac{2}{5} \times \left(\frac{1}{2}\right)^4$$

$$= \frac{3}{10} + \frac{1}{10} + \frac{1}{40} = \frac{17}{40}$$

$$\Pr(A \cap B) = \Pr(X \geq 2 \text{ and two cards the same colour})$$

$$= \Pr(\text{cards the same colour}) \times \Pr(X \geq 2 | \text{cards the same colour})$$

$$= \Pr(A) \Pr(B|A)$$

$$= \frac{2}{5} ({}^4C_2 \left(\frac{1}{2}\right)^4 + {}^4C_3 \left(\frac{1}{2}\right)^4 + \left(\frac{1}{2}\right)^4)$$

$$= \frac{3}{20} + \frac{1}{10} + \frac{1}{40} = \frac{11}{40}$$

$$\text{Therefore } \Pr(A \cup B) = \Pr(A) + \Pr(B) - \Pr(A \cap B)$$

$$= \frac{2}{5} + \Pr(B) - \Pr(A \cap B)$$

$$= \frac{2}{5} + \frac{17}{40} - \frac{11}{40} = \frac{11}{20}$$

ii $\Pr(A|B) = \frac{\Pr(A \cap B)}{\Pr(B)}$

$$= \frac{\frac{11}{40}}{\frac{17}{40}} = \frac{11}{17}$$

4 Let X be the number of correct answers.

X is the random variable of binomial distribution with $n = 20$ and $p = 0.2$.

a **TI:** Press **Menu** → **5:Probability** → **5:Distributions** → **E:Binomial Cdf**

Input $n = 20$, $p = 0.2$, lower bound = 10, upper bound = 20

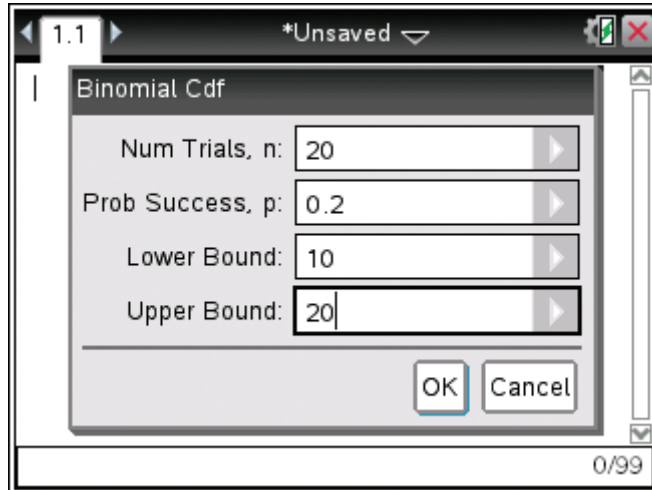

CP: Tap Interactive → Distribution → binomialCDF

Input Lower = 10, Upper = 20, Numtrial = 20, pos = 0.2

$\therefore \Pr(X \geq 10) = 0.002\,594\,827\,379\dots$

$= 0.003$ (to 3 decimal places)

b 80% of 20 = 16, $\Pr(X \geq 16|X \geq 10) = \frac{\Pr(X \geq 16)}{\Pr(X \geq 10)}$
 From the CAS calculator, $\Pr(X \geq 16) = 0.000\,000\,013\,803\,464\dots$
 Therefore $\Pr(X \geq 16|X \geq 10) = \frac{0.000\,000\,013\,803\,464\dots}{0.002\,594\,827\,379\dots}$
 $\approx 5.320 \times 10^{-6}$

5 Let p be the probability of winning in any one game.

Then the probability of winning at least once in 5 games

$= 1 - \text{the probability of losing every one of the 5 games}$

$$= 1 - (1 - p)^5$$

Therefore $1 - (1 - p)^5 = 0.999\,68$

Solve for p $1 - p = (0.000\,32)^{\frac{1}{5}}$

Therefore $1 - p = 0.2$

which implies $p = 0.8$

6 The probability of a telephone salesperson making a successful call is 0.05.

a Let X be the number of successful calls out of 10.

$$\begin{aligned}\Pr(X \geq 1) &= 1 - \Pr(X = 0) \\ &= 1 - (0.95)^{10} \\ &= 0.401\end{aligned}$$

b Let Y be the number of successful calls out of n .

$$\begin{aligned}\Pr(Y \geq 1) &= 1 - \Pr(Y = 0) \\ &= 1 - (0.95)^n\end{aligned}$$

If $\Pr(Y \geq 1) > 0.9$

then $1 - (0.95)^n > 0.9$

Therefore $0.1 > (0.95)^n$

By trial and error, $(0.95) > 0.1$

$$(0.95)^{10} > 0.1$$

$$(0.95)^{20} > 0.1$$

$$(0.95)^{40} > 0.1$$

$$(0.95)^{44} = 0.104\ 67 \dots > 0.1$$

$$(0.95)^{45} = 0.099 \dots$$

$$n \geq 45$$

7 a For a two-engine plane

Let X be the number of engines which will fail.

The plane will successfully complete its journey if 0 or 1 engine fails.

$$\begin{aligned}\Pr(X = 0) + \Pr(X = 1) &= (1 - q)^2 + 2q(1 - q) \\ &= 1 - 2q + q^2 + 2q - 2q^2 \\ &= 1 - q^2\end{aligned}$$

b For a four-engine plane

Let Y be the number of engines which will fail.

The plane will successfully complete its journey if 0, 1 or 2 engines fail.

$$\begin{aligned}\Pr(Y = 0) + \Pr(Y = 1) + \Pr(Y = 2) &= (1 - q)^4 + 4q(1 - q)^3 + 6q^2(1 - q)^2 \\ &= (1 - q)^2[(1 - q)^2 + 4q(1 - q) + 6q^2] \\ &= (1 - q)^2(1 - 2q + q^2 + 4q - 4q^2 + 6q^2) \\ &= (1 - q)^2(1 + 2q + 3q^2) \\ &= 1 - 4q^3 + 3q^4\end{aligned}$$

c To find when a two-engine plane is preferable to a four-engine plane consider

$$\begin{aligned}
 1 - q^2 &> 1 - 4q^3 + 3q^4 \\
 0 &> q^2 - 4q^3 + 3q^4 \\
 0 &> q^2(3q^2 - 4q + 1) \\
 0 &> (3q - 1)(q - 1)
 \end{aligned}$$

$$\therefore \frac{1}{3} < q < 1$$

A two-engine plane is preferred to a four-engine plane when $\frac{1}{3} < q < 1$.

8 a Let the probability of having type O blood be $p = 0.45$

The probability of at least four out of ten blood donors having blood type O can be approximated by simulation in a spreadsheet.

The exact probability can be calculated using the binomial distribution

$$\begin{aligned}
 \Pr(X \geq 4) &= \Pr(X = 4) + \Pr(X = 5) + \dots + \Pr(X = 10) \\
 &= \binom{10}{4} p^4 (1-p)^{10-4} + \binom{10}{5} p^5 (1-p)^{10-5} + \dots + \binom{10}{10} p^{10} (1-p)^{10-10} \\
 &= \binom{10}{4} p^4 (1-p)^6 + \binom{10}{5} p^5 (1-p)^5 + \dots + \binom{10}{10} p^{10} (1-p)^0 \\
 &= 210 \times (0.45)^4 \times (.55)^6 + \dots + 1 \times 0.45^{10} \times 0.55^0 \\
 &= 0.734
 \end{aligned}$$

b Answers will vary depending on the simulation. To verify the result from the simulation the exact answer can be calculated using the formula

$$\begin{aligned}
 E(\text{number of trials for } x \text{ successes}) &= \frac{x}{p} \\
 E(\text{number of trials for 4 successes}) &= \frac{4}{0.45} \\
 &= 8.89 \\
 &\approx 9
 \end{aligned}$$

Chapter 12 – Revision of chapters 9-11

Solutions to Technology-free questions

- 1 a** Sum of numbers showing is 5 means that one of the following four outcomes is observed: $\{(1, 4), (2, 3), (3, 2), (4, 1)\}$.

Since there are 36 possible outcomes

$$n(\varepsilon) = 36, \text{ and}$$

$$\Pr(\text{sum is } 5) = \frac{4}{36} = \frac{1}{9}$$

- b** $\Pr(\text{sum is not } 5) = 1 - \Pr(\text{sum is } 5)$

$$= 1 - \frac{1}{9}$$

$$= \frac{8}{9}$$

- 2 a** Sample space:

$$\{348, 384, 438, 483, 843, 834\},$$

$$n(\varepsilon) = 6$$

- b** Number is less than

$$500 = \{348, 384, 438, 483\},$$

$$n(\text{less than } 500) = 4,$$

$$\Pr(\text{less than } 500) = \frac{4}{6} = \frac{2}{3}$$

- c** Even = $\{348, 384, 438, 834\}$,

$$n(\text{Even}) = 4, \Pr(\text{Even}) = \frac{2}{3}$$

- 3 a** $\Pr(\text{Not red}) = \Pr(\text{Black})$

$$= \frac{26}{52}$$

$$= \frac{1}{2}$$

- b** $\Pr(\text{Not an ace}) = 1 - \Pr(\text{Ace})$

$$= 1 - \frac{1}{13}$$

$$= \frac{12}{13}$$

- 4 a** Area circle = πr^2 ,

$$\text{Area } A = \frac{\pi r^2}{4},$$

$$\Pr(A) = \frac{\pi r^2}{4} \div (\pi r^2) = \frac{1}{4}$$

- b** Area circle = πr^2 ,

$$\text{Area } A = \frac{135}{360} \times \pi r^2 = \frac{3}{8} \pi r^2$$

$$\Pr(A) = \frac{3}{8} \times \pi r^2 \div \pi r^2 = \frac{3}{8}$$

- 5 a** Let,

$$\Pr(1) = \Pr(2) = \Pr(3) = \Pr(5) = x.$$

$$\text{Then } \Pr(4) = 4x, \text{ and } \Pr(6) = \frac{x}{2}.$$

Since the sum of probabilities is 1,

$$x + x + x + x + 4x + \frac{x}{2} = 1.$$

$$\text{So } x = \frac{2}{17}.$$

Thus

$$\Pr(1) = \Pr(2) = \Pr(3) = \Pr(5) = \frac{2}{17},$$

$$\Pr(4) = \frac{8}{17}, \Pr(6) = \frac{1}{17}$$

- b** $\Pr(\text{Not a } 4) = 1 - \frac{8}{17}$

$$= \frac{9}{17}$$

- 6** $\Pr(\text{hitting the blue circle}) =$

$$\pi(10)^2 \div \pi(20)^2 = 100\pi \div 400\pi = \frac{1}{4}$$

7 $\Pr(B) = 0.3$, $\Pr(H) = 0.4$, and $\Pr(B \cap H) = 0.1$.

a

$$\begin{aligned}\Pr(B \cup H) &= \Pr(B) + \Pr(H) - \Pr(B \cap H) \\ &= 0.3 + 0.4 - 0.1 \\ &= 0.6\end{aligned}$$

b $\Pr(H|B) = \frac{\Pr(H \cap B)}{\Pr(B)}$

$$\begin{aligned}&= \frac{0.1}{0.3} \\ &= \frac{1}{3}\end{aligned}$$

8

	Music	Not Music	
Painting	$\frac{15}{60}$	$\frac{30}{60}$	$\frac{45}{60}$
Not Painting	$\frac{15}{60}$	0	$\frac{15}{60}$
	$\frac{30}{60}$	$\frac{30}{60}$	1

From the table

a $\frac{30}{60} = \frac{1}{2}$

b $\frac{45}{60} = \frac{3}{4}$

c $\frac{30}{60} = \frac{1}{2}$

d $\frac{15}{60} = \frac{1}{4}$

9 Let S be the event that the day is sunny.

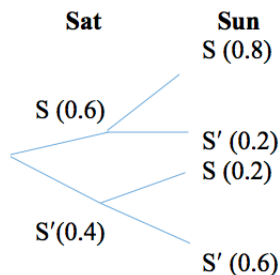

a $\Pr(\text{sunny all weekend}) = \Pr(SS)$

$$\begin{aligned}&= 0.6 \times 0.8 \\ &= 0.48\end{aligned}$$

b

$$\begin{aligned}\Pr(\text{Sunny on Sunday}) &= \Pr(SS \text{ or } S'S) \\ &= 0.6 \times 0.8 + 0.4 \times 0.2 \\ &= 0.48 + 0.08 \\ &= 0.56\end{aligned}$$

10 a $\Pr(A \cap B) = \Pr(B|A)\Pr(A)$

$$\begin{aligned}&= 0.1 \times 0.5 \\ &= 0.05\end{aligned}$$

b $\Pr(A|B) = \frac{\Pr(A \cap B)}{\Pr(B)}$

$$\begin{aligned}&= \frac{0.05}{0.2} \\ &= 0.25\end{aligned}$$

11 A and B are independent events, and $\Pr(A) = 0.4$, $\Pr(B) = 0.5$.

a $\Pr(A|B) = \Pr(A) = 0.4$ (since A and B are independent)

b $\Pr(A \cap B) = \Pr(A)\Pr(B)$

(since A and B are independent)

$$\begin{aligned}&= 0.4 \times 0.5 \\ &= 0.2\end{aligned}$$

c

$$\begin{aligned}\Pr(A \cup B) &= \Pr(A) + \Pr(B) - \Pr(A \cap B) \\ &= 0.4 + 0.5 - 0.2 \\ &= 0.7\end{aligned}$$

12 Since order is important there are
 $10 \times 9 \times 8 = 720$ ways

13 Since order is not important, there are
 $\binom{52}{7} = 133784560$ different hands

14 There are $\binom{12}{3} = 220$ different
 committees (without restrictions)

a If there is one girl then there are two
 boys. We can choose one girl from
 7 girls and two boys from 5 boys in
 $\binom{7}{1} \times \binom{5}{2} = 7 \times 10 = 70$ ways.
 Thus, $\Pr(\text{one girl}) = \frac{70}{220} = \frac{7}{22}$

b If there are two girls then there is one
 boy. We can choose two girls from
 7 girls and one boy from 5 boys in
 $\binom{7}{2} \times \binom{5}{1} = 21 \times 5 = 105$ ways.
 Thus $\Pr(\text{one girl}) = \frac{105}{220} = \frac{21}{44}$

15 a
 $\Pr(X \leq 2)$
 $= \Pr(X = 0) + \Pr(X = 1) + \Pr(X = 2)$
 $= 0.1 + 0.2 + 0.4$
 $= 0.7$

b
 $\Pr(X \geq 2)$
 $= \Pr(X = 2) + \Pr(X = 3) + \Pr(X = 4)$
 $= 0.4 + 0.1 + 0.2$
 $= 0.7$

c
 $\Pr(1 \leq X \leq 3)$
 $= \Pr(X = 1) + \Pr(X = 2) + \Pr(X = 3)$
 $= 0.2 + 0.4 + 0.1$
 $= 0.7$

16 a $\Pr(X = 4) = \binom{4}{4} 0.2^4 \times 0.8^0$
 $= 0.0016$

b $\Pr(X \geq 3) = \Pr(X = 3) + \Pr(X = 4)$
 $\Pr(X = 3) = \binom{4}{3} (0.2)^3 (0.8)^1$
 $= 4 \times 0.008 \times 0.9$
 $= 0.1536$
 $\Pr(X \geq 3) = 0.1536 + 0.0256$
 $= 0.0272$

17 a $\Pr(X = 3) = \binom{7}{3} (0.2)^3 (0.8)^4$

b $\Pr(X < 3) = \binom{7}{3} (0.2)^0 (0.8)^7 +$
 $\binom{7}{1} (0.2)^1 (0.8)^6 + \binom{7}{2} (0.2)^2 (0.8)^5$

c $\Pr(X \geq 4) = \binom{7}{4} (0.2)^4 (0.8)^3 +$
 $\binom{7}{5} (0.2)^5 (0.8)^2 + \binom{7}{6} (0.2)^6 (0.8)^1 +$
 $\binom{7}{7} (0.2)^7 (0.8)^0$

18 Records show that $x\%$ of people will
 pass their driver's license on the first
 attempt.

a

b $\left(\frac{x}{100}\right)^{10}$

c $10\left(\frac{x}{100}\right)^9\left(1 - \frac{x}{100}\right)$

d $\left(\frac{x}{100}\right)^{10} + 10\left(\frac{x}{100}\right)^9\left(1 - \frac{x}{100}\right)$
 $+ 45\left(\frac{x}{100}\right)^8\left(1 - \frac{x}{100}\right)^2$

Solutions to multiple-choice questions

1 E $\Pr(\text{success}) = \frac{1}{12}$ for each

$$\Pr(\text{both}) = \left(\frac{1}{12}\right)^2 = \frac{1}{144}$$

2 C $\Pr(WB) + \Pr(BW) = \left(\frac{2}{5}\right)^2 + \left(\frac{3}{5}\right)^2 = \frac{13}{25}$

3 E Two dice, $\Pr(X > 12) = 0$,
 $\Pr(X = 12) = \frac{1}{36}$

4 B $\Pr(G, B) + \Pr(B, G) = \frac{3}{7}\left(\frac{4}{6}\right) + \frac{4}{7}\left(\frac{3}{6}\right) = \frac{4}{7}$

5 E $\Pr(X \cup Y) = \Pr(X) + \Pr(Y) - \Pr(X \cap Y)$
 $= \Pr(Y') + \Pr(Y) - 0$
 $= 1$

6 E Binomial, $n = 500$, $p = \frac{1}{2}$:
 $\Pr(X = 250) = {}^{500}C_{250} \left(\frac{1}{2}\right)^{250} \left(\frac{1}{2}\right)^{250}$
 $= {}^{500}C_{250} \left(\frac{1}{2}\right)^{500}$

7 C Binomial, $n = 6$, $p = \frac{1}{6}$:
 $\Pr(X \geq 1) = 1 - \Pr(X = 0)$
 $= 1 - \left(\frac{5}{6}\right)^6$

8 C $\Pr(\heartsuit \cup J) = \Pr(\heartsuit) + \Pr(J) - \Pr(J\heartsuit)$
 $= \frac{1}{4} + \frac{1}{13} - \frac{1}{52}$
 $= \frac{16}{52} = \frac{4}{13}$

9 B $\Pr(R, R) = \left(\frac{k}{k+1}\right)\left(\frac{k-1}{k}\right) = \frac{k-1}{k+1}$

10 D Replace: $\Pr(A, A) = \left(\frac{4}{52}\right)^2 = \frac{1}{169}$
 No replace: $\Pr(A, A) = \frac{4}{52}\left(\frac{3}{51}\right) = \frac{1}{221}$
 Ratio = 221:169 = 17:13

11 D Bill: $n = 2$, $p = \frac{1}{2}$
 Charles: $n = 4$, $p = \frac{1}{4}$
 $\Pr(\geq 1) = 1 - \Pr(\text{none})$
 Bill: $1 - \left(\frac{1}{2}\right)^2 = \frac{3}{4} = \frac{192}{256}$
 Charles: $1 - \left(\frac{3}{4}\right)^4 = \frac{175}{256}$
 Bill:Charles = 192:175

12 D $N(\text{RAPIDS, vowels together})$
 $= 2!(\text{vowels}) \times 5!(\text{cons} + \text{vowel group})$
 $= 240$

13 E n from $(m+n)$: ${}^{m+n}C_n = \frac{(m+n)!}{n!m!}$

14 A Choose 7 from 12 = ${}^{12}C_7 = 792$

15 E 4 letters, 4 choices, replacement
 $= 4^4 = 256$

16 E $\Pr(O, O, O) = \frac{3}{6}\left(\frac{2}{5}\right)\frac{1}{4} = \frac{1}{20}$

17 B Person 1 has 6×10 possibilities.
 Person 2 enters by the same gate and
 can choose 9 exits.

18 C $\Pr(A \cap B) = \frac{1}{5}, \Pr(B) = \frac{1}{2},$
 $\Pr(B|A) = \frac{1}{3}$
 $\Pr(A|B) = \frac{\Pr(A \cap B)}{\Pr(B)} = \frac{1}{5} \div \frac{1}{2} = \frac{2}{5}$
 $\Pr(B|A) = \frac{\Pr(A \cap B)}{\Pr(A)}$
 $\Pr(A) = \frac{\Pr(A \cap B)}{\Pr(B|A)}$
 $= \frac{1}{5} \div \frac{1}{3} = \frac{3}{5}$

19 C $\Pr(4, 6) + \Pr(6, 4) + \Pr(5, 5) = \frac{3}{36}$

20 A $\Pr(A, D, E, H, S) = \frac{1}{5!} = \frac{1}{120}$

21 E $\Pr(G, G) = \frac{4}{16} \left(\frac{3}{15} \right) = \frac{1}{20}$

22 E Binomial, $n = 6, p = \frac{1}{8}$
 $\Pr(X = 4) = {}^6C_4 \left(\frac{1}{8} \right)^4 \left(\frac{7}{8} \right)^2$
 $= 15 \left(\frac{1}{8} \right)^4 \left(\frac{7}{8} \right)^2$

23 C Binomial, $n = 3, p = p$
 $\Pr(X \leq 1) = (1 - p)^3 + {}^3C_1 p(1 - p)^2$
 $= (1 - p)^2(1 - p + 3p)$
 $= (1 - p)^2(1 + 2p)$

24 D Binomial, $n = 10, p = 0.8$
 $\Pr(X \geq 1) = 1 - \Pr(X = 0)$
 $= 1 - (0.2)^{10}$

25 D Binomial, $n = n, p = 0.15$
 $\Pr(X \geq 1) = 1 - \Pr(X = 0)$
 $\therefore 0.85^n < 0.1$
 $\left(\frac{20}{17} \right)^n > 10, \therefore n > 14.2$
 15 shots needed

Solutions to extended-response questions

1	Interval	No. of plants	Proportion	No. of plants > 30 cm	Proportion
	(0, 10]	1	$\frac{1}{56}$		
	(10, 20]	2	$\frac{2}{56}$		
	(20, 30]	4	$\frac{4}{56}$		
	(30, 40]	6	$\frac{6}{56}$	6	$\frac{6}{49}$
	(40, 50]	13	$\frac{13}{56}$	13	$\frac{13}{49}$
	(50, 60]	22	$\frac{22}{56}$	22	$\frac{22}{49}$
	(60, 70]	8	$\frac{8}{56}$	8	$\frac{8}{49}$
	Total	56	1	49	1

Let X be the height of the plants (in cm).

$$\begin{aligned} \text{a i } \Pr(X > 50) &= \frac{22}{56} + \frac{8}{56} \\ &= \frac{30}{56} = \frac{15}{28} \approx 0.5357 \end{aligned}$$

$$\begin{aligned} \text{ii } \Pr(X > 50) + \Pr(X \leq 30) &= \frac{30}{56} + \frac{1}{56} + \frac{2}{56} + \frac{4}{56} \\ &= \frac{37}{56} \approx 0.6607 \end{aligned}$$

$$\begin{aligned} \text{iii } \Pr(X > 40|X > 30) &= 1 - \Pr(X \leq 40|X > 30) \\ &= 1 - \frac{6}{49} = \frac{43}{49} \approx 0.8776 \end{aligned}$$

$$\text{b } \Pr(F) = \frac{6}{7} \text{ and } \Pr(D) = \frac{1}{4}$$

$$\begin{aligned} \text{i } \Pr(F \cap D') &= \Pr(F) \times \Pr(D') \\ &= \frac{6}{7} \left(1 - \frac{1}{4}\right) = \frac{6}{7} \times \frac{3}{4} \\ &= \frac{9}{14} \approx 0.6429 \end{aligned}$$

$$\begin{aligned}
 \text{ii } \Pr(F \cap D' \cap (X > 50)) &= \Pr(F) \times \Pr(D') \times \Pr(X > 50) \\
 &= \frac{9}{14} \times \frac{15}{28} = \frac{135}{392} \\
 &\approx 0.3444
 \end{aligned}$$

2 a Possible choices

<i>C</i>	<i>B</i>
1	any ball
2	5
4	5
7	no possible choice

\therefore probability that *B* draws a higher number than *C*

$$\begin{aligned}
 &= \frac{1}{3} + \frac{1}{6} \times \frac{1}{3} + \frac{1}{3} \times \frac{1}{3} \\
 &= \frac{1}{3} + \frac{1}{18} + \frac{1}{9} \\
 &= \frac{6 + 1 + 2}{18} = \frac{1}{2}
 \end{aligned}$$

b Possible choices

<i>B</i>	<i>C</i>	<i>A</i>
2	1	3 or 6
2	2	3 or 6
2	4	6
2	7	no possible choice
5	1	6
5	2	6
5	4	6
5	7	no possible choice

\therefore probability that *A* draws a higher number than *B* or *C*

$$\begin{aligned}
 &= \frac{2}{3} \times \frac{1}{3} \times \frac{5}{6} + \frac{2}{3} \times \frac{1}{6} \times \frac{5}{6} + \frac{2}{3} \times \frac{1}{3} \times \frac{1}{6} + \frac{1}{3} \times \frac{1}{3} \times \frac{1}{6} + \frac{1}{3} \times \frac{1}{6} \times \frac{1}{6} + \frac{1}{3} \times \frac{1}{3} \times \frac{1}{6} \\
 &= \frac{10}{54} + \frac{10}{108} + \frac{2}{54} + \frac{1}{54} + \frac{1}{108} + \frac{1}{54} \\
 &= \frac{20 + 10 + 4 + 2 + 1 + 2}{108} = \frac{39}{108} = \frac{13}{36}
 \end{aligned}$$

3 a 1st card 2nd card Probability

$\frac{2}{8}$ A	—	$\frac{3}{7}$ L	$\frac{6}{56}$
$\frac{1}{8}$ E	—	$\frac{3}{7}$ L	$\frac{3}{56}$
$\frac{3}{8}$ L	—	$\frac{2}{7}$ L	$\frac{6}{56}$
$\frac{1}{8}$ P	—	$\frac{3}{7}$ L	$\frac{3}{56}$
$\frac{1}{8}$ R	—	$\frac{3}{7}$ L	$\frac{3}{56}$

$$\begin{aligned} \text{Probability that second card bears L} &= \frac{6}{56} + \frac{3}{56} + \frac{6}{56} + \frac{3}{56} + \frac{3}{56} \\ &= \frac{21}{56} = \frac{3}{8} \end{aligned}$$

b $\Pr(A, L, E) = \frac{2}{8} \times \frac{3}{7} \times \frac{1}{6} = \frac{1}{56}$

c

1st card	2nd card	3rd card	Probability
$\frac{2}{8}$ A	$\frac{3}{7}$ L	— $\frac{1}{6}$ E	$\frac{6}{336}$
	$\frac{1}{7}$ E	— $\frac{3}{6}$ L	$\frac{6}{336}$
$\frac{3}{8}$ L	$\frac{2}{7}$ A	— $\frac{1}{6}$ E	$\frac{6}{336}$
	$\frac{1}{7}$ E	— $\frac{2}{6}$ A	$\frac{6}{336}$
$\frac{1}{8}$ E	$\frac{2}{7}$ A	— $\frac{3}{6}$ L	$\frac{6}{336}$
	$\frac{3}{7}$ L	— $\frac{2}{6}$ A	$\frac{6}{336}$

$$\Pr(A, L, E \text{ in any order}) = \frac{36}{336} = \frac{3}{28} \left(\text{or } 3! \times \frac{1}{56} = \frac{6}{56} = \frac{3}{28} \right)$$

d 1st card 2nd card Probability

$\frac{2}{8}$ A	—	$\frac{6}{7}$ not A	$\frac{12}{56}$
$\frac{1}{8}$ E	—	$\frac{7}{7}$ not E	$\frac{7}{56}$
$\frac{3}{8}$ L	—	$\frac{5}{7}$ not L	$\frac{15}{56}$
$\frac{1}{8}$ P	—	$\frac{7}{7}$ not P	$\frac{7}{56}$
$\frac{1}{8}$ R	—	$\frac{7}{7}$ not R	$\frac{7}{56}$

Probability that first two cards bear different letters

$$\begin{aligned}
 &= \frac{12}{56} + \frac{7}{56} + \frac{15}{56} + \frac{7}{56} + \frac{7}{56} \\
 &= \frac{48}{56} = \frac{6}{7}
 \end{aligned}$$

4 Let X be the number of correct predictions, $n = 10$, $p = 0.6$

a $\Pr(\text{first 8 correct, last 2 wrong}) = (0.6)^8(0.4)^2 \approx 0.0027$

b $\Pr(X = 8) = \binom{10}{8}(0.6)^8(0.4)^2$

$$\begin{aligned}
 &= \frac{10 \times 9 \times 8!}{8! \times 2 \times 1} \times 0.002\,687\,385 \\
 &= 45 \times 0.002\,687\,385 \\
 &= 0.120\,932\,352 \approx 0.12
 \end{aligned}$$

c $\Pr(X \geq 8) = \Pr(X = 8) + \Pr(X = 9) + \Pr(X = 10)$

$$\begin{aligned}
 &= 0.120\,932\,352 + \binom{10}{9}(0.6)^9(0.4)^1 + \binom{10}{10}(0.6)^{10}(0.4)^0 \\
 &= 0.120\,932\,352 + 0.040\,310\,784 + 0.006\,046\,617 \\
 &= 0.167\,289\,753 \approx 0.17
 \end{aligned}$$

d $\Pr(X = 8 | X \geq 8) = \frac{\Pr(X = 8)}{\Pr(X \geq 8)}$

$$\begin{aligned}
 &= \frac{0.120\,932\,352}{0.167\,289\,753} \\
 &\approx 0.722\,891\,568 \approx 0.72
 \end{aligned}$$

5 a Let L be the event ‘an employee is late’, B the event ‘travels by bus’, T the event ‘travels by train’, and C the event ‘travels by car’.

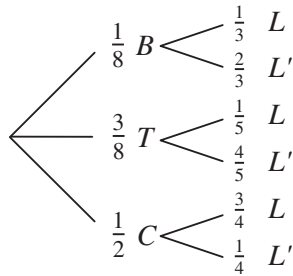

$$\begin{aligned}
\Pr(L) &= \Pr(L \cap B) + \Pr(L \cap T) + \Pr(L \cap C) \\
&= \Pr(L|B) \times \Pr(B) + \Pr(L|T) \times \Pr(T) + \Pr(L|C) \times \Pr(C) \\
&= \frac{1}{8} \times \frac{1}{3} + \frac{3}{8} \times \frac{1}{5} + \frac{1}{2} \times \frac{3}{4} \\
&= \frac{1}{24} + \frac{3}{40} + \frac{3}{8} \\
&= \frac{5 + 9 + 45}{120} \\
&= \frac{59}{120} \approx 0.4917
\end{aligned}$$

$$\begin{aligned}
\text{b } \Pr(C|L) &= \frac{\Pr(C \cap L)}{\Pr(L)} = \frac{\Pr(L|C) \times \Pr(C)}{\Pr(L)} \\
&= \frac{\frac{3}{8}}{\frac{59}{120}} = \frac{3 \times 120}{8 \times 59} \\
&= \frac{45}{59} \approx 0.7627
\end{aligned}$$

6 Let A be the event ‘Group A is chosen’, B be the event ‘Group B is chosen’ and C be the event ‘Group C is chosen’

Group	Boy (G') or Girl (G)	
$\frac{1}{2} A$	$\left\langle \begin{array}{l} G' \\ G \end{array} \right.$	$\Pr(A \cap G') = \frac{1}{5}$ $\Pr(A \cap G) = \frac{3}{10}$
	$\left\langle \begin{array}{l} G' \\ G \end{array} \right.$	$\Pr(B \cap G') = \frac{1}{24}$ $\Pr(B \cap G) = \frac{1}{8}$
$\frac{1}{6} B$	$\left\langle \begin{array}{l} G' \\ G \end{array} \right.$	$\Pr(C \cap G') = \frac{2}{9}$ $\Pr(C \cap G) = \frac{1}{9}$
	$\left\langle \begin{array}{l} G' \\ G \end{array} \right.$	

$$\begin{aligned}
\text{a } \Pr(G') &= \Pr(G' \cap A) + \Pr(G' \cap B) + \Pr(G' \cap C) \\
&= \frac{1}{5} + \frac{1}{24} + \frac{2}{9} \\
&= \frac{216 + 45 + 240}{1080} \\
&= \frac{501}{1080} = \frac{167}{360} \approx 0.639
\end{aligned}$$

$$\begin{aligned}
 \text{b i } \Pr(A|G) &= \frac{\Pr(A \cap G)}{\Pr(G)} \\
 &= \frac{\Pr(A \cap G)}{\Pr(A \cap G) + \Pr(B \cap G) + \Pr(C \cap G)} \\
 &= \frac{\frac{3}{10}}{\frac{3}{10} + \frac{1}{8} + \frac{1}{9}} \\
 &= \frac{\frac{3}{10}}{\frac{108 + 45 + 40}{360}} \\
 &= \frac{3}{10} \times \frac{360}{193} \\
 &= \frac{108}{193} \approx 0.596
 \end{aligned}$$

Note: $\Pr(G)$ can also be found by *calculating* $1 - \Pr(G')$ or directly from the tree diagram.

$$\begin{aligned}
 \text{ii } \Pr(B|G) &= \frac{\Pr(B \cap G)}{\Pr(G)} \\
 &= \frac{\frac{1}{8}}{\frac{193}{360}} \\
 &= \frac{1}{8} \times \frac{360}{193} \\
 &= \frac{45}{193} \approx 0.332
 \end{aligned}$$

7 a

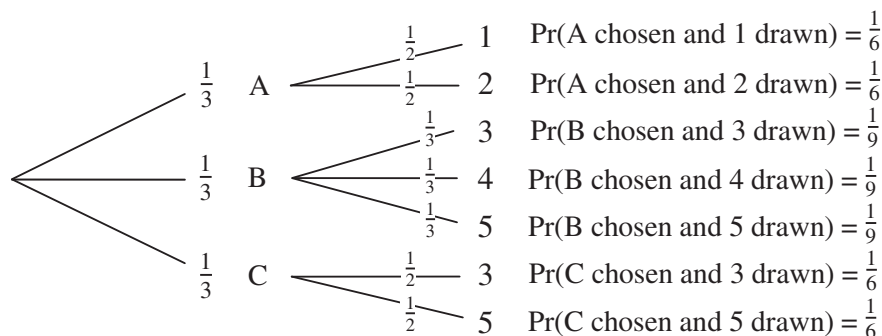

$$\begin{aligned}
 \text{i } \Pr(4 \text{ drawn}) &= \Pr(\text{B chosen and 4 drawn}) \\
 &= \frac{1}{9} \\
 &\approx 0.1111
 \end{aligned}$$

$$\text{ii } \Pr(3 \text{ drawn}) = \Pr(\text{B chosen and 3 drawn}) + \Pr(\text{C chosen and 3 drawn})$$

$$= \frac{1}{9} + \frac{1}{6}$$

$$= \frac{5}{18}$$

$$\approx 0.2778$$

$$\text{b i } \Pr(\text{balls drawn by David and Sally are both 4})$$

$$= \Pr(\text{B chosen and 4 drawn}) \times \Pr(\text{B chosen and 4 drawn})$$

$$= \frac{1}{9} \times \frac{1}{9} = \frac{1}{81}$$

$$\approx 0.0123$$

$$\text{ii } \Pr(\text{David and Sally both draw balls numbered 3 from the same bag})$$

$$= \Pr(\text{B chosen and 3 drawn}) \times \Pr(\text{B chosen and 3 drawn})$$

$$+ \Pr(\text{C chosen and 3 drawn}) \times \Pr(\text{C chosen and 3 drawn})$$

$$= \frac{1}{9} \times \frac{1}{9} + \frac{1}{6} \times \frac{1}{6}$$

$$= \frac{1}{81} + \frac{1}{36}$$

$$= \frac{36 + 81}{2916}$$

$$= \frac{117}{2916} = \frac{13}{324}$$

$$\approx 0.0401$$

$$\text{8 a i } \quad m + 10 = 40$$

$$\therefore m = 30$$

$$q + 10 = 45$$

$$\therefore q = 35$$

$$m + q + s + 10 = 100$$

$$\therefore s = 100 - 10 - m - q$$

$$= 100 - 10 - 30 - 35$$

$$\therefore s = 25$$

$$\text{ii } m + q = 30 + 35$$

$$= 65$$

- b** Let H be the event 'History is taken'
Let G be the event 'Geography is taken'.

$$\begin{aligned}\Pr(H \cap G') &= \frac{m}{100} \\ &= \frac{30}{100} \\ &= 0.3\end{aligned}$$

c $\Pr(G|H') = \frac{\Pr(G \cap H')}{\Pr(H')}$

$$\begin{aligned}&= \frac{\frac{q}{100}}{\frac{100 - m - 10}{100}} \\ &= \frac{q}{90 - m} \\ &= \frac{35}{60} = \frac{7}{12} \approx 0.5833\end{aligned}$$

- 9 a** $\Pr(\text{total score} = 23) = \Pr(A = 8) \times \Pr(B = 6) \times \Pr(C = 9)$ as there are no other ways of achieving 23, and spins are independent.

$$\begin{aligned}\therefore \Pr(\text{total score} = 23) &= \frac{4}{10} \times \frac{7}{10} \times \frac{3}{10} \\ &= \frac{84}{1000} \\ &= 0.084\end{aligned}$$

- b** Possible combinations for Player B to score more than Player C

Player B	Player C
3	2
6	2
6	5

$$\begin{aligned}\Pr(B > C) &= \Pr(B = 3, C = 2) + \Pr(B = 6, C = 2) + \Pr(B = 6, C = 5) \\ &= \Pr(B = 3) \times \Pr(C = 2) + \Pr(B = 6) \times \Pr(C = 2) + \Pr(B = 6) \\ &\quad \times \Pr(C = 5) \\ &= \frac{3}{10} \times \frac{1}{10} + \frac{7}{10} \times \frac{1}{10} + \frac{7}{10} \times \frac{6}{10}\end{aligned}$$

$$\begin{aligned}
&= \frac{3 + 7 + 42}{100} \\
&= \frac{52}{100} \\
&= 0.52
\end{aligned}$$

c Possible combinations for Player C to score more than Player A

Player C	Player A
2	1
5	1
9	1
5	4
9	4
9	8

$$\begin{aligned}
\Pr(C > A) &= \Pr(C = 2, A = 1) + \Pr(C = 5, A = 1) + \Pr(C = 9, A = 1) \\
&\quad + \Pr(C = 5, A = 4) + \Pr(C = 9, A = 4) + \Pr(C = 9, A = 8) \\
&= \Pr(C = 2) \times \Pr(A = 1) + \Pr(C = 5) \times \Pr(A = 1) + \Pr(C = 9) \\
&\quad \times \Pr(A = 1) + \Pr(C = 5) \times \Pr(A = 4) + \Pr(C = 9) \times \Pr(A = 4) \\
&\quad + \Pr(C = 9) \times \Pr(A = 8) \\
&= \frac{1}{10} \times \frac{2}{10} + \frac{6}{10} \times \frac{2}{10} + \frac{3}{10} \times \frac{2}{10} + \frac{6}{10} \times \frac{4}{10} + \frac{3}{10} \times \frac{4}{10} + \frac{3}{10} \times \frac{4}{10} \\
&= \frac{2 + 12 + 6 + 24 + 12 + 12}{100} \\
&= \frac{68}{100} \\
&= 0.68
\end{aligned}$$

10

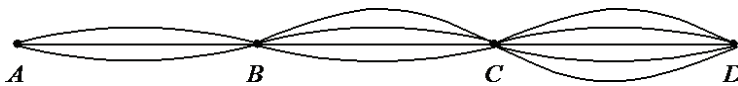

a There are $3 \times 4 \times 5 = 60$ different routes from A to D .

b There are $2 \times 2 \times 2 = 8$ routes without roadworks.

$$\begin{aligned}
\text{c } \Pr(\text{roadworks at each stage}) &= \frac{1}{3} \times \frac{2}{4} \times \frac{3}{5} \\
&= \frac{1}{10} = 0.1
\end{aligned}$$

- 11** Let A be the event 'A hits the target', B be the event 'B hits the target', and C be the event 'C hits the target'.

$$\therefore \Pr(A) = \frac{1}{5}, \Pr(B) = \frac{1}{4}, \Pr(C) = \frac{1}{3}$$

- a** $\Pr(A \cap B \cap C) = \Pr(A) \times \Pr(B) \times \Pr(C)$ as A, B, C are independent

$$\begin{aligned} &= \frac{1}{5} \times \frac{1}{4} \times \frac{1}{3} \\ &= \frac{1}{60} \approx 0.0167 \end{aligned}$$

- b** $\Pr(A') = \frac{4}{5}, \Pr(B') = \frac{3}{4}$

$$\Pr(A' \cap B' \cap C) = \Pr(A') \times \Pr(B') \times \Pr(C)$$

$$\begin{aligned} &= \frac{4}{5} \times \frac{3}{4} \times \frac{1}{3} \\ &= \frac{1}{5} = 0.2 \end{aligned}$$

- c** $\Pr(\text{at least one shot hits the target}) = 1 - \Pr(\text{no shot hits the target})$

$$\begin{aligned} &= 1 - \frac{4}{5} \times \frac{3}{4} \times \frac{2}{3} \\ &= 1 - \frac{2}{5} \\ &= \frac{3}{5} = 0.6 \end{aligned}$$

- d** $\Pr(C|\text{only one shot hits the target})$

$$\begin{aligned} &= \frac{\Pr(C \cap A' \cap B')}{\Pr(A \cap B' \cap C') + \Pr(A' \cap B \cap C') + \Pr(A' \cap B' \cap C)} \\ &= \frac{\frac{1}{3} \times \frac{4}{5} \times \frac{3}{4}}{\frac{1}{5} \times \frac{3}{4} \times \frac{2}{3} + \frac{4}{5} \times \frac{1}{4} \times \frac{2}{3} + \frac{4}{5} \times \frac{3}{4} \times \frac{1}{3}} \\ &= \frac{\frac{12}{60}}{\frac{6}{60} + \frac{8}{60} + \frac{12}{60}} \\ &= \frac{12}{26} \\ &= \frac{6}{13} \approx 0.4615 \end{aligned}$$

12 a

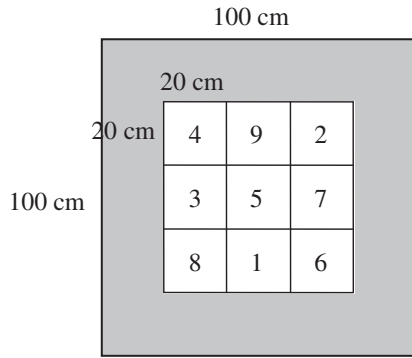

i Area of large outer square = $100 \times 100 = 10\,000 \text{ cm}^2$.

ii Area of one inner square = $20 \times 20 = 400 \text{ cm}^2$.

iii Area of shaded region = $10\,000 - 9 \times 400 = 6400 \text{ cm}^2$.

b i $\Pr(\text{one dart will score } 7) = \frac{400}{10\,000}$
 $= 0.04$

(i.e. area of small square marked 7 divided by area of large square)

ii $\Pr(\text{at least } 7) = \Pr(7) + \Pr(8) + \Pr(9)$
 $= 3 \times 0.4 = 0.12$

iii $\Pr(\text{score will be } 0) = \frac{\text{area of shaded region}}{\text{total area of board}}$
 $= \frac{6400}{10\,000} = 0.64$

c i To get 18 from two darts, 9 and 9 need to be thrown.

$$\Pr(18) = 0.04 \times 0.04$$

$$= 0.0016$$

ii Throws to score 24 are 6, 9, 9 or 7, 8, 9 or 8, 8, 8 in any order, i.e. possible throws

6	9	9	7	8	9
7	9	8	8	7	9
8	8	8	8	9	7
9	6	9	9	7	8
9	8	7	9	9	6

There are 10 winning combinations.

$$\Pr(\text{a winning combination}) = (0.04)^3$$

$$\begin{aligned} \therefore \Pr(\text{scoring 24}) &= 10 \times (0.04)^3 \\ &= 10 \times 0.000064 \\ &= 0.00064 \end{aligned}$$

13 a The possible choices are $c \quad b$

8 11
3 11
3 7

$$\Pr(c < b) = \Pr(c = 8, b = 11) + \Pr(c = 3, b = 11) + \Pr(c = 3, b = 7)$$

$$\begin{aligned} &= \frac{1}{3} \times \frac{1}{6} + \frac{2}{3} \times \frac{1}{6} + \frac{2}{3} \times \frac{1}{3} \\ &= \frac{1}{18} + \frac{2}{18} + \frac{2}{9} \\ &= \frac{7}{18} \approx 0.3889 \end{aligned}$$

b Possible choices $b \quad c \quad a$

1 3 6
1 3 10
1 8 10
7 3 10
7 8 10

$$\begin{aligned} \Pr(a > \text{both } b \text{ and } c) &= \Pr(a = 6, b = 1, c = 3) + \Pr(a = 10, b = 1, c = 3) \\ &\quad + \Pr(a = 10, b = 1, c = 8) + \Pr(a = 10, b = 7, c = 3) \end{aligned}$$

$$\begin{aligned} &\quad + \Pr(a = 10, b = 7, c = 8) \\ &= \frac{2}{3} \times \frac{1}{2} \times \frac{2}{3} + \frac{1}{6} \times \frac{1}{2} \times \frac{2}{3} + \frac{1}{6} \times \frac{1}{2} \times \frac{1}{3} + \frac{1}{6} \times \frac{1}{3} \times \frac{2}{3} \\ &\quad + \frac{1}{6} \times \frac{1}{3} \times \frac{1}{3} \\ &= \frac{4}{18} + \frac{2}{36} + \frac{1}{36} + \frac{2}{54} + \frac{1}{54} \\ &= \frac{24 + 6 + 3 + 4 + 2}{108} \\ &= \frac{39}{108} \\ &= \frac{13}{36} \approx 0.3611 \end{aligned}$$

c	Possible choices	<i>a</i>	<i>b</i>	<i>c</i>
		0	1	3
		0	1	8
		0	7	8
		6	1	8

$$\begin{aligned}
\Pr(c > a + b) &= \Pr(c = 3, a = 0, b = 1) + \Pr(c = 8, a = 0, b = 1) \\
&\quad + \Pr(c = 8, a = 0, b = 7) + \Pr(c = 8, a = 6, b = 1) \\
&= \frac{2}{3} \times \frac{1}{6} \times \frac{1}{2} + \frac{1}{3} \times \frac{1}{6} \times \frac{1}{2} + \frac{1}{3} \times \frac{1}{6} \times \frac{1}{3} + \frac{1}{3} \times \frac{2}{3} \times \frac{1}{2} \\
&= \frac{2}{36} + \frac{1}{36} + \frac{1}{54} + \frac{2}{18} \\
&= \frac{6 + 3 + 2 + 12}{108} \\
&= \frac{23}{108} \approx 0.2130
\end{aligned}$$

14 a It can be considered as a binomial distribution, with $n = 5$ and $p = 0.2$.
Let X be the number of trout caught in 5 days.

i $\Pr(X = 0) = (0.8)^5 = 0.32768 \approx 0.328$

ii $\Pr(X = 2) = {}^5C_2(0.2)^2(0.8)^3 = 0.2048 \approx 0.205$

iii Probability of at least 1 = $\Pr(X \geq 1)$
 $= 1 - \Pr(X = 0) = 1 - (0.8)^5 = 0.67232 \approx 0.672$

b i For n days, the probability of catching no trout = $(0.8)^n$.
Therefore the probability of catching at least one = $1 - (0.8)^n$.

Consider $1 - (0.8)^n > 0.9$

which is equivalent to $(0.8)^n < 0.1$

Using a calculator gives $n = 11$

ii For n days, the probability of catching no trout = $(0.8)^n$.
For n days, the probability of catching one trout = $0.2n(0.8)^{n-1}$ (binomial distribution).

Probability of catching more than one = $1 - 0.2n(0.8)^{n-1} - (0.8)^n$.

Use a calculator to find the value of n . It is 18 days.

15 a Let X be the number of goals scored. X is the random variable of a binomial distribution. The parameter values are $n = 10$ and $p = 0.3$.

i $\Pr(X = 1) = {}^{10}C_1(0.3)(0.7)^9 \approx 0.121$

ii $\Pr(X \geq 2) = 1 - \Pr(X \leq 1)$
 $= 1 - 0.149308 \dots \approx 0.851$

iii $\Pr(X \leq 2) \approx 0.383$

b i The probability of scoring at least one goal

$$= 1 - \text{probability of scoring no goals}$$

$$= 1 - (0.7)^n$$

Therefore the least value of n , for which the probability of scoring at least one goal is more than 0.95, is given by the inequality

$$1 - (0.7)^n > 0.95$$

or equivalently $(0.7)^n < 0.05$

The smallest such value is 9.

ii The probability of scoring more than one goal

$$= 1 - \text{probability of scoring no goals or one goal}$$

$$= 1 - (0.7)^n - n \times 0.3 \times (0.7)^{n-1}$$

Therefore the least value of n , for which the probability of scoring more than one goal is more than 0.95, is given by the inequality

$$1 - (0.7)^n - n \times 0.3 \times (0.7)^{n-1} > 0.95$$

or equivalently $(0.7)^n + n \times 0.3 \times (0.7)^{n-1} < 0.05$

The smallest such value of n is 14.

Chapter 13 – Exponential functions and logarithms

Solutions to Exercise 13A

1 a $x^2x^3 = x^{2+3} = x^5$

b $2(x^3x^4)4 = 8x^{3+4} = 8x^7$

c $x^5 \div x^3 = x^{5-3} = x^2$

d $4x^6 \div 2x^3 = 2x^{6-3} = 2x^3$

e $(a^3)^2 = a^{2 \times 3} = a^6$

f $(2^3)^2 = 2^{3 \times 2} = 2^6$

g $(xy)^2 = x^2y^2$

h $(x^2y^3)^2 = (x^2)^2(y^3)^2$
 $= x^{2 \times 2}y^{3 \times 2} = x^4y^6$

i $\left(\frac{x}{y}\right)^3 = \frac{x^3}{y^3}$

j $\left(\frac{x^3}{y^2}\right)^2 = \frac{(x^3)^2}{(y^2)^2}$
 $= \frac{x^{3 \times 2}}{y^{2 \times 2}} = \frac{x^6}{y^4}$

2 a $3^5 \times 3^{12} = 3^{5+12} = 3^{17}$

b $x^3y^2 \times x^4y^3 = x^{3+4}y^{2+3} = x^7y^5$

c $3^{x+1} \times 3^{3x+2} = 3^{x+1+3x+2} = 3^{4x+3}$

d $5a^3b^2 \times 6a^2b^4 = 30a^{3+2}b^{2+4} = 30a^5b^6$

3 a $\frac{x^5y^2}{x^3y} = x^{5-3}y^{2-1} = x^2y$

b $\frac{b^{5x} \times b^{2x+1}}{b^{3x}} = b^{5x+2x+1-3x} = b^{4x+1}$

c $\frac{8a^2b \times 3a^5b^2}{6a^2b^2} = 4a^{2+5-2}b^{1+2-2} = 4a^5b$

4 a $7^{-2} = \frac{1}{7^2} = \frac{1}{49}$

b $\left(\frac{1}{4}\right)^{-3} = 4^3 = 64$

c $\left(\frac{5}{2}\right)^{-3} = \left(\frac{2}{5}\right)^3 = \frac{8}{125}$

5 a $(b^5)^2 = b^{10}$

b $\left(\left(\frac{1}{3}\right)^{-2}\right)^3 = \left(\frac{1}{3}\right)^{-6} = 3^6 = 729$

c $(b^5)^2 \times (b^2)^{-3} = b^{10} \times b^{-6} = b^4$

6 a $(3a^4b^3)^3 \times (4a^2b^4)^{-2}$
 $= 27a^{12}b^9 \times 4^{-2}a^{-4}b^{-8}$
 $= \frac{27}{16}a^8b$

b $\left(\frac{5a^3b^3}{ab^2c^2}\right)^3 \div (a^2b^{-1}c)^3$
 $= \left(5a^2bc^{-2}\right)^3 \times a^{-6}b^3c^{-3}$
 $= 125a^6b^3c^{-6} \times a^{-6}b^3c^{-3}$
 $= 125b^6c^{-9}$
 $= \frac{125b^6}{c^9}$

7 a $(-2)^6 = 64$

b $(-3a)^3 = -27a^3$

c $(-2a)^5 \times 3a^{-2} = -32a^5 \times 3a^{-2}$
 $= -96a^3$

$$8 \text{ a } 36^n \times 12^{-2n} = 2^{-2n}$$

$$b \frac{2^{-3} \times 8^4 \times 32^{-3}}{4^{-4} \times 2^{-2}} = 2^4$$

$$c \frac{5^{2n} \times 10^n}{8^n \times 5^n} = \frac{5^{2n}}{2^{2n}}$$

$$9 \text{ a } x^3 x^4 x^2 = x^{3+4+2} = x^9$$

$$b \quad 2^4 4^3 8^2 = 2^4 2^6 2^6 \\ = 2^{4+6+6} = 2^{16}$$

$$c \quad 3^4 9^2 27^3 = 3^4 3^4 3^9 \\ = 3^{4+4+9} = 3^{17}$$

$$d \quad (q^2 p)^3 (qp^3)^2 = q^6 p^3 q^2 p^6 \\ = q^{6+2} p^{3+6} = q^8 p^9$$

$$e \quad a^2 b^{-3} (a^3 b^2)^3 = a^2 b^{-3} a^9 b^6 \\ = a^{2+9} b^{6-3} = a^{11} b^3$$

$$f \quad (2x^3)^2 (4x^4)^3 = 2^2 x^{3 \times 2} 4^3 x^{3 \times 4} \\ = 2^2 2^6 x^6 x^{12} = 2^8 x^{18}$$

$$g \quad m^3 p^2 (m^2 n^3)^4 (p^{-2})^2 = m^3 p^2 m^8 n^{12} p^{-4} \\ = m^{11} n^{12} p^{-2}$$

$$h \quad 2^3 a^3 b^2 (2a^{-1} b^2)^{-2} = 2^3 a^3 b^2 2^{-2} a^2 b^{-4} \\ = 2a^5 b^{-2}$$

$$10 \text{ a } \frac{x^3 y^5}{xy^2} = x^{3-1} y^{5-2} = x^2 y^3$$

$$b \quad \frac{16a^5 b 4a^4 b^3}{8ab} = \frac{64}{8} a^{5+4-1} b^{1+3-1} \\ = 8a^8 b^3$$

$$c \quad \frac{(-2xy)^2 2(x^2 y)^3}{8(xy)^3} = \frac{4x^2 y^2 2x^6 y^3}{8x^3 y^3} \\ = \frac{8}{8} x^{2+6-3} y^{2+3-3} \\ = x^5 y^2$$

$$d \quad \frac{(-3x^2 y^3)^2 4x^4 y^3}{(2xy)^3 (xy)^3} = \frac{9x^4 y^6 4x^4 y^3}{8x^3 y^3 x^3 y^3} \\ = \frac{9}{2} x^{4+4-3-3} y^{6+3-3-3} \\ = \frac{9x^2 y^3}{2}$$

11 a

$$m^3 n^2 p^{-2} (mn^2 p)^{-3} = m^3 n^2 p^{-2} m^{-3} n^{-6} p^{-3} \\ = m^{3-3} n^{2-6} p^{-2-3} \\ = n^{-4} p^{-5} = \frac{1}{n^4 p^5}$$

b

$$\frac{x^3 y z^{-2} 2(x^3 y^{-2} z)^2}{xyz^{-1}} = \frac{2x^3 y z^{-2} x^6 y^{-4} z^2}{xyz^{-1}} \\ = 2x^{3+6-1} y^{1-4-1} z^{-2+2+1} \\ = 2x^8 y^{-4} z = \frac{2x^8 z}{4}$$

$$c \quad \frac{a^2 b (ab^{-2})^{-3}}{(a^{-2} b^{-1})^{-2}} = \frac{a^2 b a^{-3} b^6}{a^4 b^2} \\ = a^{2-3-4} b^{1+6-2} \\ = a^{-5} b^5 = \frac{b^5}{a^5}$$

$$d \quad \frac{a^2 b^3 c^{-4}}{a^{-1} b^2 c^{-3}} = a^{2+1} b^{3-2} c^{3-4} \\ = \frac{a^3 b}{c}$$

$$e \quad \frac{a^{2n-1} b^3 c^{1-n}}{a^{n-3} b^{2-n} c^{2-2n}} \\ = a^{2n-1-n+3} b^{3-2+n} c^{1-n-2+2n} \\ = a^{n+2} b^{n+1} c^{n-1}$$

$$12 \text{ a } 3^{4n}9^{2n}27^{3n} = 3^{4n}3^{4n}3^{9n} \\ = 3^{17n}$$

$$\text{b } \frac{2^n 8^{n+1}}{32^n} = \frac{2^n 2^{3n+3}}{2^{5n}} \\ = 2^{n+3n+3-5n} = 2^{3-n}$$

$$\text{c } \frac{3^{n-1}9^{2n-3}}{6^2 3^{n+2}} = \frac{3^{n-1}3^{4n-6}}{6^2 3^{n+2}} \\ = \frac{3^{4n-9}}{36} = \frac{3^{4n-11}}{2^2}$$

$$\text{d } \frac{2^{2n}9^{2n-1}}{6^{n-1}} = \frac{2^{2n}3^{4n-2}}{6^{n-1}} \\ = \frac{2^{2n}3^{4n-2}}{2^{n-1}3^{n-1}} \\ = 2^{2n-n+1}3^{4n-2-n+1} \\ = 2^{n+1}3^{3n-1}$$

$$\text{e } \frac{25^{2n}5^{n-1}}{5^{2n+1}} = \frac{5^{4n}5^{n-1}}{5^{2n+1}} \\ = 5^{4n+n-1-2n-1} = 5^{3n-2}$$

$$\text{f } \frac{6^{x-3}4^x}{3^{x+1}} = \frac{3^{x-3}2^{x-3}2^{2x}}{3^{x+1}} \\ = 3^{x-3-x-1}2^{x-3+2x} \\ = 2^{3x-3}3^{-4}$$

$$\text{g } \frac{6^{2n}9^3}{27^n 8^n 16^n} = \frac{3^{2n}2^{2n}3^6}{3^{3n}2^{3n}2^{4n}} \\ = 3^{2n+6-3n}2^{2n-3n-4n} \\ = 3^{6-n}2^{-5n}$$

$$\text{h } \frac{3^{n-2}9^{n+1}}{27^{n-1}} = \frac{3^{n-2}3^{2n+2}}{3^{3n-3}} \\ = 3^{n-2+2n+2-3n+3} \\ = 3^3 = 27$$

$$\text{i } \frac{82^5 3^7}{9^2 7^8 1} = \frac{2^3 2^5 3^7}{3^2 2^7 3^4} \\ = 2^{3+5-7}3^{7-2-4} \\ = (2)(3) = 6$$

$$13 \text{ a } \frac{(8^3)^4}{(2^{12})^2} = \frac{2^{36}}{2^{24}} \\ = 2^{36-24} \\ = 2^{12} = 4096$$

$$\text{b } \frac{(125)^3}{(25)^2} = \frac{5^9}{5^4} \\ = 5^{9-4} \\ = 5^5 = 3125$$

$$\text{c } \frac{(81)^4 \div (27^3)}{9^2} = \frac{3^{16} \div 3^9}{3^4} \\ = \frac{3^{16} \div 3^9}{3^4} \\ = 3^{16-9-4} \\ = 3^3 = 27$$

Solutions to Exercise 13B

$$1 \text{ a } 125^{\frac{2}{3}} = 5^2 = 25$$

$$\text{b } 243^{\frac{3}{5}} = 3^3 = 27$$

$$\text{c } 81^{-\frac{1}{2}} = \frac{1}{\sqrt{81}} = \frac{1}{9}$$

$$\text{d } 64^{\frac{2}{3}} = 4^2 = 16$$

$$\text{e } \left(\frac{1}{8}\right)^{\frac{1}{3}} = \frac{1}{2}$$

$$\text{f } 32^{-\frac{2}{5}} = \frac{1}{32^{\frac{2}{5}}} \\ = \frac{1}{2^2} = \frac{1}{4}$$

$$\text{g } 125^{-\frac{2}{3}} = \frac{1}{125^{\frac{2}{3}}} \\ = \frac{1}{5^2} = \frac{1}{25}$$

$$\text{h } 32^{\frac{4}{5}} = 2^4 = 16$$

$$\text{i } 1000^{\frac{4}{3}} = \frac{1}{100^{\frac{4}{3}}} \\ = \frac{1}{10^4} = \frac{1}{10\,000}$$

$$\text{j } 10\,000^{\frac{3}{4}} = 10^3 = 1000$$

$$\text{k } 81^{\frac{3}{4}} = 3^3 = 27$$

$$\text{l } \left(\frac{27}{125}\right)^{\frac{1}{3}} = \left(\frac{3}{5}\right)^{\frac{3}{3}} = \frac{3}{5}$$

$$2 \text{ a } (a^2b)^{\frac{1}{3}} \div \sqrt{ab^3} = \frac{a^{\frac{2}{3}}b^{\frac{1}{3}}}{a^{\frac{1}{2}}b^{\frac{3}{2}}} \\ = a^{\frac{2}{3}-\frac{1}{2}}b^{\frac{1}{3}-\frac{3}{2}} \\ = a^{\frac{1}{6}}b^{-\frac{7}{6}}$$

$$\text{b } = a^{-6}b^3b^{\frac{3}{2}} \\ = a^{-6}b^{3+\frac{3}{2}}b^{\frac{3}{2}} = a^{-6}b^{\frac{9}{2}}$$

$$\text{c } (45^{\frac{1}{3}}) \div (9^{\frac{3}{4}}15^{\frac{3}{2}}) = (3^{\frac{2}{3}}5^{\frac{1}{3}}) \div (3^{\frac{3}{2}}3^{\frac{3}{2}}5^{\frac{3}{2}}) \\ = 3^{\frac{2}{3}-\frac{3}{2}-\frac{3}{2}}5^{\frac{1}{3}-\frac{3}{2}} \\ = 3^{-\frac{7}{3}}5^{-\frac{7}{6}}$$

$$\text{d } 2^{\frac{3}{2}}4^{-\frac{1}{4}}16^{-\frac{3}{4}} = 2^{\frac{3}{2}}2^{-\frac{1}{2}}2^{-3} \\ = 2^{\frac{3}{2}-\frac{1}{2}-3} = 2^{-2} = \frac{1}{4}$$

$$\text{e } \left(\frac{x^3y^{-2}}{3^{-3}y^{-3}}\right)^{-2} \div \left(\frac{3^{-3}x^{-2}y}{x^4y^{-2}}\right)^2 = \left(\frac{x^{-6}y^4}{3^6y^6}\right)\left(\frac{x^8y^{-4}}{3^{-6}x^{-4}y^2}\right) \\ = 3^{6-6}x^{-6+8+4}y^{4-4-6-2} \\ = x^6y^{-8}$$

$$\text{f } \left((a^2)^{\frac{1}{5}}\right)^{\frac{3}{2}}\left((a^5)^{\frac{1}{3}}\right)^{\frac{1}{5}} = a^{\frac{2}{5}\frac{3}{2}}a^{\frac{5}{3}\frac{1}{5}} \\ = a^{\frac{3}{5}}a^{\frac{1}{3}} \\ = a^{\frac{3}{5}+\frac{1}{3}} = a^{\frac{14}{15}}$$

$$3 \text{ a } (2x-1)\sqrt{2x-1} = (2x-1)^{1+\frac{1}{2}} \\ = (2x-1)^{\frac{3}{2}}$$

$$\begin{aligned}\mathbf{b} \quad (x-1)^2 \sqrt{x-1} &= (x-1)^{2+\frac{1}{2}} \\ &= (x-1)^{\frac{5}{2}}\end{aligned}$$

$$\begin{aligned}\mathbf{c} \quad (x^2+1) \sqrt{x^2+1} &= (x^2+1)^{1+\frac{1}{2}} \\ &= (x^2+1)^{\frac{3}{2}}\end{aligned}$$

$$\begin{aligned}\mathbf{d} \quad (x-1)^3 \sqrt{x-1} &= (x-1)^{3+\frac{1}{2}} \\ &= (x-1)^{\frac{7}{2}}\end{aligned}$$

$$\begin{aligned}\mathbf{e} \quad \frac{1}{\sqrt{x-1}} + \sqrt{x-1} &= \frac{1+x-1}{\sqrt{x-1}} \\ &= x(x-1)^{-\frac{1}{2}}\end{aligned}$$

$$\begin{aligned}\mathbf{f} \quad (5x^2+1)(5x^2+1)^{\frac{1}{3}} &= (5x^2+1)^{1+\frac{1}{3}} \\ &= (5x^2+1)^{\frac{4}{3}}\end{aligned}$$

Solutions to Exercise 13C

1

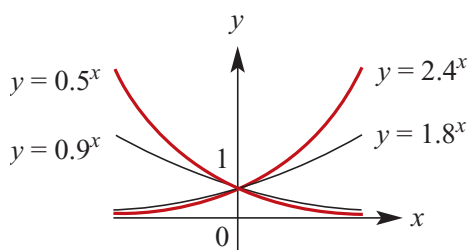

If the bases > 1 the function is increasing; if < 1 they are decreasing.

2

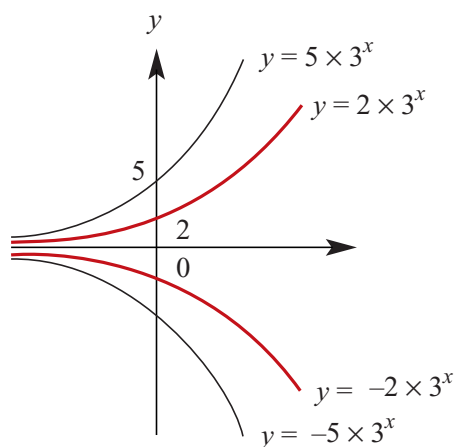

All graphs have an asymptote at $y = 0$. The y -intercepts are wherever the constant is in front of the exponential, however, at 2, -2, 5 and -5. The negative values are also below the axis instead of above.

3 $y = 2^x$ for $x \in [-4, 4]$:

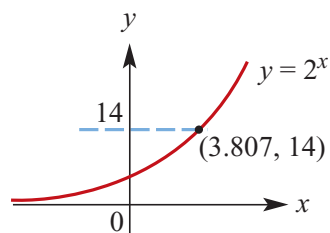

$2^x = 14$: solution of the equation is where the graph cuts the line $y = 14$, i.e. $x = 3.807$

4 $y = 10^x$; $x \in [-0.4, 0.8]$

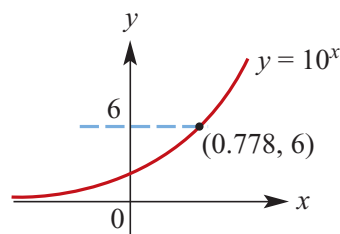

$10^x = 6$: solution of the equation is where the graph cuts the line $y = 6$, i.e. $x = 0.778$

5 a $f: R \rightarrow R$; $f(x) = 3(2^x) + 2$

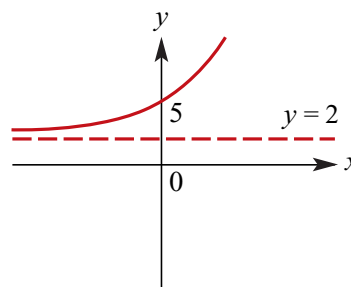

Asymptote at $y = 2$,
 y -axis intercept at $(0, 5)$,
 range = $(2, \infty)$

b $f: R \rightarrow R$; $f(x) = 3(2^x) - 3$

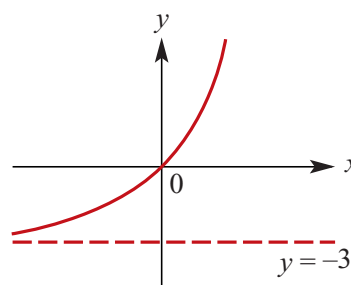

Asymptote at $y = -3$,
 y -axis intercept at $(0, 0)$,
 range = $(-3, \infty)$

c $f: R \rightarrow R$; $f(x) = -3^x - 2$

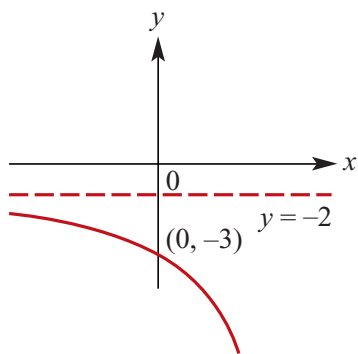

Asymptote at $y = -2$,
y-axis intercept at $(0, -3)$,
range = $(-\infty, -2)$

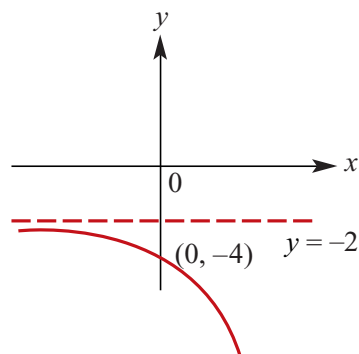

Asymptote at $y = -2$,
y-axis intercept at $(0, -4)$,
range = $(-\infty, -2)$

d $f: R \rightarrow R; f(x) = -2(3^x) + 2$

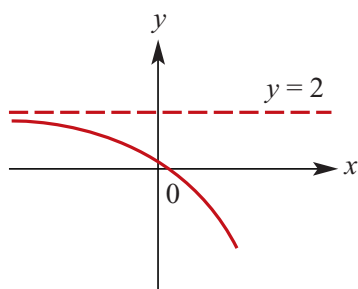

Asymptote at $y = 2$,
y-axis intercept at $(0, 0)$,
range = $(-\infty, 2)$

6 a $y = 2(5^x)$

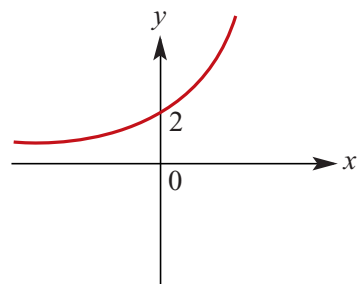

Asymptote at $y = 0$,
y-axis intercept at $(0, 2)$,
range = $(0, \infty)$

e $f: R \rightarrow R; f(x) = \left(\frac{1}{2}\right)^x + 2$

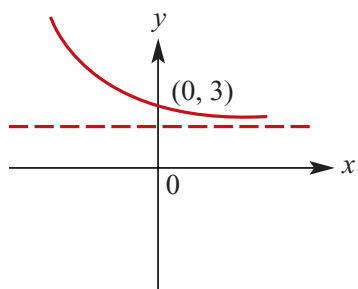

Asymptote at $y = 2$,
y-axis intercept at $(0, 3)$,
range = $(2, \infty)$

b $y = 3^{3x}$

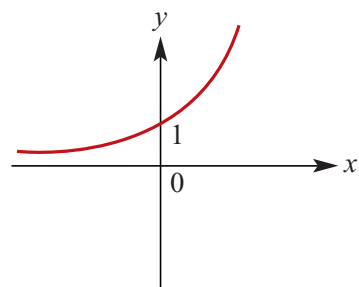

Asymptote at $y = 0$,
y-axis intercept at $(0, 1)$,
range = $(0, \infty)$

f $f: R \rightarrow R; f(x) = -2(3^x) - 2$

c $y = 5^{\frac{x}{2}}$

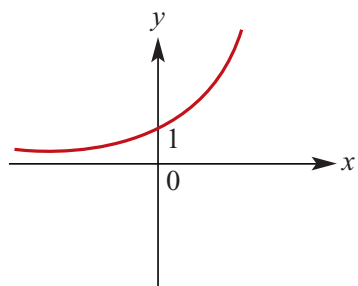

Asymptote at $y = 0$,
 y-axis intercept at $(0, 1)$,
 range = $(0, \infty)$

d $y = -3(2^x) + 2$

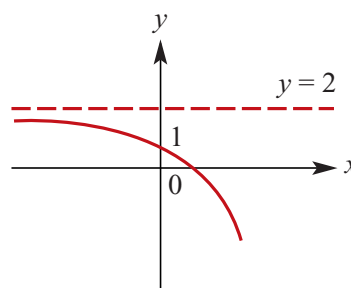

Asymptote at $y = 2$,
 y-axis intercept at $(0, 1)$,
 range = $(-\infty, 2)$

Solutions to Exercise 13D

1 a $3^x = 27 = 3^3, \therefore x = 3$

b $4^x = 64 = 4^3, \therefore x = 3$

c $49^x = 7 = 49^{\frac{1}{2}}, \therefore x = \frac{1}{2}$

d $16^x = 8, \therefore 2^{4x} = 2^3$
 $\therefore 4x = 3, \therefore x = \frac{3}{4}$

e $125^x = 5, \therefore 5^{3x} = 5$
 $\therefore 3x = 1, \therefore x = \frac{1}{3}$

f $5^x = 625 = 5^4, \therefore x = 4$

g $16^x = 256 = 16^2, \therefore x = 2$

h $4^{-x} = \frac{1}{64}, \therefore 4^x = 64$
 $\therefore 4^x = 4^3, \therefore x = 3$

i $5^{-x} = \frac{1}{125}, \therefore 5^x = 125$
 $\therefore 5^x = 5^3, \therefore x = 3$

2 a $5^n 25^{2n-1} = 125$

$$\therefore 5^n 5^{4n-2} = 5^3$$

$$5^{5n-2} = 5^3$$

$$5n - 2 = 3, \therefore n = 1$$

b $3^{2n-4} = 1$

$$\therefore 3^{2n-4} = 3^0$$

$$2n - 4 = 0, \therefore n = 2$$

c $3^{2n-1} = \frac{1}{81}$

$$\therefore 3^{2n-1} = 3^{-4}$$

$$2n - 1 = -4, \therefore n = -\frac{3}{2}$$

d $\frac{3^{n-2}}{9^{1-n}} = 1$

$$\therefore 3^{n-2} = 9^{1-n}$$

$$3^{n-2} = 3^{2(1-n)}$$

$$n - 2 = 2 - 2n$$

$$3n = 4, n = \frac{4}{3}$$

e $3^{3n} 9^{-2n+1} = 27$

$$\therefore 3^{3n} 3^{2-4n} = 3^3$$

$$3^{3n+2-4n} = 3^3$$

$$2 - n = 3, \therefore n = -1$$

f $2^{-3n} 4^{2n-2} = 16$

$$\therefore 2^{-3n} 2^{4n-4} = 2^4$$

$$2^{4n-3n-4} = 2^4$$

$$n - 4 = 4, \therefore n = 8$$

g $2^{n-6} = 8^{2-n} = 2^{6-3n}$

$$\therefore n - 6 = 6 - 3n$$

$$4n = 12, \therefore n = 3$$

h $9^{3n+3} = 27^{n-2}$

$$\therefore 3^{6n+6} = 3^{3n-6}$$

$$6n + 6 = 3n - 6$$

$$3n = -12, \therefore n = -4$$

i $4^{n+1} = 8^{n-2}$

$$\therefore 2^{2n+2} = 2^{3n-6}$$

$$2n + 2 = 3n - 6, n = 8$$

$$\begin{aligned} \mathbf{j} \quad 32^{2n+1} &= 8^{4n-1} \\ \therefore 2^{10n+5} &= 2^{12n-3} \\ 10n + 5 &= 12n - 3 \\ 2n &= 8, \therefore n = 4 \end{aligned}$$

$$\begin{aligned} \mathbf{k} \quad 25^{n+1} &= 5 \times 390\,625 \\ \therefore 25^{n+1} &= (25)^{\frac{1}{2}}(25)^4 = 25^{\frac{9}{2}} \\ n + 1 &= \frac{9}{2}, \therefore n = \frac{7}{2} = 3\frac{1}{2} \end{aligned}$$

$$\begin{aligned} \mathbf{l} \quad 125^{4-n} &= 5^{6-2n} \\ \therefore 5^{12-3n} &= 5^{6-2n} \\ 12 - 3n &= 6 - 2n, \therefore n = 6 \end{aligned}$$

$$\begin{aligned} \mathbf{m} \quad 4^{2-n} &= \frac{1}{2048} \\ \therefore 2^{4-2n} &= 2^{-11} \\ 4 - 2n &= -11 \\ 2n &= 15, \therefore n = \frac{15}{2} \end{aligned}$$

$$\begin{aligned} \mathbf{3 a} \quad 2^{x-1}4^{2x+1} &= 32 \\ \therefore 2^{x-1}2^{4x+2} &= 2^5 \\ 2^{x-1+4x+2} &= 2^5 \\ 5x + 1 &= 5, \therefore x = \frac{4}{5} \end{aligned}$$

$$\begin{aligned} \mathbf{b} \quad 3^{2x-1}9^x &= 243 \\ \therefore 3^{2x-1}3^{2x} &= 3^5 \\ 3^{2x-1+2x} &= 3^5 \\ 4x - 1 &= 5 \\ 4x &= 6, \therefore x = \frac{3}{2} \end{aligned}$$

$$\begin{aligned} \mathbf{c} \quad (27 \cdot 3^x)^2 &= 27^x 3^{\frac{1}{2}} \\ \therefore (3^3 3^x)^2 &= 3^{3x} 3^{\frac{1}{2}} \\ 3^{6+2x} &= 3^{3x+\frac{1}{2}} \\ 2x + 6 &= 3x + \frac{1}{2}, \therefore x = \frac{11}{2} = 5\frac{1}{2} \end{aligned}$$

$$\begin{aligned} \mathbf{4 a} \quad 4(2^{2x}) &= 8(2^x) - 4, A = 2^x \\ \therefore 4A^2 &= 8A - 4 \\ A^2 - 2A + 1 &= 0 \\ (A - 1)^2 &= 0 \\ A = 2^x &= 1, \therefore x = 0 \end{aligned}$$

$$\begin{aligned} \mathbf{b} \quad 8(2^{2x}) - 10(2^x) + 2 &= 0, A = 2^x \\ \therefore 8A^2 - 10A + 2 &= 0 \\ 4A^2 - 5A + 1 &= 0 \\ (4A - 1)(A - 1) &= 0 \\ A = 2^x &= \frac{1}{4}, 1 \\ \therefore x &= -2, 0 \end{aligned}$$

$$\begin{aligned} \mathbf{c} \quad 3(2^{2x}) - 18(2^x) + 24 &= 0, A = 2^x \\ \therefore 3A^2 - 18A + 24 &= 0 \\ A^2 - 6A + 8 &= 0 \\ (A - 2)(A - 4) &= 0 \\ A = 2^x &= 2, 4 \\ \therefore x &= 1, 2 \end{aligned}$$

$$\begin{aligned} \mathbf{d} \quad 9^x - 4(3^x) + 3 &= 0, A = 3^x \\ \therefore (A - 1)(A - 3) &= 0 \\ A = 3^x &= 1, 3 \\ \therefore x &= 0, 1 \end{aligned}$$

5 a $2^x = 5, \therefore x = 2.32$

b $4^x = 6, \therefore x = 1.29$

c $10^x = 18, \therefore x = 1.26$

d $10^x = 56, \therefore x = 1.75$

6 a $7^x > 49, \therefore 7^x > 7^2$

$\therefore x > 2$

b $8^x > 2, \therefore 2^{3x} > 2^1$

$3x > 1, \therefore x > \frac{1}{3}$

c $25^x \leq 5, \therefore 5^{2x} \leq 5^1$

$2x \leq 1, \therefore x \leq \frac{1}{2}$

d $3^{x+1} < 81, \therefore 3^{x+1} < 3^4$

$x + 1 < 4, \therefore x < 3$

e $9^{2x+1} < 243, \therefore 3^{4x+2} < 3^5$

$4x + 2 < 5$

$4x < 3, \therefore x < \frac{3}{4}$

f $4^{2x+1} > 64, \therefore 4^{2x+1} > 4^3$

$2x + 1 > 3, \therefore x > 1$

g $3^{2x-2} \leq 81, \therefore 3^{2x-2} \leq 3^4$

$2x - 2 \leq 4, \therefore x \leq 3$

Solutions to Exercise 13E

1 a $\log_2 128 = 7$

b $\log_3 81 = 4$

c $\log_5 125 = 3$

d $\log_{10} 0.1 = -1$

2 a $\log_2 10 + \log_2 a = \log_2 10a$

b $\log_{10} 5 + \log_{10} 2 = \log_{10} 10 = 1$

c $\log_2 9 - \log_2 4 = \log_2 \left(\frac{9}{4}\right)$

d $\log_2 10 - \log_2 5 = \log_2 \left(\frac{10}{5}\right)$
 $= \log_2 2 = 1$

e $\log_2 a^3 = 3 \log_2 a$

f $\log_2 8^3 = 3 \log_2 8 = 9$

g $\log_5 \left(\frac{1}{6}\right) = -\log_5 6$

h $\log_5 \left(\frac{1}{25}\right) = -\log_5 25 = -2$

3 a $\log_3 27 = \log_3 3^3$
 $= 3 \log_3 3 = 3$

b $\log_5 625 = \log_5 5^4$
 $= 4 \log_5 5 = 4$

c $\log_2 \left(\frac{1}{128}\right) = \log_2 2^{-7}$
 $= -7 \log_2 2 = -7$

d $\log_4 \left(\frac{1}{64}\right) = \log_4 4^{-3}$
 $= -3 \log_4 4 = -3$

e $\log_x x^4 = 4 \log_x x = 4$

f $\log_2 0.125 = -\log_2 8$
 $= -3 \log_2 2 = -3$

g $\log_{10} 10000 = \log_{10} 10^4$
 $= 4 \log_{10} 10 = 4$

h $\log_{10} 0.000001 = \log_{10} 10^{-6}$
 $= -6 \log_{10} 10 = -6$

i $-3 \log_5 125 = -3 \log_5 5^3$
 $= -9 \log_5 5 = -9$

j $-4 \log_{16} 2 = -\log_{16} 16 = -1$

k $2 \log_3 9 = 4 \log_3 3 = 4$

l $-4 \log_{16} 4 = -2 \log_{16} 16 = -2$

4 a $\frac{1}{2} \log_{10} 16 + 2 \log_{10} 5 = \log_{10} (\sqrt{16} (5^2))$
 $= \log_{10} 100 = 2$

b $\log_2 16 + \log_2 8 = \log_2 2^4 + \log_2 2^3$
 $= 4 + 3 = 7$

c $\log_2 128 + \log_3 45 - \log_3 5$
 $= \log_2 2^7 + \log_3 5(3^2) - \log_3 5$
 $= 7 + 2 \log_3 3 + \log_3 5 - \log_3 5$
 $= 7 + 2 = 9$

$$\begin{aligned} \text{d } \log_4 32 - \log_9 27 &= \log_4 2^5 - \log_9 3^3 \\ &= \log_4 4^2 - \log_9 9^2 \\ &= \frac{5}{2} - \frac{3}{2} = 1 \end{aligned}$$

$$\begin{aligned} \text{e } \log_b b^3 - \log_b \sqrt{b} &= \log_b b^3 - \log_b \left(b^{\frac{1}{2}}\right) \\ &= 3 - \frac{1}{2} = \frac{5}{2} \end{aligned}$$

$$\begin{aligned} \text{f } 2 \log_x a + \log_x a^3 &= 2 \log_x a + 3 \log_x a \\ &= 5 \log_x a \\ &= \log_x a^5 \end{aligned}$$

$$\begin{aligned} \text{g } x \log_2 8 + \log_2(8^{1-x}) &= \log_2 8^x + \log_2(8^{1-x}) \\ &= \log_2(8^{x+1-x}) \\ &= \log_x 8 = 3 \end{aligned}$$

$$\begin{aligned} \text{h } \frac{3}{2} \log_a a - \log_a \sqrt{a} &= \frac{3}{2} - \log_a \left(a^{\frac{1}{2}}\right) \\ &= \frac{3}{2} - \frac{1}{2} = 1 \end{aligned}$$

$$\begin{aligned} \text{5 a } \log_3 9 &= x \\ x &= \log_3 3^2 = 2 \end{aligned}$$

$$\begin{aligned} \text{b } \log_5 x &= -3 \\ x &= 5^{-3}, \therefore x = \frac{1}{125} \end{aligned}$$

$$\begin{aligned} \text{c } \log_3 x &= -3 \\ x &= 3^3, \therefore x = 27 \end{aligned}$$

$$\begin{aligned} \text{d } \log_{10} x &= \log_{10} 4 + \log_{10} 2 \\ \log_{10} x &= \log_{10} 8 \\ \therefore x &= 8 \end{aligned}$$

e

$$\begin{aligned} \log_{10} 2 + \log_{10} 5 + \log_{10} x - \log_{10} 3 &= 2 \\ \log_{10} \left(\frac{10x}{3}\right) &= 2 \\ \frac{10x}{3} &= 10^2 \\ \therefore x &= 30 \end{aligned}$$

$$\begin{aligned} \text{f } \log_{10} x &= \frac{1}{2} \log_{10} 36 - 2 \log_{10} 3 \\ \log_{10} x &= \log_{10} \sqrt{36} - \log_{10} 3^2 \\ \log_{10} x &= \log_{10} \frac{6}{9} \\ \therefore x &= \frac{2}{3} \end{aligned}$$

$$\begin{aligned} \text{g } \log_x 64 &= 2 \\ 64 &= x^2 \\ x^2 &= 64, \therefore x = 8 \\ &\text{(no negative solutions for log base)} \end{aligned}$$

$$\begin{aligned} \text{h } \log_5(2x - 3) &= 3 \\ 2x - 3 &= 5^3 \\ 2x - 3 &= 125, \therefore x = 64 \end{aligned}$$

$$\begin{aligned} \text{i } \log_5(x + 2) - \log_3 2 &= 1 \\ \log_3 \frac{x + 2}{2} &= 1 \\ \frac{x + 2}{2} &= 3^1 \\ \frac{x + 2}{2} &= 3 \\ x + 2 &= 6, \therefore x = 4 \end{aligned}$$

$$\begin{aligned} \text{j } \log_x 0.01 &= -2 \\ 0.01 &= x^{-2} \\ x^{-2} &= 0.01 \\ x^2 &= 100, \therefore x = 10 \end{aligned}$$

6 a $\log_x\left(\frac{1}{25}\right) = -2$
 $\log_x 25 = 2$
 $25 = x^2$
 $x^2 = 25, \therefore x = 5$
(No negative solutions for log base)

b $\log_4(2x - 1) = 3$
 $2x - 1 = 4^3$
 $2x - 1 = 64, \therefore x = \frac{65}{2} = 32.5$

c $\log_4(3x + 2) - \log_4 6 = 1$
 $\log_4 \frac{x+2}{6} = 1$
 $\frac{x+2}{6} = 4^1$
 $\frac{x+2}{6} = 4$
 $x+2 = 24, \therefore x = 22$

d $\log_4(3x + 4) + \log_4 16 = 5$
 $\log_4(3x + 4) + 2 = 5$
 $\log_4(3x + 4) = 3$
 $3x + 4 = 4^3$
 $3x + 4 = 64, \therefore x = 20$

e $\log_3(x^2 - 3x - 1) = 0$
 $x^2 - 3x - 1 = 1$
 $x^2 - 3x - 2 = 0$
 $\therefore x = \frac{3 \pm \sqrt{17}}{2}$

f $\log_3(x^2 - 3x + 1) = 0$
 $x^2 - 3x + 1 = 1$
 $x^2 - 3x = 0$
 $x(x - 3) = 0, x = 0, 3$

7 $\log_{10} x = a; \log_{10} y = c :$
 $\log_{10}\left(\frac{100x^3y^{-\frac{1}{2}}}{y^2}\right) = \log_{10}\left(100x^3y^{-\frac{5}{2}}\right)$
 $= \log_{10}(100x^3) + \log_{10}(y^{-\frac{5}{2}})$
 $= \log_{10}(100) + 3 \log_{10} x - \frac{5}{2} \log_{10} y$
 $= 3a - \frac{5c}{2} + 2$

8 $\log_{10} \frac{ab^2}{c} + \log_{10} \frac{c^2}{ab} - \log_{10}(bc)$
 $= \log_{10}\left(\frac{ab^2}{c}\right)\left(\frac{c^2}{ab}\right) - \log_{10}(bc)$
 $= \log_{10}(bc) - \log_{10}(bc)$
 $= \log_{10}\left(\frac{bc}{bc}\right) = \log_{10} 1 = 0$

9
 $\log_a\left(\frac{11}{3}\right) + \log_a\left(\frac{490}{297}\right) - 2 \log_a\left(\frac{7}{9}\right) = \log_a(k)$
 $\log_a\left(\frac{11}{3}\right)\left(\frac{490}{297}\right) - 2 \log_a\left(\frac{7}{9}\right) = \log_a(k)$
 $\log_a\left(\frac{490}{81}\right) - \log_a\left(\frac{7}{9}\right)^2 = \log_a(k)$
 $\log_a 10 + \log_a 1 = \log_a(k)$
 $\log_a 10 = \log_a(k)$
 $\therefore k = 10$

10 a $\log_{10}(x^2 - 2x + 8) = 2 \log_{10} x$
 $\log_{10}(x^2 - 2x + 8) = \log_{10} x^2$
 $x^2 - 2x + 8 = x^2$
 $-2x + 8 = 0, \therefore x = 4$

b

$$\log_{10}(5x) - \log_{10}(3 - 2x) = 1$$

$$\log_{10}\left(\frac{5x}{3 - 2x}\right) = 1$$

$$\left(\frac{5x}{3 - 2x}\right) = 10^1$$

$$5x = 10(3 - 2x)$$

$$x = 2(3 - 2x)$$

$$5x = 6$$

$$\therefore x = \frac{6}{5}$$

c $3 \log_{10}(x - 1) = \log_{10} 8$

$$3 \log_{10}(x - 1) = 3 \log_{10} 2$$

$$x - 1 = 2, \therefore x = 3$$

d

$$\log_{10}(20x) - \log_{10}(x - 8) = 2$$

$$\log_{10}\left(\frac{20x}{x - 8}\right) = 2$$

$$\left(\frac{20x}{x - 8}\right) = 10^2$$

$$20x = 100(x - 8)$$

$$x = 5x - 40$$

$$4x = 40$$

$$\therefore x = 10$$

e $\text{LHS} = 2 \log_{10} 5 + \log_{10}(x + 1)$

$$= \log_{10} 5^2 + \log_{10}(x + 1)$$

$$= \log_{10} 25(x + 1)$$

$$\text{RHS} = 1 + \log_{10}(2x + 7)$$

$$= \log_{10} 10 + \log_{10}(2x + 7)$$

$$= \log_{10} 10(2x + 7)$$

$$\therefore 25(x + 1) = 10(2x + 7)$$

$$5x + 5 = 4x + 14$$

$$x = 9$$

f $\text{LHS} = 1 + 2 \log_{10}(x + 1)$

$$= \log_{10} 10 + \log_{10}(x + 1)^2$$

$$= \log_{10} 10(x + 1)^2$$

$$\text{RHS} = \log_{10}(2x + 1) + \log_{10}(5x + 8)$$

$$= \log_{10}(2x + 1)(5x + 8)$$

$$\therefore 10(x + 1)^2 = (2x + 1)(5x + 8)$$

$$10x^2 + 20x + 10 = 10x^2 + 21x + 8$$

$$20x + 10 = 21x + 8$$

$$x = 2$$

Solutions to Exercise 13F

1 a $2^x = 7$

$$\therefore x = \frac{\log 7}{\log 2} = 2.81$$

b $2^x = 0.4$

$$\therefore x = \frac{\log 0.4}{\log 2} = -1.32$$

c $3^x = 14$

$$\therefore x = \frac{\log 14}{\log 3} = 2.40$$

d $4^x = 3$

$$\therefore x = \frac{\log 3}{\log 4} = 0.79$$

e $2^{-x} = 6$

$$\therefore x = -\frac{\log 6}{\log 2} = -2.58$$

f $0.3^x = 2$

$$\therefore x = \frac{\log 2}{\log 0.3} = -0.58$$

2 a $5^{2x-1} = 90$

$$\therefore (2x - 1) = \log_5 90$$

$$2x = \log_5(90) + 1$$

$$x = \frac{1}{2}(\log_5(90) + 1)$$

$$x = 1.90$$

b $3^{x-1} = 10$

$$\therefore (x - 1) \log 3 = \log 10$$

$$(x - 1) = \frac{\log 10}{\log 3}$$

$$x - 1 = 2.10$$

$$x = 3.10$$

or

$$3^{x-1} = 10$$

$$\therefore (x - 1) = \log_3(10)$$

$$x = \log_3(10) + 1$$

$$x = 3.10$$

c $0.2^{x+1} = 0.6$

$$\therefore (x + 1) \log 0.2 = \log 0.6$$

$$(x + 1) = \frac{\log 0.6}{\log 0.2}$$

$$x + 1 = 0.32$$

$$x = -0.68$$

3 a $2^x > 8, \therefore 2^x > 2^3$

$$\therefore x > 3$$

b $3^x < 5, \therefore x \log 3 < \log 5$

$$\therefore x < \frac{\log 5}{\log 3} < 1.46$$

c

$$0.3^x > 4, \therefore x \log 0.3 < \log 4$$

$$x < \frac{\log 4}{\log 0.3}$$

$$\therefore x < \frac{\log 4}{\log 0.3} < -1.15$$

d

$$3^{x-1} \leq 7, \quad \therefore (x-1) \log 3 \leq \log 7$$

$$(x-1) \leq \frac{\log 7}{\log 3}$$

$$(x-1) \leq \frac{\log 7}{\log 3} = 1.77$$

$$\therefore x \leq 2.77$$

e $0.4^x \leq 0.3, \quad \therefore x \leq 2.77$

$$\therefore x \geq \frac{\log 0.3}{\log 0.4} \geq 1.31$$

4 a $f(x) = 2^x - 4$

Asymptote at $y = -4$,
axis intercepts at $(0, -3)$ and $(2, 0)$

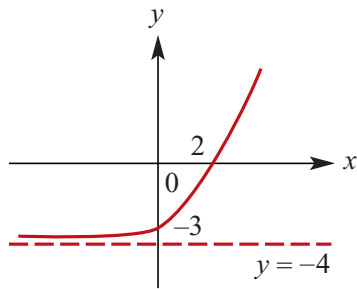

b $f(x) = 2(3^x) - 6$

Asymptote at $y = -6$,
axis intercepts at $(0, -4)$ and $(1, 0)$

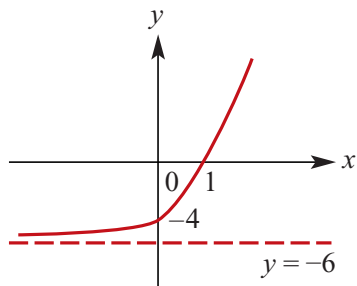

c $f(x) = 3(10^x) - 5$

Asymptote at $y = -5$,
axis intercepts at $(0, -2)$ and $(\log_{10}(\frac{5}{3}), 0)$

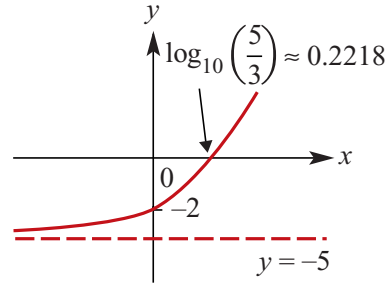

d $f(x) = -2(10^x) + 4$

Asymptote at $y = 4$,
axis intercepts at $(0, 2)$ and $(\log_{10} 2, 0)$

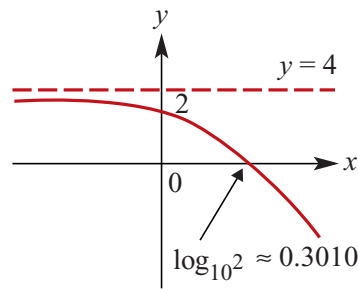

e $f(x) = -3(2^x) + 6$

Asymptote at $y = 6$,
axis intercepts at $(0, 3)$ and $(1, 0)$

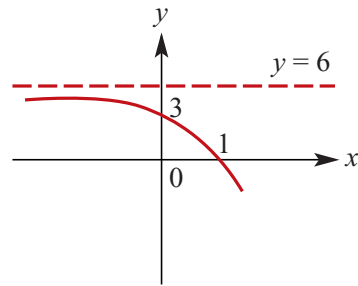

f $f(x) = 5(2^x) - 6$

Asymptote at $y = -6$,
axis intercepts at $(0, -1)$ and $(\log_2 1.2, 0)$

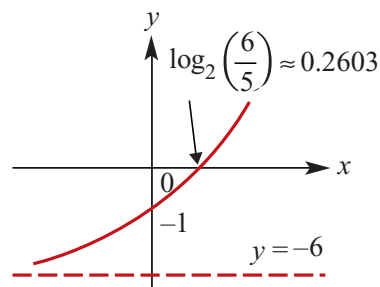

Solutions to Exercise 13G

- 1 a** $y = \log_{10}(2x)$; domain $(0, \infty)$,
range R , x -intercept $(\frac{1}{2}, 0)$

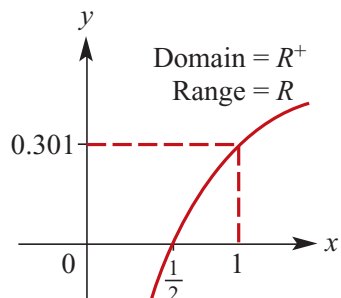

- b** $y = 2 \log_{10} x$; domain $(0, \infty)$,
range R , x -intercept $(1, 0)$

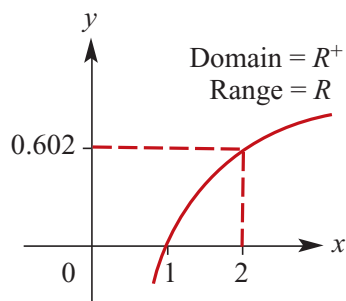

- c** $y = \log_{10}(\frac{x}{2})$; domain $(0, \infty)$ range R ,
 x -intercept $(2, 0)$

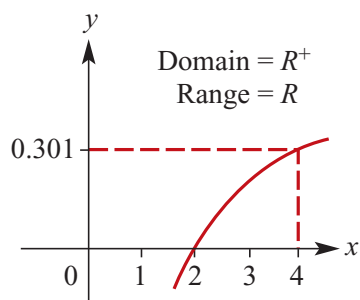

- d** $y = 2 \log_{10}(3x)$; domain $(0, \infty)$,
range R , x -intercept $(\frac{1}{3}, 0)$

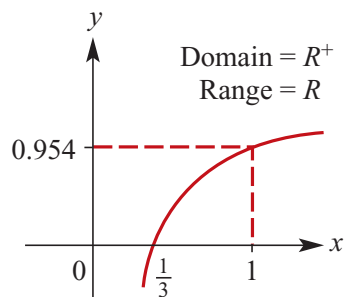

- e** $y = -\log_{10} x$; domain $(0, \infty)$,
range R , x -intercept $(1, 0)$

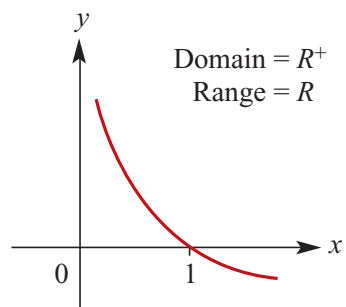

- f** $y = \log_{10}(-x)$ domain $(-\infty, 0)$,
range R , x -intercept $(-1, 0)$

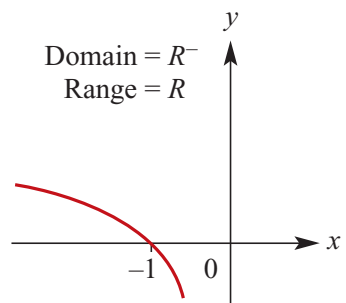

- 2 a** $f(x) = 10^{0.5x}$
 $f^{-1}(x): x = 10^{0.5y}$
 $\log_{10} x = 0.5y$
 $\therefore f^{-1}(x) = 2 \log_{10} x$

- b** $y = 3 \log_{10} x$

$$f^{-1}(x): x = 3 \log_{10} y$$

$$\log_{10} y = \frac{x}{3}$$

$$\therefore f^{-1}(x) = 10^{\frac{x}{3}}$$

c $f(x) = 10^{3x}$

$$f^{-1}(x): x = 10^{3y}$$

$$\log_{10} x = 3y$$

$$\therefore f^{-1}(x) = \frac{1}{3} \log_{10} x$$

d $y = 2 \log_{10} 3x$

$$f^{-1}(x): x = 2 \log_{10} 3y$$

$$\log_{10} 3y = \frac{x}{2}$$

$$3y = 10^{\frac{x}{2}}$$

$$\therefore f^{-1}(x) = \frac{1}{3} 10^{\frac{x}{2}}$$

3 a $f(x) = 3^x + 2$

$$f^{-1}(x): x = 3^y + 2$$

$$3^y = x - 2$$

$$\log_3 3^y = \log_3(x - 2)$$

$$\therefore f^{-1}(x) = \log_3(x - 2)$$

b $f(x) = \log_2(x - 3)$

$$f^{-1}(x): x = \log_2(y - 3)$$

$$2^x = y - 3$$

$$\therefore f^{-1}(x) = 2^x + 3$$

c $f(x) = 4 \times 3^x + 2$

$$f^{-1}x: (x) = 4 \times 3^y + 2$$

$$x - 2 = 4 \times 3^y$$

$$\frac{(x - 2)}{4} = 3^y$$

$$\therefore f^{-1}(x) = \log_3\left(\frac{x - 2}{4}\right)$$

d $f(x) = 5^x - 2$

$$f^{-1}(x): x = 5^y - 2$$

$$5^y = x + 2$$

$$\therefore f^{-1}(x) = \log_5(x + 2)$$

e $f(x) = \log_2(3x)$

$$f^{-1}(x): x = \log_2(3y)$$

$$2^x = 3y$$

$$\therefore f^{-1}(x) = \frac{1}{3}(2^x)$$

f $f(x) = \log_2 \frac{x}{3}$

$$f^{-1}(x): x = \log_2 \frac{y}{3}$$

$$\frac{y}{3} = 2^x$$

$$\therefore f^{-1}(x) = 3(2^x)$$

g $f(x) = \log_2(x + 3)$

$$f^{-1}(x): x = \log_2(y + 3)$$

$$2^x = y + 3$$

$$\therefore f^{-1}(x) = 2^x - 3$$

h $f(x) = 5(3^x) - 2$

$$f^{-1}(x): x = 5(3^y) - 2$$

$$5(3^y) = x + 2$$

$$3^y = \frac{x + 2}{5}$$

$$\therefore f^{-1}(x) = \log_3 \frac{x + 2}{5}$$

$$\therefore f^{-1}(x) = \log_3 \frac{x + 2}{5}$$

4 a $f(x) = \log_2(x - 4)$

Domain $(4, \infty)$, asymptote $x = 4$,

x -intercept at $(5, 0)$

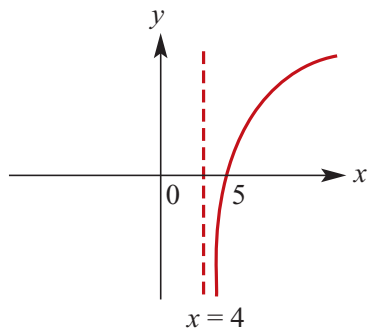

- b** $f(x) = \log_2(x + 3)$
 Domain $(-3, \infty)$, asymptote $x = -3$,
 x -intercept at $(-2, 0)$, y -intercept
 at $(0, \log_2 3)$

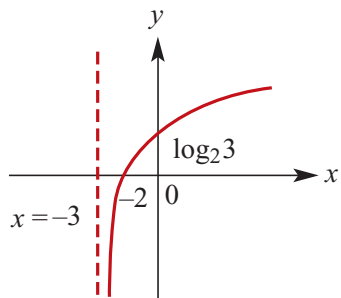

- c** $f(x) = \log_2(2x)$
 Domain $(0, \infty)$, asymptote $x = 0$,
 x -intercept at $(\frac{1}{2}, 0)$

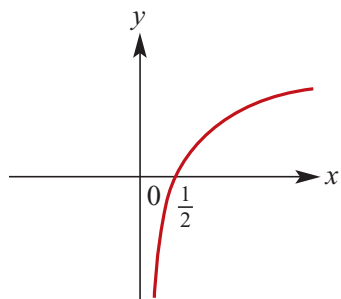

- d** $f(x) = \log_2(x + 2)$
 Domain $(-2, \infty)$, asymptote $x = -2$,
 x -intercept at $(-1, 0)$, y -intercept
 at $(0, 1)$

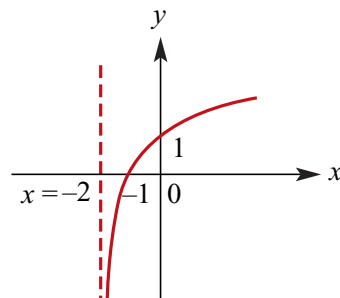

- e** $f(x) = \log_2\left(\frac{x}{3}\right)$
 Domain $(0, \infty)$, asymptote $x = 0$,
 x -intercept at $(3, 0)$

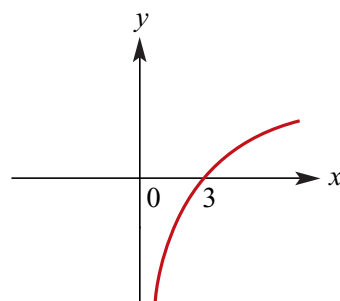

- f** $f(x) = \log_2(-2x)$
 Domain $(-\infty, 0)$, asymptote $x = 0$,
 x -intercept at $(-\frac{1}{2}, 0)$

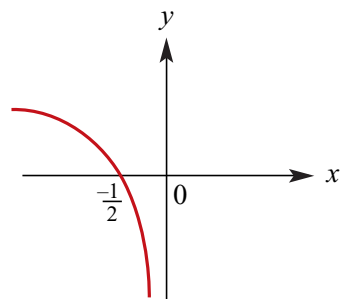

5 a $2^{-x} = x, \therefore x = 0.64$

b $\log_{10}(x) + x = 0, \therefore x = 0.40$

6 $y = \log_{10}(x^2)$;
 $x \in [-10, 10], x \neq 0$

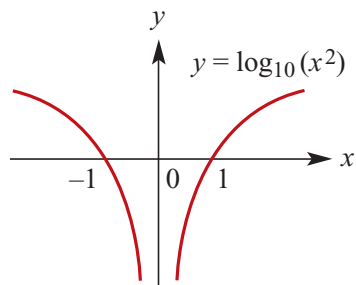

$y = 2 \log_{10} x$;
 $x \in [-10, 10], x \neq 0$

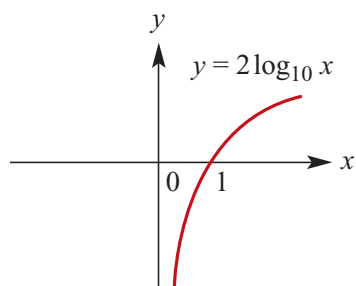

7 $y = \log_{10} \sqrt{x}$;
 $x \in (0, 10], x \neq 0$
 $y = \frac{1}{2} \log_{10} x$;
 $x \in (0, 10], x \neq 0$

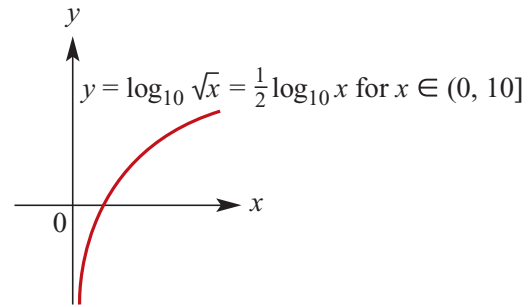

8 $y = \log_{10}(2x) + \log_{10}(3x)$

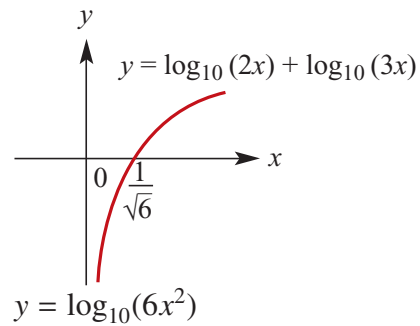

$y = \log_{10}(6x^2)$

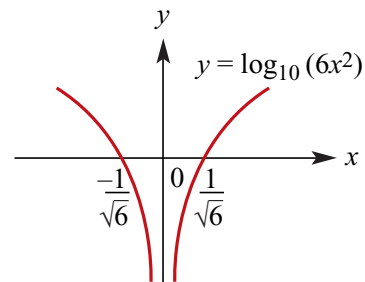

Solutions to Exercise 13H

1 Let N be the number of bacteria at time t minutes.

a $N = 1000 \times 2^{\frac{t}{15}}$

b $10\,000 = 1000 \times 2^{\frac{t}{15}}$

$$10 = 2^{\frac{t}{15}}$$

$$\frac{t}{15} = \log_2 10$$

$$t = 49.8289\dots$$

$$t \approx 50.$$

It will take approximately 50 minutes

2 Choose $A(t) = A_0 \times 10^{-kt}$ as the model where $A_0 = 10$ is the original amount and t is the time in years.

First find k :

$$5 = 10 \times 10^{-24\,000k}$$

$$\log_{10} \frac{1}{2} = -24\,000k$$

$$k = -\frac{1}{24\,000} \log_{10} \frac{1}{2} = 1.254296\dots \times 10^{-5}$$

If $A(t) = 1$

$$1 = 10 \times 10^{-kt}$$

$$0.1 = 10^{-kt}$$

$$\therefore kt = 1$$

$$\therefore t = \frac{1}{1.254296 \times 10^{-5}}$$

$$t \approx 79\,726.$$

It will take 79 726 years for there to be 10% of the original.

3 Choose $A(t) = A_0 \times 10^{-kt}$ as the model where A_0 is the original amount and t is the time in years.

First find k :

$$\frac{1}{2}A_0 = A_0 \times 10^{-5730k}$$

$$\log_{10} \frac{1}{2} = -5730k$$

$$k = -\frac{1}{5730} \log_{10} \frac{1}{2}$$

$$k = 5.2535\dots \times 10^{-5}$$

When $A(t) = 0.4A_0$

$$0.4A_0 = A_0 \times 10^{-kt}$$

$$0.4 = 10^{-kt}$$

$$\therefore kt = \log_{10} 0.4$$

$$\therefore t = \frac{1}{5.2535\dots \times 10^{-5}} \times \log_{10} 0.4$$

$$t \approx 7575$$

It is approximately 7575 years old.

4 $P(h) = 1000 \times 10^{-0.0542h}$

a $P(5) = 1000 \times 10^{-0.0542 \times 5}$
 $= 535.303 \dots$
 $P(h) \approx 535 \text{ millibars}$

b If $P(h) = 400$

Then $400 = 1000 \times 10^{-0.05428h}$

$$\frac{2}{5} = 10^{-0.05428h}$$

$$\log_{10} \left(\frac{2}{5} \right) = -0.05428h$$

$$h \approx 7331 \text{ metres correct to the nearest metre}$$

5 $N(t) = 500\,000(1.1)^t$ where $N(t)$ is the number of bacteria at time t

$$4\,000\,000 = 500\,000(1.1)^t$$

$$8 = 1.1^t$$

$$t = 21.817 \dots$$

The number will exceed 4 million bacteria after 22 hours.

6 $T = T_0 10^{-kt}$

When $t = 0$, $T = 100$. Therefore $T_0 = 100$

We have $T = 100 \times 10^{-kt}$

When $t = 5, T = 40$

$$\therefore 40 = 100 \times 10^{-5k}$$

$$\frac{2}{5} = 10^{-5k}$$

$$k = -\frac{1}{5} \log_{10} \frac{2}{5}$$

$$k = 0.07958 \dots$$

When $t = 15$

$$T = 100 \times 10^{-15k} = 6.4$$

The temperature is 6.4°C after 15 minutes.

7 $A(t) = 0.9174^t$

When $A(t) = 0.2$

$$0.2 = 0.9174^t$$

$$t = 18.668 \dots$$

$$t > 18.668 \dots$$

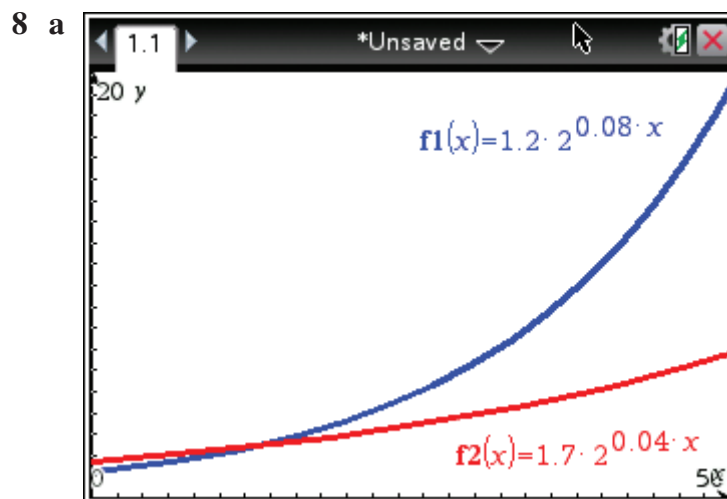

b i

$$p = q$$

\Leftrightarrow

$$2^{0.04t} = \frac{17}{12}$$

$$\therefore t = 12.56 \quad (\text{mid 1962})$$

ii Solve the equation $p = 2q$

$$\text{i.e. } 1.2 \times 2^{0.08t} = 2(1.7 \times 2^{0.04t})$$

$$\frac{6}{17} \times 2^{0.04t} = 1$$

$$2^{0.04t} = \frac{17}{6}$$

$$t = 37.56 \quad (\text{mid 1987})$$

9 a We can write

$$a \times b^1 = 15 \quad (1)$$

$$a \times b^4 = 1875 \quad (2)$$

Dividing equation (2) by equation (1) gives $b^3 = 125$. Thus $b = 5$, and substituting into equation (1) gives $a = 3$.

$$\therefore y = 3 \times 5^x$$

b We can write

$$a \times b^2 = 1 \quad (1)$$

$$a \times b^5 = \frac{1}{8} \quad (2)$$

Dividing equation (2) by equation (1) gives $b^3 = \frac{1}{8}$. Thus $b = \frac{1}{2}$, and substituting into equation (1) gives $a = 4$.

$$\therefore y = 4 \times \left(\frac{1}{2}\right)^x$$

c We can write

$$a \times b^1 = \frac{15}{2} \quad (1)$$

$$a \times b^{\frac{1}{2}} = \frac{5\sqrt{6}}{2} \quad (2)$$

Dividing equation (2) by equation (1) gives $b^{-\frac{1}{2}} = \frac{\sqrt{6}}{3}$. Thus $b = \frac{3}{2}$, and substituting into equation (1) gives $a = 5$.

$$y = 5 \times \left(\frac{3}{2}\right)^x$$

10 $S = 5 \times 10^{-kt}$

a $S = 3.2$ when $t = 2$

$$3.2 = 5 \times 10^{-2k}$$

$$0.64 = 10^{-2k}$$

$$k = -\frac{1}{2} \log_{10} 0.64$$

$$= 0.0969 \dots$$

b When $S = 1$

$$1 = 5 \times 10^{-0.0969 \dots t}$$

$$10^{(-0.0969 \dots)t} = 0.2$$

$$(-0.0969 \dots)t = \log_{10} 0.2$$

$$t = 7.212 \dots$$

There will be 1 kg of sugar remaining after approximately 7.21 hours

11 a When $t = 0, N = 1000$

$$N = ab^t$$

$$1000 = ab^0$$

$$a = 1000$$

When $t = 5, N = 10\,000$

$$\therefore 10 = b^5$$

$$\therefore b = 10^{\frac{1}{5}}$$

$$\therefore N = 1000 \times 10^{\frac{t}{5}}$$

b When $N = 5000$

$$5 = 10^{\frac{t}{5}}$$

$$\frac{t}{5} = \log_{10} 5$$

$$t = 5 \log_{10} 5$$

$$\approx 3.4948 \text{ hours}$$

$$= 210 \text{ minutes}$$

c When $N = 1\,000\,000$

$$\begin{aligned}1000 &= 10^{\frac{t}{5}} \\ \frac{t}{5} &= \log_{10} 1000 \\ t &= 5 \times 3 \\ &= 15 \text{ hours}\end{aligned}$$

d $N(12) = 1000 \times 10^{\frac{12}{5}} \approx 251188.64$

12 We can write

$$a \times 10^{2k} = 6 \quad (1)$$

$$a \times 10^{5k} = 20 \quad (2)$$

Dividing equation (2) by equation (1) gives $10^{3k} = \frac{10}{3}$. Thus $k = \frac{1}{3} \log_{10} \frac{10}{3}$, and substituting into equation (1) gives $a = 6 \times \left(\frac{10}{3}\right)^{-\frac{2}{3}}$.

13 Use two points, say (0, 1.5) and (10, 0.006) to find $y = ab^x$.

at (0, 1.5) $1.5 = a \times b^0$

$\therefore 1.5 = a$

$\therefore y = 1.5b^x$

at (10, 0.006) $0.006 = 1.5b^{10}$

$\therefore b^{10} = \frac{0.006}{1.5}$
 $= 0.004$

$\therefore b = (0.004)^{\frac{1}{10}} \approx 0.5757$

$\therefore y = 1.5 \times 0.58^x$

If CAS is used with exponential regression, $a = 1.5$ and $b = 0.575$, so $y = 1.5(0.575)^x$

14 Use two points, say (0, 2.5) and (8, 27.56) to find $p = ab^t$.

$$\text{at } (0, 2.5) \quad 2.5 = a \times b^0$$

$$\therefore 2.5 = a$$

$$\therefore p = 2.5b^t$$

$$\text{at } (8, 27.56) \quad 27.56 = 2.5b^8$$

$$\therefore b^8 = \frac{27.56}{2.5}$$

$$= 11.024$$

$$\therefore b = (11.024)^{\frac{1}{8}}$$

$$\approx 1.3499$$

$$\therefore p = 2.5 \times 1.35^t$$

If CAS is used with exponential regression, $a = 1.5$ and $b = 0.575$, so $y = 1.5(0.575)^x$

15 a

Cuts, n	Sheets	Total thickness, T (mm)
0	1	0.2
1	2	0.4
2	4	0.8
3	8	1.6
4	16	3.2
5	32	6.4
6	64	12.8
7	128	25.6
8	256	51.2
9	512	102.4
10	1024	204.8

b $T = 0.2 \times 2^n$

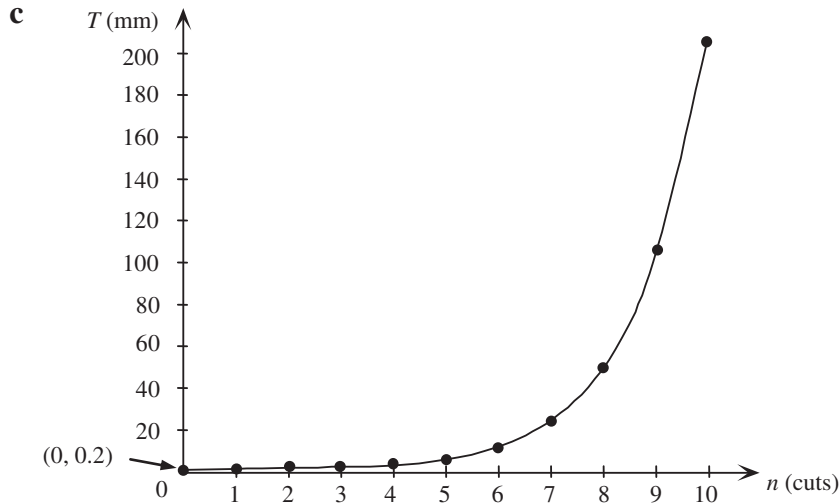

d When $n = 30$, $T = 0.2 \times 2^{30}$
 $= 214\,748\,364.8$
 Total thickness is $214\,748\,364.8 \text{ mm} = 214\,748.4 \text{ m}$

16 $d = d_0(10^{mt})$

$d(1) = 52; d(3) = 80$

$\therefore d_0(10^m) = 52; d_0(10^{3m}) = 80$

Take \log_{10} both equations:

(1): $\log_{10} d_0 + m \log_{10} 10 = \log_{10} 52$

$\therefore \log_{10} d_0 + m = \log_{10} 52$

(2): $\log_{10} d_0 + 3m \log_{10} 10 = \log_{10} 80$

$\therefore \log_{10} d_0 + 3m = \log_{10} 80$

(2)–(1) gives

$2m = \log_{10} \left(\frac{80}{52} \right)$

$\therefore m = \frac{1}{2} \log_{10} \left(\frac{20}{13} \right) = 0.0935$

Substitute into **(1)**:

$\log_{10} d_0 = \log_{10} 52 - 0.0935$
 $= \log_{10} 52 - \log_{10}(10^{0.0935})$
 $= \log_{10} \left(\frac{52}{1.240} \right) = \log_{10} 41.88$

$\therefore d_0 = 41.88 \text{ cm}$

$\therefore d_0 = 41.88 \text{ cm}$

Solutions to Exercise 13I

1 a $m = 2$ and $c = \log_4 3$

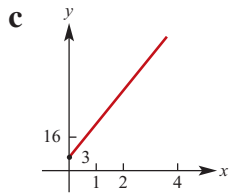
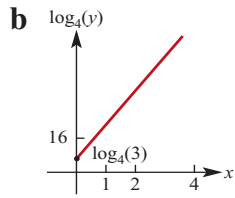

2 a $m = 3$ and $c = \log_5 2$

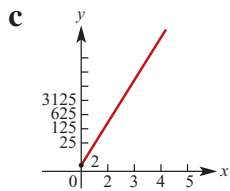
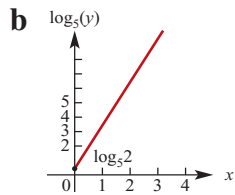

3 Street 10^{-9} watt/cm²; Quiet car 10^{-11} watt/cm²

4 a Increases by $10 \log_{10} 2 \approx 3$ dB

b Increases by $10 \log_{10} 10 = 10$ dB

c $P_{\text{new}} = (P_{\text{old}})^3 \times 10^{32}$

d $P = 10^{-16}$

e $P = 10^{-6}$

5 $P_1 = 10^{\frac{\lambda}{10}} \times P_2$

6 $5 + \log_{10} 5$

7 $7.3 - \log_{10} 4$

8 $[10^{-4}, 10^{-2}]$

Solutions to Technology-free questions

$$1 \text{ a } \frac{a^6}{a^2} = a^{6-2} = a^4$$

$$b \frac{b^8}{b^{10}} = b^{8-10} \\ = b^{-2} = \frac{1}{b^2}$$

$$c \frac{m^3 n^4}{m^5 n^6} = m^{3-5} n^{4-6} \\ = m^{-2} n^{-2} = \frac{1}{m^2 n^2}$$

$$d \frac{a^3 b^2 4}{ab^2} = \frac{a^3 b^2}{a^4 b^8} \\ = a^{3-4} b^{2-8} = \frac{1}{ab^6}$$

$$e \frac{6a^8}{4a^2} = \left(\frac{6}{4}\right)a^{8-2} = \frac{3a^6}{2}$$

$$f \frac{10a^7}{6a^9} = \left(\frac{10}{6}\right)a^{7-9} = \frac{5}{3a^2}$$

$$g \frac{8(a^3)^2}{2a^3} = \frac{8a^6}{8a^3} \\ = a^{6-3} = a^3$$

$$h \frac{m^{-1}n^2}{(mn^{-2})^3} = \frac{m^{-1}n^2}{m^3n^{-6}} \\ = m^{-1-3}n^{2+6} = \frac{n^8}{m^4}$$

$$i (p^{-1}q(-2))^2 = p^{-2}q^{-4} = \frac{1}{p^2q^4}$$

$$j \frac{(2a^{-4})^3}{5a^{-1}} = \frac{8a^{-12}}{5a^{-1}} \\ = \frac{8a^{1-12}}{5} = \frac{8}{5a^{11}}$$

$$k \frac{6a^{-1}}{3a^{-2}} = \left(\frac{6}{3}\right)a^{-1+2} = 2a$$

$$l \frac{a^4 + a^8}{a^2} = \frac{a^4}{a^2}(1 + a^4) \\ = a^2(1 + a^4) = a^2 + a^6$$

$$2 \text{ a } 2^x = 7, \therefore x = \log_2 7$$

$$b \ 2^{2x} = 7, 2x = \log_2 7 \\ \therefore x = \frac{1}{2} \log_2 7$$

$$c \ 10^x = 2, \therefore x = \log_{10} 2$$

$$d \ 10^x = 3.6, \therefore x = \log_{10} 3.6$$

$$e \ 10^x = 110, \therefore x = \log_{10} 110 \\ \text{(or } 1 + \log_{10} 11)$$

$$f \ 10^x = 1010, \therefore x = \log_{10} 1010 \\ \text{(or } 1 + \log_{10} 101)$$

$$g \ 2^{5x} = 100, \therefore 5x = \log_2 100 \\ \therefore x = \frac{1}{5} \log_2 100$$

$$h \ 2^x = 0.1, \therefore x = \log_2 0.1 \\ = -\log_2 10$$

$$3 \text{ a } \log_2 64 = \log_2 2^6 \\ = 6 \log_2 2 = 6$$

$$b \ \log_{10} 10^7 = 7 \log_{10} 10 = 7$$

$$c \ \log_a a^2 = 2 \log_a a = 2$$

$$d \ \log_4 1 = 0 \text{ by definition}$$

$$e \ \log_3 27 = \log_3 3^3 \\ = 3 \log_3 3 = 3$$

$$\begin{aligned} \mathbf{f} \quad \log_2 \frac{1}{4} &= \log_2 2^{-2} \\ &= -2 \log_2 2 = -2 \end{aligned}$$

$$\begin{aligned} \mathbf{g} \quad \log_{10} 0.001 &= \log_{10} 10^{-3} \\ &= -3 \log_{10} 10 = -3 \end{aligned}$$

$$\begin{aligned} \mathbf{h} \quad \log_2 16 &= \log_2 2^4 \\ &= 4 \log_2 2 = 4 \end{aligned}$$

$$\mathbf{4} \quad \mathbf{a} \quad \log_{10} 2 + \log_{10} 3 = \log_{10}(2 \times 3) = \log_{10} 6$$

$$\begin{aligned} \mathbf{b} \quad \log_{10} 4 + 2 \log_{10} 3 - \log_{10} 6 \\ &= \log_{10} 4 + \log_{10}(3^2) - \log_{10} 6 \\ &= \log_{10} \frac{4(3^2)}{6} = \log_{10} 6 \end{aligned}$$

$$\begin{aligned} \mathbf{c} \quad 2 \log_{10} a - \log_{10} b &= \log_{10} a^2 - \log_{10} b \\ &= \log_{10} \left(\frac{a^2}{b} \right) \end{aligned}$$

$$\begin{aligned} \mathbf{d} \quad 2 \log_{10} a - 3 - \log_{10} 25 \\ &= \log_{10} a^2 - \log_{10} 25 - \log_{10} 10^3 \\ &= \log_{10} \left(\frac{a^2}{25000} \right) \end{aligned}$$

$$\mathbf{e} \quad \log_{10} x + \log_{10} y - \log_{10} x = \log_{10} y$$

$$\begin{aligned} \mathbf{f} \quad 2 \log_{10} a + 3 \log_{10} b - \log_{10} c \\ &= \log_{10} a^2 + \log_{10} b^3 - \log_{10} c \\ &= \log_{10} \left(\frac{a^2 b^3}{c} \right) \end{aligned}$$

$$\begin{aligned} \mathbf{5} \quad \mathbf{a} \quad 3^x(3^x - 27) &= 0 \\ 3^x &= 27, \therefore x = 3 \\ (3^x \neq 0 \text{ for any real } x) \end{aligned}$$

$$\begin{aligned} \mathbf{b} \quad (2^x - 8)(2^x - 1) &= 0 \\ 2^x &= 1, 8, \therefore x = 0, 3 \end{aligned}$$

$$\begin{aligned} \mathbf{c} \quad 2^{2x} - 2^{x+1} &= 0 \\ (2^x)(2^x - 2) &= 0 \\ 2^x &= 2, \therefore x = 1 \\ (2^x \neq 0 \text{ for any real } x) \end{aligned}$$

$$\begin{aligned} \mathbf{d} \quad 2^{2x} - 12(2^x) + 32 &= 0 \\ (2^x - 8)(2^x - 4) &= 0 \\ 2^x &= 4, 8, \therefore x = 2, 3 \end{aligned}$$

$$\mathbf{6} \quad \mathbf{a} \quad y = 2 \times 2^x$$

Asymptote at $y = 0$, y -intercept at $(0, 1)$

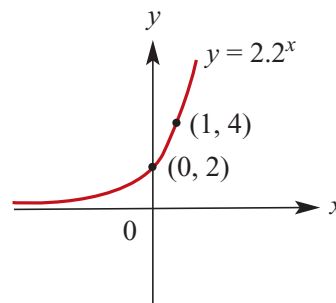

$$\mathbf{b} \quad y = -3 \times 2^x$$

Asymptote at $y = 0$, y -intercept at $(0, -3)$

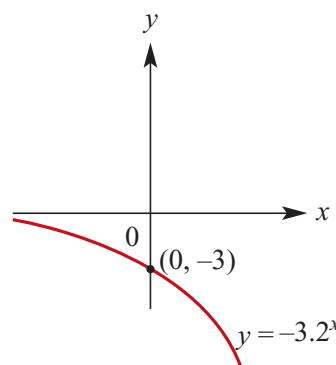

$$\mathbf{c} \quad y = 5 \times 2^{-x}$$

Asymptote at $y = 0$, y -intercept at $(0, 1)$

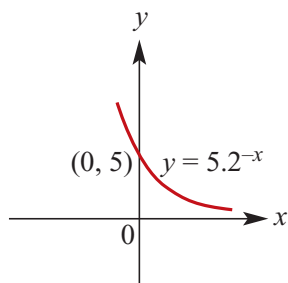

- d** $y = 2^{-x} + 1$
Asymptote at $y = 1$, y-intercept at $(0, 2)$

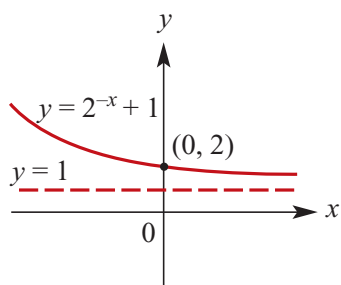

- e** $y = 2^x - 1$
Asymptote at $y = -1$, y-intercept at $(0, 0)$

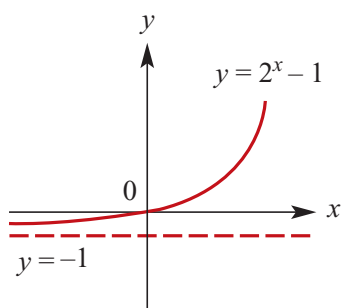

- f** $y = 2^x + 2$
Asymptote at $y = 2$, y-intercept at $(0, 3)$

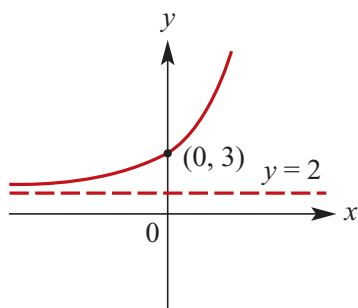

7

$$\log_{10} x + \log_{10} 2x - \log_{10}(x + 1) = 0$$

$$\begin{aligned} \therefore \log_{10} \frac{2x^2}{x+1} &= 0 \\ \frac{2x^2}{x+1} &= 1 \\ 2x^2 &= x + 1 \\ 2x^2 - x - 1 &= 0 \\ (2x + 1)(x - 1) &= 0 \end{aligned}$$

$$\begin{aligned} \therefore x &= -\frac{1}{2}, 1 \\ \text{Since } \log x &\text{ is not defined for } \\ x \leq 0, x &= 1 \end{aligned}$$

8 $3^x = 4^y = 12^z$

$$\therefore z(\log 12) = x \log 3$$

$$x = \frac{z \log 12}{\log 3}$$

$$y = \frac{z \log 12}{\log 4}$$

$$\frac{xy}{x+y} = \frac{(z \log 12)^2}{(\log 3)(\log 4)} \div \left(\frac{z \log 12}{\log 3} + \frac{z \log 12}{\log 4} \right)$$

$$= \frac{z \log 12}{(\log 3)(\log 4)} \div \left(\frac{1}{\log 3} + \frac{1}{\log 4} \right)$$

$$= \frac{z \log 12}{(\log 3)(\log 4)} \div \frac{\log 4 + \log 3}{(\log 3)(\log 4)}$$

$$= (z \log 12) \div (\log 12) = z$$

$$\therefore z = \frac{xy}{x+y}$$

9 $2 \log_2 12 + 3 \log_2 5 - \log_2 15 - \log_2 150$

$$= \log_2 \frac{(12^2)(5^3)}{(15)(150)}$$

$$= \log_2 \left(\frac{18000}{2250} \right)$$

$$= \log_2 8 = 3$$

10 **a** $\log_p 7 + \log_p k = 0, \therefore \log_p 7k = 0$

$$\therefore 7k = 1, \therefore k = \frac{1}{7}$$

$$\mathbf{b} \quad 4 \log_q 3 + 2 \log_q 2 - \log_q 144 = 2$$

$$\therefore \log_q \frac{(3^4)(2^2)}{144} = 2$$

$$\log_q \left(\frac{9}{4} \right) = 2$$

$$\frac{9}{4} = q^2, \therefore q = \frac{3}{2}$$

(all log bases > 0)

$$\mathbf{11 a} \quad 2(4^{a+1}) = 16^{2a}$$

$$\therefore 4^{\frac{1}{2}}(4^{a+1}) = 4^{4a}$$

$$4^{a+\frac{3}{2}} = 4^{4a}$$

$$a + \frac{3}{2} = 4a$$

$$3a = \frac{3}{2}, \therefore a = \frac{1}{2}$$

$$\mathbf{b} \quad \log_2 y^2 = 4 + \log_2(y + 5)$$

$$\therefore \log_2 y^2 - \log_2(y + 5) = 4$$

$$\log_2 \left(\frac{y^2}{y + 5} \right) = 4$$

$$\frac{y^2}{y + 5} = 2^4$$

$$y^2 = 16y + 80$$

$$y^2 - 16y - 80 = 0$$

$$(y - 20)(y + 4) = 0$$

$$\therefore y = -4, 20$$

(Both solutions must be included here, because the only domain restriction is that $y > -5$)

Solutions to multiple-choice questions

$$1 \text{ C } \frac{8x^3}{4x^{-3}} = \frac{8}{4}x^{3+3} = 2x^6$$

$$2 \text{ A } \frac{a^2b}{(2ab^2)^3} \div \frac{ab}{16a^0} = \frac{a^2b}{8a^3b^6} \frac{16}{ab}$$

$$= \frac{16}{8}a^{2-3-1}b^{1-6-1}$$

$$= 2a^{-2}b^{-6}$$

$$= \frac{2}{a^2b^6}$$

3 C The range of $y = 3 \times 2^x$ is $(0, \infty)$ but $f(x) = 3(2^x) - 1$ is translated 1 unit down
 \therefore range = $(-1, \infty)$

$$4 \text{ C } f(x) = \log_2 3x$$

$$f^{-1}(x): x = \log_2(3y)$$

$$2^x = 3y$$

$$\therefore f^{-1}(x) = \frac{1}{3}2^x$$

$$5 \text{ A } \log_{10}(x-2) - 3 \log_{10} 2x = 1 - \log_{10} y$$

$$\therefore \log_{10} \frac{x-2}{(2x)^3} + \log_{10} y = 1$$

$$\log_{10} \frac{y(x-2)}{8x^3} = 1$$

$$\frac{y(x-2)}{8x^3} = 10$$

$$\therefore y = \frac{80x^3}{x-2}$$

$$6 \text{ B } 5(2^{5x}) = 10, \therefore 2^{5x} = 2^1$$

$$\therefore 5x = 1, \therefore x = \frac{1}{5}$$

7 A The vertical asymptote of $y = \log x$ is at $x = 0$. Here $5x = 0$ so $x = 0$.
 (y-direction translations don't affect the vertical asymptote.)

8 A $f(x) = 2^{ax} + b$; $a, b > 0$
 Function must be increasing, with a horizontal asymptote at $y = b$ which the graph approaches at large negative values of x , and there will be no x -intercept because $b > 0$

9 A Vertical asymptote, hence log or hyperbola. But B and C both have a vertical asymptote $x = -b$.

$$10 \text{ A } \frac{2mh}{(3mh^2)^3} \div \frac{mh}{81m^2} = \frac{2mh}{27m^3h^6} \frac{81m^2}{mh}$$

$$= 6m^{1+2-3-1}h^{1-6-1}$$

$$= 6m^{-1}h^{-6}$$

$$= \frac{6}{mh^6}$$

Solutions to extended-response questions

1 a

Number of discs, n	0	1	2	3	4
Minimum no. of moves, M	0	1	3	7	15

For two discs, the following procedure may be used.

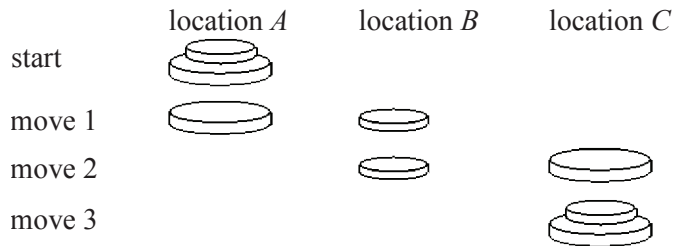

For three discs, the procedure is as follows.

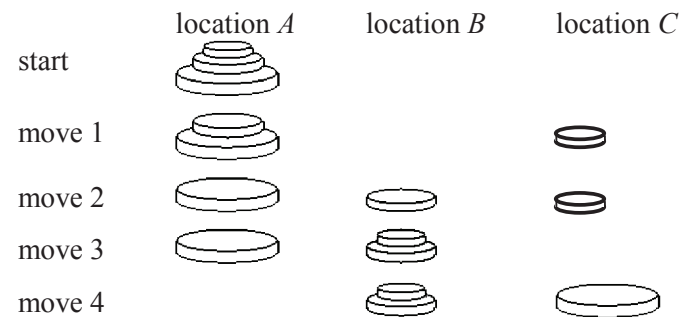

Now the problem reduces to taking the two discs from B to C , i.e. three more moves (using the technique for two discs).

$$\begin{aligned} \therefore \text{total number of moves} &= 3 + 4 \\ &= 7 \end{aligned}$$

This procedure can be generalised for n discs.

- The top $n - 1$ discs can be moved from A to B in $2^{n-1} - 1$ moves.
- The remaining bottom disc can be moved from A to C .
- The $n - 1$ discs on B can be moved to C in $2^{n-1} - 1$ moves.

$$\begin{aligned} \therefore \text{total number of moves} &= 2^{n-1} - 1 + 1 + 2^{n-1} - 1 \\ &= 2 \times 2^{n-1} - 1 \\ &= 2^n - 1 \end{aligned}$$

b $M = 2^n - 1$

Number of discs, n	0	5	6	7
Minimum no. of moves, M	0	31	63	127

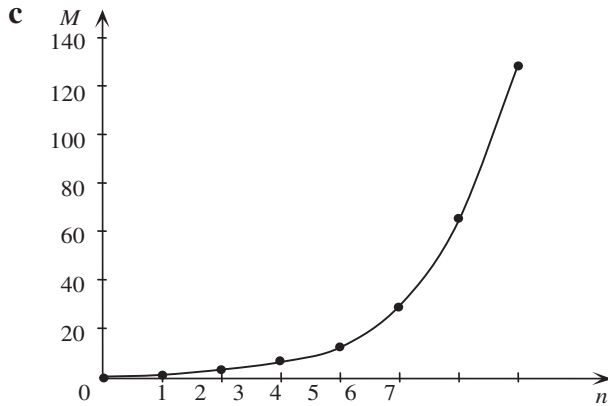

- d** Let the top disc be called D_1 , the next D_2 , then D_3 and so on to n th disc, D_n .
 For 3 discs, D_1 moves 4 times, D_2 2 times and D_3 once.
 For 4 discs, D_1 moves 8 times, D_2 4 times, D_3 2 times and D_4 once.
 For n discs, D_1 moves 2^{n-1} times, D_2 2^{n-2} times, \dots , D_n 2^0 times.

Three discs	D_1	D_2	D_3
Times moved	4	2	1

Four discs	D_1	D_2	D_3	D_4
Times moved	8	4	2	1

n discs	D_1	D_2	D_3	\dots	D_{n-1}	D_n
Times moved	2^{n-1}	2^{n-2}	2^{n-3}		2^1	2^0

Note: For n discs, total number of moves = $1 + 2 + 4 + \dots + 2^{n-1}$

$$= \frac{1(2^n - 1)}{2 - 1} = 2^n - 1$$

2 $2187 = 9 \times 9 \times 9 \times 3 = 9^3 \times 3^1$

This gives 3 switches of Type 1 and 1 switch of Type 2.

However, if n of Type 1 and $n + 1$ of Type 2 are used, there needs to be one more 3 than the number of 9s in the factorisation.

$$2187 = 9 \times 9 \times 3 \times 3 \times 3 = 9^2 \times 3^3$$

Two switches of Type 1 and three of Type 2 are needed. Hence, $n = 2$.

3 a $\left(\frac{1}{8}\right)^n = \left(\left(\frac{1}{2}\right)^3\right)^n = \left(\frac{1}{2}\right)^{3n}$

b $\left(\frac{1}{4}\right)^{n-1} \left(\frac{1}{2}\right)^{3n} = \left(\left(\frac{1}{2}\right)^2\right)^{n-1} \left(\frac{1}{2}\right)^{3n}$
 $= \left(\frac{1}{2}\right)^{2(n-1)} \left(\frac{1}{2}\right)^{3n}$
 $= \left(\frac{1}{2}\right)^{2n-2} \left(\frac{1}{2}\right)^{3n} = \left(\frac{1}{2}\right)^{5n-2}$

c $\left(\frac{1}{2}\right)^{n-3} \left(\frac{1}{2}\right)^{5n-2} = \left(\frac{1}{2}\right)^{6n-5}$

Now, $\left(\frac{1}{2}\right)^{6n-5} = \frac{1}{8192} = \frac{1}{2^{13}} = \left(\frac{1}{2}\right)^{13}$

$\therefore 6n - 5 = 13$

$\therefore 6n = 18 \therefore n = 3$

4 a

Times used	1	2	3	n
Caffeine remaining	$729\left(\frac{1}{4}\right)^1$	$729\left(\frac{1}{4}\right)^2$	$729\left(\frac{1}{4}\right)^3$	$729\left(\frac{1}{4}\right)^n$

b

Times used	1	2	3	n
Tannin remaining	$128\left(\frac{1}{2}\right)^1$	$128\left(\frac{1}{2}\right)^2$	$128\left(\frac{1}{2}\right)^3$	$128\left(\frac{1}{2}\right)^n$

c Can be re-used if amount of tannin $\leq 3 \times$ amount of caffeine.

i.e. $128\left(\frac{1}{2}\right)^n \leq 3 \times 729\left(\frac{1}{4}\right)^n$

$\Leftrightarrow 128\left(\frac{1}{2}\right)^n \leq 2187\left(\frac{1}{2}\right)^{2n}$

$\Leftrightarrow \frac{128}{2187} \leq \frac{\left(\frac{1}{2}\right)^{2n}}{\left(\frac{1}{2}\right)^n}$

$\Leftrightarrow \frac{128}{2187} \leq \left(\frac{1}{2}\right)^n$

$\Leftrightarrow \log_{10}\left(\frac{128}{2187}\right) \leq \log_{10}\left(\frac{1}{2}\right)^n$

$\Leftrightarrow \log_{10}\left(\frac{128}{2187}\right) \leq n \log_{10}\left(\frac{1}{2}\right)$

$\Leftrightarrow \frac{\log_{10}\left(\frac{128}{2187}\right)}{\log_{10}\left(\frac{1}{2}\right)} \geq n$ as $\log_{10}\left(\frac{1}{2}\right) < 0$

$\therefore n \leq 4.09$

Hence, the tea leaves can be re-used 4 times.

5 a Brightness Batch 1 after n years = $15(0.95)^n$
 Brightness of Batch 2 after n years = $20(0.94)^n$

b Let n be the number of years until brightness is the same.

$$15(0.95)^{n+1} = 20(0.94)^n$$

$$\frac{(0.95)^{n+1}}{(0.94)^n} = \frac{20}{15}$$

$$\log_{10}\left(\frac{(0.95)^{n+1}}{(0.94)^n}\right) = \log_{10}\left(\frac{4}{3}\right)$$

$$\therefore \log_{10}(0.95)^{n+1} - \log_{10}(0.94)^n = \log_{10}\left(\frac{4}{3}\right)$$

$$(n+1)\log_{10}(0.95) - n\log_{10}(0.94) = \log_{10}\left(\frac{4}{3}\right)$$

$$n\log_{10}(0.95) + \log_{10}(0.95) - n\log_{10}(0.94) = \log_{10}\left(\frac{4}{3}\right)$$

$$n(\log_{10}(0.95) - \log_{10}(0.94)) = \log_{10}\left(\frac{4}{3}\right) - \log_{10}(0.95)$$

$$n\log_{10}\left(\frac{0.95}{0.94}\right) = \log_{10}\left(\frac{4}{3 \times 0.95}\right)$$

$$n = \frac{\log_{10}\left(\frac{400}{285}\right)}{\log_{10}\left(\frac{95}{94}\right)}$$

$$= 32.033$$

Hence, the brightness is the same early in the 33rd year (i.e. after about 32 years).

6 $x = 0.8 + 0.17t$, $y = 10^{0.03t}$, $z = 1.7 \log_{10}(5(x+1))$

a For X: $t = 6$ implies

$$x = 1.82$$

i.e. the value is \$ 1.82

For Y: $t = 6$ implies

$$y = 1.51$$

i.e. the value is \$ 1.51

For Z: $t = 6$ implies

$$z = 2.62$$

i.e. the value is \$ 2.62

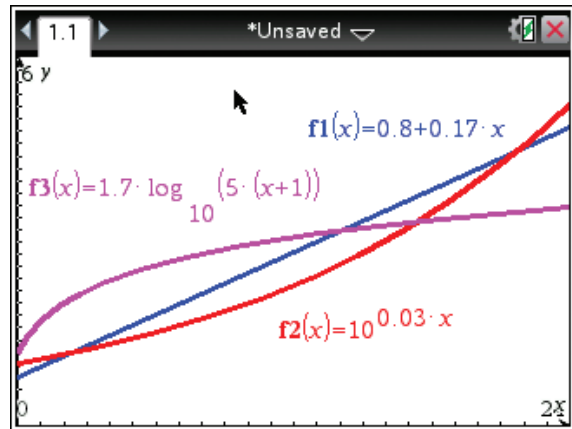

- b** For X: $t = 21$ implies $x = 4.37$ i.e. the value is \$ 4.37
 For Y: $t = 21$ implies $y = 4.27$ i.e. the value is \$ 4.27
 For Z: $t = 21$ implies $z = 3.47$ i.e. the value is \$ 3.47
- c** The graphs of $x(t)$ and $y(t)$ intersect where $t = 2.09$ and $t = 21.78$.
 From the graph, the shares of X have greater value than the shares of Y for $2.09 < t < 21.78$, i.e. from February 2014 to September 2015.
- d** The graphs of $x(t)$ and $z(t)$ intersect at $t = 14.06$.
 From the graphs, it can be seen that shares in X are most valuable for $14.06 < t < 21.78$.
 Therefore X were the most valuable shares for 7.72 months, or about 8 months, i.e. from February 1998 to September 2015.

7 Let W be the number of wildebeest and n the number of years.

Then $W = 700(1.03)^n$

Let Z be the number of zebras.

Then $Z = (0.96)^n \times 1850$
 $= 1850(0.96)^n$

a $(0.96)^n \times 1850 = 700(1.03)^n$

$$\frac{1850}{700} = \left(\frac{1.03}{0.96}\right)^n$$

$$\frac{37}{14} = \left(\frac{103}{96}\right)^n$$

$\therefore n = 13.81$

After 13.81 years, the number of wildebeest exceeds the number of zebras.

b Let A be the number of antelopes.

$$A = 1000 + 50n$$

The number of antelopes is greater than the number of zebras when

$$1000 + 50n > 1850(0.96)^n$$

From a CAS calculator,

$$1000 + 50n > 1850(0.96)^n \text{ for } n > 7.38$$

After 7.38 years, the number of antelopes exceeds the number of zebras.

8 a TI: Type the given data into a new Lists & Spreadsheet application. Call column A *time*, and column B *temp*

Press **Menu** → **4:Statistics** → **1:Stat Calculations** → **A:Exponential Regression**

Set **X List** to **time** and **Y List** to **temp** then ENTER

A	B	C	D
1	3	71.5	Title
2	6	59	RegEqn
3	9	49	a
4	12	45.5	b
5	15	34	r ²
6	18	28	r

CP: Open the Statistics application. Type the time data into list1 and the temperature data into list2

Tap **Calc** → **abExponential Reg** and set **XList** to **list1** and **YList** to **list2**

The values of a and b are given as $a = 87.06$ and $b = 0.94$, correct to 2 decimal places,

$$\therefore T = 87.06 \times 0.94^t$$

b i When $t = 0$, $T = 87.06^\circ\text{C}$

ii When $t = 25$, $T = 18.56^\circ\text{C}$

c (12, 45.5) is the reading which appears to be incorrect.

Re-calculating gives $a = 85.724\dots$ and $b = 0.9400$

$$\therefore T = 85.72 \times 0.94^t$$

d i When $t = 0$, $T = 85.72^\circ\text{C}$

ii When $t = 12$, $T = 40.82^\circ\text{C}$

e When $T = 15$, $t = 28.19$ min

9 a At (1, 1) $1 = a \times b^1$
 $\therefore 1 = ab$ (1)

At (2, 5) $5 = a \times b^2$ (2)

Divide (2) by (1) $5 = b$

Substitute $b = 5$ into (1) $1 = a \times 5$

$\therefore a = \frac{1}{5} = 0.2$

$\therefore a = 0.2, b = 5$

b Let $b^x = 10^z$

i By the definition of logarithm:

$$\begin{aligned} z &= \log_{10} b^x \\ \therefore &= x \log_{10} b \end{aligned}$$

ii $y = a \times 10^{kx}$
 $= a \times b^x$ where $b^x = 10^{kx}$

From **b i**, $b^x = 10^{kx}$ can be rewritten

$$\begin{aligned} kx &= x \log_{10} b \\ \therefore k &= \log_{10} b \\ \text{From a, } a &= 0.2 \text{ and } b = 5, \therefore k = \log_{10} 5 \end{aligned}$$

10 a Use two points, say (0, 2) and (10, 200) to find $y = ab^x$.

At (0, 2) $2 = a \times b^0$

$\therefore 2 = a$

$\therefore y = 2b^x$

At (10, 200) $200 = 2b^{10}$

$\therefore b^{10} = \frac{200}{2} = 100$

$\therefore b = (100)^{\frac{1}{10}}$
 $= 1.5849$ (correct to 4 decimal places)

$\therefore y = 2 \times 1.5849^x$

Using CAS regression $y = 2 \times 1.585^x$

b From Question 9, $k = \log_{10} b$
 and from part **a**, $a = 2$ and $b = (100)^{\frac{1}{10}}$
 $\therefore k = \log_{10}(100)^{\frac{1}{10}}$
 $= \frac{1}{10} \log_{10} 100$
 $= \frac{1}{10} \times 2 = \frac{1}{5}$
 $\therefore y = 2 \times 10^{\frac{x}{5}} = 2 \times 10^{0.2x}$

c $y = 2 \times 10^{\frac{x}{5}}$
 can be written $\frac{y}{2} = 10^{\frac{x}{5}}$

By definition of logarithms:

$$\frac{x}{5} = \log_{10}\left(\frac{y}{2}\right)$$

$$x = 5 \log_{10}\left(\frac{y}{2}\right)$$

Chapter 14 – Circular functions

Solutions to Exercise 14A

1 a $60^\circ = \frac{60\pi}{180} = \frac{\pi}{3}$

b $144^\circ = \frac{144\pi}{180} = \frac{4\pi}{5}$

c $240^\circ = \frac{240\pi}{180} = \frac{4\pi}{3}$

d $330^\circ = \frac{330\pi}{180} = \frac{11\pi}{6}$

e $420^\circ = \frac{420\pi}{180} = \frac{7\pi}{3}$

f $480^\circ = \frac{480\pi}{180} = \frac{8\pi}{3}$

2 a $\frac{2\pi}{3} = \frac{2\pi}{3} \frac{180^\circ}{\pi} = 120^\circ$

b $\frac{5\pi}{6} = \frac{5\pi}{6} \frac{180^\circ}{\pi} = 150^\circ$

c $\frac{7\pi}{6} = \frac{7\pi}{6} \frac{180^\circ}{\pi} = 210^\circ$

d $0.9\pi = 0.9\pi \frac{180^\circ}{\pi} = 162^\circ$

e $\frac{5\pi}{9} = \frac{5\pi}{9} \frac{180^\circ}{\pi} = 100^\circ$

f $\frac{9\pi}{5} = \frac{9\pi}{5} \frac{180^\circ}{\pi} = 324^\circ$

g $\frac{11\pi}{5} = \frac{11\pi}{5} \frac{180^\circ}{\pi} = 220^\circ$

h $1.8\pi = 1.8\pi \frac{180^\circ}{\pi} = 324^\circ$

3 From calculator:

a $0.6 = 34.38^\circ$

b $1.89 = 108.29^\circ$

c $2.9 = 166.16^\circ$

d $4.31 = 246.94^\circ$

e $3.72 = 213.14^\circ$

f $5.18 = 296.79^\circ$

g $4.73 = 271.01^\circ$

h $6.00 = 343.77^\circ$

4 From calculator:

a $38^\circ = 0.66$

b $73^\circ = 1.27$

c $107^\circ = 1.87$

d $161^\circ = 2.81$

e $84.1^\circ = 1.47$

f $228^\circ = 3.98$

g $136.4^\circ = 2.39$

h $329^\circ = 5.74$

$$5 \text{ a } -\frac{\pi}{3} = -\frac{\pi}{3} \frac{180^\circ}{\pi} = -60^\circ$$

$$\text{b } -4\pi = -4\pi \frac{180^\circ}{\pi} = -720^\circ$$

$$\text{c } -3\pi = -3\pi \frac{180^\circ}{\pi} = -540^\circ$$

$$\text{d } -\pi = -\pi \frac{180^\circ}{\pi} = -180^\circ$$

$$\text{e } \frac{5\pi}{3} = \frac{5\pi}{3} \frac{180^\circ}{\pi} = 300^\circ$$

$$\text{f } -\frac{11\pi}{6} = -\frac{11\pi}{6} \frac{180^\circ}{\pi} = 330^\circ$$

$$\text{g } \frac{23\pi}{6} = \frac{23\pi}{6} \frac{180^\circ}{\pi} = 690^\circ$$

$$\text{h } -\frac{23\pi}{6} = -\frac{23\pi}{6} \frac{180^\circ}{\pi} = -690^\circ$$

$$6 \text{ a } -360^\circ = -\frac{360\pi}{180} = -2\pi$$

$$\text{b } -540^\circ = -\frac{540\pi}{180} = -3\pi$$

$$\text{c } -240^\circ = -\frac{240\pi}{180} = -\frac{4\pi}{3}$$

$$\text{d } -720^\circ = -\frac{720\pi}{180} = -4\pi$$

$$\text{e } -330^\circ = -\frac{330\pi}{180} = -\frac{11\pi}{6}$$

$$\text{f } -210^\circ = -\frac{210\pi}{180} = -\frac{7\pi}{6}$$

7 a

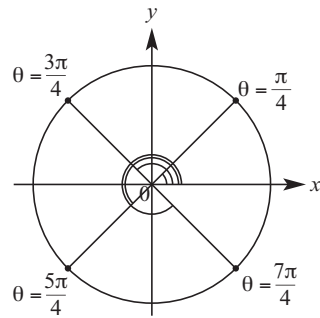

b

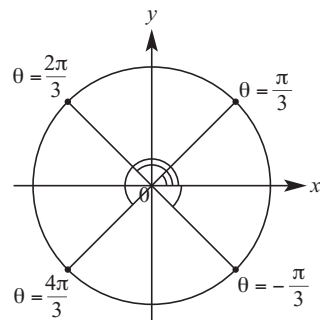

c

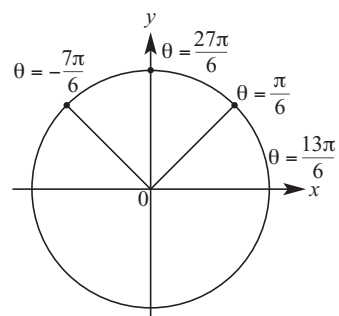

Solutions to Exercise 14B

1 a $t = 0$; $\sin t = 0$; $\cos t = 1$

b $t = \frac{3\pi}{2}$; $\sin t = -1$; $\cos t = 0$

c $t = -\frac{3\pi}{2}$; $\sin t = 1$; $\cos t = 0$

d $t = \frac{5\pi}{2}$; $\sin t = 1$; $\cos t = 0$

e $t = -3\pi$; $\sin t = 0$; $\cos t = -1$

f $t = \frac{9\pi}{2}$; $\sin t = 1$; $\cos t = 0$

g $t = \frac{7\pi}{2}$; $\sin t = -1$; $\cos t = 0$

h $t = 4\pi$; $\sin t = 0$; $\cos t = 1$

2 From calculator:

a $\sin 1.9 = 0.95$

b $\sin 2.3 = 0.75$

c $\sin 4.1 = -0.82$

d $\cos 0.3 = 0.96$

e $\cos 2.1 = -0.5$

f $\cos(-1.6) = -0.03$

g $\sin(-2.1) = -0.86$

h $\sin(-3.8) = 0.61$

3 a $\theta = 27\pi$; $\sin \theta = 0$; $\cos \theta = -1$

b $\theta = -\frac{5\pi}{2}$; $\sin \theta = -1$; $\cos \theta = 0$

c $\theta = \frac{27\pi}{2}$; $\sin \theta = -1$; $\cos \theta = 0$

d $\theta = -\frac{9\pi}{2}$; $\sin \theta = -1$; $\cos \theta = 0$

e $\theta = \frac{11\pi}{2}$; $\sin \theta = -1$; $\cos \theta = 0$

f $\theta = 57\pi$; $\sin \theta = 0$; $\cos \theta = -1$

g $\theta = 211\pi$; $\sin \theta = 0$; $\cos \theta = -1$

h $\theta = -53\pi$; $\sin \theta = 0$; $\cos \theta = -1$

Solutions to Exercise 14C

1 a $\tan \pi = \tan 0 = 0$

b $\tan(-\pi) = \tan 0 = 0$

c $\tan\left(\frac{7\pi}{2}\right) = \tan \frac{\pi}{2} = \text{undefined}$

d $\tan(-2\pi) = \tan 0 = 0$

e $\tan\left(\frac{5\pi}{2}\right) = \tan \frac{\pi}{2} = \text{undefined}$

f $\tan -\frac{\pi}{2} = \tan \frac{\pi}{2} = \text{undefined}$

2 From calculator:

a $\tan 1.6 = -34.23$

b $\tan(-1.2) = -2.57$

c $\tan 136^\circ = -0.97$

d $\tan(-54^\circ) = -1.38$

e $\tan 3.9 = 0.95$

f $\tan(-2.5) = 0.75$

g $\tan 239^\circ = 1.66$

3 a $\tan 180^\circ = \tan 0^\circ = 0$

b $\tan 360^\circ = \tan 0^\circ = 0$

c $\tan 0^\circ = 0$

d $\tan(-180^\circ) = \tan 0^\circ = 0$

e $\tan(-540^\circ) = \tan 0^\circ = 0$

f $\tan 720^\circ = \tan 0^\circ = 0$

Solutions to Exercise 14D

1 a $\theta = \cos^{-1}\left(\frac{3}{8}\right) = 67.98^\circ \text{ or } 67^\circ 59'$

b $x = 5 \cos 25^\circ = 4.5315$

c $x = 6 \sin 25^\circ = 2.5357$

d $x = 10 \cos 50^\circ = 6.4279$

e $\theta = \tan^{-1}\left(\frac{6}{5}\right) = 50.20^\circ \text{ or } 50^\circ 12'$

f $x = 10 \sin 20^\circ = 3.4202$

g $x = \frac{5}{\tan 65^\circ} = 2.3315$

h $x = 7 \sin 70^\circ = 6.5778$

i $x = \frac{5}{\cos 40^\circ} = 6.5270$

Solutions to Exercise 14E

1 $\sin \theta = 0.42, \cos x = 0.7, \tan \alpha = 0.38$

a $\sin(\pi + \theta) = -\sin \theta = -0.42$

b $\cos(\pi - x) = -\cos x = -0.7$

c $\sin(2\pi - \theta) = -\sin \theta = -0.42$

d $\tan(\pi - \alpha) = -\tan \alpha = -0.38$

e $\sin(\pi - \theta) = \sin \theta = 0.42$

f $\tan(2\pi - \alpha) = -\tan \alpha = -0.38$

g $\cos(\pi + x) = -\cos x = -0.7$

h $\cos(2\pi - x) = \cos x = 0.7$

2 a $\cos x = -\cos \frac{\pi}{6}; \frac{\pi}{2} < x < \pi,$

$$\therefore x = \pi - \frac{\pi}{6} = \frac{5\pi}{6}$$

b $\cos x = -\cos \frac{\pi}{6}; \pi < x < \frac{3\pi}{2}$

$$\therefore x = \pi + \frac{\pi}{6} = \frac{7\pi}{6}$$

c $\cos x = \cos \frac{\pi}{6}; \frac{3\pi}{2} < x < 2\pi$

$$\therefore x = 2\pi - \frac{\pi}{6} = \frac{11\pi}{6}$$

3 $\sin \theta = \frac{\sqrt{3}}{2}, \cos \theta = \frac{1}{2}$ from diagram

$$\tan \theta = \frac{\sin \theta}{\cos \theta} = \frac{\sqrt{3}}{2} \div \frac{1}{2} = \sqrt{3}$$

a $a = \cos(\pi - \theta) = -\cos \theta = -\frac{1}{2}$

b $b = \sin(\pi - \theta) = \sin \theta = \frac{\sqrt{3}}{2}$

c $c = \cos(-\theta) = \cos \theta = \frac{1}{2}$

d $d = \sin(-\theta) = -\sin \theta = -\frac{\sqrt{3}}{2}$

e $\tan(\pi - \theta) = -\tan \theta = -\sqrt{3}$

f $\tan(-\theta) = -\tan \theta = -\sqrt{3}$

4 $\sin \theta = \frac{\sqrt{3}}{2}, \cos \theta = -\frac{1}{2}$ from diagram

$$\tan \theta = \frac{\sin \theta}{\cos \theta} = \frac{\sqrt{3}}{2} \div -\frac{1}{2} = -\sqrt{3}$$

a $d = \sin(\pi + \theta) = -\sin \theta = -\frac{\sqrt{3}}{2}$

b $c = \cos(\pi + \theta) = -\cos \theta = \frac{1}{2}$

c $\tan(\pi + \theta) = \tan \theta = -\sqrt{3}$

d $\sin(2\pi - \theta) = -\sin \theta = -\frac{\sqrt{3}}{2}$

e $\cos(2\pi - \theta) = \cos \theta = -\frac{1}{2}$

5 a $(a, b) = (\cos 40^\circ, \sin 40^\circ)$
 $= (0.7660, 0.6428)$

b $(c, d) = (-\cos 40^\circ, \sin 40^\circ)$
 $= (-0.7660, 0.6428)$

c i $\cos 140^\circ = -0.7660,$
 $\sin 140^\circ = 0.6428$

ii $\cos 140^\circ = -\cos 40^\circ$

6 $\sin x^\circ = 0.7, \cos \theta = 0.6^\circ$ and

$$\tan \alpha^\circ = 0.4$$

a $\sin(180 + x)^\circ = -\sin x^\circ = -0.7$

b $\cos(180 + \theta)^\circ = -\cos \theta^\circ = -0.6$

c $\tan(360 - \alpha)^\circ = -\tan \alpha^\circ = -0.4$

d $\cos(180 - \theta)^\circ = -\cos \theta^\circ = -0.6$

e $\sin(360 - x)^\circ = -\sin x^\circ = -0.7$

f $\sin(-x)^\circ = -\sin x^\circ = -0.7$

g $\tan(360 + \alpha)^\circ = \tan \alpha^\circ = 0.4$

h $\cos(-\theta)^\circ = \cos \theta^\circ = 0.6$

7 a $\sin x = \sin 60^\circ$ and $90^\circ < x < 180^\circ$

$$\therefore x = 180^\circ - 60^\circ = 120^\circ$$

b

$$\sin x = -\sin 60^\circ \text{ and } 180^\circ < x < 270^\circ$$

$$\therefore x = 180^\circ + 60^\circ = 240^\circ$$

c $\sin x = -\sin 60^\circ$ and $-90^\circ < x < 0^\circ$

$$\therefore x = 0^\circ - 60^\circ = -60^\circ$$

d

$$\cos x^\circ = -\cos 60^\circ \text{ and } 90^\circ < x < 180^\circ$$

$$\therefore x = 180^\circ - 60^\circ = 120^\circ$$

e

$$\cos x^\circ = -\cos 60^\circ \text{ and } 180^\circ < x < 270^\circ$$

$$\therefore x = 180^\circ + 60^\circ = 240^\circ$$

f $\cos x^\circ = \cos 60^\circ$ and $270^\circ < x < 360^\circ$

$$\therefore x = 360^\circ - 60^\circ = 300^\circ$$

Solutions to Exercise 14F

1

	x	$\sin x$	$\cos x$	$\tan x$
a	120°	$\frac{\sqrt{3}}{2}$	$-\frac{1}{2}$	$-\sqrt{3}$
b	135°	$\frac{\sqrt{2}}{2}$	$-\frac{\sqrt{2}}{2}$	-1
c	210°	$-\frac{1}{2}$	$-\frac{\sqrt{3}}{2}$	$\frac{\sqrt{3}}{3}$
d	240°	$-\frac{\sqrt{3}}{2}$	$-\frac{1}{2}$	$\sqrt{3}$
e	315°	$-\frac{\sqrt{2}}{2}$	$\frac{\sqrt{2}}{2}$	-1
f	390°	$\frac{1}{2}$	$\frac{\sqrt{3}}{2}$	$\frac{\sqrt{3}}{3}$
g	420°	$\frac{\sqrt{3}}{2}$	$\frac{1}{2}$	$\sqrt{3}$
h	-135°	$-\frac{\sqrt{2}}{2}$	$-\frac{\sqrt{2}}{2}$	1
i	-300	$\frac{\sqrt{3}}{2}$	$\frac{1}{2}$	$\sqrt{3}$
j	-60	$-\frac{\sqrt{3}}{2}$	$\frac{1}{2}$	$-\sqrt{3}$

$$2 \text{ a } \sin \frac{2\pi}{3} = \sin \frac{\pi}{3} = \frac{\sqrt{3}}{2}$$

$$\text{b } \cos \frac{3\pi}{4} = -\cos \frac{\pi}{4} = -\frac{\sqrt{2}}{2}$$

$$\text{c } \tan \frac{5\pi}{6} = -\tan \frac{\pi}{6} = -\frac{\sqrt{3}}{3}$$

$$\text{d } \sin \frac{7\pi}{6} = -\sin \frac{\pi}{6} = -\frac{1}{2}$$

$$\text{e } \cos \frac{5\pi}{4} = -\cos \frac{\pi}{4} = -\frac{\sqrt{2}}{2}$$

$$\text{f } \tan \frac{4\pi}{3} = \tan \frac{\pi}{3} = \sqrt{3}$$

$$\text{g } \sin \frac{5\pi}{3} = -\sin \frac{\pi}{3} = -\frac{\sqrt{3}}{2}$$

$$\text{h } \cos \frac{7\pi}{4} = \cos \frac{\pi}{4} = \frac{\sqrt{2}}{2}$$

$$\text{i } \tan \frac{11\pi}{6} = -\tan \frac{\pi}{6} = -\frac{\sqrt{3}}{3}$$

$$3 \text{ a } \sin \left(-\frac{2\pi}{3}\right) = -\sin \left(\frac{2\pi}{3}\right) \\ = -\sin \frac{\pi}{3} = -\frac{\sqrt{3}}{2}$$

$$\text{b } \cos \frac{11\pi}{4} = \cos \frac{3\pi}{4} \\ = -\cos \frac{\pi}{4} = -\frac{\sqrt{2}}{2}$$

$$\text{c } \tan \frac{13\pi}{6} = \tan \frac{\pi}{6} = \frac{\sqrt{3}}{3}$$

$$\text{d } \tan \frac{15\pi}{6} = \tan \frac{5\pi}{2} \\ = \tan \frac{\pi}{2} = \text{undefined}$$

$$\text{e } \cos \frac{14\pi}{4} = \cos \frac{7\pi}{2} \\ = \cos \frac{3\pi}{2} = 0$$

$$\text{f } \cos \left(-\frac{3\pi}{4}\right) = \cos \frac{3\pi}{4} \\ = -\cos \frac{\pi}{4} = -\frac{\sqrt{2}}{2}$$

$$\text{g } \sin \frac{11\pi}{4} = \sin \frac{3\pi}{4} \\ = \sin \frac{\pi}{4} = \frac{\sqrt{2}}{2}$$

$$\text{h } \cos \left(-21\frac{\pi}{3}\right) = \cos (-7\pi) \\ = \cos \pi = -1$$

Solutions to Exercise 14G

1 a $2 \sin \theta$: per = 2π , ampl = 2

b $3 \sin 2\theta$: per = $\frac{2\pi}{2} = \pi$, ampl = 3

c $\frac{1}{2} \cos 3\theta$: per = $\frac{2\pi}{3}$, ampl = $\frac{1}{2}$

d $3 \sin \frac{\theta}{2}$: per = $\frac{2\pi}{\frac{1}{2}} = 4\pi$, ampl = 3

e $4 \cos 3\theta$: per = $\frac{2\pi}{3}$, ampl = 4

f $-\frac{1}{2} \sin 4\theta$: per = $\frac{2\pi}{4} = \frac{\pi}{2}$, ampl = $\frac{1}{2}$

g $-2 \cos \frac{\theta}{2}$: per = $\frac{2\pi}{\frac{1}{2}} = 4\pi$, ampl = 2

h $2 \cos \pi t$: per = $\frac{2\pi}{\pi} = 2$, ampl = 2

i $-3 \sin \left(\frac{\pi t}{2}\right)$: per = $\frac{2\pi}{\frac{\pi}{2}} = 4$, ampl = 3

2 a $g(x) = 3 \sin x$: dilation of 3 from x -axis, amplitude = 3, period = 2π

b $g(x) = \sin(5x)$: dilation of $\frac{1}{5}$ from y -axis, amplitude = 1, period = $\frac{2\pi}{5}$

c $g(x) = \sin\left(\frac{x}{3}\right)$: dilation of 3 from y -axis, amplitude = 1, period = 6π

d $g(x) = 2 \sin 5x$: dilation of 2 from x -axis, dilation of $\frac{1}{5}$ from y -axis, amplitude = 2, period = $\frac{2\pi}{5}$

3 a $y = 3 \sin 2x$:

per = π , ampl = 3, x -intercepts $0, \frac{\pi}{2}, \pi$

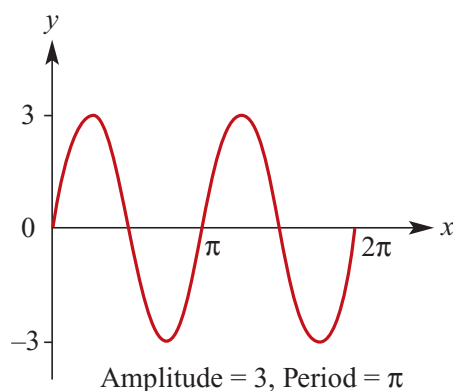

b $y = 2 \cos 3\theta$:
per = $\frac{2\pi}{3}$, ampl = 2,
 θ intercepts $0, \frac{\pi}{6}, \frac{\pi}{2}$

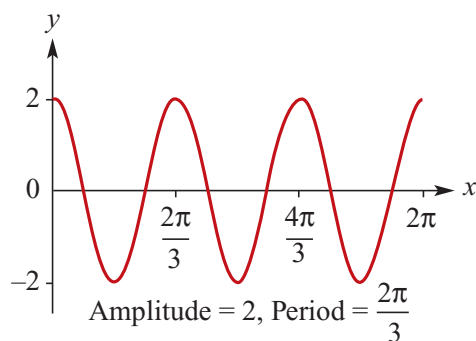

c $y = 4 \cos \frac{\theta}{2}$:
per = 4π , ampl = 4,
 θ intercepts $0, \pi, 3\pi$

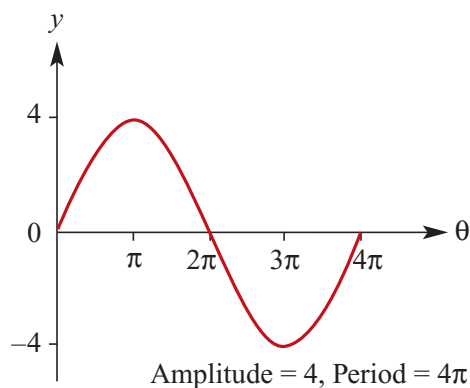

d $y = \frac{1}{2} \cos 3x$:
 per = $\frac{2\pi}{3}$, ampl = $\frac{1}{2}$,
 x intercepts $\frac{\pi}{6}, \frac{\pi}{2}$

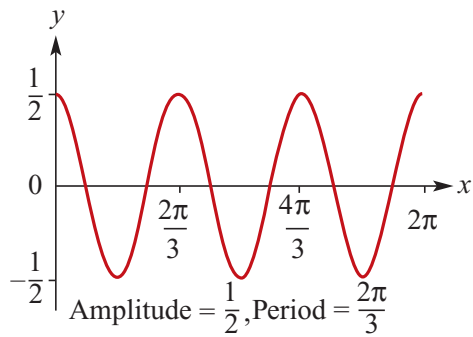

g $y = -3 \cos \frac{\theta}{2}$:
 per = 4π , ampl = 3,
 θ intercepts 0, π , 3π

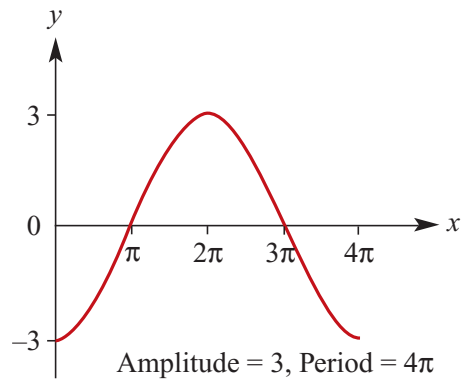

e $y = 4 \sin 3x$:
 per = $\frac{2\pi}{3}$, ampl = 4,
 x intercepts 0, $\frac{2\pi}{3}, \frac{4\pi}{3}$

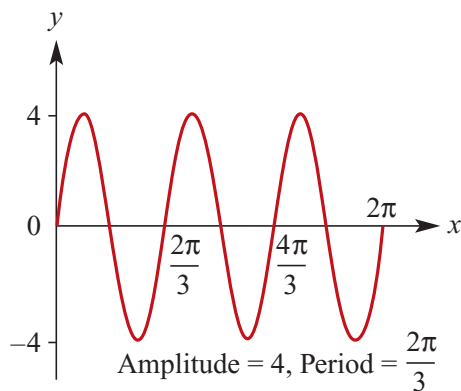

h $y = 2 \cos 4\theta$:
 per = $\frac{\pi}{2}$, ampl = 2,
 θ intercepts 0, $\frac{\pi}{8}, \frac{3\pi}{8}$

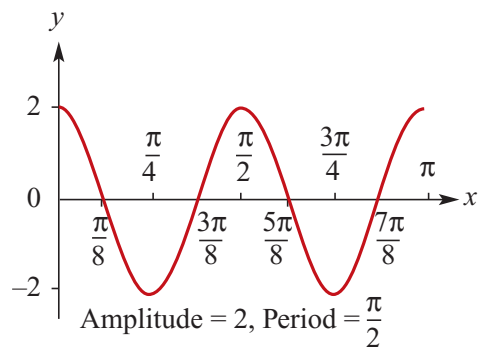

f $y = 5 \cos 2x$:
 per = π , ampl = 5,
 x intercepts 0, $\frac{\pi}{4}, \frac{3\pi}{4}$

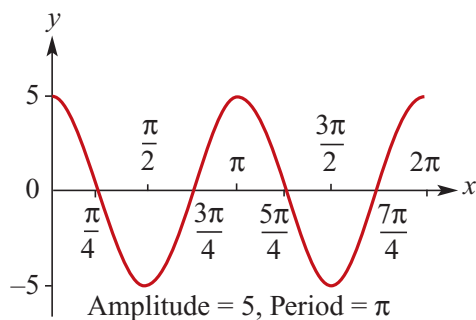

i $y = -2 \sin \frac{\theta}{3}$:
 per = 6π , ampl = 2,
 θ intercepts 0, 3π , 6π

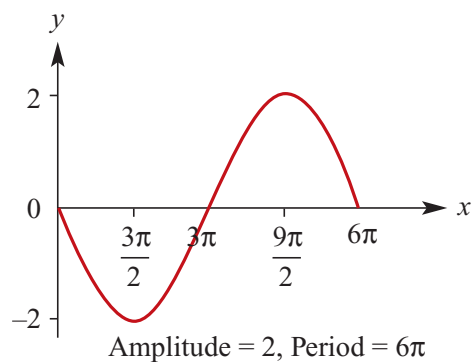

- 4 a** $f: [0, 2] \rightarrow R, f(t) = 2 \cos \pi t$
 per = $\frac{2\pi}{\pi} = 2$, ampl = 2,
 range = $[-2, 2]$,
 endpoints (0, 2) and
 (2, 2); x -intercepts $\frac{1}{2}, \frac{3}{2}$

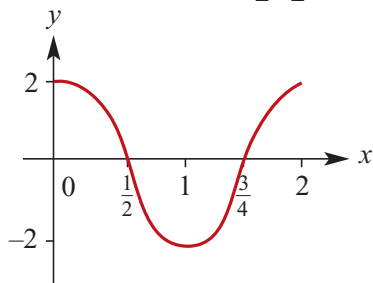

- b** $f: [0, 2] \rightarrow R, f(t) = 3 \sin(2\pi t)$
 per = $\frac{2\pi}{2\pi} = 1$, ampl = 3,
 range = $[-3, 3]$,
 endpoints (0, 0) and (2, 0);
 x -intercepts $\frac{1}{2}, \frac{3}{2}, \frac{5}{2}$

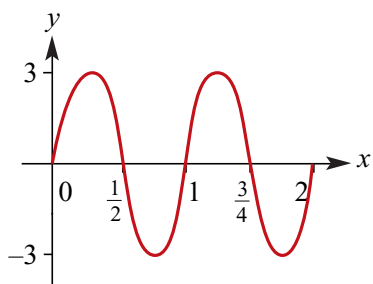

- 5 a** $f(x) = \sin 2x$ for $x \in [-2\pi, 2\pi]$:
 endpoints: $(-2\pi, 0), (2\pi, 0)$
 x -intercepts: $-\frac{3\pi}{2}, -\pi, -\frac{\pi}{2}, 0, \frac{\pi}{2}, \pi, \frac{3\pi}{2}$
 ampl = 1, range $[-1, 1]$

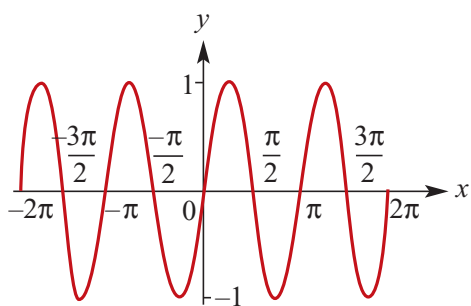

- b** $f(x) = 2 \sin \frac{x}{3}$ for $x \in [-6\pi, 6\pi]$:
 endpoints: $(-6\pi, 0), (6\pi, 0)$
 x -intercepts: $-3\pi, 0, 3\pi$
 ampl = 2, range $[-2, 2]$

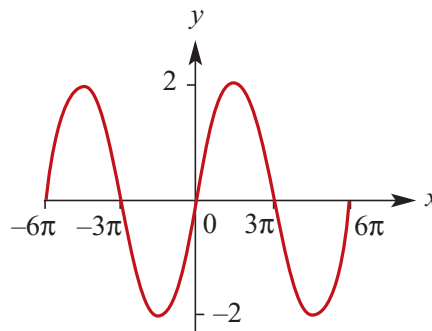

- c** $f(x) = 2 \cos 3x$ for $x \in [0, 2\pi]$:
 endpoints: (0, 1), $(2\pi, 1)$
 x -intercepts: $\frac{\pi}{6}, \frac{\pi}{2}, \frac{5\pi}{6}, \frac{7\pi}{6}, \frac{3\pi}{2}, \frac{11\pi}{6}$
 ampl = 2, range $[-2, 2]$

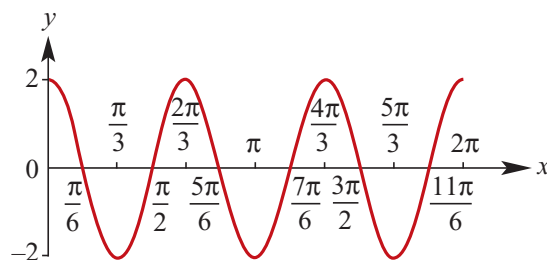

- d** $f(x) = -2 \sin 3x$ for $x \in [0, 2\pi]$:
 endpoints: (0, 0), $(2\pi, 0)$
 x -intercepts: $\frac{\pi}{3}, \frac{2\pi}{3}, \pi, \frac{4\pi}{3}, \frac{5\pi}{3}$
 ampl = 2, range $[-2, 2]$

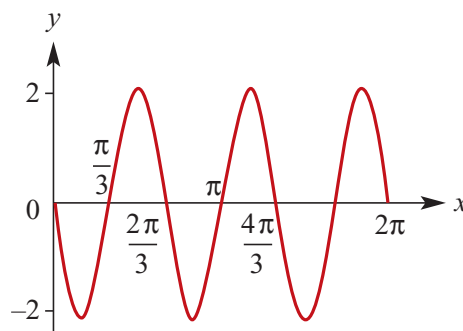

- 6** $f: [0, 2\pi] \rightarrow R, f(x) = \frac{5}{2} \cos\left(\frac{2x}{3}\right)$:

endpoints: $f(0) = \frac{5}{2}$ and $f(2\pi) = -\frac{5}{4}$
 per = $\frac{2\pi}{\frac{2}{3}} = 3\pi$ so we only have $\frac{2}{3}$ period
 ampl = $\frac{5}{2}$, range = $\left[-\frac{5}{2}, \frac{5}{2}\right]$

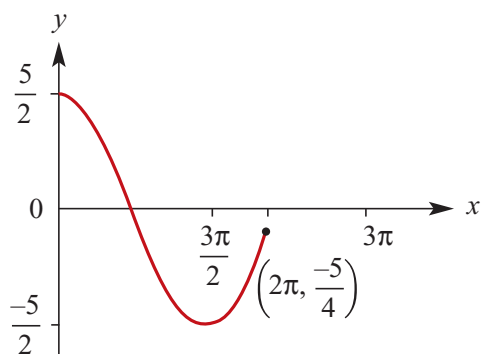

- 7 a** $g(x) = -\sin 5x$: dilation of $\frac{1}{5}$ from y -axis, reflection in x -axis, amplitude = 1, period = $\frac{2\pi}{5}$
- b** $g(x) = \sin(-x)$: reflection in y -axis, amplitude = 1, period = 2π
- c** $g(x) = 2 \sin\left(\frac{x}{3}\right)$: dilation of 3 from y -axis, dilation of 2 from x -axis, amplitude = 2, period = 6π
- d** $g(x) = -4 \sin\left(\frac{x}{2}\right)$: dilation of 2 from y -axis, dilation of 4 from x -axis, reflection in x -axis, amplitude = 4, period = 4π
- e** $g(x) = 2 \sin\left(-\frac{x}{3}\right)$: dilation of 3 from y -axis, dilation of 2 from x -axis, reflection in y -axis, amplitude = 2, period = 6π

- 8 a** $f: [0, 2\pi] \rightarrow R, f(x) = \sin x$;
 per = 2π , ampl = 1, range = $[-1, 1]$,
 endpoints $(0, 0)$ and $(2\pi, 0)$,
 other x -intercept at π

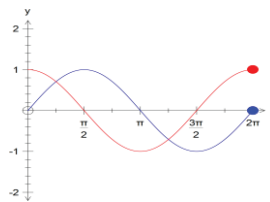

- $g: [0, 2\pi] \rightarrow R, g(x) = \cos x$;
 per = 2π , ampl = 1, range = $[-1, 1]$,
 endpoints at $(0, 1)$ and $(2\pi, 1)$,
 x -intercepts at $\frac{\pi}{2}, \frac{3\pi}{2}$

- b** $\sin x = \cos x$ when $x = \frac{\pi}{4}$ and $\frac{5\pi}{4}$

Solutions to Exercise 14H

1 a

$$\begin{aligned}\cos x &= \frac{1}{2} \\ x &= \frac{\pi}{3}, 2\pi - \frac{\pi}{3}, 2\pi + \frac{\pi}{3}, 4\pi - \frac{\pi}{3}, \dots \\ &= \frac{\pi}{3}, \frac{5\pi}{3}, \frac{7\pi}{3}, \frac{11\pi}{3}\end{aligned}$$

b

$$\begin{aligned}\sin x &= \frac{1}{\sqrt{2}} \\ x &= \frac{\pi}{4}, \pi - \frac{\pi}{4}, 2\pi + \frac{\pi}{4}, 3\pi - \frac{\pi}{4}, \dots \\ &= \frac{\pi}{4}, \frac{3\pi}{4}, \frac{9\pi}{4}, \frac{11\pi}{4}\end{aligned}$$

c

$$\begin{aligned}\sin x &= \frac{\sqrt{3}}{2} \\ x &= \frac{\pi}{3}, \pi - \frac{\pi}{3}, 2\pi + \frac{\pi}{3}, 3\pi - \frac{\pi}{3}, \dots \\ &= \frac{\pi}{3}, \frac{2\pi}{3}, \frac{7\pi}{3}, \frac{8\pi}{3}\end{aligned}$$

2 Solve over $[0, 2\pi]$:

a $\sin x = 0.8, \therefore x = 0.93, \pi - 0.93$
 $= 0.93, 2.21$

b $\cos x = -0.4, \therefore x = \pi \pm 1.16$
 $= 1.98, 4.30$

c $\sin x = -0.35,$
 $\therefore x = \pi + 0.36, 2\pi - 0.36$
 $= 3.50, 5.93$

d $\sin x = 0.4, \therefore x = 0.41, \pi - 0.41$
 $= 0.41, 2.73$

e $\cos x = -0.7, \therefore x = \pi \pm 0.80$
 $= 2.35, 3.94$

f $\cos x = -0.2, \therefore x = \pi \pm 1.39$
 $= 1.77, 4.51$

3 Solve over $[0, 360^\circ]$:

a $\cos \theta^\circ = -\frac{\sqrt{3}}{2}, \therefore \theta = 180 \pm 30$
 $= 150, 210$

b $\sin \theta^\circ = \frac{1}{2}, \therefore \theta = 30, 180 - 30$
 $= 30, 150$

c $\cos \theta^\circ = -\frac{1}{2}, \therefore \theta = 180 \pm 60$
 $= 120, 240$

d $2 \cos \theta^\circ + 1 = 0, \therefore \cos \theta^\circ = -\frac{1}{2}$
 $\therefore \theta = 120, 240$

e $2 \sin \theta^\circ = \sqrt{3}, \therefore \sin \theta^\circ = \frac{\sqrt{3}}{2}$
 $\therefore \theta = 60, 180 - 60$
 $= 60, 120$

f $\sqrt{2} \sin \theta^\circ - 1 = 0, \therefore \sin \theta^\circ = \frac{1}{\sqrt{2}}$
 $\theta = 45, 180 - 45$
 $= 45, 135$

4 a $2 \cos x = \sqrt{3}$
 $\therefore \cos x = \frac{\sqrt{3}}{2}$
 $x = \pi - \frac{\pi}{6}, \pi + \frac{\pi}{6}$
 $= \frac{5\pi}{6}, \frac{7\pi}{6}$

$$\begin{aligned} \text{b} \quad & \sqrt{2} \sin x + 1 = 0 \\ \therefore & \sin x = -\frac{1}{\sqrt{2}} \\ & x = \pi + \frac{\pi}{4}, 2\pi - \frac{\pi}{4} \\ & = \frac{5\pi}{4}, \frac{7\pi}{4} \end{aligned}$$

$$\begin{aligned} \text{c} \quad & \sqrt{2} \cos x - 1 = 0 \\ \therefore & \cos x = \frac{1}{\sqrt{2}} \\ & x = \frac{\pi}{4}, 2\pi - \frac{\pi}{4} \\ & = \frac{\pi}{4}, \frac{7\pi}{4} \end{aligned}$$

5 Solve over $[-\pi, \pi]$:

$$\begin{aligned} \text{a} \quad \cos x = -\frac{1}{\sqrt{2}}, \therefore x = \pi - \frac{\pi}{4}, -\pi + \frac{\pi}{4} \\ = -\frac{3\pi}{4}, \frac{3\pi}{4} \end{aligned}$$

$$\begin{aligned} \text{b} \quad \sin x = \frac{\sqrt{3}}{2}, \therefore x = \frac{\pi}{3}, \pi - \frac{\pi}{3} \\ = \frac{\pi}{3}, \frac{2\pi}{3} \end{aligned}$$

$$\begin{aligned} \text{c} \quad \cos x = -\frac{1}{2}, \therefore x = \pi - \frac{\pi}{3}, -\pi + \frac{\pi}{3} \\ = -\frac{2\pi}{3}, \frac{2\pi}{3} \end{aligned}$$

6 a $f: [-2\pi, 2\pi] \rightarrow R, f(x) = \cos x$

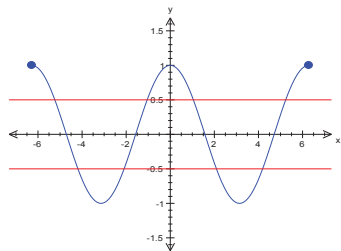

b Line marked at $y = \frac{1}{2}$, x -values are at:

$$x = \pm \frac{\pi}{3}, \pm \left(2\pi - \frac{\pi}{3}\right) = \pm \frac{\pi}{3}, \pm \frac{5\pi}{3}$$

c Line marked at $y = -\frac{1}{2}$, x -values are at:
 $x = \pm \left(\pi \pm \frac{\pi}{3}\right) = \pm \frac{2\pi}{3}, \pm \frac{4\pi}{3}$

7 Solve over $[0, 2\pi]$:

$$\begin{aligned} \text{a} \quad & \sin(2\theta) = -\frac{1}{2} \\ \therefore & 2\theta = \pi + \frac{\pi}{6}, 2\pi - \frac{\pi}{6}, 3\pi + \frac{\pi}{6}, 4\pi - \frac{\pi}{6} \\ & \theta = \frac{7\pi}{12}, \frac{11\pi}{12}, \frac{19\pi}{12}, \frac{23\pi}{12} \end{aligned}$$

$$\begin{aligned} \text{b} \quad & \cos(2\theta) = \frac{\sqrt{3}}{2} \\ \therefore & 2\theta = \frac{\pi}{6}, 2\pi - \frac{\pi}{6}, 2\pi + \frac{\pi}{6}, 4\pi - \frac{\pi}{6} \\ & \theta = \frac{\pi}{12}, \frac{11\pi}{12}, \frac{13\pi}{12}, \frac{23\pi}{12} \end{aligned}$$

$$\begin{aligned} \text{c} \quad & \sin(2\theta) = \frac{1}{2} \\ \therefore & 2\theta = \frac{\pi}{6}, \pi - \frac{\pi}{6}, 2\pi + \frac{\pi}{6}, 3\pi - \frac{\pi}{6} \\ & \theta = \frac{\pi}{12}, \frac{5\pi}{12}, \frac{13\pi}{12}, \frac{17\pi}{12} \end{aligned}$$

$$\begin{aligned} \text{d} \quad & \sin(3\theta) = -\frac{1}{\sqrt{2}} \\ \therefore & 3\theta = \pi + \frac{\pi}{4}, 2\pi - \frac{\pi}{4}, 3\pi + \frac{\pi}{4}, 4\pi - \frac{\pi}{4} \dots \\ & \theta = \frac{5\pi}{12}, \frac{7\pi}{12}, \frac{13\pi}{12}, \frac{15\pi}{12}, \frac{21\pi}{12}, \frac{23\pi}{12} \end{aligned}$$

$$\begin{aligned} \mathbf{e} \quad \cos(2\theta) &= -\frac{\sqrt{3}}{2} \\ \therefore \quad 2\theta &= \pi \pm \frac{\pi}{6}, 3\pi \pm \frac{\pi}{6} \\ \theta &= \frac{5\pi}{12}, \frac{7\pi}{12}, \frac{17\pi}{12}, \frac{19\pi}{12} \end{aligned}$$

$$\begin{aligned} \mathbf{f} \quad \sin(2\theta) &= -\frac{1}{\sqrt{2}} \\ \therefore \quad 2\theta &= \pi + \frac{\pi}{4}, 2\pi - \frac{\pi}{4}, 3\pi + \frac{\pi}{4}, 4\pi - \frac{\pi}{4} \\ \theta &= \frac{5\pi}{8}, \frac{7\pi}{8}, \frac{13\pi}{8}, \frac{15\pi}{8} \end{aligned}$$

8 Solve over $[0, 2\pi]$:

$$\begin{aligned} \mathbf{a} \quad \sin(2\theta) &= -0.8 \\ \therefore \quad 2\theta &= \pi + 0.927, 2\pi - 0.927, \\ &\quad 3\pi + 0.927, 4\pi - 0.927 \\ \theta &= 2.034, 2.678, 5.176, 5.820 \end{aligned}$$

$$\begin{aligned} \mathbf{b} \quad \sin(2\theta) &= -0.6 \\ \therefore \quad 2\theta &= \pi + 0.644, 2\pi - 0.644, \\ &\quad 3\pi + 0.644, 4\pi - 0.644 \\ \theta &= 1.892, 2.820, 5.034, 5.961 \end{aligned}$$

$$\begin{aligned} \mathbf{c} \quad \cos(2\theta) &= 0.4 \\ \therefore \quad 2\theta &= 1.159, 2\pi \pm 1.159, 4\pi - 1.159 \\ \theta &= 0.580, 2.562, 3.721, 5.704 \end{aligned}$$

$$\begin{aligned} \mathbf{d} \quad \cos(3\theta) &= 0.6 \\ \therefore \quad 3\theta &= 0.927, 2\pi \pm 0.927; \\ &\quad 4\pi \pm 0.927, 6\pi - 0.927 \\ \theta &= 0.309, 1.785, 2.403, \\ &\quad 3.880, 4.498, 5.974 \end{aligned}$$

Solutions to Exercise 14I

1 a $y = 3 \sin\left(\theta - \frac{\pi}{2}\right)$:
per = 2π , ampl = 3, range = $[-3, 3]$

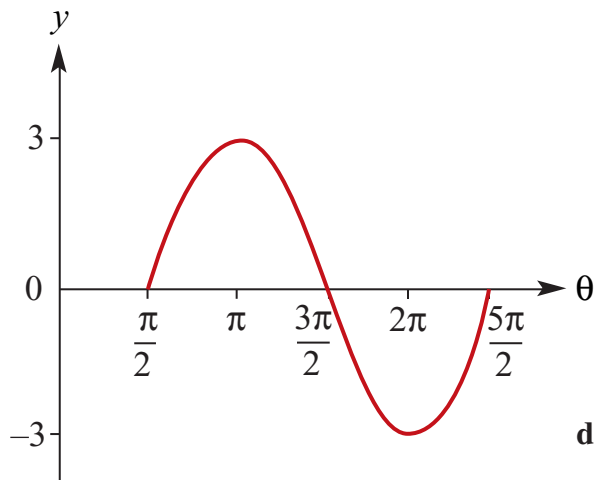

b $y = \sin 2(\theta + \pi)$:
per = π , ampl = 1, range = $[-1, 1]$

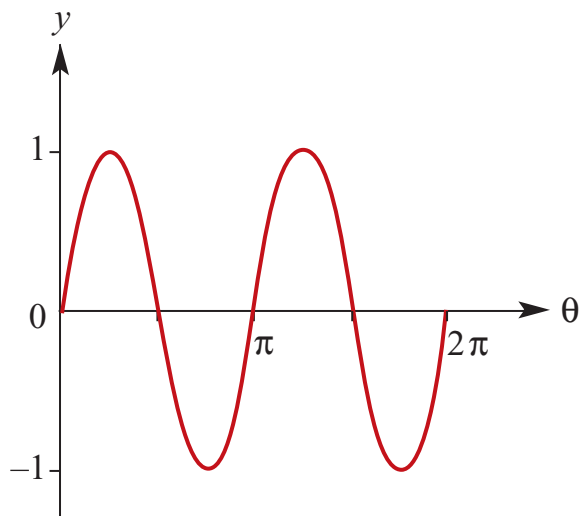

c $y = 2 \sin 3\left(\theta + \frac{\pi}{4}\right)$:
per = $\frac{2\pi}{3}$, ampl = 2, range = $[-2, 2]$

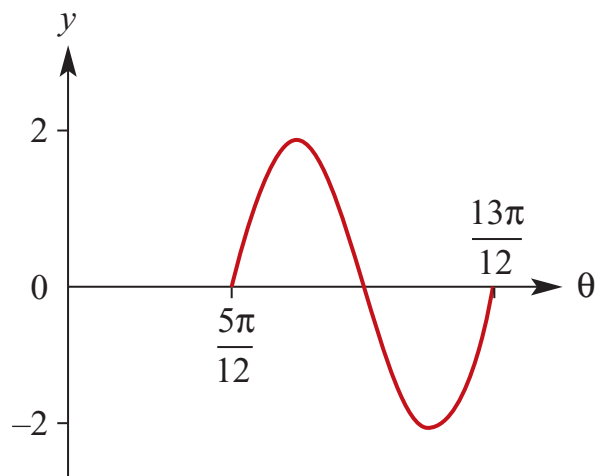

d $y = \sqrt{3} \sin 2\left(\theta - \frac{\pi}{2}\right)$:
per = π , ampl = $\sqrt{3}$,
range = $[-\sqrt{3}, \sqrt{3}]$

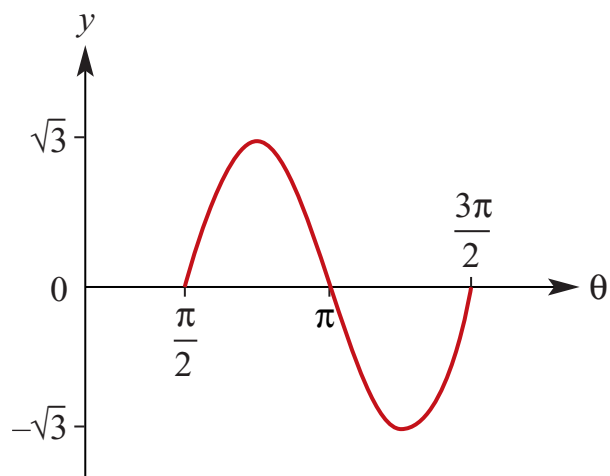

e $y = 3 \sin(2x)$:
per = π , ampl = 3, range = $[-3, 3]$

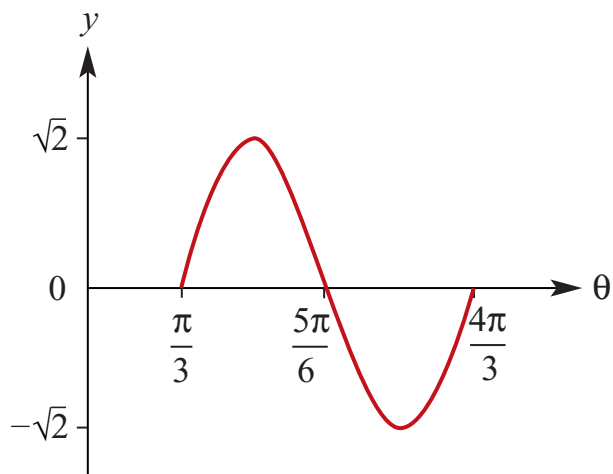
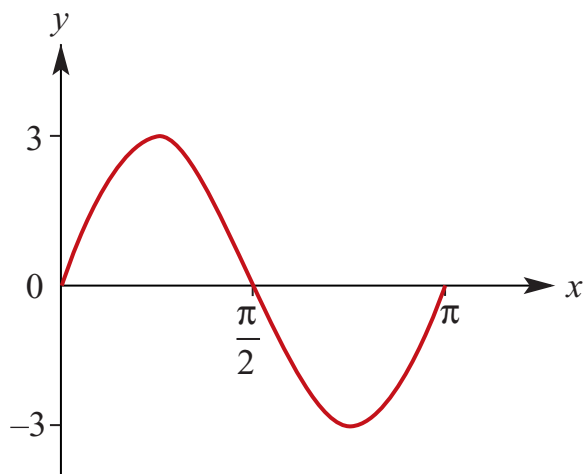

f $y = 2 \cos 3 \left(\theta + \frac{\pi}{4} \right)$:
 per = $\frac{2\pi}{3}$, ampl = 2, range = $[-2, 2]$

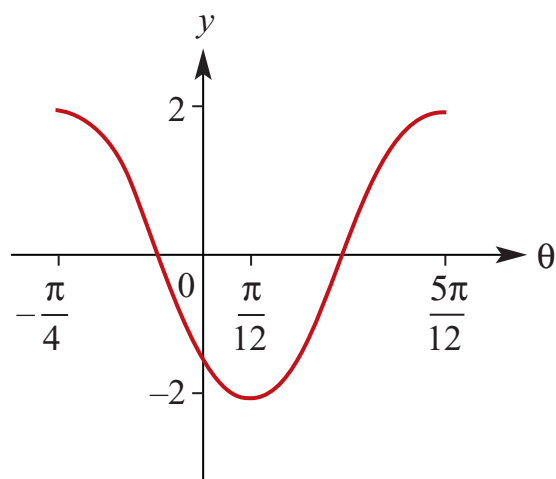

h $y = -3 \sin (2x)$:
 per = π , ampl = 3, range = $[-3, 3]$

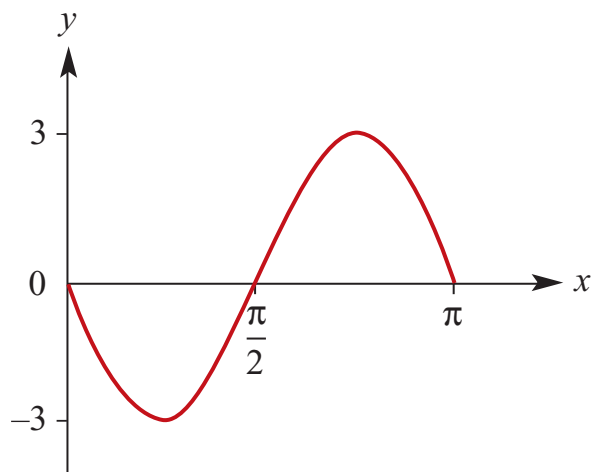

g $y = \sqrt{2} \sin 2 \left(\theta - \frac{\pi}{3} \right)$:
 per = π , ampl = $\sqrt{2}$,
 range = $[-\sqrt{2}, \sqrt{2}]$

i $y = -3 \cos 2 \left(\theta + \frac{\pi}{2} \right)$:
 per = π , ampl = 3, range = $[-3, 3]$

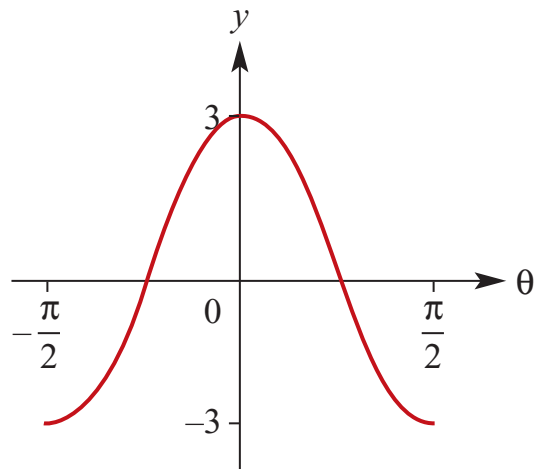

2 $f: [0, 2\pi] \rightarrow \mathbb{R}, f(x) = \cos\left(x - \frac{\pi}{3}\right)$

$$f(0) = \cos\left(-\frac{\pi}{3}\right) = \frac{1}{2}$$

$$f(2\pi) = \cos\left(\frac{5\pi}{3}\right) = \frac{1}{2}$$

per = 2π , ampl = 1, range $[-1, 1]$

x-intercepts at $\frac{5\pi}{6}, \frac{11\pi}{6}$

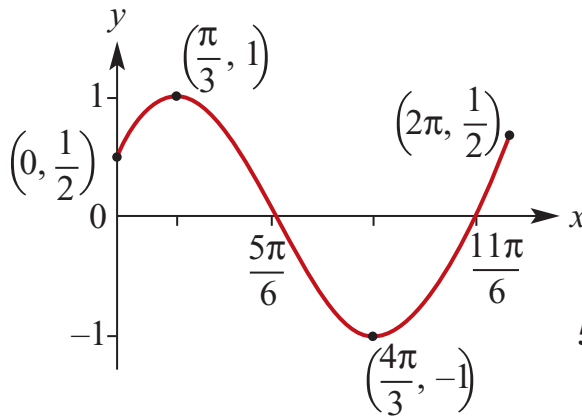

3 $f: [0, 2\pi] \rightarrow \mathbb{R}, f(x) = \sin 2\left(x - \frac{\pi}{3}\right)$

$$f(0) = \sin\left(-\frac{2\pi}{3}\right) = -\frac{\sqrt{3}}{2}$$

$$f(2\pi) = \sin\left(\frac{10\pi}{3}\right) = -\frac{\sqrt{3}}{2}$$

per = π , ampl = 1, range $[-1, 1]$

x-intercepts at $\frac{\pi}{3}, \frac{5\pi}{6}, \frac{4\pi}{3}, \frac{11\pi}{6}$

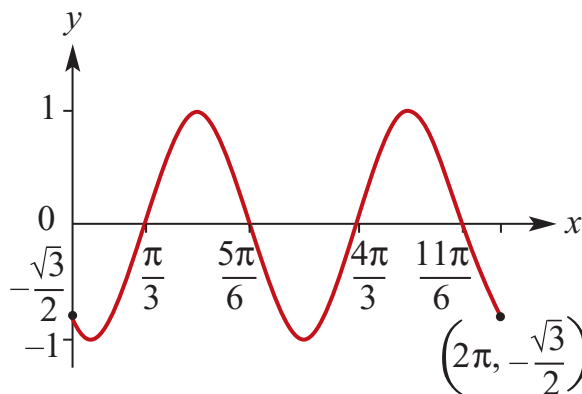

4 $f: [-\pi, \pi] \rightarrow \mathbb{R}, f(x) = \sin 3\left(x + \frac{\pi}{4}\right)$

$$f(-\pi) = \sin\left(-\frac{3\pi}{4}\right) = -\frac{\sqrt{2}}{2}$$

$$f(\pi) = \sin\left(\frac{5\pi}{4}\right) = -\frac{\sqrt{2}}{2}$$

per = $\frac{2\pi}{3}$, ampl = 1, range $[-1, 1]$,

x-intercepts at $-\frac{11\pi}{12}, -\frac{7\pi}{12}, -\frac{\pi}{4}, \frac{\pi}{12}, \frac{5\pi}{12}, \frac{3\pi}{4}$

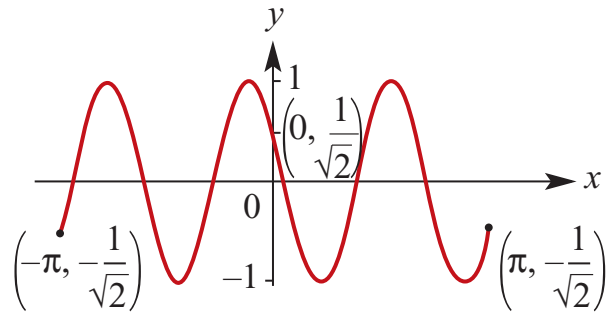

5 $y = \sin x$

a Dilation of 2 from y-axis: $y = \sin\left(\frac{x}{2}\right)$;

dilation of 3 from x-axis:

$$y = 3 \sin\left(\frac{x}{2}\right)$$

b Dilation of $\frac{1}{2}$ from y-axis: $y = \sin 2x$;

dilation of 3 from x-axis: $y = 3 \sin 2x$

c Dilation of 3 from y-axis: $y = \sin\left(\frac{x}{3}\right)$;

dilation of 2 from x-axis:

$$y = 2 \sin\left(\frac{x}{3}\right)$$

d Dilation of $\frac{1}{2}$ from y-axis: $y = \sin 2x$;

translation of $+\frac{\pi}{3}$ (x-axis):

$$y = \sin 2\left(x - \frac{\pi}{3}\right)$$

e Dilation of 2 from the y-axis:

$$y = \sin\left(\frac{x}{2}\right);$$

translation of $-\frac{\pi}{3}$ (x-axis):

$$y = \sin \frac{1}{2}\left(x + \frac{\pi}{3}\right)$$

Solutions to Exercise 14J

1 Sketch over $[0, 2\pi]$:

- a** $y = 2 \sin x + 1$;
 per = 2π , ampl = 2, range = $[-1, 3]$,
 endpoints at $(0, 1)$ and $(2\pi, 0)$
 $y = 0$ when $\sin x = -\frac{1}{2}$,
 i.e. when $x = \frac{7\pi}{6}, \frac{11\pi}{6}$

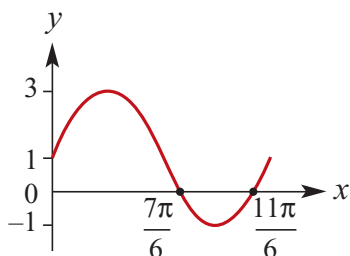

- b** $y = 2 \sin 2x - \sqrt{3}$;
 per = π , ampl = 2,
 range = $[-2 - \sqrt{3}, 2 - \sqrt{3}]$,
 endpoints at $(0, -\sqrt{3})$ and $(2\pi, -\sqrt{3})$
 $y = 0$ when $\sin 2x = \frac{\sqrt{3}}{2}$,
 i.e. when $x = \frac{\pi}{6}, \frac{\pi}{3}, \frac{7\pi}{6}, \frac{4\pi}{3}$

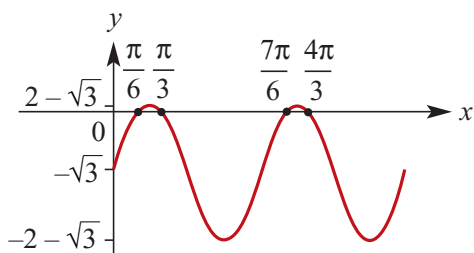

- c** $y = \sqrt{2} \cos x + 1$;
 per = 2π , ampl = $\sqrt{2}$,
 range = $[-\sqrt{2} + 1, \sqrt{2} + 1]$,
 endpoints at $(0, \sqrt{2} + 1)$ and
 $(2\pi, \sqrt{2} + 1)$
 $y = 0$ when $\cos x = -\frac{1}{\sqrt{2}}$
 i.e. when $x = \frac{3\pi}{4}, \frac{5\pi}{4}$

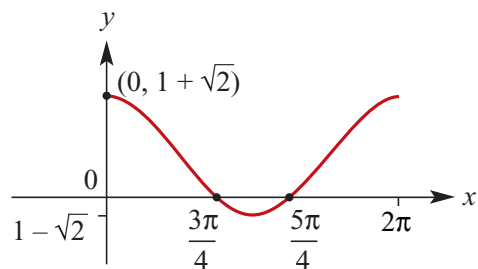

- d** $y = 2 \sin 2x - 2$;
 per = π , ampl = 2, range = $[-4, 0]$,
 endpoints at $(0, -2)$ and $(2\pi, -2)$
 $y = 0$ when $\sin 2x = 1$,
 i.e. when $x = \frac{\pi}{4}, \frac{5\pi}{4}$

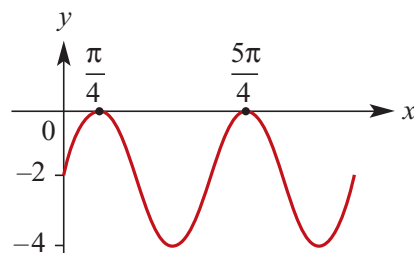

- e** $y = \sqrt{2} \sin\left(x - \frac{\pi}{4}\right) + 1$
 per = 2π , ampl = $\sqrt{2}$,
 range = $[1 - \sqrt{2}, 1 + \sqrt{2}]$,
 endpoints at $(0, 0)$ and $(2\pi, 0)$
 $y = 0$ when $\sin\left(x - \frac{\pi}{4}\right) = -\frac{1}{\sqrt{2}}$
 i.e. when $x - \frac{\pi}{4} = -\frac{\pi}{4}, \pi + \frac{\pi}{4}, 2\pi - \frac{\pi}{4}$
 i.e. $x = 0, \frac{3\pi}{2}, 2\pi$

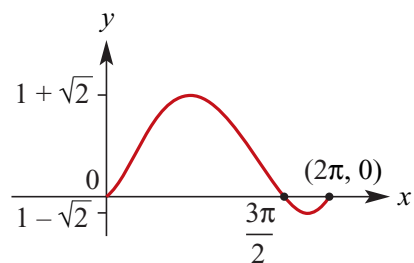

2 Sketch over $[-2\pi, 2\pi]$:

a $y = 2 \sin 3x - 2$;
 per = $\frac{2\pi}{3}$, ampl = 2, range = $[-4, 0]$,
 endpoints at $(-2\pi, -2)$ and $(2\pi, -2)$
 $y = 0$ when $\sin 3x = 1$
 i.e. when $x = \frac{\pi}{6}, \frac{5\pi}{6}, \frac{3\pi}{2}$,
 $-\frac{\pi}{2}, -\frac{7\pi}{6}, -\frac{11\pi}{6}$

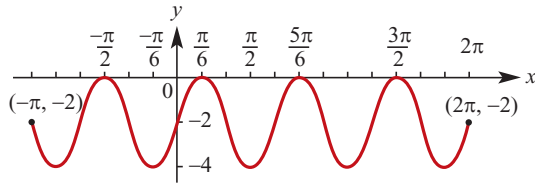

b $y = 2 \cos 3\left(x - \frac{\pi}{4}\right)$;
 per = $\frac{2\pi}{3}$, ampl = 2, range = $[-2, 2]$,
 endpoints at $(-2\pi, -\sqrt{2})$ and
 $(2\pi, -\sqrt{2})$
 $y = 0$ when $\cos 3\left(x - \frac{\pi}{4}\right) = 0$
 $\therefore 3\left(x - \frac{\pi}{4}\right) = \pm\frac{\pi}{2}, \pm\frac{3\pi}{2}, \dots, \pm\frac{11\pi}{2}$
 $x - \frac{\pi}{4} = \pm\frac{\pi}{6}, \pm\frac{\pi}{2}, \pm\frac{5\pi}{6}, \dots, \pm\frac{11\pi}{6}$
 $x = -\frac{23\pi}{12}, -\frac{19\pi}{12}, -\frac{5\pi}{4}, -\frac{11\pi}{12}, -\frac{7\pi}{12},$
 $-\frac{\pi}{4}, \frac{\pi}{12}, \frac{5\pi}{12}, \frac{3\pi}{4}, \frac{13\pi}{12}, \frac{17\pi}{12}, \frac{7\pi}{4}$
 The $\frac{11\pi}{6}$ solution will drop out, since
 adding $\frac{\pi}{4}$ to it will take the resulting
 number over 2π .
 It must be replaced by the solution
 $\frac{\pi}{4} - \frac{13\pi}{6}$.

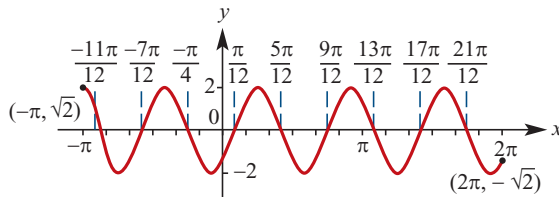

c $y = 2 \sin 2x - 3$;
 per = π , ampl = 2, range = $[-5, -1]$,

endpoints at $(-2\pi, -3)$ and $(2\pi, -3)$
 No x -intercepts since $y < 0$ for all
 real x

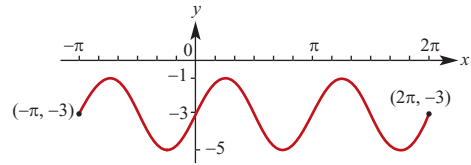

d $y = 2 \cos 2x + 1$;
 per = π , ampl = 2, range = $[-1, 3]$,
 endpoints at $(-2\pi, 3)$ and $(2\pi, 3)$
 $y = 0$ when $\cos 2x = -\frac{1}{2}$
 i.e. when $2x = \pm\left(\pi \pm \frac{\pi}{3}, \pm 3\pi \pm \frac{\pi}{3}\right)$
 $\therefore x = \pm\frac{\pi}{3}, \pm\frac{2\pi}{3}, \pm\frac{4\pi}{3}, \pm\frac{5\pi}{3}$

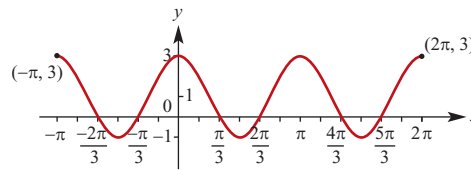

e $y = 2 \cos 2\left(x - \frac{\pi}{3}\right) - 1$;
 per = π , ampl = 2, range = $[-3, 1]$,
 endpoints at $(-2\pi, -2)$ and $(2\pi, -2)$
 $y = 0$ when $\cos 2\left(x - \frac{\pi}{3}\right) = \frac{1}{2}$
 $\therefore 2\left(x - \frac{\pi}{3}\right) = \pm\frac{\pi}{3}, \pm\left(2\pi \pm \frac{\pi}{3}\right), \pm\left(4\pi \pm \frac{\pi}{3}\right)$
 $x - \frac{\pi}{3} = \pm\frac{\pi}{6}, \pm\left(\pi \pm \frac{\pi}{6}\right), \pm\left(2\pi \pm \frac{\pi}{6}\right)$
 $x = -\frac{11\pi}{6}, -\frac{3\pi}{2}, -\frac{5\pi}{6}, -\frac{\pi}{2},$
 $\frac{\pi}{6}, \frac{\pi}{2}, \frac{7\pi}{6}, \frac{3\pi}{2}$

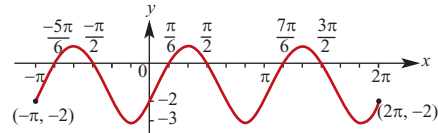

f $y = 2 \sin 2\left(x + \frac{\pi}{6}\right) + 1$;
 per = π , ampl = 2, range = $[-1, 3]$,
 endpoints at $(-2\pi, 1 + \sqrt{3})$ and

$$(2\pi, 1 + \sqrt{3})$$

$$y = 0 \text{ when } \sin 2\left(x + \frac{\pi}{6}\right) = -\frac{1}{2}$$

Positive solutions:

$$2\left(x + \frac{\pi}{6}\right) = \pi + \frac{\pi}{6}, 2\pi - \frac{\pi}{6}, 3\pi + \frac{\pi}{6}, 4\pi - \frac{\pi}{6}$$

$$x + \frac{\pi}{6} = \frac{7\pi}{12}, \frac{11\pi}{12}, \frac{19\pi}{12}, \frac{23\pi}{12}$$

$$x = \frac{5\pi}{12}, \frac{3\pi}{4}, \frac{17\pi}{12}, \frac{7\pi}{4}$$

Negative solutions:

$$2\left(x + \frac{\pi}{6}\right) = -\frac{\pi}{6}, -\pi + \frac{\pi}{6}, -2\pi - \frac{\pi}{6}, -3\pi + \frac{\pi}{6}$$

$$x + \frac{\pi}{6} = -\frac{\pi}{12}, -\frac{5\pi}{12}, -\frac{13\pi}{12}, -\frac{17\pi}{12}$$

$$x = -\frac{\pi}{4}, -\frac{7\pi}{12}, -\frac{5\pi}{4}, -\frac{19\pi}{12}$$

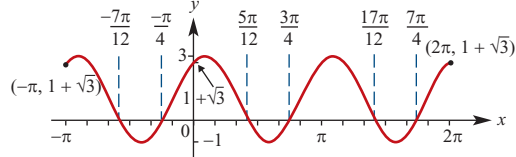

3 Sketch over $[-\pi, \pi]$:

a $y = 2 \sin 2\left(x + \frac{\pi}{3}\right) + 1$;

per = π , ampl = 2, range = $[-1, 3]$,

endpoints at $(-\pi, 1 + \sqrt{3})$ and $(\pi, 1 + \sqrt{3})$

$$y = 0 \text{ when } \sin 2\left(x + \frac{\pi}{3}\right) = -\frac{1}{2}$$

$$\therefore 2\left(x + \frac{\pi}{3}\right) = -\frac{5\pi}{6}, -\frac{\pi}{6}, \frac{7\pi}{6}, \frac{11\pi}{6}$$

$$x + \frac{\pi}{3} = -\frac{5\pi}{12}, -\frac{\pi}{12}, \frac{7\pi}{12}, \frac{11\pi}{12}$$

$$x = -\frac{3\pi}{4}, -\frac{5\pi}{12}, \frac{\pi}{4}, \frac{7\pi}{12}$$

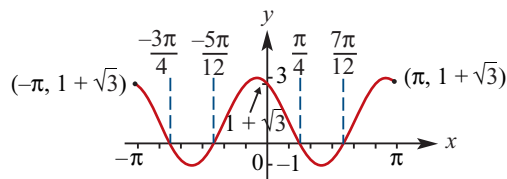

b $y = -2 \sin 2\left(x + \frac{\pi}{6}\right) + 1$;

per = π , ampl = 2, range = $[-1, 3]$,

endpoints at $(-\pi, 1 - \sqrt{3})$ and

$(\pi, 1 - \sqrt{3})$

$$y = 0 \text{ when } \sin 2\left(x + \frac{\pi}{6}\right) = \frac{1}{2}$$

$$\therefore 2\left(x + \frac{\pi}{6}\right) = -\frac{7\pi}{6}, \frac{\pi}{6}, \frac{5\pi}{6}, \frac{13\pi}{6}$$

$$x + \frac{\pi}{6} = -\frac{7\pi}{12}, \frac{\pi}{12}, \frac{5\pi}{12}, \frac{13\pi}{12}$$

$$x = -\frac{3\pi}{4}, -\frac{\pi}{12}, \frac{\pi}{4}, \frac{11\pi}{12}$$

As with **Q.2b**, $-\frac{11\pi}{6}$ drops out,

replaced by $\frac{13\pi}{6}$.

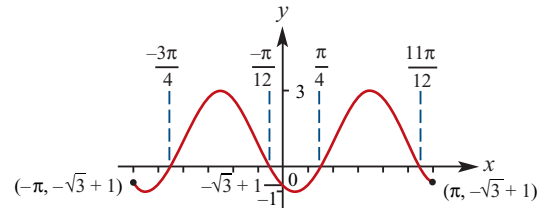

c $y = 2 \cos 2\left(x + \frac{\pi}{4}\right) + \sqrt{3}$;

per = π , ampl = 2, range = $[-1, 3]$,

endpoints at $(-\pi, \sqrt{3})$ and $(\pi, \sqrt{3})$

$$y = 0 \text{ when } \cos 2\left(x + \frac{\pi}{4}\right) = -\frac{\sqrt{3}}{2}$$

$$\therefore 2\left(x + \frac{\pi}{4}\right) = -\frac{7\pi}{6}, -\frac{5\pi}{6}, \frac{5\pi}{6}, \frac{7\pi}{6}$$

$$x + \frac{\pi}{4} = -\frac{7\pi}{12}, -\frac{5\pi}{12}, \frac{5\pi}{12}, \frac{7\pi}{12}$$

$$x = -\frac{5\pi}{6}, -\frac{2\pi}{3}, \frac{\pi}{6}, \frac{\pi}{3}$$

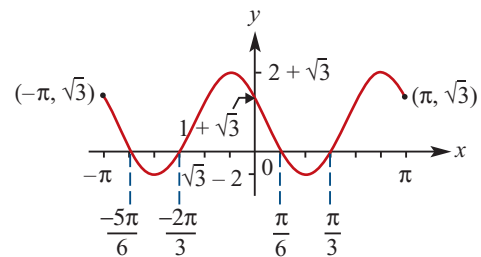

Solutions to Exercise 14K

1 $\sin x = 0.3$, $\cos \alpha = 0.6$ and $\tan \theta = 0.7$

a $\cos(-\alpha) = \cos \alpha = 0.6$

b $\sin(\frac{\pi}{2} + \alpha) = \cos \alpha = 0.6$

c $\tan(-\theta) = -\tan \theta = -0.7$

d $\cos(\frac{\pi}{2} - x) = \sin x = 0.3$

e $\sin(-x) = -\sin x = -0.3$

f $\tan(\frac{\pi}{2} - \theta) = \frac{1}{0.7} = \frac{10}{7}$

g $\cos(\frac{\pi}{2} + x) = -\sin x = -0.3$

h $\sin(\frac{\pi}{2} - \alpha) = \cos \alpha = 0.6$

i $\sin(\frac{3\pi}{2} + \alpha) = -\cos \alpha = -0.6$

j $\cos(\frac{3\pi}{2} - x) = -\sin x = -0.3$

2 $0 < \theta < \frac{\pi}{2}$

a $\cos \theta = \sin \frac{\pi}{6}$

$$\therefore \theta = (\frac{\pi}{2} - \frac{\pi}{6}) = \frac{\pi}{3}$$

b $\sin \theta = \cos \frac{\pi}{6}$

$$\therefore \theta = (\frac{\pi}{2} - \frac{\pi}{6}) = \frac{\pi}{3}$$

c $\cos \theta = \sin \frac{\pi}{12}$

$$\therefore \theta = (\frac{\pi}{2} - \frac{\pi}{12}) = \frac{5\pi}{12}$$

d $\sin \theta = \cos \frac{3\pi}{7}$

$$\therefore \theta = (\frac{\pi}{2} - \frac{3\pi}{7}) = \frac{\pi}{14}$$

3 $\cos x = \frac{3}{5}$, $\frac{3\pi}{2} < x < 2\pi$:

$$\sin x = \pm \sqrt{1 - (\frac{3}{5})^2} = \pm \frac{4}{5}$$

4th quadrant: $\sin x = -\frac{4}{5}$

$$\tan x = -\frac{4}{5} \div \frac{3}{5} = -\frac{4}{3}$$

4 $\sin x = \frac{5}{13}$, $\frac{\pi}{2} < x < \pi$:

$$\cos x = \pm \sqrt{1 - (\frac{5}{13})^2} = \pm \frac{12}{13}$$

2nd quadrant: $\cos x = -\frac{12}{13}$

$$\tan x = \frac{5}{13} \div -\frac{12}{13} = -\frac{5}{12}$$

5 $\cos x = \frac{1}{5}$, $\frac{3\pi}{2} < x < 2\pi$:

$$\sin x = \pm \sqrt{1 - (\frac{1}{5})^2} = \pm \frac{\sqrt{24}}{5} = \pm \frac{2}{5} \sqrt{6}$$

4th quadrant: $\sin x = -\frac{2}{5} \sqrt{6}$

$$\tan x = -\frac{2}{5} \sqrt{6} \div \frac{1}{5} = -2 \sqrt{6}$$

Solutions to Exercise 14L

1 a $y = \tan(4x)$, per = $\frac{\pi}{4}$

b $y = \tan\left(\frac{2x}{3}\right)$, per = $\frac{\pi}{2} = \frac{3\pi}{2}$

c $y = -3 \tan(2x)$, per = $\frac{\pi}{2}$

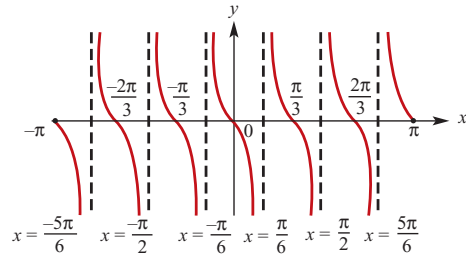

2 a $y = \tan(2x)$:

x -intercepts at $0, \pm\frac{\pi}{2}, \pm\pi$

Vertical asymptotes at $x = \pm\frac{\pi}{4}, \pm\frac{3\pi}{4}$

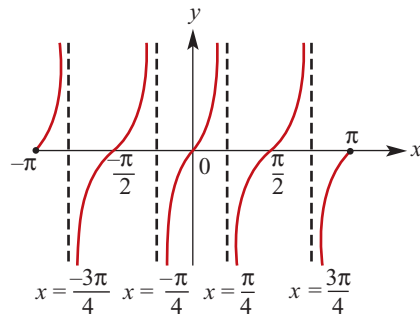

b $y = 2 \tan(3x)$:

x -intercepts at $0, \pm\frac{\pi}{3}, \pm\frac{2\pi}{3}, \pm\pi$

Vertical asymptotes at

$x = \pm\frac{\pi}{6}, \pm\frac{\pi}{2}, \pm\frac{5\pi}{6}$

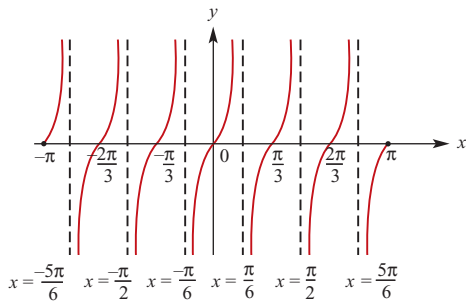

c $y = -2 \tan(3x)$:

x -intercepts at $0, \pm\frac{\pi}{3}, \pm\frac{2\pi}{3}, \pm\pi$

Vertical asymptotes at

$x = \pm\frac{\pi}{6}, \pm\frac{\pi}{2}, \pm\frac{5\pi}{6}$

3 Solve over $[-\pi, \pi]$:

a $2 \tan 2x = 2, \therefore \tan 2x = 1$

$\therefore 2x = -\frac{7\pi}{4}, -\frac{3\pi}{4}, \frac{\pi}{4}, \frac{5\pi}{4}$

$x = -\frac{7\pi}{8}, -\frac{3\pi}{8}, \frac{\pi}{8}, \frac{5\pi}{8}$

b $3 \tan 3x = \sqrt{3}, \therefore \tan 3x = \frac{\sqrt{3}}{3}$

$\therefore 3x = -\frac{17\pi}{6}, -\frac{11\pi}{6}, -\frac{5\pi}{6}, \frac{\pi}{6}, \frac{7\pi}{6}, \frac{13\pi}{6}$

$x = -\frac{17\pi}{18}, -\frac{11\pi}{18}, -\frac{5\pi}{18}, \frac{\pi}{18}, \frac{7\pi}{18}, \frac{13\pi}{18}$

c $2 \tan 2x = 2\sqrt{3} \tan 2x = \sqrt{3}$

$\therefore 2x = -\frac{5\pi}{3}, -\frac{2\pi}{3}, \frac{\pi}{3}, \frac{4\pi}{3}$

$\therefore x = -\frac{5\pi}{6}, -\frac{\pi}{3}, \frac{\pi}{6}, \frac{2\pi}{3}$

d $3 \tan 3x = -\sqrt{3}, \therefore \tan 3x = -\frac{\sqrt{3}}{3}$

$\therefore 3x = -\frac{13\pi}{6}, -\frac{7\pi}{6}, -\frac{\pi}{6}, \frac{5\pi}{6}, \frac{11\pi}{6}, \frac{17\pi}{6}$

$x = -\frac{13\pi}{18}, -\frac{7\pi}{18}, -\frac{\pi}{18}, \frac{5\pi}{18}, \frac{11\pi}{18}, \frac{17\pi}{18}$

4 Sketch over $[-\pi, \pi]$:

a $y = 3 \tan x + \sqrt{3}$

x -intercepts where $\tan x = -\frac{1}{\sqrt{3}}$

$\therefore x = -\frac{\pi}{6}, \frac{5\pi}{6}$

Vertical asymptotes at $x = \pm \frac{\pi}{2}$

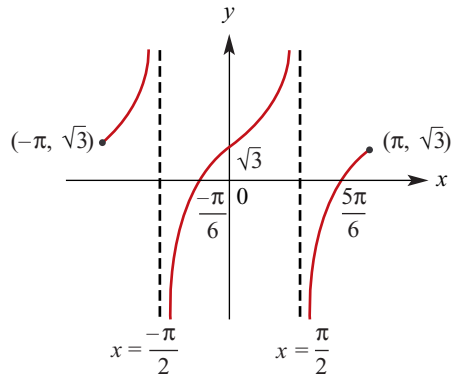

b $y = 2 \tan x + 2$

x -intercepts where $\tan x = -1$

$$\therefore x = -\frac{\pi}{4}, \frac{3\pi}{4}$$

Vertical asymptotes at $x = \pm \frac{\pi}{2}$

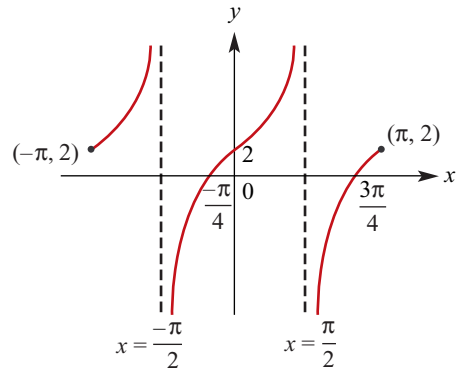

c $y = 3 \tan x - 3$

x -intercepts where $\tan x = 1$

$$\therefore x = \frac{\pi}{4}, -\frac{3\pi}{4}$$

Vertical asymptotes at $x = \pm \frac{\pi}{2}$

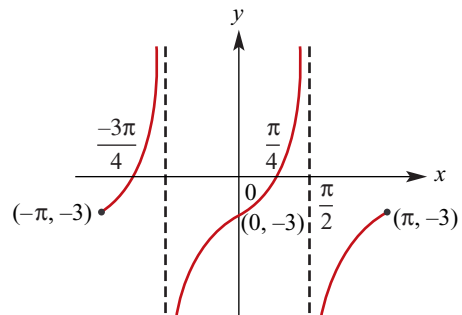

Solutions to Exercise 14M

1 From calculator:

a $\cos x = x, \therefore x = 0.74$

b $\sin x = 1 - x, \therefore x = 0.51$

c $\cos x = x^2, \therefore x = \pm 0.82$

d $\sin x = x^2, x = 0, 0.88$

2 $y = a \sin(b\theta + c) + d$ From calculator:

a $y = 1.993 \sin(2.998 \theta + 0.003) + 0.993$

b $y = 3.136 \sin(3.051 \theta + 0.044) - 0.140$

c $y = 4.971 \sin(3.010 \theta + 3.136) + 4.971$

Solutions to Exercise 14N

1 a $\sin x = 0.5, \therefore x = \frac{\pi}{6}$ (primary solution)
 2nd solution is $x = \pi - \frac{\pi}{6} = \frac{5\pi}{6}$
 $\therefore x = (12n+1)\frac{\pi}{6}, (12n+5)\frac{\pi}{6}; n \in \mathbb{Z}$

b $2 \cos 3x = \sqrt{3}, \therefore 3x = \pm \frac{\pi}{6}$
 $x = \pm \frac{\pi}{18}$
 $\therefore x = (12n \pm 1)\frac{\pi}{18}; n \in \mathbb{Z}$

c $\sqrt{3} \tan x = -3, \therefore \tan x = -\sqrt{3}$
 $x = \frac{2\pi}{3}$
 $\therefore x = (3n+2)\frac{\pi}{3}; n \in \mathbb{Z}$

2 a $\sin x = 0.5, \therefore x = \frac{\pi}{6}, \pi - \frac{\pi}{6}$
 $= \frac{\pi}{6}, \frac{5\pi}{6}$

b $2 \cos 3x = \sqrt{3}, \therefore \cos 3x = \frac{\sqrt{3}}{2}$
 $3x = \frac{\pi}{6}, \frac{11\pi}{6}$
 $\therefore x = \frac{\pi}{18}, \frac{11\pi}{18}$

c $\sqrt{3} \tan x = -3, \therefore \tan x = -\sqrt{3}$
 $\therefore x = \frac{2\pi}{3}, \frac{5\pi}{3}$

3

$$2 \cos\left(2x + \frac{\pi}{4}\right) = \sqrt{2}$$

$$\therefore \cos\left(2x + \frac{\pi}{4}\right) = \frac{1}{\sqrt{2}}$$

$$2x + \frac{\pi}{4} = (8n \pm 1)\frac{\pi}{4}$$

$$2x = \frac{8n\pi}{4}, (8n-2)\frac{\pi}{4}$$

$$2x = 2n\pi, (4n-1)\frac{\pi}{2}$$

$$\therefore x = n\pi, (4n-1)\frac{\pi}{4}; n \in \mathbb{Z}$$

Over $(-2\pi, 2\pi)$ the solutions are:

$$x = \frac{5\pi}{4}, -\pi, -\frac{\pi}{4}, 0, \pi, \frac{3\pi}{4}, \frac{7\pi}{4}$$

4 $\sqrt{3} \tan\left(\frac{\pi}{6} - 3x\right) - 1 = 0$

$$\therefore \tan\left(\frac{\pi}{6} - 3x\right) = \frac{1}{\sqrt{3}}$$

$$\frac{\pi}{6} - 3x = (6n+1)\frac{\pi}{6}$$

$$-3x = \frac{6n\pi}{6} = n\pi$$

$$\therefore x = \frac{n\pi}{3}; n \in \mathbb{Z}$$

Over $[-\pi, 0]$ the solutions are:

$$x = -\pi, -\frac{2\pi}{3}, -\frac{\pi}{3}, 0$$

5

$$2 \sin(4\pi x) + \sqrt{3} = 0$$

$$\therefore \sin(4\pi x) = -\frac{\sqrt{3}}{2}$$

$$4\pi x = (6n+4)\frac{\pi}{3}, (6n+5)\frac{\pi}{3}$$

$$\therefore x = \frac{3n+2}{6}, \frac{6n+5}{12}; n \in \mathbb{Z}$$

Over $[-1, 1]$ the solutions are:

$$x = -\frac{2}{3}, -\frac{7}{12}, -\frac{1}{6}, -\frac{1}{12}, \frac{1}{3}, \frac{5}{12}, \frac{5}{6}, \frac{11}{12}$$

Solutions to Exercise 140

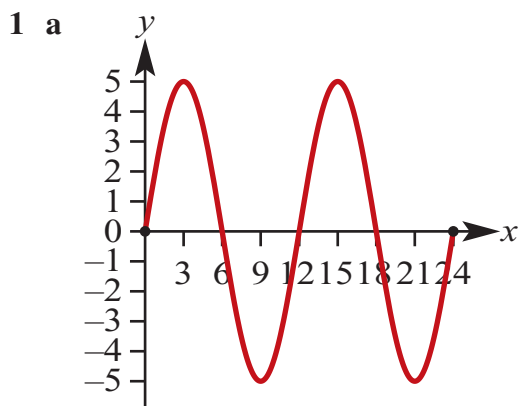

b Maximum values occur when $\sin\left(\frac{\pi}{6}t\right) = 1$
That is when $t = 3$ and $t = 15$

c $h(3) = h(15) = 5$. The maximum height is 5 m above mean sea level

d $h(2) = 5 \sin\left(\frac{\pi}{3}\right) = \frac{5\sqrt{3}}{2}$ m above mean sea level

e $h(14) = 5 \sin\left(\frac{7\pi}{3}\right) = \frac{5\sqrt{3}}{2}$ m above mean sea level

f $5 \sin\left(\frac{\pi}{6}t\right) = 2.5$

$$\sin\left(\frac{\pi}{6}t\right) = \frac{1}{2}$$

$$\frac{\pi}{6}t = \frac{\pi}{6}, \frac{5\pi}{6}, \frac{13\pi}{6}, \frac{17\pi}{6}$$

$$t = 1, 5, 13, 17$$

Tide is higher than 2.5 m for $t \in [1, 5] \cup [13, 17]$

2 a $x = 3 + 2 \sin 3t$

When $\sin 3t = 1$, $x = 3 + 2 = 5$, the greatest distance from O .

b When $\sin 3t = -1$, $x = 3 - 2 = 1$, the least distance from O .

c When $x = 5$, $3 + 2 \sin 3t = 5$

$$\therefore \sin 3t = 1$$

$$\therefore 3t = \frac{\pi}{2} \text{ or } \frac{5\pi}{2} \text{ or } \frac{9\pi}{2} \text{ or } \dots$$

$$\therefore t = \frac{\pi}{6} \text{ or } \frac{5\pi}{6} \text{ or } \frac{9\pi}{6} \text{ or } \dots$$

$\therefore t = 0.524$ or 2.618 or 4.712 seconds for $t \in [0, 5]$

d When $x = 3$, $3 + 2 \sin 3t = 3$

$$\therefore \sin 3t = 0$$

$$\therefore 3t = 0 \text{ or } \pi \text{ or } 2\pi \text{ or } \dots$$

$$\therefore t = 0 \text{ or } \frac{\pi}{3} \text{ or } \frac{2\pi}{3} \text{ or } \dots$$

$$\therefore t = 0 \text{ or } 1.047 \text{ or } 2.094 \text{ seconds for } t \in [0, 3]$$

e Particle oscillates about $x = 3$, from $x = 1$ to $x = 5$.

3 $x = 5 + 2 \sin(2\pi t)$. Note that the particle oscillates between $x = 3$ and $x = 7$

a Greatest distance from O when $\sin(2\pi t) = 1$. Therefore greatest distance from O is 7 m

b Least distance from O when $\sin(2\pi t) = -1$. Therefore least distance from O is 7 m

c $5 + 2 \sin(2\pi t) = 7$

$$2 \sin(2\pi t) = 2$$

$$\sin(2\pi t) = 1$$

$$2\pi t = \frac{\pi}{2}, \frac{5\pi}{2}, \dots$$

$$t = \frac{1}{4}, \frac{5}{4}, \frac{9}{4}, \frac{13}{4}, \frac{17}{4}$$

d $5 + 2 \sin(2\pi t) = 6$

$$2 \sin(2\pi t) = 1$$

$$\sin(2\pi t) = \frac{1}{2}$$

$$2\pi t = \frac{\pi}{6}, \frac{5\pi}{6}, \frac{13\pi}{6}, \frac{17\pi}{6}, \frac{25\pi}{6}, \frac{29\pi}{6}, \dots$$

$$t = \frac{1}{12}, \frac{5}{12}, \frac{13}{12}, \frac{17}{12}, \frac{25}{12}, \frac{29}{12}$$

e Particle oscillates between $x = 3$ and $x = 7$

4 $h(t) = 10 \sin\left(\frac{\pi t}{3}\right) + 10$

a i $h(0) = 10 \sin(0) + 10 = 10$

$$\text{ii } h(1) = 10 \sin\left(\frac{\pi}{3}\right) + 10 = 10 + 5\sqrt{3}$$

$$\text{iii } h(2) = 10 \sin\left(\frac{2\pi}{3}\right) + 10 = 10 + 5\sqrt{3}$$

$$\text{iv } h(4) = 10 \sin\left(\frac{4\pi}{3}\right) + 10 = 10 - 5\sqrt{3}$$

$$\text{v } h(5) = 10 \sin\left(\frac{5\pi}{3}\right) + 10 = 10 - 5\sqrt{3}$$

$$\text{b } \text{Period} = 2\pi \div \frac{\pi}{3} = 6 \text{seconds}$$

$$\text{c } \text{Greatest height} = 20 \text{ m}$$

$$\text{d } 10 \sin\left(\frac{\pi t}{3}\right) + 10 = 15$$

$$10 \sin\left(\frac{\pi t}{3}\right) = 5$$

$$\sin\left(\frac{\pi t}{3}\right) = \frac{1}{2}$$

$$\frac{\pi t}{3} = \frac{\pi}{6}, \frac{5\pi}{6}, \frac{13\pi}{6}, \frac{17\pi}{6} \dots$$

$$t = \frac{1}{2}, \frac{5}{2}, \frac{13}{2}, \frac{17}{4}$$

$$\text{e } 10 \sin\left(\frac{\pi t}{3}\right) + 10 = 5$$

$$10 \sin\left(\frac{\pi t}{3}\right) = -5$$

$$\sin\left(\frac{\pi t}{3}\right) = -\frac{1}{2}$$

$$\frac{\pi t}{3} = \frac{7\pi}{6}, \frac{11\pi}{6}, \frac{19\pi}{6}, \frac{23\pi}{6} \dots$$

$$t = \frac{7}{2}, \frac{11}{2}, \frac{19}{2}, \frac{23}{2}$$

$$5 \quad T = 17 - 8 \cos\left(\frac{\pi t}{12}\right)$$

$$\text{a } T(0) = 17 - 8 \cos(0) = 9$$

The temperature was 9°C at midnight

$$\text{b } \text{Maximum temperature } 25^\circ$$

Minimum temperature 9°

c $17 - 8 \cos\left(\frac{\pi t}{12}\right) = 20$

$$-8 \cos\left(\frac{\pi t}{12}\right) = 3$$

$$\cos\left(\frac{\pi t}{12}\right) = -\frac{3}{8}$$

$$\frac{\pi t}{12} = \pi - \cos^{-1} \frac{3}{8}, \pi + \cos^{-1} \frac{3}{8}, \dots$$

$$t = 7.468 \dots, 16.53 \dots$$

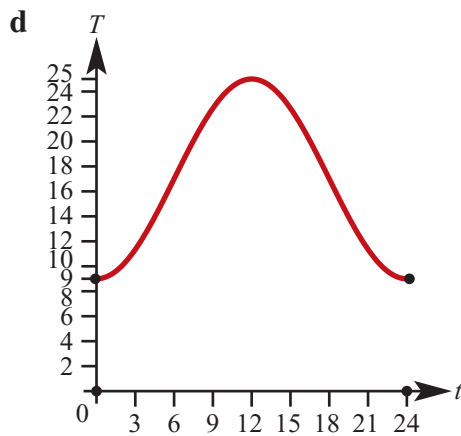

6 a $D(t) = 10 + 3 \sin\left(\frac{\pi t}{6}\right), 0 \leq t \leq 24$

period = $\frac{2\pi}{\frac{\pi}{6}} = 12$; amplitude = 3;

translation in the positive direction of the $D(t)$ -axis = 10

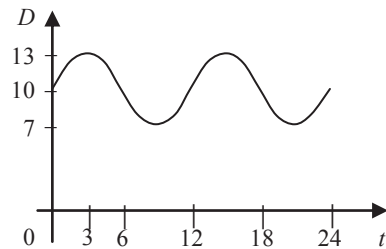

b When $D(t) = 8.5$, $10 + 3 \sin\left(\frac{\pi t}{6}\right) = 8.5$

$$\therefore 3 \sin\left(\frac{\pi t}{6}\right) = -1.5$$

$$\therefore \sin\left(\frac{\pi t}{6}\right) = -\frac{1}{2}$$

$$\therefore \frac{\pi t}{6} = \frac{7\pi}{6} \text{ or } \frac{11\pi}{6} \text{ or } \frac{19\pi}{6} \text{ or } \frac{23\pi}{6} \text{ or } \dots$$

$$\therefore t = 7 \text{ or } 11 \text{ or } 19 \text{ or } 23 \text{ or } \dots$$

From the graph, $D(t) \geq 8.5$ implies

$$0 \leq t \leq 7, \text{ or } 11 \leq t \leq 19, \text{ or } 23 \leq t \leq 24, \text{ for } 0 \leq t \leq 24$$

$$\therefore \{t: D(t) \geq 8.5\} = \{t: 0 \leq t \leq 7\} \cup \{t: 11 \leq t \leq 19\} \cup \{t: 23 \leq t \leq 24\}$$

c The maximum depth is 13 m.

From the graph, the required period of time is $[2.5, 3.5]$.

The largest value of w occurs for $t = 2.5$.

$$w = 10 + 3 \sin\left(\frac{2.5\pi}{6}\right) \approx 12.9$$

The largest value of w is 12.9, correct to 1 decimal place.

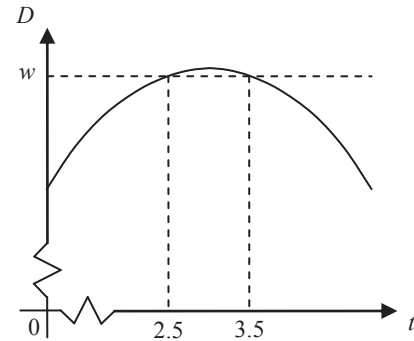

7 a period = 2×6 , and also period = $\frac{360}{r}$

$$\therefore \frac{360}{r} = 12 \quad \therefore r = 30$$

$$\text{translation parallel to } D\text{-axis} = \frac{7+3}{2} = 5$$

$$\therefore p = 5$$

$$\text{amplitude} = \frac{7-3}{2} = 2 \quad \therefore q = 2$$

b When $t = 0$, $D = 7$

When $t = 6$, $D = 3$

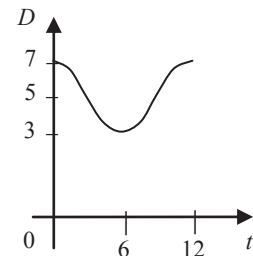

c $D = 5 + 2 \cos(30t)^\circ$

$$\text{When } D = 4, 5 + 2 \cos(30t)^\circ = 4$$

$$\therefore 2 \cos(30t)^\circ = -1 \quad \therefore \cos(30t)^\circ = -\frac{1}{2}$$

$$\therefore (30t)^\circ = 120^\circ \text{ or } 240^\circ$$

$$\therefore t = 4 \text{ or } 8 \text{ (from graph, only two values required)}$$

Low tide is at $t = 6$, hence it will be 2 hours before the ship can enter the harbour.

Solutions to Technology-free questions

$$1 \text{ a } 330^\circ = 330\left(\frac{\pi}{180}\right) = \frac{11\pi}{6}$$

$$\text{b } 810^\circ = 810\left(\frac{\pi}{180}\right) = \frac{9\pi}{2}$$

$$\text{c } 1080^\circ = 1080\left(\frac{\pi}{180}\right) = 6\pi$$

$$\text{d } 1035^\circ = 1035\left(\frac{\pi}{180}\right) = \frac{23\pi}{4}$$

$$\text{e } 135^\circ = 135\left(\frac{\pi}{180}\right) = \frac{3\pi}{4}$$

$$\text{f } 405^\circ = 405\left(\frac{\pi}{180}\right) = \frac{9\pi}{4}$$

$$\text{g } 390^\circ = 390\left(\frac{\pi}{180}\right) = \frac{13\pi}{6}$$

$$\text{h } 420^\circ = 420\left(\frac{\pi}{180}\right) = \frac{7\pi}{3}$$

$$\text{i } 80^\circ = 80\left(\frac{\pi}{180}\right) = \frac{4\pi}{9}$$

$$2 \text{ a } \frac{5\pi}{6} = \frac{5\pi}{6}\left(\frac{180^\circ}{\pi}\right) = 150^\circ$$

$$\text{b } \frac{7\pi}{4} = \frac{7\pi}{4}\left(\frac{180^\circ}{\pi}\right) = 315^\circ$$

$$\text{c } \frac{11\pi}{4} = \frac{11\pi}{4}\left(\frac{180^\circ}{\pi}\right) = 495^\circ$$

$$\text{d } \frac{3\pi}{12} = \frac{3\pi}{12}\left(\frac{180^\circ}{\pi}\right) = 45^\circ$$

$$\text{e } \frac{15\pi}{2} = \frac{15\pi}{2}\left(\frac{180^\circ}{\pi}\right) = 1350^\circ$$

$$\text{f } -\frac{3\pi}{4} = -\frac{3\pi}{4}\left(\frac{180^\circ}{\pi}\right) = -135^\circ$$

$$\text{g } -\frac{\pi}{4} = -\frac{\pi}{4}\left(\frac{180^\circ}{\pi}\right) = -45^\circ$$

$$\text{h } -\frac{11\pi}{4} = -\frac{11\pi}{4}\left(\frac{180^\circ}{\pi}\right) = -495^\circ$$

$$\text{i } -\frac{23\pi}{4} = -\frac{23\pi}{4}\left(\frac{180^\circ}{\pi}\right) = -1035^\circ$$

$$3 \text{ a } \sin \frac{11\pi}{4} = \sin \frac{3\pi}{4} = \frac{\sqrt{2}}{2}$$

$$\text{b } \cos\left(-\frac{7\pi}{4}\right) = \cos \frac{\pi}{4} = \frac{\sqrt{2}}{2}$$

$$\text{c } \sin \frac{11\pi}{6} = -\sin \frac{\pi}{6} = -\frac{1}{2}$$

$$\text{d } \cos\left(-\frac{7\pi}{6}\right) = \cos \frac{5\pi}{6} = -\frac{\sqrt{3}}{2}$$

$$\text{e } \cos\left(\frac{13\pi}{6}\right) = \cos \frac{\pi}{6} = \frac{\sqrt{3}}{2}$$

$$\text{f } \sin \frac{23\pi}{6} = -\sin \frac{\pi}{6} = -\frac{1}{2}$$

$$\text{g } \cos\left(-\frac{23\pi}{3}\right) = \cos \frac{\pi}{3} = \frac{1}{2}$$

$$\text{h } \sin\left(-\frac{17\pi}{4}\right) = -\sin \frac{\pi}{4} = -\frac{\sqrt{2}}{2}$$

$$4 \text{ a } 2 \sin\left(\frac{\theta}{2}\right)$$

$$\text{Ampl} = 2, \text{ per} = \frac{2\pi}{\frac{1}{2}} = 4\pi$$

$$\text{b } -3 \sin 4\theta$$

$$\text{Ampl} = 3, \text{ per} = \frac{2\pi}{4} = \frac{\pi}{2}$$

$$\text{c } \frac{1}{2} \sin 3\theta$$

$$\text{Ampl} = \frac{1}{2}, \text{ per} = \frac{2\pi}{3}$$

d $-3 \cos 2x$
 Ampl = 3, per = $\frac{2\pi}{2} = \pi$

e $-4 \sin\left(\frac{x}{3}\right)$
 Ampl = 4, per = $\frac{2\pi}{\frac{1}{3}} = 6\pi$

f $\frac{2}{3} \sin\left(\frac{2x}{3}\right)$
 Ampl = $\frac{2}{3}$, per = $\frac{2\pi}{\frac{2}{3}} = 3\pi$

5 a $y = 2 \sin 2x$
 Per = π , ampl = 2, x -intercepts
 at $0, \frac{\pi}{2}, \pi$

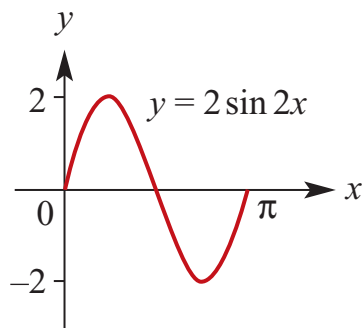

b $y = -3 \cos\left(\frac{x}{3}\right)$
 Per = 6π , ampl = 3, x -intercepts
 at $\frac{3\pi}{2}, \frac{9\pi}{2}$

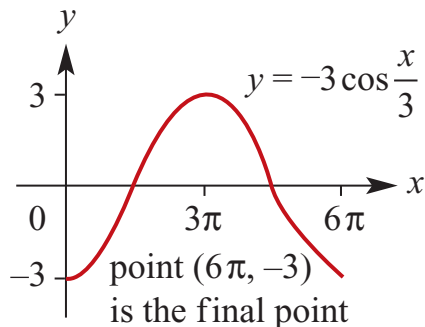

c $y = -2 \sin 3x$
 Per = $\frac{2\pi}{3}$, ampl = 2, x -intercepts

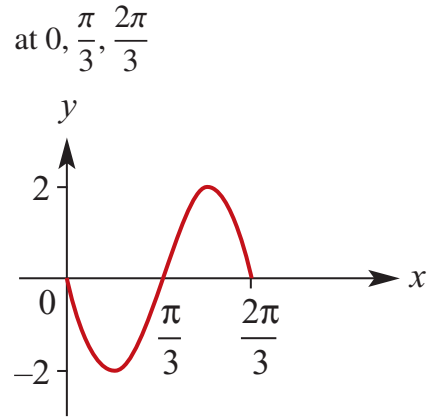

d $y = 2 \sin\left(\frac{x}{3}\right)$
 Per = 6π , ampl = 2, x -intercepts
 at $0, 3\pi, 6\pi$

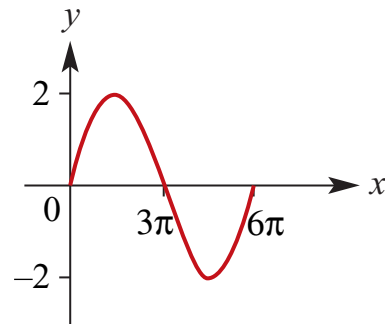

e $y = \sin\left(x - \frac{\pi}{4}\right)$
 Per = 2π , ampl = 1, x -intercepts
 at $\frac{\pi}{4}, \frac{5\pi}{4}$

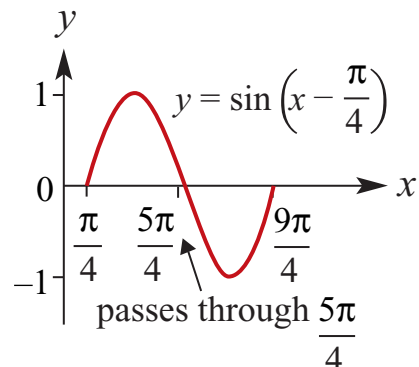

f $y = \sin\left(x + \frac{2\pi}{3}\right)$
 Per = 2π , ampl = 1, x -intercepts
 at $\frac{\pi}{3}, \frac{4\pi}{3}$

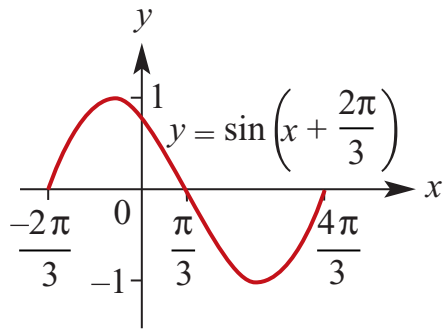

g $y = 2 \cos\left(x - \frac{5\pi}{6}\right)$
 Per = 2π , ampl = 2, x -intercepts
 at $\frac{\pi}{3}, \frac{4\pi}{3}$

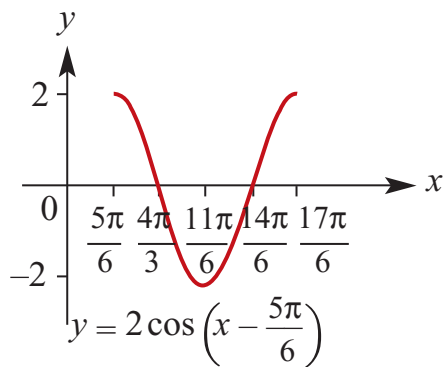

h $y = -3 \cos\left(x + \frac{\pi}{6}\right)$
 Per = 2π , ampl = 3, x -intercepts
 at $\frac{\pi}{3}, \frac{4\pi}{3}$

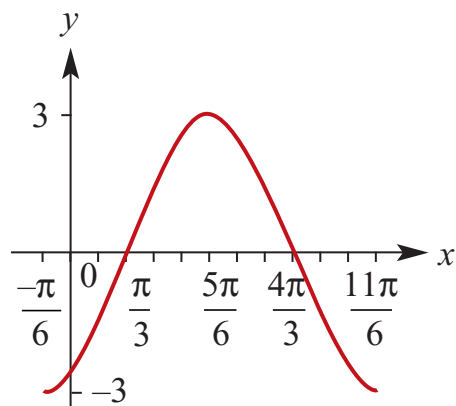

6 a $\sin \theta = -\frac{\sqrt{3}}{2}, \therefore \theta = -\frac{2\pi}{3}, -\frac{\pi}{3}$
 (No solutions over $[0, \pi]$)

b $\sin(2\theta) = -\frac{\sqrt{3}}{2}$
 $\therefore 2\theta = -\frac{2\pi}{3}, -\frac{\pi}{3}, \frac{4\pi}{3}, \frac{5\pi}{3}$
 $\theta = -\frac{\pi}{3}, -\frac{\pi}{6}, \frac{2\pi}{3}, \frac{5\pi}{6}$

c $\sin\left(\theta - \frac{\pi}{3}\right) = -\frac{1}{2}$
 $\therefore \theta - \frac{\pi}{3} = -\frac{\pi}{6}, \frac{7\pi}{6}$
 $\theta = \frac{\pi}{6}, \frac{3\pi}{2}$

d $\sin\left(\theta + \frac{\pi}{3}\right) = -1$
 $\therefore \theta + \frac{\pi}{3} = \frac{3\pi}{2}$
 $\theta = \frac{7\pi}{6}$
 (Only 1 solution for -1 and 1)

e $\sin\left(\frac{\pi}{3} - \theta\right) = -\frac{1}{2}$
 $\therefore \frac{\pi}{3} - \theta = -\frac{\pi}{6}, -\frac{5\pi}{6}$
 $-\theta = -\frac{\pi}{2}, -\frac{7\pi}{6}$
 $\theta = \frac{\pi}{2}, \frac{7\pi}{6}$

Solutions to multiple-choice questions

1 C $\sin^{-1}\left(\frac{3}{5}\right) \approx 37^\circ$

2 D $3 - 10 \cos 2x$ has range
 $[3 - 10, 3 + 10]$.

So the minimum value is $3 - 10$

3 E $4 \sin\left(2x - \frac{\pi}{2}\right)$ has range $[-4, 4]$.

4 C $3 \sin\left(\frac{x}{2} - \pi\right) + 4$ has per = $\frac{2\pi}{\frac{1}{2}} = 4\pi$

5 E $y = \sin x$:
 Dilation of $\frac{1}{2}$ from y -axis:
 $y = \sin 2x$
 Translated $+\frac{\pi}{4}$ units in x -axis:
 $y = \sin 2\left(x - \frac{\pi}{4}\right)$

6 D $f(x) = a \sin(bx) + c$: per = $\frac{2\pi}{b}$

7 E $y = \tan ax$ has vertical asymptotes at
 $y = \pm \frac{\pi}{2a}$
 If $\frac{\pi}{2a} = \frac{\pi}{6}$, then a could be 3

8 E $3 \sin x + 1 = b$
 If $b > 0$ the only value of b possible
 is 4, since the only positive value of
 y for $\sin x$ with one solution over a
 period is 1.
 $3 \sin x + 1 = 4, \therefore \sin x = 1$

9 C $b = a \sin x, x \in [-2\pi, 2\pi], a > b > 0$
 2 periods, each with 2 solutions = 4

10 B $D(t) = 8 + 2 \sin\left(\frac{\pi t}{6}\right), 0 \leq t \leq 24$
 Find primary solution for $D = 9$:
 $8 + 2 \sin \frac{\pi t}{6} = 9$
 $\sin \frac{\pi t}{6} = \frac{1}{2}$
 $\frac{\pi t}{6} = \frac{\pi}{6}$
 $\therefore t = 1$

Solutions to extended-response questions

1 a i When $t = 5.7$, $d = 12 + 12 \cos \frac{1}{6}\pi\left(5.7 + \frac{1}{3}\right)$
 $= 0.001\ 83 = 1.83 \times 10^{-3}$ hours

ii When $t = 2.7$, $d = 12 + 12 \cos \frac{1}{6}\pi\left(2.7 + \frac{1}{3}\right)$
 $= 11.79$ hours

b When $d = 5$, $12 + 12 \cos \frac{1}{6}\pi\left(t + \frac{1}{3}\right) = 5$

$\therefore 12 \cos \frac{1}{6}\pi\left(t + \frac{1}{3}\right) = -7$

$\therefore \cos \frac{1}{6}\pi\left(t + \frac{1}{3}\right) = -\frac{7}{12}$

$\therefore \frac{1}{6}\pi\left(t + \frac{1}{3}\right) = 2.193\ 622\ 912, 4.089\ 562\ 395$
 (first two positive values required)

$\therefore t = \frac{2.193\ 622\ 912 \times 6}{\pi} - \frac{1}{3}, \frac{4.089\ 562\ 395 \times 6}{\pi} - \frac{1}{3}$

$\therefore t = 3.856, 7.477$

When $t = 3.856$, the date is 26 April. When $t = 7.477$, the date is 14 August.

2 a When $t = 4$, $A = 21 - 3 \cos\left(\frac{4\pi}{12}\right) = 19.5$

The temperature inside the house is 19.5°C at 8 am.

b $D = A - B = 21 - 3 \cos\left(\frac{\pi t}{12}\right) - \left(22 - 5 \cos\left(\frac{\pi t}{12}\right)\right)$

$= 21 - 3 \cos\left(\frac{\pi t}{12}\right) - 22 + 5 \cos\left(\frac{\pi t}{12}\right)$

$\therefore D = 2 \cos\left(\frac{\pi t}{12}\right) - 1, 0 \leq t \leq 24$

c amplitude = 2,

translation in positive direction of D -axis = -1 ,

period = $\frac{2\pi}{\frac{\pi}{12}} = 24$

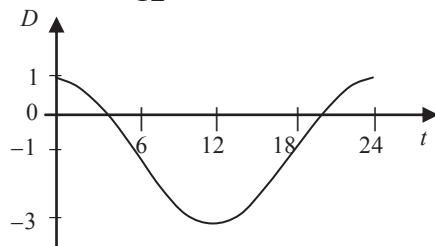

d When $A < B$, $D < 0$

$$\text{When } D = 0, \quad 2 \cos\left(\frac{\pi t}{12}\right) - 1 = 0$$

$$\therefore \cos\left(\frac{\pi t}{12}\right) = \frac{1}{2}$$

$$\therefore \frac{\pi t}{12} = \frac{\pi}{3} \text{ or } \frac{5\pi}{3} \text{ or } \dots$$

$$\therefore t = 4 \text{ or } 20 \text{ for } t \in [0, 24]$$

When $D < 0$, $4 < t < 20$

$$\therefore \{t: A < B\} = \{t: 4 < t < 20\}$$

3 a $d = 3 + 1.8 \cos\left(\frac{\pi t}{6}\right)$

$$\text{amplitude} = 1.8; \text{ period} = 2\pi \div \frac{\pi}{6} = 12$$

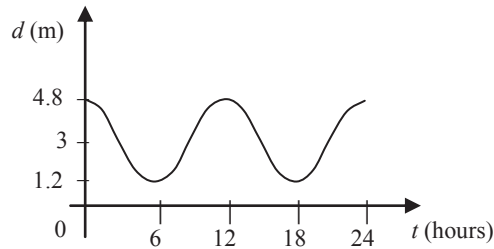

b High tides occur when $t = 0, t = 12$ and $t = 24$, i.e. at 3 am, 3 pm and 3 am.

c Low tides occur when $t = 6$ and $t = 18$, i.e. at 9 am and 9 pm.

d The ferry operates from $t = 5$ to $t = 17$.

$$\text{Consider } 3 + 1.8 \cos\left(\frac{\pi t}{6}\right) = 2$$

$$\therefore \cos\left(\frac{\pi t}{6}\right) = \frac{-1}{1.8} = \frac{-5}{9}$$

$$\therefore \frac{\pi t}{6} = \pi - \cos^{-1}\left(\frac{5}{9}\right), \pi + \cos^{-1}\left(\frac{5}{9}\right), 3\pi - \cos^{-1}\left(\frac{5}{9}\right), 3\pi + \cos^{-1}\left(\frac{5}{9}\right)$$

$$t = 6 - \frac{6}{\pi} \cos^{-1}\left(\frac{5}{9}\right), 6 + \frac{6}{\pi} \cos^{-1}\left(\frac{5}{9}\right), 18 - \frac{6}{\pi} \cos^{-1}\left(\frac{5}{9}\right) \text{ or } 18 + \frac{6}{\pi} \cos^{-1}\left(\frac{5}{9}\right)$$

$$\approx 4.125 \text{ or } 7.875 \text{ or } 16.125 \text{ or } 19.875$$

$$\therefore \text{earliest time, } 7.875 - \frac{50}{60} = 7.04$$

\therefore ferry can leave Main Beach at 10.03 am.

- e i Ferry must be in and out harbour by $t = 16.125$. It must leave 55 minutes earlier, i.e. at $t = 15.208\dots$. It can leave Main Beach no later than 6.12 pm.
- ii Starts at 10.03 am and last trip leaves at 6.12 pm. Five trips are possible.

4 $D = p - 2 \cos(rt)$

- a Low tide depth is 2 m. High tide is 8 hours later, and the depth is 6 m.

period is 16 $\therefore \frac{2\pi}{r} = 16$

$\therefore r = \frac{\pi}{8}$

The centre is 4, as the upper value is 6 and the lower value is 2, $\therefore p = 4$.

The amplitude is 2.

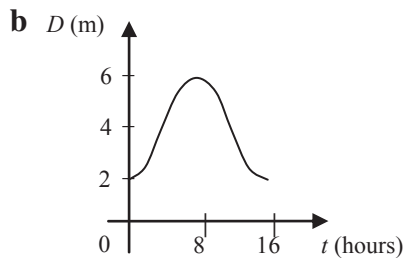

- c The first low tide is at 4 am. The second low tide will be at 8 pm.
- d The depth is equal to 4 metres when $t = 4$ and $t = 12$, i.e. at 8 am and 4 pm.
- e i $7.5 - 6 = 1.5$ metres

- ii At 2 pm, $t = 10$, and the depth is 5.414... metres.

$$7.5 - 5.414\dots = 2.085\dots$$

The length of pole exposed = 2.086 m.

- f When $d = 3.5$, $t = 3.356\dots$: by symmetry,
total time = 6.713... = 6 hours 42 minutes 47 seconds

$$\begin{aligned} \therefore \text{time covered} &= 16 - 6.713 = 9.287 \\ &= 9 \text{ hours } 17 \text{ minutes} \end{aligned}$$

Chapter 15 – Revision of chapters 13–14

Solutions to Technology-free questions

$$1 \text{ a } (-2a^2)^3 \times 3a^4 = -8a^6 \times 3a^4 \\ = -24a^{10}$$

$$b \frac{5a^4 \times 2ab^2}{20a^2b^4} = \frac{10a^5b^2}{20a^2b^4} \\ = \frac{a^3}{2b^2}$$

$$c \frac{(xy^{-2})^{-1}}{y} \times \frac{3x^{-1}y^2}{4(xy)^3} = \frac{x^{-1}y^2}{y} \times \frac{3x^{-1}y^2}{4x^3y^3} \\ = \frac{3y^3}{4x^5y^3} \\ = \frac{3}{4x^5}$$

$$d \left(\frac{4a^2}{ab}\right)^3 \div (2ab^{-1})^3 = \left(\frac{64a^6}{a^3b^3}\right) \div (8a^3b^{-3}) \\ = \frac{64a^6}{a^3b^3} \times \frac{1}{8a^3b^{-3}} \\ = \frac{64a^6}{8a^6} \\ = 8$$

$$e \sqrt{x^{-1}y^2} \times \left(\frac{y}{x}\right)^{-\frac{1}{3}} = x^{-\frac{1}{2}}y \times y^{-\frac{1}{3}}x^{\frac{1}{3}} \\ = x^{-\frac{1}{6}}y^{\frac{2}{3}} \\ = \frac{y^{\frac{2}{3}}}{x^{\frac{1}{6}}}$$

$$f \sqrt{2x-1} \times (2x-1)^{-1} = (2x-1)^{\frac{1}{2}}(2x-1)^{-1} \\ = \frac{1}{(2x-1)^{\frac{1}{2}}}$$

$$2 \text{ a } \left(\frac{3}{5}\right)^{-2} = \left(\frac{5}{3}\right)^2 = \frac{25}{9}$$

$$b \left(\frac{4^2}{2^6}\right)^{-2} = \frac{4^{-4}}{2^{-12}} = \frac{2^{-8}}{2^{-12}} = 2^4 = 16$$

$$c \frac{27^2 \times 9^3}{81^2} = \frac{3^6 \times 3^6}{3^8} = 3^4 = 81$$

$$d (-27)^{-\frac{1}{3}} = \frac{1}{-27^{\frac{1}{3}}} = -\frac{1}{3}$$

$$3 \text{ a } \frac{9^{2n} \times 8^n \times 16^n}{6^n} = \frac{3^{4n} \times 2^{3n} \times 2^{4n}}{3^n 2^n} \\ = 2^{6n} 3^{3n}$$

$$b 3 \log_2(16) = 3 \times 4 = 12$$

$$c 2 \log_{10} 3 + \log_{10} 4 = \log_{10}(3^2 \times 4) \\ = \log_{10} 36$$

$$d \log_3\left(\frac{1}{27}\right) = \log_3(3^{-3}) = -3$$

$$4 \text{ a } f: \mathbb{R} \rightarrow \mathbb{R}, f(x) = 2^x - 3 \text{ Range} \\ (-3, \infty)$$

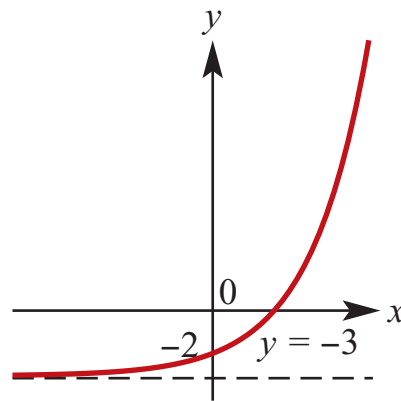

$$b f: \mathbb{R} \rightarrow \mathbb{R}, f(x) = -3 \times 2^x + 1 \\ \text{Range } (-\infty, 1)$$

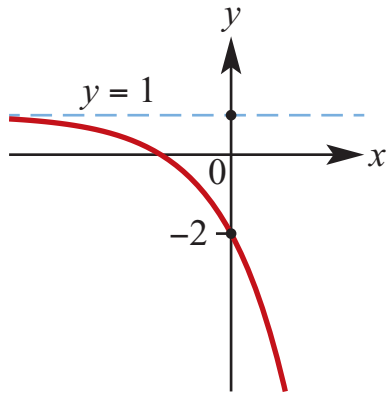

5 a $4^x = 8^{x-1}$

$$2^{2x} = 2^{3x-3}$$

$$2x = 3x - 3$$

$$x = 3$$

b $4^x = 5 \times 2^x - 4$

$$2^{2x} - 5 \times 2^x + 4 = 0$$

$$(2^x - 4)(2^x - 1) = 0$$

$$x = 2 \text{ or } x = 0$$

c $5^{x-1} > 125$

$$\Leftrightarrow 5^{x-1} > 5^3$$

$$\Leftrightarrow x - 1 > 3$$

$$\Leftrightarrow x > 4$$

d $\log_2(x+1) = 3$

$$x + 1 = 2^3$$

$$x = 7$$

e $\log_4(2x) - \log_4(x+1) = 0$

$$\log_4 \frac{2x}{x+1} = 0$$

$$\frac{2x}{x+1} = 4^0$$

$$2x = x + 1$$

$$x = 1$$

6 a $2^x = 5 \Leftrightarrow x = \log_2(5)$

b $5^{3x+1} = 10$

$$5^{3x} = 2$$

$$3x = \log_5(2)$$

$$x = \frac{1}{3} \log_5(2)$$

c $0.6^x < 0.2$

$$\Leftrightarrow x \log_{10}(0.6) < \log_{10} 0.2$$

$$\Leftrightarrow x > \frac{\log_{10} 0.2}{\log_{10}(0.6)}$$

7 $f(f^{-1}(x)) = x$

$$3^{f^{-1}(x)} + 2 = x$$

$$3^{f^{-1}(x)} = x - 2$$

$$f^{-1}(x) = \log_3(x - 2)$$

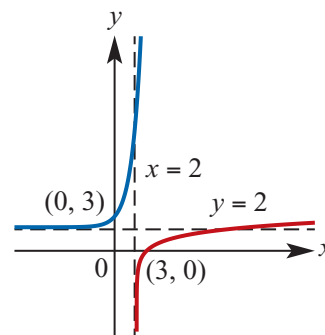

8 a $60^\circ = 60 \times \frac{\pi}{180} \text{ radians} = \frac{\pi}{3} \text{ radians}$

b $270^\circ = \frac{3\pi}{2} \text{ radians}$

c $140^\circ = 140 \times \frac{\pi}{180} \text{ radians} = \frac{7\pi}{9} \text{ radians}$

9 a $\sin\left(-\frac{\pi}{2}\right) = -1$

b $\cos\left(\frac{3\pi}{2}\right) = 0$

c $\tan(3\pi) = 0$

d $\tan\left(-\frac{\pi}{2}\right)$ undefined

10 a $\tan \theta = \frac{2}{5}$
 $\theta \approx 21.8^\circ$

b $x = 4 \cos 40^\circ \approx 3.06$

c $\frac{6}{x} = \sin 37^\circ$
 $x = \frac{6}{\sin 37^\circ} \approx 9.97$

11 a $\sin(2\pi - \theta) = -\sin \theta = -0.3$

b $\cos(-\theta) = \cos \theta = -0.5$

c $\tan(\pi + \theta) = \tan \theta = 1.6$

d $\sin(\pi + \theta) = -\sin \theta = -0.6$

e $\sin\left(\frac{\pi}{2} - \theta\right) = \cos \theta = 0.1$

f $\cos \theta = \sqrt{1 - \left(\frac{3}{5}\right)^2} = \frac{4}{5}$ (since
 $0 < \theta < \frac{\pi}{2}$)

12 a $\sin\left(\frac{2\pi}{3}\right) = \frac{\sqrt{3}}{2}$

b $\cos\left(\frac{5\pi}{6}\right) = -\frac{\sqrt{3}}{2}$

c $\tan\left(\frac{-\pi}{4}\right) = -1$

d $\sin\left(\frac{-7\pi}{6}\right) = \frac{1}{2}$

e $\cos\left(\frac{-7\pi}{4}\right) = \frac{1}{\sqrt{2}}$

f $\tan\left(\frac{5\pi}{3}\right) = -\sqrt{3}$

13 $f(x) = 2 \cos\left(\frac{x}{2}\right)$.

a Period = 4π ; Amplitude = 2

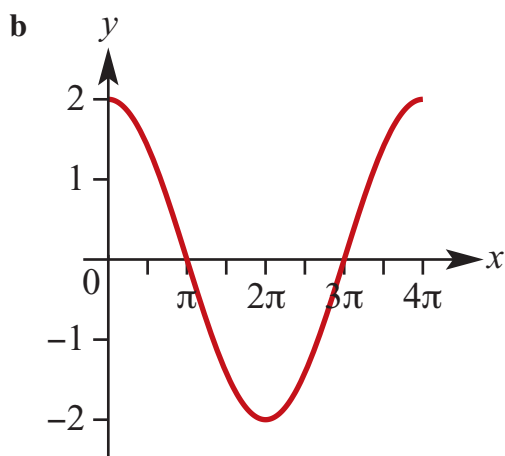

c Dilation of factor 2 from the x -axis and dilation of factor 2 from the y -axis

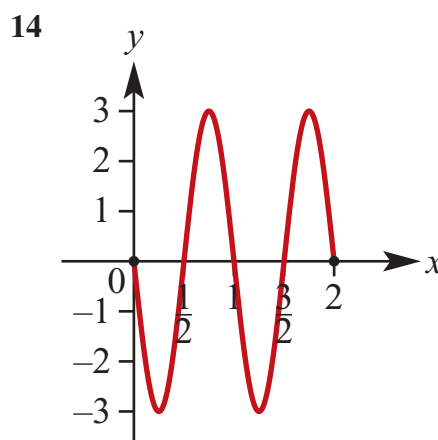

15 a $\cos \theta = -\frac{\sqrt{3}}{2}$
 $\theta = -\frac{5\pi}{6}, -\frac{7\pi}{6}, \frac{5\pi}{6}, \frac{7\pi}{6}$

b $\sqrt{2} \sin \theta = 1$

$$\sin \theta = \frac{1}{\sqrt{2}}$$

$$\theta = -\frac{7\pi}{4}, -\frac{5\pi}{4}, \frac{\pi}{4}, \frac{3\pi}{4}$$

c

$$\sin(2\theta) = -\frac{1}{2}$$

$$2\theta = -\frac{17\pi}{6}, -\frac{13\pi}{6}, -\frac{5\pi}{6}, -\frac{\pi}{6}, \frac{7\pi}{6}, \frac{11\pi}{6}, \frac{19\pi}{6}, \frac{23\pi}{6}$$

$$\theta = -\frac{17\pi}{12}, -\frac{13\pi}{12}, -\frac{5\pi}{12}, -\frac{\pi}{12}, \frac{7\pi}{12}, \frac{11\pi}{12}, \frac{19\pi}{12}, \frac{23\pi}{12}$$

d $\tan \theta = -\sqrt{3}$

$$\theta = -\frac{4\pi}{3}, -\frac{\pi}{3}, \frac{2\pi}{3}, \frac{5\pi}{3}$$

17

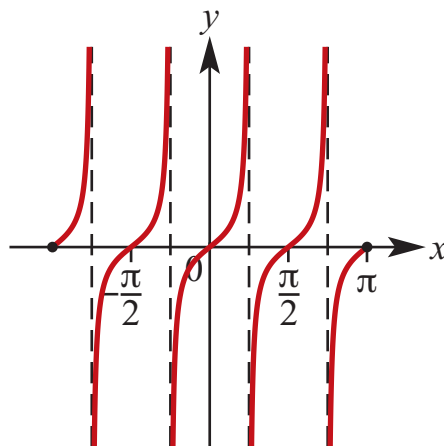

16

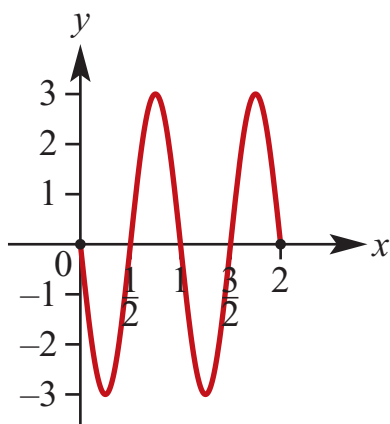

18 a

$$\sin x = \frac{1}{2}$$

$$x = \frac{\pi}{6} + 2k\pi \text{ or } x = \frac{5\pi}{6} + 2k\pi, k \in \mathbb{Z}$$

b

$$2 \cos x = \sqrt{3}$$

$$\cos x = \frac{\sqrt{3}}{2}$$

$$x = \frac{\pi}{6} + 2k\pi \text{ or } x = -\frac{\pi}{6} + 2k\pi, k \in \mathbb{Z}$$

c $\tan(2x) = -1$

$$2x = -\frac{\pi}{4} + k\pi$$

$$x = -\frac{\pi}{8} + k\frac{\pi}{2}, k \in \mathbb{Z}$$

Solutions to multiple-choice questions

$$\begin{aligned} 1 \text{ B } \log_a 8 = 3, \therefore a^3 &= 8 \\ a &= 2 \end{aligned}$$

$$\begin{aligned} 2 \text{ B } 5^{n-1}5^{n+1} &= 5^{n-1+n+1} \\ &= 5^{2n} \end{aligned}$$

$$\begin{aligned} 3 \text{ B } 2^x &= \frac{1}{64}, \therefore 2^x = 2^{-6} \\ \therefore x &= -6 \end{aligned}$$

$$\begin{aligned} 4 \text{ E } 125^a 5^b &= 5^{3a} 5^b \\ &= 5^{3a+b} \end{aligned}$$

$$\begin{aligned} 5 \text{ D } 4^x &= 10 - 4^{x+1} \\ \therefore 4^x + 4^{x+1} &= 10 \\ 4^x(1 + 4) &= 10 \\ 5(4^x) &= 10 \\ 4^x &= 2 = 4^{0.5} \\ \therefore x &= 0.5 \end{aligned}$$

$$\begin{aligned} 6 \text{ A } \frac{7^{n+2} - 35(7^{n+1})}{44(7^{n+2})} &= \frac{7^{n+2} - 5(7^n)}{44(7^{n+2})} \\ &= \frac{7^n(49 - 5)}{44(7^{n+2})} \\ &= \frac{7^n}{7^{n+2}} = \frac{1}{49} \end{aligned}$$

$$\begin{aligned} 7 \text{ D } f(x) &= 2 + 3^x \\ \therefore f(2x) - f(x) &= (2 + 3^{2x}) - (2 + 3^x) \\ &= 3^{2x} - 3^x \\ &= 3^x(3^x - 1) \end{aligned}$$

$$\begin{aligned} 8 \text{ C } (7^{2x})(49^{2x-1}) &= 1 \\ \therefore 7^{2x}7^{4x-2} &= 1 \\ 7^{6x-2} &= 1 = 7^0 \\ \therefore 6x - 2 &= 0, \therefore x = \frac{1}{3} \end{aligned}$$

$$\begin{aligned} 9 \text{ B } y &= 2^x \text{ and; } y = \left(\frac{1}{2}\right)^x \\ \text{y-intercept at } &(0, 1) \end{aligned}$$

$$\begin{aligned} 10 \text{ A } f(x) &= (2x)^0 + x^{-\frac{2}{3}} \\ &= 1 + x^{-\frac{2}{3}} \\ \therefore f(8) &= 1 + 8^{-\frac{2}{3}} \\ &= 1 + \frac{1}{4} = \frac{5}{4} \end{aligned}$$

$$\begin{aligned} 11 \text{ A } \log a^2 + \log b^2 - 2 \log ab \\ &= \log \frac{(a^2b^2)}{(ab)^2} \\ &= \log 1 = 0 \end{aligned}$$

$$\begin{aligned} 12 \text{ D } 2x &= 2x\left(\frac{180}{\pi}\right)^\circ \\ &= \left(\frac{360x}{\pi}\right)^\circ \\ &= \frac{360x^\circ}{\pi} \end{aligned}$$

$$\begin{aligned} 13 \text{ A } y &= \sin 2x + 1 \\ \text{Q is at the 1st maximum:} \\ x &= \frac{\pi}{4}, y = \sin \frac{\pi}{2} + 1 = 2 \end{aligned}$$

$$\begin{aligned} 14 \text{ D } 1 - 3 \cos \theta \\ \text{range} &= [1 - 3, 1 + 3] = [-2, 4], \\ \text{so min value} &= -2 \end{aligned}$$

$$\begin{aligned} 15 \text{ D } y &= 16 + 15 \sin \frac{\pi x}{60} \\ \therefore y(10) &= 16 + 15 \sin \frac{10\pi}{60} \\ &= 16 + \frac{15}{2} \\ &= 23.5 \text{ m} \end{aligned}$$

$$\begin{aligned} 16 \text{ D } \sin(\pi + \theta) + \cos(\pi + \theta) \\ &= -\sin \theta - \cos \theta \end{aligned}$$

17 A $\sin x = 0, \therefore x = 0, \pi$
 Over $[0, \pi]$, **B, C, E** have 1 solution
 and **D** has none.

18 E $y = \sin \frac{\theta}{2}$ has per = 4π

19 D $2 - 3 \sin \theta$
 range = $[2 - 3, 2 + 3] = [-1, 5]$

20 D $y = \cos x^\circ$ with translation of 30° in
 negative x direction
 $\therefore y = \cos(x + 30)^\circ$

21 E $f(x) = -2 \cos 3x$:
 per $\frac{2\pi}{3}$, ampl 2

22 A $C^d = 3$
 $\therefore C^{4d} - 5 = 3^4 - 5$
 $= 76$

23 E $\log_2 56 - \log_2 7 + \log_2 2$
 $= \log_2 \left(\frac{56 \times 2}{7} \right)$
 $= \log_2 16$
 $= 4$

24 B $\log_b a = c; \log_x b = c$

$$\therefore a = b^c, b = x^c$$

$$\therefore \log_a b = c \log_a x$$

$$\therefore \log_a x = \frac{1}{c} \log_a b = \frac{1}{c^2} \log_a b^c$$

$$\therefore \log_a x = \frac{1}{c^2} \log_a a = \frac{1}{c^2}$$

25 D $\cos \theta - \sin \theta = \frac{1}{4}$

$$\therefore (\cos \theta - \sin \theta)^2 = \frac{1}{16}$$

$$\sin^2 \theta + \cos^2 \theta - 2 \sin \theta \cos \theta = \frac{1}{16}$$

$$1 - 2 \sin \theta \cos \theta = \frac{1}{16}$$

$$2 \sin \theta \cos \theta = 1 - \frac{1}{16}$$

$$\therefore \sin \theta \cos \theta = \frac{15}{32}$$

26 B $y = \frac{1}{2} \sin 2x$ and $y = \frac{1}{2}$ meet at

$$\sin 2x = 1$$

$$\therefore 2x = \frac{\pi}{2}, \frac{5\pi}{2} \dots$$

$$x = \frac{\pi}{4}, \frac{5\pi}{4} \dots$$

Solutions to extended-response questions

1 a $h(t) = 10 + 4 \sin(15t)^\circ$, $0 \leq t \leq 24$

period = $\frac{360}{15} = 24$, amplitude = 4

translation of 10 units in the positive direction of the h -axis

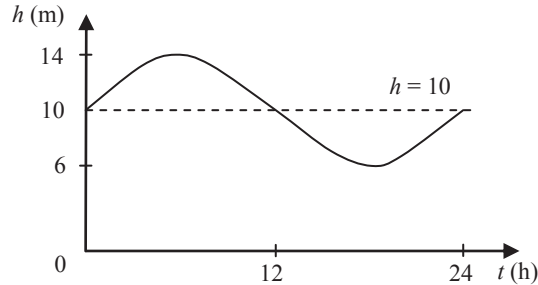

b When $h = 13$, $10 + 4 \sin(15t) = 13$

$$\therefore 4 \sin(15t) = 3 \qquad \therefore \sin(15t) = \frac{3}{4}$$

$$\therefore 15t = \sin^{-1}\left(\frac{3}{4}\right) \qquad \text{or} \qquad 15t = 180 - \sin^{-1}\left(\frac{3}{4}\right)$$

$$\text{and} \qquad t = \frac{1}{15} \sin^{-1}\left(\frac{3}{4}\right) \qquad \text{or} \qquad t = \frac{1}{15} \left(180 - \sin^{-1}\left(\frac{3}{4}\right)\right)$$

From the graph it can be seen that only two solutions are required.

$$\therefore t \approx \frac{1}{15}(48.5904) \qquad \text{or} \qquad t \approx \frac{1}{15}(180 - 48.5904)$$

$$\approx 3.2394 \qquad \qquad \qquad \approx 8.7606$$

Hence, $h = 13$ after approximately 3.2394 hours and 8.7606 hours.

c When $h = 11$, $10 + 4 \sin(15t) = 11$

$$\therefore 4 \sin(15t) = 1 \qquad \therefore \sin(15t) = \frac{1}{4}$$

$$\therefore 15t = \sin^{-1}(0.25) \qquad \text{or} \qquad 15t = 180 - \sin^{-1}(0.25)$$

$$\text{and} \qquad t = \frac{1}{15} \sin^{-1}(0.25) \qquad \text{or} \qquad t = \frac{1}{15} (180 - \sin^{-1}(0.25))$$

From the graph only two solutions are required for the domain $0 \leq t \leq 24$.

$$\therefore t \approx \frac{1}{15}(14.4775) \qquad \text{or} \qquad t \approx \frac{1}{15}(180 - 14.4775)$$

$$\approx 0.9652 \qquad \qquad \qquad \approx 11.0348$$

For $h \geq 11$, $0.9652 \leq t \leq 11.0348$ (approximately).

Hence a boat can leave the harbour between 0.9652 hours and 11.0348 hours.

2 a At the start of the experiment, $t = 0$.

$$\begin{aligned}\therefore N(0) &= 40 \times 2^{1.5(0)} \\ &= 40 \times 2^0 \\ &= 40 \times 1 = 40\end{aligned}$$

Hence there are 40 bacteria present at the start of the experiment.

b i When $t = 2$, $N(2) = 40 \times 2^{1.5(2)}$

$$\begin{aligned}&= 40 \times 2^3 \\ &= 40 \times 8 \\ &= 320\end{aligned}$$

After 2 hours, there are 320 bacteria present.

ii When $t = 4$, $N(4) = 40 \times 2^{1.5(4)}$

$$\begin{aligned}&= 40 \times 2^6 \\ &= 40 \times 64 \\ &= 2560\end{aligned}$$

After 4 hours, there are 2560 bacteria present.

iii When $t = 12$, $N(12) = 40 \times 2^{1.5(12)}$

$$\begin{aligned}&= 40 \times 2^{18} \\ &= 40 \times 262\,144 \\ &= 10\,485\,760\end{aligned}$$

After 12 hours, there are 10 485 760 bacteria present.

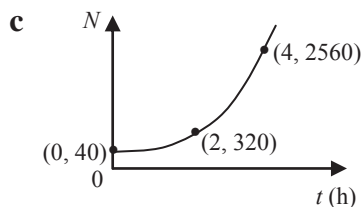

d When $N = 80$, $80 = 40 \times 2^{1.5(t)}$

$$\begin{aligned}\therefore 2^{1.5(t)} &= 2^1 \\ \therefore 1.5t &= 1 \\ \therefore t &= \frac{2}{3}\end{aligned}$$

The number of bacteria doubles after $\frac{2}{3}$ of an hour (40 minutes).

3 a The Ferris wheel makes one revolution after one period.

$$\begin{aligned} \text{Period} &= \frac{2\pi}{n}, \text{ where } n = \frac{\pi}{30} \\ &= 2\pi \div \frac{\pi}{30} \\ &= \frac{2\pi \times 30}{\pi} \\ &= 60 \end{aligned}$$

i.e. the Ferris wheel takes 60 seconds for one revolution.

b Period = 60, amplitude = 9

The graph is translated 10 units in the positive direction of the t -axis and 11 units in the positive direction of the h -axis.

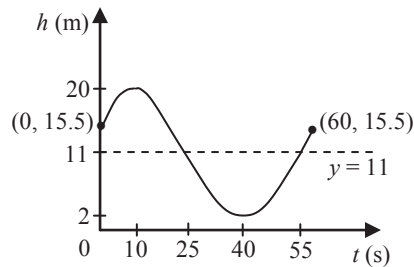

c Range = [2, 20]

d At $h = 2$, $11 + 9 \cos\left(\frac{\pi}{30}(t - 10)\right) = 2$

$$\therefore 9 \cos\left(\frac{\pi}{30}(t - 10)\right) = -9$$

$$\therefore \cos\left(\frac{\pi}{30}(t - 10)\right) = -1$$

$$\therefore \frac{\pi}{30}(t - 10) = \pi \text{ or } 3\pi \text{ or } 5\pi \text{ or } \dots$$

$$\therefore t - 10 = 30 \text{ or } 90 \text{ or } 150 \text{ or } \dots$$

$$\therefore t = 40 \text{ or } 100 \text{ or } 160 \text{ or } \dots$$

i.e. the height of the person above the ground is 2 m after 40 seconds and then again after each further 60 seconds.

e At $h = 15.5$, $11 + 9 \cos\left(\frac{\pi}{30}(t - 10)\right) = 15.5$

$\therefore 9 \cos\left(\frac{\pi}{30}(t - 10)\right) = 4.5$

$\therefore \cos\left(\frac{\pi}{30}(t - 10)\right) = \frac{1}{2}$

$\therefore \frac{\pi}{30}(t - 10) = \frac{-\pi}{3} \text{ or } \frac{\pi}{3} \text{ or } \frac{5\pi}{3} \text{ or } \frac{7\pi}{3} \text{ or } \dots$

$\therefore t - 10 = -10 \text{ or } 20 \text{ or } 50 \text{ or } 70 \text{ or } \dots$

$\therefore t = 0 \text{ or } 20 \text{ or } 60 \text{ or } 80 \text{ or } \dots$

i.e. the height of the person above the ground is 15.5 m at the start and each 60 seconds thereafter, and also at 20 seconds and each 60 seconds after that.

4 a $V = 120 \cos(60\pi t)$, period = $\frac{2\pi}{60\pi} = \frac{1}{30}$, amplitude = 120

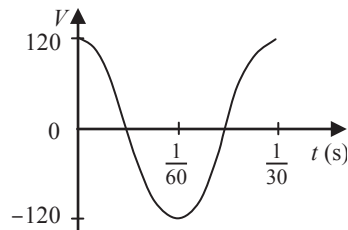

b At $V = 60$, $120 \cos(60\pi t) = 60$

$\therefore \cos(60\pi t) = \frac{1}{2}$

$\therefore 60\pi t = \frac{\pi}{3}$ (Only smallest positive solution is required.)

$\therefore t = \frac{\pi}{3 \times 60\pi}$

$= \frac{1}{180}$

i.e. the first time the voltage is 60 is at $\frac{1}{180}$ second.

c The voltage is maximised when $V = 120$

$\therefore 120 \cos(60\pi t) = 120$

$\therefore \cos(60\pi t) = 1$

$\therefore 60\pi t = 0 \text{ or } 2\pi \text{ or } 4\pi \text{ or } \dots$

$\therefore t = \frac{0}{60\pi} \text{ or } \frac{2\pi}{60\pi} \text{ or } \frac{4\pi}{60\pi} \text{ or } \dots$

$= 0 \text{ or } \frac{1}{30} \text{ or } \frac{1}{15} \text{ or } \dots$

i.e. the voltage is maximised when $t = 0$ seconds, and every $\frac{1}{30}$ second thereafter
 $(t = \frac{k}{30}, k = 0, 1, 2, \dots)$.

5 $d = a + b \sin c(t - h)$

a i period = $\frac{60 \text{ seconds}}{4 \text{ revolutions}}$
 $= 15 \text{ seconds}$

ii amplitude = radius of waterwheel
 $= 3 \text{ metres}$

iii period = $\frac{2\pi}{c} = 15$
 $\therefore c = \frac{2\pi}{15}$

b At $(0, 0)$, $0 = a + b \sin\left(\frac{2\pi}{15}(0 - h)\right)$

Now amplitude = 3, $\therefore b = 3$
and the translation in the positive direction of the y-axis is 2,

$\therefore a = 2$

$\therefore 0 = 2 + 3 \sin \frac{-2\pi h}{15}$

$\therefore 3 \sin \frac{-2\pi h}{15} = -2$

$\therefore \sin \frac{-2\pi h}{15} = \frac{-2}{3}$

$\therefore \frac{-2\pi h}{15} \approx -0.729\ 727\ 656$

$\therefore h \approx \frac{-0.729\ 727\ 656 \times 15}{-2\pi}$

$\approx 1.742\ 10$

$$\text{c } d = 2 + 3 \sin\left(\frac{2\pi}{15}(t - 1.74210)\right)$$

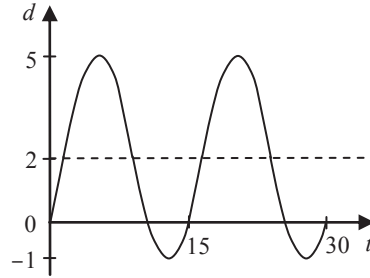

$$\begin{aligned} \text{6 a i } \text{When } t = 0, \quad h &= 30(1.65)^0 \\ &= 30 \times 1 \\ &= 30 \end{aligned}$$

$$\begin{aligned} \text{ii } \text{When } t = 1, \quad h &= 30(1.65)^1 \\ &= 30 \times 1.65 \\ &= 49.5 \end{aligned}$$

$$\begin{aligned} \text{iii } \text{When } t = 2, \quad h &= 30(1.65)^2 \\ &= 30 \times 2.7225 \\ &= 81.675 \end{aligned}$$

$$\begin{aligned} \text{b} \quad h(N) &= 30(1.65)^N \\ h(N + 1) &= 30(1.65)^{N+1} \\ &= 30(1.65)^N \times 1.65 \\ &= 1.65h(N) \end{aligned}$$

$$\therefore h(N + 1) = kh(N)$$

$$\text{implies } k = 1.65$$

$$\text{c } \text{When } h = 900, \quad 30(1.65)^t = 900$$

$$\therefore 1.65^t = 30$$

$$\therefore \log_{10} 1.65^t = \log_{10} 30$$

$$\therefore t \log_{10} 1.65 = \log_{10} 30$$

$$\therefore t = \frac{\log_{10} 30}{\log_{10} 1.65}$$

$$\approx 6.792$$

i.e. it takes approximately 6.792 hours for 900 hectares to be burnt.

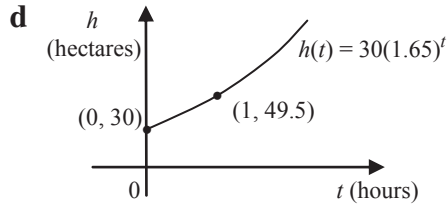

7 a When $t = 0$, $\theta = 80(2^{-0}) + 20$
 $= 80 + 20$
 $= 100$

When $t = 1$, $\theta = 80(2^{-1}) + 20$
 $= 40 + 20$
 $= 60$

When $t = 2$, $\theta = 80(2^{-2}) + 20$
 $= 20 + 20$
 $= 40$

When $t = 3$, $\theta = 80(2^{-3}) + 20$
 $= 10 + 20$
 $= 30$

When $t = 4$, $\theta = 80(2^{-4}) + 20$
 $= 5 + 20$
 $= 25$

When $t = 5$, $\theta = 80(2^{-5}) + 20$
 $= 2.5 + 20$
 $= 22.5$

t	0	1	2	3	4	5
θ	100	60	40	30	25	22.5

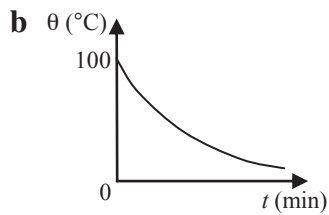

c When $\theta = 60^\circ$, $t = 1$
 i.e. the temperature is 60°C after 1 minute.

d When $t = 3.5$, $\theta = 80(2^{-3.5}) + 20$
 $\approx \frac{80}{11.3137085} + 20$
 ≈ 27.071

8 a $P_A = 70\,000\,000 + 3\,000\,000t$,
 $P_B = 70\,000\,000 + 5\,000\,000t$
 $P_C = 70\,000\,000(1.3)^{\frac{t}{10}}$

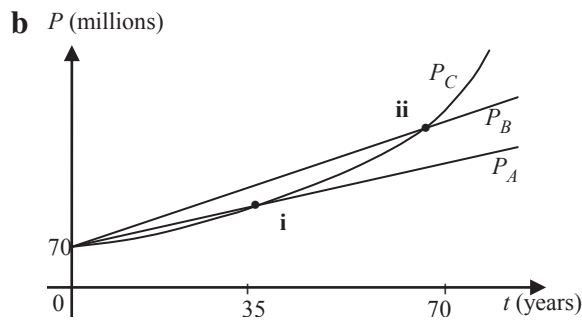

c From the graph, the population of C overtakes the population of

i A after approximately 35 years

ii B after approximately 67 years.

9 a i When $t = 1975$, $P = 4(2)^{\frac{1975-1975}{35}}$
 $= 4(2)^0$
 $= 4 \times 1$
 $= 4$ billion

ii When $t = 1995$, $P = 4(2)^{\frac{1995-1975}{35}}$
 $= 4(2)^{\frac{20}{35}}$
 $\approx 4 \times 1.48599$
 ≈ 5.944 billion

iii When $t = 2005$, $P = 4(2)^{\frac{2005-1975}{35}}$
 $= 4(2)^{\frac{30}{35}}$
 ≈ 7.246 billion

b When $t = 1997$, $P = 4(2)^{\frac{1997-1975}{35}}$
 $= 4(2)^{\frac{22}{35}}$

In 1997, $P = 4(2)^{\frac{1997-1975}{35}}$
 $= 4(2)^{\frac{22}{35}}$

Double this is $2 \times 4(2)^{\frac{22}{35}}$
 $= 4(2)^{1+\frac{22}{35}}$

$$= 4(2)^{\frac{57}{35}}$$

Solve for t : $4(2)^{\frac{t-1975}{35}} = 4(2)^{\frac{57}{35}}$

Then $t - 1975 = 57$

$t = 2032$

i.e. in 2032 the population of Earth will be twice the population it was in 1997.

10 $V_1(t) = 1000e^{\frac{-t}{10}}$, $t \geq 0$
 $V_2(t) = 1000 - 40t$, $0 \leq t \leq 25$

a $V_1(0) = 1000$, $V_2(0) = 1000$

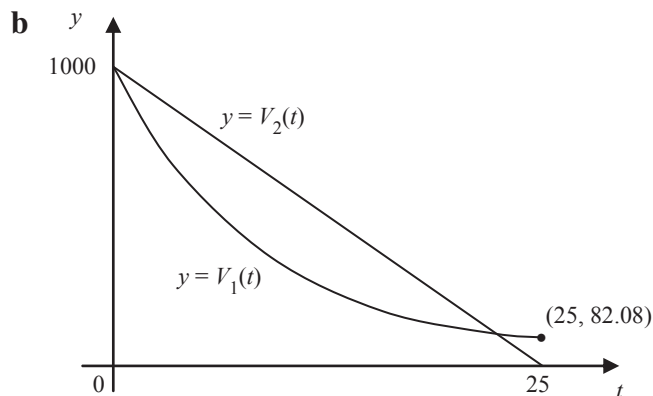

c Tank B is empty when $t = 25$, i.e. when $1000 - 40t = 0$.

$$V_1(25) = 1000e^{\frac{-25}{10}}$$

$$= 64.15 \dots$$

Tank A has 64.15 litres in it when B is first empty.

- d On a CAS calculator, with $f_1 = 10003^{(-x/10)}$ and $f_2 = 1000 - 40x$, and using
TI: Press **Menu** → **6:Analyze Graph** → **4:Intersection**
CP: Tap **Analysis** → **G-Solve** → **Intersect**
 $t = 0$, and $V_1(0) = V_2(0) = 1000$
 $t = 23$,

11
$$h_1(t) = 18 + 10 \sin\left(\frac{\pi t}{6}\right)$$

$$h_2(t) = 8 + 6t$$

- a period of $y = h_1(t)$

$$= 2\pi \div \frac{\pi}{6}$$

$$= 12$$

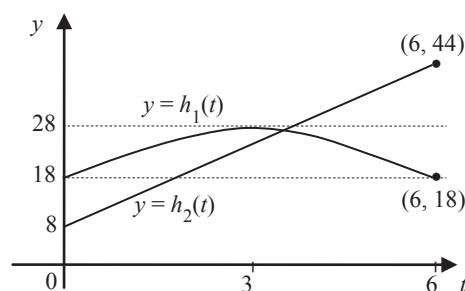

- b On a CAS calculator, with $f_1 = 18 + 10 \sin(\pi x/6)$ and $f_2 = 8 + 6x$, and using
TI: Press **Menu** → **6:Analyze Graph** → **4:Intersection**
CP: Tap **Analysis** → **G-Solve** → **Intersect**
the coordinates of the intersection point are (3.311, 27.867). (3.19 am)
- c i When $t = 9$ (9.00 am), $h_1(t)$ reaches its minimum value of 8.
- ii The original function satisfies this with t redefined, i.e. $h(t) = 8 + 6t$.

Chapter 16 – Rates of change

Solutions to Exercise 16A

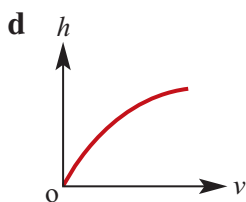
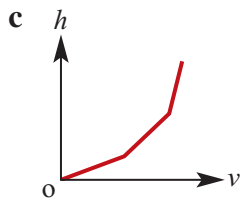
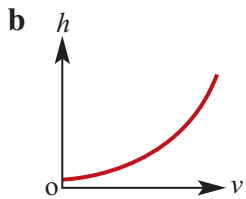
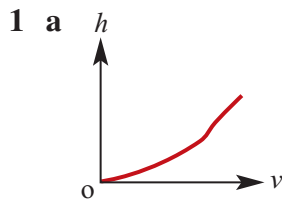

- 2 For the first 2 minutes, the particle travels a distance of 4 m with its speed increasing. For the next 4 minutes, it travels 4 m at constant speed. Then it turns back and returns to its starting point O , travelling at a constant speed and taking 8 minutes to reach O .

- 3 a **C** and **D** are most likely, since putting the price up is most likely to result in fewer customers. In **C** the present price of admission is clearly too low, whereas in the case of **D** the present price is about right.

B, **E** and **F** assume that people will keep coming in the same numbers however expensive the tickets are. This seems very unlikely. **A** is possible, but the shape seems wrong.

- b The axis intersection must refer to current profits and current prices. This can hardly be zero profit and zero prices since it is scarcely possible that net overheads are zero.

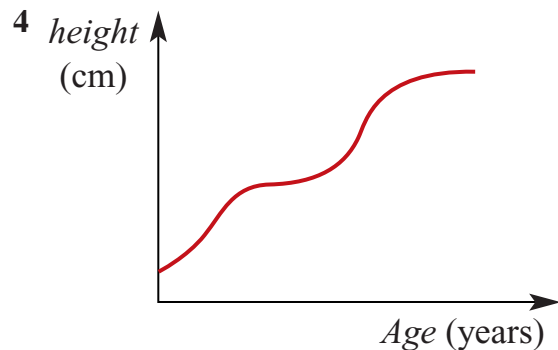

There are usually two main growth spurts, one before and during puberty. Height decreases during old age as bones diminish in size and strength.

- 5 a The car accelerates up to 100 km/hr and slows considerably just before 1 km and again at 1.8 km. From 1 to $1\frac{1}{2}$ it will speed up again.

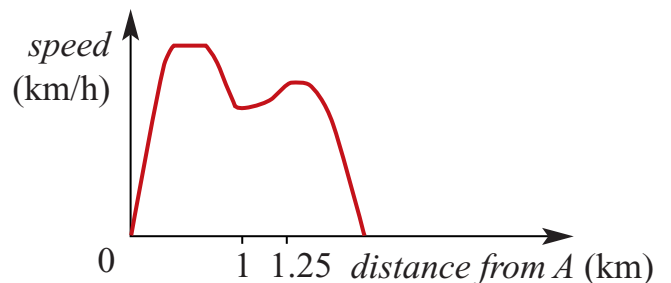

- 6 a** **A** begins very slowly and smoothly accelerates continually until maximum speed at the end of the race.
B sets off fast, slows very slightly, then maintains a constant speed until the final sprint.
C is like **B** except that **C**'s start and finish are a little slower than the average speed.
D starts quickly, slows down a little and maintains constant speed until the finish.
E begins fast and progressively slows almost to a complete stop.
F begins fast, slows down progressively until the middle of the race, and then slows down at an increasing rate until the last lap, when **D** (presumably) walks slower and slower until the end.

- b** **B** is most likely to win because the final sprint generally decides the race, and **B** is the only one apart from **A** who is accelerating at this point. **A** will be, in all probability, several laps behind **B** by then.
C is also a possibility to win.

- 7 a** distance–time graph:

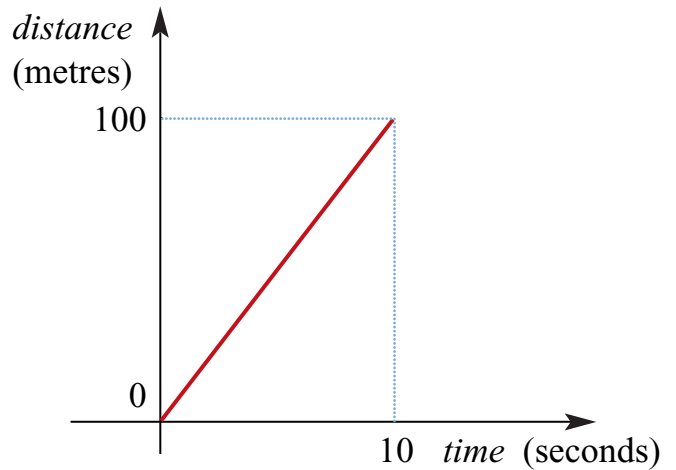

- b** speed–time graph:

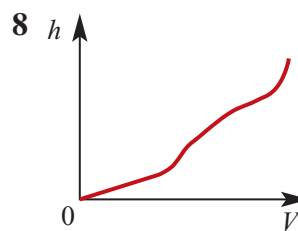
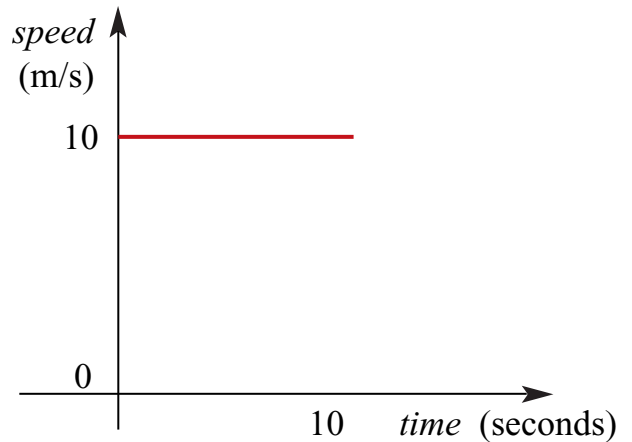

- 9** Distance-time graph is a straight line, therefore the car travels at constant speed. **D**

- 10** Only **C** shows the rate of cost of living slowing down. **B** and **D** show the rate actually decreasing and **A** shows an

acceleration.

11

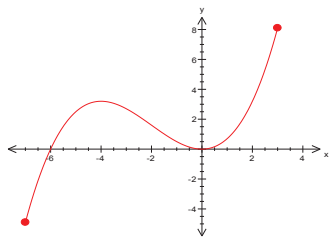

a $(-4, 0)$

b y increases with x :
 $[-7, -4) \cup (0, 3]$

12

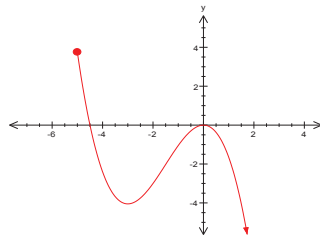

a $(-3, 0)$

b y decreases as x increases:
 $[-5, -3) \cup (0, 2]$

Solutions to Exercise 16B

$$\begin{aligned} \text{1 Speed} &= \frac{200}{150} = \frac{4}{3} \text{ km/min} \\ &= \frac{4}{3}(60) \\ &= 80 \text{ km/h} \end{aligned}$$

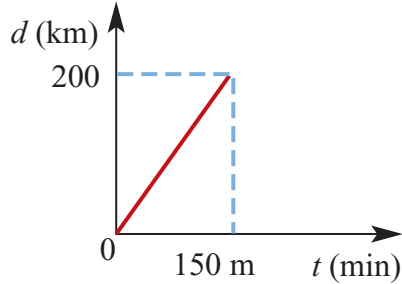

2 distance (km)

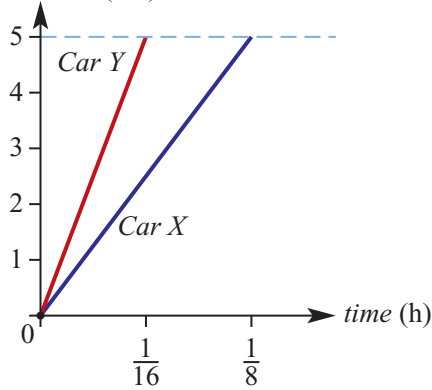

3 A\$1=US\$0.75

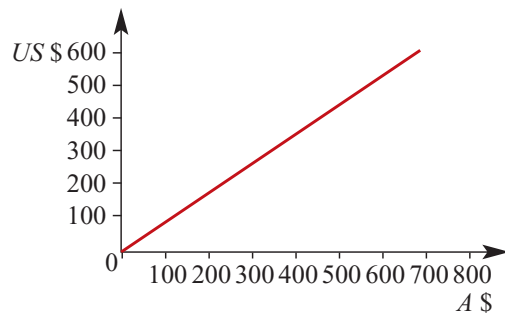

$$\begin{aligned} \text{4 a } 120 \text{ km in 2 hours} &= \frac{120}{2} \\ &= 60 \text{ km/h} \end{aligned}$$

$$\begin{aligned} \text{b } 60 \text{ m in 20 seconds} &= \frac{60}{20} \\ &= 3 \text{ m/s} \end{aligned}$$

$$\begin{aligned} \text{c } 8000 \text{ m in 20 minutes} &= \frac{8000}{1/3} = 24 \text{ km/h} \\ \text{OR } \frac{8000}{20 \times 60} &= \frac{20}{3} \text{ m/s} = 6\frac{2}{3} \text{ m/s} \end{aligned}$$

$$\begin{aligned} \text{d } 200 \text{ km in 5 hours 40 minutes} &= \frac{200}{17/3} \approx 35.29 \text{ km/h} \end{aligned}$$

$$\begin{aligned} \text{e } 6542 \text{ m in 5 minutes 20 seconds} &= \frac{6542}{320} = 20.44 \text{ m/s} \end{aligned}$$

$$\text{5 a } 40 \text{ L in 5 minutes} = \frac{40}{5} = 8 \text{ L/min}$$

$$\text{b } 600 \text{ L in 12 minutes} = \frac{600}{12} = 50 \text{ L/min}$$

$$\text{c } 200 \text{ L in 17 minutes} = \frac{200}{17} \approx 11.8 \text{ L/min}$$

$$\begin{aligned} \text{d } 180 \text{ L in } \frac{52}{3} \text{ minutes} &= \frac{135}{13} \approx 1.04 \text{ L/min} \end{aligned}$$

6 a

<i>t</i>	0	0.5	1	1.5	2	3	4	5
<i>A</i>	0	7.5	15	22.5	30	45	60	75

b

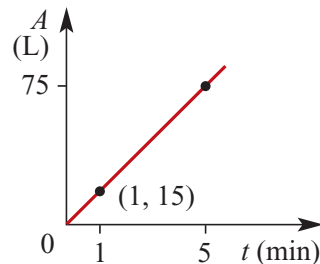

7 \$200 for 13 hours = $\frac{\$200}{13} = \15.38 per hour

8 5000 m in 24 sec = $\frac{5000}{24} = 208\frac{1}{3}$ m/s

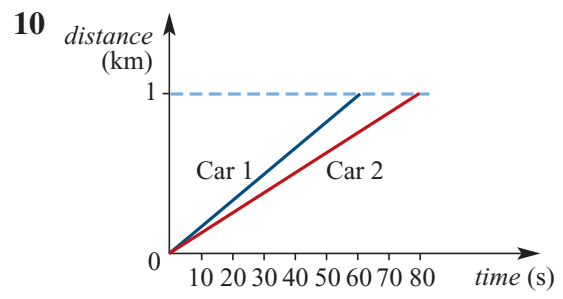
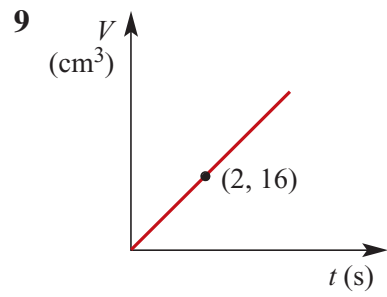

Solutions to Exercise 16C

1 Average speed = $\frac{48 - 32}{8 - 3} = \frac{16}{5} \text{ m/s}^2$

2 a $f(x) = 2x + 5$

Av. rate of change:

$$\frac{f(3) - f(0)}{3 - 0} = \frac{11 - 5}{3} = 2$$

b $f(x) = 3x^2 + 4x - 2$

Av. rate of change:

$$\begin{aligned} \frac{f(2) - f(-1)}{2 - (-1)} &= \frac{18 - (-3)}{3} \\ &= \frac{21}{3} = 7 \end{aligned}$$

c $f(x) = \frac{2}{x-3} + 4$

Av. rate of change:

$$\frac{f(7) - f(4)}{7 - 4} = \frac{4.5 - 6}{3} = -\frac{1}{2}$$

d $f(x) = \sqrt{5-x}$

Av. rate of change:

$$\frac{f(4) - f(0)}{4 - 0} = \frac{1 - \sqrt{5}}{4}$$

3 a Av. rate of change: $\frac{5 - 30}{2 - (-5)} = -\frac{25}{7}$

b Av. rate: $\frac{5 - 14}{2 - (-1.5)} = -\frac{9}{3.5} = -\frac{18}{7}$

c Av. rate: $\frac{15 - 3}{3 - 0} = \frac{12}{3} = 4$

d Av. rate: $\frac{5b - b}{2a - (-a)} = \frac{4b}{3a}$

4 $S(t) = t^3 + t^2 - 2t, t > 0$

a Av. rate: $\frac{S(2) - S(0)}{2 - 0} = \frac{8}{2} = 4 \text{ m/s}$

b Av. rate: $\frac{S(4) - S(2)}{4 - 2} = \frac{72 - 8}{2} = 32 \text{ m/s}$

5 \$2000 dollars, 7% per year over 3 years

$\therefore I = 2000(1.07^t)$

a $I(3) = 2000(1.07^3) = \$2450.09$

b Av. return = $\frac{2450.09 - 2000}{3} = \150.03

6 $d(t) = -\frac{300}{t+6} + 50, t > 0$

$d(10) = (50 - \frac{300}{16}) = 31.25 \text{ cm}$

$d(0) = (50 - \frac{300}{6}) = 0 \text{ cm}$

Av. rate: $\frac{31.25}{10} = 3.125 \text{ cm/min}$

7 C $d(3) = 2 \text{ m}, d(0) = 0 \text{ m}$

Av. speed = $\frac{2}{3} \text{ m/s}$

Solutions to Exercise 16D

1 $y = x^3 + x^2$; chord from $x = 1.2$ to 1.3 :

$$\begin{aligned} &\cong \frac{y(1.3) - y(1.2)}{1.3 - 1.2} = \frac{3.887 - 3.168}{0.1} \\ &= 7.19 \end{aligned}$$

2 a

$$\begin{aligned} \text{From 0 to 1200, av. rate} &= \frac{19 - 5}{1200} \\ &\approx 0.012\text{L/kgm} \end{aligned}$$

b $C(600) = 15\text{L/min}$, $C(0) = 5\text{L/min}$.

$$\begin{aligned} W = 450, \text{ est. rate} &= \frac{15 - 5}{600} = \frac{1}{60} \\ &\approx 0.0167\text{L/kg m} \end{aligned}$$

3 $y = 10^x$

a Average rate of change over:

$$\text{i } [0, 1] : \frac{y(1) - y(0)}{1} = \frac{10 - 1}{1} = 9$$

$$\text{ii } [0, 0.5] : \frac{y(0.5) - y(0)}{0.5} = \frac{\sqrt{10} - 1}{0.5} \cong 4.3246$$

$$\text{iii } [0, 0.1] : \frac{y(0.1) - y(0)}{0.1} \cong 2.5893$$

b Even smaller intervals suggest the instantaneous rate of change at $x = 0$ is about 2.30

4 a $T \approx 25^\circ$ at $t = 16$ hours, i.e. at 16:00.

b $T(14) = 23^\circ$, $T(10) = 9^\circ$ (approx.)

$$\text{Est. rate} = \frac{23 - 9}{14 - 10} = 3^\circ\text{C/hr}$$

c $T(20) = 15.2^\circ$, $T(16) = 25.2^\circ$

$$\text{Est. rate} = \frac{15.2 - 25.2}{20 - 16} = -2.5^\circ\text{C/hr}$$

5 Using chord $x = 1.2$ to 1.4 , av. rate of change

$$\begin{aligned} &= \left(\frac{1}{1.4} - \frac{1}{1.2} \right) \div (1.4 - 1.2) \\ &\cong \frac{0.714 - 0.833}{0.2} = -0.5952 \end{aligned}$$

6 $y = \sqrt{16 - x^2}$, $-4 \leq x \leq 4$

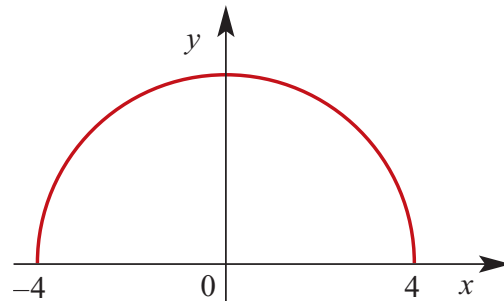

a Gradient at $x = 0$ must be zero, as a tangent drawn at that point is horizontal.

b $x = 2$; chord connecting $x = 1.9$ and 2.1 .

$$\begin{aligned} y(2.1) &= \sqrt{16 - 2.1^2} \cong 3.40 \\ y(1.9) &= \sqrt{16 - 1.9^2} \cong 3.52 \\ \text{Av. rate} &= \frac{3.40 - 3.52}{2.1 - 1.9} \cong -0.6 \end{aligned}$$

c $x = 3$; chord connecting $x = 2.9$ and 3.1 .

$$\begin{aligned} y(3.1) &= \sqrt{16 - 3.1^2} \cong 2.53 \\ y(2.9) &= \sqrt{16 - 2.9^2} \cong 2.76 \\ \text{Av. rate} &= \frac{2.53 - 2.76}{3.1 - 2.9} \cong -1.1 \end{aligned}$$

7 $y = x^2$ and $y = 4x - 4$:

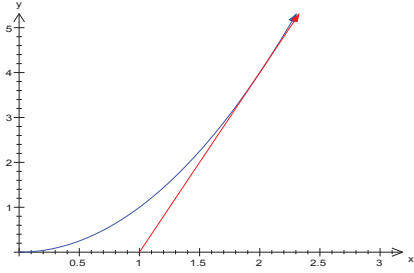

Graphs meet at (2, 4), where the line is a tangent.

Gradient = 4 (= gradient of $y = 4x - 4$)

8 $V = 3t^2 + 4t + 2$

a Av. rate of change from $t = 1$ to

$$\begin{aligned} \frac{V(3) - V(1)}{3 - 1} &= \frac{41 - 9}{2} \\ &= 16 \\ &= 16 \text{ m}^3/\text{min} \end{aligned}$$

b Est. rate of change at $t = 1$, chord 0.9

$$\begin{aligned} \frac{V(1.1) - V(0.9)}{1.1 - 0.9} &= \frac{10.03 - 8.03}{0.2} \\ &= 10 \\ &= 10 \text{ m}^3/\text{min} \end{aligned}$$

9 $P = 3(2^t)$

a Av. rate of change from $t = 2$ to

$$\begin{aligned} \frac{P(4) - P(2)}{4 - 2} &= \frac{48 - 12}{2} \\ &= 18 \\ &= 18 \text{ million/min} \end{aligned}$$

b Est. rate of change at $t = 2$, chord 1.9

$$\begin{aligned} \frac{P(2.1) - P(1.9)}{2.1 - 1.9} &\cong \frac{12.86 - 11.20}{0.2} \\ &= 8.30 \\ &= 8.30 \text{ million/min} \end{aligned}$$

10 $V = 5 \times 10^5 - 10^2(2^t)$, $0 \leq t \leq 12$

a Av. rate of change from $t = 0$ to

$$\begin{aligned} \frac{V(5) - V(0)}{5 - 0} &= \frac{-3200 + 100}{5} \\ &= -620 \text{ m}^3/\text{min} \end{aligned}$$

i.e. 620 m³/min flowing out

b Est. rate of change at $t = 6$, chord 5.9

$$\begin{aligned} \frac{V(6.1) - V(5.9)}{6.1 - 5.9} &= \frac{-686 + 597}{0.2} \\ &\cong -4440 \text{ m}^3/\text{min} \end{aligned}$$

i.e. 4440 m³/min flowing out

c Est. rate of change at $t = 12$, chord

$$\begin{aligned} \frac{V(12) - V(11.9)}{12 - 11.9} &= \frac{-409600 + 382200}{0.1} \\ &\cong -284000 \text{ m}^3/\text{min} \end{aligned}$$

i.e. 284 000 m³/min flowing out

11 a $y = x^3 + 2x^2$; chord from $x = 1$ to 1.1:

$$\begin{aligned} \cong \frac{y(1.1) - y(1)}{1.1 - 1} &= \frac{3.751 - 3}{0.1} \\ &= 7.51 \end{aligned}$$

b $y = 2x^3 + 3x$;
 chord from $x = 1$ to 1.1 :

$$\cong \frac{y(1.1) - y(1)}{1.1 - 1} = \frac{5.962 - 5}{0.1}$$

$$= 9.62$$

b Est. rate of change at $x = 1$, chord 0.9
 to 1.1:

$$\frac{y(1.1) - y(0.9)}{1.1 - 0.9} = \frac{1.42 - 0.62}{0.2}$$

$$= 4.00$$

c $y = -x^3 + 3x^2 + 2x$;
 chord from $x = 2$ to 2.1 :

$$\cong \frac{y(2.1) - y(2)}{2.1 - 2} = \frac{8.169 - 8}{0.1}$$

$$= 1.69$$

14 a i $\frac{2}{\pi} \approx 0.637$

ii $\frac{2\sqrt{2}}{\pi} \approx 0.9003$

iii 0.959

iv 0.998

d $y = 2x^3 - 3x^2 - x + 2$;
 chord from $x = 3$ to 3.1 :

$$\cong \frac{y(3.1) - y(3)}{3.1 - 3} = \frac{29.7 - 26}{0.1}$$

$$= 37$$

b 1

(Using smaller chords give answers which approach $a7, b9, c2, d35$)

12 $V = x^3$

a Av. rate of change from $x = 2$ to

$x = 4$:

$$\frac{V(4) - V(2)}{4 - 2} = \frac{64 - 8}{2}$$

$$= 28$$

b Est. rate of change at $t = 2$, chord 1.9

to 2.1:

$$\frac{V(2.1) - V(1.9)}{2.1 - 1.9} \cong \frac{9.261 - 6.859}{0.2}$$

$$= 12.01$$

13 $y = 2x^2 - 1$

a Av. rate of change from $x = 1$ to

$x = 4$:

$$\frac{y(4) - y(1)}{4 - 1} = \frac{31 - 1}{3}$$

$$= 10$$

Solutions to Exercise 16E

1 $s(t) = 6t - 2t^3$

a Av. velocity over $[0, 1]$

$$= \frac{s(1) - s(0)}{1 - 0} = \frac{4 - 0}{1} = 4 \text{ m/s}$$

b Av. velocity over $[0.8, 1]$

$$\frac{s(1) - s(0.8)}{1 - 0.8} = \frac{4 - 3.776}{0.2} = 1.12 \text{ m/s}$$

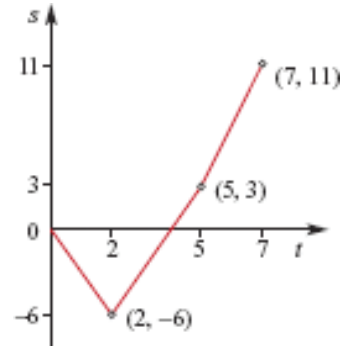

2 a Train's velocity over:

i $[0, 2] = \frac{60}{2} = 30 \text{ km/h}$

ii $[2, 5] = \frac{20}{3} = 6.67 \text{ km/h}$

iii $[5, 8] = -\frac{120}{3} = -40 \text{ km/h}$

b The train journey travelled steadily for 2 hrs at 30 km/hr, and at 6.67 km/h for another 3 hours. It then turned around and headed back to Jimbara at 40 km/h, reaching the station after 7 hours. It went back past the station at the same speed for another hour.

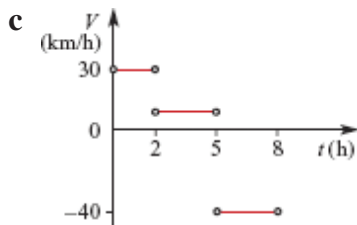

3 Over $(0, 2)$, $v = -3$; over $(2, 5)$, $v = 3$; over $(5, 7)$, $v = 4$

4 a From graph: $v = 0$ at $t = 2.5$ seconds

b $v > 0$ for $0 \leq t < 2.5$ seconds

c 6 m (maximum value of x)

d 5 seconds (2nd x -intercept)

e $v(1) \cong 3 \text{ m/s}$

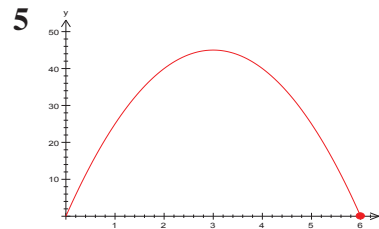

a Ball returns to starting point at $t = 6 \text{ sec}$

b Av. velocity $t = 1$ to $t = 2$:

$$\frac{40 - 25}{2 - 1} = 15 \text{ m/s}$$

c $t = 1$ to $t = 1.5$:

$$\frac{33.75 - 25}{1.5 - 1} = 17.5 \text{ m/s}$$

d $v(1) = 20 \text{ m/s}$

e $v(4) = -10 \text{ m/s}$

f $v(5) = -20 \text{ m/s}$

- 6 a** $v(0) \cong 11 \text{ m/s}$
- b** $h \text{ max.} = 15 \text{ m}$
- c** $h \text{ max.}$ occurs at $t = 1 \text{ sec}$
- d** The stone hit the ground at $t = 2.8$ seconds
- e** The stone hits the ground at 15 m/s
- 7 a** Particle is at O at x -intercepts:
 $t = 2, 3, 8$ seconds
- b** Particle moves right when gradient is positive: $\{t: 0 < t < 2.5\} \cup \{t: t > 6\}$
- c** Particle is stationary at gradient zero:
 $t = 2.5, 6$

Solutions to Technology-free questions

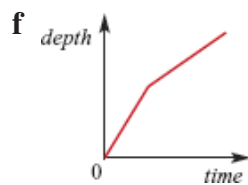
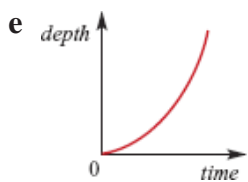
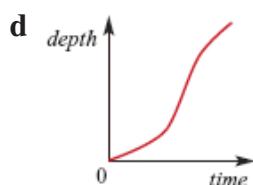
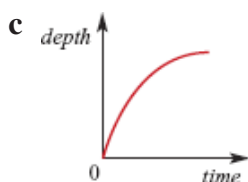
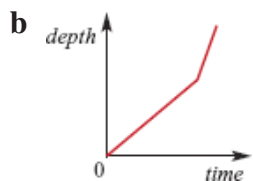
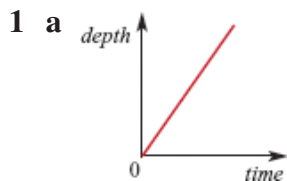

2 a Constant speed = $\frac{200}{3}$ km/h
 $= \frac{200}{180}$ km/min
 $= \frac{10}{9}$ km/min

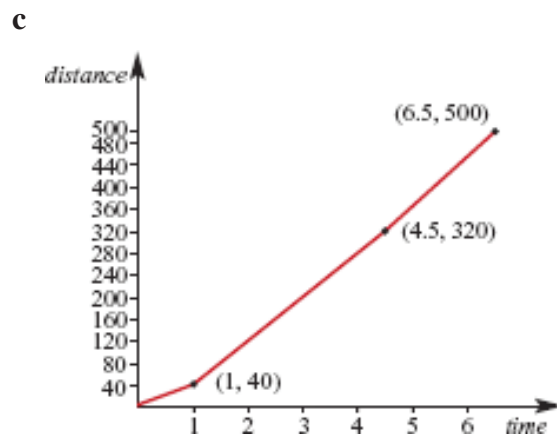
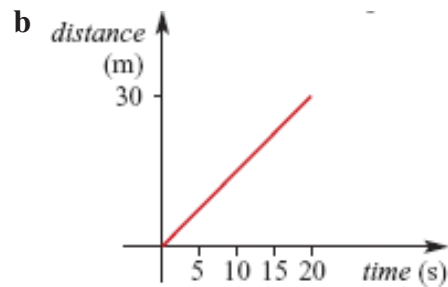
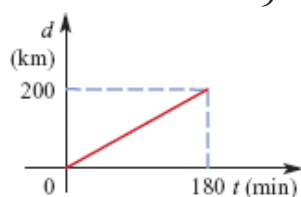

3 $s = 6x^2$
 Av. rate of change from $x = 2$ to $x = 4$:
 $\frac{s(4) - s(2)}{4 - 2} = \frac{6(16 - 4)}{2}$
 $= 36 \text{ cm}^2/\text{cm}$

4 $y = x^3$
 a Av. rate over $[0, 1]$: $\frac{1^3 - 0^3}{1 - 0} = 1$
 b Av. rate over $[1, 3]$: $\frac{3^3 - 1^3}{3 - 1} = 13$

5 $s(t) = 4t - 6t^3$
 a Av. v over $[0, 1]$: $\frac{-2 - 0}{1 - 0} = -2$
 b av v over $[0.9, 1]$: $\frac{-2 + 0.774}{1 - 0.9} = -12.26$

c Smaller intervals suggest a good estimate of the instantaneous velocity for $t = 1 = -14\text{m/s}$

Solutions to multiple-choice questions

$$\begin{aligned} 1 \quad \mathbf{C} \quad \text{Av. } v &= \frac{12 + 0 + 8}{2 + 0.75 + 1.25} = \frac{20}{4} \\ &= 5 \text{ km/h} \end{aligned}$$

$$\begin{aligned} 2 \quad \mathbf{B} \quad \text{Av. rate} &= \frac{12000 + 2500}{8 + 2} \\ &= 1450 \text{ letters/hour} \end{aligned}$$

3 **D** OA oblique line \therefore constant speed

4 **E** AB = horizontal line \therefore stationary

5 **D** Horizontal lines at AB and DE

6 **B** Av. rate of change of $y = 3(2^x)$ over

$$\begin{aligned} [0, 2]: \\ \frac{3(2^2 - 2^0)}{2 - 0} &= \frac{9}{2} = 4.5 \end{aligned}$$

$$\begin{aligned} 7 \quad \mathbf{C} \quad P &= 10(1.1^t) \\ \text{Av. rate of growth in 5th week:} \\ \frac{P(5) - P(4)}{5 - 4} &= 10(1.1^5 - 1.1^4) \\ &= 1.5 \end{aligned}$$

$$\begin{aligned} 8 \quad \mathbf{E} \quad f(x) &= 2x^3 + 3x \\ \text{Av. rate over } [-2, 2]: \\ \frac{f(2) - f(-2)}{2 - (-2)} &= \frac{22 - (-22)}{4} \\ &= \frac{44}{4} = 11 \end{aligned}$$

Solutions to extended-response questions

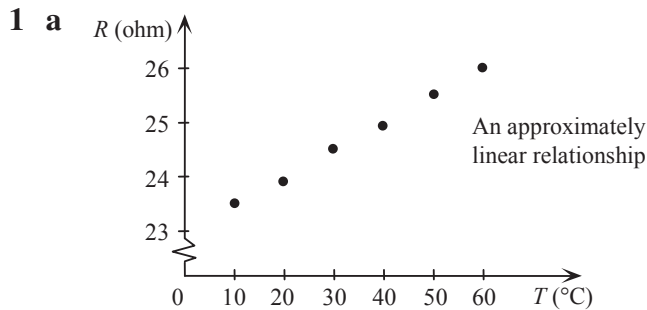

b Rate of increase = $\frac{\text{change in resistance}}{\text{change in temperature}}$

$$= \frac{26 - 23.4}{60 - 10} = 0.05 \text{ohm}/^{\circ}\text{C}$$

2 a i When $t = 0$, $y = 4.9(0)^2 = 0$

When $t = 2$, $y = 4.9(2)^2 = 19.6$

Average speed between $t = 0$ and $t = 2$ is

$$\frac{19.6 - 0}{2 - 0} = 9.8 \text{ m/s}$$

ii When $t = 4$, $y = 4.9(4)^2 = 78.4$

Average speed between $t = 2$ and $t = 4$ is

$$\frac{78.4 - 19.6}{4 - 2} = 29.4 \text{ m/s}$$

b i When $t = 4 - h$, $y = 4.9(4 - h)^2$

$$= 4.9(16 - 8h + h^2)$$

$$= 78.4 - 39.2h + 4.9h^2$$

Distance rock has fallen between $t = 4 - h$ and $t = 4$

$$= 78.4 - (78.4 - 39.2h + 4.9h^2)$$

$$= 39.2h - 4.9h^2$$

$$= 4.9h(8 - h)$$

ii Average speed = $\frac{\text{distance}}{\text{time}}$

$$= \frac{4.9h(8 - h)}{4 - (4 - h)}$$

$$= \frac{4.9h(8 - h)}{h}$$

$$= 4.9(8 - h)$$

- iii When $h = 0.2$, average speed = $4.9(8 - 0.2) = 38.22$
 When $h = 0.1$, average speed = $4.9(8 - 0.1) = 38.71$
 When $h = 0.05$, average speed = $4.9(8 - 0.05) = 38.955$
 When $h = 0.01$, average speed = $4.9(8 - 0.01) = 39.151$
 When $h = 0.001$, average speed = $4.9(8 - 0.001) = 39.1951$
 Hence, the speed of impact will be 39.2 m/s.

- 3 From 6 am to 2 pm business should gradually improve, hence a negative gradient getting steeper. Fill up at 2 pm. From 2 pm to midnight business should gradually decrease, hence a negative gradient getting less steep. At midnight the machine has slightly more cans than at 6 am next morning.

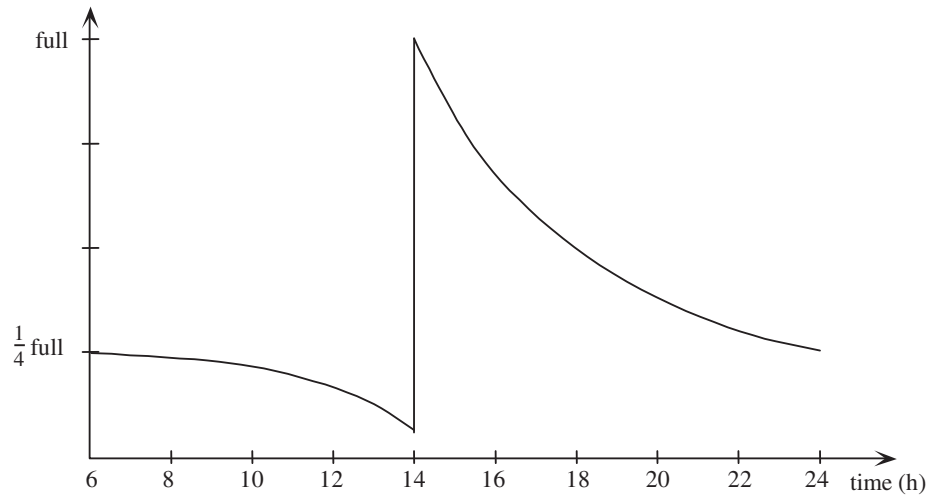

4 a Gradient of $PQ = \frac{b^2 - a^2}{b - a}$
 $= \frac{(b - a)(b + a)}{b - a}$
 $= b + a \quad \text{for } a \neq b$

- b When $a = 1, b = 2$,

$$\begin{aligned} \text{gradient of } PQ &= 2 + 1 \\ &= 3 \end{aligned}$$

- c When $a = 2, b = 2.01$,

$$\begin{aligned} \text{gradient of } PQ &= 2.01 + 2 \\ &= 4.01 \end{aligned}$$

$$\begin{aligned}
 \mathbf{5\ a} \quad \text{When } x = 1.5, \quad y &= \frac{4}{1.5} \\
 &= \frac{8}{3} \\
 &= 2\frac{2}{3}
 \end{aligned}$$

$$\begin{aligned}
 \text{When } x = 2.5, \quad y &= \frac{4}{2.5} \\
 &= \frac{8}{5} \\
 &= 1\frac{3}{5}
 \end{aligned}$$

Coordinates of $A_1 = \left(1.5, \frac{8}{3}\right)$ and coordinates of $A_2 = \left(2.5, \frac{8}{5}\right)$

$$\begin{aligned}
 \therefore \quad \text{gradient of } A_1A_2 &= \frac{\frac{8}{5} - \frac{8}{3}}{2.5 - 1.5} \\
 &= \frac{8 \times 3 - 8 \times 5}{15} \\
 &= -\frac{16}{15} \\
 &= -1\frac{1}{15} \\
 &\approx -1.07
 \end{aligned}$$

$$\begin{aligned}
 \mathbf{b} \quad \text{When } x = 1.9, \quad y &= \frac{4}{1.9} \\
 &= \frac{40}{19} \approx 2.1053
 \end{aligned}$$

$$\begin{aligned}
 \text{When } x = 2.1, \quad y &= \frac{4}{2.1} \\
 &= \frac{40}{21} \approx 1.9048
 \end{aligned}$$

Coordinates of $B_1 = \left(1.9, \frac{40}{19}\right)$ and coordinates of $B_2 = \left(2.1, \frac{40}{21}\right)$

$$\begin{aligned}
 \therefore \quad \text{gradient of } B_1B_2 &= \frac{\frac{40}{21} - \frac{40}{19}}{2.1 - 1.9} \\
 &= -\frac{400}{399} \\
 &= -1\frac{1}{399} \\
 &\approx -1.003
 \end{aligned}$$

$$\begin{aligned} \text{c When } x = 1.99, \quad y &= \frac{4}{1.99} \\ &= \frac{400}{199} \end{aligned}$$

$$\begin{aligned} \text{When } x = 2.01, \quad y &= \frac{4}{2.01} \\ &= \frac{400}{201} \end{aligned}$$

Coordinates of $C_1 = \left(1.99, \frac{400}{199}\right)$ and coordinates of $C_2 = \left(2.01, \frac{400}{201}\right)$

$$\begin{aligned} \therefore \text{gradient of } C_1C_2 &= \frac{\frac{400}{201} - \frac{400}{199}}{2.01 - 1.99} \\ &= -\frac{40\,000}{39\,999} \\ &= -1\frac{1}{39\,999} \\ &\approx -1.000\,025 \end{aligned}$$

$$\begin{aligned} \text{d When } x = 1.999, \quad y &= \frac{4}{1.999} \\ &= \frac{4000}{1999} \end{aligned}$$

$$\begin{aligned} \text{When } x = 2.001, \quad y &= \frac{4}{2.001} \\ &= \frac{4000}{2001} \end{aligned}$$

Coordinates of $D_1 = \left(1.999, \frac{4000}{1999}\right)$ and coordinates of $D_2 = \left(2.001, \frac{4000}{2001}\right)$

$$\begin{aligned} \therefore \text{gradient of } D_1D_2 &= \frac{\frac{4000}{2001} - \frac{4000}{1999}}{2.001 - 1.999} \\ &= -\frac{4\,000\,000}{3\,999\,999} \\ &= -1\frac{1}{3\,999\,999} \\ &\approx -1.000\,000\,3 \end{aligned}$$

6 Let t = age (in years), let x = Andrea's weight (kg), let y = Clive's weight (kg).

a When $t = 0$, $x \approx 2$ and when $t = 18$, $x \approx 62$.

$$\begin{aligned} \text{Average rate of change for Andrea} &\approx \frac{62 - 2}{18 - 0} \\ &\approx \frac{60}{18} \text{ kg/year} \approx 3\frac{1}{3} \text{ kg/year} \end{aligned}$$

b When $t = 0$, $y \approx 2$ and when $t = 18$, $y \approx 81$.

$$\begin{aligned}\text{Average rate of change for Clive} &\approx \frac{81 - 2}{18 - 0} \\ &\approx \frac{79}{18} \text{ kg/year} \approx 4.4 \text{ kg/year}\end{aligned}$$

c Andrea weighed more than Clive between the ages of 0 and 5 and between the ages of 10 and 12, i.e. $\{t: 0 < t < 5\} \cup \{t: 10 < t < 12\}$.

d Clive was growing more rapidly than Andrea between the ages of 5 and 7 and between the ages of 11 and $17\frac{1}{2}$, i.e. $\{t: 5 < t < 7\} \cup \{t: 11 < t < 17\frac{1}{2}\}$.

7 a i 0.24 billion

ii 0.52 billion

b Average annual population increase = $\frac{0.52 - 0.24}{2000 - 1960}$

$$\begin{aligned}&= \frac{0.28}{40} \\ &= \frac{7}{1000} \\ &= 0.007 \text{ billion/year}\end{aligned}$$

c i Draw a tangent to the curve at 1960. Select 2 points on the tangent, e.g. (1950, 0.2) and (1960, 0.24).

$$\begin{aligned}\text{Rate of population increase} &= \frac{0.24 - 0.2}{1960 - 1950} \\ &= \frac{4}{1000} \\ &= 0.004 \text{ billion/year}\end{aligned}$$

ii Draw a tangent to the curve at 2000. Select 2 points on the tangent, e.g. (1990, 0.38) and (2000, 0.52).

$$\begin{aligned}\text{Rate of population increase} &= \frac{0.52 - 0.38}{2000 - 1990} \\ &= \frac{14}{1000} \\ &= 0.014 \text{ billion/year}\end{aligned}$$

d If the curve is continued with ever-increasing gradient, an estimation of how long it will take to double the 2020 population is 25 years, i.e. in 2045.

- 8 When $x = 2.5$, $y = 10^{2.5}$
 ≈ 316.23
- When $x = 2.6$, $y = 10^{2.6}$
 ≈ 398.11
- When $x = 2.7$, $y = 10^{2.7}$
 ≈ 501.19
- When $x = 2.75$, $y = 10^{2.75}$
 ≈ 562.34
- When $x = 2.8$, $y = 10^{2.8}$
 ≈ 630.9573445

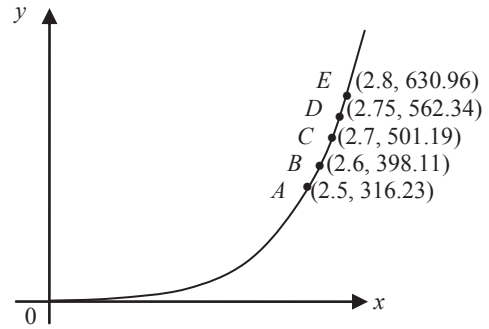

a i Gradient of $AE = \frac{630.96 - 316.23}{2.8 - 2.5} \approx 1049.1$

ii Gradient of $BE = \frac{630.96 - 398.11}{2.8 - 2.6} \approx 1164.3$

iii Gradient of $CE = \frac{630.96 - 501.19}{2.8 - 2.7} \approx 1297.7$

iv Gradient of $DE = \frac{630.96 - 562.34}{2.8 - 2.75} \approx 1372.4$

- b The gradients are approaching the gradient of the curve at $x = 2.8$ as the intervals are made smaller.

When $x = 2.79$, $y = 10^{2.79} \approx 616.595$

$$\text{Gradient} = \frac{630.957 - 616.595}{2.8 - 2.79} \approx 1436.2$$

When $x = 2.799$, $y = 10^{2.799} \approx 629.5062$

$$\text{Gradient} = \frac{630.9573 - 629.5062}{2.8 - 2.799} \approx 1451.2$$

When $x = 2.7999$, $y = 10^{2.7999} \approx 630.81208$

$$\text{Gradient} = \frac{630.95734 - 630.81208}{2.8 - 2.7999} \approx 1452.7$$

When $x = 2.79999$, $y = 10^{2.79999} \approx 630.9428163$

$$\text{Gradient} = \frac{630.9573445 - 630.9428163}{2.8 - 2.79999} \approx 1452.8$$

When $x = 2.799999$, $y = 10^{2.799999} \approx 630.9558916$

$$\text{Gradient} = \frac{630.9573445 - 630.9558916}{2.8 - 2.799999} \approx 1452.8$$

When $x = 2.799\,999\,9$, $y = 10^{2.799\,999\,9} \approx 630.957\,199\,2$

$$\text{Gradient} = \frac{630.957\,344\,5 - 630.957\,199\,2}{2.8 - 2.799\,999\,9} \approx 1452.8$$

When $x = 2.799\,999\,99$, $y = 10^{2.799\,999\,99} \approx 630.957\,33$

$$\text{Gradient} = \frac{630.957\,344\,5 - 630.957\,33}{2.8 - 2.799\,999\,99} \approx 1452.8$$

Hence the gradient of the curve at $x = 2.8$ has been shown to be 1452.8.

9 a Gradient of $QP = \frac{a^3 - b^3}{a - b}$

$$= \frac{(a - b)(a^2 + ab + b^2)}{a - b}$$
$$= a^2 + ab + b^2 \quad \text{for } a \neq b$$

b When $a = 1$, $b = 2$

$$\begin{aligned} \text{gradient} &= 1^2 + 1 \times 2 + 2^2 \\ &= 1 + 2 + 4 \\ &= 7 \end{aligned}$$

c When $a = 2$, $b = 2.01$

$$\begin{aligned} \text{gradient} &= 2^2 + 2 \times 2.01 + 2.01^2 \\ &= 4 + 4.02 + 4.0401 \\ &= 12.0601 \end{aligned}$$

d gradient = $a^2 + ab + b^2$

If $a = b$, then

$$\begin{aligned} \text{gradient} &= b^2 + b \times b + b^2 \\ &= 3b^2 \end{aligned}$$

At the point with coordinates (b, b^3) the gradient is $3b^2$.

10 a B wins the race.

b A is in front at the 50 metre mark.

c From the graph, approximately 25 m separates 1st and 3rd placegetters when 1st finishes the race.

d From the graph, approximately 45 s separates 1st and 3rd finishing times.

e From the graph, average speed of $A \approx \frac{100 - 0}{102 - 0} \approx 0.980\text{m/s}$

From the graph, average speed of $B \approx \frac{100 - 0}{58 - 0} \approx 1.724\text{m/s}$

From the graph, average speed of $C \approx \frac{100 - 0}{88 - 0} \approx 1.136\text{m/s}$

- f** A got a fine start, for an early lead, with B second and C trailing third. A started strongly; perhaps too strongly because his pace is slowing, allowing B and C to gain ground. B and C are swimming consistently, maintaining a constant speed, although B is faster and increasing the gap. At the 70 metre mark now, and A is tiring visibly as B powers past him. A has his head down and is swimming much more consistently but his early sprint has cost him dearly. The crowd is cheering wildly as B wins this race very comfortably, with A still 25 m to go and C a further 10 m behind him. The excitement is building further as C closes the gap on A and with 15 m to go surges past him to finish in second place. A finishes third and would be most disappointed with this result. I'd say he has a lot of promise and if he can get his timing right, he'll be a serious contender against B in the next competition.
- 11 a** The graph of $y = f(x) + c$ is obtained from the graph of $y = f(x)$ by a translation of c units in the positive direction of the y -axis. Hence the average rate of change of $y = f(x) + c$ is m for the interval $[a, b]$.

The computation is:

$$\begin{aligned}\text{average rate of change} &= \frac{f(b) + c - (f(a) + c)}{b - a} \\ &= \frac{f(b) - f(a)}{b - a} \\ &= m\end{aligned}$$

- b** The graph of $y = cf(x)$ is obtained from the graph of $y = f(x)$ by a dilation of c units from the x -axis. Hence the average rate of change of $y = cf(x)$ is cm for the interval $[a, b]$.

The computation is:

$$\begin{aligned}\text{average rate of change} &= \frac{cf(b) - cf(a)}{b - a} \\ &= c \times \frac{f(b) - f(a)}{b - a} \\ &= cm\end{aligned}$$

- c** The graph of $y = -f(x)$ is obtained from the graph of $y = f(x)$ by a reflection in the x -axis. Hence the average rate of change of $y = -f(x)$ is $-m$ for the interval $[a, b]$.

The computation is:

$$\begin{aligned}\text{average rate of change} &= \frac{-f(b) - (-f(a))}{b - a} \\ &= -1 \times \frac{f(b) - f(a)}{b - a} \\ &= -m\end{aligned}$$

Chapter 17 – Differentiation of polynomials

Solutions to Exercise 17A

1 a

$$\begin{aligned} \text{Gradient} &= \frac{-(3+h)^2 + 4(3+h) - 3}{3+h-3} \\ &= \frac{-(9+6h+h^2) + 12 + 4h - 3}{h} \\ &= \frac{-9 - 6h - h^2 + 12 + 4h - 3}{h} \\ &= \frac{-2h - h^2}{h} \\ &= -2 - h \end{aligned}$$

b $\lim_{h \rightarrow 0} (-2 - h) = -2$

2 a

$$\begin{aligned} \text{Gradient} &= \frac{(4+h)^2 - 3(4+h) - 4}{4+h-4} \\ &= \frac{16 + 8h + h^2 - 12 - 3h - 4}{h} \\ &= \frac{5h + h^2}{h} \\ &= 5 + h \end{aligned}$$

b $\lim_{h \rightarrow 0} (5 + h) = 5$

3 Gradient

$$\begin{aligned} &= \frac{(x+h)^2 - 2(x+h) - (x^2 - 2x)}{x+h-x} \\ &= \frac{x^2 + 2xh + h^2 - 2x - 2h - x^2 + 2x}{h} \\ &= \frac{2xh + h^2 - 2h}{h} \\ &= 2x + h - 2 \\ \lim_{h \rightarrow 0} (2x + h - 2) &= 2x - 2 \end{aligned}$$

$$\begin{aligned} \text{Gradient} &= \frac{(2+h)^4 - 16}{2+h-2} \\ &= \frac{16 + 32h + 24h^2 + h^4 - 16}{h} \\ &= \frac{32h + 24h^2 + h^4}{h} \\ &= 32 + 24h + h^3 \\ \lim_{h \rightarrow 0} (32 + 24h + h^3) &= 32 \end{aligned}$$

5 $y = 4t^4$

Chord between $t = 4$ and $t = 5$ has
gradient $\frac{4(5^4 - 4^4)}{5 - 4} = 2244$ (around
2000 m/s)

6 $P = 1000 + t^2 + t, t > 0$

$$\begin{aligned} P(3+h) - P(3) &= (3+h)^2 - 9 + (3+h) - 3 \\ &= 6h + h^2 + h \\ &= 7h + h^2 \\ \text{Chord gradient} &= \frac{7h + h^2}{3+h-3} \\ &= 7 + h \end{aligned}$$

Growth rate at $t = 3$ is 7 insects/day

7 a $\lim_{h \rightarrow 0} \frac{2x^2h^3 + xh^2 + h}{h}$
 $= \lim_{h \rightarrow 0} (2x^2h^2 + xh + 1) = 1$

b $\lim_{h \rightarrow 0} \frac{3x^2h - 2xh^2 + h}{h}$
 $= \lim_{h \rightarrow 0} (3x^2 - 2xh + 1) = 3x^2 + 1$

c $\lim_{h \rightarrow 0} (20 - 10h) = 20$

$$\begin{aligned} \text{d } \lim_{h \rightarrow 0} \frac{30hx^2 + 2h^2 + h}{h} \\ = \lim_{h \rightarrow 0} 30x^2 + 2h + 1 = 30x^2 + 1 \end{aligned}$$

$$\text{e } \lim_{h \rightarrow 0} 5 = 5$$

$$\begin{aligned} \text{f } \lim_{h \rightarrow 0} \frac{30hx^3 + 2h^2 + 4h}{h} = \\ \lim_{h \rightarrow 0} 30x^3 + 2h + 4 = 30x^3 + 4 \end{aligned}$$

$$\begin{aligned} \text{8 a } \lim_{h \rightarrow 0} \frac{(x+h)^2 + 2(x+h) - (x^2 + 2x)}{h} \\ = \lim_{h \rightarrow 0} \frac{2hx + h^2 + 2h}{h} = 2x + 2 \end{aligned}$$

$$\begin{aligned} \text{b } \lim_{h \rightarrow 0} \frac{(5+h)^2 + 3(5+h) - 40}{h} \\ = \lim_{h \rightarrow 0} \frac{10h + h^2 + 3h}{h} \\ = \lim_{h \rightarrow 0} 13 + h = 13 \end{aligned}$$

$$\begin{aligned} \text{c } \lim_{h \rightarrow 0} \frac{(x+h)^3 + 2(x+h)^2 - (x^3 + 2x^2)}{h} \\ = \lim_{h \rightarrow 0} \frac{3x^2h + 3xh^2 + h^3 + 4xh + 2h^2}{h} \\ = \lim_{h \rightarrow 0} 3x^2 + 3xh + h^2 + 4x + 2h \\ = 3x^2 + 4x \end{aligned}$$

$$\text{9 } y = 3x^2 - x$$

a Gradient of chord PQ :

$$\begin{aligned} &= \frac{3(1+h)^2 - (1+h) - 2}{1+h-1} \\ &= \frac{3(1+2h+h^2) - 1 - h - 2}{h} \\ &= \frac{6h + 3h^2 - h}{h} = 5 + 3h \end{aligned}$$

b Gradient of PQ when $h = 0.1$ is 5.3

c Gradient of the curve at $P = 5$

$$\text{10 } y = \frac{2}{x}$$

a Gradient of chord AB :

$$\begin{aligned} &= \frac{\frac{2}{2+h} - 1}{2+h-2} \\ &= \frac{2 - (2+h)}{h(2+h)} \\ &= \frac{-h}{h(2+h)} = \frac{-1}{2+h} \end{aligned}$$

b Gradient of AB when $h = 0.1 \cong -0.48$

c Gradient of the curve at $A = -\frac{1}{2}$

$$\text{11 } y = x^2 + 2x - 3$$

a Gradient of chord PQ :

$$\begin{aligned} &= \frac{(2+h)^2 + 2(2+h) - 3 - 5}{2+h-2} \\ &= \frac{4 + 4h + h^2 + 4 + 2h - 8}{h} \\ &= \frac{6h + h^2}{h} = 6 + h \end{aligned}$$

b Gradient of PQ when $h = 0.1$ is 6.1

c Gradient of the curve at $P = 6$

12 Derivatives from first principles

$$\begin{aligned} \text{a } \lim_{h \rightarrow 0} \frac{3(x+h)^2 - 3x^2}{h} \\ = \lim_{h \rightarrow 0} \frac{3x^2 + 6xh + 3h^2 - 3x^2}{h} \\ = \lim_{h \rightarrow 0} \frac{6xh + 3h^2}{h} \\ = \lim_{h \rightarrow 0} 6x + 3h = 6x \end{aligned}$$

$$\begin{aligned} \text{b } \lim_{h \rightarrow 0} \frac{4(x+h) - 4x}{h} \\ = \lim_{h \rightarrow 0} \frac{4h}{h} = 4 \end{aligned}$$

$$\text{c } \lim_{h \rightarrow 0} \frac{3-3}{h} = 0$$

$$\begin{aligned} \text{d } \lim_{h \rightarrow 0} \frac{3(x+h)^2 + 4(x+h) - 3 - 3x^2 - 4x + 3}{h} &= \lim_{h \rightarrow 0} \frac{6hx + 3h^2 + 4h}{h} \\ &= \lim_{h \rightarrow 0} 6x + 3h + 4 = 6x + 4 \end{aligned}$$

$$\begin{aligned} \text{e } \lim_{h \rightarrow 0} \frac{2(x+h)^3 - 4 - 2x^3 + 4}{h} &= \lim_{h \rightarrow 0} \frac{6x^2h + 6xh^2 + 2h^3}{h} \\ &= \lim_{h \rightarrow 0} 6x^2 + 6xh + 2h^2 = 6x^2 \end{aligned}$$

$$\begin{aligned} \text{f } \lim_{h \rightarrow 0} \frac{4(x+h)^2 - 5(x+h) - 4x^2 + 5x}{h} &= \lim_{h \rightarrow 0} \frac{8hx + 4h^2 - 5h}{h} \\ &= \lim_{h \rightarrow 0} 8x + 4h - 5 = 8x - 5 \end{aligned}$$

$$\begin{aligned} \text{g } \lim_{h \rightarrow 0} \frac{3 - 2(x+h) + (x+h)^2 - 3 + 2x - x^2}{h} &= \lim_{h \rightarrow 0} \frac{-2x - 2h + x^2 + 2hx + h^2 + 2x - x^2}{h} \\ &= \lim_{h \rightarrow 0} \frac{-2h + 2hx + h^2}{h} \\ &= \lim_{h \rightarrow 0} -2 + 2x + h = 2x - 2 \end{aligned}$$

13 Gradient

$$\begin{aligned} &= \frac{(x+h)^4 - x^4}{x+h-x} \\ &= \frac{x^4 + 4x^3h + 6x^2h^2 + 4xh^3 + h^4 - x^4}{h} \\ &= \frac{4x^3h + 6x^2h^2 + 4xh^3 + h^4}{h} \\ &= 4x^3 + 6x^2h + 4xh^2 + h^3 \\ \lim_{h \rightarrow 0} (4x^3 + 6x^2h + 4xh^2 + h^3) &= 4x^3 \end{aligned}$$

Solutions to Exercise 17B

1 Derivatives using $\frac{d}{dx}x^n = nx^{n-1}$

a $\frac{d}{dx}(x^2 + 4x) = 2x + 4$

b $\frac{d}{dx}(2x + 1) = 2$

c $\frac{d}{dx}(x^3 - x) = 3x^2 - 1$

d $\frac{d}{dx}\left(\frac{1}{2}x^2 - 3x + 4\right) = x - 3$

e $\frac{d}{dx}(5x^3 + 3x^2) = 15x^2 + 6x$

f $\frac{d}{dx}(-x^3 + 2x^2) = -3x^2 + 4x$

2 a $f(x) = x^{12}, \therefore f'(x) = 12x^{11}$

b $f(x) = 3x^7, \therefore f'(x) = 21x^6$

c $f(x) = 5x, \therefore f'(x) = 5$

d $f(x) = 5x + 3, \therefore f'(x) = 5$

e $f(x) = 3, \therefore f'(x) = 0$

f $f(x) = 5x^2 - 3x, \therefore f'(x) = 10x - 3$

g $f(x) = 10x^5 + 3x^4,$
 $\therefore f'(x) = 50x^4 + 12x^3$

h $f(x) = 2x^4 - \frac{1}{3}x^3 - \frac{1}{4}x^2 + 2$
 $\therefore f'(x) = 8x^3 - x^2 - \frac{1}{2}x$

3 a $f(x) = x^6, \therefore f'(x) = 6x^5, \therefore f'(1) = 6$

b $f(x) = 4x^5, \therefore f'(x) = 20x^4,$
 $\therefore f'(1) = 20$

c $f(x) = 5x, \therefore f'(x) = 5, \therefore f'(1) = 5$

d $f(x) = 5x^2 + 3, \therefore f'(x) = 10x,$
 $\therefore f'(1) = 10$

e $f(x) = 3, \therefore f'(x) = 0, \therefore f'(1) = 0$

f $f(x) = 5x^2 - 3x, \therefore f'(x) = 10x - 3,$
 $\therefore f'(1) = 7$

g $f(x) = 10x^4 - 3x^3,$
 $\therefore f'(x) = 40x^3 - 9x^2, \therefore f'(1) = 31$

h $f(x) = 2x^4 - \frac{1}{3}x^3, \therefore f'(x) = 8x^3 - x^2,$
 $\therefore f'(1) = 7$

i $f(x) = -10x^3 - 2x^2 + 2,$
 $\therefore f'(x) = -30x^2 - 4x, \therefore f'(1) = -34$

4 a $f(x) = 5x^3, \therefore f'(x) = 15x^2,$
 $\therefore f'(-2) = 60$

b $f(x) = 4x^2, \therefore f'(x) = 8x,$
 $\therefore f'(-2) = -16$

c $f(x) = 5x^3 - 3x, \therefore f'(x) = 15x^2 - 3,$
 $\therefore f'(-2) = 57$

d $f(x) = -5x^4 - 2x^2,$
 $\therefore f'(x) = -20x^3 - 4x,$
 $\therefore f'(-2) = 168$

5 a $f(x) = x^2 + 3x, \therefore f'(x) = 2x + 3,$
 $\therefore f'(2) = 7$

b $f(x) = 3x^2 - 4x, \therefore f'(x) = 6x - 4,$
 $\therefore f'(1) = 2$

c $f(x) = -2x^2 - 4x, \therefore f'(x) = -4x - 4,$
 $\therefore f'(3) = -16$

$$\text{d } f(x) = x^3 - x, \therefore f'(x) = 3x^2 - 1, \\ \therefore f'(2) = 11$$

$$6 \text{ a } y = -x, \therefore \frac{dy}{dx} = -1$$

$$\text{b } y = 10, \therefore \frac{dy}{dx} = 0$$

$$\text{c } y = 4x^3 - 3x + 2, \therefore \frac{dy}{dx} = 12x^2 - 3$$

$$\text{d } y = \frac{1}{3}(x^3 - 3x + 6) \\ = \frac{1}{3}x^3 - x + 2 \\ \therefore \frac{dy}{dx} = x^2 - 1$$

$$\text{e } y = (x + 1)(x + 2) \\ = x^2 + 3x + 2 \\ \therefore \frac{dy}{dx} = 2x + 3$$

$$\text{f } y = 2x(3x^2 - 4) \\ = 6x^3 - 8x \\ \therefore \frac{dy}{dx} = 18x^2 - 8$$

$$\text{g } y = \frac{10x^5 + 3x^4}{2x^2} \\ = 5x^3 + \frac{3}{2}x^2, x \neq 0 \\ \therefore \frac{dy}{dx} = 15x^2 + 3x$$

$$7 \text{ a } y = (x + 4)^2 = x^2 + 8x + 16 \\ \frac{dy}{dx} = 2x + 8$$

$$\text{b } z = (4t - 1)^2(t + 1) \\ = (16t^2 - 8t + 1)(t + 1) \\ = 16t^3 - 8t^2 + t + 16t^2 - 8t + 1 \\ = 16t^3 + 8t^2 - 7t + 1$$

$$\therefore \frac{dz}{dt} = 48t^2 + 16t - 7$$

$$\text{c } \frac{x^3 + 3x}{x} = x^2 + 3 \therefore \frac{dy}{dx} = 2x$$

$$8 \text{ a } y = x^3 + 1, \therefore \frac{dy}{dx} = 3x^2$$

$$\text{i Gradient at } (1, 2) = 3$$

$$\text{ii Gradient at } (a, a^3 + 1) = 3a^2$$

$$\text{b Derivative} = 3x^2$$

$$9 \text{ a } y = x^3 - 3x^2 + 3x \\ \therefore \frac{dy}{dx} = 3x^2 - 6x + 3$$

$$= 3(x + 1)^2 \geq 0$$

The graph of $y = x^3 - 3x^2 + 3x$ will have a positive gradient for all x , except for a saddle point at $x = -1$ where the gradient = 0.

$$\text{b } y = \frac{x^2 + 2x}{x} = x + 2, x \neq 0 \\ \therefore \frac{dy}{dx} = 1, x \neq 0$$

$$\text{c } y = (3x + 1)^2 = 9x^2 + 6x + 1 \\ \therefore \frac{dy}{dx} = 18x + 6 = 6(3x + 1)$$

$$10 \text{ a } y = x^2 - 2x + 1, \therefore \frac{dy}{dx} = 2x - 2 \\ \therefore y(2) = 1, y'(2) = 2$$

$$\text{b } y = x^2 + x + 1, \therefore \frac{dy}{dx} = 2x + 1 \\ \therefore y(0) = 1, y'(0) = 1$$

$$\text{c } y = x^2 - 2x, \therefore \frac{dy}{dx} = 2x - 2 \\ \therefore y(-1) = 3, y'(-1) = -4$$

$$\text{d } y = (x + 2)(x - 4) = x^2 - 2x - 8$$

$$\therefore \frac{dy}{dx} = 2x - 2$$

$$\therefore y(3) = -5, y'(3) = 4$$

e $y = 3x^2 - 2x^3, \therefore \frac{dy}{dx} = 6x - 6x^2$
 $\therefore y(-2) = 28, y'(-2) = -36$

f $y = (4x - 5)^2 = 16x^2 - 40x + 25$
 $\therefore \frac{dy}{dx} = 32x - 40 = 8(4x - 5)$
 $\therefore y\left(\frac{1}{2}\right) = 9, y'\left(\frac{1}{2}\right) = -24$

11 a i $f(x) = 2x^2 - x, \therefore f'(x) = 4x - 1$
 $\therefore f'(1) = 3$
 Gradient = 1 when $4x - 1 = 1$
 $\therefore x = \frac{1}{2}$ and $f\left(\frac{1}{2}\right) = 0$
 Gradient = 1 at $\left(\frac{1}{2}, 0\right)$

ii $f(x) = 1 + \frac{1}{2}x + \frac{1}{3}x^2$
 $\therefore f'(x) = \frac{2}{3}x + \frac{1}{2}, \therefore f'(1) = \frac{7}{6}$
 Gradient = 1 when $\frac{2}{3}x + \frac{1}{2} = 1$
 $\therefore x = \frac{1}{2}\left(\frac{3}{2}\right) = \frac{3}{4}$ and $f\left(\frac{3}{4}\right) = \frac{25}{16}$
 Gradient = 1 at $\left(\frac{3}{4}, \frac{25}{16}\right)$

iii $f(x) = x^3 + x, \therefore f'(x) = 3x^2 + 1$
 $\therefore f'(1) = 4$
 Gradient = 1 when $3x^2 + 1 = 1$
 $\therefore x = 0$ and $f(0) = 0$
 Gradient = 1 at $(0, 0)$

iv $f(x) = x^4 - 31x,$
 $\therefore f'(x) = 4x^3 - 31$
 $\therefore f'(1) = -27$
 Gradient = 1 when $4x^3 - 31 = 1$
 $\therefore 4x^3 = 32$
 $\therefore x = 2$ and $f(2) = -46$
 Gradient = 1 at $(2, -46)$

b Points where the gradients equal 1 are where a tangent makes an angle of 45° to the axes.

12 a $\frac{d}{dt}(3t^2 - 4t) = 6t - 4$

b $\frac{d}{dx}(4 - x^2 + x^3) = -2x + 3x^2$

c $\frac{d}{dz}(5 - 2z^2 - z^4) = -4z - 4z^3$
 $= -4z(z^2 + 1)$

d $\frac{d}{dy}(3y^2 - y^3) = 6y - 3y^2$
 $= 3y(2 - y)$

e $\frac{d}{dx}(2x^3 - 4x^2) = 6x^2 - 8x$
 $= 2x(3x - 4)$

f $\frac{d}{dt}(9.8t^2 - 2t) = 19.6t - 2$

13 a $y = x^2, \therefore \frac{dy}{dx} = 2x$
 Gradient = 8 at $(4, 16)$

b $y = x^3, \therefore \frac{dy}{dx} = 3x^2 = 12, \therefore x = \pm 2$
 Gradient = 12 at $(-2, -8), (2, 8)$

c $y = x(2 - x) = 2x - x^2, \therefore \frac{dy}{dx} = 2 - 2x$
 Gradient = 2 where $x = 0$, i.e. at $(0, 0)$

d $y = x^2 - 3x + 1, \therefore \frac{dy}{dx} = 2x - 3$
 Gradient = 0 where
 $x = \frac{3}{2}$, i.e. at $\left(\frac{3}{2}, -\frac{5}{4}\right)$

e $y = x^3 - 6x^2 + 4, \frac{dy}{dx} = 3x^2 - 12x$
 Gradient = -12 where

$$3x^2 - 12x + 12 = 0$$

$$\therefore x^2 - 4x + 4 = 0$$

$$(x - 2)^2 = 0, \therefore x = 2$$

i.e. at $(2, -12)$

$$\mathbf{f} \quad y = x^2 - x^3 \quad \therefore \frac{dy}{dx} = 2x - 3x^2$$

Gradient = -1 where

$$-3x^2 + 2x + 1 = 0$$

$$\therefore 3x^2 - 2x - 1 = 0$$

$$(3x + 1)(x - 1) = 0$$

$$x = -\frac{1}{3}, 1$$

i.e. at $\left(-\frac{1}{3}, \frac{4}{27}\right)$ and $(1, 0)$

Solutions to Exercise 17C

1 a

$$\begin{aligned} \frac{f(x+h) - f(x)}{x+h-x} &= \frac{\frac{1}{x+h-3} - \frac{1}{x-3}}{x+h-x} \\ &= \frac{\frac{(x-3) - (x+h-3)}{(x+h-3)(x-3)}}{h} \\ &= \frac{-h}{(x+h-3)(x-3)} \times \frac{1}{h} \\ &= \frac{-1}{(x+h-3)(x-3)} \\ \lim_{h \rightarrow 0} \frac{-1}{(x+h-3)(x-3)} &= -\frac{1}{(x-3)^2} \end{aligned}$$

b

$$\begin{aligned} \frac{f(x+h) - f(x)}{x+h-x} &= \frac{\frac{1}{x+h+2} - \frac{1}{x+2}}{x+h-x} \\ &= \frac{\frac{(x+2) - (x+h+2)}{(x+h+2)(x+2)}}{h} \\ &= \frac{-h}{(x+h+2)(x+2)} \times \frac{1}{h} \\ &= \frac{-1}{(x+h+2)(x+2)} \\ \lim_{h \rightarrow 0} \frac{-1}{(x+h+2)(x+2)} &= -\frac{1}{(x+2)^2} \end{aligned}$$

2 a

$$\begin{aligned} \frac{f(x+h) - f(x)}{x+h-x} &= \frac{\frac{1}{(x+h)^2} - \frac{1}{x^2}}{x+h-x} \\ &= \frac{\frac{x^2 - (x+h)^2}{(x+h)^2 x^2}}{h} \\ &= \frac{x^2 - x^2 - 2xh - h^2}{(x+h)^2 x^2} \times \frac{1}{h} \\ &= \frac{-2xh - h^2}{(x+h)^2 x^2} \times \frac{1}{h} \\ &= \frac{-2x - h}{(x+h)^2 x^2} \end{aligned}$$

$$\lim_{h \rightarrow 0} \frac{-2x - h}{(x+h)^2 x^2} = -\frac{2}{x^3}$$

b

$$\begin{aligned} \frac{f(x+h) - f(x)}{x+h-x} &= \frac{\frac{1}{(x+h)^4} - \frac{1}{x^4}}{x+h-x} \\ &= \frac{\frac{x^4 - (x+h)^4}{(x+h)^2 x^2}}{h} \\ &= \frac{x^4 - (x^4 + 4x^3h + 6x^2h^2 + 4xh^3 + h^4)}{(x+h)^2 x^2} \\ &= \frac{-(4x^3h + 6x^2h^2 + 4xh^3 + h^4)}{(x+h)^4 x^4} \times \frac{1}{h} \\ &= \frac{-(4x^3 + 6xh + 4xh^2 + h^3)}{(x+h)^4 x^4} \\ \lim_{h \rightarrow 0} \frac{-(4x^3 + 6xh + 4xh^2 + h^3)}{(x+h)^4 x^4} &= -\frac{4x^3}{x^8} \\ &= -\frac{4}{x^5} \end{aligned}$$

3 a $\frac{d}{dx}(3x^{-2} + 5x^{-1} + 6) = -6x^{-3} - 5x^{-2}$

b $\frac{d}{dx}\left(\frac{3}{x^2} + 5x^2\right) = -\frac{6}{x^3} + 10x$

c $\frac{d}{dx}\left(\frac{5}{x^3} + \frac{4}{x^2} + 1\right) = -\frac{15}{x^4} - \frac{8}{x^3}$

d $\frac{d}{dx}\left(3x^2 + \frac{5}{3}x^{-4} + 2\right) = 6x - \frac{20}{3}x^{-5}$

e $\frac{d}{dx}(6x^{-2} + 3x) = -12x^{-3} + 3$

f $\frac{d}{dx}\frac{3x^2 + 2}{x} = \frac{d}{dx}\left(3x + \frac{2}{x}\right)$
 $= 3 - \frac{2}{x^2}$

4 $z \neq 0$ throughout

$$\begin{aligned} \mathbf{a} \quad \frac{d}{dz} \frac{3z^2 + 2z + 4}{z^2} &= \frac{d}{dz} \left(3 + \frac{2}{z} + \frac{4}{z^2} \right) \\ &= -\frac{2}{z^2} - \frac{8}{z^3} \end{aligned}$$

$$\begin{aligned} \mathbf{b} \quad \frac{d}{dz} \frac{3+z}{z^3} &= \frac{d}{dz} \left(\frac{3}{z^3} + \frac{1}{z^2} \right) \\ &= -\frac{9}{z^4} - \frac{2}{z^3} \end{aligned}$$

$$\mathbf{c} \quad \frac{d}{dz} \frac{2z^2 + 3z}{4z} = \frac{d}{dz} \left(\frac{z}{2} + \frac{3}{4} \right) = \frac{1}{2}$$

$$\mathbf{d} \quad \frac{d}{dz} (9z^2 + 4z + 6z^{-3}) = 18z + 4 - 18z^{-4}$$

$$\mathbf{e} \quad \frac{d}{dz} (9 - z^{-2}) = -2z^{-3}$$

$$\mathbf{f} \quad \frac{d}{dz} \frac{5z - 3z^2}{5z} = \frac{d}{dz} \left(5 - \frac{3z}{5} \right) = -\frac{3}{5}$$

$$\mathbf{5} \quad \mathbf{a} \quad f'(x) = 12x^3 + 18x^{-4} - x^{-2}$$

$$\mathbf{b} \quad f'(x) = 20x^3 - 8x^{-3} - x^{-2}$$

$$\mathbf{6} \quad f(x) = \frac{1}{x^2}; x \neq 0$$

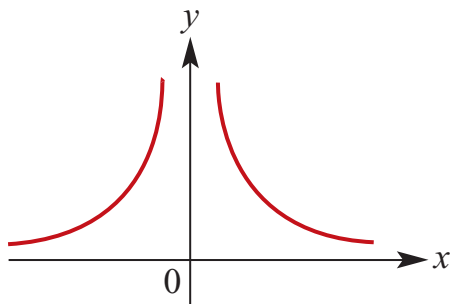

$$\mathbf{a} \quad P = (1, f(1)); Q = (1 + h, f(1 + h))$$

$$\begin{aligned} PQ's \text{ gradient} &= \frac{\frac{1}{(1+h)^2} - 1}{h} \\ &= \frac{1 - 1 - 2h - h^2}{h(1+h^2)} \\ &= \frac{-2-h}{1+h^2} \end{aligned}$$

$$\mathbf{b} \quad f(x) = \frac{1}{x^2} \text{ has gradient of } -2 \text{ at } x = 1$$

$$\mathbf{c} \quad \text{Normal at } (1, 1) \text{ has gradient} = \frac{1}{2}:$$

$$y - 1 = \frac{1}{2}(x - 1), \therefore y = \frac{1}{2}(x + 1)$$

$$\mathbf{7} \quad \mathbf{a} \quad y = x^{-2} + x^3, \therefore y' = -2x^{-3} + 3x^2$$

$$\therefore y'(2) = -\frac{2}{8} + 12 = \frac{47}{4}$$

$$\mathbf{b} \quad y = \frac{x-2}{x} = 1 - \frac{2}{x}, \therefore y' = \frac{2}{x^2}$$

$$\therefore y'(4) = \frac{2}{16} = \frac{1}{8}$$

$$\mathbf{c} \quad y = x^{-2} - \frac{1}{x}, \therefore y' = -\frac{2}{x^3} + \frac{1}{x^2}$$

$$\therefore y'(1) = -2 + 1 = -1$$

$$\mathbf{d} \quad y = x(x^{-1} + x^2 - x^{-3}) = 1 + x^3 - x^{-2}$$

$$\therefore y' = 3x^2 + 2x^{-3}$$

$$\therefore y'(1) = 3 + 2 = 5$$

$$\mathbf{8} \quad f(x) = x^{-2}, \therefore f'(x) = -2x^{-3}; x > 0$$

$$\mathbf{a} \quad f'(x) = -2x^{-3} = 16, \therefore x^3 = -\frac{1}{8}$$

$$\therefore x = -\frac{1}{2}$$

$$\mathbf{b} \quad f'(x) = -2x^{-3} = -16, \therefore x^3 = \frac{1}{8}$$

$$\therefore x = \frac{1}{2}$$

$$\mathbf{9} \quad f'(x) = -x^{-2} = -\frac{1}{x^2} < 0 \text{ for all non-zero } x$$

Solutions to Exercise 17D

1 $\frac{dy}{dx} = \text{gradient}$

a $\frac{dy}{dx} < 0$ for all x

b $\frac{dy}{dx} > 0$ for all x

c $\frac{dy}{dx}$ varies in sign

d $\frac{dy}{dx} > 0$ for all x

e $\frac{dy}{dx} > 0$ for all $x > 0$ and $\frac{dy}{dx} < 0$ for all $x < 0$

Gradient is uniformly positive for **b** and **d** only.

2 $\frac{dy}{dx} = \text{gradient}$:

a $\frac{dy}{dx} < 0$ for all x

b $\frac{dy}{dx} < 0$ for all x

c $\frac{dy}{dx}$ varies in sign

d $\frac{dy}{dx}$ varies in sign

e $\frac{dy}{dx} < 0$ for all x

f $\frac{dy}{dx} = 0$ for all x

Gradient is uniformly negative for **a**, **b** and **e** only.

3 $f(x) = 2(x - 1)^2$

a $f(x) = 0, \therefore 2(x - 1)^2 = 0$
 $x = 1$

b $f'(x) = 4x - 4 = 0, \therefore x = 1$

c $f'(x) = 4x - 4 > 0, \therefore x > 1$

d $f'(x) = 4x - 4 < 0, \therefore x < 1$

e $f'(x) = 4x - 4 = -2$

$$4x = 2, \therefore x = \frac{1}{2}$$

4 a $\{x: h'(x) > 0\}$

$$= \{x: x < -3\} \cup \{x: \frac{1}{2} < x < 4\}$$

b $\{x: h'(x) < 0\}$

$$= \{x: -3 < x < \frac{1}{2}\} \cup \{x: x > 4\}$$

c $\{x: h'(x) = 0\} = \{-3, \frac{1}{2}, 4\}$

5 a $\frac{dy}{dx} < 0$ for $x < 0$, $\frac{dy}{dx} = 0$ at $x = 0$,

$$\frac{dy}{dx} > 0 \text{ for } x > 0$$

$$\therefore \frac{dy}{dx} = \text{line } y = kx, k > 0 \quad \mathbf{B}$$

b $\frac{dy}{dx} > 0$ for $x < 0$ and $x > a > 0$,

$$\frac{dy}{dx} = 0 \text{ at } x = 0 \text{ and } a, \frac{dy}{dx} < 0 \text{ for}$$

$$0 < x < a$$

$$\therefore \frac{dy}{dx} = \text{curve like a parabola}$$

$$y = kx(x - a) \quad \mathbf{C}$$

c $\frac{dy}{dx} < 0$ for all x except $\frac{dy}{dx} = 0$ at $x = 0$ and a ,
 $\therefore \frac{dy}{dx} = \text{curve where } y \leq 0 \text{ for all } x$ **D**

d $\frac{dy}{dx} > 0$ for $x < a > 0$, $\frac{dy}{dx} = 0$ at $x = a$,
 $\frac{dy}{dx} > 0$ for $x > a$,
 $\therefore \frac{dy}{dx} = \text{line } y = -k(x - a), k > 0$ **A**

e $y = -k, k > 0$ for all x so $\frac{dy}{dx} = 0$ **F**

f $y = kx + c; k, c > 0$ so $\frac{dy}{dx} = k$ **E**

6 a $\{x: f'(x) > 0\} = \{x: x < 3\}$
 $\{x: f'(x) < 0\} = \{x: x > 3\}$
 $\{x: f'(x) = 0\} = \{3\}$
 $\therefore f'(x) = -k(x - 3), k > 0$

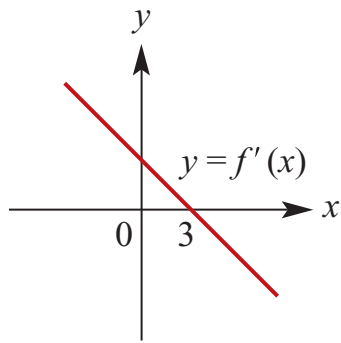

b $f(x) = 1 - x$
 $\therefore f'(x) = -1$

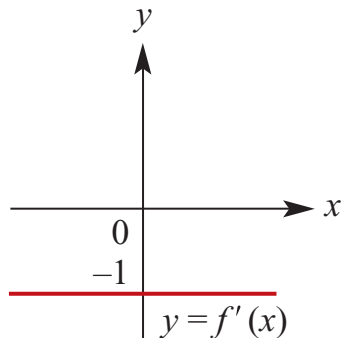

c
 $\{x: f'(x) > 0\} = \{x: -1 < x < 3\}$
 $\{x: f'(x) < 0\} = \{x: x < -1\} \cup \{x: x > 3\}$
 $\{x: f'(x) = 0\} = \{-1, 3\}$
 $\therefore f'(x) = -k(x - 3)(x + 1), k > 0$

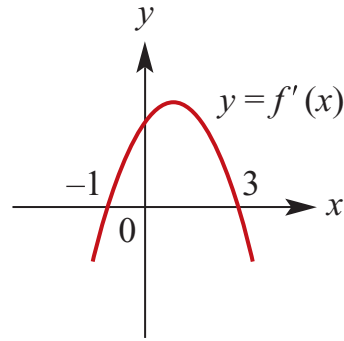

d $f(x) = 3$
 $\therefore f'(x) = 0$

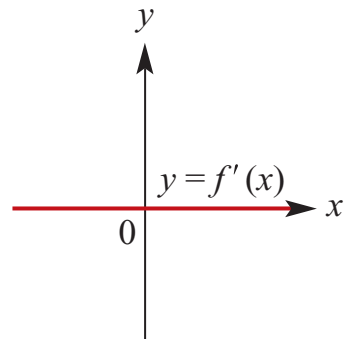

7 a $\{x: f'(x) > 0\} = \{x: -1 < x < 1.5\}$

b $\{x: f'(x) < 0\}$
 $= \{x: x < -1\} \cup \{x: x > 1.5\}$

c $\{x: f'(x) = 0\} = \{-1, 1.5\}$

8 $y = x^2 - 5x + 6, \therefore \frac{dy}{dx} = 2x - 5$

a Tangent makes an angle of 45° with the positive direction of the x -axis

$\therefore \text{gradient} = 1$

$\therefore \frac{dy}{dx} = 2x - 5 = 1, \therefore x = 3$

$y(3) = 0$ so coordinates are $(3, 0)$.

b Tangent parallel to $y = 3x + 4$

\therefore gradient = 3

$\therefore \frac{dy}{dx} = 2x - 5 = 3, \therefore x = 4$

$y(4) = 2$ so coordinates are $(4, 2)$.

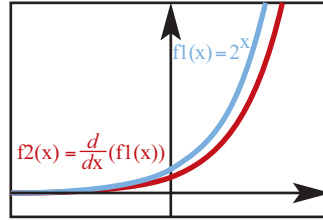

9 $y = x^2 - x - 6, \therefore \frac{dy}{dx} = 2x - 1$

a $\frac{dy}{dx} = 2x - 1 = 0, \therefore x = \frac{1}{2}$

$y\left(\frac{1}{2}\right) = -\frac{25}{4}$ so coordinates are $\left(\frac{1}{2}, -\frac{25}{4}\right)$.

b Tangent parallel to $x + y = 6$

\therefore gradient = -1

$\therefore \frac{dy}{dx} = 2x - 1 = -1, \therefore x = 0$

$y(0) = -6$ so coordinates are $(0, -6)$.

10 a $f(x) = \sin x$

$f'(x)$

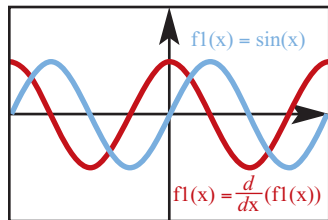

b $f(x) = \cos x$

$f'(x)$

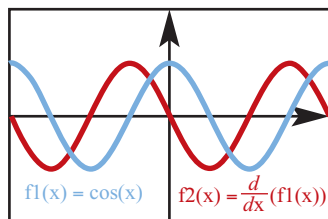

c $f(x) = 2^x$

$f'(x)$

11 a i 66.80°

ii 42.51°

b $(0.5352, 0.2420)$

c No

12 $S(t) = (0.2)t^3$ m

a Speed = $s'(t) = 0.6t^2$ m/s

b $s'(1) = 0.6(1)^2 = 0.6$ m/s

$S'(3) = 0.6(3)^2 = 5.4$ m/s

$S'(5) = 0.6(5)^2 = 15$ m/s

13 $y = ax^2 + bx$

a $y(2) = -2, \therefore 4a + 2b = -2$

$y'(x) = 2ax + b$

$\therefore y'(2) = 4a + b = 3$

$\therefore b = -5, a = 2$

b $\frac{dy}{dx} = 4x - 5 = 0, \therefore x = \frac{5}{4}$

$y\left(\frac{5}{4}\right) = 4\left(\frac{5}{4}\right)^2 - 5\left(\frac{5}{4}\right)$

$= \frac{25}{4} - \frac{25}{4} = -\frac{25}{8}$

Coordinates are $\left(\frac{5}{4}, -\frac{25}{8}\right)$.

14 $h(t) = 20t^2, 0 \leq t \leq 150$

a $h(150) = 20(150)^2 = 450\,000$ m
 $h'(t) = 40t, \therefore h'(150) = 6000$ m/s

b $h'(t) = 40t = 1000$
 $\therefore t = \frac{1000}{40} = 25$ sec

Solutions to Exercise 17E

$$1 \text{ a } \int \frac{1}{2}x^3 dx = \frac{1}{8}x^4 + c$$

$$b \int 3x^2 - 2 dx = x^3 - 2x + c$$

$$c \int 5x^3 - 2x dx = \frac{5}{4}x^4 - x^2 + c$$

$$d \int \frac{4}{5}x^3 - 2x^2 dx = \frac{1}{5}x^4 - \frac{2}{3}x^3 + c$$

$$e \int (x-1)^2 dx = \int x^2 - 2x + 1 dx \\ = \frac{x^3}{3} - x^2 + x + c$$

$$f \int x\left(x + \frac{1}{x}\right) dx = \int x^2 + 1 dx \\ = \frac{1}{3}x^3 + x + c$$

$$g \int 2z^2(z-1) dz = \int 2z^3 - 2z^2 dz \\ = \frac{1}{2}z^4 - \frac{2}{3}z^3 + c$$

$$h \int (2t-3)^2 dt = \int 4t^2 - 12t + 9 dt \\ = \frac{4t^3}{3} - 6t^2 + 9t + c$$

$$i \int (t-1)^3 dt = \int t^3 - 3t^2 + 3t - 1 dt \\ = \frac{t^4}{4} - t^3 + \frac{3t^2}{2} - t + c$$

$$2 \quad f'(x) = 4x^3 + 6x^2 + 2 \\ \therefore f(x) = x^4 + 2x^3 + 2x + c$$

$$\text{We have, } f(0) = 0$$

$$\therefore c = 0$$

$$\therefore f(x) = x^4 + 2x^3 + 2x$$

$$3 \quad f'(x) = 6x^2 \\ \therefore f(x) = 2x^3 + c$$

$$\text{We have, } f(0) = 12$$

$$\therefore c = 12$$

$$\therefore f(x) = 2x^3 + 12$$

$$4 \text{ a } \frac{dy}{dx} = 2x - 1, \therefore y = x^2 - x + c$$

$$y(1) = c = 0, \therefore y = x^2 - x$$

$$b \frac{dy}{dx} = 3 - x, \therefore y = 3x - \frac{1}{2}x^2 + c$$

$$y(0) = c = 1, \therefore y = -\frac{1}{2}x^2 + 3x + 1$$

$$c \frac{dy}{dx} = x^2 + 2x, \therefore y = \frac{1}{3}x^3 + x^2 + c$$

$$y(0) = c = 2, \therefore y = \frac{1}{3}x^3 + x^2 + 2$$

$$d \frac{dy}{dx} = 3 - x^2, \therefore y = 3x - \frac{1}{3}x^3 + c$$

$$y(3) = c = 2, \therefore y = -\frac{1}{3}x^3 + 3x + 2$$

$$e \frac{dy}{dx} = 2x^4 + x, \therefore y = \frac{2}{5}x^5 + \frac{1}{2}x^2 + c$$

$$y(0) = c = 0, \therefore y = \frac{2}{5}x^5 + \frac{1}{2}x^2$$

$$5 \quad \frac{dV}{dt} = t^2 - t, t > 1$$

$$a \quad V(t) = \frac{1}{3}t^3 - \frac{1}{2}t^2 + c$$

$$V(3) = 9 - \frac{9}{2} + c = 9$$

$$c = \frac{9}{2}$$

$$\begin{aligned}\mathbf{b} \quad V(10) &= \frac{1000}{3} - \frac{100}{2} + \frac{9}{2} \\ &= \frac{1727}{6} \approx 287.33\end{aligned}$$

$$\begin{aligned}\mathbf{6} \quad f'(x) &= 3x^2 - 1, \therefore f(x) = x^3 - x + c \\ f(1) &= c = 2, \therefore f(x) = x^3 - x + 2\end{aligned}$$

7 a Only **B** has the correct gradient (negative) with the correct axis intercept.

b $\frac{dw}{dt} = 2000 - 20t, t > 0$
 $w = 2000t - 10t^2 + c, t \geq 0$
 $w(0) = c = 100\,000$
 $\therefore w = -10t^2 + 2000t + 100\,000$

8 $\frac{dy}{dx} = 5 - x, \therefore f(x) = 5x - \frac{1}{2}x^2 + c$
 $f(0) = c = 4, \therefore f(x) = -\frac{1}{2}x^2 + 5x + 4$

9 $f(x) = x^2(x - 3) = x^3 - 3x^2$
 $\therefore f(x) = \frac{1}{4}x^4 - x^3 + c$
 $f(2) = 4 - 8 + c = -6, \therefore c = -2$
 $\therefore f(x) = \frac{1}{4}x^4 - x^3 - 2$

10 $f'(x) = 4x + k, \therefore f(x) = 2x^2 + kx + c$

a $f'(-2) = -8 + k = 0$
 $k = 8$

b $f(-2) = 8 - 16 + c = -1, \therefore c = 7$
 $\therefore f(x) = 2x^2 + 8x + 7$
 $\therefore f(0) = 7$

Curve meets y-axis at (0, 7)

11 $\frac{dy}{dx} = ax^2 + 1, \therefore y = \frac{a}{3}x^3 + x + c$
 $y'(1) = a + 1 = 3, \therefore a = 2$
 $y(1) = \frac{2}{3} + 1 + c = 3, \therefore c = \frac{4}{3}$

$$\begin{aligned} \therefore y(2) &= \frac{2}{3}(2)^3 + 2 + \frac{4}{3} \\ &= \frac{26}{3} \end{aligned}$$

12 $\frac{dy}{dx} = 2x + k, \therefore y'(3) = 6 + k$

a Tangent: $y - 6 = (6 + k)(x - 3)$
 $y = (6 + k)x - 12 - 3k$
Tangent passes through (0, 0),
 $\therefore k = -4$

b $y = \int 2x - 4 dx = x^2 - 4x + c$
 $y(3) = 9 - 12 + c = 6, \therefore c = 9$
 $\therefore y = x^2 - 4x + 9$

13 $f'(x) = 16x + k$

a $y'(2) = 32 + k = 0$
 $k = -32$

b $f(x) = \int 16x - 32 dx$
 $= 8x^2 - 32x + c$
 $f(2) = 32 - 64 + c = 1, \therefore c = 33$
 $\therefore f(7) = 8(7)^2 - 32(7) + 33$
 $= 201$

14 $f'(x) = x^2, \therefore f(x) = \frac{1}{3}x^3 + c$
 $f(2) = \frac{8}{3} + c = 1, \therefore c = -\frac{5}{3}$
 $\therefore f(x) = \frac{1}{3}(x^3 - 5)$

Solutions to Exercise 17F

1 a $\lim_{x \rightarrow 3} 15 = 15$

b $\lim_{x \rightarrow 6} (x - 5) = 6 - 5 = 1$

c $\lim_{x \rightarrow \frac{1}{2}} (3x - 5) = \frac{3}{2} - 5 = -\frac{7}{2}$

d $\lim_{t \rightarrow -3} \frac{t - 2}{t + 5} = \frac{-3 - 2}{-3 + 5} = -\frac{5}{2}$

e $\lim_{t \rightarrow -1} \frac{t^2 + 2t + 1}{t + 1} = \frac{(t + 1)^2}{t + 1}$
 $= \lim_{t \rightarrow -1} t + 1 = 0$

f $\lim_{x \rightarrow 0} \frac{(x + 2)^2 - 4}{x} = \frac{x^2 + 4x}{x}$
 $= \lim_{x \rightarrow 0} x + 4 = 4$

g $\lim_{t \rightarrow 1} \frac{t^2 - 1}{t - 1} = \frac{(t - 1)(t + 1)}{t - 1}$
 $= \lim_{t \rightarrow 1} t + 1 = 2$

h $\lim_{x \rightarrow 9} \sqrt{x + 3} = \sqrt{12} = 2\sqrt{3}$

i $\lim_{x \rightarrow 0} \frac{x^2 - 2x}{x} = x - 2 = -2$

j $\lim_{x \rightarrow 2} \frac{x^3 - 8}{x - 2} = \frac{(x - 2)(x^2 + 2x + 4)}{x - 2}$
 $= \lim_{x \rightarrow 2} x^2 + 2x + 4 = 12$

k $\lim_{x \rightarrow 2} \frac{3x^2 - x - 10}{x^2 + 5x - 14} = \frac{(x - 2)(3x + 5)}{(x - 2)(x + 7)}$
 $= \lim_{x \rightarrow 2} \frac{3x + 5}{x + 7} = \frac{11}{9}$

l $\lim_{x \rightarrow 1} \frac{x^2 - 3x + 2}{x^2 - 6x + 5} = \frac{(x - 1)(x - 2)}{(x - 1)(x - 5)}$
 $= \lim_{x \rightarrow 1} \frac{x - 2}{x - 5} = \frac{1}{4}$

2 a Discontinuities at $x = 3$ and 4 , because at $x = 3$, $f(x)$ is not defined, and the right limit of $f(x)$ at $x = 4$ is not equal to $f(4)$. ($x = 1$ is not a discontinuity, although the function is not differentiable there.)

b There is a discontinuity at $x = 7$, because the right limit of $f(x)$ at $x = 7$ is not equal to $f(7)$.

3 a $f(x) = 3x$ if $x \geq 0$, $-2x + 2$ if $x < 0$
 Discontinuity at $x = 0$: $f(0) = 0$, but $\lim_{x \rightarrow 0^+} f(x) = 0$, $\lim_{x \rightarrow 0^-} f(x) = 2$

b $f(x) = x^2 + 2$ if $x \geq 1$, $-2x + 1$ if $x < 1$
 Discontinuity at $x = 1$: $f(1) = 3$, but $\lim_{x \rightarrow 1^+} f(x) = 3$, $\lim_{x \rightarrow 1^-} f(x) = -1$

c $f(x) = -x$ if $x \leq -1$
 $f(x) = x^2$ if $-1 < x < 0$
 $f(x) = -3x + 1$ if $x \geq 0$
 Discontinuity at $x = 0$: $f(0) = 1$, but $\lim_{x \rightarrow 0^+} f(x) = 1$, $\lim_{x \rightarrow 0^-} f(x) = 0$
 $x = -1$ is not a discontinuity, since $f(-1) = 1$
 $\lim_{x \rightarrow (-1)^+} f(x) = 1$, $\lim_{x \rightarrow (-1)^-} f(x) = 1$

4 $y = \begin{cases} 2; & x < 1 \\ (x - 4)^2 - 9; & 1 \leq x < 7 \\ x - 7; & x \geq 7 \end{cases}$

Discontinuity at $x = 1$: $y(1) = 0$, but $\lim_{x \rightarrow 1^+} y(x) = 0$, $\lim_{x \rightarrow 1^-} y(x) = 2$
 $x = 7$ is not a discontinuity, since $y(7) = 0$

$\lim_{x \rightarrow 7^+} y(x) = 0$, $\lim_{x \rightarrow 7^-} y(x) = 0$

Solutions to Exercise 17G

1 a

x	-1	-0.5	0.2	0	0.2	0.5	1
$f'(x)$	+	0	-	0	+	0	-

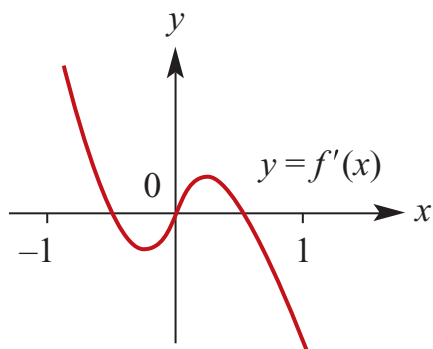

b

x	-4	-3	-2	0	1	2	3	4	5
$f'(x)$	+	0	-	0	+	0	-	0	+

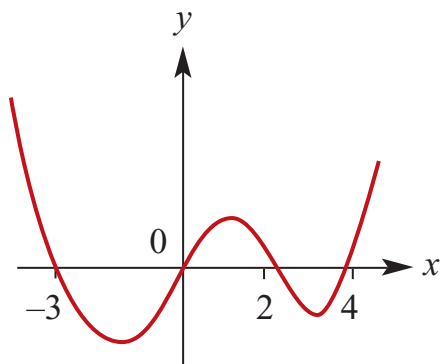

- c For $x < 0$, $f'(x) = -k$, $k > 0$
 For $x > 0$, $f'(x) = k$, $k > 0$
 At $x = 0$, $f'(x)$ is undefined since $f(x)$ is not differentiable at that point.

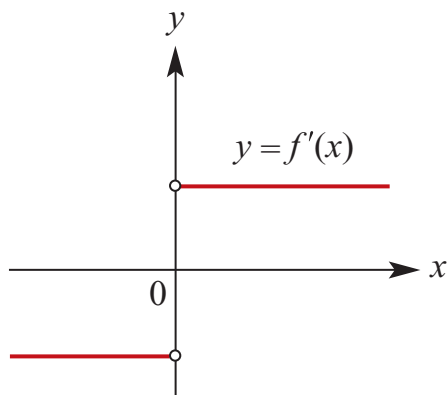

d For all x , $f'(x) = k$, $k > 0$

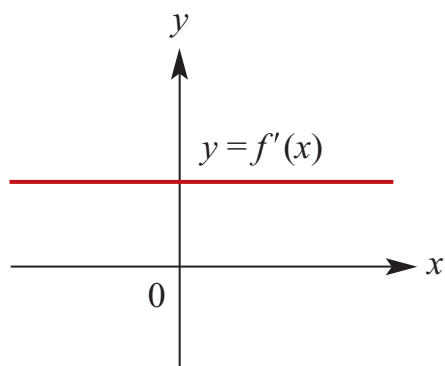

- e $f'(x)$ only exists for $\{x: -1 < x < 1\} \setminus \{0\}$
 For $-1 < x < 0$, $f'(x) < 0$
 For $0 < x < 1$, $f'(x) > 0$
 At $x = 0$, $f'(x)$ is undefined since $f(x)$ is not differentiable at that point.

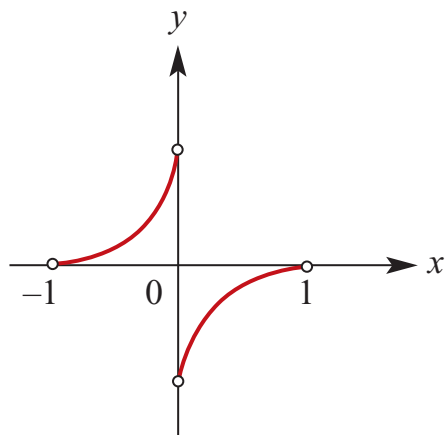

- f $f'(x)$ is undefined at four points over $[-1, 1]$ and is positive at both ends, alternating + to - between the undefined points:

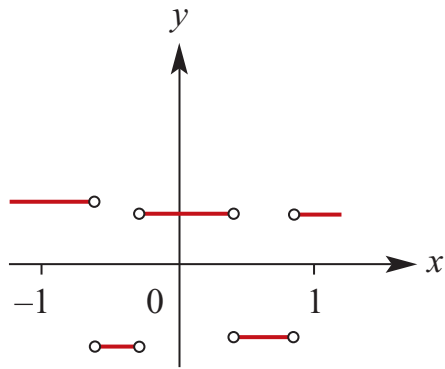

- 2 $f(x) = -x^2 + 3x + 1$ if $x \geq 0$
 $f(x) = 3x + 1$ if $x < 0$
 $\therefore f'(x) = -2x + 3$ if $x \geq 0$
 $f'(x) = 3$ if $x < 0$
 $f(x)$ is differentiable at $x = 0$
because both $f(x)$ and $f'(x)$
are continuous at that point.

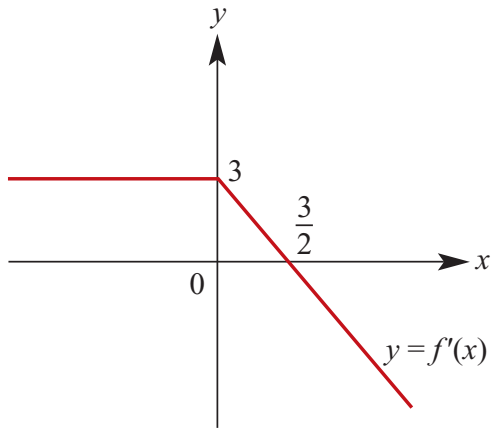

- 3 $f(x) = x^2 + 2x + 1$ if $x \geq 1$
 $f(x) = -2x + 3$ if $x < 1$
 $\therefore f'(x) = 2x + 2$ if $x > 1$
 $f'(x) = -2$ if $x < 1$

$f(x)$ is not differentiable at $x = 0$
because both $f(x)$ and $f'(x)$ are
discontinuous at that point.
 $\therefore f'(x)$ is defined over $R/\{1\}$

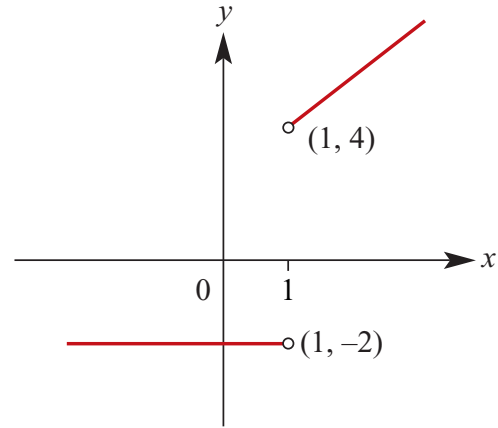

- 4 $f(x) = -x^2 - 3x + 1$ if $x \geq -1$
 $f(x) = -2x + 3$ if $x < -1$
 $\therefore f'(x) = -2x - 3$ if $x > -1$
 $f(x) = -2$ if $x < -1$
 $f(x)$ is not differentiable at $x = -1$
because both $f(x)$ and $f'(x)$ are
discontinuous at that point.
 $\therefore f'(x)$ is defined over $R/\{-1\}$

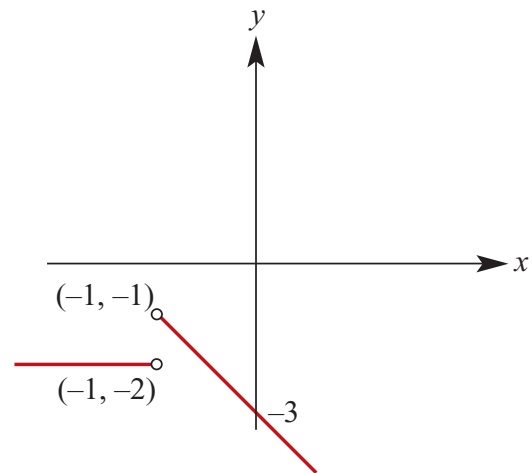

Solutions to Technology-free questions

1 a

$$\begin{aligned}\frac{f(x+h) - f(x)}{x+h-x} &= \frac{3(x+h) + 1 - (3x+1)}{x+h-x} \\ &= \frac{3h}{h} \\ &= 3\end{aligned}$$

$$\lim_{h \rightarrow 0} 3 = 3$$

$$\begin{aligned}\frac{f(x+h) - f(x)}{x+h-x} &= \frac{(x+h)^2 + 2(x+h) + 1 - (x^2 + 2x + 1)}{x+h-x} \\ &= \frac{x^2 + 2xh + h^2 + 2x + 2h + 1 - x^2 - 2x - 1}{h} \\ &= \frac{2xh + h^2 + 2h}{h}\end{aligned}$$

$$= 2x + h + 2$$

$$\lim_{h \rightarrow 0} 2x + h + 2 = 2x + 2$$

b

$$\begin{aligned}\frac{f(x+h) - f(x)}{x+h-x} &= \frac{4 - (x+h)^2 - (4 - x^2)}{x+h-x} \\ &= \frac{4 - x^2 - 2xh - h^2 - 4 + x^2}{h} \\ &= \frac{-2xh - h^2}{h} \\ &= -2x - h\end{aligned}$$

$$\lim_{h \rightarrow 0} -2x - h = -2x$$

f

$$\begin{aligned}\frac{f(x+h) - f(x)}{x+h-x} &= \frac{3(x+h)^2 - (x+h) - (3x^2 - x)}{x+h-x} \\ &= \frac{3x^2 + 6xh + 3h^2 - x - h - 3x^2 + x}{h} \\ &= \frac{6xh + 3h^2 - h}{h}\end{aligned}$$

$$= 6x + 3h - 1$$

$$\lim_{h \rightarrow 0} 6x + 3h - 1 = 6x - 1$$

c

$$\begin{aligned}\frac{f(x+h) - f(x)}{x+h-x} &= \frac{(x+h)^2 + 5(x+h) - (x^2 + 5x)}{x+h-x} \\ &= \frac{x^2 + 2xh + h^2 + 5x + 5h - x^2 - 5x}{h} \\ &= \frac{2xh + h^2 + 5h}{h}\end{aligned}$$

$$= 2x + h + 5$$

$$\lim_{h \rightarrow 0} 2x + h + 5 = 2x + 5$$

d

$$\begin{aligned}\frac{f(x+h) - f(x)}{x+h-x} &= \frac{(x+h)^3 + (x+h) - (x^3 + x)}{x+h-x} \\ &= \frac{x^3 + 3x^2h + 3xh^2 + x + h - x^3 - x}{h} \\ &= \frac{3x^2h + 3xh^2 + h}{h}\end{aligned}$$

$$= 3x^2 + 3xh + 1$$

$$\lim_{h \rightarrow 0} 3x^2 + 3xh + 1 = 3x^2 + 1$$

e

2 a $y = 3x^2 - 2x + 6$

$$\therefore \frac{dy}{dx} = 6x - 2$$

b $y = 5, \therefore \frac{dy}{dx} = 0$

c $y = 2x(2-x) = 4x - 2x^2$

$$\therefore \frac{dy}{dx} = 4 - 4x$$

d $y = 4(2x-1)(5x+2)$

$$= 40x^2 - 4x - 8$$

$$\therefore \frac{dy}{dx} = 80x - 4 = 4(20x - 1)$$

e $y = (x+1)(3x-2)$

$$= 3x^2 + x - 2$$

$$\therefore \frac{dy}{dx} = 6x + 1$$

- f** $y = (x + 1)(2 - 3x)$
 $= -3x^2 - x + 2$
 $\therefore \frac{dy}{dx} = -6x - 1$
- 3 a** $y = -x, \therefore \frac{dy}{dx} = -1$
- b** $y = 10, \therefore \frac{dy}{dx} = 0$
- c** $y = \frac{(x + 3)(2x + 1)}{4}$
 $= \frac{1}{2}x^2 + \frac{7}{4}x + \frac{3}{4}$
 $\therefore \frac{dy}{dx} = x + \frac{7}{4}$
- d** $y = \frac{2x^3 - x^2}{31} = \frac{2}{3}x^2 - \frac{1}{3}x, x \neq 0$
 $\therefore \frac{dy}{dx} = \frac{4}{3}x - \frac{1}{3} = \frac{1}{3}(4x - 1), x \neq 0$
- e** $y = \frac{x^4 + 3x^2}{2x^2} = \frac{1}{2}x^2 + 3, x \neq 0$
 $\therefore \frac{dy}{dx} = x, x \neq 0$
- 4 a** $y = x^2 - 2x + 1, \therefore \frac{dy}{dx} = 2x - 2$
 At $x = 2, y = 1$ and gradient = 2
- b** $y = x^2 - 2x, \therefore \frac{dy}{dx} = 2x - 2$
 At $x = -1, y = 3$ and gradient = -4
- c** $y = (x + 2)(x - 4) = x^2 - 2x - 8$
 $\therefore \frac{dy}{dx} = 2x - 2$
 At $x = 3, y = -5$ and gradient = 4
- d** $y = 3x^2 - 2x^3, \therefore \frac{dy}{dx} = 6x - 6x^2$
 At $x = -2, y = 28$ and gradient = -36
- 5 a** $y = x^2 - 3x + 1, \therefore \frac{dy}{dx} = 2x - 3$
 $\frac{dy}{dx} = 0, \therefore 2x - 3 = 0$
 $x = \frac{3}{2}$
 $y\left(\frac{3}{2}\right) = \frac{9}{4} - \frac{9}{2} + 1 = -\frac{5}{4}$
 Coordinates are $\left(\frac{3}{2}, -\frac{5}{4}\right)$
- b** $y = x^3 - 6x^2 + 4, \therefore \frac{dy}{dx} = 3x^2 - 12x$
 $\frac{dy}{dx} = -12, \therefore 3x^2 - 12x = -12$
 $x^2 - 4x + 4 = 0$
 $(x - 2)^2 = 0, \therefore x = 2$
 $y(2) = 8 - 24 + 4 = -12$
 Coordinates are (2, -12)
- c** $y = x^2 - x^3, \therefore \frac{dy}{dx} = 2x - 3x^2$
 $\frac{dy}{dx} = -1, \therefore -3x^2 + 2x + 1 = 0$
 $3x^2 - 2x - 1 = 0$
 $(3x + 1)(x - 1) = 0$
 $\therefore x = -\frac{1}{3}, 1$
 $y\left(-\frac{1}{3}\right) = \frac{4}{27}, y(1) = 0$
 Coordinates are $\left(-\frac{1}{3}, \frac{4}{27}\right)$ and (1, 0)
- d** $y = x^3 - 2x + 7, \therefore \frac{dy}{dx} = 3x^2 - 2$
 $\frac{dy}{dx} = 1, \therefore 3x^2 - 2 = 1$
 $3x^2 = 3, \therefore x = \pm 1$
 $y(-1) = 8; y(1) = 6$
 Coordinates are (-1, 8) and (1, 6)
- e** $y = x^4 - 2x^3 + 1, \therefore \frac{dy}{dx} = 4x^3 - 6x^2$

$$\frac{dy}{dx} = 0, \therefore 4x^3 - 6x^2 = 0$$

$$2x^2(2x - 3) = 0, \therefore x = 0, \frac{3}{2}$$

$$y(0) = 1; y\left(\frac{3}{2}\right) = \frac{81}{16} - \frac{27}{4} + 1 = -\frac{11}{16}$$

Coordinates are $(0, 1)$ and $\left(\frac{3}{2}, -\frac{11}{16}\right)$

f

$$y = x(x - 3)^2 = x^3 - 6x^2 + 9x$$

$$\therefore \frac{dy}{dx} = 3x^2 - 12x + 9 = 3(x^2 - 4x + 3)$$

$$\frac{dy}{dx} = 0, \therefore x^2 - 4x + 3 = 0$$

$$(x - 1)(x - 3) = 0 \therefore x = 1, 3$$

$$y(1) = 4; y(3) = 0$$

Coordinates are $(1, 4)$ and $(3, 0)$

6 $f(x) = 3(2x - 1)^2 = 12x^2 - 12x + 3$

$$\therefore f'(x) = 24x - 12 = 12(2x - 1)$$

a $f(x) = 0, \therefore 2x - 1 = 0$

$$x = \frac{1}{2}$$

b $f'(x) = 0, \therefore 2x - 1 = 0$

$$x = \frac{1}{2}$$

c $f'(x) > 0, \therefore 2x - 1 > 0$

$$x > \frac{1}{2}$$

d $f'(x) < 0, \therefore 2x - 1 < 0$

$$x < \frac{1}{2}$$

e $f'(x) > 0, \therefore 3(2x - 1)^2 > 0$

$$\{x: x \in \mathbb{R} \setminus \{\frac{1}{2}\}\}$$

f $f'(x) = 3, \therefore 24x - 12 = 3$

$$24x = 15$$

$$x = \frac{5}{8}$$

7 a $\frac{d}{dx}x^{-4} = -4x^{-5}$

b $\frac{d}{dx}2x^{-3} = -6x^{-4}$

c $\frac{d}{dx} \frac{1}{3x^2} = -\frac{1}{3} \frac{d}{dx}x^{-2} = \frac{2}{3x^3}$

d $\frac{d}{dx} \frac{1}{x^4} = -(-4)x^{-5} = \frac{4}{x^5}$

e $\frac{d}{dx} \frac{3}{x^5} = -15x^{-6} = -\frac{15}{x^6}$

f $\frac{d}{dx} \frac{x^2 + x^3}{x^4} = \frac{d}{dx}x^{-2} + x^{-1} = -\frac{2}{x^3} - \frac{1}{x^2}$

g $\frac{d}{dx} \frac{3x^2 + 2x}{x^2} = \frac{d}{dx} \left(3 + \frac{2}{x}\right) = -\frac{2}{x^2}$

h $\frac{d}{dx} \left(5x^2 - \frac{2}{x}\right) = 10x + \frac{2}{x^2}$

8 $y = ax^2 + bx$

$$\therefore \frac{dy}{dx} = 2ax + b$$

a Using $(1, 1)$: $a + b = 1$

Gradient = 3: $2a + b = 3$

$$\therefore a = 2, b = -1$$

b $\frac{dy}{dx} = 0, \therefore 2ax + b = 0$

$$\therefore 4x - 1 = 0$$

$$x = \frac{1}{4}$$

$$y = 2x^2 - x$$

$$\therefore y\left(\frac{1}{4}\right) = \frac{1}{8} - \frac{1}{4} = -\frac{1}{8}$$

Coordinates are $\left(\frac{1}{4}, -\frac{1}{8}\right)$

9 a $\int \frac{1}{2} dx = \frac{x}{2} + c$

b $\int \frac{x^2}{2} dx = \frac{x^3}{6} + c$

c $\int x^2 + 3x dx = \frac{x^3}{3} + \frac{3x^2}{2} + c$

d $\int (2x+3)^2 dx = \int 4x^2 + 12x + 9 dx$
 $= \frac{4x^3}{3} + 6x^2 + 9x + c$

e $\int at dt = \frac{1}{2} at^2 + c$

f $\int \frac{1}{3} t^3 dt = \frac{1}{12} t^4 + c$

g $\int (t+1)(t-2) dt = \int t^2 - t - 2 dt$
 $= \frac{1}{3} t^3 - \frac{1}{2} t^2 - 2t + c$

h $\int (2-t)(t+1) dt = \int -t^2 - t + 2 dt$
 $= -\frac{1}{3} t^3 - \frac{1}{2} t^2 + 2t + c$

10 $f'(x) = 2x + 5$

$\therefore f(x) = x^2 + 5x + c$

$f(3) = 9 + 15 + c = -1$

$\therefore c = -25$

$f(x) = x^2 + 5x - 25$

11 $f'(x) = 3x^2 - 8x + 3$

$\therefore f(x) = x^3 - 4x^2 + 3x + c$

a $f(0) = 0, \therefore c = 0$

$\therefore f(x) = x^3 - 4x^2 + 3x$

b

$f(x) = 0, \therefore x(x-1)(x-3) = x = 0$

$x = 0, 1, 3$

12

x	-2	-1	0	2	3
$f'(x)$	+	0	-	0	+

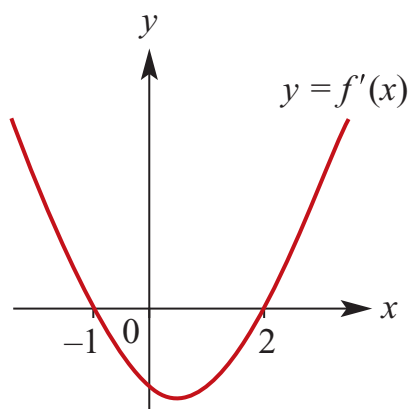

13 a $\{x: h'(x) > 0\} = \{x: -1 < x < 4\}$

b $\{x: h'(x) < 0\}$

$= \{x: x < -1\} \cup \{x: x > 4\}$

c $\{x: h'(x) = 0\} = \{-1, 4\}$

Solutions to multiple-choice questions

1 D $y = x^3 + 4x$, $\therefore \frac{dy}{dx} = 3x^2 + 4$
 $\therefore y'(2) = 12 + 4 = 16$

2 B $y = 2x^2$
 \therefore chord gradient $= \frac{2(1+h)^2 - 2(1)^2}{h}$
 $= \frac{4h + 2h^2}{h}$
 $= 4 + 2h$

3 E $y = 2x^4 - 5x^3 + 2$
 $\therefore \frac{dy}{dx} = 8x^3 - 15x^2$

4 B $f(x) = x^2(x+1) = x^3 + x^2$
 $\therefore f'(x) = 3x^2 + 2x$
 $\therefore f'(-1) = 3 - 2 = 1$

5 C $f(x) = (x-3)^2 = x^2 - 6x + 9$
 $\therefore f'(x) = 2x - 6$

6 C $y = \frac{2x^4 + 9x^2}{3x}$
 $= \frac{2}{3}x^3 + 3x; x \neq 0$
 $\therefore \frac{dy}{dx} = 2x^2 + 3; x \neq 0$

7 A $y = x^2 - 6x + 9$
 $\therefore \frac{dy}{dx} = 2x - 6 \geq 0$ if $x \geq 3$

8 E $y = 2x^4 - 36x^2$
 $\therefore \frac{dy}{dx} = 8x^3 - 72x = 8x(x^2 - 9)$
 Tangent to curve parallel to x -axis
 where
 $8x(x^2 - 9) = 0$
 $\therefore x = 0, \pm 3$

9 A $y = x^2 + 6x - 5$, $\therefore \frac{dy}{dx} = 2x + 6$
 Tangent to curve parallel to $y = 4x$
 where
 $\frac{dy}{dx} = 2x + 6 = 4$
 $\therefore 2x = -2 < \therefore x = -1$
 $y(-1) = (-1)^2 + 6(-1) - 5 = -10$
 Coordinates are $(-1, -10)$

10 D $y = -2x^3 + 3x^2 - x + 1$
 $\therefore \frac{dy}{dx} = -6x^2 + 6x - 1$

Solutions to extended-response questions

- 1 For $x < -1$, the gradient is negative, becoming less steep as x approaches -1 .
 For $x = -1$, the gradient is zero.
 For $-1 < x < 2$, the gradient is positive, getting steeper as x approaches 0.5 (approximately) then becoming less steep as x approaches 2.
 For $x = 2$, the gradient is zero.
 For $2 < x < 5$, the gradient is negative, getting steeper as x approaches 4 (approximately) then becoming less steep as x approaches 5.
 For $x = 5$, the gradient is zero.
 For $x > 5$, the gradient is positive and becoming steeper.

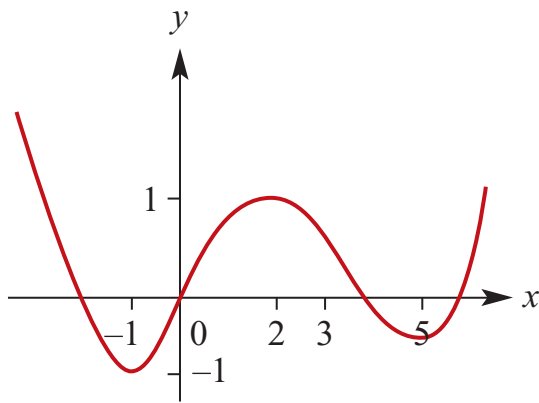

- 2 $P(x) = ax^3 + bx^2 + cx + d$
- At $(0, 0)$, $0 = 0 + 0 + 0 + d$
 $\therefore d = 0$
- At $(-2, 3)$, $3 = a(-2)^3 + b(-2)^2 + c(-2)$
 $\therefore 3 = -8a + 4b - 2c$ (1)
- At $(1, -2)$, $-2 = a(1)^3 + b(1)^2 + c(1)$
 $\therefore -2 = a + b + c$ (2)
- $P'(x) = 3ax^2 + 2bx + c$
- At $x = -2$, $P'(x) = 0$, $\therefore 0 = 3a(-2)^2 + 2b(-2) + c$
 $\therefore 0 = 12a - 4b + c$ (3)

$$(3) - (2) \quad \begin{array}{r} 12a - 4b + c = 0 \\ -a + b + c = -2 \\ \hline \end{array}$$

$$(1) + 2 \times (2) \quad \begin{array}{r} 11a - 5b = 2 \quad (4) \\ -8a + 4b - 2c = 3 \\ +2a + 2b + 2c = -4 \\ \hline \end{array}$$

$$6 \times (4) + 5 \times (5) \quad \begin{array}{r} -6a + 6b = -1 \quad (5) \\ 66a - 30b = 12 \\ + \quad -30a + 30b = -5 \\ \hline 36a = 7 \end{array}$$

$$\therefore a = \frac{7}{36} \quad (6)$$

$$\text{Substitute (6) into (5)} \quad -6\left(\frac{7}{36}\right) + 6b = -1$$

$$\therefore 6b = -1 + \frac{7}{6}$$

$$\therefore b = \frac{1}{36} \quad (7)$$

$$\text{Substitute (6) and (7) into (2)} \quad -2 = \frac{7}{36} + \frac{1}{36} + c$$

$$\begin{aligned} \therefore c &= \frac{-72 - 7 - 1}{36} \\ &= \frac{-80}{36} \\ &= \frac{-20}{9} \end{aligned}$$

$$\text{Hence} \quad a = \frac{7}{36}, b = \frac{1}{36}, c = \frac{-20}{9}, d = 0$$

$$\text{so} \quad P(x) = \frac{7}{36}x^3 + \frac{1}{36}x^2 - \frac{20}{9}x$$

$$3 \text{ a} \quad y = \frac{1}{5}x^5 + \frac{1}{2}x^4$$

$$\frac{dy}{dx} = x^4 + 2x^3$$

$$\begin{aligned} \text{i} \quad \text{When } x = 1, \quad \frac{dy}{dx} &= 1^4 + 2(1)^3 \\ &= 1 + 2 \\ &= 3 \end{aligned}$$

$\therefore \tan \theta = 3$ where θ is the angle required

$$\therefore \theta \approx 71^\circ 34'$$

$$\begin{aligned} \text{ii} \quad \text{When } x = 3, \quad \frac{dy}{dx} &= 3^4 + 2(3)^3 \\ &= 81 + 54 \\ &= 135 \end{aligned}$$

$\therefore \tan \theta = 135$

$$\therefore \theta \approx 89^\circ 35'$$

$$\text{b} \quad \text{Consider} \quad \frac{dy}{dx} = 32$$

$$\text{which implies} \quad x^4 + 2x^3 = 32$$

$$\text{i.e.} \quad x^4 + 2x^3 - 32 = 0$$

The factor theorem gives that $x - 2$ is a factor

$$\therefore (x - 2)(x^3 + 4x^2 + 8x + 16) = 0$$

$$\text{i.e.} \quad \frac{dy}{dx} = 32 \text{ when } x = 2.$$

So, gradient path is 32 when $x = 2$ km.

$$\text{4 a} \quad y = 2 + 0.12x - 0.01x^3$$

$$\frac{dy}{dx} = 0.12 - 0.03x^2$$

At the beginning of the trail, $x = 0$

$$\therefore \frac{dy}{dx} = 0.12 - 0.03(0)^2 = 0.12$$

Hence, the gradient at the beginning of the trail is 0.12.

At the end of the trail, $x = 3$

$$\begin{aligned} \therefore \frac{dy}{dx} &= 0.12 - 0.03(3)^2 \\ &= 0.12 - 0.27 \\ &= -0.15 \end{aligned}$$

Hence, the gradient at the end of the trail is -0.15 .

- b** The trail climbs at the beginning and goes downwards at the end, suggesting a peak in between (i.e. for $0 < x < 3$) where the gradient will be zero.

Gradient is zero where $\frac{dy}{dx} = 0$

$\therefore 0.03x^2 = 0.12$

$\therefore x^2 = 4$

$\therefore x = \pm 2$

$\therefore x = 2$ as $0 < x < 3$

At $x = 2$, $y = 2 + 0.12(2) - 0.01(2)^3$
 $= 2 + 0.24 - 0.08$
 $= 2.16$

From the above, $\frac{dy}{dx} > 0$ for $x < 2$

and $\frac{dy}{dx} < 0$ for $x > 2$

Hence the gradient is zero when $x = 2$, i.e. 2 km from the beginning of the trail, and the height of the pass is 2.16 km.

5 a Let $y = 25 - 0.1t^3$

At the surface of the pond $y = 0$

$\therefore 25 - 0.1t^3 = 0$

$\therefore 0.1t^3 = 25$

$\therefore t^3 = 250$

$\therefore t = \sqrt[3]{250} \approx 6.30$

Hence it takes the tadpole approximately 6.30 seconds to reach the surface.

$$\begin{aligned} \text{Speed} &= \frac{dy}{dt} \\ &= -0.3t^2 \end{aligned}$$

At $t = \sqrt[3]{250}$, $\frac{dy}{dt} = -0.3(\sqrt[3]{250})^2$
 ≈ -11.9

The tadpole's speed as it reaches the surface is approximately 11.9 cm/s.

b When $t_1 = 0$, $y_1 = 25 - 0.1(0)^3 = 25$

When $t_2 = \sqrt[3]{250}$, $y_2 = 0$

$$\begin{aligned} \text{Average speed} &= \frac{y_2 - y_1}{t_2 - t_1} \\ &= \frac{0 - 25}{\sqrt[3]{250} - 0} \approx -3.97 \end{aligned}$$

Hence the average speed over this time is 3.97 cm/s.

6 a $y = x(x - 2)$
 $= x^2 - 2x$

$$\frac{dy}{dx} = 2x - 2$$

At (0, 0) $\frac{dy}{dx} = 2(0) - 2$
 $= -2$

At (2, 0) $\frac{dy}{dx} = 2(2) - 2$
 $= 2$

Geometrically, the angles of inclination between the positive direction of the x -axis and the tangents to the curve at (0, 0) and (2, 0) are supplementary (i.e. add to 180°).

b $y = x(x - 2)(x - 5)$
 $= x(x^2 - 5x - 2x + 10)$
 $= x(x^2 - 7x + 10)$
 $= x^3 - 7x^2 + 10x$

$$\frac{dy}{dx} = 3x^2 - 14x + 10$$

At (0, 0) $\frac{dy}{dx} = l$

$\therefore l = 3(0)^2 - 14(0) + 10$
 $= 10$

At (2, 0) $\frac{dy}{dx} = m$

$\therefore m = 3(2)^2 - 14(2) + 10$
 $= 12 - 28 + 10$
 $= -6$

$$\text{At } (5, 0) \quad \frac{dy}{dx} = n$$

$$\begin{aligned} \therefore \quad n &= 3(5)^2 - 14(5) + 10 \\ &= 75 - 70 + 10 \\ &= 15 \end{aligned}$$

$$\begin{aligned} \frac{1}{l} + \frac{1}{m} + \frac{1}{n} &= \frac{1}{10} + \frac{1}{-6} + \frac{1}{15} \\ &= \frac{3 - 5 + 2}{30} \\ &= 0 \text{ as required.} \end{aligned}$$

Chapter 18 – Applications of differentiation of polynomials

Solutions to Exercise 18A

1 a $f(x) = x^2, \therefore f'(x) = 2x$

$$f'(2) = 4$$

Tangent at (2, 4) has equation:

$$y - 4 = 4(x - 2)$$

$$\therefore y = 4x - 4$$

Normal at (2, 4) has equation:

$$y - 4 = -\frac{1}{4}(x - 2)$$

$$y = -\frac{1}{4}x + \frac{9}{2}$$

$$\therefore 4x + y = 18$$

b $f(x) = (2x - 1)^2 = 4x^2 - 4x + 1$

$$\therefore f'(x) = 8x - 4$$

$$f'(2) = 12$$

Tangent at (2, 9) has equation:

$$y - 9 = 12(x - 2)$$

$$\therefore y = 12x - 15$$

Normal at (2, 9) has equation:

$$y - 9 = -\frac{1}{12}(x - 2)$$

$$y = -\frac{1}{12}x + \frac{55}{6}$$

$$\therefore 12y + x = 110$$

c $f(x) = 3x - x^2, \therefore f'(x) = 3 - 2x$

$$f'(2) = -1$$

Tangent at (2, 2) has equation:

$$y - 2 = -(x - 2)$$

$$\therefore y = -x + 4$$

Normal at (2, 2) has equation:

$$y - 2 = x - 2$$

$$\therefore y = x$$

d $f(x) = 9x - x^3, \therefore f'(x) = 9 - 3x^2$

$$f'(1) = 6$$

Tangent at (1, 8) has equation:

$$y - 8 = 6(x - 1)$$

$$\therefore y = 6x + 2$$

Normal at (1, 8) has equation:

$$y - 8 = -\frac{1}{6}(x - 1)$$

$$y = -\frac{1}{6}x + \frac{49}{6}$$

$$\therefore 6y + x = 49$$

2 $y = 3x^3 - 4x^2 + 2x - 10$

$$\therefore \frac{dy}{dx} = 9x^2 - 8x + 2$$

Intersection with the y-axis is at (0, -10)

$$\therefore \text{gradient} = 2$$

$$\text{Tangent equation: } y + 10 = 2(x - 0)$$

$$\therefore y = 2x - 10$$

3 $y = x^2, \therefore \frac{dy}{dx} = 2x$

Tangent at (1, 1) has grad = 2 and equation:

$$y - 1 = 2(x - 1)$$

$$\therefore y = 2x - 1$$

$$y = \frac{x^3}{6}, \therefore \frac{dy}{dx} = \frac{x^2}{2}$$

Tangent at $\left(2, \frac{4}{3}\right)$ has grad = 2 and equation:

$$y - \frac{4}{3} = 2(x - 2)$$

$$\therefore y = 2x - \frac{8}{3}$$

Tangents are parallel, since both have gradient = 2.

To find the perpendicular distance between them we need to measure the normal between, which has a gradient of $-\frac{1}{2}$.

From (1,1) the normal is:

$$y - 1 = -\frac{1}{2}(x - 1)$$

$$\therefore y = -\frac{x}{2} + \frac{3}{2}$$

This cuts the 2nd tangent where:

$$-\frac{x}{2} + \frac{3}{2} = 2x - \frac{8}{3}$$

$$\frac{5x}{2} = \frac{8}{3} + \frac{3}{2}$$

$$15x = 16 + 9, \therefore x = \frac{5}{3}$$

\therefore Normal cuts 2nd tangent at $(\frac{5}{3}, \frac{2}{3})$

Distance between (1,1) and $(\frac{5}{3}, \frac{2}{3})$ is

$$\sqrt{\left(\frac{5}{3} - 1\right)^2 + \left(\frac{2}{3} - 1\right)^2} = \frac{\sqrt{5}}{3}$$

4 $y = x^3 - 6x^2 + 12x + 2$

$$\therefore \frac{dy}{dx} = 3x^2 - 12x + 12$$

Tangents parallel to $y = 3x$ have gradient = 3

$$\therefore 3x^2 - 12x + 12 = 3$$

$$3x^2 - 12x + 9 = 0$$

$$3(x - 1)(x - 3) = 0, \therefore x = 1, 3$$

$$y(1) = 9; y(3) = 11$$

Tangents are:

$$y - 9 = 3(x - 1), \therefore y = 3x + 6$$

$$y - 11 = 3(x - 3), \therefore y = 3x + 2$$

5 a $y = (x - 2)(x - 3)(x - 4)$
 $= x^3 - 9x^2 + 26x + 24$

$$\therefore \frac{dy}{dx} = 3x^2 - 18x + 26$$

$$\frac{dy}{dx} = 2 \text{ at } P, 4 \text{ at } R \text{ and } -1 \text{ at } Q.$$

Gradients at P and R are equal, so tangents are parallel.

b Normal at $Q(3, 0)$ has gradient = ± 1 :

$$y = x - 3 \text{ which cuts the } y\text{-axis at } (0, -3).$$

6 $y = x^2 + 3, \therefore \frac{dy}{dx} = 2x$

Gradient at $x = a$ is $2a$; $y(a) = a^2 + 3$

Tangent has equation:

$$y - (a^2 + 3) = 2a(x - a)$$

$$\therefore y = 2ax - 2a^2 + a^2 + 3$$

$$= 2ax - a^2 + 3$$

Tangents pass through (2, 6)

$$\therefore 6 = 2a(2) - a^2 + 3$$

$$a^2 - 4a + 3 = 0$$

$$(a - 1)(a - 3) = 0, \therefore a = 1, 3$$

If $a = 1$, the point is (1, 4)

If $a = 3$, the point is (3, 12)

7 a $y = x^3 - 2x, \therefore \frac{dy}{dx} = 3x^2 - 2$

At (2, 4), gradient = 10

Equation of tangent:

$$y - 4 = 10(x - 2)$$

$$\therefore y = 10x - 16$$

b The tangent meets the curve again where

$$y = x^3 - 2x = 10x - 16$$

$$\therefore x^3 - 12x + 16 = 0$$

$$(x - 2)(x^2 + 2x - 8) = 0$$

$$(x - 2)^2(x + 4) = 0$$

$$\therefore x = 2, -4$$

Tangent cuts the curve again at

$$x = -4$$

$$y(-4) = (-4)^3 - 2(-4) = -56$$

Coordinates are $(-4, -56)$.

8 a $y = x^3 - 9x^2 + 20x - 8$

$$\therefore \frac{dy}{dx} = 3x^2 - 18x + 20$$

At $(1, 4)$, gradient = 5

Equation of tangent:

$$y - 4 = 5(x - 1)$$

$$\therefore y = 5x - 1$$

b $4x + y - 3 = 0$ has gradient = -4

$$\therefore \frac{dy}{dx} = 3x^2 - 18x + 20 = -4$$

$$3x^2 - 18x + 24 = 0$$

$$x^2 - 6x + 8 = 0$$

$$(x - 2)(x - 4) = 0$$

$$\therefore x = 2, 4$$

$$\text{If } x = 2, y = 2^3 - 9(2)^2 + 20(2) - 8$$

$$= 4$$

$$\text{If } x = 4, y = 4^3 - 9(4)^2 + 20(4) - 8$$

$$= -8$$

Coordinates are $(2, 4)$ and $(4, -8)$.

Solutions to Exercise 18B

1 a $y = 35 + 12x^2$

$\therefore y(2) = 83, y(1) = 47$

Av. rate of change

$$= \frac{y(2) - y(1)}{2 - 1} = \frac{83 - 47}{1} = 36$$

b $y(2 - h) = 35 + 12(2 - h)^2$

$$= 35 + 12(4 - 4h + h^2)$$

$$= 83 - 48h + 12h^2$$

Av. rate of change = $\frac{y(2) - y(2 - h)}{2 - (2 - h)}$

$$= \frac{83 - (83 - 48h + 12h^2)}{h} = 48 - 12h$$

c Rate of change at $x = 2$ is $y'(2)$:

$$y'(x) = 24x, \therefore y'(2) = 48$$

(Alternatively, let $h \rightarrow$

0 in **part b** answer)

2 a $M = 200\,000 + 600t^2 - \frac{200}{3}t^3$

$$\therefore \frac{dM}{dt} = 1200t - 200t^2 = 200t(6 - t)$$

b At $t = 3$, $\frac{dM}{dt} = \$1800/\text{month}$

c $\frac{dM}{dt} = 0$ at $t = 0$ and $t = 6$

3 a $R = 30P - 2P^2, \therefore \frac{dR}{dP} = 30 - 4P$

$\frac{dR}{dP}$ means the rate of change of profit per dollar increase in list price.

b $\frac{dR}{dP}$ is 10 at $P = 5$ and -10 at $P = 10$

c Revenue is rising for $0 < P < 7.5 \left(= \frac{30}{4} \right)$

4 $P = 100(5 + t - 0.25t^2)$

$$\therefore \frac{dP}{dt} = 100(1 - 0.5t)$$

i At 1 year $\frac{dP}{dt} = 100(1 - 0.5) = 50$ people/yr

ii At 2 years $\frac{dP}{dt} = 100(1 - 1) = 0$ people/yr

iii At 3 years $\frac{dP}{dt} = 100(1 - 1.5) = -50$ i.e. decreasing by 50 people/yr

5 a $V(t) = \frac{5}{8} \left(10t^2 - \frac{t^3}{3} \right), 0 \leq t \leq 20$

i $V(0) = 0$

ii $V(t) = \frac{5}{8} \left(10(20)^2 - \frac{20^3}{3} \right)$
 $= \frac{5}{8} \left(4000 - \frac{8000}{3} \right)$
 $= \frac{2500}{3} = 833\frac{1}{3}$ mL

b $V'(t) = \frac{5}{8}(20t - t^2)$

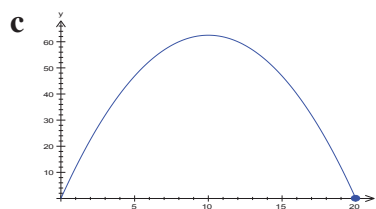

6 $A(t) = \frac{t}{2} + \frac{1}{10}t^2$ km²

$$\therefore A'(t) = \frac{1}{2} + \frac{t}{5}$$
 km²/h

a $A(1) = \frac{1}{2} + \frac{1}{10} = 0.6$ km²

b $A'(1) = \frac{1}{2} + \frac{1}{5} = 0.7\text{km}^2/\text{hr}$

Solutions to Exercise 18C

1 a $f(x) = x^2 - 6x + 3$

$$\therefore f'(x) = 2x - 6$$

$$2x - 6 = 0, \therefore x = 3$$

$$f(3) = -6$$

Coordinates of stationary pt are (3, -6).

b $y = x^3 - 4x^2 - 3x + 20, x > 0$

$$\therefore y'(x) = 3x^2 - 8x - 3$$

$$= (3x + 1)(x - 3)$$

$$y' = 0 \text{ for } x = 3 \text{ since } x = -\frac{1}{3} < 0$$

$$y(3) = 2$$

Coordinates of stationary pt are (3, 2).

c $z = x^4 - 32x + 50$

$$\therefore z' = 4x^3 - 32$$

$$4x^3 - 32 = 0, \therefore x = 2$$

$$z(2) = 2$$

Coordinates of stationary pt are (2, 2).

d $q = 8t + 5t^2 - t^3, t > 0$

$$\therefore q' = 8 + 10t - 3t^2$$

$$= (4 - t)(3t + 2)$$

$$q' = 0 \text{ for } t = 4 \text{ since } x = -\frac{2}{3} < 0$$

$$q(4) = 48$$

Coordinates of stationary pt are (4, 48).

e $y = 2x^2(x - 3)$

$$= 2x^3 - 6x^2$$

$$\therefore y' = 6x^2 - 12x$$

$$= 6x(x - 2)$$

$$y' = 0 \text{ for } x = 0, 2$$

$$y(0) = 0; y(2) = -8$$

Stationary pts at (0, 0) and (2, -8).

f $y = 3x^4 - 16x^3 + 24x^2 - 10$

$$\therefore y = 12x^3 - 48x^2 + 48x$$

$$= 12x(x - 2)^2$$

$$y' = 0 \text{ for } x = 0, 2$$

$$y(0) = -10; y(2) = 6$$

Stationary pts at (0, -10) and (2, 6).

2 $y = ax^2 + bx + c, \therefore y' = 2ax + b$

$$\text{Using } (0, -1): c = -1$$

$$\text{Using } (2, -9): 4a + 2b = -8$$

$$y'(2) = 0, \therefore 4a + b = 0$$

$$\therefore a = 2, b = -8, c = -1$$

3 $y = ax^2 + bx + c, \therefore y' = 2ax + b$

When $x = 0$, the slope of the curve is 45° .

$$y'(0) = 1, \quad \therefore b = 1$$

$$y'(1) = 0, \quad \therefore 2a + b = 0$$

$$a = -\frac{1}{2}$$

$$y(1) = 2, \quad \therefore -\frac{1}{2} + 1 + c = 2$$

$$c = \frac{3}{2}$$

$$\therefore a = -\frac{1}{2}, \quad b = 1, \quad c = \frac{3}{2}$$

4 a $y = ax^2 + bx, \therefore y' = 2ax + b$

$$y'(2) = 3, \therefore 4a + b = 3$$

$$y(2) = -2, \therefore 4a + 2b = -2$$

$$\therefore a = 2, b = -5$$

b $y'(x) = 4x - 5 = 0, \therefore x = \frac{5}{4}$
 $y\left(\frac{5}{4}\right) = 2\left(\frac{5}{4}\right)^2 - 5\left(\frac{5}{4}\right) = -\frac{25}{8}$
 Coordinates of stationary pt are $\left(\frac{5}{4}, -\frac{25}{8}\right)$.

5 $y = x^2 + ax + 3, \therefore y' = 2x + a$
 $y' = 0$ when $x = 4$
 $\therefore a = -8$

6 $y = x^2 - ax + 4, \therefore y' = 2x - a$
 $y' = 0$ when $x = 3$
 $\therefore a = 6$

7 a $y = x^2 - 5x - 6, \therefore y' = 2x - 5$
 $y' = 0$ when $x = 2.5: y\left(\frac{5}{2}\right) = -12.25$
 Stationary pt at $(2.5, -12.25)$.

b $y = (3x - 2)(8x + 3)$
 $= 24x^2 - 7x - 6$
 $y' = 48x - 7 = 0, \therefore x = \frac{7}{48}$
 $y\left(\frac{7}{48}\right) = \left(\frac{7}{16} - 2\right)\left(\frac{7}{6} + 3\right)$
 $= -\frac{625}{96}$
 Stationary pt at $\left(\frac{7}{48}, -\frac{625}{96}\right)$.

c $y = 2x^3 - 9x^2 + 27$
 $\therefore y' = 6x^2 - 18x$
 $= 6x(x - 3)$
 $y' = 0$ at $x = 0, 3: y(0) = 27, y(3) = 0$
 Stationary pts at $(0, 27)$ and $(3, 0)$.

d $y = x^3 - 3x^2 - 24x + 20$
 $\therefore y' = 3x^2 - 6x - 24$
 $= 3(x + 2)(x - 4)$
 $y' = 0$ when $x = -2, 4:$
 $y(-2) = -48, y(4) = -60$
 Stationary pts at $(-2, 48)$ and $(4, -60)$.

e $y = (x + 1)^2(x + 4)$
 $= x^3 + 6x^2 + 9x + 4$
 $\therefore y' = 3x^2 + 12x + 9$
 $= 3(x + 1)(x + 3)$
 $y' = 0$ when $x = -3, -1:$
 $y(-3) = 4, y(-1) = 0$
 Stationary pts at $(-3, 4)$ and $(-1, 0)$.

f $y = (x + 1)^2 + (x + 2)^2$
 $= 2x^2 + 6x + 5$
 $\therefore y' = 4x + 6 = 0, x = -1.5$
 $y(-1.5) = 0.5$
 Stationary pt at $(-1.5, 0.5)$.

8 $y = ax^2 + bx + 12, \therefore y' = 2ax + b$
 $y' = 0$ at $x = 1: 2a + b = 0$
 Using $(1, 13): a + b = 1$
 $\therefore a = -1, b = 2$

9 $y = ax^3 + bx^2 + cx + d$
 $\therefore y'(x) = 3ax^2 + 2bx + c$
 $y' = -3$ at $x = 0: c = -3$
 $y' = 0$ at $x = 3: 27a + 6b - 3 = 0$
 $9a + 2b = 1 \dots (1)$

$$y(0) = \frac{15}{2} : d = \frac{15}{2}$$

$$y(3) = 6, \quad \therefore 27a + 9b - 9 + \frac{15}{2} = 6$$

$$9a + 3b = \frac{5}{2} \dots (2)$$

$$\text{From (1) and (2): } b = \frac{3}{2}, \therefore a = -\frac{2}{9}$$

$$a = -\frac{2}{9}, b = \frac{3}{2}, c = -3, d = \frac{15}{2}$$

Solutions to Exercise 18D

1 a $y = 9x^2 - x^3$

$\therefore y' = 18x - 3x^2 = 3x(6 - x)$

$y' = 0$ at $x = 0, 6$:

$y(0) = 0; y(6) = 108$

x	-3	0	3	6	9
y'	-	0	+	0	-

$(0, 0)$ is a local minimum.

$(6, 108)$ is a local maximum.

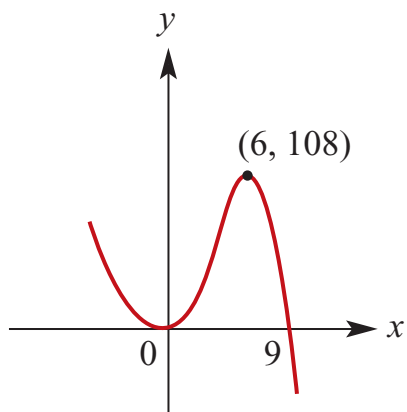

b $y = x^3 - 3x^2 - 9x$

$\therefore y' = 3x^2 - 6x - 9 = 3(x + 1)(x - 3)$

$y' = 0$ at $x = -1, 3$:

$y(-1) = 5; y(3) = -27$

x	-2	-1	0	3	4
y'	+	0	-	0	+

$(-1, 5)$ is a local maximum.

$(3, -27)$ is a local minimum.

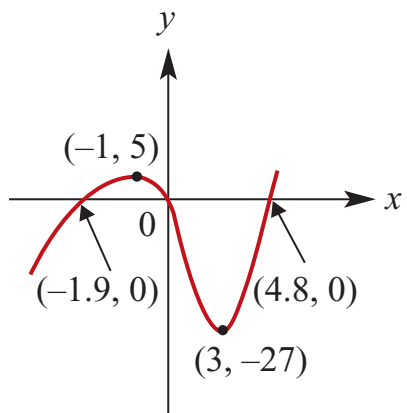

c $y = x^4 - 4x^3$

$\therefore y' = 4x^3 - 12x^2 = 4x^2(x - 3)$

$y' = 0$ at $x = 0, 3$:

$y(0) = 0; y(3) = -27$

x	-1	0	1	3	4
y'	-	0	-	0	+

$(0, 0)$ is a stationary pt of inflexion.

$(3, -27)$ is a local minimum.

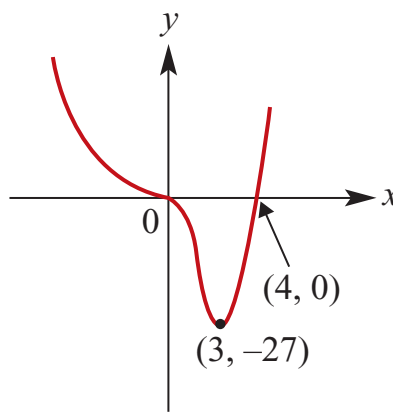

2 a $y = x^2(x - 4) = x^3 - 4x^2$

$\therefore y' = 3x^2 - 8x = x(3x - 8)$

$y' = 0$ at $x = 0, \frac{8}{3}$:

$y(0) = 0; y\left(\frac{8}{3}\right) = -\frac{256}{27}$

x	-1	0	1	$\frac{8}{3}$	3
y'	+	0	-	0	+

$(0, 0)$ is a local maximum.

$\left(\frac{8}{3}, -\frac{256}{27}\right)$ is a local minimum.

b $y = x^2(3 - x) = 3x^2 - x^3$

$\therefore y' = 6x - 3x^2 = 3x(2 - x)$

$y' = 0$ at $x = 0, 2$

$y(0) = 0; y(2) = 4$

x	-1	0	1	2	3
y'	-	0	+	0	-

$(0, 0)$ is a local minimum

(2, 4) is a local maximum

c $y = x^4$

$\therefore y' = 4x^3$

$y' = 0$ at $x = 0$; $y(0) = 0$

$y'(-1) = -4$; $y'(1) = 4$

(0, 0) is a local minimum.

d $y = x^5(x - 4) = x^6 - 4x^5$

$\therefore y' = 6x^5 - 20x^4 = 2x^4(3x - 10)$

$y' = 0$ at $x = 0, \frac{10}{3}$

$y(0) = 0$; $y\left(\frac{10}{3}\right) = \left(\frac{10}{3}\right)^5 \left(-\frac{2}{3}\right)$

$= -\frac{200\,000}{729}$

x	-1	0	1	$\frac{10}{3}$	4
y'	-	0	-	0	+

(0, 0) is a stationary pt of inflexion.

$\left(\frac{10}{3}, -\frac{200\,000}{729}\right)$ is a local minimum.

e $y = x^3 - 5x^2 + 3x + 2$

$\therefore y' = 3x^2 - 10x + 3$

$= (3x - 1)(x - 3) = 0$,

$\therefore x = \frac{1}{3}, 3$

$y\left(\frac{1}{3}\right) = \frac{67}{27}$; $y(3) = -7$

x	0	$\frac{1}{3}$	1	3	4
y'	+	0	-	0	+

$\left(\frac{1}{3}, \frac{67}{27}\right)$ is a local maximum.

(3, -7) is a local minimum.

f $y = x(x - 8)(x - 3)$

$= x^3 - 11x^2 + 24x$

$\therefore y' = 3x^2 - 22x + 24$

$= (3x - 4)(x - 6)$

$y' = 0$ at $x = \frac{4}{3}, 6$

$y\left(\frac{4}{3}\right) = \frac{4}{3} \left(-\frac{20}{3}\right) \left(-\frac{5}{3}\right) = \frac{400}{27}$

$y(6) = -36$

x	0	$\frac{4}{3}$	2	6	9
y'	+	0	-	0	+

$\left(\frac{4}{3}, \frac{400}{27}\right)$ is a local maximum.

(6, -36) is a local minimum.

3 a $y = 2 + 3x - x^3 = (x + 1)^2(2 - x)$

Axis intercepts at (0, 2), (-1, 0) and (2, 0)

$y' = 3 - 3x^2 = 0$, $\therefore x = \pm 1$

$y(-1) = 0$; $y(1) = 4$

x	-2	-1	0	1	2
y'	-	0	+	0	-

(-1, 0) is a local minimum.

(1, 4) is a local maximum.

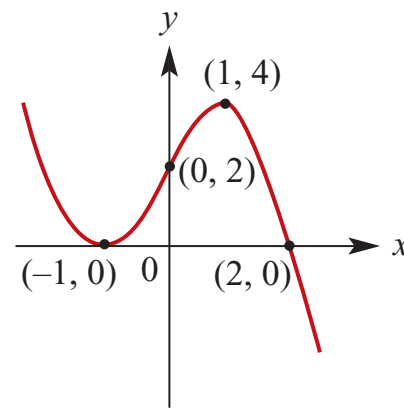

b $y = 2x^2(x - 3) = 2x^3 - 6x^2$

Axis intercepts at (0, 0) and (3, 0)

$y' = 6x^2 - 12x = 6x(x - 2)$

$y' = 0$ when $x = 0, 2$:

$y(0) = 0$; $y(2) = -8$

x	-1	0	1	2	3
y'	+	0	-	0	+

(0, 0) is a local maximum.

(2, -8) is a local minimum.

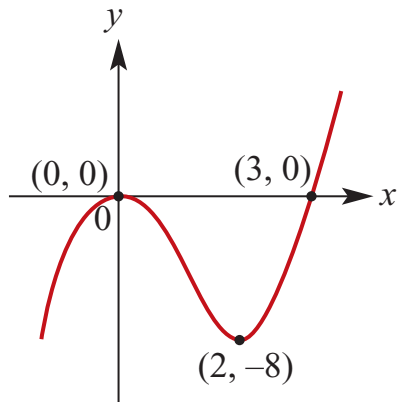

c

$$y = x^3 - 3x^2 - 9x + 11$$

$$= (x - 1)(x^2 - 2x - 11)$$

$$= (x - 1)(x - 1 - 2\sqrt{3})(x - 1 + 2\sqrt{3})$$

Axis intercepts at $(0, 11)$, $(1, 0)$,

$(1 - 2\sqrt{3}, 0)$ and $(1 + 2\sqrt{3}, 0)$.

$$y' = 3x^2 - 6x - 9$$

$$= 3(x + 1)(x - 3)$$

$y' = 0$ when $x = -1, 3$:

$$y(-1) = 16; y(3) = -16$$

x	-2	-1	0	3	4
y'	+	0	-	0	+

$(-1, 16)$ is a local maximum.

$(3, -16)$ is a local minimum.

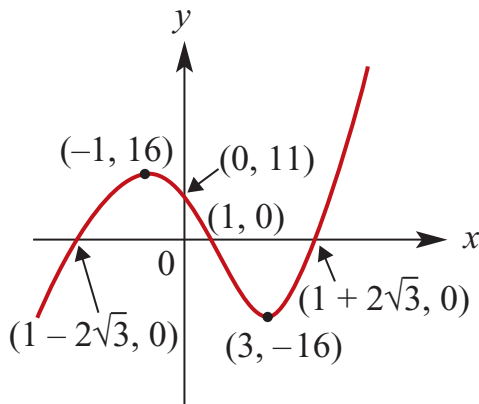

4 Graphs with a stationary point at $(-2, 10)$

a $y = 2x^3 + 3x^2 - 12x - 10$

$$\therefore y' = 6x^2 + 6x - 12$$

$$= 6(x + 2)(x - 1)$$

x	-3	-2	0	1	2
y'	+	0	-	0	+

$(-2, 10)$ is a local maximum.

b $y = 3x^4 + 16x^3 + 24x^2 - 6$

$$\therefore y' = 12x^3 + 48x^2 + 48$$

$$= 12(x + 2)^2$$

$$y' > 0; x \neq -2$$

$(-2, 10)$ is a stationary pt of inflexion.

5 $y = x^3 - 6x^2 + 9x + 10$

a $y' = 3x^2 - 12x + 9$

$$= 3(x - 1)(x - 3)$$

x	0	1	2	3	4
y'	+	0	-	0	+

$$\left\{x: \frac{dy}{dx} > 0\right\} = \{x: x < 1\} \cup \{x: x > 3\}$$

- b** $y(1) = 14, y(3) = 10$
 $(1, 14)$ is a local maximum.
 $(3, 10)$ is a local minimum.

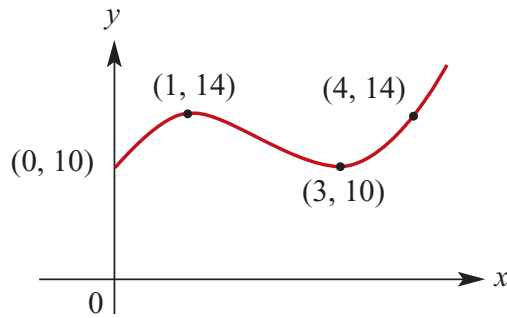

6 $f(x) = 1 + 12x - x^3$
 $f'(x) = 12 - 3x^2$

$$= 3(2 - x)(2 + x)$$

x	-3	-2	0	2	3
f'	-	0	+	0	-

$$\{x: f'(x) > 0\} = \{x: -2 < x < 2\}$$

7 $f(x) = 3 + 6x - 2x^3$

a $f'(x) = 6 - 6x^2$

$$= 6(1 - x)(1 + x)$$

x	-2	-1	0	1	2
f'	-	0	+	0	-

$$\{x: f'(x) > 0\} = \{x: -1 < x < 1\}$$

b $(-\infty, -1) \cup (1, \infty)$

8 a $f(x) = x(x + 3)(x - 5)$
 $= x^3 - 2x^2 - 15x$

$$\therefore f'(x) = 3x^2 - 4x - 15$$

$$= (3x + 5)(x - 3)$$

$$f'(x) = 0 \text{ for } x = -\frac{5}{3}, 3$$

- b** Axis intercepts at $(0, -15)$, $(-3, 0)$ and $(5, 0)$

$$f'(-\frac{5}{3}) = (-\frac{5}{3})(\frac{4}{3})(-\frac{20}{3})$$

$$= \frac{400}{27}$$

$$f(3) = -36$$

x	-2	$-\frac{5}{3}$	0	3	4
f'	+	0	-	0	+

$$(-\frac{5}{3}, \frac{400}{27}) \text{ is a local maximum.}$$

$$(3, -36) \text{ is a local minimum.}$$

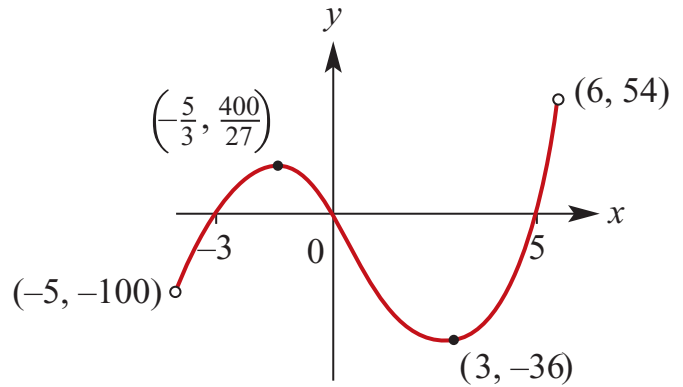

9

$$y = x^3 - 6x^2 + 9x - 4$$

$$= (x - 1)^2(x - 4)$$

- Axis intercepts at $(0, -4)$, $(1, 0)$ and $(4, 0)$

$$y' = 3x^2 - 12x + 9$$

$$= 3(x - 1)(x - 3)$$

$$y(1) = 0; y(3) = -4$$

x	0	1	2	3	4
y'	+	0	-	0	+

(1, 0) is a local maximum.
 (3, -4) is a local minimum.

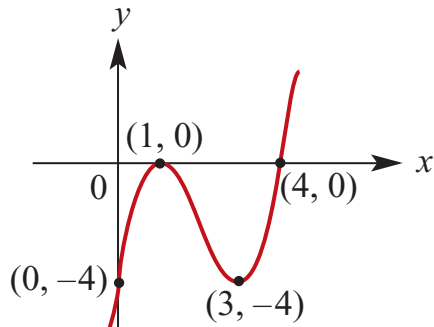

Coordinates are: (-3, 83) and (5, -173).

10 $y = x^3 - 3x^2 - 45x + 2$
 $\therefore y' = 3x^2 - 6x - 45$
 $= 3(x + 3)(x - 5)$

If tangent is parallel to the x -axis then $y' = 0$
 $\therefore x = -3, 5$

$y(-3) = 83; y(5) = -173$

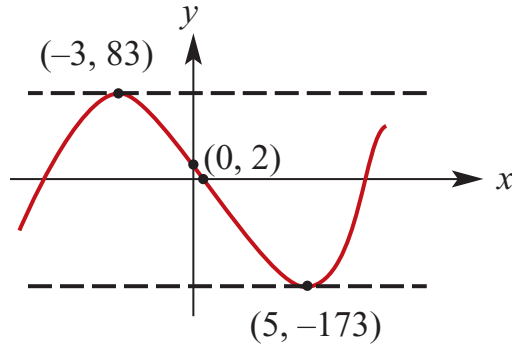

11 $f(x) = x^3 - 3x^2$
 $\therefore f'(x) = 3x^2 - 6x = 3x(x - 2)$
 $f'(x) = 0$ for $x = 0, 2$
 $f(0) = 0; f(2) = -4$

x	-1	0	1	2	3
f'	+	0	-	0	+

(0, 0) is a local maximum.
 (2, -4) is a local minimum.

a i $\{x: f'(x) < 0\} = \{x: 0 < x < 2\}$

ii $\{x: f'(x) > 0\} = \{x: x < 0\} \cup \{x: x > 2\}$

iii $\{x: f'(x) = 0\} = \{0, 2\}$

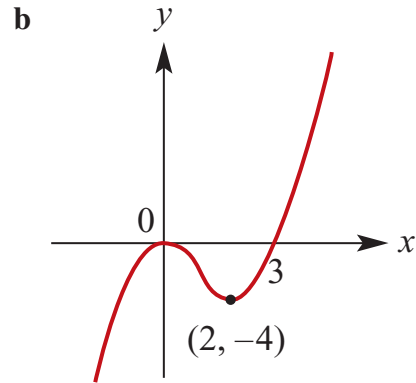

12 $y = x^3 - 9x^2 + 27x - 19$
 $= (x - 1)(x^2 - 8x + 19)$
 Axis intercepts: (0, -19) and (1, 0)
 $y' = 3x^2 - 18x + 27$
 $= 3(x - 3)^2$
 $y' = 0$ when $x = 3; y(3) = 8$
 $y' > 0$ for all $x \neq 0$
 Stationary pt of inflexion at (3, 8)

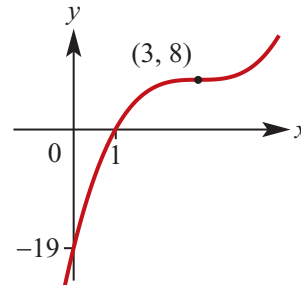

13 $y = x^4 - 8x^2 + 7$
 $= (x^2 - 1)(x^2 - 7)$
 $= (x - 1)(x + 1)(x - \sqrt{7})(x + \sqrt{7})$
 Axis intercepts: (0, 7), $(-\sqrt{7}, 0)$, $(-1, 0)$, (1, 0) and $(\sqrt{7}, 0)$

$$y' = 4x^3 - 16x$$

$$= 4x(x - 2)(x + 2)$$

$$y' = 0 \text{ when } x = -2, 0, 2$$

$$y(-2) = -9, y(0) = 7, y(2) = -9$$

x	-3	-2	-1	0	1	2	3
y'	-	0	+	0	-	0	+

$(-2, -9)$ is a local minimum.

$(0, 7)$ is a local maximum.

$(2, -9)$ is a local minimum.

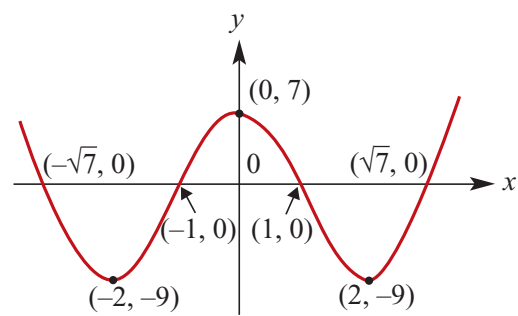

Solutions to Exercise 18E

1 Let x cm be the width and y cm be the length.

Then $2x + 2y = 200$ which implies that $y = 100 - x$

We note that $0 \leq x \leq 100$

$$\begin{aligned} \text{Area} &= xy \\ &= x(100 - x) \\ &= 100x - x^2 \end{aligned}$$

Turning point of parabola with negative coefficient of x^2 . Therefore a maximum.

$$\frac{dA}{dx} = 100 - 2x$$

$$\frac{dA}{dx} = 0 \text{ implies that}$$

$$100 - 2x = 0$$

$$\therefore x = 50$$

Maximum area of $50 \times 50 = 2500 \text{ cm}^2$ when $x = 50$

2 Let $P = x(10 - x) = 10x - x^2$

$$\text{Then } \frac{dP}{dx} = 10 - 2x$$

$$\frac{dP}{dx} = 0 \text{ implies that}$$

$$10 - 2x = 0$$

$$\therefore x = 5$$

Turning point of parabola with negative coefficient of x^2 . Therefore a maximum.

Maximum value of $P = 25$

3 Let $M = x^2 + y^2$ and it is given that

$$x + y = 2$$

$$\therefore y = 2 - x \text{ and } M = x^2 + (2 - x)^2 = 2x^2 - 4x + 4$$

$$\text{Then } \frac{dM}{dx} = 4x - 4 \quad \text{Turn-}$$

$$\frac{dM}{dx} = 0 \text{ implies that}$$

$$4 - 4x = 0$$

$$\therefore x = 1$$

ing point of parabola with positive coefficient of x^2 . Therefore a minimum.

Therefore minimum value of

$$M = 1 + 1 = 2$$

4 a Let x cm be the length of the sides of the squares which are being removed. The base of the box is a square with side lengths $6 - 2x$ cm and the height of the box is x cm.

Therefore the volume $V \text{ cm}^3$ is given by

$$\begin{aligned} V &= (6 - 2x)^2 x \\ &= (36 - 24x + 4x^2)x \end{aligned}$$

$$= 36x - 24x^2 + 4x^3$$

Note that $0 \leq x \leq 3$

$$\text{b } \frac{dV}{dx} = 12x^2 - 48x + 36$$

$$\frac{dV}{dx} = 0 \text{ implies that}$$

$$12x^2 - 48x + 36 = 0$$

$$\therefore x^2 - 4x + 3 = 0$$

$$\therefore (x - 1)(x - 3) = 0$$

$$\therefore x = 1 \text{ or } x = 3$$

The maximum value occurs when $x = 1$

We note that $V(3) = 0$

Maximum value = $V(1) = 16$.

The maximum value of the volume of the box is 16 cm^3

$$5 \quad y(x) = \frac{x^2}{400}(20 - x), \quad 0 \leq x \leq 20$$

$$\begin{aligned} \text{a i} \quad y(5) &= \frac{5^2}{400}(20 - 5) \\ &= \frac{15}{16} = 0.9375 \text{ m} \end{aligned}$$

$$\begin{aligned} \text{ii} \quad y(10) &= \frac{10^2}{400}(20 - 10) \\ &= \frac{5}{2} = 2.5 \text{ m} \end{aligned}$$

$$\begin{aligned} \text{iii} \quad y(15) &= \frac{15^2}{400}(20 - 15) \\ &= 2.8125 \text{ m} \end{aligned}$$

b Use a CAS calculator to find the gradient function:

$$\begin{aligned} y'(x) &= \frac{x(20 - x)}{200} - \frac{x^2}{400} \\ &= \frac{x(40 - 3x)}{400} \end{aligned}$$

$y' = 0$ when $x = 0, \frac{40}{3}$.
(0, 0) is the local minimum.

$$\begin{aligned} y\left(\frac{40}{3}\right) &= \frac{40^2}{3600}\left(20 - \frac{40}{3}\right) \\ &= \left(\frac{4}{9}\right)\left(\frac{20}{3}\right) = \frac{80}{27} \end{aligned}$$

Local maximum at $\left(\frac{40}{3}, \frac{80}{27}\right)$.

$$\begin{aligned} \text{c i} \quad y' &= \frac{x(40 - 3x)}{400} = \frac{1}{8} \\ \therefore 40x - 3x^2 - 50 &= 0 \\ x &= 1.396, 11.397 \end{aligned}$$

$$\begin{aligned} \text{ii} \quad y' &= \frac{x(40 - 3x)}{400} = -\frac{1}{8} \\ \therefore 40x - 3x^2 + 50 &= 0 \\ x &= 14.484 \text{ (since } x > 0) \end{aligned}$$

$$6 \quad \text{TSA} = 150 \text{ cm}^2$$

a Area of top & base
 $= 2x^2$

Area of 4 sides
 $= 4xh$

$$\therefore 2x^2 + 4xh = 150 \text{ cm}^2$$

$$2xh = 150 - 4x^2$$

$$h = \frac{75 - x^2}{2x}$$

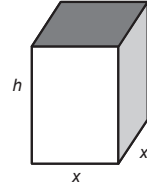

$$\begin{aligned} \text{b} \quad V(x) &= x^2h = x^2\left(\frac{75 - x^2}{2x}\right) \\ &= \frac{x}{2}(75 - x^2) \\ &= \frac{1}{2}(75x - x^3) \end{aligned}$$

$$\text{c} \quad V'(x) = \frac{1}{2}(75 - 3x^2)$$

$$v'(x) = 0, \therefore x^2 = 25$$

$$x = 5 \text{ cm}$$

$$\therefore V(5) = 125 \text{ cm}^3$$

$$V'(4) > 0; V'(6) < 0$$

\therefore stationary pt must be a maximum.

d Since $5 > 4$ and V is still increasing at $x = 4$,

$$\begin{aligned} V \text{ max. is } V(4) &= \frac{4}{2}(75 - 4^2) \\ &= 118 \text{ cm}^3 \end{aligned}$$

$$7 \quad V = \pi r^2h \text{ and } r + h = 12$$

$$h = 12 - r$$

$$\therefore V = \pi r^2(12 - r) = \pi(12r^2 - r^3)$$

Note $0 \leq r \leq 12$

$$\frac{dV}{dr} = \pi(24r - 3r^2)$$

$$\frac{dV}{dr} = 0 \text{ implies that}$$

$$24r - 3r^2 = 0$$

$$\therefore 3r(8 - r) = 0$$

$$\therefore r = 0 \text{ or } r = 8$$

Maximum occurs when $r = 8$
 Maximum volume = $8^2(12 - 8)\pi = 256\pi$

- 8** The lengths of the sides of the base of the tray are $50 - 2x$ cm and $40 - 2x$ cm. The height of the tray is x cm. Therefore the volume V cm³ of the tray is given by

$$V = (50 - 2x)(40 - 2x)x =$$

$$4(x^3 - 45x^2 + 500x)$$

We note: $20 \leq x \leq 25$

$$\frac{dV}{dx} = 4(3x^2 - 90x + 500)$$

$$\frac{dV}{dx} = 0 \text{ implies that}$$

$$3x^2 - 90x + 500 = 0$$

$$\therefore x = \frac{5(9 - \sqrt{21})}{3} \text{ or } x = \frac{5(9 + \sqrt{21})}{3}$$

Maximum occurs when $x = \frac{5(9 - \sqrt{21})}{3}$

- 9** $f(x) = 2 - 8x^2, -2 \leq x \leq 2$
 $\therefore f'(x) = -16x = 0, \therefore x = 0$
 For $x < 0, f'(x) > 0$; for $x > 0, f'(x) < 0$
 Local and absolute maximum for $f(0) = 2$ Absolute minimum at $f(\pm 2) = -30$.

- 10** $f(x) = x^3 + 2x + 3, -2 \leq x \leq 1$
 $\therefore f'(x) = 3x^2 + 2 > 0, x \in R$
 Function is constantly increasing, so absolute maximum is $f(1) = 6$.
 Absolute minimum $\neq f(-2) = -9$.

- 11** $f(x) = 2x^3 - 6x^2, 0 \leq x \leq 4$
 $\therefore f'(x) = 6x^2 - 12x = 6x(x - 2)$

x	0	1	2	3
f'	0	-	0	+

$x = 0$ is a local maximum $f(0) = 0$, but $f(4) = 32$, so the absolute maximum is 32. $x = 2$ is an absolute minimum of $f(2) = -8$.

- 12** $f(x) = 2x^4 - 8x^2, -2 \leq x \leq 5$

$$\therefore f'(x) = 8x^3 - 16x$$

$$= 8x(x - \sqrt{2})(x + \sqrt{2})$$

x	-2	$-\sqrt{2}$	-1	0	1	$\sqrt{2}$	2
f'	-	0	+	0	-	0	+

$x = 0$ is a local maximum $f(0) = 0$, but $f(5) = 1050$, so the absolute maximum is 1050.

At the other boundary condition,

$$f(-2) = 0 < 1050.$$

$$f(\pm \sqrt{2}) = -8 \text{ are local and absolute minima.}$$

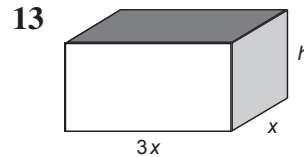

Total edges: $4h + 4x + 12x = 20$ cm.

$$\therefore h = \frac{20 - 16x}{4} = 5 - 4x$$

a $v = x(3x)h = 3x^2(5 - 4x)$
 $= 15x^2 - 12x^3$

b $\frac{dV}{dx} = 30x - 36x^2 = 6x(5 - 6x)$

c Sign diagram for $x \in [0, 1.25]$:

x	0	$\frac{1}{2}$	$\frac{5}{6}$	1
V'	0	+	0	-

$$\text{Local maximum} = V\left(\frac{5}{6}\right) = \frac{125}{36} \text{ cm}^3$$

d If $x \in [0, 0.8]$, then $0.8 < \frac{5}{6}$ and V is

still increasing

$$\therefore V \text{ max} = V(0.8) = \frac{432}{125} \text{ cm}^3$$

e If $x \in [0, 1]$, $V \text{ max} = V\left(\frac{5}{6}\right) = \frac{125}{36} \text{ cm}^3$

14 $x + y = 20$, $\therefore y = 20 - x$

a If $x \in [2, 5]$, $y \in [15, 18]$

b $z = xy = x(20 - x) = 20x - x^2$

$$\frac{dz}{dx} = 20 - 2x = 0$$

$\therefore x = 10$ for a stationary point.

However, with x restricted to $[2, 5]$,

$\frac{dz}{dx} > 0$ So the minimum value of z is $z(2) = 36$ and maximum value is $z(5) = 75$.

15 $2x + y = 50$, $\therefore y = 50 - 2x$

$$\therefore z = x^2y = x^2(50 - 2x) = 50x^2 - 2x^3$$

$$\frac{dz}{dx} = 100x - 6x^2 = 2x(50 - 3x)$$

Inverted cubic, so z has a local minimum

at $(0, 0)$ and a local maximum at

$$\left(\frac{50}{3}, \frac{125\,000}{27}\right)$$

a $x \in [0, 25]$, So max. $z = \frac{125\,000}{27}$

b $x \in [0, 10]$, so max. $z = z(10) = 3000$

c $x \in [5, 20]$, so max. $z = \frac{125\,000}{27}$

16 a 1st piece has length x metres, so 2nd piece has length $(10 - x)$ metres, each folded into 4 to make a square:

$$\begin{aligned} \text{Total area } A &= \left(\frac{x}{4}\right)^2 + \left(\frac{10-x}{4}\right)^2 \\ &= \frac{x^2}{16} + \frac{100 - 20x + x^2}{16} \\ &= \frac{1}{8}(x^2 - 10x + 50) \text{ m}^2 \end{aligned}$$

b $\frac{dA}{dx} = \frac{1}{8}(2x - 10)$
 $= \frac{x - 5}{4}$

c Upright parabola, so turning point is a minimum.

$$\frac{dA}{dx} = \frac{x - 5}{4} = 0$$

$$\therefore x = 5$$

d For $x \in [4, 7]$, check end points:

$$\begin{aligned} A(4) &= \frac{26}{8}, A(7) = \frac{29}{8} \text{ so } A_{\text{max}} = \frac{29}{8} \\ &= 3.625 \text{ m}^2. \end{aligned}$$

Solutions to Exercise 18F

1 a When $t = 0$, $x = t^2 - 12t + 11 = 11$.
The initial position is 11 cm to the right of O

b When $t = 3$, $x = t^2 - 12t + 11 = 3^2 - 12 \times 3 + 11 = -16$. The position when $t = 3$ is 16 cm to the left of O

2 $x = t^2 - 12t + 11, t \geq 0$

a Velocity $= v = \frac{dx}{dt} = 2t - 12$
When $t = 0$, $v = -12$
The particle is moving to the left at 12 cm/s

b $v = 0$ implies $2t - 12 = 0$. That is $t = 6$
When $t = 6$, $x = 36 - 72 + 11 = -25$.
The particle is 25 cm to the left of O .

c Average velocity for the first three seconds =

$$\frac{x(3) - x(0)}{3 - 0} = \frac{-9 - 11}{3} = -9 \text{ cm/s.}$$

d The particle moves to the left for the first three seconds and doesn't change direction. The speed is 9 cm/s

3 $x = \frac{1}{3}t^3 - 12t + 6, t \geq 0$

a Therefore $\frac{dx}{dt} = t^2 - 12$ When $t = 3$, $v = \frac{dx}{dt} = -3$

b $\frac{dx}{dt} = 0$
 $\Rightarrow t^2 = 12$

$$\Rightarrow t = \pm 2\sqrt{3}$$

But $t \geq 0$. Therefore $t = 2\sqrt{3}$

The velocity is zero at time $t = 2\sqrt{3}$ seconds

4 $x = 4t^3 - 6t^2 + 5$
Velocity $: v = \frac{dx}{dt} = 12t^2 - 12t$

Acceleration $: a = \frac{dv}{dt} = 24t - 12$

a When $t = 0$, $x = 5$, $v = 0$, $a = -12$
The particle is initially at rest at $x = 5$ and starts moving to the left.

It is instantaneously at rest when $12t(t - 1) = 0$. That is, when $t = 0$ and $t = 1$

When $t > 1$ it is moving to the right.

5 $s = t^4 + t^2$
 $v = \frac{ds}{dt} = 4t^3 + 2t$
 $a = \frac{dv}{dt} = 12t^2 + 2$

a When $t = 0$, acceleration is 2 m/s^2

b When $t = 2$, acceleration is 50 m/s^2

6 a $s = 10 + 15t - 4.9t^2$

$$\therefore v = \frac{ds}{dt} = 15 - 9.8t \text{ m/s}$$

b $a = \frac{dv}{dt} = -9.8 \text{ m/s}^2$

7 $x(t) = t^2 - 7t + 10, t \geq 0$

a $v(t) = 2t - 7 = 0$

$\therefore t = 3.5 \text{ s}$

b $a(t) = 2 \text{ m/s}^2$ at all times

c 14.5 m

d $v(t) = 2t - 7 = -2$

$\therefore t = 2.5 \text{ s}$

$x(2.5) = 2.5^2 - 7(2.5) + 10 \text{ cm}$
 $= 1.25 \text{ m to the left of } O.$

8 a $s = t^3 - 3t^2 + 2t$

$= t(t - 1)(t - 2)$

$\therefore s = 0$ at $t = 0, 1$ and 2

b $v(t) = 3t^2 - 6t + 2; a(t) = 6t - 6$
 $t = 0: v = 2 \text{ m/s and } a = -6 \text{ m/s}^2$
 $t = 1: v = -1 \text{ m/s and } a = 0 \text{ m/s}^2$
 $t = 2: v = 2 \text{ m/s and } a = 6 \text{ m/s}^2$

c Av. v in 1st second
 $= s(1) - s(0) = 0 \text{ m/s}$

9 a $x = t^2 - 7t + 12$
 $\therefore x(0) = 12 \text{ cm to the right of } O.$

b $x(5) = 5^2 - 7(5) + 12$
 $= 2 \text{ cm to the right of } O.$

c $v(t) = 2t - 7$

$\therefore v(0) = -7$

$= 7 \text{ cm/s moving to the left of } O.$

d $v = 0$ when $t = 3.5 \text{ s}$

$x(3.5) = 3.5^2 - 7(3.5) + 12$
 $= -0.25$
 $= 0.25 \text{ cm to the left.}$

e $\text{Av. } v = \frac{x(5) - x(0)}{5}$
 $= \frac{2 - 12}{5}$
 $= -2 \text{ cm/s}$

f Total distance traveled

$= x(0) - x(3.5) + x(5) - x(3.5)$
 $= 12.25 + 2.25 = 14.5 \text{ cm.}$

Total time = 5 seconds
 $\therefore \text{av. speed} = \frac{14.5}{5} = 2.9 \text{ cm/s}$

10 $s = t^4 + 3t^2$
 $v = \frac{ds}{dt} = 4t^3 + 6t$
 $a = \frac{dv}{dt} = 12t^2 + 6$

a When $t = 1$, acceleration is 18 m/s^2
 When $t = 2$, acceleration is 54 m/s^2
 When $t = 3$, acceleration is 114 m/s^2

b Average acceleration
 $= \frac{v(3) - v(1)}{3 - 1} = \frac{116}{2} = 58 \text{ m/s}^2$

11 $x(t) = t^3 - 11t^2 + 24t - 3, t \geq 0$

a $v(t) = 3t^2 - 22t + 24, t \geq 0$
 $x(0) = -3 \text{ cm}; v(0) = 24 \text{ cm/s}$
 Particle is 3 cm to the left of O
 moving to the right at 24 cm/s.

b See a: $v(t) = 3t^2 - 22t + 24, t \geq 0$

$$\begin{aligned} \text{c } v(t) &= 3t^2 - 22t + 24 = 0 \\ &= (3t - 4)(t - 6) = 0, \end{aligned}$$

$$\therefore t = \frac{4}{3}, 6 \text{ s}$$

$$\begin{aligned} \text{d } x\left(\frac{4}{3}\right) &= \left(\frac{4}{3}\right)^3 - 11\left(\frac{4}{3}\right)^2 + 24\left(\frac{4}{3}\right) - 3 \\ &= \frac{64}{27} - \frac{176}{9} + 32 - 3 \\ &= \frac{319}{27} \text{ cm right of } O \end{aligned}$$

$$\begin{aligned} x(6) &= (6)^3 - 11(6)^2 + 24(6) - 3 \\ &= 216 - 396 + 144 - 3 \\ &= 39 \text{ cm left of } O \end{aligned}$$

e Velocity negative for $t \in \left(\frac{4}{3}, 6\right)$,

$$\text{i.e. for } \frac{14}{3} \text{ s} = 4\frac{2}{3} \text{ s.}$$

$$\text{f } a(t) = 6t - 22 \text{ cm/s}^2$$

$$\text{g } a(t) = 6t - 22 = 0, \therefore t = \frac{11}{3} \text{ s}$$

$$\begin{aligned} x\left(\frac{11}{3}\right) &= \left(\frac{11}{3}\right)^3 - 11\left(\frac{11}{3}\right)^2 + 24\left(\frac{11}{3}\right) - 3 \\ &= \frac{1331}{27} - \frac{1331}{9} + \frac{264}{3} - 3 \\ &= -\frac{313}{27} \\ &= \frac{313}{27} \text{ cm to the left of } O \end{aligned}$$

$$\begin{aligned} v\left(\frac{11}{3}\right) &= 3\left(\frac{11}{3}\right)^2 - 22\left(\frac{11}{3}\right) + 24 \\ &= \frac{121}{3} - \frac{242}{3} + 24 \\ &= -\frac{49}{3} \\ &= \frac{49}{3} \text{ cm/s moving to the left.} \end{aligned}$$

$$\begin{aligned} \text{12 } x(t) &= 2t^3 - 5t^2 + 4t - 5, t \geq 0 \\ \therefore v(t) &= 6t^2 - 10t + 4, t \geq 0 \end{aligned}$$

$$\therefore a(t) = 12t - 10, t \geq 0$$

$$\begin{aligned} \text{a } v(t) &= 6t^2 - 10t + 4 = 0 \\ 2(3t - 2)(t - 1) &= 0 \\ \therefore t &= \frac{2}{3}, 1 \end{aligned}$$

$$\begin{aligned} a\left(\frac{2}{3}\right) &= 12\left(\frac{2}{3}\right) - 10 \\ &= -2 \text{ cm/s}^2 \end{aligned}$$

$$a(1) = 12 - 10 = 2 \text{ cm/s}^2$$

$$\text{b } a(t) = 12t - 10 = 0, \therefore t = \frac{5}{6} \text{ s}$$

$$\begin{aligned} v\left(\frac{5}{6}\right) &= 6\left(\frac{5}{6}\right)^2 - 10\left(\frac{5}{6}\right) + 4 \\ &= \frac{25}{6} - \frac{50}{6} + 4 = -\frac{1}{6} \end{aligned}$$

Particle is moving to the left at $\frac{1}{6} \text{ cm/s}$

$$\begin{aligned} x(t) &= t^3 - 13t^2 + 46t - 48, t \geq 0 \\ \therefore v(t) &= 3t^2 - 26t + 46, t \geq 0 \end{aligned}$$

$$\therefore a(t) = 6t - 26, t \geq 0$$

The particle passes through O where $x = 0$:

$$x(t) = (t - 2)(t - 3)(t - 8) = 0$$

$$\therefore t = 2, 3, 8 \text{ s}$$

$$\text{At } t = 2: v = 6 \text{ cm/s}, a = -14 \text{ cm/s}^2$$

$$\text{At } t = 3: v = -5 \text{ cm/s}, a = -8 \text{ cm/s}^2$$

$$\text{At } t = 8: v = 30 \text{ cm/s}, a = 22 \text{ cm/s}^2$$

$$\text{14 P1: } x(t) = t + 2, \therefore v(t) = 1$$

$$\text{P2: } x(t) = t^2 - 2t - 2, \therefore v(t) = 2t - 2$$

a Particles at same position when

$$t + 2 = t^2 - 2t - 2$$

$$t^2 - 3t - 4 = 0$$

$$(t - 4)(t + 1) = 0$$

$$\therefore t = -1, 4$$

(No restricted domain: both correct)

b Velocities equal when $2t - 2 = 1$ so

$$t = 1.5 \text{ s}$$

Solutions to Exercise 18G

1 $v = 4t - 6; t \geq 0$

a $x = \int 4t - 6 dt = 2t^2 - 6t; v(0) = 0$

b $x(3) = 18 - 18 = 0$ cm
Body is at O .

c $v = 0, \therefore t = 1.5$ s
 $x(1.5) = \frac{9}{2} - 9 = -4.5$ cm
 $x(3) = 0$
Body goes 4.5 cm in each direction = 9 cm total.

d Av. v over $[0, 3] = 0$ since $x(3) = x(0)$

e Av. speed over $[0, 3] = \frac{9}{3} = 3$ cm/s

2 $v = 3t^2 - 8t + 5; t \geq 0$

$x(0) = 4$ m + direction to the right of O .

a $x = t^3 - 4t^2 + 5t + 4$
 $a = 6t - 8$

b $v(t) = (3t - 5)(t - 1) = 0, \therefore t = 1, \frac{5}{3}$
 $x(1) = 1 - 4 + 5 + 4 = 6$ m
 $x\left(\frac{5}{3}\right) = \frac{125}{27} - \frac{100}{9} + \frac{25}{3} + 4$
 $= \frac{158}{27}$ m

c $a(1) = -2$ m/s²; $a\left(\frac{5}{3}\right) = 2$ m/s²

3 $a = 2t - 3; t \geq 0$

$\therefore v = t^2 - 3t + 3; v(0) = 3$

$\therefore x = \frac{1}{3}t^3 - \frac{3}{2}t^2 + 3t + 2; x(0) = 2$

$$x(10) = \frac{1000}{3} - 150 + 30 + 2$$

$$= \frac{646}{3} \text{ m}$$

4 $a = -10$ m/s²

a $v(0) = 25, \therefore v(t) = 25 - 10t$ m/s

b $h(0) = 0, \therefore h(t) = 25t - 5t^2$ m

c h is max. when $v = 0$ at $t = 2.5$ s

d $h\left(\frac{5}{2}\right) = \frac{125}{4} = 31.25$ m

e $h = 0, \therefore 5t(5 - t) = 0$

$t = 0, 5$

Body returns to its start after 5 seconds.

5 $a = \frac{t-5}{9}, \therefore v = \frac{t^2}{18} - \frac{5t}{9} + c$ m/s

$v(0) = -8, \therefore c = -8$

$\therefore v(t) = \frac{t^2}{18} - \frac{5t}{9} - 8$ m/s

$\therefore x(t) = \frac{t^3}{54} - \frac{5t^2}{18} - 8t + 300$ m

since $x(0) = 300$ m

$v = 0$ when $\frac{t^2}{18} - \frac{5t}{9} = 8$

$\therefore t^2 - 10t - 144 = 0$

$(t - 18)(t + 10) = 0$

$t = 18; t > 0$

$x(18) = 108 - 90 - 144 + 300$

$= 174$ m

$\frac{174}{6} = 29, \therefore$ lift stops at the 29th floor.

Solutions to Exercise 18H

1 $f(x) = (x - 2)^2(x - b)$, $b > 2$

- a Use CAS calculator to find gradient function.

$$f'(x) = (x - 2)(3x - 2(b + 1))$$

- b For stationary points $f'(x) = 0$
 $\therefore x = 2, c$ where $c = \frac{2}{3}(b + 1)$

$$\begin{aligned} f(2) &= 0; f(c) = (c - 2)^2(c - b) \\ &= -\frac{4}{27}(b - 2)^3 \end{aligned}$$

$$(2, 0) \text{ and } \left(\frac{2}{3}(b + 1), -\frac{4}{27}(b - 2)^3\right)$$

- c $f(x)$ is an upright cubic and the 1st stationary pt is always a maximum. Since $\frac{2}{3}(b + 1) > 0$ by definition, this is the 2nd stationary pt and is thus a minimum.

A sign diagram confirms this:

x	0	2		c	
f'	+	0	-	0	+

$\therefore (2, 0)$ is always a local maximum.

d $\frac{2}{3}(b + 1) = 4$

$$\therefore b + 1 = 6$$

$$b = 5$$

2 a $y = x^4 - 12x^3$

$$\frac{dy}{dx} = 4x^3 - 36x^2 = 4x^2(x - 9)$$

$$\frac{dy}{dx} = 0$$

$$\Rightarrow 4x^2(x - 9) = 0$$

$$\Rightarrow x = 0 \text{ or } x = 9$$

$$\frac{dy}{dx} > 0 \text{ for } x > 9 \text{ and } \frac{dy}{dx} < 0 \text{ for}$$

$x < 9$. There is a stationary point of inflexion at $(0, 0)$ and a local minimum at $(9, -2187)$.

- b (a, b) and $(9 + a, -2187 + b)$.

3 $f(x) = x - ax^2, a > 0$

$$\therefore f'(x) = 1 - 2ax$$

- a i f is an increasing function if $1 - 2ax > 0$

$$\therefore 2ax < 1, \therefore x < \frac{1}{2a}$$

(since $a > 0$)

- ii f is a decreasing function if $1 - 2ax < 0$

$$\therefore 2ax > 1, \therefore x > \frac{1}{2a}$$

(since $a > 0$)

- b Tangent at $\left(\frac{1}{a}, 0\right)$ has gradient = -1

$$\therefore y - 0 = -1\left(x - \frac{1}{a}\right)$$

$$y = \frac{1}{a} - x$$

- c Normal at $\left(\frac{1}{a}, 0\right)$ has gradient = 1 :

$$\therefore y = x - \frac{1}{a}$$

- d Local maximum occurs at $x = \frac{1}{2a}$

$$f\left(\frac{1}{2a}\right) = \frac{1}{2a} - \frac{a}{4a^2} = \frac{1}{4a}$$

$$\therefore \text{Range of } f = \left(-\infty, \frac{1}{4a}\right]$$

- 4 a Using a CAS:

$$f'(x) = (x - a)(x - a + 2(x - 1))$$

$$= (x - a)(3x - a - 2)$$

$$f'(x) = 0, \therefore x = a, \frac{a+2}{3}$$

$$f(a) = 0;$$

$$f\left(\frac{a+2}{3}\right) = \left(\frac{2}{3}\right)^2 (a-1)^2 \left(\frac{a-1}{3}\right)$$

$$= \frac{4}{27}(a-1)^3$$

Turning pts at $(a, 0)$ and $\left(\frac{a+2}{3}, \frac{4}{27}(a-1)^3\right)$

- b** $(a, 0)$ is a local minimum.
 $\left(\frac{a+2}{3}, \frac{4}{27}(a-1)^3\right)$ is a local maximum.

- c i** Tangent at $x = 1$ has gradient $(a-1)^2$:
 $y(1) = 0, \therefore y = (a-1)^2(x-1)$

- ii** Tangent at $x = a$ has gradient 0:
 $y(0) = 0, \therefore y = 0$

- iii** Tangent at $x = \frac{a+1}{2}$ has gradient:
 $= \left(\frac{a+1}{2} - a\right) \left(\frac{3}{2}(a+1) - a - 2\right)$
 $= \frac{1-a}{2} \left(\frac{a-1}{2}\right)$
 $= -\frac{1}{4}(a-1)^2$
 $y\left(\frac{a+1}{2}\right) = \left(\frac{a+1}{2} - a\right)^2 \left(\frac{a+1}{2} - a\right)$
 $= \left(\frac{1-a}{2}\right)^2 \left(\frac{a-1}{2}\right)$
 $= \frac{1}{8}(a-1)^3$

Tangent equation:

$$y - \frac{1}{8}(a-1)^3$$

$$= -\frac{1}{4}(a-1)^2 \left(x - \frac{a+1}{2}\right)$$

$$\therefore y = -\frac{1}{4}(a-1)^2 \left(x - \frac{a+1}{2}\right)$$

$$+ \frac{1}{8}(a-1)^3$$

$$= -\frac{1}{4}(a-1)^2 \left(x - \frac{a+1}{2} - \frac{a-1}{2}\right)$$

$$= -\frac{1}{4}(a-1)^2(x-a)$$

- 5** $y = (x-2)^2$
 $y = mx + c$ is a tangent to the curve at point P .

- a i** $y'(x) = 2(x-2)$
 $\therefore y'(a) = 2(a-2)$
 where $0 \leq a < 2$

- ii** $m = 2(a-2)$

- b** $P = (a, (a-2)^2)$

- c** $y - (a-2)^2 = 2(a-2)(x-a)$

$$\therefore y = 2(a-2)x - 2a(a-2) + (a-2)^2$$

$$= 2(a-2)x + (a-2)(a-2-2a)$$

$$= 2(a-2)x + (a-2)(-a-2)$$

$$= 2(a-2)x + 4 - a^2$$

- d** x -axis intercept of the tangent is where $y = 0$
 $2(a-2)x + 4 - a^2 = 0$
 $\therefore x = \frac{a^2 - 4}{2(a-2)} = \frac{a+2}{2}$
 (since $a \neq 2$)

6 a $f(x) = x^3 \rightarrow y = f(x+h)$
 $f(1+h) = 27, \therefore (1+h)^3 = 27$
 $1+h = 3$
 $h = 2$

b $f(x) = x^3 \rightarrow y = f(ax)$
 $f(ax)$ passes through $(1, 27)$
 $\therefore ax = 3$
 $\therefore a = 3$ since $x = 1$

c $y = ax^3 - bx^2 = x^2(ax - b)$
 $\therefore y' = 3ax^2 - 2bx = x(3ax - 2b)$
Using $(1, 8)$: $a - b = 8 \dots (1)$
 $y'(1) = 0, \therefore 3a - 2b = 0 \dots (2)$
From (1) : $3a - 3b = 24$
 $\therefore a = -16, b = -24$

7 $y = x^4 + 4x^2$
Translation $+a$ in x direction, and $+b$ in y direction:
 $y = (x-a)^4 + 4(x-a)^2 + b$

a $y' = 4x^3 + 8x = 4x(x^2 + 2)$
Turning pt at $(0, 0)$ only, since
 $x^2 + 2 > 0; x \in R$

b Turning point of image = (a, b)

8 a
 $f(x) = (x-1)^2(x-b)^2, b > 1$
 $\therefore f'(x) = 2(x-1)(x-b)^2$
 $+ 2(x-b)^2(x-1)$
 $= 2(x-1)(x-b)(2x-b-1)$

Use a CAS calculator to determine the gradient function.

b $f'(x) = 0$ when $x = 1, b, \frac{b+1}{2}$
 $f(1) = f(b) = 0$
 $f'(\frac{b+1}{2}) = (\frac{b+1}{2} - 1)^2(\frac{b+1}{2} - b)^2$
 $= (\frac{b-1}{2})^2(\frac{1-b}{2})^2$
 $= \frac{1}{16}(b-1)^4$

Turning pts: $(1, 0), (b, 0)$ and
 $(\frac{b+1}{2}, \frac{1}{16}(b-1)^4)$

c Turning pt at $(2, 1)$ must mean
 $\frac{b+1}{2} = 2$
 $\therefore b+1 = 4, \therefore b = 3$

Solutions to Exercise 18I

1 a Let $f(x) = x^3 - x - 1$

$$f'(x) = 3x^2 - 1$$

$$\text{Using } x_{n+1} = x_n - \frac{f(x_n)}{f'(x_n)}$$

We start with $x_0 = 1.5, f(x_0) = 0.875$

Step 1

$$\begin{aligned} x_1 &= x_0 - \frac{f(x_0)}{f'(x_0)} \\ &= 1.5 - \frac{0.875}{5.75} \\ &= 1.347 \dots \end{aligned}$$

Step 2

$$\begin{aligned} x_2 &= x_1 - \frac{f(x_1)}{f'(x_1)} \\ &= 1.347 \dots - \frac{0.100 \dots}{4.449 \dots} \\ &= 1.325 \dots \end{aligned}$$

A section of spreadsheet is given here:

n	xn	f(xn)	f'(xn)
0	1.5	0.875	5.75
1	1.347826086957	0.100682173	4.449905482
2	1.32520039895091	0.002058362	4.268468292
3	1.32471817399905	9.24378E-07	4.264634722
4	1.32471795724479	1.86517E-13	4.264632999
5	1.32471795724475	0	4.264632999

In the remainder of Question 1 only the spreadsheet is presented

b $f(x) = x^4 + x - 3$ We start with $x_0 = 2, f(x_0) = 15$

n	xn	f(xn)	f'(xn)
0	2	15	33
1	1.545454545455	4.250051226	15.76483847
2	1.27586401112589	0.925691183	9.307553621
3	1.17640810463650	0.091687036	7.512294242
4	1.16420317321405	0.001228377	7.311699696
5	1.16403517169033	2.29506E-07	7.308967641
6	1.16403514028977	7.10543E-15	7.308967131
7	1.16403514028977	0	7.308967131

c $f(x) = x^3 - 5x + 4.2$ We start with $x_0 = 1.5, f(x_0) = 0.075$

n	xn	f(xn)	f'(xn)
0	1.5	0.075	1.75
1	1.457142857143	0.008186589	1.369795918
2	1.45116635450366	0.000155928	1.317651365
3	1.45104801685409	6.09639E-08	1.316621042
4	1.45104797055081	9.76996E-15	1.316620639
5	1.45104797055080	0	1.316620639

We note that a second solution also exists. We start with $x_0 = 1.1$, $f(x_0) = 0.031$

n	xn	f(xn)	f'(xn)
0	1.1	0.031	-1.37
1	1.122627737226	0.001701234	-1.219120891
2	1.12402319650002	6.56102E-06	-1.209715561
3	1.12402862010434	9.91909E-11	-1.209678984
4	1.12402862018633	0	-1.209678983

d $f(x) = x^3 - 2x^2 + 2x - 5$ We start with $x_0 = 2.5$, $f(x_0) = 3.125$

n	xn	f(xn)	f'(xn)
0	2.5	3.125	10.75
1	2.209302325581	0.440212811	7.805840995
2	2.15290701702655	0.014539377	7.293397804
3	2.15091351865629	1.77112E-05	7.27563282
4	2.15091108433957	2.63869E-11	7.275611141
5	2.15091108433594	0	7.275611141

e $f(x) = 2x^4 - 3x^2 + 2x - 6$ We start with $x_0 = -1.5$, $f(x_0) = -5.625$

n	xn	f(xn)	f'(xn)
0	-1.5	-5.625	-16
1	-1.851562500000	3.518282063	-37.67207718
2	-1.75817019655487	0.320742748	-30.92929622
3	-1.74780000429266	0.003650831	-30.22670348
4	-1.74767922265566	4.9098E-07	-30.21857364
5	-1.74767920640803	8.88178E-15	-30.21857255
6	-1.74767920640803	0	-30.21857255

2 The equation $x^3 = 3$ can be rearranged as follows;

$$x^3 = 3$$

$$3x^3 = 2x^3 + 3$$

$$x = \frac{2x^3 + 3}{3x^2}$$

1.9 1.10 1.11 *Unsaved	
Define $g(x) = \frac{2 \cdot x^3 + 3}{3 \cdot x^2}$	Done
$g(2)$	$\frac{19}{12}$
$g(g(g(2)))$	1.44235158436
$g(g(g(g(g(2))))))$	1.44224957031
3/4	

- 3 The equation $x^3 - 2x - 1 = 0$ can be rearranged to $x = \frac{2x^3 + 1}{3x^2 - 2}$

1.9 1.10 1.11 *Unsaved	
Define $g(x) = \frac{2 \cdot x^3 + 1}{3 \cdot x^2 - 2}$	Done
$g(2)$	$\frac{17}{10}$
$g(g(g(g(g(2))))))$	1.61803398875
7/99	

Solutions to Technology-free questions

1 $y = 4x - x^2$

a $\frac{dy}{dx} = 4 - 2x$

b Gradient at $Q(1, 3) = 4 - 2 = 2$

c Tangent at $Q : y - 3 = 2(x - 1)$
 $\therefore y = 2x + 1$

2 $y = x^3 - 4x^2$

a $\frac{dy}{dx} = 3x^2 - 8x$

b Gradient at $(2, -8) = 3(2)^2 - 8(2)$
 $= -4$

c Tangent at $(2, -8) = y + 8$
 $= -4(x - 2)$
 $y = -4x$

d Tangent meets curve when $y = x^3 - 4x^2$
 $= -4x$

$$\therefore x(x - 2)^2 = 0$$

$$x = 0, 2$$

Tangent cuts curve again at $(0, 0)$.

3 $y = x^3 - 12x + 2$

a $\frac{dy}{dx} = 3x^2 - 12$
 $= 3(x - 2)(x + 2)$

$$\frac{dy}{dx} = 0, \therefore x = \pm 2$$

$$y(-2) = 18, y(2) = -14$$

b Upright cubic.

$(-2, 18)$ is a local maximum and $(2, -14)$ is a local minimum.

- c Upright cubic.
 $(-2, 18)$ is a local maximum and $(2, -14)$ is a local minimum.

4 a $\frac{dy}{dx} = 3x^2$

Stationary pt of inflexion at $x = 0$:

x	-1	0	1
$\frac{dy}{dx}$	+	0	+

b $\frac{dy}{dx} = -3x^3$

Local maximum at $x = 0$:

x	-1	0	1
$\frac{dy}{dx}$	+	0	-

c $f'(x) = (x - 2)(x - 3)$

x	0	2	2.5	3	4
f'	+	0	-	0	+

Local maximum at $x = 2$, minimum at $x = 3$

d $f'(x) = (x - 2)(x + 2)$

x	-3	-2	0	2	3
f'	+	0	-	0	+

Local maximum at $x = -2$, minimum at $x = 2$

e $f'(x) = (2 - x)(x + 2)$

x	-3	-2	0	2	3
f'	-	0	+	0	-

Local minimum at $x = -2$, maximum at $x = 2$

f $f'(x) = -(x - 1)(x - 3)$

x	0	1	2	3	4
f'	-	0	+	0	-

Local minimum at $x = 1$, maximum at $x = 3$

g $\frac{dy}{dx} = -x^2 + x + 12 = (4 - x)(x + 3)$

x	-4	-3	0	4	5
$\frac{dy}{dx}$	-	0	+	0	-

Local minimum at $x = -3$, maximum at $x = 4$

h $\frac{dy}{dx} = 15 - 2x - x^2 = (3 - x)(x + 5)$

x	-6	-5	0	3	4
$\frac{dy}{dx}$	-	0	+	0	-

Local minimum at $x = -5$, maximum at $x = 3$

5 a $y = 4x - 3x^3, \therefore y' = 4 - 9x^2$

$$y' = 0, \therefore x = \pm \frac{2}{3}$$

$$y\left(-\frac{2}{3}\right) = -\frac{16}{9}, y\left(\frac{2}{3}\right) = \frac{16}{9}$$

Inverted cubic:

$\left(-\frac{2}{3}, -\frac{16}{9}\right)$ is a local minimum, $\left(\frac{2}{3}, \frac{16}{9}\right)$ is a local maximum.

b $y = 2x^3 - 3x^2 - 12x - 7$

$$\therefore y' = 6x^2 - 6x - 12$$

$$= 6(x-2)(x+1)$$

$$y' = 0, \therefore x = -1, 2$$

$$y(-1) = 0, y(2) = -27$$

Upright cubic:

$(-1, 0)$ is a local maximum,

$(2, -27)$ is a local minimum.

c $y = x(2x-3)(x-4)$

$$= 2x^3 - 11x^2 + 12x$$

$$\therefore y' = 6x^2 - 22x + 12$$

$$= 2(3x-2)(x-3)$$

$$y' = 0, \therefore x = \frac{2}{3}, 3$$

$$y(3) = -9,$$

$$y\left(\frac{2}{3}\right) = \frac{2}{3}\left(-\frac{5}{3}\right)\left(-\frac{10}{3}\right)$$

$$= \frac{100}{27}$$

Upright cubic:

$\left(\frac{2}{3}, \frac{100}{27}\right)$ is a local maximum,

$(3, -9)$ is a local minimum.

6 a $y = 3x^2 - x^3$

$$= x^2(3-x)$$

Axis intercepts at $(0, 0)$ and $(3, 0)$.

$$\begin{aligned}y' &= 6x - 3x^2 \\ &= 3x(2 - x)\end{aligned}$$

Stationary pts at $(0, 0)$ and $(2, 4)$.

Inverted cubic:

local min. at $(0, 0)$, max. at $(2, 4)$.

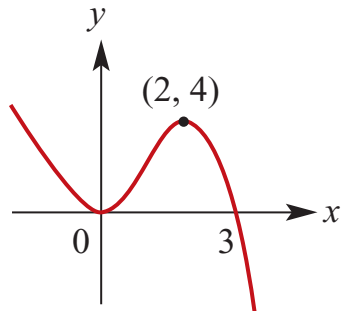

b $y = x^3 - 6x^2$

$$= x^2(x - 6)$$

Axis intercepts at $(0, 0)$ and $(6, 0)$.

$$\begin{aligned}y' &= 3x^2 - 12x \\ &= 3x(x - 4)\end{aligned}$$

Stationary pts at $(0, 0)$ and $(4, -32)$.

Upright cubic:

local max. at $(0, 0)$, min. at $(4, -32)$.

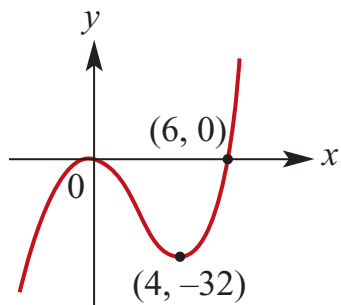

c $y = (x + 1)^2(2 - x)$

$$= 2 + 3x - x^3$$

Axis intercepts at $(0, 2)$, $(-1, 0)$ and $(2, 0)$.

$$\begin{aligned}y' &= 3 - 3x^2 \\ &= 3(1 - x)(1 + x)\end{aligned}$$

Stationary pts at $(-1, 0)$ and $(1, 4)$.

Inverted cubic:

local min. at $(-1, 0)$, max. at $(1, 4)$.

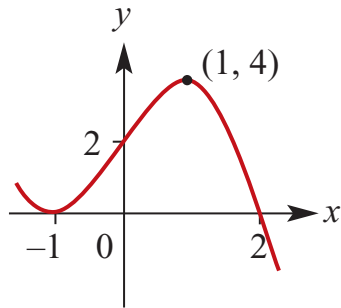

d $y = 4x^3 - 3x$

$$= x(2x - \sqrt{3})(2x + \sqrt{3})$$

Axis intercepts at $(0, 0)$, $(-\sqrt{3}/2, 0)$ and $(\sqrt{3}/2, 0)$.

$$y' = 12x^2 - 3$$

$$= 3(2x - 1)(2x + 1)$$

Stationary pts at $(-\frac{1}{2}, 1)$ and $(\frac{1}{2}, -1)$.

Upright cubic:

local max. $(-\frac{1}{2}, 1)$ min. $(\frac{1}{2}, -1)$.

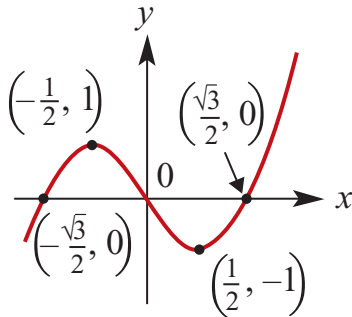

e $y = x^3 - 12x^2$

$$= x^2(x - 12)$$

Axis intercepts at $(0, 0)$ and $(12, 0)$.

$$y' = 3x^2 - 24x$$

$$= 3x(x - 8)$$

Stationary pts at $(0, 0)$ and $(8, -256)$.

Inverted cubic:

local max. $(0, 0)$, min. $(8, -256)$.

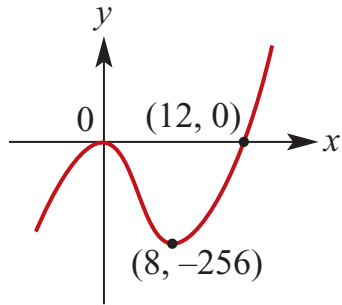

7 a C

b A

c B

8 $h = 20t - 5t^2$

$$v = \frac{dh}{dt} = 20 - 10t$$

a $\frac{dh}{dt} = 0$

$$\Rightarrow 20 - 10t = 0$$

$$\Rightarrow t = 2$$

Stone reaches the maximum height when $t = 2$

$$h(2) = 40 - 20 = 20$$

The maximum height is 20 m.

b $20t - 5t^2 = -60$

$$\Leftrightarrow 5t^2 - 20t - 60 = 0$$

$$\Leftrightarrow t^2 - 4t - 12 = 0$$

$$\Leftrightarrow (t - 6)(t + 2) = 0$$

$$\Leftrightarrow t = 6 \text{ or } t = -2$$

$$t \geq 0, \therefore t = 6$$

It takes 6 seconds to hit the beach.

c When $t = 6$, $v = 20 - 60$

The speed is 40 m/s

9 $x + y = 12 \Rightarrow y = 12 - x$

Let $M = x^2 + y^2$

Then $M = x^2 + 144 - 24x + x^2 = 2x^2 - 24x + 144$

Minimum value when $\frac{dM}{dx} = 0$

$$\frac{dM}{dx} = 4x - 24$$

\therefore minimum value when $x = 6$

Therefore minimum value is 72

10 $\frac{dv}{dt} = a = 4 - t$

$$\therefore v = 4t - \frac{1}{2}t^2 + c$$

When $t = 0, v = 0$

$$\therefore v = 4t - \frac{1}{2}t^2$$

$$v = \frac{dx}{dt} = 4t - \frac{1}{2}t^2$$

$$\therefore x = 2t^2 - \frac{1}{6}t^3 + c$$

When $t = 0, v = 0$

$$\therefore x = 2t^2 - \frac{1}{6}t^3$$

When $t = 3, v = \frac{15}{2}$ m/s

b Comes to rest when $v = 0$

$$4t - \frac{1}{2}t^2 = 0$$

$$t(4 - \frac{1}{2}t) = 0$$

$$t = 0 \text{ or } t = 8$$

When $t = 8$

$$x = 2 \times 8^2 - \frac{1}{6} \times 8^3$$

$$x = \frac{128}{3} \text{ m}$$

c When $t = 12, x = 0$

d Moves to the right for the first 8 seconds of motion. $x(8) = \frac{128}{3}$

It then returns to the origin in the next 4 seconds.

Hence the total distance travelled = $\frac{256}{3}$ m

The average speed = $\frac{256}{36} = \frac{64}{9}$ m/s

Solutions to multiple-choice questions

1 D $y = x^3 + 2x, \therefore y' = 3x^2 + 2$
Tangent at (1, 3) has gradient
 $y'(1) = 5$

$$y - 3 = 5(x - 1)$$

$$\therefore y = 5x - 2$$

2 E Normal at (1, 3) has gradient $= -\frac{1}{5}$

$$y - 3 = -\frac{1}{5}(x - 1)$$

$$\therefore y = -\frac{1}{5}x + \frac{16}{5}$$

3 E $y = 2x - 3x^3, \therefore y' = 2 - 9x^2$
Tangent at (0,0) has gradient
 $y'(0) = 2$
 $\therefore y = 2x$

4 A $f(x) = 4x - x^2$
Av. rate of change over [0, 1]
 $= \frac{f(1) - f(0)}{1} = 3$

5 C $S(t) = 4t^3 + 3t - 7$
 $\therefore S'(t) = 12t^2 + 3$
 $\therefore S(0) = 3 \text{ m/s}$

6 D $y = x^3 - 12x$
 $\therefore y' = 3x^2 - 12$
 $= 3(x - 2)(x + 2)$
 $y' = 0$ for $x = \pm 2$

7 D $y = 2x^3 - 6x$
 $\therefore y' = 6x^2 - 6 = 6$
So $6x^2 = 12$
 $\therefore x = \pm\sqrt{2}$

8 A $f(x) = 2x^3 - 5x^2 + x$
 $\therefore f'(x) = 6x^2 - 10x + 1$
 $\therefore f'(2) = 5$

9 A $y = \frac{1}{2}x^4 + 2x^2 - 5$
Av. rate of change over $[-2, 2]$
 $= \frac{y(-2) - y(-2)}{2 - (-2)} = 0$

10 C $y = x^2 - 8x + 1$
 $\therefore y' = 2x - 8$
Minimum value is $y(4) = -15$

11 A

12 A

Solutions to extended-response questions

1 a $s = 2 + 10t - 4t^2$

$$v = \frac{ds}{dt} = 10 - 8t, \text{ where } v \text{ is velocity}$$

$$\begin{aligned} \text{When } t = 3, \quad v &= 10 - 8(3) \\ &= -14 \end{aligned}$$

After 3 seconds, the velocity of the stone is -14 m/s (i.e. the stone is falling).

b $a = \frac{dv}{dt} = -8$

The acceleration due to gravity is -8 m/s².

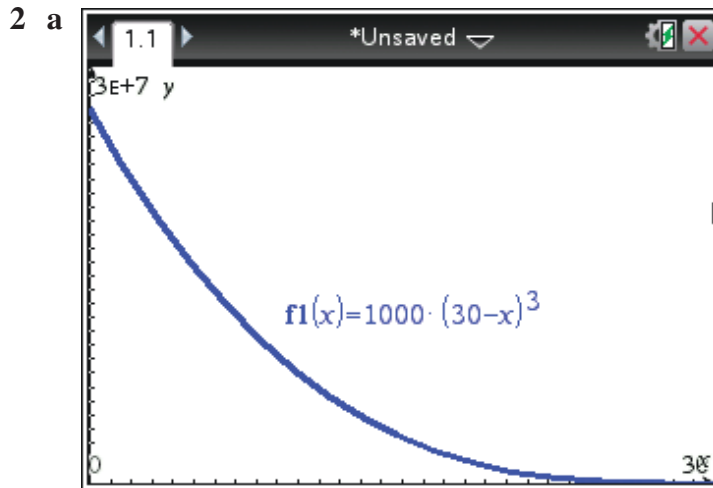

b i $2\,000\,000 = 1000(30 - t)^3$

$$2000 = (30 - t)^3$$

$$(2000)^{\frac{1}{3}} = 30 - t$$

$$\therefore t = 30 - (2000)^{\frac{1}{3}}$$

$$\approx 17.4 \text{ min}$$

ii $20\,000\,000 = 1000(30 - t)^3$

$$20\,000 = (30 - t)^3$$

$$(20\,000)^{\frac{1}{3}} = 30 - t$$

$$\therefore t = 30 - (20\,000)^{\frac{1}{3}}$$

$$\approx 2.9 \text{ min}$$

$$\begin{aligned}
 \text{c } V &= 1000(30 - t)^3 \\
 &= 1000(30 - t)(900 - 60t + t^2) \\
 &= 1000(27\,000 - 1800t + 30t^2 - 900t + 60t^2 - t^3) \\
 &= 1000(27\,000 - 2700t + 90t^2 - t^3) \\
 &= 27\,000\,000 - 2700\,000t + 90\,000t^2 - 1000t^3
 \end{aligned}$$

$$\begin{aligned}
 \frac{dV}{dt} &= -2700\,000 + 180\,000t - 3000t^2 \\
 &= -3000(900 - 60t + t^2) \\
 &= -3000(30 - t)^2, \quad t \geq 0
 \end{aligned}$$

At any time t , the dam is being emptied at the rate of $3000(30 - t)^2$ litres/min.

$$\text{d } \text{When } V = 0, 1000(30 - t)^3 = 0$$

$$\therefore 30 - t = 0$$

$$\therefore t = 30$$

It takes 30 minutes to empty the dam.

$$\text{e } \text{When } \frac{dV}{dt} = -8000 \quad -3000(30 - t)^2 = -8000$$

$$\therefore (30 - t)^2 = \frac{8}{3}$$

$$\therefore 30 - t = \pm \frac{\sqrt{8}}{\sqrt{3}}$$

$$\therefore t = 30 \pm \frac{2\sqrt{2}}{\sqrt{3}}$$

$$\therefore t = 30 - \frac{2\sqrt{2}}{\sqrt{3}}, \text{ as } t \leq 30$$

$$\therefore t \approx 28.37$$

Water is flowing out of the dam at 8000 litres per minute when t is approximately 28.37 minutes.

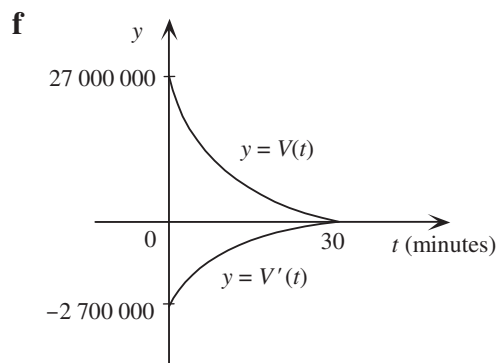

3 a

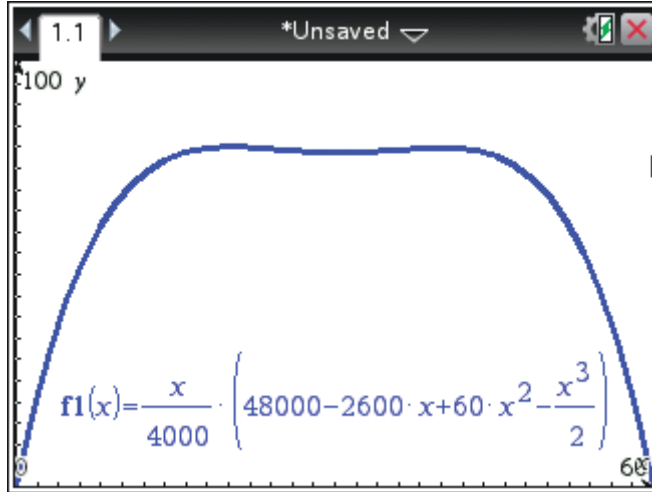

b Sketch the graph of $f_2 = 50$ and

TI: Press **Menu** → **6:Analyze Graph** → **4:Intersection**

CP: Tap **Analysis** → **G-Solve** → **Intersect**

After 5.71 days; quantity drops below this after 54.29 days.

c

$$W = \frac{x}{4000} \left(48000 - 2600x + 60x^2 - \frac{x^3}{2} \right)$$

$$= 12x - \frac{13}{20}x^2 + \frac{3}{200}x^3 - \frac{1}{8000}x^4$$

$$\frac{dW}{dx} = 12 - \frac{26}{20}x + \frac{9}{200}x^2 - \frac{4}{8000}x^3$$

$$= 12 - \frac{13}{10}x + \frac{9}{200}x^2 - \frac{1}{2000}x^3$$

$$\text{When } x = 20, \quad \frac{dW}{dx} = 12 - \frac{13}{10}(20) + \frac{9}{200}(20)^2 - \frac{1}{2000}(20)^3$$

$$= 12 - 26 + 18 - 4$$

$$= 0$$

$$\text{When } x = 40, \quad \frac{dW}{dx} = 12 - \frac{13}{10}(40) + \frac{9}{200}(40)^2 - \frac{1}{2000}(40)^3$$

$$= 12 - 52 + 72 - 32$$

$$= 0$$

$$\text{When } x = 60, \quad \frac{dW}{dx} = 12 - \frac{13}{10}(60) + \frac{9}{200}(60)^2 - \frac{1}{2000}(60)^3$$

$$= 12 - 78 + 162 - 108$$

$$= -12$$

The rate of increase of W , when $x = 20, 40$ and 60 is $0, 0$ and -12 tonnes per day respectively.

d When $x = 30$,
$$W = 12(30) - \frac{13}{20}(30)^2 + \frac{3}{200}(30)^3 - \frac{1}{8000}(30)^4$$

$$= 360 - 585 + 405 - 101.25 = 78.75$$

4 a When $t = 0$, $y = 15 + \frac{1}{80}(0)^2(30 - 0) = 15$
 When $t = 0$, the temperature is 15°C .

b
$$y = 15 + \frac{1}{80}t^2(30 - t)$$

$$= 15 + \frac{3}{8}t^2 - \frac{1}{80}t^3$$

$$\frac{dy}{dt} = \frac{3}{4}t - \frac{3}{80}t^2$$

When $t = 0$,
$$\frac{dy}{dt} = \frac{3}{4}(0) - \frac{3}{80}(0)^2 = 0$$

When $t = 5$,
$$\frac{dy}{dt} = \frac{3}{4}(5) - \frac{3}{80}(5)^2$$

$$= \frac{15}{4} - \frac{75}{80} = \frac{45}{16}$$

When $t = 10$,
$$\frac{dy}{dt} = \frac{3}{4}(10) - \frac{3}{80}(10)^2$$

$$= \frac{30}{4} - \frac{300}{80} = \frac{15}{4}$$

When $t = 15$,
$$\frac{dy}{dt} = \frac{3}{4}(15) - \frac{3}{80}(15)^2$$

$$= \frac{45}{4} - \frac{675}{80} = \frac{45}{16}$$

When $t = 20$,
$$\frac{dy}{dt} = \frac{3}{4}(20) - \frac{3}{80}(20)^2$$

$$= \frac{60}{4} - \frac{1200}{80} = 0$$

The rate of increase of y with respect to t when $t = 0, 5, 10, 15$ and 20 is $0, \frac{45}{16}, \frac{15}{4}, \frac{45}{16}$ and 0°C per minute respectively.

c

t	0	5	10	15	20
y	15	22.8125	40	57.1875	65

When $t = 5$,
$$y = 15 + \frac{1}{80}(5)^2(30 - 5)$$

$$= 22.8125$$

When $t = 20$,
$$y = 15 + \frac{1}{80}(20)^2(30 - 20)$$

$$= 65$$

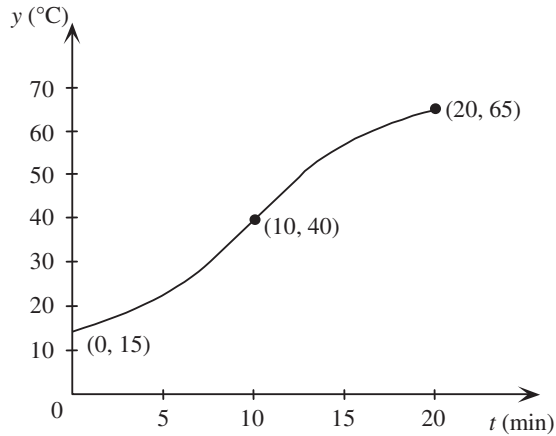

5 a

$$\begin{aligned}
 S &= 4000 + (t - 16)^3 \\
 &= 4000 + (t - 16)(t^2 - 32t + 256) \\
 &= 4000 + t^3 - 32t^2 + 256t - 16t^2 + 512t - 4096 \\
 &= t^3 - 48t^2 + 768t - 96
 \end{aligned}$$

$$\frac{dS}{dt} = 3t^2 - 96t + 768$$

$$\begin{aligned}
 \text{When } t = 0, \quad \frac{dS}{dt} &= 3(0)^2 - 96(0) + 768 \\
 &= 768
 \end{aligned}$$

Sweetness was increasing by 768 units/day when $t = 0$.

$$\begin{aligned}
 \text{b When } t = 4, \quad \frac{dS}{dt} &= 3(4)^2 - 96(4) + 768 \\
 &= 48 - 384 + 768 \\
 &= 432
 \end{aligned}$$

$$\begin{aligned}
 \text{When } t = 8, \quad \frac{dS}{dt} &= 3(8)^2 - 96(8) + 768 \\
 &= 192 - 768 + 768 \\
 &= 192
 \end{aligned}$$

$$\begin{aligned}
 \text{When } t = 12, \quad \frac{dS}{dt} &= 3(12)^2 - 96(12) + 768 \\
 &= 432 - 1152 + 768 \\
 &= 48
 \end{aligned}$$

$$\begin{aligned}
 \text{When } t = 16, \quad \frac{dS}{dt} &= 3(16)^2 - 96(16) + 768 \\
 &= 768 - 1536 + 768 \\
 &= 0
 \end{aligned}$$

c The rate of increase of sweetness is zero after 16 days.

d When $t = 0$, $S = 4000 + (0 - 16)^3$
 $= -96$

When $t = 4$, $S = 4000 + (4 - 16)^3$
 $= 2272$

When $t = 8$, $S = 4000 + (8 - 16)^3$
 $= 3488$

When $t = 16$, $S = 4000 + (16 - 16)^3$
 $= 4000$

Note that $\frac{dS}{dt} = 3t^2 - 96t + 768 = 3(t^2 - 32t + 256) = 3(t - 16)^2$ which implies

$\frac{dS}{dt} > 0$ for $0 \leq t < 16$.

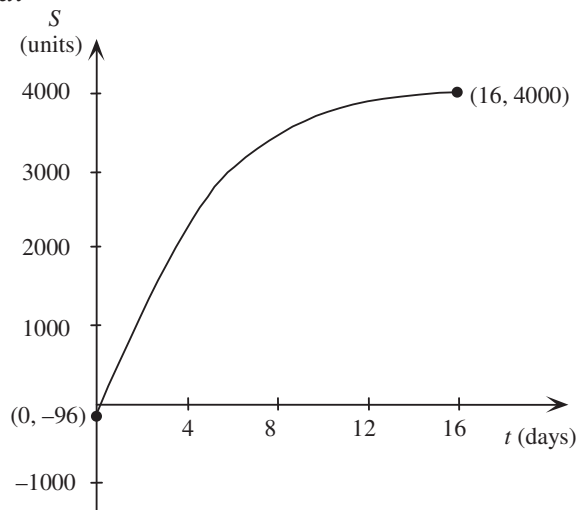

6 a $\frac{ds}{dt} = \frac{1}{3} + \frac{2}{9}t - \frac{1}{9}t^2$
 $= -\frac{1}{9}(t^2 - 2t - 3)$
 $= -\frac{1}{9}(t - 3)(t + 1)$

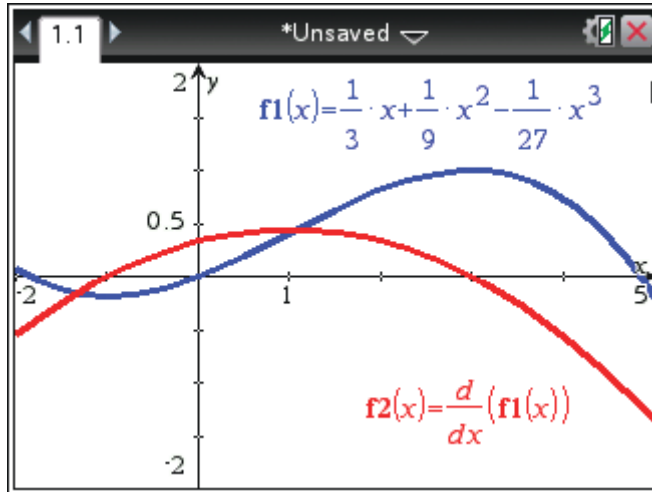

b When the train stops at stations, $\frac{ds}{dt} = 0$

$$\therefore -\frac{1}{9}(t-3)(t+1) = 0$$

$$\therefore t = 3 \text{ or } t = -1$$

When $t = -1$, the time is 1 minute before noon, i.e. 11.59 am is the time of departure from the first station.

When $t = 3$, the time is 3 minutes past noon, i.e. 12.03 pm is the time of arrival at the second station.

c When $t = -1$,

$$s = \frac{1}{3}(-1) + \frac{1}{9}(-1)^2 - \frac{1}{27}(-1)^3$$

$$= -\frac{1}{3} + \frac{1}{9} + \frac{1}{27} = -\frac{5}{27}$$

The first station is $\frac{5}{27}$ km before the signal box.

When $t = 3$,

$$s = \frac{1}{3}(3) + \frac{1}{9}(3)^2 - \frac{1}{27}(3)^3$$

$$= 1 + 1 - 1 = 1$$

The second station is 1 km after the signal box.

d Average velocity = $\frac{s_2 - s_1}{t_2 - t_1}$

where $s_2 = 1, s_1 = \frac{5}{27}, t_2 = 3, t_1 = -1$

$$\begin{aligned} \text{average velocity} &= \frac{1 - \frac{5}{27}}{3 - (-1)} \\ &= \frac{\frac{32}{27}}{4} = \frac{8}{27} \end{aligned}$$

$$\frac{8}{27} \text{ km/min} = \left(\frac{8}{27} \times 60\right) \text{ km/h} = \frac{160}{9} \text{ km/h}$$

\therefore average velocity = $17\frac{7}{9}$ km/h

The average velocity between the stations is $17\frac{7}{9}$ km/h.

e $v = \frac{ds}{dt} = -\frac{1}{9}(t-3)(t+1)$

When the train passes the signal box, $t = 0$

i.e. $v = -\frac{1}{9}(0-3)(0+1) = \frac{1}{3}$

$$\text{velocity} = \frac{1}{3} \text{ km/min} = \left(\frac{1}{3} \times 60\right) \text{ km/h} = 20 \text{ km/h}$$

The train passes the signal box at 20 km/h.

7 a $V(t) \geq 0$

\therefore $1000 + (2-t)^3 \geq 0$

\therefore $(2-t)^3 \geq -1000$

\therefore $2-t \geq -10$

\therefore $2 \geq t-10$

\therefore $t \leq 12$

Now $t \geq 0$ so the possible values of t are $0 \leq t \leq 12$.

b Rate of change in volume over time = $\frac{dV}{dt}$

$$\begin{aligned}
 \text{Now} \quad V &= 1000 + (2 - t)^3 \\
 &= 1000 + (2 - t)(4 - 4t + t^2) \\
 &= 1000 + 8 - 8t + 2t^2 - 4t + 4t^2 - t^3 \\
 &= 1008 - 12t + 6t^2 - t^3
 \end{aligned}$$

$$\begin{aligned}
 \therefore \frac{dV}{dt} &= -12 + 12t - 3t^2 \\
 &= -3(t^2 - 4t + 4) \\
 &= -3(t - 2)^2
 \end{aligned}$$

i When $t = 5$, $\frac{dV}{dt} = -3(5 - 2)^2 = -27$
 The rate of draining is 27 L/h when $t = 5$.

ii When $t = 10$, $\frac{dV}{dt} = -3(10 - 2)^2 = -192$
 The rate of draining is 192 L/h when $t = 10$.

8 a When $x = 0$,

$$\begin{aligned}
 y &= \frac{1}{5}(4(0)^3 - 8(0)^2 + 192(0) + 144) \\
 &= \frac{1}{5} \times 144 \\
 &= \frac{144}{5} \\
 &= 28.8
 \end{aligned}$$

The start of the track is 28.8 m above sea level.

b When $x = 6$,

$$\begin{aligned}
 y &= \frac{1}{5}(4(6)^3 - 8(6)^2 + 192(6) + 144) \\
 &= \frac{1}{5}(864 - 288 + 1152 + 144) \\
 &= \frac{1870}{5} \\
 &= 374.4
 \end{aligned}$$

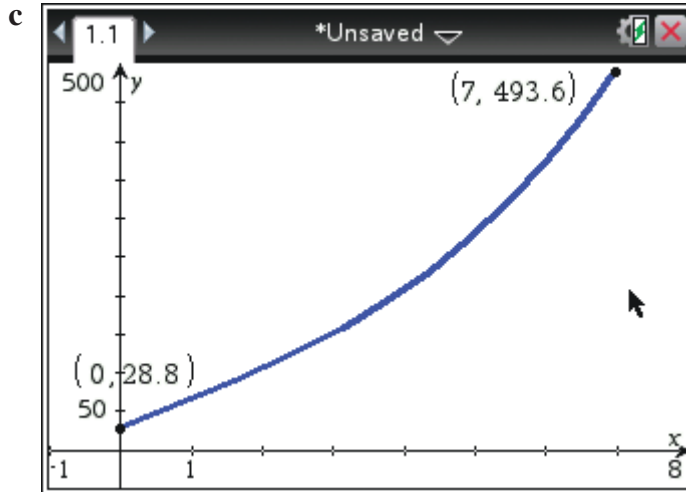

d The graph gets very steep for $x > 7$, which would not be practical.

e

$$y = \frac{4}{5}x^3 - \frac{8}{5}x^2 + \frac{192}{5}x + \frac{144}{5}$$

$$\text{Gradient} = \frac{dy}{dx} = \frac{12}{5}x^2 - \frac{16}{5}x + \frac{192}{5}$$

i When $x = 0$,

$$\begin{aligned} \frac{dy}{dx} &= \frac{12}{5}(0)^2 - \frac{16}{5}(0) + \frac{192}{5} \\ &= 38.4 \end{aligned}$$

$$\begin{aligned} 38.4 \text{ m/km} &= \left(38.4 \frac{1}{1000}\right) \text{ m/m} \\ &= 0.0384 \text{ m/m} \end{aligned}$$

The gradient of the graph is 0.0384 for $x = 0$.

ii When $x = 3$,

$$\begin{aligned} \frac{dy}{dx} &= \frac{12}{5}(3)^2 - \frac{16}{5}(3) + \frac{192}{5} \\ &= \frac{108}{5} - \frac{48}{5} + \frac{192}{5} \\ &= 50.4 \end{aligned}$$

$$\begin{aligned} 50.4 \text{ m/km} &= \left(50.4 \times \frac{1}{1000}\right) \text{ m/m} \\ &= 0.0504 \text{ m/m} \end{aligned}$$

The gradient of the graph is 0.0504 for $x = 3$.

iii When $x = 7$,

$$\begin{aligned}\frac{dy}{dx} &= \frac{12}{5}(7)^2 - \frac{16}{5}(7) + \frac{192}{5} \\ &= \frac{588}{5} - \frac{112}{5} + \frac{192}{5} \\ &= \frac{668}{5} \\ &= 133.6\end{aligned}$$

$$\begin{aligned}133.6\text{m/km} &= \left(133.6 \times \frac{1}{1000}\right)\text{m/m} \\ &= 0.1336\text{ m/m}\end{aligned}$$

The gradient of the graph is 0.1336 for $x = 7$.

9 a $y = x^3$

Point of inflexion at $(0, 0)$

When $x = -1$, $y = -1$ $(-1, -1)$

When $x = 1$, $y = 1$ $(1, 1)$

$$\begin{aligned}y &= 2 + x - x^2 \\ &= -(x^2 - x - 2) \\ &= -(x - 2)(x + 1)\end{aligned}$$

When $x = 0$, $y = -(0 - 2)(0 + 1)$
 $= 2$

\therefore y-axis intercept is 2.

When $y = 0$, $-(x - 2)(x + 1) = 0$

$\therefore x - 2 = 0$ or $x + 1 = 0$

$\therefore x = 2$ or $x = -1$

\therefore x-axis intercepts are -1 and 2 .

By symmetry, turning point is at $x = \frac{2 + (-1)}{2} = \frac{1}{2}$.

When $x = \frac{1}{2}$, $y = -\left(\frac{1}{2} - 2\right)\left(\frac{1}{2} + 1\right)$
 $= -\left(\frac{-3}{2}\right)\left(\frac{3}{2}\right)$

$$= \frac{9}{4}$$

\therefore turning point is $\left(\frac{1}{2}, \frac{9}{4}\right)$.

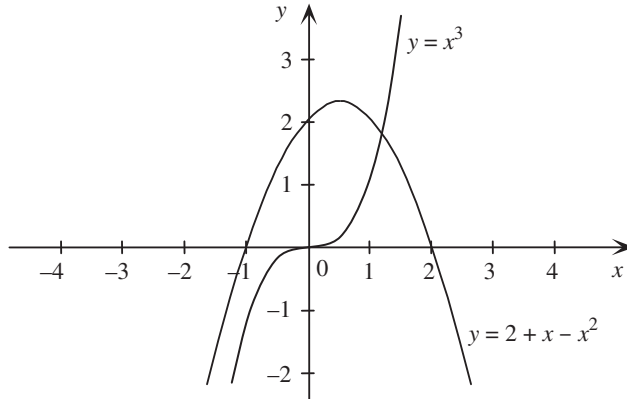

b For $x \leq 0$, $2 + x - x^2 \geq x^3$.

The vertical distance between the two curves is given by $y = 2 + x - x^2 - x^3$, $x \leq 0$.

x	-3	-2	-1	0
y	17	4	1	2

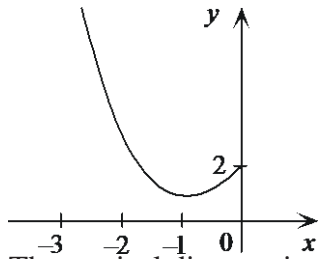

The vertical distance is a minimum when y is a minimum.

This occurs where $\frac{dy}{dx} = 0$.

Now $\frac{dy}{dx} = 1 - 2x - 3x^2$

Consider $0 = 1 - 2x - 3x^2$

$$\therefore 0 = (-3x + 1)(x + 1)$$

$$\therefore x + 1 = 0 \quad \text{or} \quad -3x + 1 = 0$$

$$\therefore x = -1 \quad \text{or} \quad x = \frac{1}{3}$$

But $x \leq 0$, so $x = -1$ and $y = 2 + (-1) - (-1)^2 - (-1)^3 = 1$.

Hence the minimum distance between the two curves is 1 unit when $x = -1$.

10

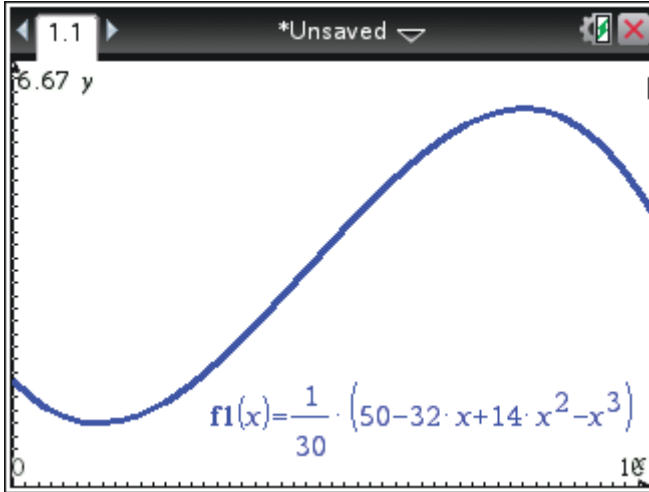

$$M(x) = \frac{5}{3} - \frac{16}{15}x + \frac{7}{15}x^2 - \frac{1}{30}x^3 \quad \leq x \leq 10$$

$$M'(x) = -\frac{16}{15} + \frac{14}{15}x - \frac{1}{10}x^2$$

Stationary points occur where

$$M'(x) = 0$$

$$\therefore -\frac{16}{15} + \frac{14}{15}x - \frac{1}{10}x^2 = 0$$

$$\therefore -\frac{1}{10}x^2 + \frac{14}{15}x - \frac{16}{15} = 0$$

$$\therefore -\frac{1}{30}(3x^2 - 28x + 32) = 0$$

$$\therefore -\frac{1}{30}(3x - 4)(x - 8) = 0$$

$$\therefore 3x - 4 = 0 \quad \text{or} \quad x - 8 = 0$$

$$x = \frac{4}{3} \quad \text{or} \quad x = 8$$

x	0	$\frac{4}{3}$	2	8	10
Sign of $M'(x)$	-	0	+	0	-
Shape	\	—	/	—	\

Hence the minimum number of mosquitoes is produced when rainfall is $\frac{4}{3}$ mm and the maximum number is produced when rainfall is 8 mm.

11 a $x + y = 5$

$$\therefore y = 5 - x$$

b $P = xy$

$$\therefore P = x(5 - x)$$

c $P = 5x - x^2$

$$\frac{dP}{dx} = 5 - 2x$$

Stationary points occur where $\frac{dP}{dx} = 0$

$$\therefore 5 - 2x = 0$$

$$\therefore x = 2.5$$

As coefficient of x^2 is negative, there is a local maximum at $x = 2.5$.

When $x = 2.5$, $y = 5 - 2.5$

$$= 2.5$$

and $P = xy$

$$= 2.5 \times 2.5$$

$$= 6.25, \text{ the maximum value of } P.$$

12 a $2x + y = 10$

$$\therefore y = 10 - 2x$$

b $A = x^2y$

$$\therefore A = x^2(10 - 2x)$$

c $A = 10x^2 - 2x^3$

$$\frac{dA}{dx} = 20x - 6x^2$$

Stationary points occur where $\frac{dA}{dx} = 0$

$$\therefore 20x - 6x^2 = 0$$

$$\therefore 2x(10 - 3x) = 0$$

$$\therefore x = 0 \text{ or } 10 - 3x = 0$$

$$x = \frac{10}{3}$$

x	0	1	$\frac{10}{3}$	4
Sign of $\frac{dA}{dx}$	0	+	0	-
Shape	—	/	—	\

The maximum value of A occurs at $x = \frac{10}{3}$.

$$\text{When } x = \frac{10}{3}, \quad y = 10 - 2x = 10 - 2\left(\frac{10}{3}\right) = \frac{10}{3}$$

$$A = x^2y$$

$$= \left(\frac{10}{3}\right)^2 \times \frac{10}{3} = \frac{1000}{27}$$

Maximum value of A of $\frac{1000}{27}$ occurs where $x = y = \frac{10}{3}$.

$$\mathbf{13} \quad xy = 10 \quad \therefore \quad y = \frac{10}{x}$$

$$T = 3x^2y - x^3$$

$$= 3x^2 \times \frac{10}{x} - x^3$$

$$= 30x - x^3$$

$$\frac{dT}{dx} = 30 - 3x^2$$

Stationary points occur where $\frac{dT}{dx} = 0$

$$30 - 3x^2 = 0$$

$$30 = 3x^2$$

$$x^2 = 10$$

$$x = \pm\sqrt{10}$$

$$\therefore \quad x = \sqrt{10} \quad \text{as } 0 < x < \sqrt{30}$$

x	0	$\sqrt{10}$	4
Sign of $\frac{dT}{dx}$	+	0	-
Shape	/	—	\

Hence the maximum value of T occurs when $x = \sqrt{10}$.

$$\text{When } x = \sqrt{10}, \quad T = 30\sqrt{10} - (\sqrt{10})^3$$

$$= \sqrt{10}(30 - 10)$$

$$= 20\sqrt{10}$$

$$\approx 63.25$$

$$\mathbf{14} \quad \mathbf{a} \quad x + y = 8 \quad \therefore \quad y = 8 - x$$

$$\mathbf{b} \quad s = x^2 + y^2$$

$$= x^2 + (8 - x)^2$$

c

$$\begin{aligned} s &= x^2 + (8 - x)^2 \\ &= x^2 + 64 - 16x + x^2 \\ &= 2x^2 - 16x + 64 \end{aligned}$$

$$\frac{ds}{dx} = 4x - 16$$

Stationary points occur where

$$\frac{ds}{dx} = 0$$

\therefore

$$4x - 16 = 0$$

$$4x = 16$$

$$x = 4$$

x	0	4	5
Sign of $\frac{ds}{dx}$	-	0	+
Shape	\	—	/

or $x = 4$ is a local minimum because coefficient of x^2 is positive.

Hence the least value of the sum of the squares occurs at $x = 4$.

$$\begin{aligned} \text{When } x = 4, \quad s &= x^2 + (8 - x)^2 \\ &= 4^2 + (8 - 4)^2 \\ &= 16 + 4^2 \\ &= 16 + 16 \\ &= 32 \end{aligned}$$

15 Let x and y be the two numbers.

$$x + y = 4 \quad \therefore y = 4 - x$$

$$\begin{aligned} s &= x^3 + y^2 \quad \therefore s = x^3 + (4 - x)^2 \\ &= x^3 + 16 - 8x + x^2 \\ &= x^3 + x^2 - 8x + 16 \end{aligned}$$

$$\frac{ds}{dx} = 3x^2 + 2x - 8$$

$$\text{When } \frac{ds}{dx} = 0, \quad 3x^2 + 2x - 8 = 0$$

$$\therefore (3x - 4)(x + 2) = 0$$

$$\therefore 3x - 4 = 0 \quad \text{or } x + 2 = 0$$

$$x = \frac{4}{3} \quad \text{or } x = -2$$

x	-3	-2	0	$\frac{4}{3}$	2
Sign of $\frac{ds}{dx}$	+	0	-	0	+
Shape	/	—	\	—	/

Note: Positive numbers are considered, so $x = -2$ need not be considered.

s will be as small as possible when $x = \frac{4}{3}$

and

$$y = 4 - x$$

$$= 4 - \frac{4}{3} = \frac{8}{3}$$

Hence the two numbers are $\frac{4}{3}$ and $\frac{8}{3}$.

16 Let x be the length, y the width and A the area of the rectangle.

$$\therefore 2(x + y) = 100$$

$$\therefore x + y = 50$$

$$\therefore y = 50 - x$$

$$A = xy$$

$$= x(50 - x) = 50x - x^2$$

$$\frac{dA}{dx} = 50 - 2x$$

$$\text{When } \frac{dA}{dx} = 0, \quad 50 - 2x = 0 \quad \therefore x = 25$$

A local maximum at $x = 25$, as the coefficient of x^2 is negative.

$$\text{When } x = 25, \quad y = 50 - x = 25$$

The area is a maximum (625 m^2) when the rectangle is a square of side length 25 m.

17 Let y be the second number and P the product of the two numbers.

$$x + y = 24$$

$$\therefore y = 24 - x$$

$$P = xy$$

$$= x(24 - x)$$

$$= 24x - x^2$$

$$\frac{dP}{dx} = 24 - 2x$$

$$\text{When } \frac{dP}{dx} = 0, \quad 24 - 2x = 0$$

$$\therefore x = 12$$

There is a local maximum at $x = 12$, as the coefficient of x^2 is negative.
Hence, the product of the two numbers is a maximum when $x = 12$.

18 Let $C =$ overhead costs (\$/h)

$$\therefore C = 400 - 16n + \frac{1}{4}n^2$$

$$\frac{dC}{dn} = -16 + \frac{1}{2}n$$

$$\text{When } \frac{dC}{dn} = 0, \quad -16 + \frac{1}{2}n = 0$$

$$\therefore n = 32$$

There is a local minimum at $n = 32$, as the coefficient of n^2 is positive.
Hence, 32 items should be produced per hour to keep costs to a minimum.

19 $x + y = 100$

$$\therefore y = 100 - x$$

$$\begin{aligned} P &= xy \\ &= x(100 - x) \\ &= 100x - x^2 \end{aligned}$$

$$\frac{dP}{dx} = 100 - 2x$$

$$\text{When } \frac{dP}{dx} = 0, \quad 100 - 2x = 0$$

$$\therefore x = 50$$

There is a local maximum at $x = 50$, as the coefficient of x^2 is negative.

$$\begin{aligned} \text{When } x = 50, \quad y &= 100 - x \\ &= 100 - 50 \\ &= 50 \end{aligned}$$

$$\text{Hence } x = y$$

$$\begin{aligned} \text{When } x = 50, \quad P &= xy \\ &= 50 \times 50 \\ &= 2500, \text{ the maximum value of } P. \end{aligned}$$

20 Let x be the length of river (in km) to be used as a side of the enclosure and let y be the side length of the rectangle (in km) perpendicular to the river.

$$\therefore x + 2y = 4$$

$$\therefore y = \frac{1}{2}(4 - x)$$

Let $A = xy$, the area of the land enclosed.

$$\begin{aligned}\therefore A &= x \times \frac{1}{2}(4 - x) \\ &= 2x - \frac{1}{2}x^2\end{aligned}$$

$$\frac{dA}{dx} = 2 - x$$

$$\text{When } \frac{dA}{dx} = 0, \quad 2 - x = 0$$

$$x = 2$$

There is a local maximum at $x = 2$, as the coefficient of x^2 is negative.

$$\begin{aligned}\text{When } x = 2, \quad y &= \frac{1}{2}(4 - x) \\ &= \frac{1}{2}(4 - 2) = 1\end{aligned}$$

Hence the maximum area of land of 2 km^2 will be enclosed if the farmer uses a 2 km stretch of river and a width of 1 km for his land.

21 $p^3q = 9$ and $p, q > 0$

$$\begin{aligned}\therefore q &= \frac{9}{p^3} \\ &= 9p^{-3}\end{aligned}$$

$$\begin{aligned}z &= 16p + 3q \\ &= 16p + 3(9p^{-3}) \\ &= 16p + 27p^{-3}\end{aligned}$$

We know that $\frac{d}{dx}(x^n) = nx^{n-1}$ when $n = 1, 2, 3$

Now suppose this also true for $n = -1, -2, -3, \dots$

$$\text{So } \frac{d}{dx}(p^{-3}) = -3p^{-4}$$

$$\text{Hence } \frac{dz}{dp} = 16 - 81p^{-4}$$

$$\text{When } \frac{dz}{dp} = 0, \quad 16 - 81p^{-4} = 0$$

$$16 = 81p^{-4}$$

$$p^{-4} = \frac{16}{81}$$

$$p^4 = \frac{81}{16}$$

$$p = \frac{\sqrt[4]{81}}{\sqrt[4]{16}} = \frac{3}{2}$$

$$= \pm \frac{3}{2}$$

p	1	$\frac{3}{2}$	2
Sign of $\frac{dz}{dp}$	-	0	+
Shape	\	—	/

Hence z is a minimum when

$$p = \frac{3}{2}$$

and

$$q = \frac{9}{p^3}$$

$$= \frac{9}{\left(\frac{3}{2}\right)^3}$$

$$= \frac{9 \times 8}{27}$$

$$= \frac{8}{3}$$

So $p = \frac{3}{2}$ and $q = \frac{8}{3}$.

22 a $2(x + y) = 120$

$$x + y = 60$$

$$y = 60 - x$$

b $S = 5x^2y$

$$= 5x^2(60 - x)$$

c $S > 0, \therefore 5x^2(60 - x) > 0$

$$\therefore 0 < x < 60$$

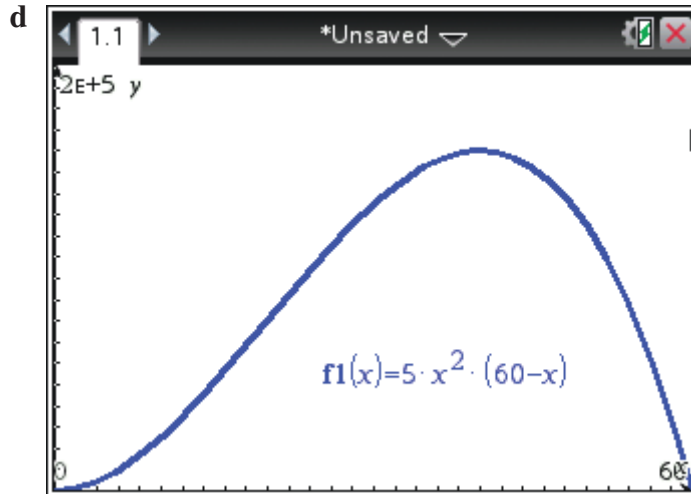

e

$$S = 5x^2(60 - x)$$

$$= 300x^2 - 5x^3$$

$$\frac{dS}{dx} = 600x - 15x^2$$

$$= 0$$

if $x = 0$ or $x = 40$

From the graph, the maximum occurs at $x = 40$

$$\therefore \quad y = 60 - x$$

$$= 60 - 40$$

$$= 20$$

Hence $x = 40$ and $y = 20$ give the strongest beam.

f For $x \leq 19$, the maximum strength of the beam occurs when $x = 19$.

$$\therefore \quad S = 5 \times 19^2(60 - 19)$$

$$= 74\,005$$

The maximum strength of the beam, if the cross-sectional depth of the beam must be less than 19 cm, is 74 005.

23

$$s'(x) = -3x^2 + 6x + 360$$

$$= -3(x^2 - 2x - 120)$$

$$= -3(x + 10)(x - 12)$$

When $s'(x) = 0$, $-3(x + 10)(x - 12) = 0$

$$\therefore x + 10 = 0 \text{ or } x - 12 = 0$$

$$\therefore x = -10 \text{ or } x = 12$$

But $6 \leq x \leq 20$, so $x = 12$.

x	10	12	14
Sign of $s'(x)$	+	0	-
Shape	/	—	\

Hence the maximum number of salmon swimming upstream occurs when the water temperature is 12°C .

- 24 a** Let x (cm) be the breadth of the box, $2x$ (cm) be the length of the box, and h (cm) be the height of the box.

$$4(x + 2x) + 4h = 360$$

$$\therefore 4h = 360 - 4(3x)$$

$$\therefore h = 90 - 3x$$

$$\begin{aligned} V &= x \times 2x \times h \\ &= 2x^2(90 - 3x) \\ &= 180x^2 - 6x^3 \text{ as required} \end{aligned}$$

b $V = 6x^2(30 - x)$

$$\therefore \text{Domain } V = \{x: 0 < x < 30\}$$

c

$$V = 180x^2 - 6x^3$$

$$\frac{dV}{dx} = 360x - 18x^2$$

$$= 18x(20 - x)$$

$$\text{When } \frac{dV}{dx} = 0 \quad 18x(20 - x) = 0$$

$$\therefore 18x = 0 \quad \text{or} \quad 20 - x = 0$$

$$\therefore x = 0 \quad \text{or} \quad x = 20$$

x	-10	0	10	20	30
Sign of $\frac{dV}{dx}$	-	0	+	0	-
Shape	\	—	/	—	\

Hence V is a minimum when $x = 0$ and a maximum when $x = 20$.

$$\text{When } x = 0, \quad V = 180(0)^2 - 6(0)^3$$

$$= 0$$

\therefore y-axis intercept is 0.

When $V = 0$, $180x^2 - 6x^3 = 0$
 $\therefore 6x^2(30 - x) = 0$
 $\therefore 6x^2 = 0$ or $30 - x = 0$
 $x = 0$ or $x = 30$
 $\therefore x$ -axis intercepts are 0 and 30.

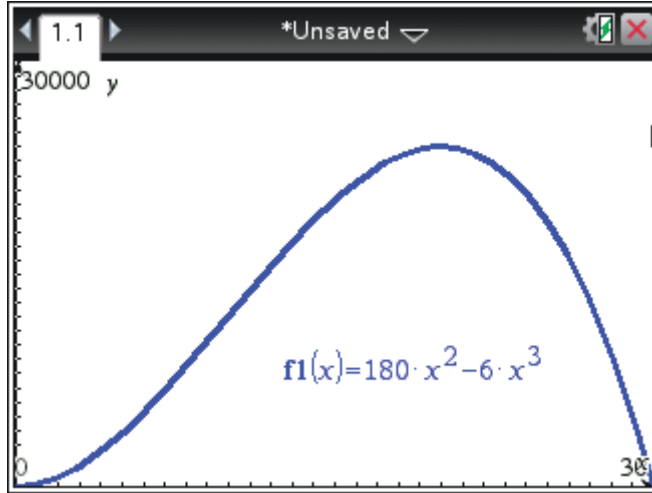

d From part **c**, V is a maximum when $x = 20$.

$$\begin{aligned} \therefore h &= 90 - 3x \\ &= 90 - 60 \\ &= 30 \end{aligned}$$

Hence the dimensions giving the greatest volume are 20 cm \times 30 cm \times 40 cm.

e On a CAS calculator, with $f1 = 180x^2 - 6x^3$ and $f2 = 20\,000$,

TI: Press **Menu** \rightarrow **6:Analyze Graph** \rightarrow **4:Intersection**

CP: Tap **Analysis** \rightarrow **G-Solve** \rightarrow **Intersect**

The x -coordinates of the points of intersection are 14.817 02 and 24.402 119. Hence the values of x for which $V = 20\,000$ are 14.82 and 24.40, correct to 2 decimal places.

25 a

$$\begin{aligned} A &= 8x \times y + 2\left(\frac{1}{2} \times 4x \times \sqrt{(5x)^2 - (4x)^2}\right) \\ &= 8xy + 4x \times \sqrt{25x^2 - 16x^2} \\ &= 8xy + 4x \times \sqrt{9x^2} \\ &= 8xy + 4x \times 3x \text{ (only positive square root appropriate)} \\ &= 8xy + 12x^2 \end{aligned}$$

Also

$$8x + y + y + 5x + 5x = 90$$

$$\therefore 18x + 2y = 90$$

$$2y = 90 - 18x$$

$$y = 45 - 9x$$

$$\begin{aligned}\therefore A &= 8x(45 - 9x) + 12x^2 \\ &= 360x - 72x^2 + 12x^2\end{aligned}$$

$$\therefore A = 360x - 60x^2 \text{ as required}$$

$$\mathbf{b} \quad A = 360x - 60x^2, \quad \therefore \frac{dA}{dx} = 360 - 120x$$

$$\text{When } \frac{dA}{dx} = 0, \quad 360 - 120x = 0$$

$$x = 3$$

Area is a maximum at $x = 3$, as the coefficient of x^2 is negative.

$$\begin{aligned}\text{When } x = 3, \quad y &= 45 - 9x \\ &= 45 - 27 \\ &= 18\end{aligned}$$

26 a Let r (cm) be the radius of the circle and x (cm) be the side length of the square.

$$2\pi r + 4x = 100$$

$$2\pi r = 100 - 4x$$

$$r = \frac{50 - 2x}{\pi}$$

$$\text{As } r > 0, \quad 50 - 2x > 0$$

$$\text{i.e. } x < 25$$

Let A be the sum of the areas of the circle and the square.

$$\begin{aligned}\therefore A &= \pi r^2 + x^2 \\ &= \pi \left(\frac{50 - 2x}{\pi} \right)^2 + x^2 \\ &= \frac{1}{\pi} (2500 - 200x + 4x^2) + x^2 \\ &= \frac{2500}{\pi} - \frac{200}{\pi}x + \frac{4}{\pi}x^2 + x^2\end{aligned}$$

i.e.
$$A = \frac{4 + \pi}{\pi}x^2 - \frac{200}{\pi}x + \frac{2500}{\pi}, x \in [0, 25]$$

$$\frac{dA}{dx} = \frac{2(4 + \pi)}{\pi}x - \frac{200}{\pi}$$

When $\frac{dA}{dx} = 0$,
$$\frac{2(4 + \pi)}{\pi}x - \frac{200}{\pi} = 0$$

$$2(4 + \pi)x = 200$$

$$x = \frac{100}{4 + \pi}$$

The area is a minimum when $x = \frac{100}{4 + \pi}$, as the coefficient of x^2 is positive.

When $x = \frac{100}{4 + \pi}$,
$$4x = \frac{400}{4 + \pi} \approx 56$$

and
$$2\pi r = 2\pi\left(\frac{50 - 2x}{\pi}\right)$$

$$= 100 - 4x$$

$$= 100 - 4\left(\frac{100}{4 + \pi}\right)$$

$$= 100 - \frac{400}{4 + \pi}$$

$$\approx 44$$

Hence the wire should be cut into a 56 cm strip to form the square, and 44 cm to form the circle.

b When $x = 0$,
$$A = \frac{4 + \pi}{\pi}(0)^2 - \frac{200}{\pi}(0) + \frac{2500}{\pi}$$

$$= \frac{2500}{\pi}$$

$$\approx 796$$

When $x = 25$,
$$A < \frac{2500}{\pi}$$

Hence the maximum area occurs when $x = 0$ and all the wire is used to form the circle.

27
$$2(x + 2x + x) + 2x + 4y = 36$$

$$2(4x) + 2x + 4y = 36$$

$$10x + 4y = 36$$

$$4y = 36 - 10x$$

$$y = 9 - \frac{5}{2}x$$

Let A (m^2) be the area of the court.

$$\begin{aligned}A &= 4xy \\ &= 4x\left(9 - \frac{5}{2}x\right) \\ &= 36x - 10x^2\end{aligned}$$

$$\frac{dA}{dx} = 36 - 20x$$

$$\text{When } \frac{dA}{dx} = 0, \quad 36 - 20x = 0$$

$$20x = 36$$

$$x = \frac{9}{5}$$

Area is a maximum when $x = \frac{9}{5}$, as the coefficient of x^2 is negative.

$$\text{When } x = \frac{9}{5}, \quad \text{length} = 4x$$

$$= 4 \times \frac{9}{5}$$

$$= 7.2$$

and

$$\text{width} = y$$

$$= 9 - \frac{5}{2}x$$

$$= 9 - \frac{5}{2} \times \frac{9}{5}$$

$$= 4.5$$

The length is 7.2 m and the width is 4.5 m.

28 a $A = xy$

b $x + 2y = 16$

$$2y = 16 - x$$

$$y = 8 - \frac{x}{2}$$

$$A = \left(8 - \frac{x}{2}\right)x$$

c When $A = 0$, $x\left(8 - \frac{1}{2}x\right) = 0$

$$x = 0 \quad \text{or} \quad x = 16$$

$$\therefore \quad \text{Domain} = \{x: 0 < x < 16\}$$

d Turning point is at $x = \frac{0 + 16}{2} = 8$

When $x = 8$, $A = x(8 - \frac{1}{2}x)$
 $= 8(8 - \frac{1}{2}(8))$
 $= 32$

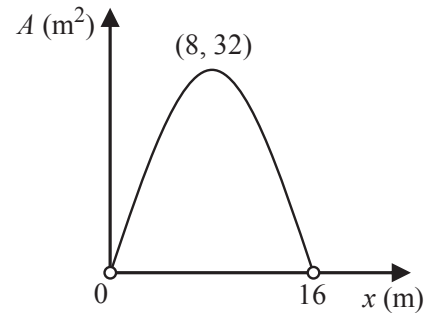

e Calculus could be used, but as the graph is a parabola with turning point (8, 32), the maximum is 32. Therefore, the largest area of ground which could be covered is 32 m².

29 $2a + h + h + 2a + 2a = 8000$

$\therefore 6a + 2h = 8000$

$\therefore 2h = 8000 - 6a$

$\therefore h = 4000 - 3a$

Let A be the area of the shape and v be the vertical height of the triangle.

$$\begin{aligned} v &= \sqrt{(2a)^2 - a^2} \\ &= \sqrt{4a^2 - a^2} \\ &= \sqrt{3a^2} \\ &= \sqrt{3}a \end{aligned}$$

$$\begin{aligned} A &= 2ah + \frac{1}{2}(2a)v \\ &= 2a(4000 - 3a) + a \times \sqrt{3}a \\ &= 8000a - 6a^2 + \sqrt{3}a^2 \\ &= (\sqrt{3} - 6)a^2 + 8000a \end{aligned}$$

$$\frac{dA}{da} = 2(\sqrt{3} - 6)a + 8000$$

When $\frac{dA}{da} = 0$, $2(\sqrt{3} - 6)a + 8000 = 0$

$$\begin{aligned} \therefore a &= \frac{8000}{2(6 - \sqrt{3})} \\ &= \frac{4000}{6 - \sqrt{3}} \\ &\approx 937 \end{aligned}$$

The area is a maximum when $a = 937$, as the coefficient of a^2 is negative.

$$\text{When } a = \frac{4000}{6 - \sqrt{3}},$$

$$h = 4000 - 3a$$

$$= 4000 - \frac{3 \times 4000}{6 - \sqrt{3}}$$

$$\approx 4000 - 2812 = 1188$$

The maximum amount of light passes through when $a = 931$ and $h = 1188$.

30 a $\pi x + y = 10$

$$\therefore y = 10 - \pi x$$

b When $x = 0$, $y = 10 - \pi(0)$

$$= 10$$

When $y = 0$, $10 - \pi x = 0$

$$\therefore x = \frac{10}{\pi}$$

Hence all possible values of x are $0 \leq x \leq \frac{10}{\pi}$.

c

$$\begin{aligned} A &= xy + \frac{\pi}{2}x^2 \\ &= x(10 - \pi x) + \frac{\pi}{2}x^2 \\ &= 10x - \pi x^2 + \frac{\pi}{2}x^2 \\ &= \frac{x}{2}(20 - \pi x) \end{aligned}$$

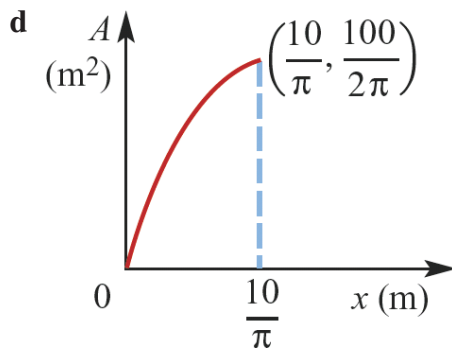

e $A = 10x - \frac{\pi}{2}x^2$

$\therefore \frac{dA}{dx} = 10 - \pi x$

When $\frac{dA}{dx} = 0$, $10 - \pi x = 0$

$\therefore x = \frac{10}{\pi}$

The value of x which maximises A is $\frac{10}{\pi}$.

f When $x = \frac{10}{\pi}$, $y = 10 - \pi \times \frac{10}{\pi} = 0$

The capacity of the drain is a maximum when the cross-section is a semi-circle.

31 a Surface area = $2\pi xh + 2\pi x^2$

$\therefore 1000 = 2\pi xh + 2\pi x^2$

$\therefore 500 = \pi xh + \pi x^2$

$\therefore h = \frac{500 - \pi x^2}{\pi x} = \frac{500}{\pi x} - x$

b $V = \pi x^2 h$

$$= \pi x^2 \left(\frac{500 - \pi x^2}{\pi x} \right)$$

$$= x(500 - \pi x^2) = 500x - \pi x^3$$

c $\frac{dV}{dx} = 500 - 3\pi x^2$

d $\frac{dV}{dx} = 0$

implies $500 - 3\pi x^2 = 0$

$\therefore x = \frac{\sqrt{500}}{\sqrt{3\pi}}$ as $x > 0$

$\therefore x = \frac{10\sqrt{5}}{\sqrt{3\pi}} \approx 7.28$

e $h > 0$ and $x > 0$

$$\therefore \frac{500 - \pi x^2}{\pi x} > 0$$

$$\therefore 500 > \pi x^2$$

$$\therefore \frac{500}{\pi} > x^2$$

$$\therefore x < \frac{\sqrt{500}}{\sqrt{\pi}} \text{ for } x > 0$$

$$\therefore x < \frac{10\sqrt{5}}{\sqrt{\pi}}$$

$$\therefore \text{domain} = \left(0, \frac{10\sqrt{5}}{\sqrt{\pi}}\right)$$

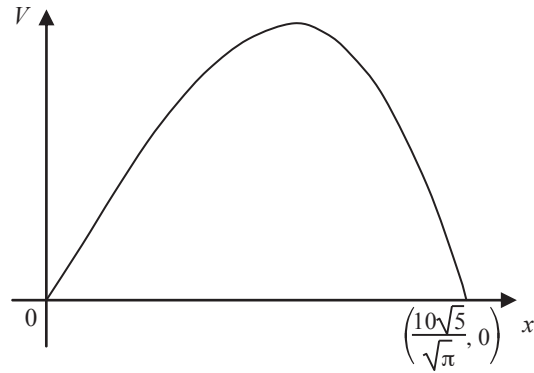

f When $x = \frac{10\sqrt{5}}{\sqrt{3\pi}}$ (from part d)

$$V = 5000 \times \frac{\sqrt{5}}{\sqrt{3\pi}} - \pi \times \left(\frac{5}{3\pi}\right)^{\frac{3}{2}} \times 1000$$

$$= \frac{\sqrt{5}}{\sqrt{3\pi}} \left(5000 - \frac{\pi \times 5000}{3\pi}\right)$$

$$= \frac{\sqrt{5}}{\sqrt{3\pi}} \times \frac{10\,000}{3}$$

$$= \frac{10\,000\sqrt{5}}{3\sqrt{3\pi}} \text{ cm}^3$$

The maximum volume is 2427.89 cm^3 , correct to 2 decimal places.

g On a CAS calculator, with $f1 = x(500 - \pi x^2)$ and $f2 = 1000$,

TI: Press **Menu** → **6:Analyze Graph** → **4:Intersection**

CP: Tap **Analysis** → **G-Solve** → **Intersect**

to find $x = 2.05$ and $x = 11.46$

Corresponding values of h are $h = 75.41$ and $h = 2.42$

32 a Let x (cm) be the radius, h (cm) be the height, S (cm²) be the surface area of the can.

$$\pi x^2 h = 500$$

$$\therefore h = \frac{500}{\pi x^2}$$

$$\begin{aligned} S &= 2\pi x h + 2\pi x^2 \\ &= 2\pi x \left(\frac{500}{\pi x^2} \right) + 2\pi x^2 \\ &= \frac{1000}{x} + 2\pi x^2 \\ &= 1000x^{-1} + 2\pi x^2 \end{aligned}$$

We know that $\frac{d}{dx}(x^n) = nx^{n-1}$ when $n = 1, 2, 3$

Now suppose this also true for $n = -1, -2, -3, \dots$

$$\text{So } \frac{d}{dx}(x^{-1}) = -x^{-2}$$

$$\begin{aligned} \text{Hence } \frac{dS}{dx} &= -1000x^{-2} + 4\pi x \\ &= \frac{-1000}{x^2} + 4\pi x \end{aligned}$$

$$\text{When } \frac{dS}{dx} = 0, \quad \frac{-1000}{x^2} + 4\pi x = 0$$

$$\therefore 4\pi x = \frac{1000}{x^2}$$

$$\therefore x^3 = \frac{1000}{4\pi}$$

$$\begin{aligned} \therefore x &= \frac{10}{(4\pi)^{\frac{1}{3}}} \\ &\approx 4.3 \end{aligned}$$

x	4	4.3	5
Sign of $\frac{dS}{dx}$	-	0	+
Shape	\	—	/

The surface area is a minimum when the radius is 4.3 cm,

$$\begin{aligned} \text{and } h &= \frac{500}{\pi x^2} \\ &= \frac{500}{\pi \left(\frac{10}{(4\pi)^{\frac{1}{3}}} \right)^2} \\ &= \frac{500}{\pi \left(\frac{100}{(4\pi)^{\frac{2}{3}}} \right)} \\ &= \frac{500 \times (4\pi)^{\frac{2}{3}}}{100\pi} \\ \therefore h &= \frac{5(4\pi)^{\frac{2}{3}}}{\pi} \\ &\approx 8.6 \end{aligned}$$

The minimum surface area occurs when the radius is approximately 4.3 cm and the height is approximately 8.6 cm.

- b** If the radius of the can must be no greater than 5 cm, the minimum surface area occurs when the radius is approximately 4.3 cm and the height is approximately 8.6 cm.

Chapter 19 – Revision of chapters 16–18

Solutions to Technology-free questions

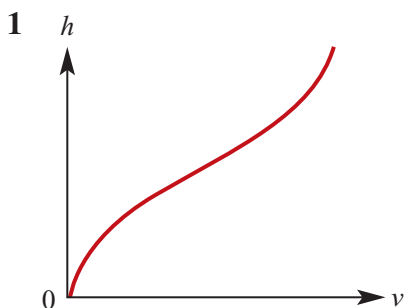

2 a $x(0) = 0$ and $x(1) = 1$
 Average velocity = $\frac{x(1) - x(0)}{1 - 0}$
 = 1 m/s

b $x(1) = 1$ and $x(4) = 124$
 Average velocity = $\frac{x(4) - x(1)}{4 - 1}$
 = 41 m/s

3 a i Average rate of change
 = $\frac{0 - 8}{3 - 1} = -4$

ii Average rate of change
 = $\frac{5 - 8}{2 - 1} = -3$

b Average rate of change
 = $\frac{(9 - (1 + h)^2) - (9 - 1)}{1 + h - 1}$
 = $\frac{9 - (1 + 2h + h^2) - 8}{h}$
 = $\frac{-2h - h^2}{h}$
 = $-2 - h$

c -2

4 $\frac{f(x+h) - f(x)}{x+h-x}$
 = $\frac{\frac{1}{2}(x+h)^2 - (x+h) - (\frac{1}{2}x^2 - x)}{h}$
 = $\frac{xh + \frac{1}{2}h^2 - h}{h}$
 = $x + \frac{1}{2}h - 1$
 $\therefore f'(x) = x - 1$

5 a Let $f(x) = 2x^3 - x + 1$
 $\therefore f'(x) = 6x^2 - 1$

b Let $f(x) = (x-1)(x-2) = x^2 + x - 2$
 $\therefore f'(x) = 2x + 1$

c Let $f(x) = \frac{x^2 + 5x}{x} = x + 5$
 $\therefore f'(x) = 1$

6 a Let $y = 3x^4 + x$

Then $\frac{dy}{dx} = 12x^3 + 1$

When $x = 1$, $\frac{dy}{dx} = 13$

Gradient = 13 at the point(1, 4)

b Let $y = 2x(1-x) = 2x - x^2$

Then $\frac{dy}{dx} = 2 - 2x$

When $x = -2$, $\frac{dy}{dx} = 10$

Gradient = 10 at the point(-2, -12)

7 a $f(x) = 0$

$x - 2x^2 = 0$

$x(1 - 2x) = 0 \Rightarrow x = 0$ or $x = \frac{1}{2}$

b $f'(x) = 0$

$$1 - 4x = 0$$

$$x = \frac{1}{4}$$

c $f'(x) > 0$

$$1 - 4x > 0$$

$$x < \frac{1}{4}$$

d $f'(x) < 0$

$$1 - 4x < 0$$

$$x > \frac{1}{4}$$

e $f'(x) = 10$

$$1 - 4x = 10$$

$$4x = 11 \quad x = \frac{11}{4}$$

8 a $\frac{d}{dx}(2x^{-3} - x^{-1}) = -6x^{-4} + x^{-2}$

b $\frac{d}{dz}\left(\frac{3-z}{z^3}\right) = \frac{d}{dz}(3z^{-3} - z^{-2}) =$
 $-9z^{-4} + 2z^{-3} = \frac{2z-9}{z^4}$

9 Let $y = x^2 - 5x$

$$\frac{dy}{dx} = 2x - 5$$

When $x = 1$, $\frac{dy}{dx} = -3$

When $x = 1$, $y = -4$

Therefore equation of tangent:

$$y + 4 = -3(x - 1)$$

$$y = -3x - 1.$$

Normal has gradient $\frac{1}{3}$

$$\text{Equation of Normal } y = \frac{1}{3}x - \frac{13}{3}$$

10 $x = \frac{1}{6}t^3 - \frac{1}{2}t^2$
 $v = \frac{dx}{dt} = \frac{1}{2}t^2 - t$
 $a = \frac{dv}{dt} = t - 1$

a $v = 0 \Rightarrow \frac{1}{2}t^2 - t = 0$
 $\Rightarrow t\left(\frac{1}{2}t - 1\right) = 0$
 $\Rightarrow t = 0$ and $t = 2$

b $t = 0, a = -1 \text{ cm/s}^2; t = 2,$
 $a = 1 \text{ cm/s}^2$

c $a = 0 \Rightarrow t = 1 \Rightarrow v = -\frac{1}{2} \text{ cm/s}$

11 $y = 2(x^3 - 4x) = 2x^3 - 8x \quad \frac{dy}{dx} = 6x^2 - 8$
 $\frac{dy}{dx} = 0$

$$\Rightarrow 3x^2 - 4 = 0$$

$$\Rightarrow x = \frac{2}{\sqrt{3}} \text{ or } x = -\frac{2}{\sqrt{3}}$$

When $x = \frac{2}{\sqrt{3}}, y = \frac{32}{3\sqrt{3}}$

When $x = -\frac{2}{\sqrt{3}}, y = \frac{32}{3\sqrt{3}}$

Local minimum $\left(\frac{2}{\sqrt{3}}, -\frac{32}{3\sqrt{3}}\right)$

Local maximum $\left(-\frac{2}{\sqrt{3}}, \frac{32}{3\sqrt{3}}\right)$

Leading coefficient of the cubic is positive.

Solutions to multiple-choice questions

- 1 B** $\frac{dh}{dV}$ decreases as bowl fills,
so gradient must be constantly
increasing.
- 2 A** Gradient $\approx \frac{0-60}{6-0} = -10$
- 3 B** Av. speed $= \frac{3-0}{3-0} = 1$ m/s
- 4 A** Av. rate $= \frac{f(2) - f(0)}{2-0}$
 $= \frac{13-1}{2}$
 $= 6$
- 5 B** Av. rate $= \frac{23.5-10}{12-7}$
 $= 2.7^\circ\text{C/h}$
- 6 A** $y = 5x^2 + 1 \therefore \frac{dy}{dx} = 10x$
- 7 D** $f(5+h) - f(5) = (5+h)^2 - 5^2$
 $= 10h + h^2$
- 8 B** Gradient = 0 at turning points
 $x = -1, 1.5$
- 9 C** $V = 3t^2 + 4t + 2, \therefore V' = 6t + 4$
 $\therefore V'(2) = 6(2) + 4$
 $= 16 \text{ m}^3/\text{min}$
- 10 A** $\frac{f(3+h) - f(3)}{h} = 2h^2 + 2h$
 $\therefore \lim_{h \rightarrow 0} 2h^2 + 2h = 0$
- 11 C** Curve increases for
 $x \in (-\infty, -2) \cup (1, \infty)$
- 12 B** $f(x) = x^3 - x^2 - 5$
 $\therefore f'(x) = 3x^2 - 2x$
 $= x(3x - 2)$
 $\therefore f' = 0, x = 0, \frac{2}{3}$
- 13 A** $f'(x) = \frac{0-3}{5-0} = -\frac{3}{5}$ for all x
- 14 C** $y = 2x^3 - 3x^2, \therefore y' = 6x^2 - 6x$
 $\therefore y'(1) = 6 - 6 = 0$
- 15 C** $y = 7 + 2x - x^2, \therefore y' = 2(1-x)$
Inverted parabola, so
 $y \text{ max.} = y(1) = 8$
- 16 A** $s = 28t - 16t^2, \therefore v = 28 - 32t$
 $s_{\text{max}} = s\frac{7}{8}$
 $= \frac{49}{2} - \frac{49}{4}$
 $= \frac{49}{4} \text{ m/s}$
- 17 D** $f'(x) > 0$ for $x < 1, f'(x) < 0$ for
 $x > 1$
 $f'(1) = 0$; only **D** fits.
- 18 E** $f'(-2) > 0, f'(-1) = 0, f'(0) < 0$
 $f(x)$ has a local max. at $x = -1$.
- 19 C** $y = \frac{x^2}{2}(x^2 + 2x - 4)$
 $= \frac{x^4}{2} + x^3 - 2x^2$
 $\therefore \frac{dy}{dx} = 2x^3 + 3x^2 - 4x$
- 20 B** $\frac{d}{dx}(5 + 3x^2) = 6x$
- 21 E** Negative slope for $x < -1, x > 1$

$$\begin{aligned} 22 \text{ D } \text{ Rise/run} &= \frac{(1+h)^2 - 1}{1+h-1} \\ &= 2+h \end{aligned}$$

$$\begin{aligned} 23 \text{ A } y &= x^2(2x-3) = 2x^3 - 3x^2 \\ y' &= 6x^2 - 6x < \therefore y'(1) = 0 \end{aligned}$$

$$24 \text{ A } \text{ Rise/run} = \frac{b^2 - a^2}{b - a} = b + a$$

$$\begin{aligned} 25 \text{ C } f(x) &= 3x^3 + 6x^2 - x + 1 \\ \therefore f'(x) &= 9x^2 + 12x - 1 \end{aligned}$$

$$\begin{aligned} 26 \text{ D } y + 3x &= 10, \therefore y = 10 - 3x \\ A &= 4x(10 - 3x) \\ \therefore A' &= 40 - 24x = 0 \\ \therefore 5 - 3x &= 0 \end{aligned}$$

$$\begin{aligned} 27 \text{ B } y &= x^2 + 3, \therefore y' = 2x \\ \therefore y'(3) &= 6 \end{aligned}$$

$$\begin{aligned} 28 \text{ B } y &= x^3 + 5x^2 - 8x \\ \therefore y' &= 3x^2 + 10x - 8 \\ &= (3x - 2)(x + 4) \end{aligned}$$

x	-5	-4	0	$\frac{2}{3}$	1
y'	+	0	-	0	+

$x = -4$ is a local maximum.

$x = \frac{2}{3}$ is a local minimum.

$$29 \text{ B } f'(1) = \lim_{h \rightarrow 0} \frac{f(1+h) - f(1)}{h}$$

$$\begin{aligned} 30 \text{ C } y &= x^2 + 4x - 3 \\ \therefore y' &= 2(x+2) \\ y \text{ min} &= y(-2) = -7 \end{aligned}$$

$$\begin{aligned} 31 \text{ D } y &= x^2, \therefore y' = 2x \\ y'(2) &= 4 \\ \therefore \text{gradient of normal} &= -\frac{1}{4} \end{aligned}$$

$$\begin{aligned} 32 \text{ E } y &= \frac{2x+5}{x} = 2 + 5x^{-1} \\ \therefore \frac{dy}{dx} &= -5x^{-2} = -\frac{5}{x^2} \end{aligned}$$

$$\begin{aligned} 33 \text{ A } y &= x^2 - 3x - 4, \therefore y' = 2x - 3 \\ y' < 0, \therefore x &< \frac{3}{2} \end{aligned}$$

$$34 \text{ A } \lim_{x \rightarrow 0} \frac{x^2 - x}{x} = x - 1 = -1$$

35 C Graph is discontinuous at $x = 0, 2$ since in both cases the positive and negative limits are different.

36 C Graph is discontinuous at $x = -1, 1$ since in both cases the positive and negative limits are different.

37 D

38 D

39 D

Solutions to extended-response questions

1 a When the particle returns to ground level, $y = 0$

$$\therefore x - 0.01x^2 = 0$$

$$\therefore x(1 - 0.01x) = 0$$

$$\therefore x = 0 \quad \text{or} \quad 1 - 0.01x = 0$$

$$0.01x = 1$$

$$x = 100$$

The particle travels 100 units horizontally before returning to ground level.

b $y = x - 0.01x^2$

$$\therefore \frac{dy}{dx} = 1 - 0.02x$$

c $\frac{dy}{dx} = 0$

$$\therefore 1 - 0.02x = 0$$

$$\therefore 0.02x = 1$$

$$\therefore x = 50$$

When $x = 50$,

$$\begin{aligned} y &= 50 - 0.01(50)^2 \\ &= 50 - 0.01 \times 2500 \\ &= 50 - 25 \\ &= 25 \end{aligned}$$

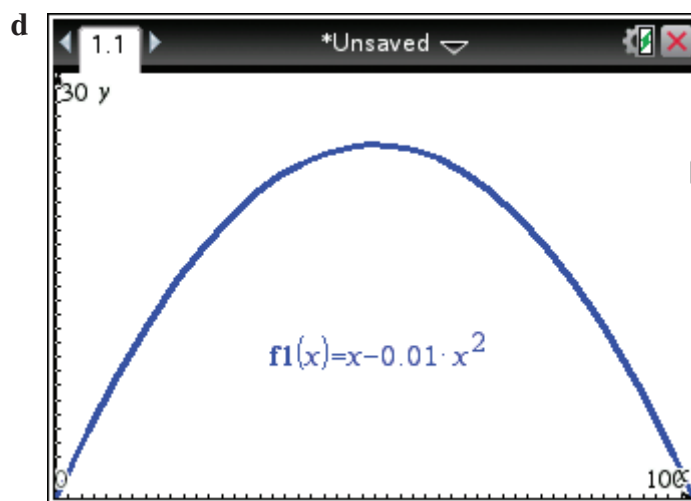

e i When $\frac{dy}{dx} = \frac{1}{2}$, $1 - 0.02x = \frac{1}{2}$

$\therefore 0.02x = \frac{1}{2}$

$\therefore x = 25$

When $x = 25$, $y = 25 - 0.01(25)^2$
 $= 25 - 0.01 \times 625$
 $= 25 - 6.25$
 $= 18.75$

i.e. the coordinates of the point with gradient $\frac{1}{2}$ are (25, 18.75).

ii When $\frac{dy}{dx} = -\frac{1}{2}$, $1 - 0.02x = -\frac{1}{2}$

$\therefore 0.02x = 1.5$

$\therefore x = 75$

When $x = 75$, $y = 75 - 0.01(75)^2$
 $= 75 - 0.01 \times 5625$
 $= 75 - 56.25$
 $= 18.75$

i.e. the coordinates of the point with gradient $-\frac{1}{2}$ are (75, 18.75).

2 a $y = -0.0001(x^3 - 100x^2)$
 $= -0.0001x^3 + 0.01x^2$

Highest point is reached where $\frac{dy}{dx} = 0$

$$\frac{dy}{dx} = -0.0003x^2 + 0.02x$$

When $\frac{dy}{dx} = 0$, $-0.0003x^2 + 0.02x = 0$

$\therefore x(0.02 - 0.0003x) = 0$

$\therefore x = 0$ or $0.02 - 0.0003x = 0$

$\therefore 0.0003x = 0.02$

$\therefore x = \frac{200}{3}$

$= 66\frac{2}{3}$

When $x = 0$, $y = 0$

When $x = 66\frac{2}{3}$,

$$\begin{aligned}y &= -0.0001x^2(x - 100) \\&= -0.0001\left(\frac{200}{3}\right)^2\left(\frac{200}{3} - 100\right) \\&= -0.0001 \times \frac{40\,000}{9}\left(-\frac{100}{3}\right) \\&= -\frac{4}{9} \times -\frac{100}{3} \\&= \frac{400}{27} \\&= 14\frac{22}{27}\end{aligned}$$

i.e. the coordinates of the highest point are $\left(66\frac{2}{3}, 14\frac{22}{27}\right)$.

b i At $x = 20$,

$$\begin{aligned}\frac{dy}{dx} &= x(0.02 - 0.0003x) \\&= 20(0.02 - 0.0003 \times 20) \\&= 20(0.02 - 0.006) \\&= 20 \times 0.014 \\&= 0.28\end{aligned}$$

i.e. at $x = 20$, the gradient of the curve is 0.28.

ii At $x = 80$,

$$\begin{aligned}\frac{dy}{dx} &= x(0.02 - 0.0003x) \\&= 80(0.02 - 0.0003 \times 80) \\&= 80(0.02 - 0.024) \\&= 80 \times -0.004 \\&= -0.32\end{aligned}$$

i.e. at $x = 80$, the gradient of the curve is -0.32 .

iii At $x = 100$,

$$\begin{aligned}\frac{dy}{dx} &= x(0.02 - 0.0003x) \\&= 100(0.02 - 0.0003 \times 100) \\&= 100(0.02 - 0.03) \\&= 100 \times -0.01 \\&= -1\end{aligned}$$

i.e. at $x = 100$, the gradient of the curve is -1 .

c The rollercoaster begins with a gentle upwards slope until it reaches the turning point (its highest point). On its downward trip the rollercoaster has a steeper slope and by the end of the ride it has reached a very steep downward slope.

d It would be less dangerous if the steep slope at the end were smoothed out.

3 a Let h = height of the block.

$$\text{Now } 4(3x + x + h) = 20$$

$$\therefore 4(4x + h) = 20$$

$$\therefore 4x + h = 5$$

$$\therefore h = 5 - 4x$$

i.e. the height of the block is $(5 - 4x)$ cm.

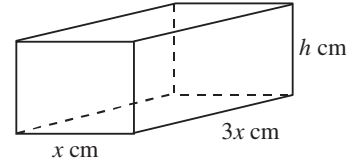

b $V = x \times 3x \times (5 - 4x)$

$$= 3x^2(5 - 4x)$$

$$= 15x^2 - 12x^3 \text{ as required}$$

c $x > 0$ and $V > 0$

$$\therefore 15x^2 - 12x^3 > 0$$

$$\iff 3x^2(5 - 4x) > 0$$

$$\iff 5 - 4x > 0 \text{ as } 3x^2 > 0 \text{ for all } x$$

$$\iff 5 > 4x$$

$$\iff \frac{5}{4} > x$$

$$\text{Domain is } \left\{ x: 0 < x < \frac{5}{4} \right\}$$

d $\frac{dV}{dx} = 30x - 36x^2$

e When $\frac{dV}{dx} = 0,$

$$30x - 36x^2 = 0$$

$$\therefore 6x(5 - 6x) = 0$$

$$\therefore 6x = 0 \quad \text{or} \quad 5 - 6x = 0$$

$$\therefore x = 0 \quad \text{or} \quad x = \frac{5}{6}$$

$$\therefore x = \frac{5}{6} \text{ as } x > 0$$

$$\begin{aligned} \text{When } x = \frac{5}{6}, \quad V &= 3\left(\frac{5}{6}\right)^2\left(5 - 4 \times \frac{5}{6}\right) \\ &= 3 \times \frac{25}{36}\left(5 - \frac{10}{3}\right) = \frac{25}{12} \times \frac{5}{3} \\ &= \frac{125}{36} = 3\frac{17}{36} \end{aligned}$$

$$\frac{dV}{dx} = 6x(5 - 6x)$$

$$\text{If } x < \frac{5}{6}, \text{ e.g. } x = \frac{1}{6}, \frac{dV}{dx} > 0.$$

$$\text{If } x > \frac{5}{6}, \text{ e.g. } x = 1, \frac{dV}{dx} < 0.$$

$$\therefore \text{ local maximum at } \left(\frac{5}{6}, \frac{125}{36}\right).$$

i.e. the maximum volume possible is $3\frac{17}{36} \text{ cm}^3$, for $x = \frac{5}{6}$.

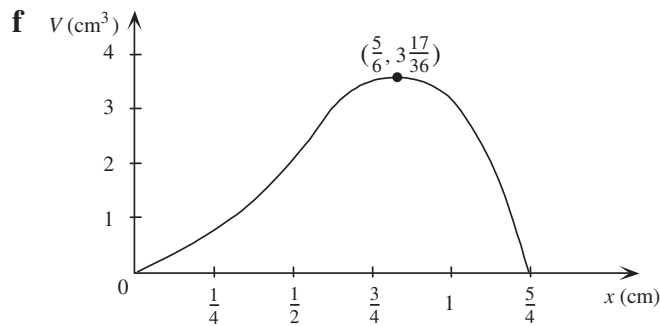

4 a $h = 30t - 5t^2$

$$\frac{dh}{dt} = 30 - 10t$$

b Maximum height is reached where $\frac{dh}{dt} = 0$

$$\therefore 30 - 10t = 0$$

$$\therefore 10t = 30 \quad \therefore t = 3$$

(a maximum, as it is a quadratic with negative coefficient of t^2)

$$\text{When } t = 3, \quad h = 30(3) - 5(3)^2$$

$$= 90 - 5 \times 9$$

$$= 90 - 45 = 45$$

i.e. maximum height reached is 45 m after 3 seconds.

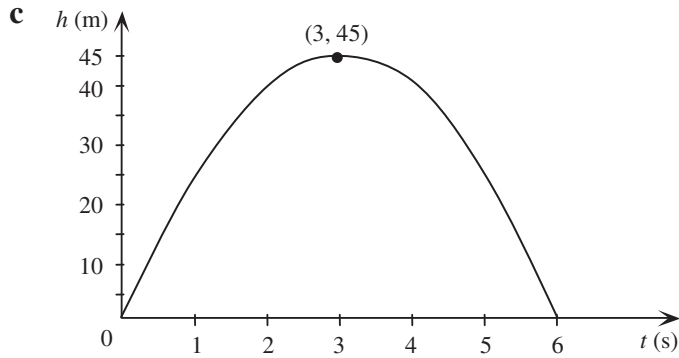

5 a Let A = surface area of the net

$$\begin{aligned} A &= 4x(1 - 2x) + 2x^2 \\ &= 4x - 8x^2 + 2x^2 \\ &= 4x - 6x^2 \end{aligned}$$

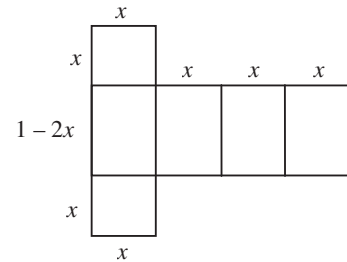

b

$$\begin{aligned} V &= x \times x \times (1 - 2x) \\ &= x^2(1 - 2x) \\ &= x^2 - 2x^3 \end{aligned}$$

c $x > 0$ and $V > 0$

$$\therefore x^2 - 2x^3 > 0$$

$$\iff x^2(1 - 2x) > 0$$

$$\iff 1 - 2x > 0$$

(as $x^2 > 0$ for all x)

$$\therefore x < \frac{1}{2}$$

$$\text{Domain } \left\{ x: 0 < x < \frac{1}{2} \right\}$$

When $x = 0$, $V = 0$

When $x = \frac{1}{2}$, $V = 0$

$$\frac{dV}{dx} = 2x - 6x^2$$

$$\text{When } \frac{dV}{dx} = 0, \quad 2x - 6x^2 = 0$$

$$\therefore 2x(1 - 3x) = 0$$

$$\therefore x = 0 \text{ or } x = \frac{1}{3}$$

$$\text{When } x = \frac{1}{3}, \quad V = \left(\frac{1}{3}\right)^2 - 2\left(\frac{1}{3}\right)^3 = \frac{1}{9} - \frac{2}{27} = \frac{1}{27}$$

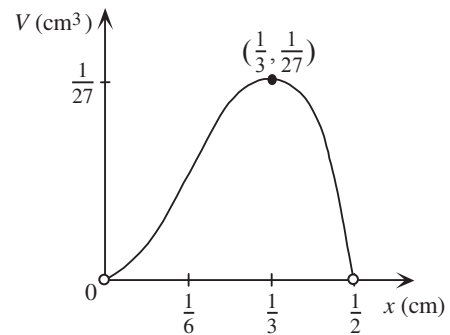

If $x < \frac{1}{3}$, e.g. $x = \frac{1}{6}$, $\frac{dV}{dx} > 0$.

If $x > \frac{1}{3}$, e.g. $x = \frac{1}{2}$, $\frac{dV}{dx} < 0$.

\therefore a local maximum at $\left(\frac{1}{3}, \frac{1}{27}\right)$

d A box with dimensions $\frac{1}{3}$ cm \times $\frac{1}{3}$ cm \times $\frac{1}{3}$ cm will give a maximum volume of $\frac{1}{27}$ cm³.

6 a i Using Pythagoras' theorem:

$$x^2 + r^2 = 1^2$$

$$\therefore r^2 = 1 - x^2$$

$$\therefore r = \sqrt{1 - x^2}$$

ii $h = 1 + x$

b $V = \frac{1}{3}\pi r^2 h$

$$= \frac{1}{3}\pi(1 - x^2)(1 + x)$$

$$= \frac{\pi}{3}(1 + x - x^2 - x^3) \text{ as required}$$

c $x > 0$ and $V > 0$

For $V > 0$, $\frac{\pi}{3}(1 - x^2)(1 + x) > 0$

$$\iff 1 - x^2 > 0 \text{ as } 1 + x > 0 \text{ for all } x > 0$$

$$\iff -1 < x < 1$$

$$\therefore V > 0 \text{ for } -1 < x < 1$$

To satisfy $x > 0$ and $V > 0$, domain is $\{x: 0 < x < 1\}$.

d i $\frac{dV}{dx} = \frac{\pi}{3}(1 - 2x - 3x^2)$

ii When $\frac{dV}{dx} = 0$, $\frac{\pi}{3}(1 - 2x - 3x^2) = 0$

$$\therefore \frac{-\pi}{3}(3x^2 + 2x - 1) = 0$$

$$\therefore \frac{-\pi}{3}(3x - 1)(x + 1) = 0$$

$$\therefore 3x - 1 = 0 \quad \text{or} \quad x + 1 = 0$$

$$\therefore 3x = 1 \quad \quad \quad x = -1$$

$$\therefore x = \frac{1}{3}$$

$$\therefore x = \frac{1}{3}, \text{ as } x > 0$$

$$\text{i.e. } \left\{ x: \frac{dV}{dx} = 0 \right\} = \left\{ x: x = \frac{1}{3} \right\}$$

$$\begin{aligned} \text{iii When } x = \frac{1}{3}, \quad V &= \frac{\pi}{3} \left(1 - \left(\frac{1}{3} \right)^2 \right) \left(1 + \frac{1}{3} \right) \\ &= \frac{\pi}{3} \left(1 - \frac{1}{9} \right) \left(\frac{4}{3} \right) \\ &= \frac{\pi}{3} \times \frac{8}{9} \times \frac{4}{3} \\ &= \frac{32\pi}{81} \\ &\approx 1.24 \end{aligned}$$

$$\text{If } x < \frac{1}{3}, \text{ e.g. } x = \frac{1}{6}, \frac{dV}{dx} > 0.$$

$$\text{If } x > \frac{1}{3}, \text{ e.g. } x = \frac{2}{3}, \frac{dV}{dx} < 0.$$

$$\therefore \text{local maximum at } \left(\frac{1}{3}, \frac{32\pi}{81} \right).$$

i.e. the maximum volume of the cone is $\frac{32\pi}{81} \text{ m}^3$ or approximately 1.24 m^3 .

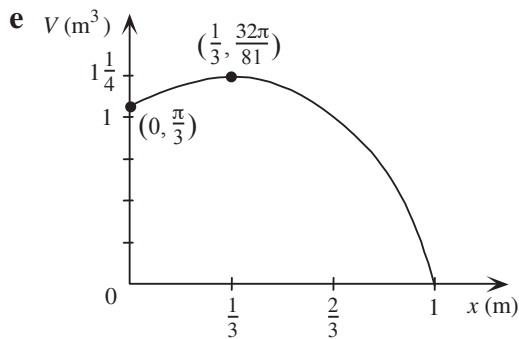

$$\begin{aligned} \text{7 a When } t = 0, \quad P(0) &= 1000 \times 2^{\frac{0}{20}} \\ &= 1000 \end{aligned}$$

On 1 January 1993, there were 1000 insects in the colony.

b When $t = 9$,
$$P(9) = 1000 \times 2^{\frac{9}{20}}$$

$$= 1000 \times 2^{0.45}$$

$$\approx 1366$$

On 10 January, there were approximately 1366 insects in the colony.

c i When $P(t) = 4000$,
$$1000 \times 2^{\frac{t}{20}} = 4000$$

$$\therefore 2^{\frac{t}{20}} = 4$$

$$\therefore 2^{\frac{t}{20}} = 2^2$$

$$\therefore \frac{t}{20} = 2$$

$$\therefore t = 40$$

ii When $P(t) = 6000$,
$$1000 \times 2^{\frac{t}{20}} = 6000$$

$$\therefore 2^{\frac{t}{20}} = 6$$

$$\therefore \log_{10} 2^{\frac{t}{20}} = \log_{10} 6$$

$$\therefore \frac{t}{20} = \frac{\log_{10} 6}{\log_{10} 2}$$

$$\therefore t = \frac{20 \log_{10} 6}{\log_{10} 2}$$

$$\approx 51.70$$

d
$$P(20) = 1000 \times 2^{\frac{20}{20}}$$

$$= 1000 \times 2$$

$$= 2000$$

$$P(15) = 1000 \times 2^{\frac{15}{20}}$$

$$\approx 1000 \times 1.681792831$$

$$\approx 1681.792831$$

Average rate of change of P with respect to time, for the interval of time

$$[15, 20] = \frac{P(20) - P(15)}{20 - 15}$$

$$\approx \frac{2000 - 1681.792831}{5}$$

$$\approx \frac{318.2071695}{5} \approx 63.64$$

$$\begin{aligned}
\text{e i Average rate of change} &= \frac{P(15+h) - P(15)}{15+h-15} \\
&= \frac{1000 \times 2^{\frac{15+h}{20}} - 1000 \times 2^{\frac{15}{20}}}{h} \\
&= \frac{1000 \times 2^{\frac{3}{4}} \times 2^{\frac{h}{20}} - 1000 \times 2^{\frac{3}{4}}}{h} \\
&= \frac{1000 \times 2^{\frac{3}{4}} \left(2^{\frac{h}{20}} - 1 \right)}{h}, h \neq 0
\end{aligned}$$

ii Consider h decreasing and approaching zero:

$$\begin{aligned}
\text{Let } h &= 0.0001 \\
\text{Average rate of change} &\approx \frac{1681.792831(2^{0.000005} - 1)}{0.0001} \\
&\approx 58.28656686
\end{aligned}$$

$$\begin{aligned}
\text{Let } h &= 0.00001 \\
\text{Average rate of change} &\approx \frac{1681.792831(2^{0.0000005} - 1)}{0.00001} \\
&\approx 58.28589414
\end{aligned}$$

$$\begin{aligned}
\text{Let } h &= 0.000001 \\
\text{Average rate of change} &\approx \frac{1681.792831(2^{0.00000005} - 1)}{0.000001} \\
&\approx 58.28656686
\end{aligned}$$

Hence as $h \rightarrow 0$, the instantaneous rate of change is approaching 58.287 insects per day.

8 a Let A (m^2) be the total surface area of the block.

Now $A = 300$

and $A = 2(2xh + 2x^2 + xh)$
 $= 2(2x^2 + 3xh)$

$$\therefore 2(2x^2 + 3xh) = 300$$

$$\therefore 2x^2 + 3xh = 150$$

$$\therefore 3xh = 150 - 2x^2$$

$$\therefore h = \frac{150 - 2x^2}{3x}$$

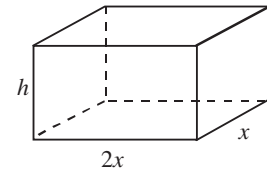

b $V = h \times 2x \times x$

$$= \frac{150 - 2x^2}{3x} \times 2x^2$$

$$= \frac{2}{3}x(150 - 2x^2)$$

c $V = 100x - \frac{4}{3}x^3$

$$\therefore \frac{dV}{dx} = 100 - 4x^2$$

d When $V = 0$, $\frac{2}{3}x(150 - 2x^2) = 0$

$$\therefore \frac{2}{3}x = 0 \quad \text{or} \quad 150 - 2x^2 = 0$$

$$\therefore x = 0 \quad \text{or} \quad 2x^2 = 150$$

$$\therefore x^2 = 75$$

$$\therefore x = \pm 5\sqrt{3}$$

When $x = 1$, $V = \frac{2}{3} \times 1(150 - 2(1)^2)$

$$= \frac{2}{3}(148) = \frac{296}{3} > 0$$

$$\therefore V > 0 \text{ for } 0 < x < 5\sqrt{3}$$

Note also, for $x > 0$

$$\frac{2}{3}x(150 - 2x^2) > 0$$

$$\iff 150 - 2x^2 > 0$$

$$\iff 75 > x^2$$

$$\iff 5\sqrt{3} > x$$

e Maximum value of V occurs when $\frac{dV}{dx} = 0$

$$\therefore 100 - 4x^2 = 0$$

$$\therefore 4x^2 = 100$$

$$\therefore x^2 = 25$$

$$\therefore x = \pm\sqrt{25}$$

$$x = 5 \text{ as } x > 0$$

When $x = 5$,

$$V = \frac{2}{3} \times 5(150 - 2(5)^2)$$

$$= \frac{10}{3}(150 - 50)$$

$$= \frac{1000}{3} = 333\frac{1}{3}$$

When $x < 5$, e.g. $x = 4$, $\frac{dV}{dx} > 0$ and when $x > 5$, e.g. $x = 6$, $\frac{dV}{dx} < 0$
 \therefore a local maximum at $\left(5, \frac{1000}{3}\right)$.

i.e. when $x = 5$ m, the block has its maximum volume of $\frac{1000}{3}$ m³ or $333\frac{1}{3}$ m³.

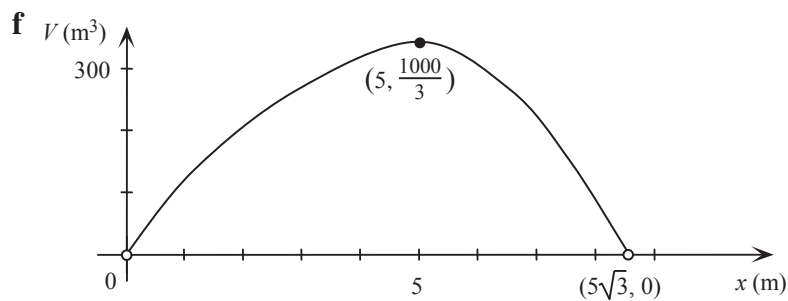

9 a

$$12x + y + y + 6.5x + 6.5x = 70$$

$$\therefore 25x + 2y = 70$$

If $x = 2$,

$$25(2) + 2y = 70$$

$$\therefore 50 + 2y = 70$$

$$\therefore y = 10$$

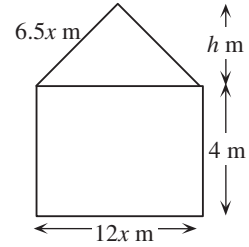

b

$$25x + 2y = 70$$

$$2y = 70 - 25x$$

$$\therefore y = \frac{70 - 25x}{2} \text{ as required}$$

c i Using Pythagoras' theorem:

$$h^2 + (6x)^2 = (6.5x)^2$$

$$\therefore h^2 + 36x^2 = 42.25x^2$$

$$\therefore h^2 = 6.25x^2$$

$$\therefore h = \sqrt{6.25x^2}$$

$$= 2.5x \text{ as } x > 0$$

ii Let A (m) be the area of the front face of the building.

$$A = \text{area of rectangle} + \text{area of triangle}$$

$$= 12x \times y + \frac{1}{2} \times 12x \times 2.5x$$

$$= 12xy + 15x^2$$

$$= 15x^2 + 12xy \text{ as required}$$

d Let V (cm^3) be the volume of the building.

$$V = A \times 40$$

$$= 40(15x^2 + 12xy)$$

$$= 40\left(15x^2 + 12x\left(\frac{70 - 25x}{2}\right)\right)$$

$$= 40(15x^2 + 6x(70 - 25x))$$

$$= 40(15x^2 + 420x - 150x^2)$$

$$= 600x(28 - 9x)$$

e i

$$V = 600(28x - 9x^2)$$

Volume is a maximum when $\frac{dV}{dx} = 0$

$$\therefore \frac{dV}{dx} = 600(28 - 18x)$$

$$\therefore 600(28 - 18x) = 0$$

$$\therefore 28 - 18x = 0$$

$$\therefore 18x = 28$$

$$\therefore x = \frac{28}{18} = \frac{14}{9}$$

$$\begin{aligned} \text{When } x = \frac{14}{9}, \quad y &= \frac{70 - 25\left(\frac{14}{9}\right)}{2} \\ &= \frac{70 - \frac{350}{9}}{2} \\ &= \frac{630 - 350}{18} \\ &= \frac{280}{18} = \frac{140}{9} \end{aligned}$$

When $x < \frac{14}{9}$, e.g. $x = 1$, $\frac{dV}{dx} > 0$.

When $x > \frac{14}{9}$, e.g. $x = 2$, $\frac{dV}{dx} < 0$.

\therefore a local maximum at $\left(\frac{14}{9}, \frac{140}{9}\right)$.

i.e. the volume is a maximum when $x = \frac{14}{9}$ and $y = \frac{140}{9}$.

$$\begin{aligned} \text{ii When } x = \frac{14}{9}, \quad V &= 40\left(420\left(\frac{14}{9}\right) - 135\left(\frac{14}{9}\right)^2\right) \\ &= 13\,066\frac{2}{3} \text{ m}^3 \end{aligned}$$

i.e. the maximum volume of the building is $13\,066\frac{2}{3}\text{m}^3$.

10 a $y = kx^2(a - x)$

At (200, 0) $0 = k \times 200^2(a - 200)$

\therefore either $k = 0$ or $a = 200$

At (170, 8.67) $8.67 = k \times 170^2(a - 170)$ (1)

$\therefore k \neq 0 \quad \therefore a = 200$ (2)

Substitute (2) into (1) $8.67 = k \times 170^2(200 - 170)$

$\therefore 8.67 = 28\,900k \times 30$

$\therefore k = \frac{8.67}{28\,900 \times 30}$
 $= 0.000\,01$

$\therefore y = 0.000\,01x^2(200 - x)$

b i $y = 0.000\,01x^2(200 - x)$

$\therefore = 0.002x^2 - 0.000\,01x^3$

At the local maximum, $\frac{dy}{dx} = 0$

and $\frac{dy}{dx} = 0.004x - 0.000\,03x^2$

$\therefore 0.004x - 0.000\,03x^2 = 0$

$\therefore 0.001x(4 - 0.03x) = 0$

$\therefore x = 0$ or $4 - 0.03x = 0$

$\therefore 0.03x = 4$

$\therefore x = \frac{400}{3}$

If $x < \frac{400}{3}$, e.g. $x = 100$, $\frac{dy}{dx} > 0$.

If $x > \frac{400}{3}$, e.g. $x = 150$, $\frac{dy}{dx} < 0$.

Therefore a local maximum when $x = \frac{400}{3}$.

ii When $x = \frac{400}{3}$, $y = 0.000\,01\left(\frac{400}{3}\right)^2\left(200 - \frac{400}{3}\right)$
 $= \frac{16}{90} \times \frac{200}{3}$
 $= \frac{320}{27}$

c i When $x = 105$, $y = 0.000\ 01(105)^2(200 - 105)$

$$\begin{aligned}
 &= \frac{1}{100\ 000} \times 11\ 025 \times 95 \\
 &= \frac{104\ 737\ 5}{100\ 000} \\
 &= \frac{8379}{800} \\
 &= 10\frac{379}{800} \quad (= 10.473\ 75)
 \end{aligned}$$

ii When $x = 105$, $\frac{dy}{dx} = 0.001(105)(4 - 0.03 \times 105)$

$$\begin{aligned}
 &= \frac{105}{1000}(4 - 3.15) \\
 &= \frac{105}{1000} \times \frac{85}{100} \\
 &= \frac{8925}{100\ 000} = \frac{357}{4000}
 \end{aligned}$$

d i $y - y_1 = m(x - x_1)$

$$\therefore y = \frac{357}{4000}(x - 105) + \frac{8379}{800}$$

$$\therefore y = \frac{357}{4000}x - \frac{37485}{4000} + \frac{41895}{4000}$$

$$\therefore y = \frac{357}{4000}x + \frac{441}{400}$$

i.e. the equation of the tangent at $x = 105$ is $y = \frac{357}{4000}x + \frac{441}{400}$.

ii The y-axis intercept of the tangent is $\frac{441}{400}$.

e Average rate of change = $\frac{\frac{8379}{800} - 0}{105 - 0}$

$$\begin{aligned}
 &= \frac{8379}{800 \times 105} \\
 &= 0.099\ 75
 \end{aligned}$$

f $y = 0.000\ 01x^2(200 - x)$

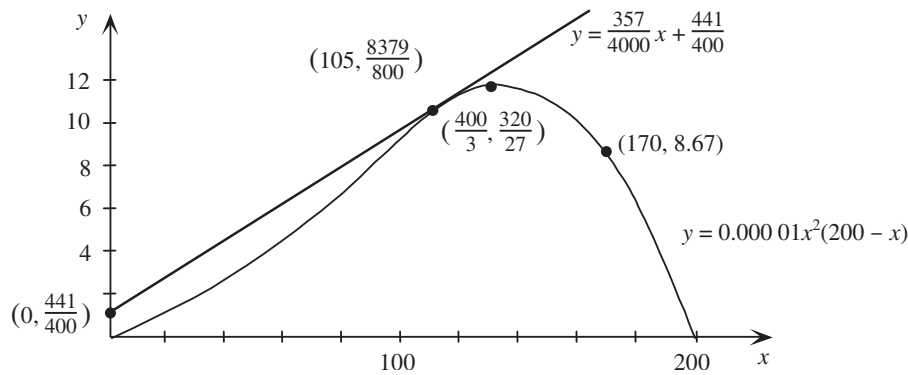

11 a In the centre of the city $r = 0$

and

$$P = 10 + 40(0) - 20(0)^2$$

$$= 10$$

i.e. the population density is 10 000 people per square kilometre.

b $P > 0$

$$\therefore 10 + 40r - 20r^2 > 0$$

$$\therefore -10(2r^2 - 4r - 1) > 0$$

When $P = 0$, $2r^2 - 4r - 1 = 0$

$$\therefore r = \frac{4 \pm \sqrt{4^2 - 4(2)(-1)}}{2 \times 2}$$

$$= \frac{4 \pm \sqrt{16 + 8}}{4}$$

$$= \frac{4 \pm 2\sqrt{6}}{4}$$

$$= \frac{2 \pm \sqrt{6}}{2}$$

and, as $r \geq 0$

$$r = \frac{2 + \sqrt{6}}{2}$$

When $r = 1$,

$$P = 10 + 40(1) - 20(1)^2$$

$$= 10 + 40 - 20$$

$$= 30 > 0$$

$$\therefore P > 0 \text{ for } 0 \leq r \leq \frac{2 + \sqrt{6}}{2}$$

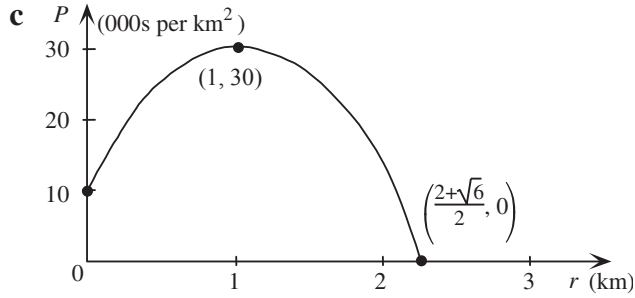

d i $\frac{dP}{dr} = 40 - 40r$

ii When $r = 0.5$, $\frac{dP}{dr} = 40 - 40(0.5)$
 $= 40 - 20$
 $= 20$

When $r = 1$, $\frac{dP}{dr} = 40 - 40(1)$
 $= 40 - 40$
 $= 0$

When $r = 2$, $\frac{dP}{dr} = 40 - 40(2)$
 $= 40 - 80$
 $= -40$

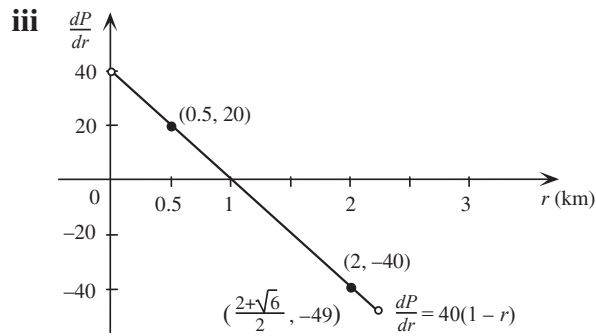

e The population density is greatest at a 1 km radius from the city centre.

12 a $y = x(a - x)$
 $= ax - x^2$

b $0 < x < a$

c Maximum value of y is found where $\frac{dy}{dx} = 0$.

$$\frac{dy}{dx} = a - 2x$$

$$\therefore a - 2x = 0$$

$$\therefore 2x = a$$

$$\therefore x = \frac{a}{2}$$

$$\begin{aligned} \text{When } x = \frac{a}{2}, \quad y &= \frac{a}{2}\left(a - \frac{a}{2}\right) \\ &= \frac{a}{2} \times \frac{a}{2} = \frac{1}{4}a^2 \end{aligned}$$

So the maximum value of y is $\frac{1}{4}a^2$ when $x = \frac{a}{2}$.

d $y = \frac{1}{4}a^2$ is a maximum because the coefficient of the x^2 term is negative.

e i When $a = 9$, $y = x(9 - x)$

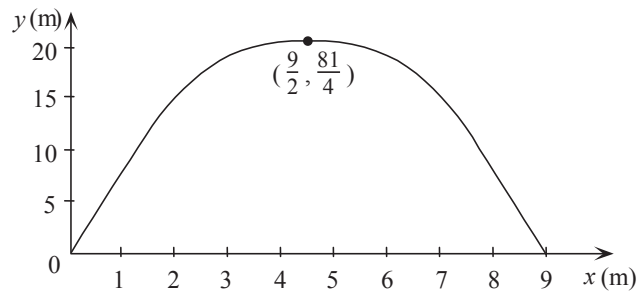

ii $0 < y \leq \frac{81}{4}$

13 a $V(t) = 0.6\left(20t^2 - \frac{2t^3}{3}\right)$

$$\begin{aligned} \text{i When } t = 0, \quad V(0) &= 0.6\left(20(0)^2 - \frac{2(0)^3}{3}\right) \\ &= 0.6(0 - 0) \\ &= 0 \end{aligned}$$

ii When $t = 20$,

$$\begin{aligned}
 V(20) &= 0.6\left(20(20)^2 - \frac{2(20)^3}{3}\right) \\
 &= 0.6\left(8000 - \frac{16000}{3}\right) \\
 &= 0.6 \times \frac{8000}{3} \\
 &= 1600
 \end{aligned}$$

b $V'(t) = 0.6(40t - 2t^2) = 1.2t(20 - t)$

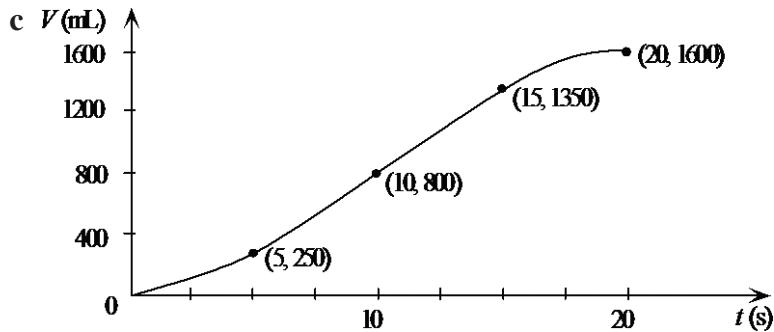

When $V'(t) = 0$, $1.2t(20 - t) = 0$

$\therefore t = 0$ or $20 - t = 0$

$$t = 20$$

When $t = 10$,

$$\begin{aligned}
 V &= 0.6\left(20 \times 10^2 - \frac{2 \times 10^3}{3}\right) \\
 &= 0.6\left(2000 - \frac{2000}{3}\right) \\
 &= 800
 \end{aligned}$$

When $t = 5$,

$$\begin{aligned}
 V &= 0.6\left(20 \times 5^2 - \frac{2 \times 5^3}{3}\right) \\
 &= 0.6\left(500 - \frac{250}{3}\right) \\
 &= 250
 \end{aligned}$$

When $t = 15$,

$$\begin{aligned}
 V &= 0.6\left(20 \times 15^2 - \frac{2 \times 15^3}{3}\right) \\
 &= 0.6\left(4500 - \frac{6750}{3}\right) \\
 &= 1350
 \end{aligned}$$

d
$$V'(t) = 1.2t(20 - t), t \in [0, 20]$$

$$= 24t - 1.2t^2$$

When $t = 0$, $V'(0) = 0$

When $t = 20$,
$$V'(20) = 24 \times 20 - 1.2(20)^2$$

$$= 480 - 480$$

$$= 0$$

When $t = 10$,
$$V'(10) = 24 \times 10 - 1.2(10)^2$$

$$= 240 - 120$$

$$= 120$$

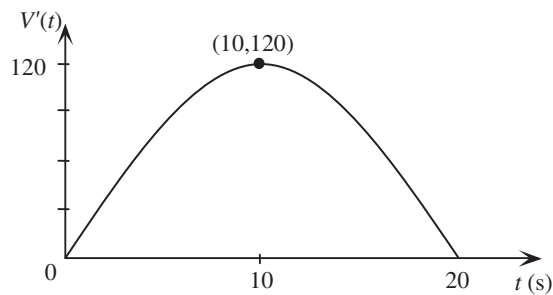

14 a $y = ax^3 + bx^2$

At (1, -1),
$$-1 = a(1)^3 + b(1)^2$$

$$\therefore a + b + 1 = 0 \quad (1)$$

b
$$\frac{dy}{dx} = 3ax^2 + 2bx$$

At (1, -1),
$$\frac{dy}{dx} = 0$$

$$\therefore 3a(1)^2 + 2b(1) = 0$$

$$\therefore 3a + 2b = 0 \quad (2)$$

$$(2) - 2 \times (1) \quad \begin{array}{r} 3a + 2b = 0 \\ -2a + 2b + 2 = 0 \\ \hline a - 2 = 0 \end{array}$$

$$\therefore a = 2$$

Substitute $a = 2$ into (1) $2 + b + 1 = 0$

$$\therefore b = -3$$

$$\therefore y = 2x^3 - 3x^2$$

c x -axis intercept when $y = 0$

$$\therefore 2x^3 - 3x^2 = 0$$

$$\therefore x^2(2x - 3) = 0$$

$$\therefore x = 0 \quad \text{or} \quad x = \frac{3}{2}$$

$$\frac{dy}{dx} = 6x^2 - 6x$$

$$= 6x(x - 1)$$

Stationary points where $\frac{dy}{dx} = 0$

$$\therefore 6x(x - 1) = 0$$

$$\therefore 6x = 0 \quad \text{or} \quad x - 1 = 0$$

$$\therefore x = 0 \quad \text{or} \quad x = 1$$

At $x = 0$, $y = 0$

At $x = 1$, $y = -1$

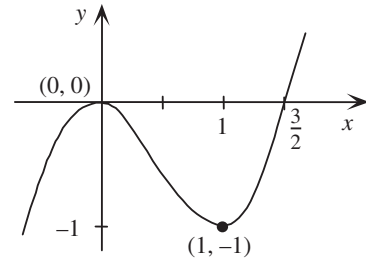

	$x < 0$	0	$0 < x < 1$	1	$x > 1$
Sign of $\frac{dy}{dx}$	+	0	-	0	+
Shape	/	—	\	—	/

\therefore there is a local minimum at $(1, -1)$ and a local maximum at $(0, 0)$.

15 a i $AD + AB + CB = 80$

$$\therefore x + AB + x = 80$$

$$\therefore AB = 80 - 2x$$

ii $\sin 60^\circ = \frac{h}{x}$

$$\therefore h = x \sin 60^\circ$$

$$h = \frac{\sqrt{3}x}{2}$$

b Let area of trapezoid = A

$$\begin{aligned}\therefore A &= \text{area of rectangle} + 2(\text{area of triangle}) \\ &= \frac{\sqrt{3}}{2}x(80 - 2x) + 2\left(\frac{1}{2} \times \frac{\sqrt{3}}{2}x \times x \sin 30^\circ\right) \\ &= \frac{80\sqrt{3}}{2}x - \sqrt{3}x^2 + \frac{\sqrt{3}}{2}x \times \frac{x}{2} \\ &= \frac{80\sqrt{3}}{2}x - \sqrt{3}x^2 + \frac{\sqrt{3}}{4}x^2 \\ &= \frac{80\sqrt{3}}{2}x - \frac{3\sqrt{3}}{4}x^2 \\ &= \frac{\sqrt{3}}{4}x(160 - 3x)\end{aligned}$$

(Formula for the area of a trapezium may also be used.)

c

$$\begin{aligned}A &= \frac{\sqrt{3}}{4}x(160 - 3x) \\ &= 40\sqrt{3}x - \frac{3\sqrt{3}}{4}x^2 \\ \frac{dA}{dx} &= 40\sqrt{3} - \frac{3\sqrt{3}}{4}x\end{aligned}$$

$$\text{When } \frac{dA}{dx} = 0, \quad 40\sqrt{3} - \frac{3\sqrt{3}}{2}x = 0$$

$$\therefore \frac{3\sqrt{3}}{2}x = 40\sqrt{3}$$

$$\therefore x = \frac{40\sqrt{3} \times 2}{3\sqrt{3}} = \frac{80}{3}$$

The area is a maximum for $x = \frac{80}{3}$, as $A = \frac{\sqrt{3}}{4}x(160 - 3x)$ is a quadratic function with negative coefficient of x^2 .

16 a Total amount of cardboard = $x^2 + 4xy + x^2 + 8x$

$$\therefore 2x^2 + 4xy + 8x = 1400$$

$$\therefore y = \frac{1400 - 2x^2 - 8x}{4x}$$

b $V = x^2y$

$$\begin{aligned}&= x^2\left(\frac{1400 - 2x^2 - 8x}{4x}\right) \\ &= \frac{-x^3}{2} - 2x^2 + 350x\end{aligned}$$

c

$$V = \frac{-x^3}{2} - 2x^2 + 350x$$

$$\frac{dV}{dx} = \frac{-3}{2}x^2 - 4x + 350$$

d $\frac{dV}{dx} = 0$ implies

$$\frac{-3}{2}x^2 - 4x + 350 = 0$$

$$\therefore 3x^2 + 8x - 700 = 0$$

$$\therefore x = \frac{-8 \pm \sqrt{64 + 8400}}{6} = \frac{-8 \pm 92}{6}$$

$$\therefore x = 14, \text{ as } x \text{ is positive.}$$

e,f When $x = 14$, $V = 3136$

Maximum volume is 3136 cm^3 .

From part b,

$$V = x^2 \left(\frac{1400 - 2x^2 - 8x}{4x} \right)$$

$$= \frac{x}{4}(1400 - 2x^2 - 8x)$$

defined if $x > 0$ and $V > 0$

i.e. $-2x^2 - 8x + 1400 > 0$

$$x^2 + 4x - 700 > 0$$

Consider $x = \frac{-4 \pm \sqrt{16 + 2800}}{2} = -2 \pm \sqrt{704} = -2 \pm 8\sqrt{11}$

V is defined for $0 < x < -2 + 8\sqrt{11}$.

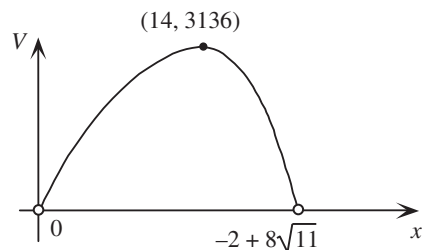

g On a CAS calculator, with $f1 = x/4(1400 - 2x^2 - 8x)$ and $f2=1000$, choose

TI: Press Menu \rightarrow 6:Analyze Graph \rightarrow 4:Intersection

CP: Tap Analysis \rightarrow G-Solve \rightarrow Intersect

From the CAS calculator, when $V = 1000$,

$$x = 22.827\dots \quad \text{or} \quad x = 2.943\dots$$

$$\therefore y = 1.919\dots \quad \text{or} \quad y = 115.452\dots$$

Chapter 20 – Further differentiation and antidifferentiation

Solutions to Exercise 20A

$$1 \text{ a } \frac{d}{dx}(x-1)^{30} = 30(x-1)^{29}$$

$$b \frac{d}{dx}(x^5 - x^{10})^{20} \\ = 100(x^4 - 2x^9)(x^5 - x^{10})^{19}$$

$$c \frac{d}{dx}(x - x^3 - x^5)^4 = \\ 4(1 - 3x^2 - 5x^4)((x - x^3 - x^5)^3)$$

$$d \frac{d}{dx}(x^2 + 2x + 1)^4 = \frac{d}{dx}(x + 1)^8 \\ = 8(x + 1)^7$$

$$e \frac{d}{dx}(x^2 + 2x)^{-2}; x \neq -2, 0 \\ = -4(x + 1)(x^2 + 2x)^{-3}$$

$$f \frac{d}{dx}\left(x^2 - \frac{2}{x}\right)^{-3}; x \neq 0 \\ = -6(x + x^{-2})(x^2 - 2x^{-1})^{-4}$$

$$2 \text{ a } f(x) = (2x^3 + 1)^4 \\ \therefore f'(x) = 4(2x^3 + 1)^3(6x^2) \\ = 24x^2(2x^3 + 1)^3$$

$$b f'(1) = 24(3)^3 = 648$$

$$3 \text{ a } y = \frac{1}{x+3}, \therefore y' = -1(x+3)^{-2} \\ \therefore y'(1) = -\frac{1}{(1+3)^2} = -\frac{1}{16}$$

$$b y = \frac{1}{(x+3)^3}, \therefore y' = -\frac{3}{(x+3)^4} \\ \therefore y'(1) = -\frac{3}{(1+3)^4} = -\frac{3}{256}$$

$$4 f(x) = \frac{1}{2x+3}, \therefore f'(x) = -\frac{2}{(2x+3)^2}$$

$$a f'(0) = -\frac{2}{9}$$

$$b f'(x) = -\frac{2}{(2x+3)^2} = -\frac{2}{9}$$

$$\therefore (2x+3)^2 = 9$$

$$2x+3 = \pm 3$$

$$2x = -6, 0$$

$$x = -3, 0$$

$$f(-3) = -\frac{1}{3}; f(0) = \frac{1}{3}$$

Coordinates are $\left(-3, -\frac{1}{3}\right), \left(0, \frac{1}{3}\right)$.

$$5 \text{ a } y = \frac{1}{x}, \therefore y' = -\frac{1}{x^2} \\ \therefore y'(2) = -\frac{1}{4}$$

$$b y = -\frac{1}{x}, \therefore y' = \frac{1}{x^2} \\ \therefore y'(2) = \frac{1}{4}$$

$$c y'(1) = -1, y - 1 = -(x - 1) \\ y = 2 - x$$

$$d y'(1) = 1, \therefore y + 1 = x - 1 \\ y = x - 2$$

e P: $y - 1 = x + 1, \therefore y = x + 2$
Q: $y + 1 = -(x + 1), \therefore y = -x - 2$
They intersect at $(-2, 0)$

f

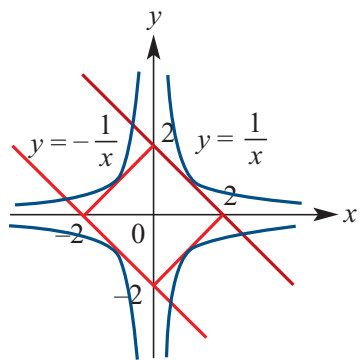

Solutions to Exercise 20B

1 a $\frac{d}{dx}(x^{\frac{1}{3}}) = \frac{1}{3}x^{-\frac{2}{3}}$

b $\frac{d}{dx}x^{\frac{3}{2}} = \frac{3}{2}x^{\frac{1}{2}}; x > 0$

c $\frac{d}{dx}(x^{\frac{5}{2}} - x^{\frac{3}{2}}) = \frac{5}{2}x^{\frac{3}{2}} - \frac{3}{2}x^{\frac{1}{2}} > 0$

d $\frac{d}{dx}(2x^{\frac{1}{2}} - 3x^{\frac{5}{3}}) = x^{-\frac{1}{2}} - 5x^{\frac{2}{3}}; x = 0$

e $\frac{d}{dx}x^{-\frac{5}{6}} = -\frac{5}{6}x^{-\frac{11}{6}}; x > 0$

f $\frac{d}{dx}(x^{-\frac{1}{2}} - 4) = -\frac{1}{2}x^{-\frac{3}{2}}; x > 0$

2 a $\frac{d}{dx}\sqrt{1+x^2} = x(1+x^2)^{-\frac{1}{2}}$

b $\frac{d}{dx}(x+x^2)^{\frac{1}{3}} = \frac{1}{3}(1+2x)(x+x^2)^{-\frac{2}{3}}$

c $\frac{d}{dx}(1+x^2)^{-\frac{1}{2}} = 2x\left(-\frac{1}{2}\right)(1+x^2)^{-\frac{3}{2}}$
 $= -x(1+x^2)^{-\frac{3}{2}}$

d $\frac{d}{dx}(1+x)^{\frac{1}{3}} = \frac{1}{3}(1+x)^{-\frac{2}{3}}$

3 $y = x^{\frac{1}{3}}, \therefore y' = \frac{1}{3}x^{-\frac{2}{3}}$

a i $y'\left(\frac{1}{8}\right) = \frac{1}{3}\left(\frac{1}{8}\right)^{-\frac{2}{3}} = \frac{1}{3}(8)^{\frac{2}{3}} = \frac{4}{3}$

ii $y'\left(-\frac{1}{8}\right) = \frac{1}{3}\left(-\frac{1}{8}\right)^{-\frac{2}{3}} =$
 $\frac{1}{3}(-8)^{\frac{2}{3}} = \frac{4}{3}$

iii $y'(1) = \frac{1}{3}(1)^{-\frac{2}{3}} = \frac{1}{3}(1)^{\frac{2}{3}} = \frac{1}{3}$

iv $y'(-1) = \frac{1}{3}(-1)^{-\frac{2}{3}} = \frac{1}{3}(-1)^{\frac{2}{3}} = \frac{1}{3}$

b Graph has rotational symmetry around (0, 0).

4

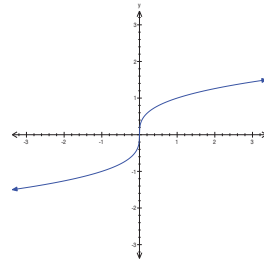

a $x^{\frac{1}{2}} < x^{\frac{1}{3}}$
 $\therefore (x^{\frac{1}{2}})^6 < (x^{\frac{1}{3}})^6; x > 0$
 $x^3 < x^2$

$$x^3 - x^2 < 0$$

$$x^2(x-1) < 0$$

$$x^2 > 0, \therefore x-1 < 0$$

$$x < 1$$

$$\{x : 0 < x < 1\}$$

b $\frac{d}{dx}x^{\frac{1}{2}} = \frac{1}{2}x^{-\frac{1}{2}} \quad \frac{d}{dx}x^{\frac{1}{3}} = \frac{1}{3}x^{-\frac{2}{3}}$

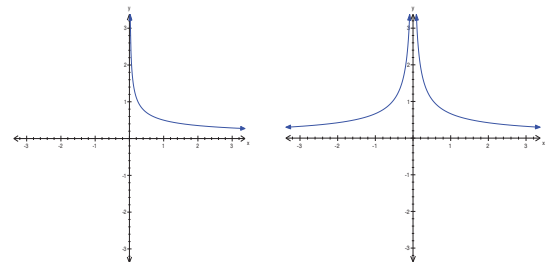

As in a:

$$\left(\frac{1}{2}x^{-\frac{1}{2}}\right)^6 > \left(\frac{1}{3}x^{-\frac{2}{3}}\right)^6; x > 0$$

$$\therefore x > \left(\frac{2}{3}\right)^6$$

$$\{x: x > \frac{64}{729}\}$$

5 a

$$\begin{aligned}\frac{d}{dx}(2 - 5\sqrt{x})^2 &= 2\left(-\frac{5}{2}x^{-\frac{1}{2}}\right)(2 - 5\sqrt{x}) \\ &= -5x^{-\frac{1}{2}}(2 - 5\sqrt{x})\end{aligned}$$

$$\begin{aligned}\mathbf{b} \quad \frac{d}{dx}(3\sqrt{x} + 2)^2 &= 2\left(\frac{3}{2}x^{-\frac{1}{2}}\right)(3\sqrt{x} + 2) \\ &= 3x^{-\frac{1}{2}}(3\sqrt{x} + 2)\end{aligned}$$

$$\begin{aligned}\mathbf{c} \quad \frac{d}{dx}\left(\frac{2 + \sqrt{x}}{x^2}\right) &= \frac{d}{dx}(2x^{-2} + x^{-\frac{3}{2}}) \\ &= -4x^{-3} - \frac{3}{2}x^{-\frac{5}{2}}\end{aligned}$$

$$\begin{aligned}\mathbf{d} \quad \frac{d}{dx}\left(\frac{x^2 + 2}{\sqrt{x}}\right) &= \frac{d}{dx}\left(x^{\frac{3}{2}} + 2x^{-\frac{1}{2}}\right) \\ &= \frac{3}{2}x^{\frac{1}{2}} - x^{-\frac{3}{2}}\end{aligned}$$

$$\begin{aligned}\mathbf{e} \quad \frac{d}{dx}(3\sqrt{x})(x^2 + 2) &= \frac{d}{dx}\left(3x^{\frac{5}{2}} + 6x^{\frac{1}{2}}\right) \\ &= \frac{15}{2}x^{\frac{3}{2}} + 3x^{-\frac{1}{2}}\end{aligned}$$

Solutions to Exercise 20C

$$1 \text{ a } \int 3x^{-2} dx = -\frac{3}{x} + c$$

$$b \int 2x^{-4} + 6x dx = -\frac{2}{3}x^{-3} + 3x^2 + c$$

$$c \int \sqrt{x}(2+x) dx = \int 2x^{\frac{1}{2}} + x^{\frac{3}{2}} dx \\ = \frac{4}{3}x^{\frac{3}{2}} + \frac{2}{5}x^{\frac{5}{2}} + c$$

$$d \int 3x^{\frac{1}{3}} - 5x^{\frac{5}{4}} dx = \frac{9}{4}x^{\frac{4}{3}} - \frac{20}{9}x^{\frac{9}{4}} + c$$

$$e \int \frac{3z^4 + 2z}{z^3} dz = \int 3z + 2z^{-2} dz \\ = \frac{3}{2}z^2 - \frac{2}{z} + c$$

$$f \int 3x^{\frac{3}{4}} - 7x^{\frac{1}{2}} dx = \frac{12}{7}x^{\frac{7}{4}} - \frac{14}{3}x^{\frac{3}{2}} + c$$

$$2 \text{ a } \frac{dy}{dx} = x^{\frac{1}{2}} + x$$

$$\therefore y = \frac{2}{3}x^{\frac{3}{2}} + \frac{1}{2}x^2 + c$$

$$y(4) = \frac{2}{3}(8) + \frac{16}{2} + c = 6$$

$$\therefore c = 6 - 8 - \frac{16}{3} = -\frac{22}{3}$$

$$\therefore y = \frac{2}{3}x^{\frac{3}{2}} + \frac{1}{2}x^2 - \frac{22}{3}$$

$$b \frac{dy}{dx} = \frac{1}{x^3}, \therefore y = -\frac{1}{2x^2} + c$$

$$y(1) = c - \frac{1}{2} = 1, \therefore c = \frac{3}{2}$$

$$\therefore y = \frac{3}{2} - \frac{1}{2x^2}$$

$$c \frac{dy}{dx} = 3x + \frac{1}{x^2}, \therefore y = \frac{3}{2}x^2 - \frac{1}{x} + c$$

$$y(1) = \frac{3}{2} - 1 + c = 5, \therefore c = \frac{9}{2}$$

$$\therefore y = \frac{3}{2}x^2 - \frac{1}{x} + \frac{9}{2}$$

3

$$f'(x) = 3x^2 - \frac{1}{x^2}, \therefore f(x) = x^3 + \frac{1}{x} + c$$

$$f(2) = 8 + \frac{1}{2} + c = 0, \therefore c = -\frac{17}{2}$$

$$\therefore f(x) = x^3 + \frac{1}{x} - \frac{17}{2}$$

$$4 \frac{ds}{dt} = 3t - \frac{8}{t^2}, \therefore s = \frac{3}{2}t^2 + \frac{8}{t} + c$$

$$s(1) = \frac{3}{2} + 8 + c = \frac{3}{2}, \therefore c = -8$$

$$\therefore s = \frac{3}{2}t^2 + \frac{8}{t} - 8$$

$$5 \frac{dy}{dx} = \frac{a}{x^2} + 1, \therefore y = x - \frac{a}{x} + c$$

$$y'(1) = a + 1 = 3, \therefore a = 2$$

$$y(1) = -1 + c = 3, \therefore c = 4$$

$$\therefore y = x - \frac{2}{x} + 4$$

$$y(2) = 2 - 1 + 4 = 5$$

$$6 \frac{dy}{dx} = ax, \therefore y = \frac{a}{2}x^2 + c$$

a

$$\text{Tangent at } (1, 2): y - 2 = a(x - 1)$$

$$\therefore y = ax + (2 - a)$$

Tangent passes through (0, 0),

$$\therefore a = 2$$

b $y = x^2 + c$
 $y(1) = 2, \therefore c = 1$
 $\therefore y = x^2 + 1$

7 $\frac{dy}{dx} = x^2, \therefore y = \frac{1}{3}x^3 + c$
 $y(-1) = -\frac{1}{3} + c = 2, \therefore c = \frac{7}{3}$
 $\therefore y = \frac{x^3 + 7}{3}$

Solutions to Exercise 20D

1 a $f(x) = x^3 + 2x + 1$

$$\therefore f'(x) = 3x^2 + 2$$

$$\therefore f''(x) = 6x$$

b $f(x) = 3x + 2$

$$\therefore f'(x) = 3$$

$$\therefore f''(x) = 0$$

c $f(x) = (3x + 1)^4$

$$\therefore f'(x) = 12(3x + 1)^3$$

$$\therefore f''(x) = 108(3x + 1)^2$$

d $f(x) = x^{\frac{1}{2}} + 3x^3; x > 0$

$$\therefore f'(x) = \frac{1}{2}x^{-\frac{1}{2}} + 9x^2; x > 0$$

$$\therefore f''(x) = -\frac{1}{4}x^{-\frac{3}{2}} + 18x; x > 0$$

e $f(x) = (x^6 + 1)^3$

$$\begin{aligned}\therefore f'(x) &= 18x^5(x^6 + 1)^2 \\ &= 18x^{17} + 36x^{11} + 18x^5\end{aligned}$$

$$\therefore f''(x) = 306x^{16} + 396x^{10} + 90x^4$$

f $f(x) = 5x^2 + 6x^{-1} + 3x^{\frac{3}{2}}$

$$\therefore f'(x) = 10x - 6x^{-2} + 9x^{\frac{1}{2}}$$

$$\therefore f''(x) = 10 + 12x^{-3} + \frac{9}{4}x^{-\frac{1}{2}}$$

2 a $y = 3x^3 + 4x + 1$

$$\therefore \frac{dx}{dy} = 9x^2 + 4$$

$$\frac{d^2y}{dx^2} = 18x$$

b $y = 6$

$$\therefore \frac{dy}{dx} = \frac{d^2y}{dx^2} = 0$$

c $y = 6x^2 + 3x + 1$

$$\therefore \frac{dy}{dx} = 12x + 3$$

$$\frac{d^2y}{dx^2} = 12$$

d $y = (6x + 1)^4$

$$\therefore \frac{dy}{dx} = 24(6x + 1)^3$$

$$\therefore \frac{d^2y}{dx^2} = 432(6x + 1)^2$$

e $y = (5x + 2)^4$

$$\therefore \frac{dy}{dx} = 20(5x + 2)^3$$

$$\therefore \frac{d^2y}{dx^2} = 300(5x + 2)^2$$

f $y = x^3 + 2x^2 + 3x^{-1}$

$$\therefore \frac{dy}{dx} = 3x^2 + 4x - 3x^{-2}$$

$$\therefore \frac{d^2y}{dx^2} = 6x + 4 + 6x^{-3}$$

3 $h = 20t - 4.9 t^2$ m

$$\therefore v = 20 - 9.8 t$$
 m/s

$$\therefore a = -9.8$$
 m/s²

4 $x(t) = 4t - 3t^3$ m

$$\therefore v(t) = 4 - 9t^2$$
 m/s

$$\therefore a(t) = -18t$$
 m/s²

a i $x(2) = 8 - 24 = -16 \text{ m}$

ii $v(0) = 4 \text{ m/s}$

iii $v(0.5) = 4 - \frac{9}{4} = \frac{7}{4} \text{ m/s}$

iv $v(2) = 4 - 36 = -32 \text{ m/s}$

b $a(t) = 0, \therefore t = 0$

c
$$\begin{aligned} \text{Av. } v &= \frac{x(2) - x(0)}{2 - 0} \\ &= \frac{-16 - 0}{2} = -8 \text{ m/s} \end{aligned}$$

Solutions to Exercise 20E

1 $y = 4x + \frac{1}{x}, \therefore y' = 4 - \frac{1}{x^2}$

a $y' = 0, \therefore 4x^2 = 1$

$$x = \pm \frac{1}{2}$$

$$y\left(-\frac{1}{2}\right) = -4; y\left(\frac{1}{2}\right) = 4$$

Turning pts at $\left(-\frac{1}{2}, -4\right)$ and $\left(\frac{1}{2}, 4\right)$.

b $y'(2) = 4 - \frac{1}{4} = \frac{15}{4}$

$$y(2) = 8 + \frac{1}{2} = \frac{17}{2}$$

Tangent equation:

$$y - \frac{17}{2} = \frac{15}{4}(x - 2)$$

$$\therefore y = \frac{15}{4}x + 1 \text{ OR } 4y - 15x = 1$$

2 $y = \frac{x^2 - 1}{x} = x - \frac{1}{x}$

$$\therefore y' = 1 + \frac{1}{x^2} = 5$$

$$\therefore x^2 = \frac{1}{4}$$

$$x = \pm \frac{1}{2}$$

3 $y = \frac{2x - 4}{x^2} = 2x^{-1} - 4x^{-2}$

$$\therefore y' = -2x^{-2} + 8x^{-3}$$

$$y = 0, \therefore 2x^{-1} = 4x^{-2}; x \neq 0$$

$$2x = 4; \therefore x = 2$$

$$\therefore y'(2) = -\frac{2}{2^2} + \frac{8}{2^3} = \frac{1}{2}$$

4 $y = x - 5 + \frac{4}{x} = \frac{(x-1)(x-4)}{x}$

a Axis intercepts at $(1, 0), (4, 0)$.

b Vertical asymptote at $x = 0$

Oblique asymptote at $y = x - 5$

c $y'(x) = 1 - \frac{4}{x^2} = 0, x = \pm 2$

$$y(-2) = -9; y(2) = -1$$

Turning pts at $(-2, -9), (2, -1)$

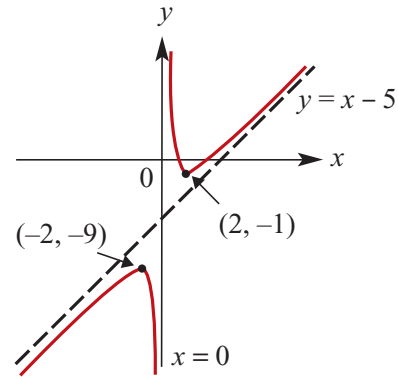

5 $y = x + \frac{4}{x^2}; x > 0$

$$\therefore y' = 1 - \frac{8}{x^3}; y > 0$$

$$y'(1) < 0; y'(2) = 0; y'(3) > 0$$

local and absolute minimum at $x = 2$:

$$y(2) = 2 + 1 = 3$$

6 $y = x + \frac{4}{x}; x > 0$

$$= \frac{x^2 + 4}{x}; x > 0$$

$x^2 + 4 > 0; x \in \mathbb{R}, \therefore$ no axis intercepts

Asymptotes at $x = 0$ and $y = x$

$$y' = 1 - \frac{4}{x^2} = 0; x > 0$$

$$x^2 = 4, \therefore x = 2$$

$y(2) = 4$; Local and absolute minimum is 4.

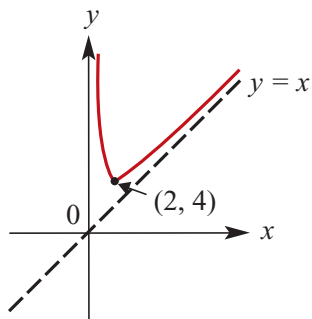

7 a $y = x + \frac{1}{x}; x \neq 0 = \frac{x^2 + 1}{x}; x \neq 0$
 $x^2 + 1 > 0; x \in R, \therefore$ no axis intercepts

Asymptotes at $x = 0$ and $y = x$

$$y' = 1 - \frac{1}{x^2} = 0; x \neq 0$$

$$x^2 = 1, x = \pm 1$$

$$y(-1) = -2; y(1) = 2$$

x	-2	-1	-0.5	0	0.5	1	2
y'	+	0	-	N	-	0	+

Local maximum $(-1, -2)$,

local minimum $(1, 2)$.

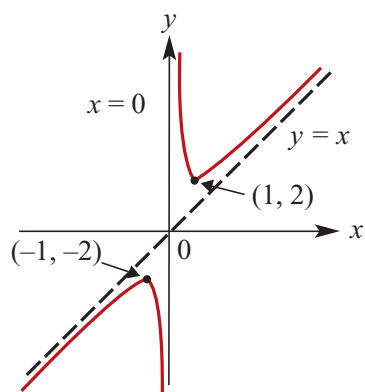

b $y = \frac{1}{x^2} - x; x \neq 0$

$$= \frac{1 - x^3}{x^2}; x \neq 0$$

Axis intercept at $(1, 0)$.

Asymptotes at $x = 0$ and $y = -x$

$$y' = -1 - \frac{2}{x^3} = 0; x \neq 0$$

$$x^3 = -2, \therefore x = -2^{\frac{1}{3}}$$

Local minimum $\left(-2^{\frac{1}{3}}, \left(\frac{3}{4}\right)^{\frac{1}{3}}\right) \approx$
 $(-1.26, 1.89)$

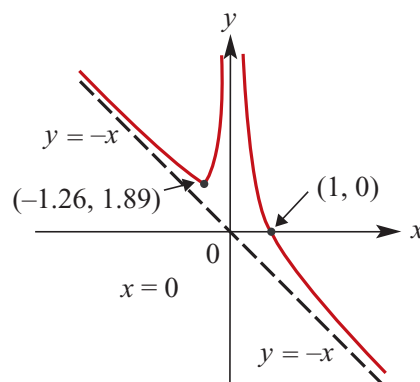

c $y = x + 1 + \frac{1}{x+3}; x \neq -3$
 $= \frac{(x+1)(x+3) + 1}{x+3}; x \neq -3$
 $= \frac{(x+2)^2}{x+3}; x \neq -3$

Axis intercepts at $(0, \frac{4}{3})$ and $(-2, 0)$.

Asymptotes at $x = -3$ and $y = x + 1$

$$y' = 1 - \frac{1}{(x+3)^2} = 0; x \neq -3$$

$$(x+3)^3 = 1$$

$$x^2 + 6x + 8 = 0$$

$$(x+4)(x+2) = 0, \therefore x = -4, 2$$

x	-5	-4	-3.5	-3	-2.5	-2	0
y'	+	0	-	N	-	0	+

Local minimum $(-2, 0)$, maximum
 $(-4, -4)$.

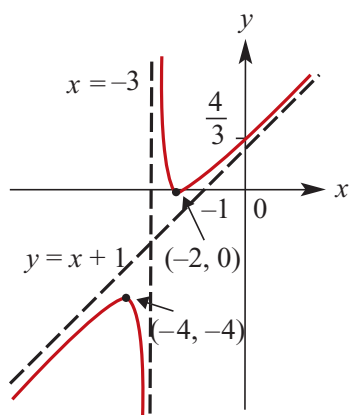

d $y = x^3 + \frac{243}{x}; x \neq 0$
 $= \frac{x^4 + 243}{x}; x \neq 0$
 No axis intercept: $x^4 + 243 > 0; x \in R$
 Asymptotes at $x = 0$.

$$y' = 3x^2 - \frac{243}{x^2} = 0; x \neq 0$$

$$3x^4 = 243, \therefore x = \pm 3$$

x	-4	-3	-1	0	1	3	4
y'	+	0	-	N	-	0	+

Local maximum $(-3, -108)$,
 minimum $(3, 108)$.

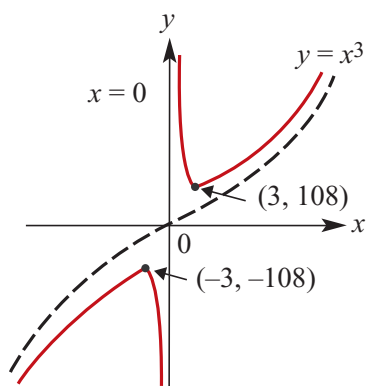

e $y = x - 5 + \frac{1}{x}; x \neq 0$
 $= \frac{x^2 - 5x + 1}{x}; x \neq 0$

$$y = 0, \therefore x = \frac{1}{2}(5 \pm \sqrt{21})$$

Axis intercepts: $(0.21, 0), (4.79, 0)$.

Asymptotes at $x = 0$ and $y = x - 5$

$$y' = 1 - \frac{1}{x^2} = 0; x \neq 0$$

$$x^2 = 1, \therefore x = \pm 1$$

x	-2	-1	-0.5	0	0.5	1	2
y'	+	0	-	N	-	0	+

Local maximum $(-1, -7)$, minimum
 $(1, -3)$.

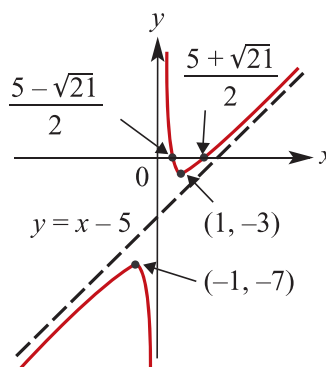

f $y = \frac{x^2 - 4}{x + 2}; x \neq -2$
 $= \frac{(x + 2)(x - 2)}{x + 2}; x \neq -2$
 $= x - 2; x \neq -2$

$$= x - 2; x \neq -2$$

Axis intercepts at $(2, 0)$ and $(0, -2)$.

No asymptotes, no turning points.

The graph is a straight line with equation $y = x - 2$ with a hole at $(-2, -4)$.

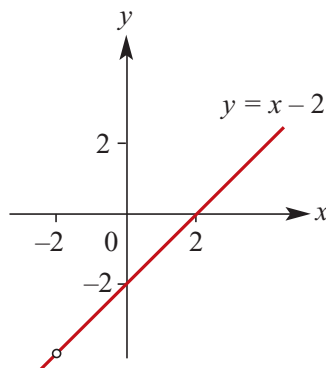

Solutions to Technology-free questions

$$1 \text{ a } \frac{d}{dx}x^{\frac{1}{2}} = \frac{1}{2}x^{-\frac{1}{2}} = \frac{1}{2x^{\frac{1}{2}}}$$

$$b \frac{d}{dx}x^{\frac{1}{3}} = \frac{1}{3}x^{-\frac{2}{3}} = \frac{1}{3x^{\frac{2}{3}}}$$

$$c \frac{d}{dx} - 2x^{-\frac{1}{3}} = \frac{2}{3}x^{-\frac{4}{3}} = \frac{2}{3x^{\frac{4}{3}}}$$

$$d \frac{d}{dx}x^{\frac{4}{3}} = \frac{4}{3}x^{\frac{1}{3}}$$

$$e \frac{d}{dx}x^{-\frac{1}{3}} = -\frac{1}{3}x^{-\frac{4}{3}} = -\frac{1}{3x^{\frac{4}{3}}}$$

$$f \frac{d}{dx}x^{-\frac{1}{3}} + 2x^{\frac{3}{5}} = -\frac{1}{3}x^{-\frac{4}{3}} + \frac{6}{5}x^{-\frac{2}{5}}$$

$$= -\frac{1}{3x^{\frac{4}{3}}} + \frac{6}{5x^{\frac{2}{5}}}$$

$$2 \text{ a } \frac{d}{dx}(2x+3)^2 = 4(2x+3) = 8x+12$$

$$b \frac{d}{dx}2(3x+4)^4 = 24(3x+4)^3$$

$$c \frac{d}{dx}(3-2x)^{-\frac{1}{2}} = (3-2x)^{-\frac{3}{2}}$$

$$= \frac{1}{(3-2x)^{\frac{3}{2}}}$$

$$d \frac{d}{dx} \frac{1}{3+2x} = -\frac{2}{(3+2x)^2}$$

$$e \frac{d}{dx}(2x-1)^{-\frac{2}{3}} = -\frac{4}{3}(2x-1)^{-\frac{5}{3}}$$

$$= -\frac{4}{3(2x-1)^{\frac{5}{3}}}$$

$$f \frac{d}{dx}3(2+x^2)^{-\frac{1}{2}} = -3x(2+x^2)^{-\frac{3}{2}}$$

$$= -\frac{3x}{(2+x^2)^{\frac{3}{2}}}$$

$$g \frac{d}{dx}\left(2x^2 - \frac{3}{x^2}\right)^{\frac{1}{3}} =$$

$$\frac{1}{3}\left(4x + \frac{6}{x^3}\right)\left(2x^2 - \frac{3}{x^2}\right)^{-\frac{2}{3}}$$

$$3 \text{ a } \frac{-1}{x^2} + c$$

$$b \frac{2x^{\frac{5}{2}}}{5} - \frac{4x^{\frac{3}{2}}}{3} + c$$

$$c \frac{3x^2}{2} + 2x + c$$

$$d \frac{-6x-1}{2x^2} + c$$

$$e \frac{5x^2}{2} - \frac{4x^{\frac{3}{2}}}{3} + c$$

$$f \frac{20x^{\frac{7}{4}}}{7} - \frac{3x^{\frac{4}{3}}}{2} + c$$

$$g 2x - \frac{2x^{\frac{3}{2}}}{3} + c$$

$$h -\frac{3x+1}{x^2+c} + c$$

$$4 \text{ s} = \frac{1}{2}t^2 + 3t + \frac{1}{t} + \frac{3}{2}$$

$$5 \text{ a } y = \sqrt{x}, \therefore y' = \frac{1}{2}x^{-\frac{1}{2}}$$

$$y'(9) = \frac{1}{2}(9)^{-\frac{1}{2}} = \frac{1}{6}$$

$$\mathbf{b} \quad y = \frac{1}{2x+1}, \therefore y' = -\frac{2}{(2x+1)^2}$$

$$y'(0) = -\frac{2}{1^2} = -2$$

$$\mathbf{c} \quad y = \frac{2}{x^2}, \therefore y' = -\frac{4}{x^3}$$

$$y'(4) = -\frac{4}{4^3} = -\frac{1}{16}$$

$$\mathbf{d} \quad y = 3 + \frac{2}{x}, \therefore y' = -\frac{2}{x^2}$$

$$y'(1) = -\frac{2}{1^2} = -2$$

$$\mathbf{e} \quad y = \sqrt{x+1}, \therefore y' = \frac{1}{2}(x+1)^{-\frac{1}{2}}$$

$$y'(8) = \frac{1}{2}(9^{-\frac{1}{2}}) = \frac{1}{6}$$

$$\mathbf{f} \quad y = (x^2 - 7x - 8)^3$$

$$\therefore y' = 3(2x - 7)(x^2 - 7x - 8)^2$$

$$y'(8) = 3(16 - 9)(0)^2 = 0$$

$$\mathbf{6} \quad y = \frac{1}{x}, \therefore y' = -\frac{1}{x^2} \text{ Gradient is } -4, \text{ so}$$

$$y'(x) = -4$$

$$-\frac{1}{x^2} = -4, \text{ so } x^2 = \frac{1}{4}$$

$$x = \pm \frac{1}{2}$$

$$y\left(\frac{1}{2}\right) = 2, y\left(-\frac{1}{2}\right) = -2$$

$$\mathbf{7} \quad y = \sqrt{x}, \therefore y' = \frac{1}{2}x^{-\frac{1}{2}}$$

$$y'(x) = 2, \therefore \frac{1}{2\sqrt{x}} = 2$$

$$\sqrt{x} = \frac{1}{4}$$

$$x = \frac{1}{16}$$

$$\therefore y = \frac{1}{4}$$

$$\text{Gradient is } 2 \text{ at } \left(\frac{1}{16}, \frac{1}{4}\right).$$

Solutions to multiple-choice questions

$$\begin{aligned} 1 \text{ B } \quad f(x) &= \frac{4x^4 - 12x^2}{3x} \\ &= \frac{4}{3}x^3 - 4x \\ \therefore f'(x) &= 4x^2 - 4 \end{aligned}$$

$$\begin{aligned} 2 \text{ D } \quad f(x) &= 2x^{\frac{p}{q}} \\ \therefore f'(x) &= \left(\frac{2p}{q}\right)x^{\frac{p}{q}-1} \end{aligned}$$

$$\begin{aligned} 3 \text{ A } \quad f(x) &= 4 + \frac{4}{2-x}; x \neq 2 \\ \therefore f'(x) &= \frac{4}{(2-x)^2} > 0; x \neq 2 \end{aligned}$$

$$\begin{aligned} 4 \text{ A } \quad x &= -t^3 + 7t^2 - 14t + 6 \text{ cm} \\ \therefore v &= -3t^2 + 14t - 14 \text{ cm/s} \\ \therefore a &= -6t + 14 \text{ cm/s}^2 \\ a(3) &= 14 - 18 = -4 \text{ cm/s}^2 \end{aligned}$$

$$5 \text{ A } \quad \frac{dy}{dx} = \left(\frac{dy}{df}\right)f'(x) = 3x^2 f'(x)$$

$$\begin{aligned} 6 \text{ E } \quad f(x) &= x + \frac{1}{x}, \therefore f'(x) = 1 - \frac{1}{x^2} \\ f'(x) &= 0, \therefore x^2 = 1 \\ & \quad x = \pm 1 \\ & \text{Local minimum where } x = 1 \\ \therefore a &= 1 \end{aligned}$$

$$7 \text{ A } \quad f(x) = x^{\frac{1}{5}}, \therefore f'(x) = \frac{1}{5}x^{-\frac{4}{5}}$$

A Gradient undefined for $x = 0$ X

B Curve passes through the origin ✓

C Curve passes through $(1, 1)$,
 $(-1, -1)$ ✓

D $f'(x) > 0; x \in R$ ✓

D $x > 0$, gradient is decreasing ✓

$$8 \text{ B } \quad f(x) = x^{\frac{3}{4}} < \therefore f'(x) = \frac{1}{4}x^{-\frac{1}{4}}$$

A Maximal domain = $R^+ \cup \{0\}$ ✓

B $f(x) < x$ for all $x > 1$ X

C Curve passes through $(1, 1)$ ✓

D $f'(x) > 0; x \in R$ ✓

E $x > 0$, gradient is decreasing ✓

$$\begin{aligned} 9 \text{ A } \quad \frac{d}{dx}(5x^2 + 2x)^n \\ &= n(10x + 2)(5x^2 + 2x)^{n-1} \end{aligned}$$

$$\begin{aligned} 10 \text{ D } \quad y &= \frac{k}{2(x^2 + 1)} \\ \therefore y' &= -kx(x^2 + 1)^{-2} \\ y'(1) &= 1, \therefore -\frac{k}{4} = 1 \\ & \quad k = -4 \end{aligned}$$

Solutions to extended-response questions

1 a The volume of the cylinder $= \pi r^2 h = 400$

Therefore
$$h = \frac{400}{\pi r^2}$$

b The surface area is
$$\begin{aligned} A &= 2\pi r h + 2\pi r^2 \\ &= 2\pi r \times \frac{400}{\pi r^2} + 2\pi r^2 \\ &= \frac{800}{r} + 2\pi r^2 \text{ as required} \end{aligned}$$

c
$$\frac{dA}{dr} = \frac{-800}{r^2} + 4\pi r = 4\pi r - \frac{800}{r^2}$$

d
$$\frac{dA}{dr} = 0 \text{ implies } 4\pi r - \frac{800}{r^2} = 0$$

Therefore
$$r^3 = \frac{200}{\pi}$$

and
$$r = \left(\frac{200}{\pi}\right)^{\frac{1}{3}} \approx 3.99$$

e Minimum surface area $= 120(5\pi)^{\frac{1}{3}}$
 $= 301 \text{ cm}^2$, correct to 3 significant figures

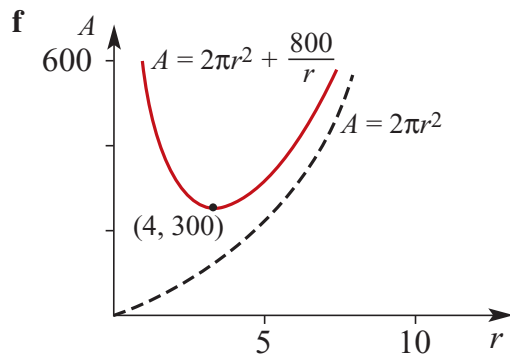

2 a Area is 16 cm^2 . Therefore $xy = 16$ and $y = \frac{16}{x}$.

b The perimeter is given by $P = 2(x + y) = 2x + \frac{32}{x}$ as required.

c The minimum occurs when $\frac{dP}{dx} = 0$,

$$\therefore \frac{dP}{dx} = 2 - \frac{32}{x^2} \text{ and } \frac{dP}{dx} = 0 \text{ implies } 2 - \frac{32}{x^2} = 0$$

therefore $2 = \frac{32}{x^2}$

$$x^2 = 16$$

and $x = \pm 4$

But $x > 0$ and so $x = 4$

When $x = 4$,

$$P = 2 \times 4 + \frac{32}{4} = 16$$

The minimum value of P is 16.

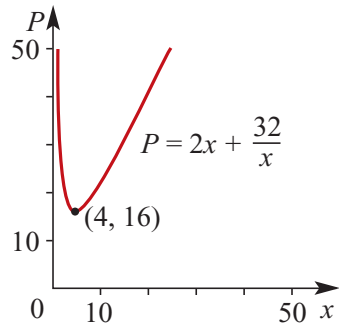

3 $OC = x$ cm, $CZ = 5$ cm and $AX = 7$ cm

a $OA \times OC = 120$, therefore $OA = \frac{120}{x}$

b
$$OX = OA + AX$$

$$= \frac{120}{x} + 7$$

c
$$OZ = OC + CZ$$

$$= x + 5$$

d
$$A = (x + 5)\left(\frac{120}{x} + 7\right) = 155 + 7x + \frac{600}{x}$$

e
$$\frac{dA}{dx} = 7 - \frac{600}{x^2}$$

$$\frac{dA}{dx} = 0 \text{ implies } x^2 = \frac{600}{7}$$

and $x = \frac{10\sqrt{42}}{7} \approx 9.26 \text{ cm} (x > 0)$

4 a For $y = \sqrt{x+2}$, the axis intercepts have coordinates $A(-2, 0)$ and $B(0, \sqrt{2})$.

b By the chain rule, $\frac{dy}{dx} = \frac{1}{2\sqrt{x+2}}$.

c i When $x = -1$, $\frac{dy}{dx} = \frac{1}{2}$.

ii When $x = -1$, $y = 1$, and the equation of the tangent at this point is

$$y - 1 = \frac{1}{2}(x + 1)$$

This implies $y = \frac{1}{2}x + \frac{3}{2}$ or $2y - x = 3$

iii The tangent meets the x -axis at $(-3, 0)$ and the y -axis at $(0, \frac{3}{2})$. Let these intercepts be the points C and D respectively.

$$\text{Distance } CD = \sqrt{\frac{9}{4} + 9} = \frac{3\sqrt{5}}{2}$$

d $\frac{1}{2\sqrt{x+2}} < 1$ implies $\frac{1}{2} < \sqrt{x+2}$

Square both sides $x + 2 > \frac{1}{4}$

and hence $x > -\frac{7}{4}$

5 The volume $V = 2x^2h$

a Since the volume is 36 cm^3 , $h = \frac{36}{2x^2}$
 $= \frac{18}{x^2}$

b The surface area is given by $A = 2x^2 + 6xh$
 $= 2x^2 + 6x \times \frac{18}{x^2}$
 $= 2x^2 + \frac{108}{x}$ as required

c $\frac{dA}{dx} = 4x - \frac{108}{x^2}$

and $\frac{dA}{dx} = 0$ implies $4x^3 = 108$

Hence $x^3 = 27$

and $x = 3$

The minimum surface area occurs for $x = 3$ and $h = 2$.

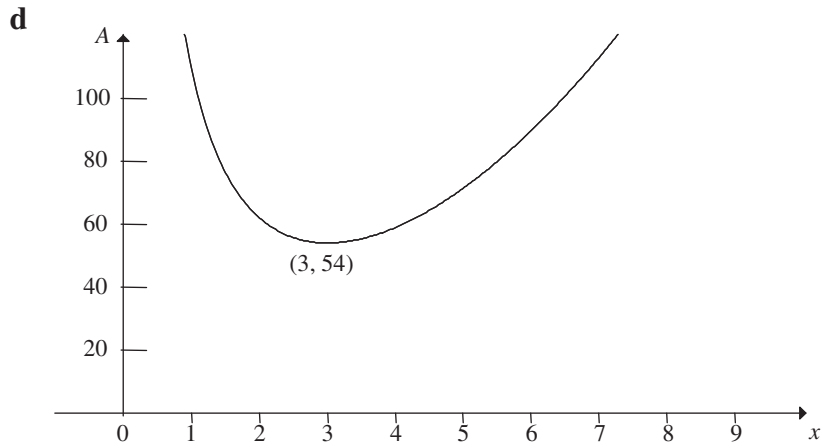

- 6 a** The height of the prism is y cm and the volume 1500 cm^3 .

$$\begin{aligned} \text{Area of triangle } ABC &= \frac{1}{2} \times 3x \times 4x \\ &= 6x^2 \end{aligned}$$

Therefore $6x^2y = 1500$

and $y = \frac{1500}{6x^2}$

$$= \frac{250}{x^2}$$

- b** $AB = 5x$ by Pythagoras' theorem.

Therefore the surface area is given by

$$\begin{aligned} S &= 5xy + 3xy + 4xy + 12x^2 \\ &= 12xy + 12x^2 \\ &= 12x^2 + \frac{3000}{x} \end{aligned}$$

c $\frac{dS}{dx} = 24x - \frac{3000}{x^2}$

d $\frac{dS}{dx} = 0$ implies $x^3 = 125$

and hence $x = 5$

When $x = 5$, $S_{\min} = 12 \times 25 + 600$

$$= 900$$

The minimum surface area is 900 cm^2 .

Chapter 21 – Integration

Solutions to Exercise 21A

1 $f(2) = 6, f(3) = 11, f(4) = 18, f(5) = 27$

Therefore area = $6 \times 1 + 11 \times 1 + 18 \times 1 + 27 \times 1 = 62$

2 $f(1) = 4, f(2) = 12, f(3) = 24, f(4) = 40$

Therefore area = $4 \times 1 + 12 \times 1 + 24 \times 1 + 40 \times 1 = 80$

3 $f(0.5) = 12.1875, f(1) = 20, f(1.5) = 23.9375, f(2) = 24, f(2.5) = 21.6875, f(3) = 20$

Therefore area = $12.1875 \times 0.5 + 20 \times 0.5 + 23.9375 \times 0.5 + 24 \times 0.5 + 21.6875 \times 0.5 + 20 \times 0.5 = 60.90625$

4 $f(0) = 0, f(1) = 5, f(2) = 14, f(3) = 27, f(4) = 44$

Area = $\frac{1}{2}(f(0) + f(1)) + \frac{1}{2}(f(1) + f(2)) + \frac{1}{2}(f(2) + f(3)) + \frac{1}{2}(f(3) + f(4)) = 68$

5 a $A \approx 5 + 3.5 + 2.5 + 2.2 = 13.2$

b $A \approx 3.5 + 2.5 + 2.2 + 2 = 10.2$

c $A \approx \frac{1}{2}(5 + 2) + (3.5 + 2.5 + 2.2) = 11.7$

6 Trapezoidal estimate:

$$\int_0^3 x(3-x) dx$$

a $= \frac{1.25 + 2 + 2.25 + 2 + 1.25}{2} = \frac{35}{8}$

b A trapezoidal approximation can be performed with a CAS calculator giving a value of 4.536.

7 $y = f(x)$:

x	0	1	2	3	4	5
y	3	3.5	3.7	3.8	3.9	3.9

x	6	7	8	9	10
y	4	4	3.7	3.3	2.9

a Left-endpoint: add all except 2.9 = 36.8

b Trapezoidal: $\frac{3 + 2.9}{2} + \text{middle 8} = 36.75$

8 $\int_0^1 \frac{1}{1+x^2} dx \approx$ (strip width = 0.25)

$$\frac{\left(1 + \frac{1}{2}\right)}{8} + \frac{\left(\frac{16}{16} + \frac{4}{5} + \frac{16}{25}\right)}{4} \approx 0.783$$

$\therefore \pi \approx 4 \times 0.783 = 3.13$

9 a $\int_0^2 2^x dx \approx$ (strip width 0.5)

$$\frac{1 + 4}{4} + \frac{\sqrt{2} + 2 + 2\sqrt{2}}{2} \approx 4.371$$

b $\int_0^{0.9} \frac{1}{\sqrt{1-x^2}} dx \approx$
 1.128 (strip width 0.1)

10

D	0	3	6	9	12	15
S	1	2	3	4	5	5

D	18	21	24	27	30
S	6	4	4	2	2

Trapezium: $\frac{3}{2}(1 + 2) +$
 $3(\text{middle } 9) = 109.5 \text{ m}^2$

Solutions to Exercise 21B

$$1 \text{ a } \int_1^2 x^2 dx = \frac{1}{3}(2^3 - 1^3) = \frac{7}{3}$$

$$b \int_{-1}^3 x^3 dx = \frac{1}{4}(3^4 - 1^4) = 20$$

$$c \int_0^1 (x^3 - x) dx = \frac{1}{4} - \frac{1}{2} = -\frac{1}{4}$$

$$d \int_{-1}^2 (x+1)^2 dx = \frac{1}{3}(3^3 - 0) = 9$$

$$e \int_1^2 x^3 dx = \frac{1}{4}(2^4 - 1^4) = \frac{15}{4}$$

$$f \int_1^4 x + 2x^2 dx = \frac{1}{2}(4^2 - 1^2) + \frac{2}{3}(4^3 - 1^3) \\ = \frac{15}{2} + 42 = 49.5$$

$$g \int_0^2 x^3 + 2x^2 + x + 2 dx \\ = \frac{2^4}{4} + \frac{2}{3}2^3 + \frac{1}{2}2^2 + 2(2) \\ = 4 + \frac{16}{3} + 4 + 2 \\ = \frac{46}{3}$$

$$h \int_1^4 2x + 5 dx = (4^2 - 1^2) + 5(4 - 1) \\ = 30$$

$$2 \int_0^2 (x+1) dx = \left[\frac{x^2}{2} + x \right]_0^2 \\ = 4 - 0 \\ = 4$$

$$3 \int_0^3 (x^2) dx = \left[\frac{x^3}{3} \right]_0^3 \\ = 9 - 0 \\ = 9$$

$$4 \int_{-1}^1 (1 - x^2) dx = \left[x - \frac{x^3}{3} \right]_{-1}^1 \\ = \frac{2}{3} - \left(-\frac{2}{3}\right) \\ = \frac{4}{3}$$

$$5 \int_0^2 (4x - x^3) dx = \left[2x^2 - \frac{x^4}{4} \right]_0^2 \\ = 4 - 0 \\ = 4$$

Solutions to Exercise 21C

$$\begin{aligned}
 \mathbf{1} \quad \int_0^4 (x^2 - 4x) dx &= \left[\frac{x^3}{3} - 2x^2 \right]_0^4 \\
 &= -\frac{32}{3} - 0 \\
 &= -\frac{32}{3}
 \end{aligned}$$

$$\begin{aligned}
 \mathbf{2} \quad \int_{-3}^3 (x^2 - 9) dx &= \left[\frac{x^3}{3} - 9x \right]_{-3}^3 \\
 &= -36 - 0 \\
 &= -36
 \end{aligned}$$

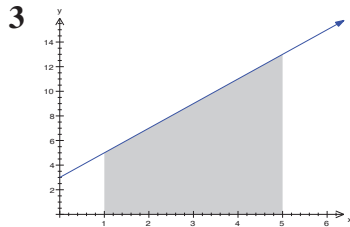

$$\begin{aligned}
 A &= \frac{1}{2}(5-1)(5+13) = 36 \\
 \int_1^5 2x + 3 dx &= (5^2 - 1^2) + 3(5-1) = 36
 \end{aligned}$$

$$\begin{aligned}
 \mathbf{4} \quad y &= x(x-1)(3-x) \\
 &= -x^3 + 4x^2 - 3x \\
 A &= \int_1^3 y dx - \int_0^1 y dx \\
 I &= -\frac{x^4}{4} + \frac{4}{3}x^3 - \frac{3x^2}{2} \\
 \therefore A &= \left[\frac{9}{4} - \left(-\frac{5}{12} \right) \right] - \left[-\frac{5}{12} - 0 \right] \\
 &= \frac{37}{12} \cong 3.08
 \end{aligned}$$

$$\mathbf{5} \quad \int_1^5 h(x) dx = 4$$

$$\mathbf{a} \quad \int_1^5 2h(x) dx = 2 \int_1^5 h(x) dx = 8$$

$$\begin{aligned}
 \mathbf{b} \quad \int_1^5 h(x) + 3 dx &= 4 + \int_1^5 3 dx \\
 &= 4 + 3(5-1) = 16
 \end{aligned}$$

$$\mathbf{c} \quad \int_5^1 h(x) dx = - \int_1^5 h(x) dx = -4$$

$$\mathbf{6} \quad \int_2^5 f(x) dx = 12$$

$$\mathbf{a} \quad \int_5^2 f(x) dx = - \int_2^5 f(x) dx = -12$$

$$\mathbf{b} \quad \int_2^5 3f(x) dx = 3 \int_2^5 f(x) dx = 36$$

$$\begin{aligned}
 \mathbf{c} \quad \int_2^4 f(x) dx + \int_4^5 f(x) dx + \int_2^4 4 dx \\
 &= \int_2^5 f(x) dx + \int_2^4 4 dx \\
 &= 12 + 4(4-2) = 20
 \end{aligned}$$

$$\begin{aligned}
 \mathbf{7} \quad \mathbf{a} \quad \int_1^3 6x dx &= 3(3^2 - 1^2) = 24 \\
 \int_3^4 6x dx &= 3(4^2 - 3^2) = 21 \\
 \int_1^4 6x dx &= 3(4^2 - 1^2) = 45
 \end{aligned}$$

$$\begin{aligned} \mathbf{b} \quad \int_1^3 6 - 2x \, dx &= 6(3 - 1) - (3^2 - 1^2) \\ &= 4 \end{aligned}$$

$$\begin{aligned} \int_3^4 6 - 2x \, dx &= 6(4 - 3) - (4^2 - 3^2) \\ &= -1 \end{aligned}$$

$$\begin{aligned} \int_1^4 6 - 2x \, dx &= 6(4 - 1) - (4^2 - 1^2) \\ &= 3 \end{aligned}$$

(1) + (2) = (3) in both cases

$$\mathbf{8} \quad y = 5x - x^2 - 4$$

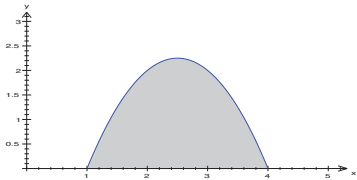

$$A = \int_1^4 5x - x^2 - 4 \, dx = 4.5$$

$$\mathbf{9} \quad y = x(10 - x)$$

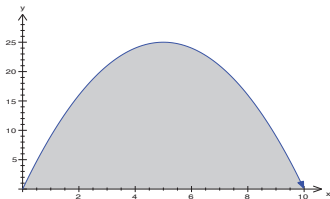

$$A = \int_0^{10} x(10 - x) \, dx = \frac{500}{3}$$

$$\mathbf{10} \quad y = x(x - 2)(x + 1)$$

Axis intercepts $(-1, 0)$, $(0, 0)$, $(2, 0)$

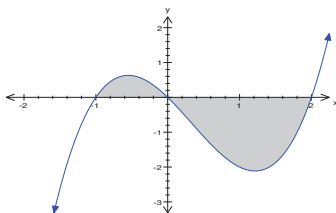

$$A = \int_{-1}^0 y \, dx - \int_0^2 y \, dx = \frac{37}{12}$$

$$\begin{aligned} \mathbf{11} \quad \mathbf{a} \quad \int_1^2 \frac{(2+x)(2-x)}{x^2} \, dx &= \int_1^2 \frac{4-x^2}{x^2} \, dx \\ &= \int_1^2 \left(\frac{4}{x^2} - 1 \right) \, dx \\ &= \left[-\frac{4}{x} - x \right]_1^2 \\ &= -\left(\frac{4}{2} + 2 \right) + \left(\frac{4}{1} + 1 \right) \\ &= -4 + 5 = 1 \end{aligned}$$

$$\begin{aligned} \mathbf{b} \quad \int_1^4 2x - 3x^{\frac{1}{2}} \, dx &= \left[x^2 - 2x^{\frac{3}{2}} \right]_1^4 \\ &= (4^2 - 1^2) - 2\left(4^{\frac{3}{2}} - 1^{\frac{3}{2}} \right) \\ &= 15 - 14 = 1 \end{aligned}$$

$$\begin{aligned} \mathbf{c} \quad \int_1^3 \frac{4x^2 + 9}{x^2} \, dx &= \int_1^3 4 + \frac{9}{x^2} \, dx \\ &= \left[4x - \frac{9}{x} \right]_1^3 \\ &= 4(3 - 1) - \left(\frac{9}{3} - \frac{9}{1} \right) = 14 \end{aligned}$$

$$\begin{aligned} \mathbf{d} \quad \int_1^4 6x - 3x^{\frac{1}{2}} \, dx &= \left[3x^2 - 2x^{\frac{3}{2}} \right]_1^4 \\ &= 3(4^2 - 1^2) - 2\left(4^{\frac{3}{2}} - 1^{\frac{3}{2}} \right) \\ &= 3(15) - 2(8 - 1) = 31 \end{aligned}$$

$$\begin{aligned} \mathbf{e} \quad \int_1^4 \frac{x^2 - 1}{x^2} \, dx &= \int_1^4 1 - \frac{1}{x^2} \, dx \\ &= \left[x + \frac{1}{x} \right]_1^4 \\ &= (4 - 1) + \left(\frac{1}{4} - \frac{1}{1} \right) \\ &= 3 - \frac{3}{4} = \frac{9}{4} \end{aligned}$$

$$\begin{aligned}
 \mathbf{f} \quad \int_1^4 \frac{2x - 3x^{\frac{1}{2}}}{x} dx &= \int_1^4 2 - 3x^{-\frac{1}{2}} dx \\
 &= \left[2x - 6x^{\frac{1}{2}} \right] \\
 &= 2(4 - 1) - 6(\sqrt{4} - \sqrt{1}) \\
 &= 6 - 6 = 0
 \end{aligned}$$

$$\mathbf{12 \ a} \quad A = - \int_0^2 x^2 - 2x dx = \frac{4}{3}$$

$$\mathbf{b} \quad A = - \int_3^4 (4 - x)(3 - x) dx = \frac{1}{6}$$

$$\mathbf{c} \quad A = \int_{-2}^7 (x + 2)(7 - x) dx = 121.5$$

$$\mathbf{d} \quad A = \int_2^3 x^2 - 5x + 6 dx = \frac{1}{6}$$

$$\mathbf{e} \quad A = \int_{-\sqrt{3}}^{\sqrt{3}} 3 - x^2 dx = 4\sqrt{3} \approx 6.93$$

$$\mathbf{f} \quad A = - \int_0^6 x^3 - 6x^2 dx = 108$$

All areas are measured in square units.

Solutions to Technology-free questions

$$1 \text{ a } \int_1^2 2x \, dx = [x^2]_1^2 = 2^2 - 1^2 = 3$$

$$1 \text{ b } \int_1^2 2 \, dx = [2x]_1^2 = 10 - 4 = 6$$

$$1 \text{ c } \int_3^5 3x^2 + 2x \, dx = [x^3 + x^2]_3^5 \\ = (5^3 - 3^3) + (5^2 - 3^2) \\ = 114$$

$$1 \text{ d } \int_1^5 x^2 + 2x \, dx = \left[\frac{x^3}{3} + x^2 \right]_1^5 \\ = \frac{1}{3}(5^3 - 1^3) + (5^2 - 1^2) \\ = \frac{196}{3}$$

$$1 \text{ e } \int_{-3}^{-2} 5 \, dx = 5(-2 + 3) = 5$$

$$2 \text{ a } \int_1^4 \sqrt{x} \, dx = \left[\frac{2}{3}x^{\frac{3}{2}} \right]_1^4 \\ = \frac{2}{3} \left(4^{\frac{3}{2}} - 1^{\frac{3}{2}} \right) \\ = \frac{14}{3}$$

$$2 \text{ b } \int_1^4 x^3 - 2x \, dx = \left[\frac{1}{4}x^4 - x^2 \right]_1^4 \\ = \frac{1}{4}(4^4 - 1^4) - (4^2 - 1^2) \\ = \frac{195}{4}$$

$$2 \text{ c } \int_1^2 \frac{1}{x^2} \, dx = \left[-\frac{1}{x} \right]_1^2 = -\left(\frac{1}{2} - \frac{1}{1} \right) = \frac{1}{2}$$

$$2 \text{ d } \int_1^4 \frac{2}{x^3} \, dx = \left[-\frac{1}{x^2} \right]_1^4 = -\left(\frac{1}{4^2} - \frac{1}{1^2} \right) \\ = \frac{15}{16}$$

$$2 \text{ e } \int_0^1 \sqrt{x}(x+2) \, dx = \int_0^1 x^{\frac{3}{2}} + x^{\frac{1}{2}} \, dx \\ = \left[\frac{2}{5}x^{\frac{5}{2}} + \frac{2}{3}x^{\frac{3}{2}} \right]_0^1 \\ = \frac{2}{5} + \frac{2}{3} = \frac{16}{15}$$

$$3 \int_1^2 x^3 \, dx = \frac{1}{4}(2^4 - 1^4) = \frac{15}{4}$$

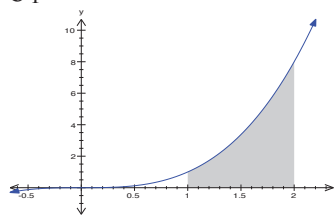

$$4 \text{ A} = \int_2^1 (1-x)(2+x) \, dx \\ = \int_2^1 2 - x - x^2 \, dx \\ = \left[2x - \frac{x^2}{2} - \frac{x^3}{3} \right]_2^1 \\ = \left[2 - \frac{1}{2} - \frac{1}{3} \right] - \left[-3 - 2 + \frac{8}{3} \right] \\ = \frac{7}{6} + \frac{10}{3} = 4.5$$

$$5 \quad y = x(x-3)(x+2) = x^3 - x^2 - 6x$$

$$A = \int_{-2}^0 y \, dx - \int_0^3 y \, dx$$

$$I = \frac{x^4}{4} - \frac{x^3}{3} - 3x^2$$

$$\begin{aligned} A &= \left(\frac{1}{4}(0-16) - \frac{1}{3}(0+8) - 3(0-4) \right) \\ &\quad - \left(\frac{1}{4}(81) - \frac{1}{3}(27) - 3(9) \right) \\ &= \left(-4 - \frac{8}{3} + 12 \right) - \left(\frac{81}{4} - 9 - 27 \right) \\ &= \frac{16}{3} + \frac{63}{4} = \frac{253}{12} \end{aligned}$$

$$6 \quad \mathbf{a} \quad B = (1, 3), C = (3, 3)$$

$$\mathbf{b} \quad ABCD \text{ area} = 3(2) = 6$$

$$\begin{aligned} \mathbf{c} \quad a &= \int_1^3 4x - x^2 \, dx - 6 \\ &= \left[2x^2 - \frac{x^3}{3} \right]_1^3 - 6 \\ &= 2(3^2 - 1^2) - \frac{1}{3}(3^3 - 1^3) - 6 \\ &= 16 - \frac{26}{3} - 6 = \frac{4}{3} \end{aligned}$$

Solutions to multiple-choice questions

$$1 \text{ C } \int x^3 + 3x dx = \frac{x^4}{4} + \frac{3x^2}{2} + c$$

$$2 \text{ D } \int \sqrt{x} + x dx = \frac{2}{3}x^{\frac{3}{2}} + \frac{1}{2}x^2 + c$$

$$3 \text{ A } 3 \int x^{-4} dx = -x^{-3} + c$$

$$4 \text{ D } \frac{dy}{dx} = 2x + 5, \therefore y = x^2 + 5x + c \\ y(0) = 1, \therefore c = 1$$

$$5 \text{ B } f'(x) = 5x^4 - 9x^2 \\ \therefore f(x) = x^5 - 3x^3 + c \\ f(1) = 2, \therefore 1 - 3 + c = 2 \\ \therefore c = 4$$

$$6 \text{ B } \frac{dy}{dx} = \frac{4}{x^3}, \therefore y = -\frac{2}{x^2} + c \\ y(1) = 0, \therefore c - 2 = 0 \\ c = 2$$

$$7 \text{ D } F'(x) = f(x) \\ \therefore \int_3^5 f(x) dx = F(5) - F(3)$$

$$8 \text{ B } \int_0^2 3x^2 - 2x dx = 2^3 - 2^2 \\ = 4$$

$$9 \text{ C } \int_0^2 3f(x) + 2 dx \\ = 3 \int_0^2 f(x) dx + \int_0^2 2 dx \\ = 3 \int_0^2 f(x) dx + 4$$

$$10 \text{ A } k \int_0^3 (x-3)^2 dx = 36 \\ \therefore -\frac{(-3)^3}{3} = \frac{36}{k} \\ k = \frac{36}{9} = 4$$

Solutions to extended-response questions

$$\begin{aligned} 1 \quad \frac{dy}{dx} &= \frac{9}{32}(x^2 - 4x) \\ &= \frac{9}{32}x^2 - \frac{9}{8}x \end{aligned}$$

$$\begin{aligned} \text{a} \quad y &= \int \frac{dy}{dx} dx \\ &= \frac{3}{32}x^3 - \frac{9}{16}x^2 + c \end{aligned}$$

The coordinates of the graph that represent the highest part of the slide are (0, 3).
Substituting these values into the equation of the curve determines c .

$$3 = \frac{3}{32}(0)^3 - \frac{9}{16}(0)^2 + c$$

$$\therefore 3 = 0 - 0 + c$$

$$\therefore c = 3$$

$$\therefore y = \frac{3}{32}x^3 - \frac{9}{16}x^2 + 3 \quad \text{for } x \in [0, 4]$$

$$\text{b} \quad \text{Domain} = \{x: 0 \leq x \leq 4\}$$

$$\text{Range} = \{y: 0 \leq y \leq 3\}$$

$$\text{At the stationary points,} \quad \frac{dy}{dx} = 0$$

$$\therefore \frac{9}{32}(x^2 - 4x) = 0$$

$$\therefore \frac{9}{32}x(x - 4) = 0$$

$$\therefore x = 0 \quad \text{or} \quad x = 4$$

$$\begin{aligned} \text{At } x = 0, \quad y &= \frac{3}{32}(0)^3 - \frac{9}{16}(0)^2 + 3 \\ &= 3 \end{aligned}$$

$$\begin{aligned} \text{At } x = 4, \quad y &= \frac{3}{32}(4)^3 - \frac{9}{16}(4)^2 + 3 \\ &= \frac{3 \times 64}{32} - \frac{9 \times 16}{16} + 3 \\ &= 6 - 9 + 3 \\ &= 0 \end{aligned}$$

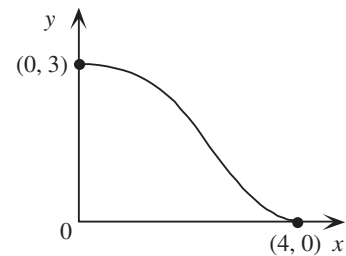

c If the slope of the slide exceeds 45° , then the gradient of the curve will be less than -1 .

$$\therefore \frac{dy}{dx} < -1$$

$$\therefore \frac{9}{32}(x^2 - 4x) < -1$$

$$\therefore x^2 - 4x + \frac{32}{9} < 0$$

Consider $x^2 - 4x + \frac{32}{9} = 0$

$$\therefore 9x^2 - 36x + 32 = 0$$

$$\therefore (3x - 4)(3x - 8) = 0$$

$$\therefore x = \frac{4}{3} \quad \text{or} \quad x = \frac{8}{3}$$

The gradient of y at $x = \frac{4}{3}$ and $x = \frac{8}{3}$ is -1 , and $x^2 - 4x + \frac{32}{9} < 0$ for $\frac{4}{3} < x < \frac{8}{3}$.

The slope of the slide exceeds 45° for $\frac{4}{3} < x < \frac{8}{3}$.

2 a $\text{Area}_{OABC} = 9 \times 3 = 27$ square units

b $y = k(x - 4)^2$

When $x = 9$, $y = 3$

$$\therefore 3 = k(9 - 4)^2$$

$$\therefore 3 = 25k$$

$$\therefore k = \frac{3}{25}$$

$$\therefore y = \frac{3}{25}(x - 4)^2$$

$$\begin{aligned}
\text{c } \int_0^9 y \, dx &= \int_0^9 \frac{3}{25}(x-4)^2 dx \\
&= \frac{3}{25} \int_0^9 x^2 - 8x + 16 dx \\
&= \frac{3}{25} \left[\frac{1}{3}x^3 - 4x^2 + 16x \right]_0^9 \\
&= \frac{3}{25} \left[\left(\frac{1}{3}(9)^3 - 4(9)^2 + 16(9) \right) - \left(\frac{1}{3}(0)^3 - 4(0)^2 + 16(0) \right) \right] \\
&= \frac{3}{25}(9) \left(\frac{9 \times 9}{3} - 4 \times 9 + 16 \right) \\
&= \frac{27}{25}(27 - 36 + 16) \\
&= \frac{27 \times 7}{25} \\
&= \frac{189}{25} \\
&= 7\frac{14}{25}
\end{aligned}$$

The total area of the region enclosed between the curve and the x -axis for $x \in [0, 9]$ is $7\frac{14}{25}$ square units.

$$\begin{aligned}
\text{d } \text{Area of shaded region} &= \text{Area}_{OABC} - \int_0^9 y \, dx \\
&= 27 - 7\frac{14}{25} = \frac{486}{25}
\end{aligned}$$

The area of the cross-section of the pool is $\frac{486}{25}$ or $19\frac{11}{25}$ square units.

3 a i Let V (litres) be the volume of water in the container.

$$\therefore V = Rt, \quad \text{and } R = 2 \text{ L/s}, t = 60 \text{ s}$$

$$\therefore V = 2 \times 60$$

$$\therefore V = 120$$

After 1 minute, 120 litres of water has flowed into the container.

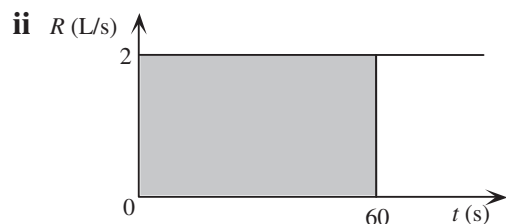

$$\begin{aligned}
 \text{b i } V &= \int_0^{60} R dt \\
 &= \int_0^{60} \frac{t}{2} dt \\
 &= \left[\frac{t^2}{4} \right]_0^{60} \\
 &= \frac{3600}{4} - 0 \\
 &= 900
 \end{aligned}$$

After 1 minute, 900 litres of water has flowed into the container.

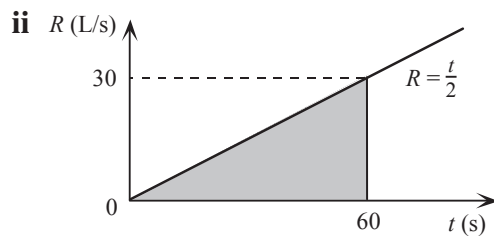

$$\begin{aligned}
 \text{iii } V &= \int_0^{60} \frac{t}{2} dt \\
 &= \frac{(60a)^2}{4} = 900a^2
 \end{aligned}$$

$900a^2$ litres have flowed into the container after a minutes.

$$\begin{aligned}
 \text{c i } V &= \int_0^{60} \frac{t^2}{10} dt \\
 &= \left[\frac{t^3}{30} \right]_0^{60}
 \end{aligned}$$

$$\therefore V = 7200$$

The area of the shaded region is 7200 square units.

ii The area of the shaded region represents the volume of water (in litres) that has flowed into the container after 60 seconds.

$$\text{iii } V = \frac{t^3}{30} \quad \text{and } V = 10\,000$$

$$\therefore t^3 = 30V = 30 \times 10\,000$$

$$\therefore t = \sqrt[3]{300\,000} \approx 66.94$$

10 000 litres had flowed into the container after about 67 seconds.

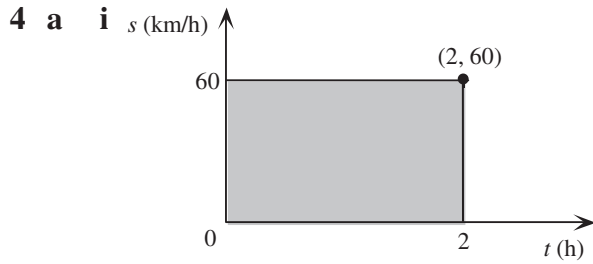

ii See shaded area above which indicates the total distance travelled by the car after 2 hours.

b i Let acceleration = $a(\text{km}/\text{min}^2) = 0.3$

$$\therefore s = \int a dt = at + c$$

When $t = 0$, $s = 0$

$$\therefore 0 = a(0) + c$$

$$\therefore c = 0$$

$$\therefore s = at$$

$$\therefore s = 0.3t$$

When $t = 5$, $s = 1.5$

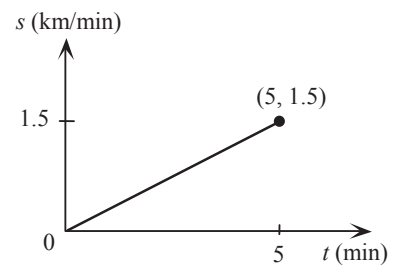

ii Let d denote the distance travelled (km) at time t (minutes).

$$\begin{aligned} d &= \int_0^5 s dt \\ &= \int_0^5 0.3t dt = [0.15t^2]_0^5 \\ &= 0.15(5)^2 \\ &= 3.75 \end{aligned}$$

The car has travelled 3.75 km after 5 minutes.

c i acceleration = $\frac{dV}{dt}$

$$= \frac{d}{dt}(20t - 3t^2)$$

$$= 20 - 6t, \text{ the acceleration of the particle at time } t \text{ in } \text{m}/\text{s}^2.$$

ii $V = 0$ implies $t(20 - 3t) = 0$

i.e. $t = 0$ or $t = \frac{20}{3}$

When $\frac{dV}{dt} = 0$, $20 - 6t = 0$

$\therefore 6t = 20$

$\therefore t = \frac{10}{3}$

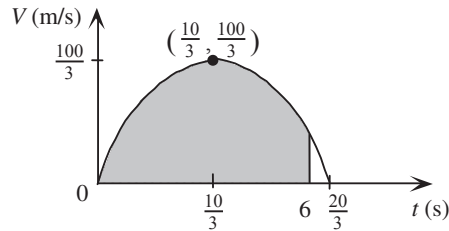

When $t = \frac{10}{3}$,

$$V = 20\left(\frac{10}{3}\right) - 3\left(\frac{10}{3}\right)^2$$

$$= \frac{20 \times 10}{3} - \frac{3 \times 10 \times 10}{3 \times 3}$$

$$= \frac{200 - 100}{3}$$

$$= \frac{100}{3}$$

iii distance travelled = $\int_0^6 V dt$

$$= \int_0^6 20t - 3t^2 dt$$

$$= [10t^2 - t^3]_0^6$$

$$= 10(6)^2 - (6)^3$$

$$= 360 - 216$$

$$= 144$$

The particle has travelled 144 m after 6 seconds (shaded area of graph).

5 a i When $x = 10$,

$$y = \frac{10^2}{1000}(50 - 10)$$

$$= \frac{100 \times 40}{1000}$$

$$= 4$$

The height of the mound 10 m from the edge is 4 m.

$$\begin{aligned} \text{ii When } x = 40, \quad y &= \frac{40^2}{1000}(50 - 40) \\ &= \frac{1600 \times 10}{1000} \\ &= 16 \end{aligned}$$

The height of the mound 40 m from the edge is 16 m.

$$\begin{aligned} \text{b} \quad y &= \frac{x^2}{1000}(50 - x) \\ &= \frac{1}{20}x^2 - \frac{1}{1000}x^3 \end{aligned}$$

$$\begin{aligned} \text{Gradient is given by} \quad \frac{dy}{dx} &= \frac{2}{20}x - \frac{3}{1000}x^2 \\ &= \frac{x}{10} - \frac{3x^2}{1000} \end{aligned}$$

$$\begin{aligned} \text{i When } x = 10, \quad \frac{dy}{dx} &= \frac{10}{10} - \frac{3(10)^2}{1000} \\ &= 1 - \frac{3}{10} \\ &= 0.7 \end{aligned}$$

The gradient of the boundary curve when 10 m from the edge is 0.7.

$$\begin{aligned} \text{ii When } x = 40, \quad \frac{dy}{dx} &= \frac{40}{10} - \frac{3(40)^2}{1000} \\ &= 4 - \frac{48}{10} = -0.8 \end{aligned}$$

The gradient of the boundary curve when 40 m from the edge is -0.8 .

c The height of the mound is a maximum when $\frac{dy}{dx} = 0$.

$$\begin{aligned} \frac{dy}{dx} &= \frac{x}{10} - \frac{3x^2}{1000} \\ &= \frac{x}{1000}(100 - 3x) \end{aligned}$$

$$\text{When } \frac{dy}{dx} = 0, \quad \frac{x}{1000}(100 - 3x) = 0$$

$$\therefore \frac{x}{1000} = 0 \quad \text{or} \quad 100 - 3x = 0$$

$$\therefore x = 0 \quad \text{or} \quad 3x = 100$$

$$x = \frac{100}{3}$$

$$\begin{aligned}
 \text{When } x = \frac{100}{3}, \quad y &= \frac{\left(\frac{100}{3}\right)^2}{1000} \left(50 - \frac{100}{3}\right) \\
 &= \frac{100 \times 100}{9 \times 1000} \left(\frac{150 - 100}{3}\right) \\
 &= \frac{10 \times 50}{9 \times 3} \\
 &= \frac{500}{27} \approx 18.52
 \end{aligned}$$

i The height of the mound is a maximum when $x = \frac{100}{3}$.

ii The maximum height of the mound is $\frac{500}{27}$ m, or approximately 18.52 m.

$$\begin{aligned}
 \mathbf{d} \quad \int_0^{50} y \, dx &= \int_0^{50} \frac{x^2}{1000} (50 - x) \, dx \\
 &= \int_0^{50} \frac{1}{20} x^2 - \frac{1}{1000} x^3 \, dx \\
 &= \left[\frac{1}{60} x^3 - \frac{1}{4000} x^4 \right]_0^{50} \\
 &= \frac{(50)^3}{60} - \frac{(50)^4}{4000} \\
 &= \frac{50 \times 50 \times 50}{60} - \frac{50 \times 50 \times 50 \times 50}{4000} \\
 &= \frac{1}{6} (12\,500 - 9375) \\
 &= \frac{3125}{6} = 520\frac{5}{6}
 \end{aligned}$$

The cross-sectional area of the mound is $520\frac{5}{6}$ m².

$$\mathbf{e \quad i} \quad y = \frac{x^2}{1000} (50 - x)$$

$$\text{When } y = 12, \quad 12 = \frac{x^2}{1000} (50 - x)$$

$$\text{i.e.} \quad 12000 = 50x^2 - x^3$$

It is known that when $x = 20$, $y = 12$, and therefore by the factor theorem $(x - 20)$

is a factor of $x^3 - 50x^2 + 1200$.

$$\therefore x^3 - 50x^2 + 1200 = 0$$

$$\therefore (x - 20)(x^2 - 30x - 600) = 0$$

$$\therefore x = 20 \quad \text{or} \quad x^2 - 30x - 600 = 0$$

$$\begin{aligned} x^2 - 30x - 600 = 0 \text{ implies} \quad x &= \frac{30 \pm \sqrt{900 + 2400}}{2} \\ &= \frac{30 \pm \sqrt{3300}}{2} \\ &= \frac{30 \pm 10\sqrt{33}}{2} \\ &= 15 \pm 5\sqrt{33} \end{aligned}$$

The required value is $x = 15 + 5\sqrt{33}$, as $x \geq 0$.

Hence B has coordinates $(15 + 5\sqrt{33}, 12)$.

ii The top of the mound can be represented by the curve

$y = \frac{x^2}{1000}(50 - x) - 12$, a translation of the curve $y = \frac{x^2}{1000}(50 - x)$ in the negative direction of the y -axis by 12 units.

$$\begin{aligned} \text{Take } p = 15 + 5\sqrt{33}, q = 20 \text{ and } R &= \int_{20}^{15+5\sqrt{33}} 12 \, dx \\ &= 12[x]_{20}^{15+5\sqrt{33}} \\ &= 12[15 + 5\sqrt{33} - 20] \\ &= 12 \times (5\sqrt{33} - 5) = 60\sqrt{33} - 60 \end{aligned}$$

6 a i $f'(x) = 6x + 3$

At $(1, 6)$ $f'(1) = 6(1) + 3$

$$= 9$$

The gradient of the curve at $(1, 6)$ is 9.

ii The tangent to the curve is a straight line of the form $(y - y_1) = m(x - x_1)$, where $m = 9$ and $(x_1, y_1) = (1, 6)$.

$$y - 6 = 9(x - 1)$$

$$\therefore y - 6 = 9x - 9$$

$$\therefore y = 9x - 3 \text{ is the equation of the tangent.}$$

$$\begin{aligned} \text{iii} \quad & y = f(x) \\ & f'(x) = 6x + 3 \\ \therefore & f(x) = \int f'(x)dx \\ & = 3x^2 + 3x + c \end{aligned}$$

The curve passes through the point with coordinates (1, 6).

$$\begin{aligned} \therefore & f(1) = 3(1)^2 + 3(1) + c = 6 \\ \therefore & 3 + 3 + c = 6 \\ \therefore & c = 0 \\ \therefore & f(x) = 3x^2 + 3x \text{ is the equation of the curve.} \end{aligned}$$

b i The gradient of the tangent is $f'(2) = 6(2) + k = 12 + k$.

ii Let $(x_1, y_1) = (0, 0)$ and $(x_2, y_2) = (2, 10)$

The gradient of the tangent is given by

$$\begin{aligned} m &= \frac{y_2 - y_1}{x_2 - x_1} \\ &= \frac{10 - 0}{2 - 0} = 5 \end{aligned}$$

The gradient of the tangent is 5.

$$f'(x) = 6x + k$$

$$\begin{aligned} \text{When } x = 2, \quad & f'(2) = 6(2) + k \\ & = 12 + k \end{aligned}$$

$$\text{But from above,} \quad f'(2) = 5$$

$$\therefore 12 + k = 5$$

$$\therefore k = -7$$

iii $f'(x) = 6x - 7$

$$f(x) = 3x^2 - 7x + c$$

The curve passes through the point with coordinates (2, 10).

$$\therefore f(2) = 3(2)^2 - 7(2) + c = 10$$

$$\therefore 12 - 14 + c = 10$$

$$\therefore c = 12$$

$\therefore f(x) = 3x^2 - 7x + 12$ is the equation of the curve.

7 a Area = $\frac{1}{2}(2 \times 2) + 1 \times 2 + \frac{1}{2}(2 \times 2)$
 $= 2 + 2 + 2$
 $= 6$ square metres

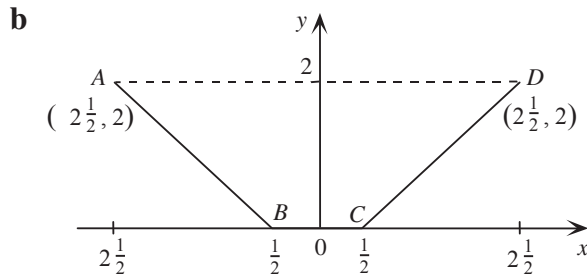
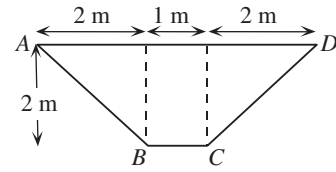

i CD passes through $(\frac{1}{2}, 0)$ and $(2\frac{1}{2}, 2)$.
 Let $y - y_1 = m(x - x_1)$ be the equation of the line CD
 where $m = \frac{y_2 - y_1}{x_2 - x_1}$, $(x_1, y_1) = (\frac{1}{2}, 0)$ and $(x_2, y_2) = (2\frac{1}{2}, 2)$.

$$\therefore y - 0 = \frac{2 - 0}{2\frac{1}{2} - \frac{1}{2}} \left(x - \frac{1}{2} \right)$$

$$\therefore y = x - \frac{1}{2}$$

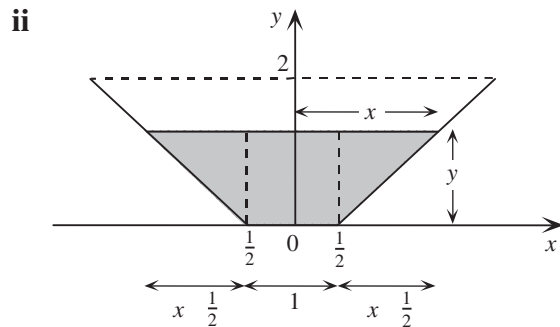

$$\begin{aligned} \text{Area of shaded region} &= \frac{1}{2}y \left(x - \frac{1}{2} \right) + 1 \times y + \frac{1}{2}y \left(x - \frac{1}{2} \right) \\ &= y \left(x - \frac{1}{2} \right) + y \\ &= xy - \frac{1}{2}y + y \\ &= xy + \frac{1}{2}y \end{aligned}$$

or by considering the trapezium

$$\begin{aligned} \text{Area} &= \frac{y}{2}(1 + 2x) \\ &= \frac{1}{2}y + xy \end{aligned}$$

$$\begin{aligned} \text{But } y &= x - \frac{1}{2} & \therefore \text{Area} &= \frac{1}{2}\left(x - \frac{1}{2}\right) + x\left(x - \frac{1}{2}\right) \\ & & &= \frac{1}{2}x - \frac{1}{4} + x^2 - \frac{1}{2}x \\ & & &= \left(x^2 - \frac{1}{4}\right) \text{m}^2 \end{aligned}$$

c i

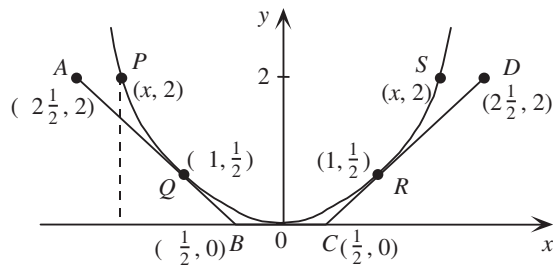

The equation of the parabola can be expressed as $y = ax^2$.

The point R is on both the line CD and the parabola.

$$\text{When } x = 1, \quad y = \frac{1}{2}$$

$$\therefore \quad \frac{1}{2} = a \times 1$$

$$\therefore \quad a = \frac{1}{2}$$

$$\text{and} \quad y = \frac{1}{2}x^2$$

For the coordinates of P and S consider

$$\frac{1}{2}x^2 = 2$$

$$x^2 = 4$$

$$x = \pm 2$$

The coordinates of S are $(2, 2)$ and the coordinates of P are $(-2, 2)$.

ii

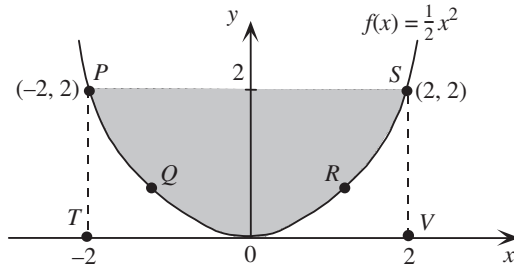

$$\text{Area of shaded region} = \text{Area}_{PTVS} - \int_{-2}^2 f(x) dx$$

$$= 4 \times 2 - \int_{-2}^2 \frac{1}{2} x^2 dx$$

$$= 8 - \frac{1}{2} \left[\frac{1}{3} x^3 \right]_{-2}^2$$

$$= 8 - \frac{1}{6} [(2)^3 - (-2)^3]$$

$$\therefore \text{Area} = 8 - \frac{1}{6}(8 + 8)$$

$$= 8 - \frac{8}{3}$$

$$= \frac{16}{3}$$

$$= 5\frac{1}{3}$$

Area of the shaded region is $5\frac{1}{3}$ square metres.

- 8 a **TI:** Enter the coordinate points into a new Lists & Spreadsheet application as shown right. Press **Menu**→**4:Statistics**→**1:Stat Calculations**→**7:Cubic Regression** and set **X List** to *x* and **Y List** to *y* then ENTER.

A	B	C	D
x	y		
0	60		
300	96		
700	15.2		
800	0		

CP: Enter the coordinate points into a new Statistics application. Tap **Calc**→**Cubic Reg** and set **XList** to **list1** and **YList** to **list2** then **EXE**.

	x	y		
1			RegEqn	a*x^3+b*x^2+c*x+d
2	300	96	a	0.000000...
3	700	15.2	b	-0.00116
4	800	0	c	0.405
5			d	60.

$$y = (7 \times 10^{-7})x^3 - 0.00116x^2 + 0.405x + 60$$

- b TI:** Open a Data & Statistics application. Add the variable x to the horizontal and the variable y to the vertical. Press **Menu**→**4:Analyze**→**6:Regression**→**5:Show Cubic**. Now Press **Menu**→**4:Analyze**→**A:Graph Trace** and move the cursor to the maximum to find the maximum height of 100 metres, to the nearest metre.

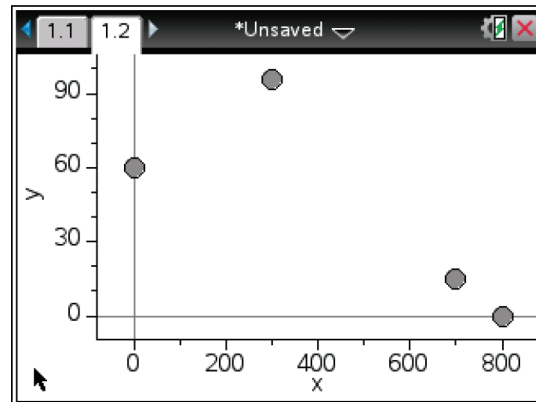

CP: After completing part **a**, the graph will be shown on the screen. Tap **Analysis**→**Trace** and move the cursor to the maximum to find the maximum height of 100 metres, to the nearest metre.

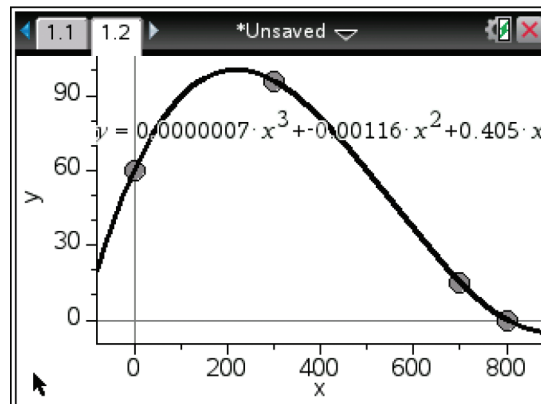

- c i **TI:** In a Calculator application press **Menu**→**1:Actions**→**1:Define**. Type $f(x) = 7 \times 10^{-7}x^3 - .00116x^2 + .405x + 60$ then ENTER. Using the mathematical template tool select the derivative template and complete as follows:

$$\frac{d}{dx}(f(x))$$

In a Graphs application input

$$\frac{d}{dx}(f(x)) \text{ into } f1(x) = \text{ then ENTER}$$

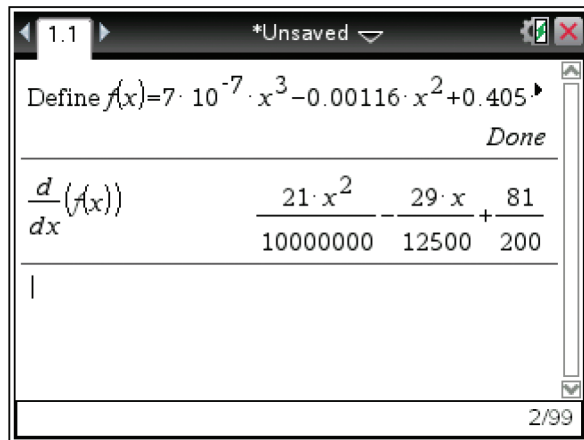
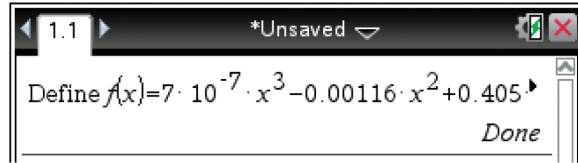

- CP:** In the Main application tap **Action**→**Command**→**Define** and type $f(x) = 7 \times 10^{-7}x^3 - .00116x^2 + .405x + 60$ then EXE. In the Graph & Table application type $\frac{d}{dx}(f(x))$ into y1 then EXE.

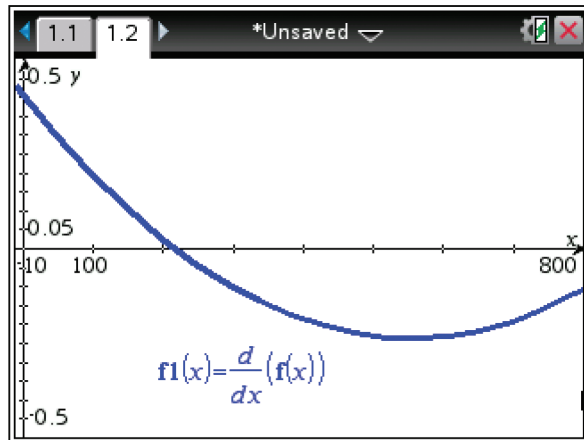

- ii The gradient is greatest when $x = 0$, and is 0.405, at the point with coordinates (0, 60).

- d Sketch the graph of $f_1(x) = f(x)$.
TI: Press **Menu**→**6:Analyze**
Graph→**7:Integral**. Enter 0 as the lower limit and 800 as the upper limit.

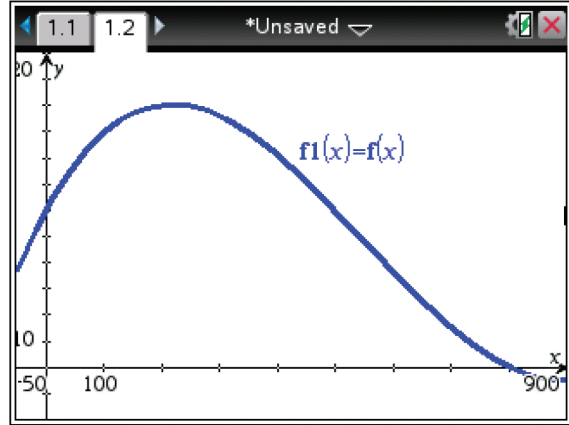

- CP:** Tap **Analysis**→**G-Solve**→ $\int dx$.
 Enter 0 as the lower limit and 800 as the upper limit.
 The cross-sectional area is $51\,307\text{ m}^2$, to the closest square metre.

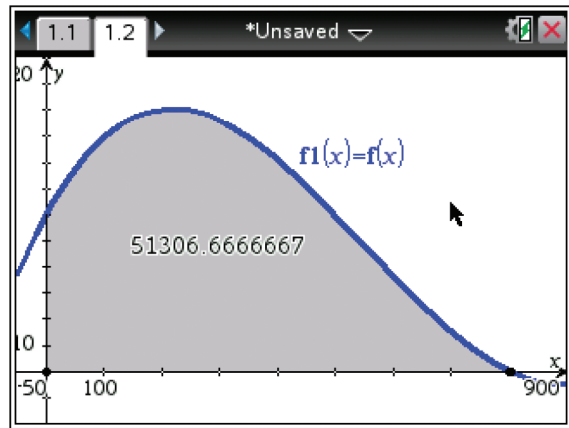

- 9 a **TI:** Type $\int_0^x 2^t dt$ into $f_1(x)$ using the mathematical template tool.
CP: Type $\int_0^x 2^t dt$ into y_1 using the 2D template tool.

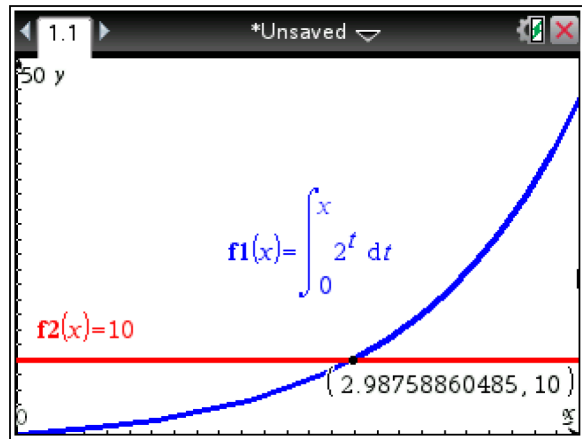

b Sketch the graph of $f(x) = 10$.

TI: Press **Menu**→**6:Analyze**

Graph→**4:Intersection**

CP: Tap **Analysis**→

G-Solve→**Intersect**

to find that $\int_0^x f(t)dt = 10$ is satisfied by $x = 2.988$, correct to 3 decimal places.

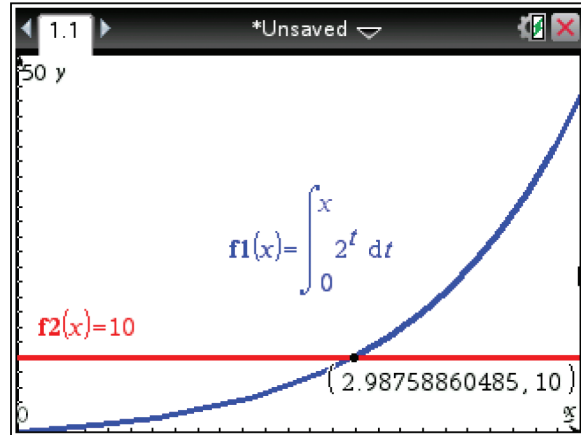

Alternatively, in the Calculator

screen type **solve** ($\int_0^x 2^t dt = 10, x$)

to give

$x = \frac{\ln(10 \ln(2) + 1)}{\ln(2)} = 2.988$,
correct to 3 decimal places.

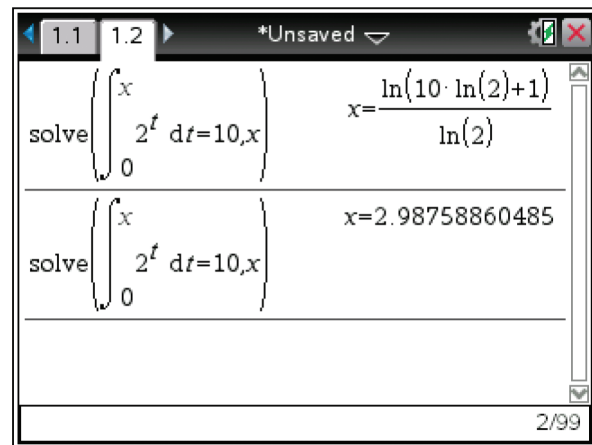

Chapter 22 – Revision of chapters 20–21

Solutions to Technology-free questions

1 a Left-endpoint estimate $f(0) = 1$, $f(1) = \frac{1}{2}$, $f(2) = \frac{1}{3}$, $f(3) = \frac{1}{4}$
 Left-endpoint estimate $= 1 + \frac{1}{2} + \frac{1}{3} + \frac{1}{4} = \frac{25}{12}$

b Right-endpoint estimate
 $f(1) = \frac{1}{2}$, $f(2) = \frac{1}{3}$, $f(3) = \frac{1}{4}$, $f(4) = \frac{1}{5}$
 Right-endpoint estimate $= \frac{1}{2} + \frac{1}{3} + \frac{1}{4} + \frac{1}{5} = \frac{77}{60}$

c Trapezoidal estimate
 Trapezoidal estimate $= \frac{1}{2}(1 + \frac{1}{2}) + \frac{1}{2}(\frac{1}{2} + \frac{1}{3}) + \frac{1}{2}(\frac{1}{3} + \frac{1}{4}) + \frac{1}{2}(\frac{1}{4} + \frac{1}{5}) = \frac{101}{60}$

2 a Let $y = 3x^{\frac{3}{2}}$
 $\frac{dy}{dx} = 3 \times \frac{3}{2}x^{\frac{1}{2}} = \frac{9}{2}x^{\frac{1}{2}}$

b Let $y = \sqrt[5]{x} = x^{\frac{1}{5}}$
 $\frac{dy}{dx} = \frac{1}{5}x^{-\frac{4}{5}}$

c Let $y = -\frac{2}{x^{\frac{5}{3}}} = -2x^{-\frac{5}{3}}$
 $\frac{dy}{dx} = -2 \times -\frac{5}{3}x^{-\frac{8}{3}} = \frac{10}{3}x^{-\frac{8}{3}}$

d Let $y = 6x^{\frac{5}{3}}$
 $\frac{dy}{dx} = 6 \times \frac{5}{3}x^{\frac{2}{3}} = 10x^{\frac{2}{3}}$

e Let $y = x^{-\frac{1}{5}}$

$$\frac{dy}{dx} = -\frac{1}{5}x^{-\frac{6}{5}}$$

f Let $y = x^{-\frac{2}{3}} - 2x^{\frac{3}{2}}$
 $\frac{dy}{dx} = -\frac{2}{3}x^{-\frac{5}{3}} - 3x^{\frac{1}{2}}$

3 a Let $y = (3x + 5)^2$ Let $u = 3x + 5$.
 Then $y = u^2$
 $\frac{dy}{dx} = \frac{dy}{du} \frac{du}{dx}$
 $= 2u \times 3$
 $= 6u$
 $= 6(3x + 5)$

b Let $y = -(2x + 7)^4$
 Let $u = 2x + 7$. Then $y = -u^4$
 $\frac{dy}{dx} = \frac{dy}{du} \frac{du}{dx}$
 $= -4u^3 \times 2$
 $= -8u^3$
 $= -8(2x + 7)^3$

c Let $y = (5 - 2x)^{-\frac{1}{3}}$ Let $u = 5 - 2x$.
 Then $y = u^{-\frac{1}{3}}$
 $\frac{dy}{dx} = \frac{dy}{du} \frac{du}{dx}$
 $= -\frac{1}{3}u^{-\frac{4}{3}} \times (-2)$
 $= \frac{2}{3}u^{-\frac{4}{3}}$
 $= \frac{2}{3}(5 - 2x)^{-\frac{4}{3}}$

d Let $y = \frac{4}{5 + 3x} = 4(5 + 3x)^{-1}$
 Let $u = 5 + 3x$. Then $y = u^{-1}$

$$\begin{aligned}\frac{dy}{dx} &= \frac{dy}{du} \frac{du}{dx} \\ &= -4u^{-2} \times (3) \\ &= -12u^{-2} \\ &= -12(5 + 3x)^{-2}\end{aligned}$$

e Let $y = \frac{1}{(x-1)^{\frac{2}{3}}}$
Let $u = x - 1$. Then $y = \frac{1}{u^{\frac{2}{3}}} = u^{-\frac{2}{3}}$

$$\begin{aligned}\frac{dy}{dx} &= \frac{dy}{du} \frac{du}{dx} \\ &= -\frac{2}{3}u^{-\frac{5}{3}} \times 1 \\ &= -\frac{2}{3}u^{-\frac{5}{3}} \\ &= -\frac{2}{3}(x-1)^{-\frac{5}{3}}\end{aligned}$$

f Let $y = \frac{3}{\sqrt{2+3x^2}} = -(2+3x^2)^{-\frac{1}{2}}$

Let $u = (2+3x^2)$. Then $y = 3u^{-\frac{1}{2}}$

$$\begin{aligned}\frac{dy}{dx} &= \frac{dy}{du} \frac{du}{dx} \\ &= -\frac{3}{2}u^{-\frac{3}{2}} \times 6x \\ &= 9xu^{-\frac{3}{2}} \\ &= 9x(2+3x^2)^{-\frac{3}{2}}\end{aligned}$$

g Let $y = \left(2x^3 - \frac{5}{x}\right)^{\frac{1}{3}}$

$$\frac{dy}{dx} = \frac{1}{3}\left(2x^3 - \frac{5}{x}\right)^{-\frac{2}{3}}\left(6x^2 + \frac{5}{x^2}\right)$$

4 $\frac{dx}{dt} = t + 4 - \frac{3}{t^2}$
 $\therefore x = \frac{t^2}{2} + 4t + \frac{3}{t} + c$
When $x = 6, t = 1$
 $\therefore 6 = \frac{1}{2} + 4 + 3 + c$

$$\begin{aligned}\therefore c &= -\frac{3}{2} \\ \therefore x &= \frac{t^2}{2} + 4t + \frac{3}{t} - \frac{3}{2}\end{aligned}$$

5 a $y = x^{\frac{1}{3}}$
 $\frac{dy}{dx} = \frac{1}{3}x^{-\frac{2}{3}}$
 \therefore gradient of tangent at $x = 27$ is $\frac{1}{27}$

b $y = \frac{1}{3x+1}$
 $\frac{dy}{dx} = -\frac{1}{(3x+1)^2}$
 \therefore gradient of tangent at $x = 0$ is -3

c $y = \frac{2}{x^3}$
 $\frac{dy}{dx} = -\frac{6}{x^4}$
 \therefore gradient of tangent at $x = 2$ is $-\frac{3}{8}$

6 $y = \frac{1}{x^2}$
 $\frac{dy}{dx} = -\frac{2}{x^3}$
When $\frac{dy}{dx} = 4, -\frac{2}{x^3} = 4$
Therefore $y = \frac{1}{x^2}$ has gradient 4 at the point $\left(-\left(\frac{1}{2}\right)^{\frac{1}{3}}, 4^{\frac{1}{3}}\right)$

7 $y = \sqrt[3]{x} = x^{\frac{1}{3}}$
 $\frac{dy}{dx} = \frac{1}{3}x^{-\frac{2}{3}}$
When $\frac{dy}{dx} = 2, \frac{1}{3}x^{-\frac{2}{3}} = 2$
Therefore $y = \sqrt[3]{x}$ has gradient 2 at the points $\left(\left(\frac{1}{6}\right)^{\frac{3}{2}}, \left(\frac{1}{6}\right)^{\frac{1}{2}}\right)$ and $\left(-\left(\frac{1}{6}\right)^{\frac{3}{2}}, -\left(\frac{1}{6}\right)^{\frac{1}{2}}\right)$

$$8 \text{ a } \int 3x^2 + 1 \, dx = x^3 + x + c$$

$$8 \text{ b } \int (t+1)(2-3t) \, dt = \int -3t^2 - t + 2 \, dt \\ = -t^3 - \frac{t^2}{2} + 2t + c$$

$$8 \text{ c } \int \sqrt{x} \, dx = \int x^{\frac{1}{2}} \, dx \\ = \frac{2}{3}x^{\frac{3}{2}} + c$$

$$8 \text{ d } \int 2x^{\frac{3}{2}} + x^{\frac{1}{3}} \, dx = \frac{4}{5}x^{\frac{5}{2}} + \frac{3}{4}x^{\frac{4}{3}} + c$$

$$9 \text{ a } \int_1^3 x^{-2} \, dx = \left[-x^{-1} \right]_1^3 \\ = -\frac{1}{3} + 1 \\ = \frac{2}{3}$$

$$9 \text{ b } \int_{-3}^{-2} (1 - x^{-2}) \, dx = \left[x + x^{-1} \right]_{-3}^{-2} \\ = \left(-2 - \frac{1}{2} \right) - \left(-3 - \frac{1}{3} \right) \\ = \frac{5}{6}$$

$$10 \text{ a } \int_1^2 (-x^2 + 3x - 2) \, dx = \left[-\frac{x^3}{3} + \frac{3x^2}{2} - 2x \right]_1^2 \\ = \left(-\frac{8}{3} + 6 - 4 \right) - \left(-\frac{1}{3} + \frac{3}{2} - 2 \right) \\ = \frac{1}{6}$$

10 b Two regions - one positive and one negative

$$\int_0^1 (x^3 - 3x^2 + 2x) \, dx = \left[\frac{x^4}{4} - x^3 + x^2 \right]_0^1 \\ = \left(\frac{1}{4} - 1 + 1 \right) - (0) \\ = \frac{1}{4}$$

$$\int_1^2 (x^3 - 3x^2 + 2x) \, dx = \left[\frac{x^4}{4} - x^3 + x^2 \right]_1^2 \\ = (4 - 8 + 4) - \left(\frac{1}{4} - 1 + 1 \right) \\ = -\frac{1}{4}$$

$$\text{Total area} = \frac{1}{2}$$

Solutions to multiple-choice questions

$$\begin{aligned} 1 \text{ E} \quad f(x) &= (9x^2 + 4)^{\frac{1}{2}} \\ \therefore f'(x) &= \frac{1}{2}(18x)(9x^2 + 4)^{-\frac{1}{2}} \\ &= 9x(9x^2 + 4)^{-\frac{1}{2}} \end{aligned}$$

$$\begin{aligned} 2 \text{ C} \quad f(x) &= (3x^2 - 7)^4 \\ \therefore f'(x) &= 4(6x)(3x^2 - 7)^3 \\ &= 24x(3x^2 - 7)^3 \end{aligned}$$

$$3 \text{ E} \quad \frac{d}{dx} \frac{2}{3+x} = -\frac{2}{(3+x)^2}$$

$$\begin{aligned} 4 \text{ D} \quad \frac{d}{dx} \frac{x-1}{\sqrt{x}} &= \frac{d}{dx} (x^{\frac{1}{2}} - x^{\frac{3}{2}}) \\ &= \frac{1}{2}x^{-\frac{1}{2}} + \frac{1}{2}x^{-\frac{3}{2}} \\ &= \frac{x+1}{2x\sqrt{x}} \end{aligned}$$

$$5 \text{ A} \quad \int 3x^2 + 6dx = x^3 + 6x + c$$

$$\begin{aligned} 6 \text{ A} \quad \int_1^3 x - 2dx &= \left[\frac{1}{2}x^2 - 2x \right]_1^3 \\ &= \frac{1}{2}(3^2 - 1^2) - 2(3 - 1) = 0 \\ &= 0 \end{aligned}$$

$$\begin{aligned} 7 \text{ E} \quad g'(x) &= f(x) \\ \therefore g(x) &= \int f(x) dx \\ \therefore \int_1^3 f(x) dx &= g(3) - g(1) \end{aligned}$$

8 C

$$\begin{aligned} f(x) &= x(x+2) = x^2 + 2x \\ A &= \int_0^1 x^2 + 2xdx - \int_{-2}^0 x^2 + 2xdx \\ &= \int_0^1 x^2 + 2xdx + \int_0^{-2} x^2 + 2xdx \end{aligned}$$

$$\begin{aligned} 9 \text{ E} \quad \int_1^4 5f(x) + 2 dx &= 5 \int_1^4 f(x) dx + \int_1^4 2dx \\ &= 5 \int_1^4 f(x) dx + 6 \end{aligned}$$

$$\begin{aligned} 10 \text{ C} \quad \int_0^1 k(1-x^2) dx &= 40 \\ \therefore (1-0) - \frac{1}{3}(1^3-0) &= \frac{40}{k} \\ \frac{40}{k} &= \frac{2}{3} \\ k &= 60 \end{aligned}$$

$$\begin{aligned} 11 \text{ B} \quad y &= 5x - x^2 < \therefore y(1) = y(4) = 4 \\ \text{Rectangle has area} &= 4(3) = 12 \\ A &= \int_1^4 5x - x^2 dx - 12 \\ &= \left[\frac{5}{2}x^2 - \frac{1}{3}x^3 \right]_1^4 \\ &= \frac{5}{2}(4^2 - 1^2) - \frac{1}{3}(4^3 - 1^3) - 12 \\ &= \frac{75}{2} - \frac{63}{3} - 12 \\ &= 4.5 \end{aligned}$$

$$\begin{aligned} 12 \text{ C} \quad \int 4x^2(2x+1)dx &= \int 8x^3 + 4x^2 dx \\ &= 2x^4 + \frac{4}{3}x^3 + c \end{aligned}$$

$$13 \text{ C} \quad A = \int_0^3 f(x) dx - \int_3^7 f(x) dx$$

Chapter 25 – Mathematical Methods

Units 1 and 2

Revision of Chapters 1-22 Solutions

Solutions to Technology-free questions

1 $2x + 3(4 - x) = 8$

$$2x + 12 - 3x = 8$$

$$-x = -4$$

$$x = 4.$$

2 $\frac{at + b}{ct + d} = 2$

$$at + b = 2ct + 2d$$

$$(a - 2c)t = 2d - b$$

$$t = \frac{2d - b}{a - 2c}.$$

3 $\frac{4x}{3} - 4 \leq 2x - 3$

$$-4 + 3 \leq 2x - \frac{4x}{3}$$

$$-1 \leq \frac{2x}{3}$$

$$-3 \leq 2x$$

$$x \geq \frac{3}{2}.$$

4 a For $x - y$ to be as small as possible choose the smallest possible value of x and the largest possible value of y .

Thus take $x = -4$ and $y = 8$.

Hence the smallest value of $x - y$ is -12 .

b The largest possible value of $\frac{x}{y}$ is achieved by making x as large as possible and y as small as possible. Thus take $x = 6$ and $y = 2$.

Hence the largest value of $\frac{x}{y}$ is 3 .

c The largest possible value of $x^2 + y^2$ is obtained by choosing values of the largest magnitude for both x and y .

Thus take $x = 6$ and $y = 8$.

Hence the largest possible value of $x^2 + y^2$ is 100.

5 Let x be the number of the first type book and y be the number of the other type of book.

There is a total of 20 books. So

$$x + y = 20 \quad (1)$$

There is total cost of \$720. So

$$72x + 24y = 720 \quad (2)$$

Multiply equation (1) by 24.

$$24x + 24y = 480 \quad (3)$$

Subtract equation (3) from equation (2).

$$48x = 240$$

$$x = 5.$$

Hence $x = 5$ and $y = 15$.

There were 5 of one type of book and 15 of the other.

$$6 \quad \frac{1 - 5x}{3} \geq -12$$

$$1 - 5x \geq -36$$

$$-5x \geq -37$$

$$x \leq \frac{37}{5}.$$

$$7 \quad a = \frac{y^2 - xz}{10}$$

When $x = -5$, $y = 7$ and $z = 6$,

$$a = \frac{7^2 + 5 \times 6}{10}$$

$$= \frac{79}{10}.$$

$$8 \quad \text{a Midpoint } M(xy): x = \frac{8 + a}{2} \text{ and } y = \frac{14 + b}{2}$$

b If $(5, 10)$ is the midpoint,

$$\frac{8 + a}{2} = 5 \text{ and } \frac{14 + b}{2} = 10. \text{ Hence } a = 2 \text{ and } b = 6.$$

- 9 a** The line passes through $A(-2, 6)$ and $B(10, 15)$.

Using the form $y - y_1 = m(x - x_1)$,

$$\begin{aligned} m &= \frac{15 - 6}{10 - (-2)} \\ &= \frac{9}{12} \\ &= \frac{3}{4} \end{aligned}$$

The equation is thus,

$$y - 6 = \frac{3}{4}(x + 2)$$

Simplifying,

$$4y - 24 = 3x + 6$$

$$4y - 3x = 30.$$

- b** When $x = 0, y = \frac{15}{2}$

When $y = 0, x = -10$

By Pythagoras's theorem,

$$\begin{aligned} \text{the length of } PQ &= \sqrt{(-10 - 0)^2 + \left(0 - \frac{15}{2}\right)^2} \\ &= \sqrt{100 + \left(-\frac{225}{4}\right)} \\ &= \sqrt{\frac{625}{4}} \\ &= \frac{25}{2}. \end{aligned}$$

- 10 a** $A = (-7, 6)$ and $B = (11, -5)$.

The midpoint $M(x, y)$ of AB has coordinates,

$$x = \frac{-7 + 11}{2} \text{ and } y = \frac{6 + (-5)}{2}$$

The midpoint is $M\left(2, \frac{1}{2}\right)$.

- b** The distance between A and $B = \sqrt{(11 - (-7))^2 + (-5 - 6)^2}$
- $$\begin{aligned} &= \sqrt{18^2 + 11^2} \\ &= \sqrt{324 + 121} \\ &= \sqrt{445} \end{aligned}$$

c The equation of AB .

$$\text{Gradient, } m = \frac{-5 - 6}{11 - (-7)} = -\frac{11}{18}.$$

Using the form $y - y_1 = m(x - x_1)$.

$$y - 6 = -\frac{11}{18}(x + 7)$$

Simplifying,

$$18y - 108 = -11x - 77.$$

$$18y + 11x = 31.$$

d The gradient of a line perpendicular to line AB is $\frac{18}{11}$.

The midpoint of AB is $M\left(2, \frac{1}{2}\right)$.

Using the form $y - y_1 = m(x - x_1)$.

$$y - \frac{1}{2} = \frac{18}{11}(x - 2)$$

$$22y - 11 = 36x - 72$$

$$22y - 36x + 61 = 0.$$

11

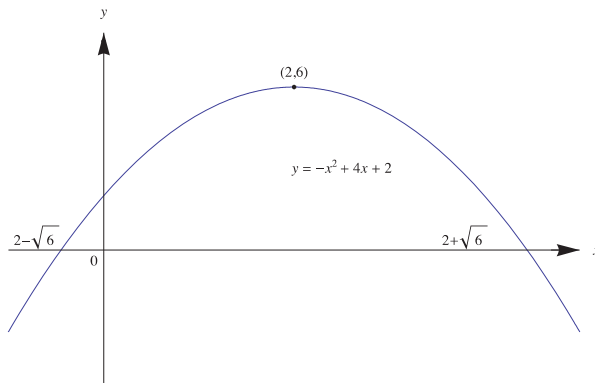

12 A parabola has turning point $(2, -6)$.

It has equation of the form $y = k(x - 2)^2 - 6$.

It passes through the point $(6, 12)$.

Hence,

$$12 = k(4)^2 - 6$$

$$18 = 16k$$

$$k = \frac{9}{8}.$$

Hence the equation is $y = \frac{9}{8}(x - 2)^2 - 6$.

13 Let $P(x) = ax^3 + 4x^2 + 3$. It has remainder 3 when divided by $x - 2$.

The remainder theorem gives us that:

$$P(2) = 3.$$

$$\text{That is, } 3 = 8a + 16 + 3.$$

$$\text{Hence } a = -2.$$

14

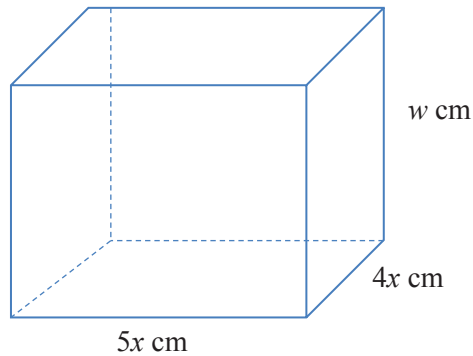

a The length of the wire is 6000 cm.

$$\text{We have: } 4 \times 5x + 4 \times 4x + 4w = 6000$$

$$5x + 4x + w = 1500$$

$$w = 1500 - 9x.$$

b Let $V \text{ cm}^3$ be the volume of cuboid.

$$V = 5x \times 4x \times w$$

$$= 20x^2(1500 - 9x)$$

c We have $0 \leq x \leq \frac{500}{3}$ since $w = 1500 - 9x > 0$.

d If $x = 100$, $V = 20 \times 100^2(1500 - 9 \times 100)$

$$= 200\,000 \times 600$$

$$= 120\,000\,000 \text{ cm}^3$$

15 a Probability of both red = $\frac{4}{9} \times \frac{4}{9} = \frac{16}{81}$.

b Probability of both red = $\frac{4}{9} \times \frac{7}{17} = \frac{28}{153}$.

16

	Box 1			
Box 2		1	3	5
	2	3	5	7
	4	5	7	9
	6	7	9	11

Sample space = {3, 5, 7, 9, 11}

The outcomes are not equally likely.

$$\Pr(\text{divisible by 3}) = \frac{1}{3}.$$

17 There are six letters and three vowels.

a The probability that the letter withdrawn is a vowel = $\frac{1}{2}$.

b The probability that the letter is a vowel is $\frac{1}{3}$.

18 This can be done simply by considering the cases.

SSF or SFF are the only two possibilities.

$$\begin{aligned} \text{The probability of fruit on Wednesday} &= 0.4 \times 0.6 + 0.6 \times 0.3 \\ &= 0.24 + 0.18 \\ &= 0.42. \end{aligned}$$

19 Solve $\cos(3x) = \frac{1}{2}$ for $x \in [-\frac{\pi}{2}, \frac{\pi}{2}]$

$$\begin{aligned} 3x &= \dots, -\frac{7\pi}{3}, -\frac{5\pi}{3}, -\frac{\pi}{3}, \frac{\pi}{3}, \frac{5\pi}{3}, \frac{7\pi}{3}, \dots \\ x &= -\frac{\pi}{9}, \frac{\pi}{9}. \end{aligned}$$

20 The graph of $y = ax^3 + bx + c$ has intercepts (0,6) and (-2, 0) and has a stationary point where $x = 1$.

$$\frac{dy}{dx} = 3ax^2 + b.$$

a The graph passes through (0,6). Therefore $6 = c$.

b The graph passes through (-2, 0). Therefore

$$0 = -8a - 2b + 6 \quad (1)$$

There is a stationary point where $x = 1$. Therefore

$$0 = 3a + b \quad (2)$$

c Multiply (2) by 2.

$$0 = 6a + 2b \quad (3)$$

Add equations (1) and (3).

$$0 = -2a + 6$$

Therefore $a = 3$. Substitute in (2) to find $b = -9$.

21 $y = x^4$ and so $\frac{dy}{dx} = 4x^3$.

The gradient of the line $y = -32x + a$ is -32 .

$$4x^3 = -32 \text{ implies } x^3 = -8.$$

Hence $x = -2$

For $y = x^4$, when $x = -2$, $y = 16$.

Therefore for the tangent $y = -32x + a$,

$$16 = -32 \times (-2) + a.$$

Hence $a = -48$.

22 $f: [-\pi, \pi] \rightarrow R, f(x) = 4 \cos(2x)$.

a Period = $\frac{2\pi}{2} = \pi$

Amplitude = 4

b

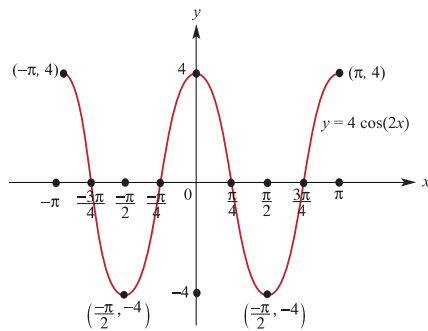

23 a The first ball can be any ball except 1. The probability of a 3, 5 or 7 is $\frac{3}{4}$.
There are 3 balls left and the probability of obtaining the white ball is $\frac{1}{3}$.

$$\text{The probability of white on the second} = \frac{3}{4} \times \frac{1}{3} = \frac{1}{4}.$$

b The sum of 8 can be obtained from the following ordered pairs: (1, 7), (7, 1), (3, 5), (5, 3).

$$\text{The probability of each of these pairs} = \frac{1}{4} \times \frac{1}{3} = \frac{1}{12}.$$

$$\text{Therefore the probability of obtaining a sum of 8} = 4 \times \frac{1}{12} = \frac{1}{3}$$

c We can see that for a sum of 8 we must only consider the pairs (1, 7), (7, 1), (3, 5), (5, 3). The probability that the second is 1 is $\frac{1}{4}$.

24 The line $y = x + 1$ cuts the circle $x^2 + y^2 + 2x - 4y + 1 = 0$ at the points A and B.

To find the points of intersection:

$$y = x + 1 \quad (1)$$

$$x^2 + y^2 + 2x - 4y + 1 = 0 \quad (2)$$

Substitute from (1) into (2)

$$x^2 + (x + 1)^2 + 2x - 4(x + 1) + 1 = 0$$

$$x^2 + x^2 + 2x + 1 + 2x - 4x - 4 + 1 = 0$$

$$2x^2 - 2 = 0$$

$$2(x^2 - 1) = 0$$

$$x = 1 \text{ or } x = -1$$

The points of intersection are A(1, 2) and B(-1, 0).

a The midpoint of AB = (0, 1).

b

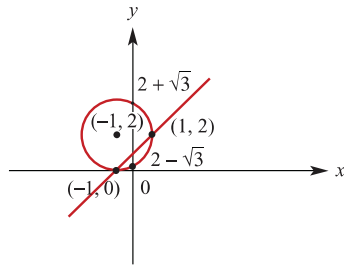

25 a $4^x - 5 \times 2^x - 24 = 0$.

Let $a = 2^x$.

The equation becomes.

$$a^2 - 5a - 24 = 0$$

$$(a - 8)(a + 3) = 0$$

$$a = 8 \text{ or } a = -3.$$

Now $2^x > 0$ for all x and so there are no solutions of $2^x = -3$.

$2^x = 8$ implies $x = 3$.

b $2^{5-3x} = -4^{x^2} = 0$

$$2^{5-3x} = 2^{2x^2}$$

We note that if $2^a = 2^b$ then $a = b$.

Hence,

$$5 - 3x = 2x^2$$

$$2x^2 + 3x - 5 = 0$$

$$(2x + 5)(x - 1) = 0.$$

$$\text{So, } x = -\frac{5}{2} \text{ or } x = 1.$$

- 26 $\frac{dy}{dx} = -4x + k$, where k is a constant. Stationary point at $(1, 5)$.

$$\frac{dy}{dx} = 0 \text{ when } x = 1.$$

$$0 = -4 + k$$

$$k = 4$$

Thus,

$$\frac{dy}{dx} = -4x + 4$$

Integrating with respect to x .

$$y = -2x^2 + 4x + c.$$

When $x = 1$, $y = 5$.

Hence,

$$5 = -2 + 4 + c$$

$$c = 3.$$

The equation is $y = -2x^2 + 4x + 3$.

- 27 $y = ax^3 - 2x^2 - x + 7$ has a gradient of 4, when $x = -1$.

$$\frac{dy}{dx} = 3ax^2 - 4x - 1.$$

Therefore,

$$4 = 3a + 4 - 1$$

$$a = \frac{1}{3}.$$

- 28 Let $\begin{bmatrix} 3 & 0 \\ 0 & -2 \end{bmatrix} \begin{bmatrix} x \\ y \end{bmatrix} = \begin{bmatrix} x' \\ y' \end{bmatrix}$

Hence $x' = 3x$ and $y' = -2y$.

$$\text{Thus } x = \frac{x'}{3} \text{ and } y = -\frac{y'}{2}.$$

$$\text{Therefore } y = x^2 \text{ maps to } -\frac{y}{2} = \frac{x^2}{9}.$$

$$\text{That is } y = -\frac{2x^2}{9}.$$

- 29** Let $P(x) = 3x^2 + x + 10$.
 $P(-b) = 3b^2 - b + 10$ and $P(2b) = 12b^2 + 2b + 10$.
 By the remainder theorem,
 $3b^2 - b + 10 = 12b^2 + 2b + 10$
 $9b^2 + 3b = 0$
 $3b(3b + 1) = 0$.
 Hence, $b = -\frac{1}{3}$.

- 30** $y = x^3$ and $y = x^3 + x^2 + 6x + 9$

The curves meet where

$$x^3 = x^3 + x^2 + 6x + 9.$$

That is,

$$0 = (x + 3)^2$$

Thus $x = -3$ and $y = -27$.

For the first curve,

$$\frac{dy}{dx} = 3x^2$$

and the second,

$$\frac{dy}{dx} = 3x^2 + 2x + 6.$$

When $x = -3$, $\frac{dy}{dx} = 27$ for the first curve.

When $x = -3$, $\frac{dy}{dx} = 27$ for the second curve.

There is a common tangent to the two curves.

- 31 a** $y = x^3 - 75x - 10$

$$\frac{dy}{dx} = 3x^2 - 75 = 3(x^2 - 25).$$

Stationary points occur when $x = 5$ or $x = -5$

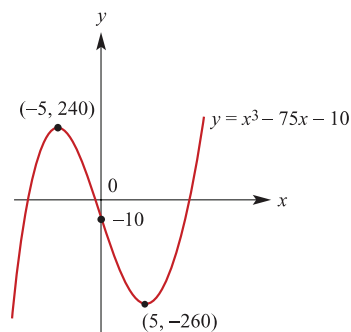

Note that the graph crosses the y-axis at -10 .

- b** $x^3 - 75x - 10 = p$ has more than one real solution when the line with equation $y = p$ crosses the graph of $y = x^3 - 75x - 10$ more than once.

This is true when $-260 \leq p \leq 240$.

- 32 a** Maximal domain $R \setminus \{3\}$.
- b** Maximal domain $R \setminus \{2\}$.
- c** Maximal domain $(-\infty, 2]$
- d** Maximal domain $[4, \infty)$
- e** Maximal domain $(-\infty, 5)$

Solutions to multiple-choice questions

1 B Period = $2\pi \div \frac{1}{4} = 8\pi$
Amplitude = 5

2 A $f(x) = x^2 + 2x$
Average rate of change for the interval $[0, 3]$ = $\frac{f(3) - f(0)}{3 - 0}$
= $\frac{15 - 0}{3}$
= 5

3 D $f: [1, 4) \rightarrow R, f(x) = (x - 2)^2 + 3$.
End points: $f(1) = 4$ and $f(4) = 7$.
The minimum value = $f(2) = 3$.
The range = $[3, 7)$.

4 D A function g with domain R has the following properties:

- $g'(x) = 3x^2 - 4x$
- the graph of $y = g(x)$ passes through the point $(1, 0)$

Taking the anti-derivative of g with respect to x :

$$g(x) = x^3 - 2x + c.$$

Also $g(1) = 0$,

so $0 = -1 + c$

$$c = 1.$$

Hence $g(x) = x^3 - 2x + 1$.

5 D Simultaneous equations

$$(m - 2)x + y = 0 \quad (1)$$

$$2x + (m - 3)y = 0 \quad (2)$$

Gradient of line (1) = $2 - m$

Gradient of line (2) = $\frac{2}{3 - m}$

Infinitely many solutions implies $2 - m = \frac{2}{3 - m}$.

$$\text{Hence } (2 - m)(3 - m) = 2$$

$$6 - 5m + m^2 = 2$$

$$m^2 - 5m + 4 = 0$$

$$(m - 1)(m - 4) = 0$$

$$m = 4 \text{ or } m = 1.$$

Both lines go through the origin and so there are infinitely many solutions for $m = 4$ or $m = 1$.

6 C $f(x) = 2 \log_e(3x)$. If $f(5x) = \log_e(y)$

First $f(5x) = 2 \log_e(15x)$.

Hence $2 \log_e(15x) = \log_e(y)$

Thus $y = 15x^2 = 225x^2$.

7 C A bag contains 2 white balls and 4 black balls. Three balls are drawn from the bag without replacement.

Probability of black on the first = $\frac{2}{3}$.

There are now 2 white balls and 3 black balls.

Probability black on the second = $\frac{3}{5}$.

There are now 2 white balls and 2 black balls.

Probability of black on the third = $\frac{1}{2}$.

Probability of three black = $\frac{2}{3} \times \frac{3}{5} \times \frac{1}{2} = \frac{1}{5}$

8 A $f: R \rightarrow R, f(x) = \frac{1}{3}x^3 - 2x^2 + 1$

$f'(x) = x^2 - 4x = x(x - 4)$

$f'(x) < 0$ if and only if $x(x - 4) < 0$.

This happens when the factors have different signs:

So either,

$x < 0$ and $x > 4$ or $x > 0$ and $x < 4$.

Only the second of these is possible.

Hence $0 < x < 4$.

This can also be seen by looking at the graph of $y = f'(x)$.

9 B $f(x) = \sqrt{2x + 1}$ is defined for $2x + 1 \geq 0$.

That is the maximal domain of f is $x \geq -\frac{1}{2}$.

In interval notation $[-\frac{1}{2}, \infty)$.

10 A In algebraic notation, 11 is four times 9 more than x is written as $11 = 4(x + 9)$

11 B Time taken by the car = $\frac{120}{a}$ hours.

Time taken by the train = $\frac{120}{a-4}$.

Time taken by the train = time taken by the car + 1.

Therefore,

$$\frac{120}{a-4} = \frac{120}{a} + 41$$

Multiplying both sides of the equation by $a(a-4)$ we have,

$$120a = 120(a-4) + a(a-4)$$

$$120a = 120a - 480 + a^2 - 4a$$

$$0 = a^2 - 4a - 480$$

$$0 = (a-24)(a+20)$$

Therefore $a = 24$ or $a = -20$.

But we assume positive speed.

12 A The parabola that passes through the point $(-3, 12)$ and has its vertex at $(-2, 8)$ has equation of the form:

$$y = k(x+2)^2 + 8.$$

It passes through the point $(-3, 12)$.

Hence,

$$12 = k(-1)^2 + 8$$

$$k = 4.$$

The equation is

$$y = 4(x+2)^2 + 8.$$

13 A $f: [-3, 5) \rightarrow R, f(x) = 5 - 2x$.

The graph of f is a straight line with negative gradient.

$$f(-3) = 11 \text{ and } f(5) = -5.$$

The range is $(-5, 11]$

14 E $f: [-3, 2) \rightarrow R, f(x) = 2x^2 + 7$.

The graph is a parabola with a minimum at $(0, 7)$.

$$f(-3) = 25 \text{ and } f(2) = 15.$$

The range is $[7, 25]$

15 B For (A), $y = 11x(x-1)$. It has a turning point at $x = \frac{1}{2}$. It is increasing on the given interval. Therefore, one-to-one.

For (B), $y = \sqrt{11-x^2}$. The function has the same value for 1 and -1 for example.

It is not one-to-one.

- 16 C** The function with rule $f(x) = mx + 2$, $m > 0$, has an inverse function with rule $f^{-1}(x) = ax + b$, $a, b \in R$.

We consider

$$x = mf^{-1}(x) + 2.$$

$$f^{-1}(x) = \frac{x}{m} - \frac{2}{m}$$

Here $\frac{1}{m} > 0$ and $-\frac{2}{m} < 0$.

Hence $a > 0$ and $b < 0$.

- 17 B** $x + 1$ is a factor of $x^2 + ax + b$, then $-a + b + 7$ equals?

By the factor theorem,

$$1 - a + b = 0.$$

$$\text{Thus } -a + b = -1$$

$$-a + b + 7 = -1 + 7 = 6$$

- 18 A** The choices are all cubic functions of the form $y = a(x + h)^3 + b$ where $a < 0$.

The graph shows a stationary point of inflexion at $(-1, 2)$

Hence it is of the form $y = a(x + 1)^3 + 2$.

It passes through the origin.

19 C
$$\begin{bmatrix} x' \\ y' \end{bmatrix} = \begin{bmatrix} 5 & 0 \\ 0 & 3 \end{bmatrix} \begin{bmatrix} x \\ y \end{bmatrix} + \begin{bmatrix} 7 \\ 1 \end{bmatrix}$$

This implies, $x' = 5x + 7$ and $y' = 3y + 1$.

$$x = \frac{x' - 7}{5} \quad \text{and} \quad y = \frac{y' - 1}{3}.$$

Hence $y = x^2$ is mapped to

$$\frac{y' - 1}{3} = \frac{(x' - 7)^2}{25}$$

$$y' = \frac{3(x' - 7)^2}{25} + 1$$

$$25y' = 3(x' - 7)^2 + 25$$

- 20 A** The transformation $T: R^2 \rightarrow R^2$ maps the curve with equation $y = 5^x$ to the curve

with equation $y = 5^{(2x+4)} - 3$

$$y' = 5^{(2x'+4)} - 3$$

$$y' + 3 = 5^{(2x'+4)}$$

Hence take $y' + 3 = y$ and $2x' + 4 = x$.

Thus,

$$y' = y - 3 \text{ and } x' = \frac{x - 4}{2}$$

$$\begin{bmatrix} x' \\ y' \end{bmatrix} = \begin{bmatrix} \frac{1}{2} & 0 \\ 0 & 1 \end{bmatrix} \begin{bmatrix} x \\ y \end{bmatrix} + \begin{bmatrix} -2 \\ -3 \end{bmatrix}$$

This can be written as:

$$\begin{bmatrix} x' \\ y' \end{bmatrix} = \begin{bmatrix} 0.5 & 0 \\ 0 & 1 \end{bmatrix} \begin{bmatrix} x \\ y \end{bmatrix} - \begin{bmatrix} 2 \\ 3 \end{bmatrix}$$

21 B $f: R \rightarrow R, f(x) = x.$

$$f(x) - f(-x) = x - (-x) = 2x.$$

22 B The tangent at the point $(1, 5)$ on the graph of the curve $y = f(x)$ has equation

$$y = 6 + x.$$

The tangent at the point $(3, 6)$ on the curve

$$y = f(x - 2) + 1 \text{ has equation??}$$

The transformation is '2 to the right' and '1 up'.

So the tangent at the point $(3, 6)$ on the curve

$$y = f(x - 2) + 1 \text{ is a translation of } y = 6 + x.$$

It transforms to:

$$y - 1 = 6 + x - 2.$$

That is,

$$y = 5 + x.$$

23 The graph of the of the derivative function f' of the cubic function with rule $y = f(x)$ crosses the x axis at $(1, 0)$ and $(-3, 0)$. The maximum value of the derivative function is 12.

$$f'(x) = k(x - 1)(x + 3).$$

The maximum value of the derivative function is 12. This occurs when $x = 2$.

This tells us that $k < 0$ as the quadratic has a maximum.

The turning points of the cubic occur at $x = 1$ and $x = -3$.

For a local maximum we look where the gradient changes from positive to negative going from left to right.

$$f'(x) = k(x - 1)(x + 3).$$

For $x < 1$, $f'(x) > 0$ (Remember $k < 0$)

For $x > 1$, $f'(x) < 0$.

Hence there is a local maximum where $x = 1$.

- 24 D** The random variable X has the following probability distribution

X	0	2	4
$\Pr(X = x)$	a	b	0.1

The mean of X is 2.

We have,

$$a + b + 0.1 = 1 \quad (\text{Probability distribution})$$

$$\text{That is, } a + b = 0.9 \quad (1)$$

and

$$2b + 0.4 = 2 \quad (2)$$

From (2), $b = 0.8$.

From (1), $a = 0.1$.

- 25 A** Let $f'(x) = 5g'(x) + 4$ and $f(1) = 5$ and $g(x) = x^2 f(x)$.

We have $f(x) = 5g(x) + 4x + c$ and $f(1) = 5$ and $g(1) = f(1) = 5$

So $5 = 25 + 4 + c$.

Hence $c = -24$.

Finally, $f(x) = 5g(x) + 4x - 24$

- 26 C** $25^x - 7 \times 5^x + 12 = 0$.

Let $a = 5^x$

$$a^2 - 7a + 12 = 0$$

$$(a - 3)(a - 4) = 0$$

Hence $a = 3$ or $a = 4$.

That is $5^x = 3$ or $5^x = 4$.

Therefore,

$$x = \log_5 3 \text{ or } x = \log_5 4$$

- 27 B** A particle moves in a straight line so that its position s m relative to O at a time t seconds ($t > 0$), is given by $s = 4t^3 - 5t - 10$.

The velocity $\frac{ds}{dt} = v = 12t^2 - 5$.

The acceleration $= \frac{dv}{dt} = 24$.

When $t = 1$, the acceleration is 24 m/s^2 .

- 28 A** The average rate of change of the function $y = 2x^4 + x^3 - 1$ between $x = -1$ and $x = 1$ is equal to $\frac{2 - 0}{2} = 1$.

29 E A function $f: R \rightarrow R$ is such that

- $f'(x) = 0$ where $x = 3$
- $f'(x) = 0$ where $x = 5$
- $f'(x) > 0$ where $3 < x < 5$
- $f'(x) < 0$ where $x > 5$
- $f'(x) < 0$ where $x < 3$

Stationary points when $x = 3$ and $x = 5$.

Immediately to the left of 3, $f'(x) < 0$ and immediately to the right of 3, $f'(x) > 0$.

Therefore there is a local minimum at $x = 3$.

Immediately to the left of 5, $f'(x) > 0$ and immediately to the right of 5, $f'(x) < 0$.

Therefore there is a local maximum at $x = 5$.

30 C The number of pets X a family has is a random variable with the following probability distribution.

x	0	1	2	3
$\Pr(X = x)$	0.3	0.2	0.4	0.1

The probability that two families have the same number of pets is equal to $0.3 \times 0.3 + 0.2 \times 0.2 + 0.4 \times 0.4 + 0.1 \times 0.1 = 0.09 + 0.04 + 0.16 + 0.01 = 0.30$

Solutions to extended-response questions

1 a i Gradient of $AB = \frac{16 - b^2 - 16}{b}$
 $= -b$

ii $f'(x) = -2x$

The tangent at point $(x, f(x))$ has gradient $-2x$

$$-2x = -b$$

$$x = \frac{b}{2}$$

The tangent at the point where $x = \frac{b}{2}$ has gradient $-b$.

b i Area of a trapezium $= \frac{h}{2}(a + b)$

$$S(b) = \frac{b}{2}(16 - b^2 + 16)$$

$$= \frac{b}{2}(32 - b^2)$$

ii $\frac{b}{2}(32 - b^2) = 28$

$$32b - b^3 = 56$$

$$b^3 - 32b + 56 = 0$$

$$(b - 2)(b^2 + 2b - 28) = 0$$

$$b = 2 \text{ or } (b + 1)^2 = 29$$

Thus $S(2) = 28$.

The other solutions of the equation are not in the interval $(0, 4)$.

The area of the trapezium is 28 when $b = 2$.

2 $f(x) = (\sqrt{x} - 2)^2(\sqrt{x} + 1)^2$

a To find the x -intercept

$$f(x) = 0 \text{ implies } \sqrt{x} - 2 = 0 \text{ or } \sqrt{x} + 1 = 0$$

Thus $\sqrt{x} - 2 = 0$ which implies $x = 4$.

Therefore $a = 4$.

b From the graph there is a local maximum at $x = \frac{1}{4}$ and a local minimum at $A(4, 0)$.

The graph has negative gradient for the interval $\left(\frac{1}{4}, 4\right)$

c $OABC$ is a rectangle with

$$OA = BC = 4.$$

Let $OC = AB = x$.

$$4x = \frac{136}{15}$$

$$x = \frac{34}{15}$$

That is, $OC = \frac{34}{15}$

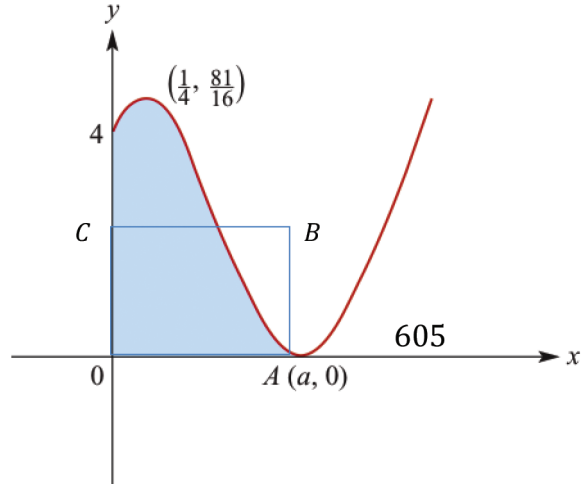

3 a $v = 4t - 6$

Find an expression for x the position at time t by finding the antiderivative.

$$x = 2t^2 - 6t + c$$

When $t = 0$, $x = 0$ and therefore $c = 0$.

$$x = 2t^2 - 6t$$

b $x(3) = 18 - 18$

$$= 0$$

The body has returned to O after 3 seconds.

c The average velocity = $\frac{\text{change in position}}{\text{change in time}} = 0 \text{ cm/s}$

d Body reverses direction when $v = 0$.

$$4t - 6 = 0$$

$$t = \frac{3}{2}$$

$$x\left(\frac{3}{2}\right) = 2 \times \frac{9}{4} - 6 \times \frac{3}{2} = -\frac{9}{2}.$$

The particle returns to O at $t = 3$.

The total distance travelled = 9 centimetres.

e Average speed = $\frac{9}{3} = 3$ centimetres/second.

4 $f(x) = -x^3 + ax^2$.

$$f'(x) = -3x^2 + 2ax$$

a i f has negative gradient for $f'(x) < 0$

$$-3x^2 + 2ax < 0$$

$$-x(3x - 2a) < 0$$

$$x < 0 \text{ or } x > \frac{2a}{3}$$

ii f has positive gradient for $f'(x) > 0$

$$0 < x < \frac{2a}{3}$$

b When $x = a$,

$$\begin{aligned} f'(a) &= -3a^2 + 2a^2 & \text{and} & & f(a) &= 0 \\ &= -a^2 \end{aligned}$$

The equation of the tangent at the point $(a, f(a))$

$$y - f(a) = f'(a)(x - a)$$

$$\text{Thus, } y = -a^2(x - a)$$

c The gradient of the normal $= -\frac{1}{f'(a)}$

$$= \frac{1}{a^2}$$

The equation of the normal is

$$y = \frac{1}{a^2}(x - a)$$

d Area $= \int_0^a (-x^3 + ax^2)dx$

$$\begin{aligned} &= \left[\frac{-x^4}{4} + \frac{ax^3}{3} \right]_0^a \\ &= \frac{-a^4}{4} + \frac{a^4}{3} \\ &= \frac{a^4}{12} \end{aligned}$$

5

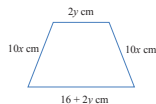

a $16x + 2y + 2y + 10x + 10x = 52$

$$36x + 4y = 52$$

$$4y = 52 - 36x$$

$$y = 13 - 9x$$

b Using Pythagoras' theorem.

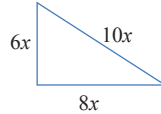

Heights = $6x$ cm

$$\begin{aligned}
 A(x) &= \frac{6x}{2}(2y + 16x + 2y) && \text{(Using the formula for the area of a trapezium)} \\
 &= 3x(4y + 16x) \\
 &= 3x(52 - 36x + 16x) && \text{(Substituting for } y \text{ from part a)} \\
 &= 156x - 60x^2
 \end{aligned}$$

c Finding the derivative:

$$A'(x) = 156 - 120x$$

$A'(x) = 0$ implies $x = \frac{13}{10}$. A maximum occurs at this value as

$A(x) = 156x - 60x^2$ is a quadratic with negative coefficient of x^2 .

Substituting for x in $y = 13 - 9x$ gives $y = \frac{13}{10}$.

6 a Total area of the two squares = $x^2 + y^2$, $x \leq y$

Total length of fencing = $2x + 3y$

Given that the length of the fencing is 5200 m

$$x + 3y = 5200$$

$$3y = 5200 - 2x$$

$$y = \frac{5200 - 2x}{3}$$

Therefore the total area, $A = x^2 + \left(\frac{5200 - 2x}{3}\right)^2$

b

$$\begin{aligned}
 A &= x^2 + \frac{5200^2}{9} - \frac{20\,800x}{9} + \frac{4x^2}{9} \\
 &= \frac{13x^2}{9} - \frac{20\,800x}{9} + \frac{5200^2}{9} \\
 A'(x) &= \frac{26x}{9} - \frac{20\,800}{9}
 \end{aligned}$$

$A'(x) = 0$ implies $x = 800$

The parabola has positive coefficient of x^2 and

therefore a minimum when $x = 800$.

When $x = 800$ substituting in $y = \frac{5200 - 2x}{3}$ gives $y = 1200$.

c $x \geq 0$ and $x \leq y$
 Substitute $y = \frac{5200 - 2x}{3}$

$$\frac{5200 - 2x}{3} \geq x$$

$$5200 - 2x \geq 3x$$

$$5200 \geq 5x$$

$$x \leq 1040$$

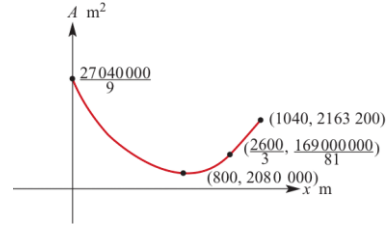

7 a

- (0, 1) (0, 3) (0, 5) (0, 7) (0, 9) (0, 11)
 (2, 1) (2, 3) (2, 5) (2, 7) (2, 9) (2, 11)
 (4, 1) (4, 3) (4, 5) (4, 7) (4, 9) (4, 11)
 (6, 1) (6, 3) (6, 5) (6, 7) (6, 9) (6, 11)
 (8, 1) (8, 3) (8, 5) (8, 7) (8, 9) (8, 11)
 (10, 1) (10, 3) (10, 5) (10, 7) (10, 9) (10, 11)
 36 outcomes

b Table showing sums

	0	2	4	6	8	10
1	1	3	5	7	9	11
3	3	5	7	9	11	13
5	5	7	9	11	13	15
7	7	9	11	13	15	17
9	9	11	13	15	17	19
11	11	13	15	17	19	21

Let X be the sum of the results.

i $\Pr(X = 1) = \frac{1}{36}$

ii $\Pr(X = 13) = \frac{5}{36}$

iii $\Pr(X = 9) = \frac{5}{36}$

c $\Pr(X = 15 | X > 7) = \frac{\Pr(X = 15)}{\Pr(X > 7)}$

$$= \frac{2}{13}$$

$$\begin{aligned} \mathbf{8\ a} \quad AB &= \begin{bmatrix} 2 & -1 & 1 \\ 4 & 2 & 2 \\ 1 & 3 & 1 \end{bmatrix} \begin{bmatrix} 2 & 1 & 1 \\ 1 & -1 & -2 \\ -5 & 2 & 1 \end{bmatrix} \\ &= \begin{bmatrix} -2 & 5 & 5 \\ 0 & 6 & 2 \\ 0 & 0 & -4 \end{bmatrix} \end{aligned}$$

$$\mathbf{b} \quad \begin{bmatrix} 2 & 1 & 1 \\ 1 & -1 & -2 \\ -5 & 2 & 1 \end{bmatrix} \begin{bmatrix} x \\ y \\ z \end{bmatrix} = \begin{bmatrix} 7 \\ -7 \\ 2 \end{bmatrix}$$

c Multiply both sides of the equation by A

$$\begin{aligned} \begin{bmatrix} 2 & -1 & 1 \\ 4 & 2 & 2 \\ 1 & 3 & 1 \end{bmatrix} \begin{bmatrix} 2 & 1 & 1 \\ 1 & -1 & -2 \\ -5 & 2 & 1 \end{bmatrix} \begin{bmatrix} x \\ y \\ z \end{bmatrix} &= \begin{bmatrix} 2 & -1 & 1 \\ 4 & 2 & 2 \\ 1 & 3 & 1 \end{bmatrix} \begin{bmatrix} 7 \\ -7 \\ 2 \end{bmatrix} \\ \begin{bmatrix} -2 & 5 & 5 \\ 0 & 6 & 2 \\ 0 & 0 & -4 \end{bmatrix} \begin{bmatrix} x \\ y \\ z \end{bmatrix} &= \begin{bmatrix} 23 \\ 18 \\ -12 \end{bmatrix} \end{aligned}$$

$$\begin{aligned} \mathbf{d} \quad -2x + 5y + 5z &= 23 & \boxed{1} \\ 6y + 2z &= 18 & \boxed{2} \\ -4z &= -12 & \boxed{3} \end{aligned}$$

From $\boxed{3}$, $z = 3$

From $\boxed{2}$, $y = 2$

From $\boxed{1}$, $x = 1$

9 a For function to be defined $x - 2a \geq 0$. That is $x \geq 2a$.

$$\mathbf{b} \quad \sqrt{x - 2a} = x$$

$$x - 2a = x^2 \quad \text{Squaring both sides}$$

$$x^2 - x + 2a = 0$$

$$x^2 - x + \frac{1}{4} = -2a + \frac{1}{4} \quad \text{Completing the square}$$

$$\left(x - \frac{1}{2}\right)^2 = \frac{-8a + 1}{4}$$

$$x = \frac{1}{2} + \frac{\sqrt{1 - 8a}}{2} \quad \text{or} \quad x = \frac{1}{2} - \frac{\sqrt{1 - 8a}}{2}$$

c The equation $f(x) = x$ has one solution for $a = \frac{1}{8}$

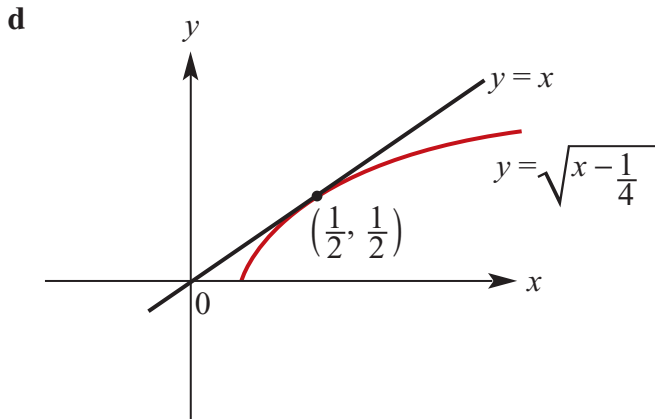

10 a Probability that Frederick goes to the library on each of the next three nights
 $= 0.7 \times 0.7 \times 0.7$
 $= 0.343$

b The possible sequences for 3 days for exactly two days going to the library:
 LSLL LLSL LLLS
 Probability of exactly two nights
 $= 0.3 \times 0.6 \times 0.7 + 0.7 \times 0.3 \times 0.6 + 0.7 \times 0.7 \times 0.3$
 $= 0.126 + 0.126 + 0.147$
 $= 0.399$

11 a Probability that sticks are brought from Platypus for the next three years
 $= 0.75 \times 0.75 \times 0.75$
 $= 0.4219$ (correct to four decimal places.)

b The possible sequences for three years for exactly two years buying from Platypus
 PNPP PPNP PPPN
 Probability of buying from Platypus for exactly two of the three years
 $= 0.25 \times 0.2 \times 0.75 + 0.75 \times 0.25 \times 0.2 + 0.75 \times 0.75 \times 0.25$
 $= 0.2156$ (correct to four decimal places.)

c Probability that they will buy from Platypus in the third year is 0.6125

12 a The line has negative gradient.
 The range $= [-mb + 3, -ma + 3]$

b Interchanging x and y and solving for y .

$$x = -my + 3$$

$$my = -x + 3$$

$$y = -\frac{1}{m}x + \frac{3}{m}$$

The equation of the inverse function is $f^{-1}(x) = \frac{-1}{m}x + \frac{3}{m}$

c The coordinates of the midpoint are found by using the midpoint of the line segment joining (x_1, y_1) to (x_2, y_2) are $\left(\frac{x_1 + x_2}{2}, \frac{y_1 + y_2}{2}\right)$

$$\text{The midpoint of } AB = \left(\frac{a + b}{2}, \frac{-ma - mb + 6}{2}\right)$$

d Gradient line through $AB = -m$

Gradient of a line perpendicular to $AB = \frac{1}{m}$

$$y - \left(\frac{-ma - mb + 6}{2}\right) = \frac{1}{m}\left(x - \left(\frac{a + b}{2}\right)\right)$$

$$2my + m^2a + m^2b - 6m = 2x - (a + b)$$

$$2my - 2x = -m^2(a + b) + 6m - (a + b)$$

e The transformation is defined by $(x, y) \rightarrow (x - 3, y + 5)$.

If $(x, y) \rightarrow (x', y')$ then

$$x' = x - 3 \text{ and } y' = y + 5$$

Hence, $x = x' + 3$ and $y = y' - 5$

Substituting in $y = -mx + 3$ gives

$$y' - 5 = -m(x' + 3) + 3$$

$$y' = -mx' - 3m + 8$$

The equation of the image is $y = -mx - 3m + 8$

Considering the end points:

$$(a, -ma + 3) \rightarrow (a - 3, -ma + 8)$$

and

$$(b, -mb + 3) \rightarrow (b - 3, -mb + 8).$$

f The transformation is defined by $(x, y) \rightarrow (-x, y)$.

If $(x, y) \rightarrow (x', y')$ then

$$x' = -x \text{ and } y' = y$$

The line is transformed to $y' = mx' + 3$.

That is, $y = mx + 3$

Considering the end points:

$$(a, -ma + 3) \rightarrow (-a, -ma + 3)$$

and

$$(b, -mb + 3) \rightarrow (-b, -mb + 3).$$

g If $a = 0$ the midpoint of AB has coordinates $\left(\frac{b}{2}, \frac{-mb + 6}{2}\right)$

$$\text{Thus } \frac{b}{2} = 6 \text{ and } \frac{-mb + 6}{2} = -4$$

$$\text{Hence } b = 12 \text{ and } m = \frac{7}{6}$$

13 a $f(x) = (p - 1)x^2 + 4x + (p - 4)$

i When $p = 0$, $f(x) = -x^2 + 4x - 4 = -(x^2 - 4x + 4) = -(x - 2)^2$

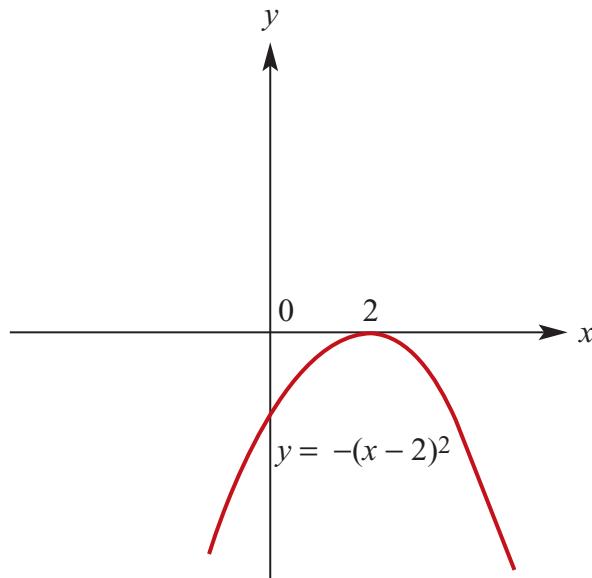

ii When $p = 2$, $f(x) = x^2 + 4x - 2$

For the x axis intercepts:

$$x^2 + 4x - 2 = 0$$

$$x^2 + 4x + 4 = 6$$

$$(x + 2)^2 = 6$$

$$x = -2 + \sqrt{6} \text{ or } x = -2 - \sqrt{6}$$

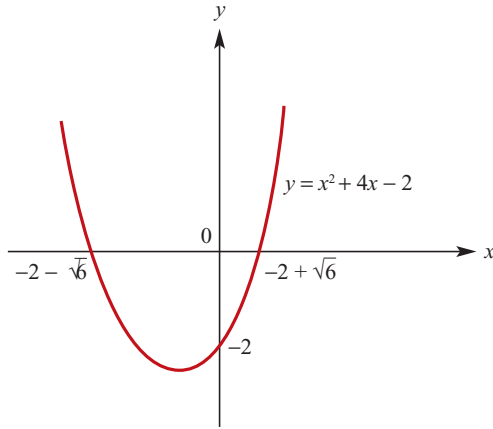

b $f'(x) = 2(p - 1)x + 4$

$$f'(x) = 0 \text{ implies } x = \frac{2}{1 - p}$$

$$\begin{aligned} \text{and } f\left(\frac{2}{1 - p}\right) &= (p - 1) \times \frac{4}{(1 - p)^2} + \frac{8}{1 - p} + (p - 4) \\ &= \frac{4}{(p - 1)} + \frac{8}{1 - p} + (p - 4) \\ &= \frac{-4}{(p - 1)} + (p - 4) \\ &= \frac{5p - p^2}{p - 1} \end{aligned}$$

The coordinates of the turning point are $\left(\frac{2}{1 - p}, \frac{5p - p^2}{p - 1}\right)$

c The turning point lies on the x axis when the y coordinate is zero.

That is, when $5p - p^2 = 0$.

$$p = 0 \text{ or } p = 5$$

d The discriminant of the quadratic $(p - 1)x^2 + 4x + (p - 4)$ is

$$\begin{aligned} 16 - 4(p - 1)(p - 4) &= 16 - 4[p^2 - 5p + 4] \\ &= -4p^2 + 20p \end{aligned}$$

There are two solutions when the discriminant is positive.

That is, when $-4p^2 + 20p > 0$

Equivalently when $p^2 - 5p < 0$

Thus $0 < p < 5$ and $p \neq 1$.

e The question should ask to sketch the graph of $y = g(x)$ and the graph of the reflection in the y -axis.

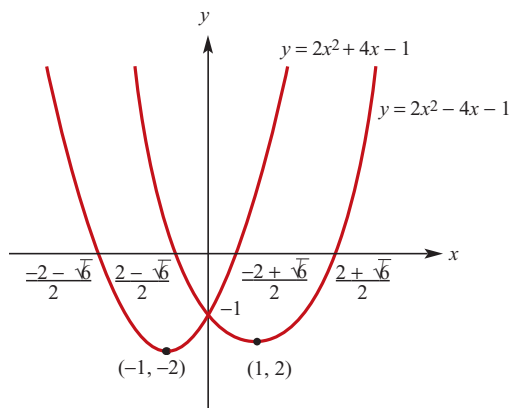

14 $h(t) = 2.3 \cos(kt)$

a High tide occurs every 12 hours

$$\frac{2\pi}{k} = 12$$

$$k = \frac{\pi}{6}$$

b $h(1.5) = 2.3 \cos\left(\frac{\pi}{6} \times 1.5\right)$

$$= 2.3 \cos\left(\frac{\pi}{4}\right)$$

$$= 2.3 \times \frac{1}{\sqrt{2}}$$

This is measured in metres

Thus the height of the road above mean sea level is:

$$2.3 \times \frac{1}{\sqrt{2}} \text{ metres} = 1.15 \sqrt{2} \times 100 \text{ cm}$$

$$= 115 \sqrt{2} \text{ cm}$$

c $h(1.5) = 2.3 \cos\left(\frac{\pi}{6}\right)$

$$= 2.3 \times \frac{\sqrt{3}}{2}$$

Thus the height of the raised footpath above mean sea level is:

$$2.3 \times \frac{\sqrt{3}}{2} \text{ metres} = 1.15 \sqrt{3} \times 100 \text{ cm}$$

$$= 115 \sqrt{3} \text{ cm}$$