

Topic 1 — Functions and graphs

1.2 Linear functions

1.2 Exercise

- 1 a The graph passes the vertical line test. It has a many-to-one correspondence.
 b Domain: $x \in [-4, 2]$
 Range: $y \in [0, 16]$
 c $f: [-4, 2] \rightarrow R, f(x) = x^2$
 d When $x = -2\sqrt{3}$,
 $y = (-2\sqrt{3})^2$
 $= 4 \times 3$
 $= 12$

	Correspondence	Domain	Range	Function?
a	Many-to-one	$[-3, 6)$	$[-9, 7]$	Yes
b	One-to-many	$[0, \infty)$	R	No
c	Many-to-many	$[-2, 2]$	$[-2, 2]$	No
d	One-to-one	R	R	Yes
e	Many-to-one	R	$\{2\}$	Yes
f	One-to-one	R	R	Yes

3 $L = \{(x \cdot y) : 3x - 4y = 12\}$.

- a Let $y = 0$.
 $\therefore 3x = 12$
 $\therefore x = 4$
 Let $x = 0$.
 $\therefore -4y = 12$
 $\therefore y = -3$

The line goes through $(4, 0)$ and $(0, -3)$.

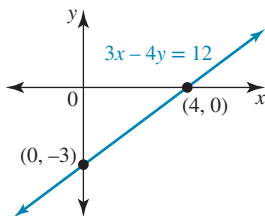

- b Rearranging the equation,
 $3x - 4y = 12$
 $\therefore 3x - 12 = 4y$

$$\therefore y = \frac{3}{4}x - 3$$

The gradient is $\frac{3}{4}$.

- 4 a $f: R \rightarrow R, f(x) = 9 - 4x$
 $f(0) = 9 \Rightarrow (0, 9)$
 Let $f(x) = 0$.
 $\therefore 9 - 4x = 0$
 $\therefore x = \frac{9}{4}$
 $\Rightarrow \left(\frac{9}{4}, 0\right)$

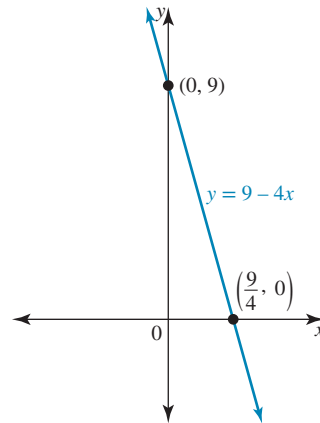

The range is R .

b $g: (-3, 5) \rightarrow R, g(x) = \frac{3x}{5}$

$$g(0) = 0 \Rightarrow (0, 0)$$

$$g(-3) = -\frac{9}{5} \Rightarrow \left(-3, -\frac{9}{5}\right) \text{ is an open end point.}$$

$$g(5) = 3 \Rightarrow (5, 3) \text{ is a closed end point.}$$

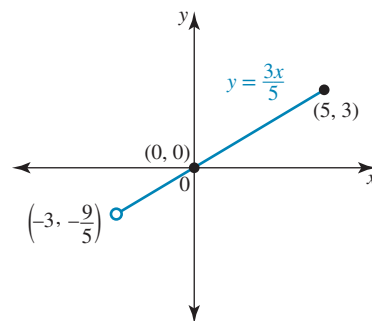

The range is $\left[-\frac{9}{5}, 3\right]$.

c $2x + y = 4, x \in [-2, 4]$
 y-intercept: $y = 4$ $(0, 4)$
 x-intercept:

$$2x = 4$$

$$x = 2$$
 $(2, 0)$

End points:

$$x = -2, y = 8$$
 $(-2, 8)$

$$x = 4, y = -4$$
 $(4, -4)$

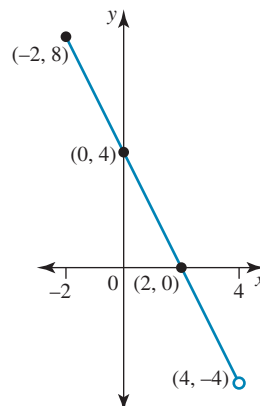

The range is $[-4, 8]$.

$$d \quad y = \frac{2x}{3} + 5, \quad x \in [-1, 5]$$

$$y\text{-intercept: } y = 5 \quad (0, 5)$$

x -intercept:

$$0 = \frac{2x}{3} + 5$$

$$-5 = \frac{2x}{3}$$

$$-15 = 2x$$

$$x = -\frac{15}{2} \left(-\frac{15}{2}, 0 \right)$$

(outside the domain)

End points:

$$x = -1, y = \frac{13}{3} \left(-1, \frac{13}{3} \right)$$

$$x = 5, y = \frac{25}{3} \left(5, \frac{25}{3} \right)$$

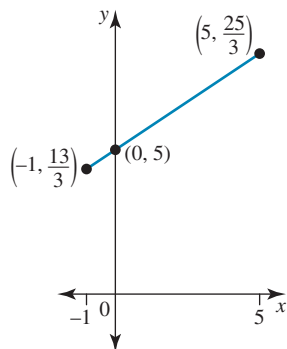

The range is $\left[\frac{13}{3}, \frac{25}{3} \right]$.

$$5 \quad a \quad y - y_1 = m(x - x_1)$$

$$y - 6 = -3(x - 2)$$

$$y - 6 = -3x + 6$$

$$y = -3x + 12$$

$$b \quad m = \frac{y_2 - y_1}{x_2 - x_1}$$

$$m = \frac{5 + 4}{1 + 2}$$

$$= \frac{9}{3}$$

$$= 3$$

$$y - y_1 = m(x - x_1)$$

$$y - 5 = 3(x - 1)$$

$$y - 5 = 3x - 3$$

$$y = 3x + 2$$

$$6 \quad a \quad y + 2x - 3 = 0$$

$$y = -2x + 3$$

$$m = -2$$

Therefore, gradient of desired line = -2.

$$y - y_1 = m(x - x_1)$$

$$y - 4 = -2(x + 1)$$

$$y - 4 = -2x - 2$$

$$y = -2x + 2$$

$$b \quad 3y - 6x = 4$$

$$3y = 6x + 4$$

$$y = 2x + \frac{4}{3}$$

$$m = 2$$

Therefore, gradient of desired line: $m = -\frac{1}{2}$

$$y - y_1 = m(x - x_1)$$

$$y - 3 = -\frac{1}{2}(x - 2)$$

$$y - 3 = -\frac{1}{2}x + 1$$

$$y = -\frac{1}{2}x + 4$$

$$2y = -x + 8$$

$$2y + x - 8 = 0$$

$$7 \quad a \quad m = \frac{y_2 - y_1}{x_2 - x_1}$$

$$= \frac{-4 - 1}{8 - 2}$$

$$= \frac{-5}{6}$$

As the gradient is negative:

$$\theta = 180^\circ - \tan^{-1} \left(\frac{5}{6} \right)$$

$$= 140.2^\circ$$

$$b \quad \tan(\theta) = m$$

$$m = \tan(45^\circ)$$

$$= 1$$

$$y - y_1 = m(x - x_1)$$

$$y - 4 = 1(x + 2)$$

$$y - 4 = x + 2$$

$$y = x + 6$$

$$8 \quad a \quad i \quad M = \left(\frac{x_1 + x_2}{2}, \frac{y_1 + y_2}{2} \right)$$

$$= \left(\frac{2 + 6}{2}, \frac{0 - 4}{2} \right)$$

$$= (4, -2)$$

$$ii \quad d = \sqrt{(x_2 - x_1)^2 + (y_2 - y_1)^2}$$

$$= \sqrt{(6 - 2)^2 + (-4 - 0)^2}$$

$$= \sqrt{4^2 + (-4)^2}$$

$$= \sqrt{32}$$

$$= 4\sqrt{2} \text{ units}$$

$$b \quad i \quad M = \left(\frac{x_1 + x_2}{2}, \frac{y_1 + y_2}{2} \right)$$

$$= \left(\frac{-3 + 4}{2}, \frac{-2 + 3}{2} \right)$$

$$= \left(\frac{1}{2}, \frac{1}{2} \right)$$

$$ii \quad d = \sqrt{(x_2 - x_1)^2 + (y_2 - y_1)^2}$$

$$= \sqrt{(4 + 3)^2 + (3 + 2)^2}$$

$$= \sqrt{7^2 + 5^2}$$

$$= \sqrt{74} \text{ units}$$

$$9 \quad a \quad x_M = \frac{x_1 + x_2}{2}$$

$$8 = \frac{a + 10}{2}$$

$$16 = a + 10$$

$$a = 6$$

$$\text{b } y_M = \frac{y_1 + y_2}{2}$$

$$\frac{5}{2} = \frac{a - 2}{2}$$

$$5 = a - 2$$

$$a = 7$$

$$\text{c } d = \sqrt{(x_2 - x_1)^2 + (y_2 - y_1)^2}$$

$$\sqrt{73} = \sqrt{(4 - 1)^2 + (6 - a)^2}$$

$$\sqrt{73} = \sqrt{9 + (6 - a)^2}$$

$$73 = 9 + (6 - a)^2$$

$$6 - a = 64$$

$$6 - a = \pm 8$$

$$a = 6 \pm 8$$

$$= 14, -2$$

$$\text{d } d = \sqrt{(x_2 - x_1)^2 + (y_2 - y_1)^2}$$

$$\sqrt{45} = \sqrt{(-2 - a)^2 + (-2 - 4)^2}$$

$$\sqrt{45} = \sqrt{(-2 - a)^2 + 36}$$

$$45 = (-2 - a)^2 + 36$$

$$(-2 - a)^2 = 9$$

$$-2 - a = \pm 3$$

$$-a = \pm 3 + 2$$

$$a = \pm 3 - 2$$

$$= -5, 1$$

10 A (5, -3), B (7, 8) and C (-2, p)

a The line $9x + 7y = 24$ has a gradient of $-\frac{9}{7}$.

This is the gradient of AC since it is parallel to this line.

$$m_{AC} = \frac{p + 3}{-2 - 5}$$

$$\therefore -\frac{9}{7} = \frac{p + 3}{-7}$$

$$\therefore 9 = p + 3$$

$$\therefore p = 6$$

b A line perpendicular to AC would have a gradient of $\frac{7}{9}$.

The line through B (7, 8) perpendicular to AC has equation:

$$y - 8 = \frac{7}{9}(x - 7)$$

$$\therefore 9y - 72 = 7x - 49$$

$$\therefore 9y - 7x = 23$$

c Let the point where $9y - 7x = 23$ meets AC be Q. The length of PQ is the shortest distance from B to AC.

To find Q, solve the pair of simultaneous equations:

$$9x + 7y = 24 \quad [1]$$

$$9y - 7x = 23 \quad [2]$$

$$Q \text{ is the point } \left(\frac{11}{2}, \frac{75}{26} \right).$$

The length of BQ is

$$\sqrt{\left(7 - \frac{11}{2}\right)^2 + \left(8 - \frac{75}{26}\right)^2} \approx 8.3 \text{ units.}$$

1.2 Exam questions

1 Midpoint: $\left(\frac{x_1 + x_2}{2}, \frac{y_1 + y_2}{2}\right)$ given (1, -5), (d, 2)

$$\text{Midpoint} = \left(\frac{1 + d}{2}, \frac{-5 + 2}{2}\right)$$

$$= \left(\frac{d + 1}{2}, -\frac{3}{2}\right)$$

The correct answer is **A**.

2 $f(x) = 4 - x$

$$f(a) = -2 \Rightarrow 4 - a = -2 \Rightarrow a = 6 \text{ included}$$

$$f(b) = 6 \Rightarrow 4 - b = 6 \Rightarrow b = -2 \text{ not included}$$

The domain is (-2, 6].

The correct answer is **D**.

3 Gradient $m = \frac{y_2 - y_1}{x_2 - x_1}$, so $m = \frac{1 - (-5)}{3 - 0} = \frac{6}{3} = 2 = m_T$

$$\text{Now } m_N m_T = -1, \text{ so } m_N = -\frac{1}{2}.$$

The correct answer is **C**.

1.3 Solving systems of equations

1.3 Exercise

$$1 \quad 2x + ky = 4 \quad [1]$$

$$(k - 3)x + 2y = 0 \quad [2]$$

There is a unique solution for all values of k except when the gradients are the same.

$$\text{From [1]: } ky = -2x + 4$$

$$y = -\frac{2}{k}x + \frac{4}{k} \quad \text{so } m = \frac{-2}{k}$$

$$\text{From [2]: } 2y = -(k - 3)x$$

$$y = -\frac{(k - 3)}{2}x \quad \text{so } m = -\frac{(k - 3)}{2}$$

Equating gradients, we have:

$$-\frac{2}{k} = -\frac{(k - 3)}{2}$$

$$2(2) = k(k - 3)$$

$$0 = k^2 - 3k - 4$$

$$0 = (k - 4)(k + 1)$$

$$0 = k - 4 \quad \text{or} \quad 0 = k + 1$$

$$k = 4 \quad \text{or} \quad k = -1$$

If $k = -1$ or 4 the equations will have the same gradient, so for all other values of k there will be a unique solution. That is, $k \in \mathbb{R} \setminus \{-1, 4\}$.

$$2 \quad mx - 2y = 4 \quad [1]$$

$$x + (m - 3)y = m \quad [2]$$

There will be infinitely many solutions if the equations are identical.

$$\text{From [1]: } mx - 4 = 2y$$

$$\frac{m}{2}x - 2 = y$$

$$\text{From [2]: } x + (m - 3)y = m$$

$$x - m = -(m - 3)y$$

$$x - m = (3 - m)y$$

$$y = \frac{1}{3 - m}x - m$$

For the equations to be identical, $m = 2$. To check we should look at the two gradients.

4 | TOPIC 1 Functions and graphs • EXERCISE 1.3

For [1]: Gradient = $\frac{m}{2} = \frac{2}{2} = 1$

For [2]: Gradient = $\frac{1}{3-m} = \frac{1}{3-2} = 1$

The gradients are also the same. Therefore, $m = 2$ for an infinite number of solutions.

3 $x + my = 3$ [1]

$4mx + y = 0$ [2]

From [1]: $my = -x + 3$

$y = -\frac{1}{m}x + \frac{3}{m}$ where gradient₁ = $-\frac{1}{m}$

From [2]: $y = -4mx$ where gradient₂ = $-4m$

There is no solution when the lines have the same gradient and are parallel.

Gradient₁ = Gradient₂

$-\frac{1}{m} = -4m$

$1 = 4m^2$

$\frac{1}{4} = m^2$

$m = \pm \frac{1}{2}$

There is no solution if $m = \pm \frac{1}{2}$.

4 $x + 3ky = 2$ [1]

$(k-1)x - 1 = -6y$ [2]

From [1]: $3ky = -x + 2$

$y = -\frac{1}{3k}x + \frac{2}{3k}$ where gradient₁ = $-\frac{1}{3k}$

From [2]: $1 - (k-1)x = 6y$

$\frac{1}{6} - \frac{(k-1)}{6}x = y$ where gradient₂ = $-\frac{k-1}{6}$

The lines have a unique solution for all values of k except for when the gradients are the same.

$m_1 = m_2$

$-\frac{1}{3k} = -\frac{k-1}{6}$

$6 = 3k^2 - 3k$

$0 = 3k^2 - 3k - 6$

$0 = k^2 - k - 2$

$0 = (k-2)(k+1)$

$k-2 = 0$ or $k+1 = 0$

$k = 2$ or $k = -1$

Lines have a unique solution when $k \in \mathbb{R} \setminus \{-1, 2\}$.

5 a $-2x + my = 1$ [1]

$(m+3)x - 2y = -2m$ [2]

From [1]: $my = 2x + 1$

$y = \frac{2}{m}x + \frac{1}{m}$ where gradient₁ = $\frac{2}{m}$

From [2]: $(m+3)x + 2m = 2y$

$\frac{(m+3)}{2}x + m = y$ where gradient₂ = $\frac{m+3}{2}$

The lines have a unique solution for all values of k except for when the gradients are the same.

Gradient₁ = Gradient₂

$\frac{2}{m} = \frac{m+3}{2}$

$4 = m^2 + 3m$

$0 = m^2 + 3m - 4$

$0 = (m+4)(m-1)$

$m + 4 = 0$ or $m - 1 = 0$

$m = -4$ or $m = 1$

The lines have a unique solution when $m \in \mathbb{R} \setminus \{-4, 1\}$.

b The lines have no solution when the gradients are the same because the lines are parallel.

If $m = -4$

$-2x - 4y = 1$ [1]

$-x - 2y = 8$ [2]

$[2] \times 2 \Rightarrow -2x - 4y = 16$

Therefore, if $m = -4$, the gradients are equal, but the y -intercepts are not. Therefore, the lines are parallel

c The lines have infinitely many solutions when both the equations are identical. This is when their gradients are the same and so too are the y -intercepts.

If $m = 1$:

$-2x + y = 1$ [1]

$4x - 2y = -2$ [2]

$[1] \times -2 \Rightarrow 4x - 2y = -2$

The lines are identical, so there are infinitely many solutions when $m = 1$.

6 $2m - 4n - p = 1$ [1]

$4m + n + p = 5$ [2]

$3m + 3n - 2p = 22$ [3]

$[1] \times 2$ and $[2] \times 2$:

$4m - 8n - 2p = 2$ [4]

$8m + 2n + 2p = 10$ [5]

$[3] - [4]$:

$-m + 11n = 20$ [6]

$[3] + [5]$:

$11m + 5n = 32$ [7]

$[6] \times 11$:

$-11m + 121n = 220$ [8]

$[7] + [8]$:

$126n = 252$

$n = 2$

Substitute $n = 2$ into [6]:

$-m + 11(2) = 20$

$22 - 20 = m$

$m = 2$

Substitute $m = 2$ and $n = 2$ into [2]:

$4(2) + 2 + p = 5$

$10 + p = 5$

$p = -5$

7 $2d - e - f = -2$ [1]

$3d + 2e - f = 5$ [2]

$d + 3e + 2f = 11$ [3]

$[1] \times 2$ and $[2] \times 2$:

$4d - 2e - 2f = -4$ [4]

$6d + 4e - 2f = 10$ [5]

$[3] + [4]$:

$5d + e = 7$ [6]

$[3] + [5]$:

$7d + 7e = 21$

$d + e = 3$ [7]

$[6] - [7]$:

$4d = 4$

$d = 1$

Substitute $d = 1$ into [7]:

$$1 + e = 3$$

$$e = 2$$

Substitute $d = 1$ and $e = 2$ into [1]:

$$2(1) - 2 - f = -2$$

$$f = 2$$

8 CAS can be used for all parts or the equations can be solved by hand.

$$\mathbf{a} \quad 2x + y - z = 12 \quad [1]$$

$$-x - 3y + z = -13 \quad [2]$$

$$-4x + 3y - z = -2 \quad [3]$$

$$[2] + [3]:$$

$$-5x = -15$$

$$x = 3$$

$$[1] \Rightarrow 6 + y - z = 12 \quad [4]$$

$$y - z = 6$$

$$[2] \Rightarrow -3 - 3y + z = -13 \quad [5]$$

$$-3y + z = -10$$

$$[4] + [5]:$$

$$-2y = -4$$

$$y = 2$$

Substitute into [4]:

$$2 - z = 6$$

$$z = -4$$

$$\mathbf{b} \quad m + n - p = 6 \quad [1]$$

$$3m + 5n - 2p = 13 \quad [2]$$

$$5m + 4n - 7p = 34 \quad [3]$$

$$[1] \times 3:$$

$$3m + 3n - 3p = 18 \quad [4]$$

$$[2] - [4]:$$

$$2n + p = -5 \quad [5]$$

$$[1] \times 5:$$

$$5m + 5n - 5p = 30 \quad [6]$$

$$[6] - [3]:$$

$$n + 2p = -4 \quad [7]$$

$$[7] \times 2:$$

$$2n + 4p = -8 \quad [8]$$

$$[8] - [5]:$$

$$3p = -3$$

$$p = -1$$

Substitute $p = -1$ into [5]:

$$2n - 1 = -5$$

$$2n = -4$$

$$n = -2$$

Substitute $p = -1$ and $n = -2$ into [1]:

$$m - 2 + 1 = 6$$

$$m = 7$$

$$\mathbf{c} \quad u + 2v - 4w = 23 \quad [1]$$

$$3u + 4v - 2w = 37 \quad [2]$$

$$3u + v - 2w = 19 \quad [3]$$

$$[1] \times 3:$$

$$3u + 6v - 12w = 69 \quad [4]$$

$$[4] - [2]:$$

$$2v - 10w = 32$$

$$v - 5w = 16 \quad [5]$$

$$[4] - [3]:$$

$$5v - 10w = 50$$

$$v - 2w = 10 \quad [6]$$

$$[6] - [5]:$$

$$3w = -6$$

$$w = -2$$

Substitute $w = -2$ into [6]:

$$v - 2(-2) = 10$$

$$v + 4 = 10$$

$$v = 6$$

Substitute $w = -2$ and $v = 6$ into [1]:

$$u + 2(6) - 4(-2) = 23$$

$$u + 12 + 8 = 23$$

$$u = 3$$

$$\mathbf{d} \quad a + b + c = 4 \quad [1]$$

$$2a - b + 2c = 17 \quad [2]$$

$$-a - 3b + c = 3 \quad [3]$$

$$[1] + [3]:$$

$$-2a + 2c = 7 \quad [4]$$

$$[3] \times 2:$$

$$-2a = 6b + 2c = 6 \quad [5]$$

$$[4] \times -2:$$

$$4b - 4c = -14 \quad [6]$$

$$[6] + [7]:$$

$$-3b = 9$$

$$b = -3$$

Substitute $b = -3$ into [4]:

$$-2(-3) + 2c = 7$$

$$6 + 2c = 7$$

$$2c = 1$$

$$c = \frac{1}{2}$$

Substitute $b = -3$ and $c = \frac{1}{2}$ into [1]:

$$a - 3 + \frac{1}{2} = 4$$

$$a - \frac{5}{2} = \frac{8}{2}$$

$$a = \frac{13}{2}$$

9 Let a be the smallest angle, b be the largest angle and c be the third angle.

$$b = a + 20 \quad [1]$$

$$a + b = c + 60 \quad [2]$$

$$a + b + c = 180 \quad [3]$$

Substitute [1] into [2] and [3]:

$$a + a + 20 = c + 60 \quad [4]$$

$$2a - c = 40$$

$$a + a + 20 + c = 180 \quad [5]$$

$$2a + c = 160$$

$$[5] + [4]:$$

$$4a = 200$$

$$a = 50^\circ$$

Substitute $a = 50^\circ$ into [1]:

$$b = 50 + 20 = 70^\circ$$

6 | TOPIC 1 Functions and graphs • EXERCISE 1.3

Substitute $a = 50^\circ$ and $b = 70^\circ$ into [3]:

$$50 + 70 + c = 180$$

$$120 + c = 180$$

$$c = 60^\circ$$

The largest angle is 70° , the smallest angle is 50° and the third angle is 60° .

10 $w - 2x + 3y - z = 10$

$$2w + x + y + z = 4$$

$$-w + x + 2y - z = -3$$

$$3w - 2x + y = 11$$

Solve using CAS:

$$w = 1, x = -3, y = 2 \text{ and } z = 3$$

11 $2x - y + az = 4$ [1]

$$(a + 2)x + y - z = 2$$
 [2]

$$6x + (a + 1)y - 2z = 4$$
 [3]

Solve using CAS:

$$x = \frac{2(a+2)}{a(a+4)}, y = \frac{4(a+2)}{a(a+4)} \text{ and } z = \frac{4}{a}$$

12 $x + 2y + 2z = 1$ [1]

$$2x - 2y + z = 2$$
 [2]

a [1] + [2]:

$$3x + 3z = 3$$

b Let $z = \lambda$.

$$3x + 3\lambda = 3$$

$$x + \lambda = 1$$

$$x = 1 - \lambda$$

Substitute $z = \lambda$ and $x = 1 - \lambda$ into [2]:

$$2(1 - \lambda) - 2y + \lambda = 2$$

$$2 - 2\lambda - 2y + \lambda = 2$$

$$-\lambda = 2y$$

$$y = -\frac{\lambda}{2}$$

c This solution describes the line along which the two planes are intersecting.

13 $x + 2y + 4z = 2$ [1]

$$x - y - 3z = 4$$
 [2]

[2] - [1]:

$$-3y - 7z = 2$$

$$3y + 7z = -2$$

Let $z = \lambda$.

$$3y + 7\lambda = -2$$

$$3y = -7\lambda - 2$$

$$y = \frac{-7\lambda - 2}{3}$$

$$y = -\frac{7\lambda + 2}{3}$$

Substitute $z = \lambda$ and $y = -\frac{7\lambda + 2}{3}$ into [2]:

$$x + \frac{7\lambda + 2}{3} - 3\lambda = 4$$

$$x = 3\lambda + 4 - \frac{7\lambda + 2}{3}$$

$$x = \frac{9\lambda + 12 - 7\lambda - 2}{3}$$

$$x = \frac{2\lambda + 10}{3}$$

$$x = \frac{2(\lambda + 5)}{3}$$

14 $x + y - 2z = 5$ [1]

$$x - 2y + 4z = 1$$
 [2]

[1] - [2]:

$$3y - 6z = 4$$

Let $z = \lambda$.

$$3y = 6\lambda + 4$$

$$y = \frac{2(3\lambda + 2)}{3}$$

Substitute $y = \frac{2(3\lambda + 2)}{3}$ into [1]:

$$x + \frac{2(3\lambda + 2)}{3} - 2\lambda = 5$$

$$3x + 6\lambda + 4 - 6\lambda = 15$$

$$3x = 11$$

$$x = \frac{11}{3}$$

15 $-2x + y + z = -2$ [1]

$$x - 3z = 0$$
 [2]

Let $z = \lambda$.

From [2]:

$$x - 3\lambda = 0$$

$$x = 3\lambda$$

Substitute $z = \lambda$ and $x = 3\lambda$ into [1]:

$$-2(3\lambda) + y + \lambda = -2$$

$$y - 5\lambda = -2$$

$$y = 5\lambda - 2$$

16 $3x + 2y = -1$ [1]

$$mx + 4y = n$$
 [2]

From [1]: $2y = -3x - 1$

$$y = -\frac{3}{2}x - \frac{1}{2} \text{ where gradient}_1 = -\frac{3}{2}$$

From [2]: $4y = -mx + n$

$$y = -\frac{m}{4}x + \frac{n}{4} \text{ where gradient}_2 = -\frac{m}{4}$$

If $\text{gradient}_1 = \text{gradient}_2$,

$$-\frac{3}{2} = -\frac{m}{4}$$

$$12 = 2m$$

$$m = 6$$

a The lines have a unique solution for all values of k except for when the gradients are the same. Therefore, $m \in \mathbb{R} \setminus \{6\}$ and $n \in \mathbb{R}$.

b The lines have infinitely many solutions when both the equations are identical. This is when the gradients are the same and so too are their c values. If the gradients are the same, then $m = 6$, and if the c values are the same, then:

$$-\frac{1}{2} = \frac{n}{4}$$

$$-4 = 2n$$

$$n = -2$$

Therefore, for an infinite number of solutions, $m = 6, n = -2$.

c The lines have no solution when the gradients are the same but the y -intercepts are different (lines are parallel).

Therefore, $m = 6$ and $n \in \mathbb{R} \setminus \{-2\}$.

1.3 Exam questions

- 1 Consider the simultaneous equations:

$$ax - 3y = 5 \quad [1]$$

$$3x - ay = 8 - a \quad [2]$$

There will be no solutions when the gradients of both equations are the same and the y -intercept is different.

First, rearrange the equations to determine the gradient of each line.

$$ax - 3y = 5 \quad [1]$$

$$-3y = -ax + 5$$

$$y = \frac{a}{3}x - \frac{5}{3}$$

$$\text{Gradient} = \frac{a}{3}$$

$$3x - ay = 8 - a \quad [2]$$

$$-ay = -3x + 8 - a$$

$$y = \frac{3}{a}x - \frac{8 - a}{a}$$

$$\text{Gradient} = \frac{3}{a}$$

Solve for when the gradients are equal.

$$\frac{a}{3} = \frac{3}{a}$$

$$a^2 = 9$$

$$a = \pm 3$$

Now test each a value to see which one(s) means that the y -intercepts are different.

$$a = 3:$$

$$3x - 3y = 5 \quad [1]$$

$$3x - 3y = 5 \quad [2]$$

When $a = 3$, the equations are the same; therefore, there would be infinitely many solutions.

$$a = -3:$$

$$-3x - 3y = 5 \quad [1]$$

$$3x + 3y = 11 \quad [2]$$

The gradients of both equations are the same; however, the y -intercepts are different.

Therefore, when $a = -3$, there are no solutions.

The correct answer is **B**.

- 2 Consider the simultaneous equations:

$$-2x - my = -4 \quad [1]$$

$$(m - 1)x + 6y = 2(m - 1) \quad [2]$$

There will be a unique solution provided the gradients of the two lines are not equal.

First, rearrange the equations to determine the gradient of each line.

$$-2x - my = -4 \quad [1]$$

$$-my = 2x - 4$$

$$y = -\frac{2}{m}x + \frac{4}{m}$$

$$\text{Gradient} = -\frac{2}{m}$$

$$(m - 1)x + 6y = 2(m - 1) \quad [2]$$

$$6y = -(m - 1)x + 2(m - 1)$$

$$y = -\frac{m - 1}{6}x + \frac{m - 1}{3}$$

$$\text{Gradient} = -\frac{m - 1}{6}$$

Solve for when the gradients are equal.

$$-\frac{2}{m} = -\frac{m - 1}{6}$$

$$12 = m^2 - m$$

$$0 = m^2 - m - 12$$

$$= (m - 4)(m + 3)$$

$$m = 4, -3$$

Therefore, there will be a unique solution for all values other than 4 and -3 .

$$m \in \mathbb{R} \setminus \{-3, 4\}$$

The correct answer is **C**.

- 3 A unique solution represents only one value for each of the three variables and will only occur at a point.

The correct answer is **C**.

1.4 Quadratic functions

1.4 Exercise

1 a $15u^2 - u - 2 = (5u - 2)(3u + 1)$

b $6d^2 - 28d + 16 = 2(3d^2 - 14d + 8) = 2(3d - 2)(d - 4)$

c $3j^2 + 12j - 6$

$$= 3(j^2 + 4j - 2)$$

$$= 3(j^2 + 4j + (2)^2 - (2)^2 - 2)$$

$$= 3((j + 2)^2 - 6)$$

$$= 3\left((j + 2)^2 - (\sqrt{6})^2\right)$$

$$= 3(j + 2 - \sqrt{6})(j + 2 + \sqrt{6})$$

d $b^2 - 1 = (b - 1)(b + 1)$

2 a $f^2 - 12f - 28 = (f - 14)(f + 2)$

b $g^2 + 3g - 4 = (g + 4)(g - 1)$

3 a $8x^2 + 2x - 3 = 0$

$$(4x + 3)(2x - 1) = 0$$

$$x = -\frac{3}{4}, \frac{1}{2}$$

b $2x^2 - 4x + 1 = 0$

$$\Delta = b^2 - 4ac$$

$$= (-4)^2 - 4 \times 2 \times 1$$

$$= 16 - 8$$

$$= 8$$

$$x = \frac{-b \pm \sqrt{b^2 - 4ac}}{2a}$$

$$= \frac{4 \pm \sqrt{8}}{2 \times 2}$$

$$= \frac{4 \pm 2\sqrt{2}}{4}$$

$$= \frac{2 \pm \sqrt{2}}{2}$$

4 a $81y^2 = 1$

$$81y^2 - 1 = 0$$

$$(9y)^2 - 1^2 = 0$$

$$(9y - 1)(9y + 1) = 0$$

8 | TOPIC 1 Functions and graphs • EXERCISE 1.4

$$9y - 1 = 0 \quad \text{or} \quad 9y + 1 = 0$$

$$y = \frac{1}{9} \qquad y = -\frac{1}{9}$$

b $4z^2 + 28z + 49 = 0$
 $(2z)^2 + 2(2z)(7) + 7^2 = 0$
 $(2z + 7)^2 = 0$
 $2z + 7 = 0$
 $2z = -7$
 $z = -\frac{7}{2}$

c $5m^2 + 3 = 10m$
 $5m^2 - 10m + 3 = 0$
 $m = \frac{10 \pm \sqrt{(-10)^2 - 4 \times 5 \times 3}}{2 \times 5}$
 $= \frac{10 \pm \sqrt{40}}{10}$
 $= \frac{10 \pm 2\sqrt{10}}{10}$
 $= \frac{5 \pm \sqrt{10}}{5}$

d $x^2 - 4x = -3$
 $x^2 - 4x + 3 = 0$
 $(x - 3)(x - 1) = 0$
 $x - 3 = 0 \quad \text{or} \quad x - 1 = 0$
 $x = 3 \qquad x = 1$

5 a $48p = 24p^2 + 18$
 $24p^2 - 48p + 18 = 0$
 $4p^2 - 8p + 3 = 0$
 $(2p - 1)(2p - 3) = 0$
 $2p - 1 = 0 \quad \text{or} \quad 2p - 3 = 0$
 $p = \frac{1}{2} \qquad p = \frac{3}{2}$

b $39k = 4k^2 + 77$
 $4k^2 - 39k + 77 = 0$
 $(4k - 11)(k - 7) = 0$
 $4k - 11 = 0 \quad \text{or} \quad k - 7 = 0$
 $k = \frac{11}{4} \qquad k = 7$

c $m^2 + 3m = 4$
 $m^2 + 3m - 4 = 0$
 $(m + 4)(m - 1) = 0$
 $m + 4 = 0 \quad \text{or} \quad m - 1 = 0$
 $m = -4 \qquad m = 1$

d $4n^2 = 8 - 5n$
 $4n^2 + 5n - 8 = 0$
 $n = \frac{-5 \pm \sqrt{(5)^2 - 4 \times 4 \times -8}}{2 \times 4}$
 $= \frac{-5 \pm \sqrt{153}}{8}$
 $= \frac{-5 \pm 3\sqrt{17}}{8}$

6 $y = 2(3x - 2)^2 - 8$
 Turning point: when $3x - 2 = 0$, $x = \frac{2}{3}$.

Therefore, the graph has a minimum turning point at

$$\left(\frac{2}{3}, -8\right).$$

y-intercept: let $x = 0$.

$$\therefore y = 2(-2)^2 - 8$$

$$\therefore y = 0$$

$$(0, 0)$$

The axis of symmetry is $x = \frac{2}{3}$, so the other x-intercept must

be $\left(\frac{4}{3}, 0\right)$.

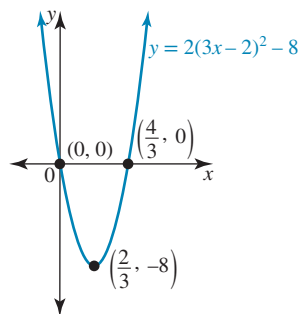

Domain R , range $[-8, \infty)$

7 a $f: (-2, 2) \rightarrow R, f(x) = 3(1 - x)^2 + 2$

TP = (1, 2)

End points:

$$x = -2, f(2) = 3(1 - 2)^2 + 2$$

$$= 3 \times (-1)^2 + 2$$

$$= 5$$

$$\therefore (-2, 5)$$

$$x = -2, f(-2) = 3(1 + 2)^2 + 2$$

$$= 3 \times (3)^2 + 2$$

$$= 29$$

$$\therefore (-2, 29)$$

Lowest value = 2, highest value = 29

Therefore, range = [2, 29).

b i $y = (x - 2)(2x + 3)$, $x \in [-2, 3]$

y-intercept, $x = 0$:

$$y = (0 - 2)(0 + 3)$$

$$= -6$$

$$(0, -6)$$

x-intercepts, $y = 0$:

$$0 = (x - 2)(2x + 3)$$

$$x = 2, -\frac{3}{2}$$

$$(2, 0), \left(-\frac{3}{2}, 0\right)$$

The turning point occurs halfway between the x-intercepts:

$$x = \frac{2 - \frac{3}{2}}{2} = \frac{\frac{1}{2}}{2} = \frac{1}{4}$$

$$y = \left(\frac{1}{4} - 2\right) \left(2 \times \frac{1}{4} + 3\right)$$

$$= -\frac{7}{4} \times \frac{7}{2}$$

$$= -\frac{49}{8}$$

$$\text{TP} = \left(\frac{1}{4}, -\frac{49}{8}\right)$$

End points:

$$x = -2, y = (-2 - 2)(-4 + 3) = 4$$

$$\therefore (-2, 4)$$

$$x = 3, y = (3 - 2)(6 + 3) = 9$$

$$\therefore (3, 9)$$

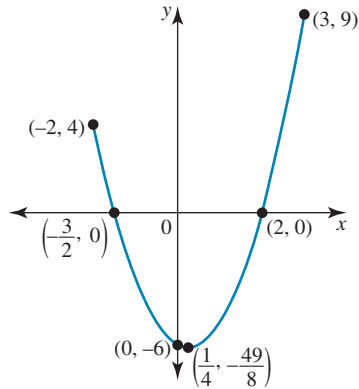

$$\text{Range} = \left[-\frac{49}{8}, 9\right]$$

ii $y = -x^2 + 4x + 2, x \in R$

y-intercept, $x = 0$:

$$y = 2$$

$$(0, 2)$$

x-intercepts, $y = 0$:

$$0 = -x^2 + 4x + 2$$

$$\Delta = b^2 - 4ac$$

$$= 4^2 - 4 \times -1 \times 2$$

$$= 24$$

$$x = \frac{-b \pm \sqrt{b^2 - 4ac}}{2a}$$

$$= \frac{-4 \pm \sqrt{24}}{-2}$$

$$= \frac{-4 \pm 2\sqrt{6}}{-2}$$

$$= 2 \pm \sqrt{6}$$

$$(2 - \sqrt{6}, 0), (2 + \sqrt{6}, 0)$$

Turning point:

$$x = \frac{-4}{-2} = 2$$

$$y = -2^2 + 4(2) + 2$$

$$= 6$$

$$\text{TP} = (2, 6)$$

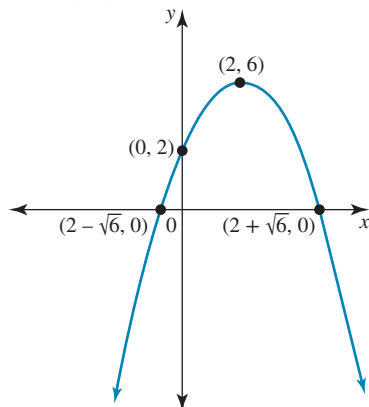

$$\text{Range} = (-\infty, 6]$$

iii $y = -2(x + 1)^2 - 3, x \in (-3, 0]$

y-intercept, $x = 0$:

$$y = -2(0 + 1)^2 - 3$$

$$= -5$$

$$(0, -5)$$

x-intercepts, $y = 0$:

$$0 = -2(x + 1)^2 - 3$$

$$-\frac{3}{2} = (x + 1)^2$$

No x-intercepts

$$\text{TP} = (-1, -3)$$

End points:

$$x = -3, y = -2(-3 + 1)^2 - 3$$

$$= -2 \times (-2)^2 - 3$$

$$= -11$$

$$\therefore (-3, -11)$$

$$x = 0, y = -2(0 + 1)^2 - 3$$

$$= -2 \times (1)^2 - 3$$

$$= -5$$

$$\therefore (0, -5)$$

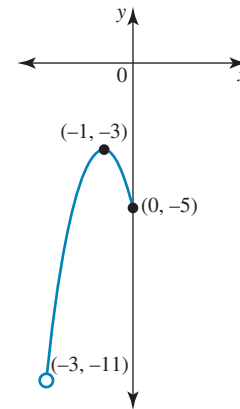

$$\text{Range} = (-11, -3]$$

iv $y = \frac{1}{2}(2x - 3)^2 - 1, x \in R$

y-intercept, $x = 0$:

$$y = \frac{1}{2}(0 - 3)^2 - 1$$

$$= \frac{9}{2} - 1$$

$$= \frac{7}{2}$$

$$= \frac{7}{2}$$

$$\left(0, \frac{7}{2}\right)$$

x-intercepts, $y = 0$:

$$0 = \frac{1}{2}(2x - 3)^2 - 1$$

$$2 = (2x - 3)^2$$

$$\pm\sqrt{2} = 2x - 3$$

$$\pm\sqrt{2} + 3 = 2x$$

$$x = \frac{3 \pm \sqrt{2}}{2}$$

$$\left(\frac{3 - \sqrt{2}}{2}, 0\right), \left(\frac{3 + \sqrt{2}}{2}, 0\right)$$

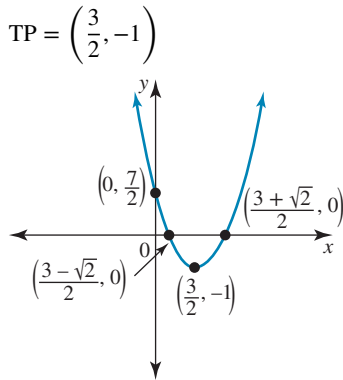

$$\text{Range} = [-1, \infty)$$

8 $f: \mathbb{R}^+ \cup \{0\} \rightarrow \mathbb{R}, f(x) = 4x^2 - 8x + 7.$

a The discriminant determines the number of x -intercepts.

$$\Delta = b^2 - 4ac, a = 4, b = -8, c = 7$$

$$\Delta = 64 - 4 \times 4 \times 7$$

$$= 64 - 112$$

$$< 0$$

There are no x -intercepts.

b $f(x) = 4x^2 - 8x + 7$

Completing the square:

$$f(x) = 4 \left(x^2 - 2x + \frac{7}{4} \right)$$

$$= 4 \left((x^2 - 2x + 1) - 1 + \frac{7}{4} \right)$$

$$= 4 \left((x - 1)^2 + \frac{3}{4} \right)$$

$$= 4(x - 1)^2 + 3$$

c The restricted domain is $\mathbb{R}^+ \cup \{0\}$.

Minimum turning point (1, 3), y -intercept and end point (0, 7)

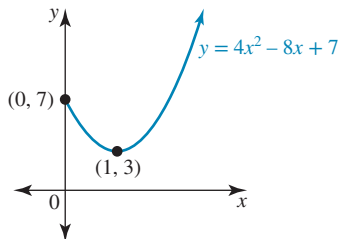

The range is $[3, \infty)$.

9 x -intercept at $x = -\frac{1}{2} \Rightarrow (2x + 1)$ is a factor.

x -intercept at $x = 4 \Rightarrow (x - 4)$ is a factor.

Let the equation be $y = a(2x + 1)(x - 4)$.

Substitute the point (0, 2):

$$\therefore 2 = a(1)(-4)$$

$$\therefore a = -\frac{1}{2}$$

The equation is $y = -\frac{1}{2}(2x + 1)(x - 4)$.

The turning point is halfway between the x -intercepts.

Therefore,

$$x = \frac{4 - 0.5}{2}$$

$$= \frac{3.5}{2}$$

$$= \frac{7}{4}$$

Substitute this x -value back into the original equation.

$$y = -\frac{1}{2} \left(2 \times \frac{7}{4} + 1 \right) \left(\frac{7}{4} - 4 \right)$$

$$= -\frac{1}{2} \left(\frac{9}{2} \right) \left(-\frac{9}{4} \right)$$

$$= \frac{81}{16}$$

Therefore, the turning point is $\left(\frac{7}{4}, \frac{81}{16}\right)$.

10 a Let the equation be $y = a(x - h)^2 + k$.

The turning point is $(-6, 12)$.

$$\therefore y = a(x + 6)^2 + 12$$

Substitute the point $(4, -3)$:

$$\therefore -3 = a(10)^2 + 12$$

$$\therefore 100a = -15$$

$$\therefore a = -\frac{3}{20}$$

The equation is $y = -\frac{3}{20}(x + 6)^2 + 12$.

b The points $(-7, 0)$ and $\left(-2\frac{1}{2}, 0\right)$ are the two x -intercepts.

The equation has linear factors $(x + 7)$ and $\left(x + 2\frac{1}{2}\right)$ or $(2x + 5)$.

Let the equation be $y = a(x + 7)(2x + 5)$.

Substitute the point $(0, -20)$:

$$\therefore -20 = a(7)(5)$$

$$\therefore a = -\frac{4}{7}$$

The equation is $y = -\frac{4}{7}(x + 7)(2x + 5)$.

c As the points $(-8, 11)$ and $(8, 11)$ have the same y -coordinate, the turning point and the axis of symmetry lie midway between them.

$$\text{Axis of symmetry: } x = \frac{-8 + 8}{2} \Rightarrow x = 0.$$

The minimum value of a quadratic function is the y -value of its minimum turning point.

Therefore, the turning point is $(0, -5)$.

Let the equation be $y = ax^2 - 5$.

Substitute the point $(8, 11)$:

$$\therefore 11 = a(64) - 5$$

$$\therefore 64a = 16$$

$$\therefore a = \frac{1}{4}$$

The equation is $y = \frac{1}{4}x^2 - 5$.

11 a $-x^2 + 2x - 5$

$$= -(x^2 - 2x + 5)$$

$$= -((x^2 - 2x + 1) - 1 + 5)$$

$$= -((x - 1)^2 + 4)$$

$$= -(x - 1)^2 - 4$$

b $y = -x^2 + 2x - 5$

$$\therefore y = -(x - 1)^2 - 4$$

The turning point is $(1, -4)$.

c The turning point is a maximum, so the range is $(-\infty, -4]$.

There are no x -intercepts. The y -intercept is $(0, -5)$.

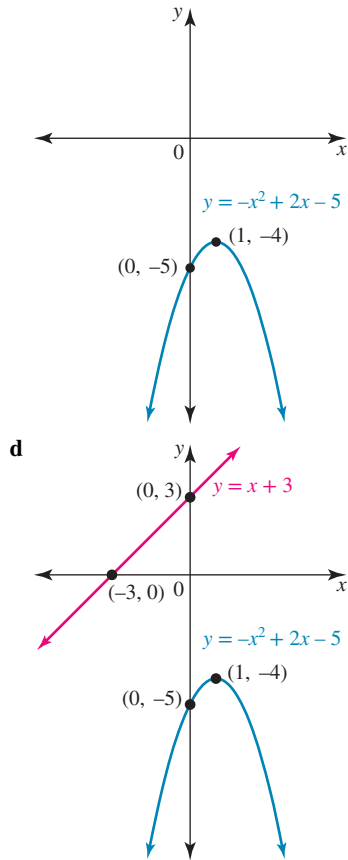

The line $y = x + 3$ passes through the points $(-3, 0)$ and $(0, 3)$. As the diagram shows, this line will never intersect the concave down parabola.

- e The graphs of $y = x + k$ and $y = -x^2 + 2x - 5$ will intersect when

$$\begin{aligned} x + k &= -x^2 + 2x - 5 \\ \therefore x^2 - x + k + 5 &= 0 \\ \text{For one intersection, } \Delta &= 0. \\ \Delta &= b^2 - 4ac, \quad a = 1, b = -1, c = k + 5 \\ &= 1 - 4(k + 5) \\ &= -4k - 19 \\ \therefore -4k - 19 &= 0 \\ \therefore k &= -\frac{19}{4} \end{aligned}$$

For exactly one intersection, $k = -\frac{19}{4}$.

12 $2x^2 = kx - 2$
 $2x^2 - kx + 2 = 0$
 $\Delta = b^2 - 4ac$
 $= (-k)^2 - 4 \times 2 \times 2$
 $= k^2 - 16$
 $\Delta < 0$
 $k^2 - 16 < 0$
 $(k - 4)(k + 4) < 0$
 $\therefore k \in (-4, 4)$

13 $x^2 - 1 = -3 - 2mx$
 $x^2 + 2mx + 2 = 0$

$$\begin{aligned} \Delta &= b^2 - 4ac \\ &= (2m)^2 - 4 \times 1 \times 2 \\ &= 4m^2 - 8 \end{aligned}$$

$$\Delta > 0$$

$$4m^2 - 8 < 0$$

$$m^2 - 2 < 0$$

$$(k - \sqrt{2})(k + \sqrt{2}) < 0$$

$$\therefore m \in (-\infty, \sqrt{2}) \cup (\sqrt{2}, \infty)$$

14 $x^2 - 2 = 2x - 3$

$$x^2 - 2x + 1 = 0$$

$$\Delta = b^2 - 4ac$$

$$= (-2)^2 - 4 \times 1 \times 1$$

$$= 4 - 4$$

$$= 0$$

As $\Delta = 0$, the graph of $y = 2x - 3$ is a tangent to the graph of $y = x^2 - 2$.

- 15 a $kx^2 - 3x + k = 0$ has no solutions if the discriminant is less than zero.

$$\Delta < 0$$

$$(-3)^2 - 4(k)(k) < 0$$

$$9 - 4k^2 < 0$$

$$(3 - 2k)(3 + 2k) < 0$$

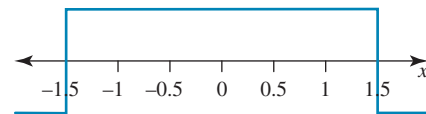

Thus, $\{k : k < -1.5\} \cup \{k : k > 1.5\}$

b $kx^2 + 4x - k + 2 = 0$

$$\Delta = 16 - 4 \times k \times (-k + 2)$$

$$= 16 + 4k^2 - 8k$$

$$= 4(k^2 - 2k + 4)$$

$$= 4(k^2 - 2k + 1^2 - 1^2 + 4)$$

$$= 4[(k + 1)^2 + 3]$$

$$= 4(k + 1)^2 + 12$$

$$\text{As } (k + 1)^2 \geq 0,$$

$$\therefore 4(k + 1)^2 \geq 0$$

$$\text{and } 4(k + 1)^2 + 12 > 0.$$

Δ is always greater than zero. Therefore, the equation will always have a solution for all values of k .

16 $(m - 1)x^2 + \left(\frac{5 - 2m}{2}\right)x + 2m = 0$

This has two solutions if the discriminant is greater than zero.

$$b^2 - 4ac > 0$$

$$\left(\frac{5 - 2m}{2}\right)^2 - 4(m - 1)2m > 0$$

Using CAS:

$$-7m^2 + 3m + \frac{25}{4} > 0$$

$$m \in \left(\frac{3 - 2\sqrt{46}}{14}, \frac{3 + 2\sqrt{46}}{14}\right) \setminus \{1\}$$

Note: $m \neq 1$ as the coefficient of x^2 would be zero if $m = 1$. Therefore, no parabola would exist.

1.4 Exam questions

1 $x^2 + 2x - k = 0$

$$\Delta = (2)^2 + 4k = 4 + 4k > 0$$

$$k > -1, (-1, \infty)$$

The correct answer is **B**.

2 $y = x^2 - 2bx + 1$

$$y = (x^2 - 2bx + b^2) + 1 - b^2$$

$$y = (x - b)^2 + 1 - b^2$$

The turning point is $V(b, 1 - b^2)$.Define the distance, s , from the origin, O , to the turning point, V , in terms of b .

$$d_{OV} = s(b) = \sqrt{b^2 + (1 - b^2)^2}$$

Enter the function in your CAS calculator and determine which b value gives the smallest value of the square root, the distance from the origin.

$$\text{When } b = \frac{1}{\sqrt{2}} \text{ or } -\frac{1}{\sqrt{2}}, \text{ the distance is } \frac{3}{4}.$$

The correct answer is **C**.

3 $y_1 = mx + c, y_2 = ax^2$

For intersection points, $y_1 = y_2$:

$$mx + c = ax^2 \Rightarrow ax^2 - mx - c = 0$$

For no points of intersection, the discriminant,

$$\Delta = m^2 + 4ac < 0.$$

$$m^2 < -4ac \Rightarrow c > -\frac{m^2}{4a} \text{ if } a < 0. \text{ Dividing by a positive does}$$

not reverse the inequality.

The correct answer is **D**.

b $3y^3 + 3y^2z^2 - 2zy - 2z^3$
$$= 3y^2(y + z^2) - 2z(y + z^2)$$
$$= (y + z^2)(3y^2 - 2z)$$

4 a $9a^2 - 16b^2 - 12a + 4$
$$= 9a^2 - 12a + 4 - 16b^2$$
$$= (3a)^2 - 2(3a)(2) + 2^2 - (4b)^2$$
$$= (3a - 2)^2 - (4b)^2$$
$$= (3a - 2 - 4b)(3a - 2 + 4b)$$

b $n^2p^2 - 4m^2 - 4m - 1$
$$= (np)^2 - (4m^2 + 4m + 1)$$
$$= (np)^2 - ((2m)^2 + 2(2m) + 1)$$
$$= (np)^2 - (2m + 1)^2$$
$$= (np - (2m + 1))(np + (2m + 1))$$
$$= (np - 2m - 1)(np + 2m + 1)$$

5 Let $P(x) = x^3 - 2x^2 - 21x - 18$.
 $P(-1) = (-1)^3 - 2(-1)^2 - 21(-1) - 18$
 $P(-1) = -1 - 2 + 21 - 18$
 $P(-1) = 0$
Thus, $(x + 1)$ is a factor.
 $x^3 - 2x^2 - 21x - 18 = (x + 1)(x^2 - 3x - 18)$
$$= (x + 1)(x - 6)(x + 3)$$

6 a $7r^3 - 49r^2 + r - 7$
$$= 7r^2(r - 7) + (r - 7)$$
$$= (r - 7)(7r^2 + 1)$$

b $36v^3 + 6v^2 + 30v + 5$
$$= 6v^2(6v + 1) + 5(6v + 1)$$
$$= (6v + 1)(6v^2 + 5)$$

c $2m^3 + 3m^2 - 98m - 147$
$$= m^2(2m + 3) - 49(2m + 3)$$
$$= (2m + 3)(m^2 - 49)$$
$$= (2m + 3)(m - 7)(m + 7)$$

d $2z^3 - z^2 + 2z - 1$
$$= z^2(2z - 1) + (2z - 1)$$
$$= (2z - 1)(z^2 + 1)$$

e $4x^2 - 28x + 49 - 25y^2$
$$= (2x - 7)^2 - (5y)^2$$
$$= (2x - 7 - 5y)(2x - 7 + 5y)$$

f $16a^2 - 4b^2 - 12b - 9$
$$= (4a)^2 - (4b^2 + 12b + 9)$$
$$= (4a)^2 - (2b + 3)^2$$
$$= (4a - (2b + 3))(4a + 2b + 3)$$
$$= (4a - 2b - 3)(4a + 2b + 3)$$

g $v^2 - 4 - w^2 + 4w$
$$= v^2 - (w^2 - 4w + 4)$$
$$= v^2 - (w - 2)^2$$
$$= (v - (w - 2))(v + (w - 2))$$
$$= (v - w + 2)(v + w - 2)$$

h $4p^2 - 1 + 4pq + q^2$
$$= 4p^2 + 4pq + q^2 - 1$$
$$= (2p + q)^2 - 1$$
$$= (2p + q - 1)(2p + q + 1)$$

1.5 Cubic functions**1.5 Exercise**

1 a $125a^3 - 27b^3 = (5a)^3 - (3b)^3$
$$= (5a - 3b)((5a)^2 + (5a)(3b) + (3b)^2)$$
$$= (5a - 3b)(25a^2 + 15ab + 9b^2)$$

b $2c^3 + 6c^2d + 6cd^2 + d^3$
$$= 2(c^3 + 3c^2d + 3cd^2 + d^3)$$
$$= 2(c + d)^3$$

c $40p^3 - 5 = 5(8p^3 - 1)$
$$= 5((2p)^3 - 1^3)$$
$$= 5(2p - 1)((2p)^2 + 2p + 1)$$
$$= 5(2p - 1)(4p^2 + 2p + 1)$$

d $8x^3 - 12x^2 + 6x - 1$
$$= (2x)^3 - 3(2x)^2(1) + 3(2x)(1)^2 - (1)^3$$
$$= (2x - 1)^3$$

2 a $27z^3 - 54z^2 + 36z - 8$
$$= (3z)^3 - 3(3z)^2(2) + 3(3z)(2)^2 + 2^3$$
$$= (3z - 2)^3$$

b $m^3n^3 + 64$
$$= (mn)^3 + 4^3$$
$$= (mn + 4)((mn)^2 - 4mn + 4^2)$$
$$= (mn + 4)(m^2n^2 - 4mn + 16)$$

3 a $3x^2 - xy - 3x + y$
$$= 3x^2 - 3x - xy + y$$
$$= 3x(x - 1) - y(x - 1)$$
$$= (x - 1)(3x - y)$$

$$\begin{aligned}
 7 \quad & 2x^3 - x^2 - 10x + 5 = 0 \\
 & x^2(2x - 1) - 5(2x - 1) = 0 \\
 & (2x - 1)(x^2 - 5) = 0 \\
 & (2x - 1)(x - \sqrt{5})(x + \sqrt{5}) = 0
 \end{aligned}$$

$$x = \frac{1}{2}, \pm\sqrt{5}$$

$$8 \text{ a Let } P(b) = b^3 + 5b^2 + 2b - 8.$$

$$P(1) = 1^3 + 5(1)^2 + 2(1) - 8 = 8 - 8 = 0$$

Thus, $b - 1$ is a factor.

$$\begin{aligned}
 b^3 + 5b^2 + 2b - 8 &= (b - 1)(b^2 + 6b + 8) \\
 &= (b - 1)(b + 2)(b + 4)
 \end{aligned}$$

$$\text{If } b^3 + 5b^2 + 2b - 8 = 0,$$

$$(b - 1)(b + 2)(b + 4) = 0$$

$$b - 1 = 0 \quad \text{or} \quad b + 2 = 0 \quad \text{or} \quad b + 4 = 0$$

$$b = 1 \qquad b = -2 \qquad b = -4$$

$$b \text{ } -2m^3 + 9m^2 - m - 12 = 0$$

$$2m^3 - 9m^2 + m + 12 = 0$$

$$\text{Let } P(m) = 2m^3 - 9m^2 + m + 12.$$

$$P(-1) = 2(-1)^3 - 9(-1)^2 - 1 + 12$$

$$= -2 - 9 - 1 + 12$$

$$= -12 + 12$$

$$= 0$$

Thus, $m + 1$ is a factor.

$$\begin{aligned}
 2m^3 - 9m^2 + m + 12 &= (m + 1)(2m^2 - 11m + 12) \\
 &= (m + 1)(2m - 3)(m - 4)
 \end{aligned}$$

$$\text{If } 2m^3 - 9m^2 + m + 12 = 0$$

$$(m + 1)(2m - 3)(m - 4) = 0$$

$$m + 1 = 0 \quad \text{or} \quad 2m - 3 = 0 \quad \text{or} \quad m - 4 = 0$$

$$m = -1 \qquad m = \frac{3}{2} \qquad m = 4$$

$$c \text{ Let } P(x) = 2x^3 - x^2 - 6x + 3.$$

$$P\left(\frac{1}{2}\right) = 2\left(\frac{1}{2}\right)^3 - \left(\frac{1}{2}\right)^2 - 6\left(\frac{1}{2}\right) + 3$$

$$= \frac{1}{4} - \frac{1}{4} - 3 + 3$$

$$= 0$$

Thus, $(2x - 1)$ is a factor.

$$2x^3 - x^2 - 6x + 3 = (2x - 1)(x^2 - 3)$$

$$\text{If } 2x^3 - x^2 - 6x + 3 = 0,$$

$$(2x - 1)(x^2 - 3) = 0$$

$$2x - 1 = 0 \quad \text{or} \quad x^2 - 3 = 0$$

$$x = \frac{1}{2} \qquad x^2 = 3$$

$$x = \pm\sqrt{3}$$

$$d \text{ } 2x^3 + 7x^2 + 2x - 3 = 0$$

$$\text{Let } P(x) = 2x^3 + 7x^2 + 2x - 3.$$

$$P(-1) = 2(-1)^3 + 7(-1)^2 + 2(-1) - 3$$

$$= -2 + 7 - 2 - 3$$

$$= 0$$

Thus, $(x + 1)$ is a factor.

$$2x^3 + 7x^2 + 2x - 3 = 0$$

$$(x + 1)(2x^2 + 5x - 3) = 0$$

$$(x + 1)(2x - 1)(x + 3) = 0$$

$$x + 1 = 0 \quad \text{or} \quad 2x - 1 = 0 \quad \text{or} \quad x + 3 = 0$$

$$x = -1 \qquad x = \frac{1}{2} \qquad x = -3$$

9 a Let $P(t) = 3t^3 + 22t^2 + 37t + 10$.

$$\begin{aligned} P(-5) &= 3(-5)^3 + 22(-5)^2 + 37(-5) + 10 \\ &= -375 + 550 - 185 + 10 \\ &= -560 + 560 \\ &= 0 \end{aligned}$$

Thus, $t + 5$ is a factor.

$$\begin{aligned} 3t^3 + 22t^2 + 37t + 10 &= (t + 5)(3t^2 + 7t + 2) \\ &= (t + 5)(t + 2)(3t + 1) \end{aligned}$$

$$\begin{aligned} \text{If } 3t^3 + 22t^2 + 37t + 10 &= 0, \\ (t + 5)(t + 2)(3t + 1) &= 0 \end{aligned}$$

$$\begin{aligned} t + 5 = 0 \quad \text{or} \quad t + 2 = 0 \quad \text{or} \quad 3t + 1 = 0 \\ = -5 \qquad \qquad = -2 \qquad \qquad = -\frac{1}{3} \end{aligned}$$

b Let $P(d) = 3d^3 - 16d^2 + 12d + 16$.

$$\begin{aligned} P(2) &= 3(2)^3 - 16(2)^2 + 12(2) + 16 \\ &= 24 - 64 + 24 + 16 \\ &= 64 - 64 \\ &= 0 \end{aligned}$$

Thus, $d - 2$ is a factor.

$$\begin{aligned} 3d^3 - 16d^2 + 12d + 16 &= (d - 2)(3d^2 - 10d - 8) \\ &= (d - 2)(d - 4)(3d + 2) \end{aligned}$$

$$\begin{aligned} \text{If } 3d^3 - 16d^2 + 12d + 16 &= 0, \\ (d - 2)(d - 4)(3d + 2) &= 0 \end{aligned}$$

$$\begin{aligned} d - 2 = 0 \quad \text{or} \quad d - 4 = 0 \quad \text{or} \quad 3d + 2 = 0 \\ d = 2 \qquad \qquad d = 4 \qquad \qquad d = -\frac{2}{3} \end{aligned}$$

10 $Ax^3 + (B - 1)x^2 + (B + C)x + D \equiv 3x^3 - x^2 + 2x - 7$

$$\begin{aligned} A = 3, \quad B - 1 = -1 \quad B + C = 2 \quad \text{and} \quad D = -7 \\ B = 0 \quad 0 + C = 2 \\ C = 2 \end{aligned}$$

11 $x^3 + 9x^2 - 2x + 1 \equiv x^3 + (dx + e)^2 + 4$

$$x^3 + 9x^2 - 2x + 1 \equiv x^3 + d^2x^2 + 2dex + e^2 + 4$$

$$d^2 = 9, \quad 2(\pm 3)e = -2$$

$$d = \pm 3 \quad \pm 6e = -2$$

$$e = \pm \frac{1}{3}$$

12 a $5z^3 - 3z^2 + 4z - 1 \equiv az^3 + bz^2 + cz + d$

$$a = 5, \quad b = -3, \quad c = 4 \quad \text{and} \quad d = -1$$

b $x^3 - 6x^2 + 9x - 1 \equiv x(x + a)^2 - b$

$$x^3 - 6x^2 + 9x - 1 \equiv x(x^2 + 2ax + a^2) - b$$

$$x^3 - 6x^2 + 9x - 1 \equiv x^3 + 2ax^2 + a^2x - b$$

$$2a = -6 \quad b = 1$$

$$a = -3$$

13 $2x^3 - 5x^2 + 5x - 5$

$$\equiv a(x - 1)^3 + b(x - 1)^2 + c(x - 1) + d$$

$$\equiv a(x^3 - 3x^2 + 3x - 1) + b(x^2 - 2x + 1) + cx - c + d$$

$$\equiv ax^3 - 3ax^2 + 3ax - a + bx^2 - 2bx + b + cx - c + d$$

$$\equiv ax^3 + (-3a + b)x^2 + (3a - 2b + c)x + (-a + b - c + d)$$

Equating coefficients:

$$a = 2 \quad -3a + b = -5 \quad 3a - 2b + c = 5 \quad -a + b - c + d = -5$$

$$-3(2) + b = -5 \quad 3(2) - 2(1) + c = 5 \quad -2 + 1 - 1 + d = -5$$

$$-6 + b = -5 \quad 6 - 2 + c = 5 \quad -2 + d = -5$$

$$b = 1 \quad 4 + c = 5 \quad d = -3$$

$$c = 1$$

$$\text{Thus, } 2x^3 - 5x^2 + 5x - 5 \equiv 2(x - 1)^3 + (x - 1)^2 + (x - 1) - 3.$$

- 14 $P(x) = ax^3 + bx^2 - 4x - 3$ where $(x + 3)$ and $(x - 1)$ are factors.

$$a(-3)^3 + b(-3)^2 - 4(-3) - 3 = 0$$

$$-27a + 9b = -9$$

$$3a - b = 1 \quad [1]$$

$$a(1)^3 + b(1)^2 - 4(1) - 3 = 0$$

$$a + b = 7 \quad [2]$$

$$[1] + [2]$$

$$4a = 8$$

$$a = 2$$

Substitute $a = 2$ into [2]: $2 + b = 7$, so $b = 5$.

- 15 $y = -4(x + 2)^3 + 16$
Stationary point of inflection at $(-2, 16)$

y-intercept: let $x = 0$.
 $\therefore y = -4(2)^3 + 16$
 $\therefore y = -16$
 $(0, -16)$
 x-intercept: let $y = 0$.
 $\therefore 0 = -4(x + 2)^3 + 16$
 $\therefore (x + 2)^3 = 4$
 $\therefore x = \sqrt[3]{4} - 2$

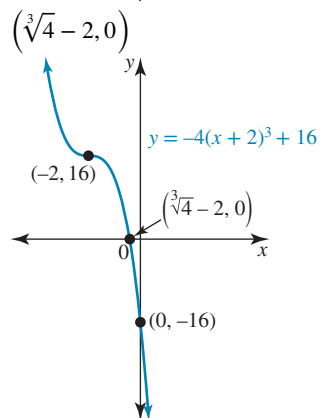

- 16 $f: [-2, 4] \rightarrow R, f(x) = 4x^3 - 8x^2 - 16x + 32$

a $4x^3 - 8x^2 - 16x + 32$
 $= 4x^2(x - 2) - 16(x - 2)$
 $= 4(x - 2)(x^2 - 4)$
 $= 4(x - 2)^2(x + 2)$

- b $f(x) = 4(x - 2)^2(x + 2), x \in [-2, 4]$
 x-intercepts: $x = 2$ (turning point), $x = -2$ (which is also an end point)
 y-intercept: $f(0) = 32 \Rightarrow (0, 32)$
 Right end point: $f(4) = 4(2)^2(6) = 96 \Rightarrow (4, 96)$

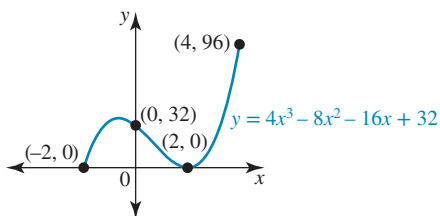

- c The maximum value of the function f is 96 and its minimum value is 0.
 17 a $y = x^3 - x^2 - 6x$
 $\therefore y = x(x^2 - x - 6)$
 $\therefore y = x(x - 3)(x + 2)$

The factors show the graph cuts the x-axis at $(0, 0)$, $(3, 0)$ and $(-2, 0)$.

The leading term has a positive coefficient.

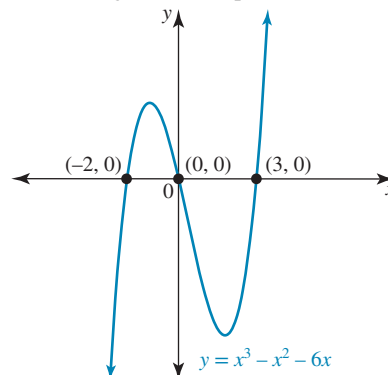

- b $y = 1 - \frac{1}{8}(x + 1)^3$
 Stationary point of inflection $(-1, 1)$
 y-intercept: let $x = 0$.

$$\therefore y = 1 - \frac{1}{8}(1)^3$$

$$\therefore y = \frac{7}{8}$$

$$\left(0, \frac{7}{8}\right)$$

x-intercept: let $y = 0$.

$$\therefore 0 = 1 - \frac{1}{8}(x + 1)^3$$

$$\therefore (x + 1)^3 = 8$$

$$\therefore x + 1 = 2$$

$$\therefore x = 1$$

$(1, 0)$

End points:

$$x = -3, y = 1 - \frac{1}{8}(-3 + 1)^3$$

$$= 1 - \frac{1}{8}(-2)^3$$

$$= 1 - \frac{1}{8} \times -8$$

$$= 2 \therefore (-3, 2)$$

$$x = 2, y = 1 - \frac{1}{8}(2 + 1)^3$$

$$= 1 - \frac{1}{8}(3)^3$$

$$= 1 - \frac{27}{8}$$

$$= -2\frac{3}{8} \therefore \left(2, -2\frac{3}{8}\right)$$

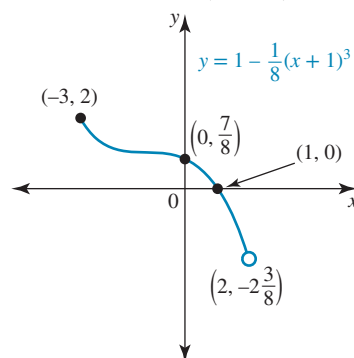

c $y = 12(x + 1)^2 - 3(x + 1)^3$
 $\therefore y = 3(x + 1)^2(4 - (x + 1))$
 $\therefore y = 3(x + 1)^2(3 - x)$
 The factors show the graph touches the x -axis at $(-1, 0)$ and cuts it at $(3, 0)$.
 y -intercept: let $x = 0$.
 $\therefore y = 3(1)^2(3) = 9$
 $(0, 9)$

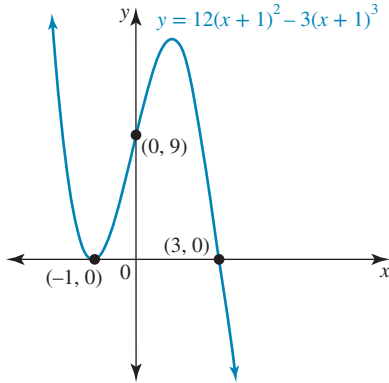

18 The x -intercepts indicate the linear factor and its multiplicity.

In the diagram each factor will have multiplicity 1.

Cut at $x = 0 \Rightarrow x$ is a factor.

Cut at $x = 0.8 = \frac{4}{5} \Rightarrow (5x - 4)$ is a factor.

Cut at $x = 1.5 = \frac{3}{2} \Rightarrow (2x - 3)$ is a factor.

Let the equation be $y = ax(5x - 4)(2x - 3)$.

Substitute the point $(2, 24)$:

$$\therefore 24 = a(2)(6)(1)$$

$$\therefore 12a = 24$$

$$\therefore a = 2$$

The equation is $y = 2x(5x - 4)(2x - 3)$.

19 The x -intercept at $x = -4 \Rightarrow (x + 4)$ is a factor.

The x -intercept at $x = \frac{5}{4} \Rightarrow (4x - 5)$ is a repeated factor of multiplicity 2.

Let the equation be $y = a(x + 4)(4x - 5)^2$.

Substitute the point $(0, 10)$:

$$\therefore 10 = a(4)(-5)^2$$

$$\therefore 10 = 100a$$

$$\therefore a = \frac{1}{10}$$

The equation is $y = \frac{1}{10}(x + 4)(4x - 5)^2$.

20 a $f(x) = -2x^3 + 9x^2 - 24x + 17$

$$f(1) = -2 + 9 - 24 + 17 = 0$$

$\therefore (x - 1)$ is a factor.

By inspection,

$$-2x^3 + 9x^2 - 24x + 17 = (x - 1)(-2x^2 + 7x - 17)$$

Consider the discriminant of the quadratic factor

$$-2x^2 + 7x - 17.$$

$$\Delta = 49 - 4(-2)(-17)$$

$$= 49 - 136$$

$$< 0$$

Since the discriminant is negative, the quadratic cannot be factorised into real linear factors and therefore it has no real zeros.

For the cubic, this means there can only be one x -intercept, the one which comes from the only linear factor $(x - 1)$.

b For there to be a stationary point of inflection, the equation of the cubic function must be able to be written in the form $y = a(x + b)^3 + c$.

$$\text{Let } -2x^3 + 9x^2 - 24x + 17 = a(x + b)^3 + c.$$

By inspection, the value of a must be -2 .

$$\therefore -2x^3 + 9x^2 - 24x + 17 = -2(x^3 + 3x^2b + 3xb^2 + b^3) + c$$

Equate coefficients of like terms:

$$x^2: 9 = -6b \Rightarrow b = -\frac{3}{2}$$

$$x: -24 = -6b^2 \Rightarrow b^2 = 4$$

It is not possible for b to have different values.

Therefore, it is not possible to express the equation of the function in the form $y = a(x + b)^3 + c$.

There is no stationary point of inflection on the graph of the function.

c The leading term has a negative coefficient. Therefore, as $x \rightarrow \pm\infty, y \rightarrow \mp\infty$.

d Given the function has a one-to-one correspondence, there cannot be any turning points on the graph. The graph of a decreasing function that has no stationary point of inflection nor any turning points and passes through $(1, 0)$ and $(0, -17)$ is required.

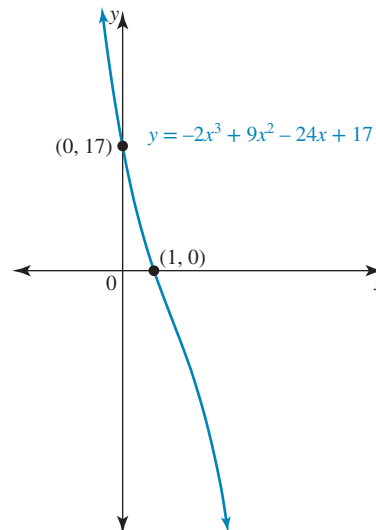

1.5 Exam questions

1 $p(x) = x^3 - 2ax^2 + x - 1$

$$p(-2) = -8 - 8a - 2 - 1 = 5$$

$$8a = -16$$

$$a = -2$$

The correct answer is **E**.

2 Let $f: [-3, 0] \rightarrow \mathbb{R}, f(x) = (x + 2)^2(x - 1)$.

a $f(x) = (x + 2)^2(x - 1)$

$$= (x^2 + 4x + 4)(x - 1)$$

$$= x^3 - x^2 + 4x^2 - 4x + 4x - 4$$

$$= x^3 + 3x^2 - 4$$

[1 mark]

b The x -intercepts are $x = -2$ and $x = 1$. ($x = 1$ is outside the domain, but it is useful to know for the shape of the graph.)

There is a maximum turning point at $(-2, 0)$.

Check for another turning point:

$$f'(x) = 3x^2 + 6x$$

$$0 = 3x(x + 2)$$

$$x = 0, -2$$

$$f(0) = (2)^2(-1) = -4$$

Therefore, there is a minimum turning point at $(0, -4)$.

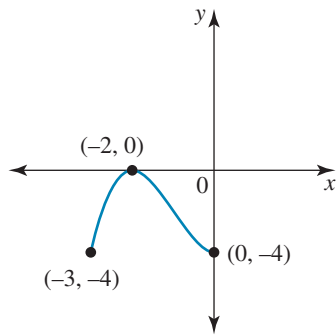

Award 1 mark for correct end points.

Award 1 mark for the maximum turning point.

Award 1 mark for correct shape.

3 First consider $f(x) = x^3 - 3x^2$.

Using CAS or calculus, there is a maximum turning point at $(0, 0)$ and a minimum turning point at $(2, -4)$.

Currently there are two x -intercepts. To obtain three distinct x -intercepts, the graph needs to be translated upwards by no more than the magnitude of the y -value of the minimum turning point.

Hence, $c \in (0, 4)$.

The correct answer is **D**.

Substitute $x = a^2$:

$$a^2 = 2, \quad a^2 = -4 \text{ (no solution)}$$

$$\therefore a = \pm\sqrt{2}$$

3 a
$$l^4 - 17l^2 + 16 = 0$$

$$(l^2 - 1)(l^2 - 16) = 0$$

$$(l - 1)(l + 1)(l - 4)(l + 4) = 0$$

$$l - 1 = 0 \text{ or } l + 1 = 0 \text{ or } l - 4 = 0 \text{ or } l + 4 = 0$$

$$l = 1 \quad l = -1 \quad l = 4 \quad l = -4$$

b
$$c^3 + 3c^2 - 4c - 12 = 0$$

 Let $P(c) = c^4 + c^3 - 10c^2 - 4c + 24$.

$$P(2) = (2)^4 + (2)^3 - 10(2)^2 - 4(2) + 24$$

$$= 16 + 8 - 40 - 8 + 24$$

$$= 48 - 48$$

$$= 0$$

Thus, $(c - 2)$ is a factor.

$$c^4 + c^3 - 10c^2 - 4c + 24 = (c - 2)(c^3 + 3c^2 - 4c - 12)$$

Let $Q(c) = c^3 + 3c^2 - 4c - 12$.

$$Q(2) = 2^3 + 3(2)^2 - 4(2) - 12$$

$$= 8 + 12 - 8 - 12$$

$$= 0$$

Thus, $(c - 2)$ is a factor.

$$c^3 + 3c^2 - 4c - 12 = (c - 2)(c^2 + 5c + 6)$$

$$= (c - 2)(c + 2)(c + 3)$$

Therefore,

$$c^4 + c^3 - 10c^2 - 4c + 24 = (c - 2)^2(c + 2)(c + 3)$$

$$(c - 2)^2(c + 2)(c + 3) = 0$$

$$c - 2 = 0 \text{ or } c + 2 = 0 \text{ or } c + 3 = 0$$

$$c = 2 \quad c = -2 \quad c = -3$$

4 a
$$a^4 - 10a^2 + 9 = 0$$

$$(a^2 - 1)(a^2 - 9) = 0$$

$$(a - 1)(a + 1)(a - 3)(a + 3) = 0$$

$$a - 1 = 0 \text{ or } a + 1 = 0 \text{ or } a - 3 = 0 \text{ or } a + 3 = 0$$

$$a = 1 \quad a = -1 \quad a = 3 \quad a = -3$$

b
$$4k^4 - 101k^2 + 25 = 0$$

$$(4k^2 - 1)(k^2 - 25) = 0$$

$$(2k - 1)(2k + 1)(k - 5)(k + 5) = 0$$

$$2k - 1 = 0 \text{ or } 2k + 1 = 0 \text{ or } k - 5 = 0 \text{ or } k + 5 = 0$$

$$k = \frac{1}{2} \quad k = -\frac{1}{2} \quad k = 5 \quad k = -5$$

c
$$9z^4 - 145z^2 + 16 = 0$$

$$(9z^2 - 1)(z^2 - 16) = 0$$

$$(3z - 1)(3z + 1)(z - 4)(z + 4) = 0$$

$$3z - 1 = 0 \text{ or } 3z + 1 = 0 \text{ or } z - 4 = 0 \text{ or } z + 4 = 0$$

$$z = \frac{1}{3} \quad z = -\frac{1}{3} \quad z = 4 \quad z = -4$$

d
$$(x^2 - 2x)^2 - 47(x^2 - 2x) - 48 = 0$$

 Let $A = (x^2 - 2x)$.

$$A^2 - 47A - 48 = 0$$

$$(A - 48)(A + 1) = 0$$

$$(x^2 - 2x - 48)(x^2 - 2x + 1) = 0$$

$$(x - 8)(x + 6)(x - 1)^2 = 0$$

$$x - 8 = 0 \text{ or } x + 6 = 0 \text{ or } x - 1 = 0$$

$$x = 8 \quad x = -6 \quad x = 1$$

5 $P(x) = x^4 + ax^3 + bx^2 + cx + 24$ where $(x + 2)$, $(x - 3)$ and $(x + 4)$ are factors.

1.6 Higher degree polynomials

1.6 Exercise

1 Let $P(x) = x^4 - 5x^3 - 32x^2 + 180x - 144$.

$$P(1) = (1)^4 - 5(1)^3 - 32(1)^2 + 180(1) - 144$$

$$P(1) = 1 - 5 - 32 + 180 - 144$$

$$P(1) = 181 - 181$$

$$P(1) = 0$$

Thus, $(x - 1)$ is a factor.

$$x^4 - 5x^3 - 32x^2 + 180x - 144 = (x - 1)(x^3 - 4x^2 - 36x + 144)$$

Let $Q(x) = x^3 - 4x^2 - 36x + 144$.

$$Q(2) = 2^3 - 4(2)^2 - 36(2) + 144 \neq 0$$

$$Q(4) = 4^3 - 4(4)^2 - 36(4) + 144$$

$$= 64 - 64 - 144 + 144$$

$$= 0$$

Thus, $(x - 4)$ is a factor.

$$x^3 - 4x^2 - 36x + 144 = (x - 4)(x^2 - 36)$$

$$= (x - 4)(x - 6)(x + 6)$$

So,

$$x^4 - 5x^3 - 32x^2 + 180x - 144 = (x - 1)(x - 4)(x - 6)(x + 6)$$

2 a $x^4 - 8x^3 + 17x^2 + 2x - 24 = 0$

$$(x - 4)(x - 3)(x - 2)(x + 1) = 0$$

$$x - 4 = 0 \quad x - 3 = 0 \quad x - 2 = 0 \quad x + 1 = 0$$

$$x = 4, \quad x = 3, \quad x = 2, \quad x = -1$$

b $a^4 + 2a^2 - 8 = 0$

Let $x = a^2$.

$$x^2 + 2x - 8 = 0$$

$$(x - 2)(x + 4) = 0$$

$$x = 2, -4$$

$$\begin{aligned} (-2)^4 + a(-2)^3 + b(-2)^2 + c(-2) + 24 &= 0 \\ 16 - 8a + 4b - 2c + 24 &= 0 \\ -8a + 4b - 2c &= -40 \\ 4a - 2b + c &= 20 \end{aligned} \quad [1]$$

$$\begin{aligned} (3)^4 + a(3)^3 + b(3)^2 + c(3) + 24 &= 0 \\ 81 + 27a + 9b + 3c + 24 &= 0 \\ 27a + 9b + 3c &= -105 \\ 9a + 3b + c &= -35 \end{aligned} \quad [2]$$

$$\begin{aligned} (-4)^4 + a(-4)^3 + b(-4)^2 + c(-4) + 24 &= 0 \\ 256 - 64a + 16b - 4c + 24 &= 0 \\ -64a + 16b - 4c &= -280 \\ 16a - 4b + c &= 70 \end{aligned} \quad [3]$$

Solve using CAS: $a = 2$, $b = -13$ and $c = -14$.

$$\begin{aligned} 6 \quad y &= x^2 - x^4 \\ y &= x^2(1 - x^2) \\ &= x^2(1 - x)(1 + x) \end{aligned}$$

The graph has a turning point at $(0, 0)$ and cuts the x -axis at $(\pm 1, 0)$.

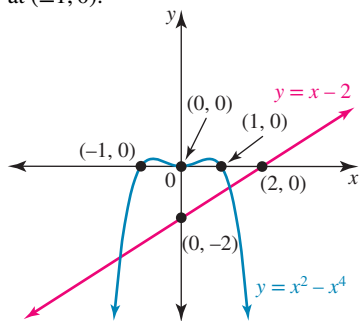

Rearranging the equation $x^4 - x^2 + x - 2 = 0$ gives $x - 2 = x^2 - x^4$.

The number of intersections of the line $y = x - 2$ with the graph of $y = x^2 - x^4$ will be the number of solutions of the equation.

The line $y = x - 2$ passes through $(0, -2)$ and $(2, 0)$. It is drawn on the diagram, showing it makes two intersections with the quartic curve.

There are two solutions to the equation $x^4 - x^2 + x - 2 = 0$.

$$\begin{aligned} 7 \quad y &= x^4 - 6x^3 \\ \therefore y &= x^3(x - 6) \end{aligned}$$

The graph has a stationary point of inflection at $(0, 0)$ and cuts the x -axis at $(6, 0)$.

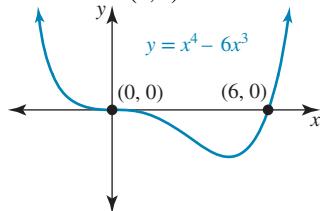

The graph of $y = x^4 - 6x^3 + 1$ is a vertical translation of 1 unit upwards of the graph of $y = x^4 - 6x^3$. Its point of inflection would lie above the axis, but the graph would still intersect the x -axis at a point between $x = 0$ and $x = 6$ as well as at a point where $x > 6$. There will be two intersections.

Check: a point below the axis, such as $(1, -5)$ for example, would still lie below the x -axis if it was vertically translated up one unit, so the graph must cross the axis to reach this point.

$$8 \quad y = a(x + b)^4 + c$$

The axis of symmetry $x = -b$ lies midway between the

x -intercepts.

$$\therefore -b = \frac{-9 - 3}{2}$$

$$\therefore b = 6$$

$$y = a(x + 6)^4 + c$$

As the range is $(-\infty, 7]$, the maximum turning point is $(-6, 7)$.

The equation becomes $y = a(x + 6)^4 + 7$.

Substitute the point $(-3, 0)$:

$$\therefore 0 = a(3)^4 + 7$$

$$\therefore a = -\frac{7}{81}$$

The equation is $y = -\frac{7}{81}(x + 6)^4 + 7$ with

$$a = -\frac{7}{81}, b = 6, c = 7.$$

Therefore, the turning point is $(-6, 7)$.

9 Draw the graphs using CAS. At the intersection of the two graphs, $x^4 - 2 = 2 - x^3$.

Therefore, $x^4 + x^3 - 4 = 0$. The roots of the equation are the x -coordinates of the points of intersection of the two graphs. Use CAS to obtain these.

To 2 decimal places the roots are $x = -1.75$ and $x = 1.22$.

10 Sketch each graph and use the tools to obtain the points required.

$$a \quad y = (x^2 + x + 1)(x^2 - 4)$$

Minimum turning points $(-1.31, -3.21)$ and $(1.20, -9.32)$, maximum turning point $(-0.64, -2.76)$

$$b \quad y = 1 - 4x - x^2 - x^3$$

No turning points or stationary point of inflection

$$c \quad y = \frac{1}{4}((x - 2)^5(x + 3) + 80)$$

Minimum turning point $(-2.17, -242)$, stationary point of inflection $(2, 20)$

$$11 \quad y = (x + 1)^6 + 10$$

Minimum turning point $(-1, 10)$

There are no x -intercepts as the turning point lies above the x -axis

y -intercept: let $x = 0$.

$$\therefore y = (1)^6 + 10$$

$$\therefore y = 11$$

$$(0, 11)$$

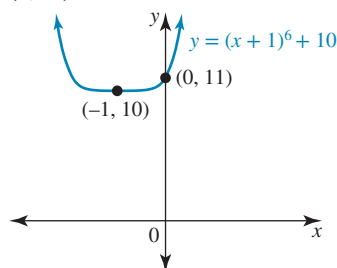

$$12 \quad y = (x + 4)(x + 2)^2(x - 2)^3(x - 5)$$

The graph cuts the x -axis at $x = -4$, touches the axis at $x = -2$, saddle cuts the axis at $x = 2$ and cuts the axis at $x = 5$. Its degree is 7 and the leading coefficient is positive. Its long-term behaviour is as $x \rightarrow \pm\infty, y \rightarrow \pm\infty$.

y -intercept: let $x = 0$.

$$\therefore y = (4)(2)^2(-2)^3(-5)$$

$$\therefore y = 640$$

$$(0, 640)$$

The y -intercept is positive.

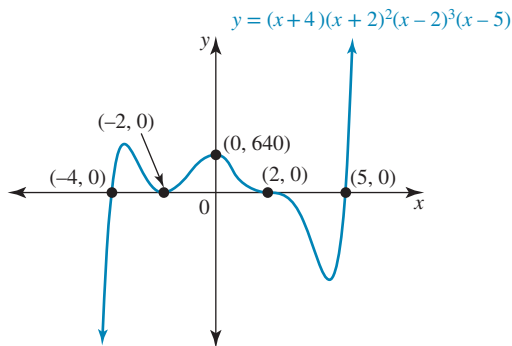

- 13 a Let the equation be $y = a(x - h)^4 + k$.

The turning point is $(-5, 12)$.

$$\therefore y = a(x + 5)^4 + 12$$

Substitute the point $(-3, -36)$:

$$\therefore -36 = a[2]^4 + 12$$

$$\therefore 16a = -48$$

$$\therefore a = -3$$

The equation is $y = -3(x + 5)^4 + 12$.

- b $y = (2 + x)(1 - x)^3$

There is an x -intercept at $(-2, 0)$ and a stationary point of inflection at $(1, 0)$.

The y -intercept is $(0, 2)$.

The coefficient of x^4 is negative.

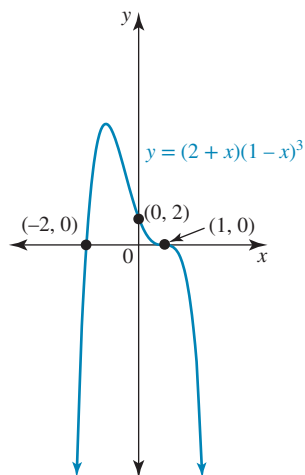

- c i $-x^4 + x^3 + 10x^2 - 4x - 24$

$$\text{Let } f(x) = -x^4 + x^3 + 10x^2 - 4x - 24.$$

By trial and error,

$$f(2) = -16 + 8 + 40 - 8 - 24 = 0 \Rightarrow (x - 2) \text{ is a factor.}$$

$$f(-2) = -16 - 8 + 40 + 8 - 24 = 0 \Rightarrow (x + 2) \text{ is a factor.}$$

Therefore, $(x - 2)(x + 2) = x^2 - 4$ is a factor.

By inspection,

$$-x^4 + x^3 + 10x^2 - 4x - 24$$

$$= (x^2 - 4)(-x^2 + x + 6)$$

$$= -(x^2 - 4)(x^2 - x - 6)$$

$$= -(x - 2)(x + 2)(x - 3)(x + 2)$$

$$= -(x + 2)^2(x - 2)(x - 3)$$

- ii $y = -x^4 + x^3 + 10x^2 - 4x - 24$

$$\therefore y = -(x + 2)^2(x - 2)(x - 3)$$

The factors indicate there is a turning point at $(-2, 0)$ and two other x -intercepts at $(2, 0)$ and $(3, 0)$.

The y -intercept is $(0, -24)$.

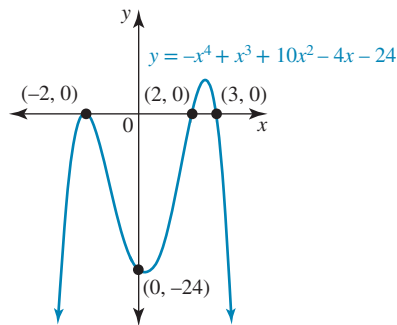

- 14 a i $y = x^6$ and $y = x^7$

$y = x^6$ is of even degree, so its graph has similarities with $y = x^2$.

$y = x^7$ is of odd degree, so its graph has similarities with $y = x^3$. As it has the higher degree, it will be steeper than $y = x^6$ for $x > 1$.

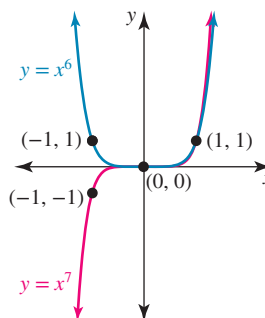

The points of intersection of the two graphs are $(0, 0)$ and $(1, 1)$.

- ii $\{x : x^6 + x^7 \geq 0\}$

$x^6 - x^7 \geq 0$ when $x^6 + x^7$. The graph of $y = x^6$ lies above that of $y = x^7$ for $x < 0$ and $0 < x < 1$, and the two graphs intersect at $x = 0$ and $x = 1$. Hence,

$$\{x : x^6 - x^7 \geq 0\} = \{x : x \leq 1\}$$

- b $y = 16 - (x + 2)^4$

The equation is of even degree, so there is a maximum turning point at $(-2, 16)$.

y -intercept: let $x = 0$.

$$\therefore y = 0 \Rightarrow (0, 0).$$

Axis of symmetry $x = -2 \Rightarrow (-4, 0)$ is the other x -intercept.

$$y = 16 - (x + 2)^5$$

This equation is of odd degree, so there is a stationary point of inflection at $(-2, 16)$.

y -intercept: let $x = 0$.

$$\therefore y = 16 - 32 = -16 \Rightarrow (0, 16).$$

x -intercept: let $y = 0$.

$$\therefore 0 = 16 - (x + 2)^5$$

$$\therefore (x + 2)^5 = 16 \quad \left(2 + \sqrt[5]{16}, 0\right)$$

$$\therefore x = -2 + \sqrt[5]{16}$$

Points of intersection of the two graphs occur when:

$$16 - (x + 2)^4 = 16 - (x + 2)^5$$

$$\therefore (x + 2)^4 = (x + 2)^5$$

$$\therefore (x + 2)^4 [1 - (x + 2)] = 0$$

$$\therefore (x + 2)^4 (-1 - x) = 0$$

$$\therefore x = -2 \text{ or } x = -1$$

The points of intersection are $(-2, 16)$ and $(-1, 15)$.

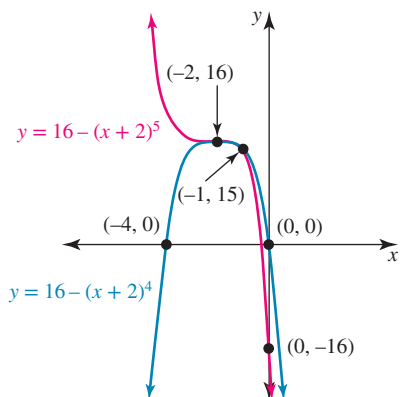

- c i** The x -intercepts determine the factors.
 The graph touches the x -axis at $x = -3 \Rightarrow (x + 3)^2$ is a factor.
 The graph cuts the x -axis at $x = -1 \Rightarrow (x + 1)$ is a factor.
 The graph saddle cuts the x -axis at $x = 2 \Rightarrow (x - 2)^3$ is a factor.
 These factors imply the degree is $2 + 1 + 3 = 6$. The shape suggests the long-term behaviour of an even degree polynomial function with a positive leading term.
 The equation is of the form
 $y = a(x + 3)^2(x + 1)(x - 2)^3$.
 Since it is a monic polynomial, $a = 1$. Therefore, the equation is $y = (x + 3)^2(x + 1)(x - 2)^3$, degree 6.
- ii** An additional cut at $x = 10 \Rightarrow (x - 10)$ is also a factor.
 The graph would now have the behaviour that as $x \rightarrow \infty$, $y \rightarrow \infty$, showing it to be an odd degree function with a negative coefficient of its leading term.
 The degree is 7 and a possible equation is
 $y = (x + 3)^2(x + 1)(x - 2)^3(10 - x)$.

1.6 Exam questions

1

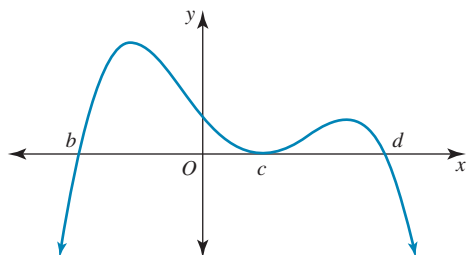

The graph is a negative quartic, crosses at $x = b$, $x = c$ is a double root, and $x = d$. Its equation could be $y = -k(x - b)(x - c)^2(x - d)$, $k > 0$, $k = 2$.
 The correct answer is C.

VCAA Assessment Report note:

Most students chose option A,
 $y = -2(x + b)(x - c)2(x - d)$,
 but the factor $(x + b)$ is incorrect.

2 $-x^4 + 7x^3 - 12x^2 = 0$
 $-x^2(x^2 - 7x + 12) = 0$
 $-x^2(x - 4)(x - 3) = 0$

$$x = 0, 4, 3 \quad [1 \text{ mark}]$$

The graph is inverted, so when solving $-x^4 + 7x^3 - 12x^2 \geq 0$, the graph is only above the x -axis between $x = 3$ and $x = 4$,

and is equal to zero at the x -intercepts.

Therefore, $x \in [3, 4] \cup \{0\}$. [1 mark]

3 $y = a(x + 3)(x + 1)(x - 2)(x - 4)$

When $x = 0$, $y = -24$.

Now $-24 = 24a$, so $a = -1$.

$$\therefore y = -(x + 3)(x + 1)(x - 2)(x - 4)$$

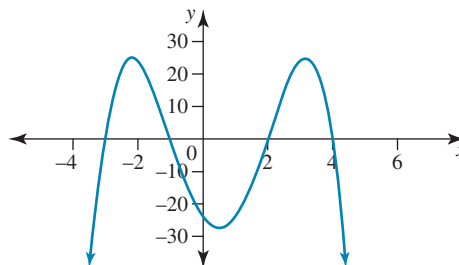

The correct answer is C.

1.7 Other algebraic functions

1.7 Exercise

1 a $y = \frac{x - 6}{x + 9}$

If $x + 9 = 0$, then $x = -9$ and the function would be undefined.

The domain is $R \setminus \{-9\}$.

b $y = \sqrt{1 - 2x}$

The domain requires $1 - 2x \geq 0$.

$$\therefore x \leq \frac{1}{2}$$

The domain is $\left(-\infty, \frac{1}{2}\right]$.

c $\frac{-2}{(x + 3)^2}$

The denominator would be zero if $x = -3$, so the domain is $R \setminus \{-3\}$.

d $\frac{1}{x^2 + 3}$

Since the denominator is the sum of two positive terms, it can never be zero, so the domain is R .

2 a Let the equation be $y = \frac{a}{x - h} + k$.

The asymptotes are $x = -3$ and $y = 1$.

$$\therefore y = \frac{a}{x + 3} + 1$$

The graph has an x -intercept at $x = -9$.

Substitute the point $(-9, 0)$:

$$\therefore 0 = \frac{a}{-6} + 1$$

$$\therefore a = 6$$

The equation is $y = \frac{6}{x + 3} + 1$.

b i $y = \frac{5x - 2}{x - 1}$

If $x = 1$, the denominator would be zero and the function would be undefined. Its maximal domain is $R \setminus \{1\}$.

$$\begin{aligned} \text{ii } \frac{5x-2}{x-1} &= \frac{5(x-1)+3}{x-1} \\ &= 5 + \frac{3}{x-1} \end{aligned}$$

$$y = 5 + \frac{3}{x-1} \text{ has asymptotes } x = 1, y = 5.$$

y-intercept: let $x = 0$, then $y = 2 \Rightarrow (0, 2)$

x-intercept: let $y = 0$.

$$\therefore \frac{5x-2}{x-1} = 0$$

$$\therefore 5x - 2 = 0$$

$$\therefore x = \frac{2}{5}$$

$$\left(\frac{2}{5}, 0\right)$$

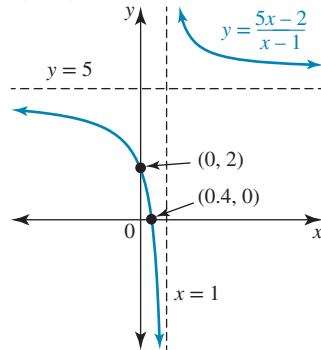

The range is $R \setminus \{5\}$.

$$3 \quad y = \frac{4}{1-2x}$$

Vertical asymptote: $1 - 2x = 0 \Rightarrow x = \frac{1}{2}$ is the vertical asymptote.

The horizontal asymptote is $y = 0$. There is no x-intercept.

y-intercept: let $x = 0$.

$$\therefore y = 4(0, 4)$$

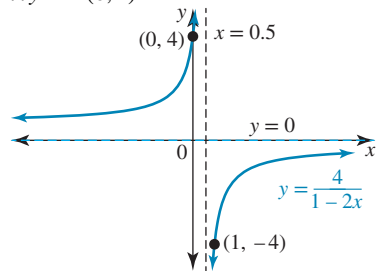

Domain $R \setminus \left\{\frac{1}{2}\right\}$ and range $R \setminus \{0\}$

$$4 \quad \text{a } y = \frac{4}{x} + 5$$

Asymptotes: $x = 0, y = 5$

No y-intercept

x-intercept: let $y = 0$.

$$\therefore \frac{4}{x} + 5 = 0$$

$$\therefore 4 = -5x$$

$$\therefore x = -\frac{4}{5}$$

$$\left(-\frac{4}{5}, 0\right)$$

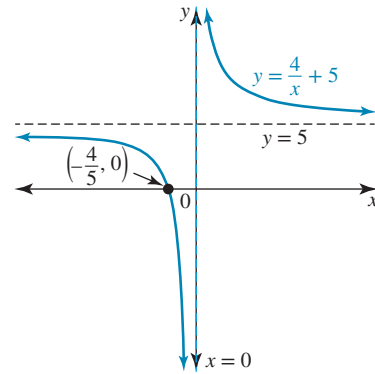

Domain $R \setminus \{0\}$ and range $R \setminus \{5\}$

$$\text{b } y = 2 - \frac{3}{x+1}$$

Asymptotes: $x = -1, y = 2$

y-intercept: let $x = 0$.

$$\therefore y = 2 - \frac{3}{1} = -1$$

$$(0, -1)$$

x-intercept: let $y = 0$.

$$\therefore 2 - \frac{3}{x+1} = 0$$

$$\therefore 2 = \frac{3}{x+1}$$

$$\therefore 2x + 2 = 3$$

$$\therefore x = \frac{1}{2}$$

$$\left(\frac{1}{2}, 0\right)$$

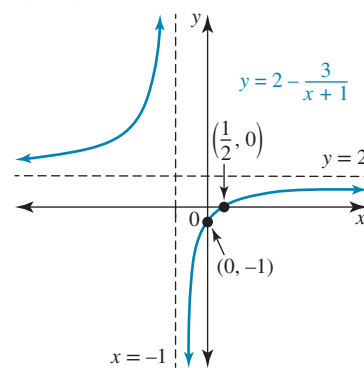

Domain $R \setminus \{-1\}$ and range $R \setminus \{2\}$

$$\text{c } y = \frac{4x+3}{2x+1}$$

$$\therefore y = \frac{2(2x+1)+1}{2x+1}$$

$$\therefore y = 2 + \frac{1}{2x+1}$$

Asymptotes: $2x + 1 = 0 \Rightarrow x = -\frac{1}{2}, y = 2$

y-intercept: let $x = 0$.

$$\therefore y = \frac{3}{1} = 3$$

$$(0, 3)$$

x-intercept: let $y = 0$.

$$\therefore \frac{4x+3}{2x+1} = 0$$

$$\therefore 4x + 3 = 0$$

$$\therefore x = -\frac{3}{4}$$

$$\left(-\frac{3}{4}, 0\right)$$

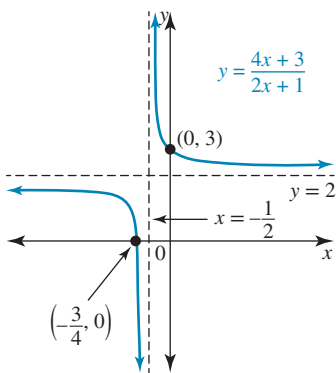

Domain $\mathbb{R} \setminus \{-\frac{1}{2}\}$ and range $\mathbb{R} \setminus \{2\}$

d $xy + 2y + 5 = 0$

$$\therefore y(x + 2) = -5$$

$$\therefore y = \frac{-5}{x + 2}$$

Asymptotes: $x = -2, y = 0$

No x -intercept.

y -intercept: let $x = 0$.

$$\therefore y = \frac{-5}{2} = -2.5$$

$(0, -2.5)$

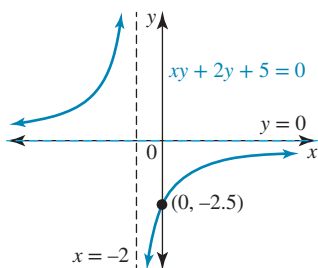

Domain $\mathbb{R} \setminus \{-2\}$ and range $\mathbb{R} \setminus \{0\}$

e $y = \frac{10}{5-x} - 5$

Asymptotes: $5 - x = 0 \Rightarrow x = 5, y = -5$

y -intercept: let $x = 0$.

$$\therefore y = \frac{10}{5} - 5 = -3$$

$(0, -3)$

x -intercept: let $y = 0$.

$$\therefore \frac{10}{5-x} - 5 = 0$$

$$\therefore 10 = 5(5-x)$$

$$\therefore 5 - x = 2$$

$$\therefore x = 3$$

$(3, 0)$

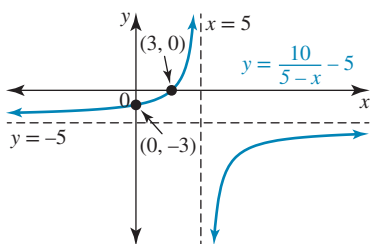

Domain $\mathbb{R} \setminus \{5\}$ and range $\mathbb{R} \setminus \{-5\}$

5 a Let the equation be $y = \frac{a}{x-h} + k$.

Asymptotes $x = -3$ and $y = 6$

$$\therefore y = \frac{a}{x+3} + 6$$

Substitute the point $(-4, 8)$:

$$\therefore 8 = \frac{a}{-1} + 6$$

$$\therefore a = -2$$

The equation is $y = \frac{-2}{x+3} + 6$.

b Let the equation be $y = \frac{a}{x-h} + k$.

Asymptotes $x = -2$ and $y = -\frac{3}{2}$

$$\therefore y = \frac{a}{x+2} - \frac{3}{2}$$

Substitute the point $(-3, -2)$:

$$\therefore -2 = \frac{a}{-1} - \frac{3}{2}$$

$$\therefore a = \frac{1}{2}$$

The equation is $y = \frac{1}{2(x+2)} - \frac{3}{2}$.

6 $y = \frac{8}{(x+2)^2} - 2$

Asymptotes: $x = -2, y = -2$

y -intercept: let $x = 0$.

$$\therefore y = \frac{8}{(2)^2} - 2$$

$$\therefore y = 0$$

The origin is the intercept on both the axes. By symmetry about the vertical axis, there is another x -intercept at $(-4, 0)$.

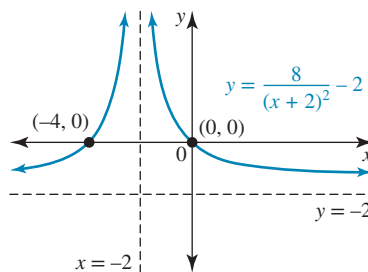

Domain $\mathbb{R} \setminus \{-2\}$ and range $(-2, \infty)$

7 a $y = \frac{2}{(3-x)^2} + 1$ or $y = \frac{2}{(x-3)^2} + 1$

Asymptotes: $x = 3, y = 1$

y -intercept: let $x = 0$.

$$\therefore y = \frac{2}{9} + 1 = \frac{11}{9}$$

$$\left(0, \frac{11}{9}\right)$$

There are no x -intercepts as the graph lies above its horizontal asymptote.

The point $\left(6, \frac{11}{9}\right)$ is symmetric about the vertical asymptote to $\left(0, \frac{11}{9}\right)$.

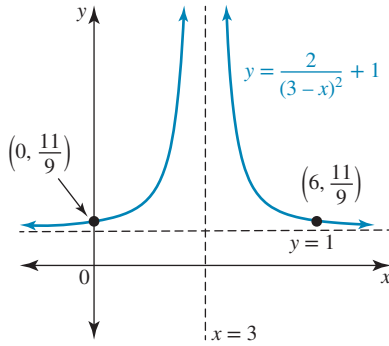

Domain $\mathbb{R} \setminus \{3\}$ and range $(1, \infty)$

$$\text{b } y = \frac{-3}{4(x-1)^2} - 2$$

Asymptotes: $x = 1, y = -2$

y -intercept: let $x = 0$.

$$\therefore y = \frac{-3}{4} - 2 = -\frac{11}{4}$$

$$\left(0, -\frac{11}{4}\right)$$

There are no x -intercepts as the graph lies below its horizontal asymptote.

The point $\left(2, -\frac{11}{4}\right)$ is symmetric about the vertical asymptote to $\left(0, -\frac{11}{4}\right)$.

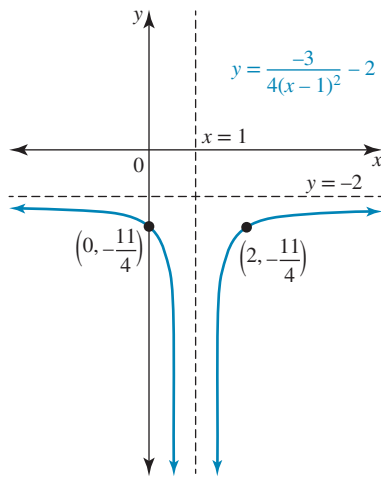

Domain $\mathbb{R} \setminus \{1\}$ and range $(-\infty, -2)$

$$\text{c } y = \frac{1}{(2x+3)^2} - 1$$

Asymptotes: $2x + 3 = 0 \Rightarrow x = -\frac{3}{2}, y = -1$

y -intercept: let $x = 0$.

$$\therefore y = \frac{1}{9} - 1 = -\frac{8}{9}$$

$$\left(0, -\frac{8}{9}\right)$$

x -intercepts: let $y = 0$.

$$\therefore \frac{1}{(2x+3)^2} - 1 = 0$$

$$\therefore 1 = (2x+3)^2$$

$$\therefore 2x + 3 = \pm 1$$

$$\therefore 2x = -4 \text{ or } -2$$

$$\therefore x = -2 \text{ or } x = -1$$

$(-2, 0), (-1, 0)$

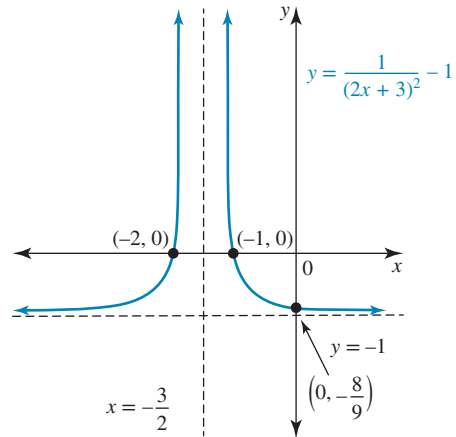

Domain $\mathbb{R} \setminus \left\{-\frac{3}{2}\right\}$ and range $(-1, \infty)$

$$\text{d } y = \frac{25x^2 - 1}{5x^2}$$

$$\therefore y = \frac{25x^2}{5x^2} - \frac{1}{5x^2}$$

$$\therefore y = 5 - \frac{1}{5x^2}$$

Asymptotes: $x = 0, y = 5$

No y -intercept

x -intercepts: let $y = 0$.

$$\therefore \frac{25x^2 - 1}{5x^2} = 0$$

$$\therefore 25x^2 - 1 = 0$$

$$\therefore x^2 = \frac{1}{25}$$

$$\therefore x = \pm \frac{1}{5}$$

$$\left(\pm \frac{1}{5}, 0\right)$$

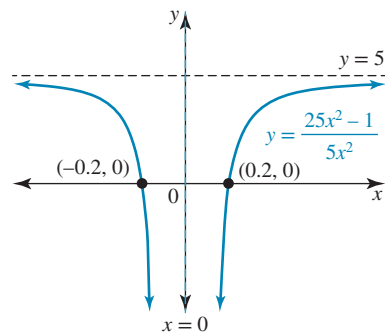

Domain $\mathbb{R} \setminus \{0\}$ and range $(-\infty, 5)$

8 Let the equation be $y = \frac{a}{(x-h)^2} + k$

The asymptotes are $x = 0$ and $y = -1$.

$$\therefore y = \frac{a}{x^2} - 1$$

Substitute the point $\left(\frac{1}{2}, 0\right)$:

$$\therefore 0 = \frac{a}{\left(\frac{1}{2}\right)^2} - 1$$

$$\therefore 0 = 4a - 1$$

$$\therefore a = \frac{1}{4}$$

The equation is $y = \frac{1}{4x^2} - 1$.

9 a Let the equation be $y = \frac{a}{(x-h)^2} + k$.

The asymptotes are $x = 4$ and $y = 2$.

$$\therefore y = \frac{a}{(x-4)^2} + 2$$

Substitute the point $(5, -1)$:

$$\therefore -1 = \frac{a}{1} + 2$$

$$\therefore a = -3$$

The equation is $y = \frac{-3}{(x-4)^2} + 2$.

b Let the equation of the graph be $y = \frac{a}{(x-h)^2} + k$.

As the range is $(-4, \infty)$, the horizontal asymptote is $y = -4$.

$$\therefore y = \frac{a}{(x-h)^2} - 4$$

Given $f(-1) = 8$ and $f(2) = 8$, the points $(-1, 8)$ and $(2, 8)$ lie on the graph. As these points have the same y -coordinate, they must be symmetrically placed around the vertical asymptote.

Therefore, the vertical asymptote is $x = \frac{-1+2}{2} = \frac{1}{2}$

The equation becomes $y = \frac{a}{(x-\frac{1}{2})^2} - 4$

This can be written as $y = \frac{4a}{(2x-1)^2} - 4$ or

$$y = \frac{b}{(2x-1)^2} - 4, \text{ where } b = 4a.$$

Substitute the point $(2, 8)$:

$$\therefore 8 = \frac{b}{9} - 4$$

$$\therefore b = 108$$

The equation of the graph is $y = \frac{108}{(2x-1)^2} - 4$.

The domain is $\mathbb{R} \setminus \left\{ \frac{1}{2} \right\}$, so the function is

$$f: \mathbb{R} \setminus \left\{ \frac{1}{2} \right\} \rightarrow \mathbb{R}, f(x) = \frac{108}{(2x-1)^2} - 4.$$

10 a $y = -\sqrt{x+9} + 2$

i For the function to have real values, $x+9 \geq 0$. This means $x \geq -9$, so the maximal domain is $[-9, \infty)$.

ii End point: $(-9, 2)$

y -intercept: let $x = 0$.

$$\therefore y = -\sqrt{9} + 2$$

$$\therefore y = -1$$

$$(-1, 0)$$

x -intercept: let $y = 0$.

$$\therefore 0 = -\sqrt{x+9} + 2$$

$$\therefore \sqrt{x+9} = 2$$

$$\therefore x+9 = 4$$

$$\therefore x = -5$$

$$(-5, 0)$$

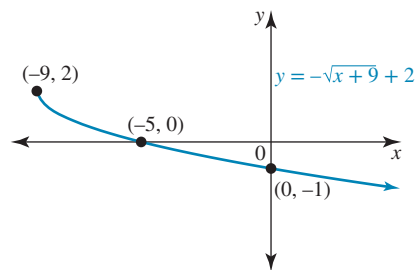

Range is $(-\infty, 2]$.

b Let the equation be $y = a\sqrt[3]{x-h} + k$.

The point of inflection is $(1, 3)$.

$$\therefore y = a\sqrt[3]{x-1} + 3$$

Substitute the point $(0, 1)$:

$$\therefore 1 = a\sqrt[3]{-1} + 3$$

$$\therefore 1 = -a + 3$$

$$\therefore a = 2$$

The equation is $y = 2\sqrt[3]{x-1} + 3$.

x -intercept: let $y = 0$.

$$\therefore 2\sqrt[3]{x-1} + 3 = 0$$

$$\therefore \sqrt[3]{x-1} = -\frac{3}{2}$$

$$\therefore x-1 = \left(-\frac{3}{2}\right)^3$$

$$\therefore x = 1 - \frac{27}{8}$$

$$\therefore x = -\frac{19}{8}$$

The x -intercept is $\left(-\frac{19}{8}, 0\right)$.

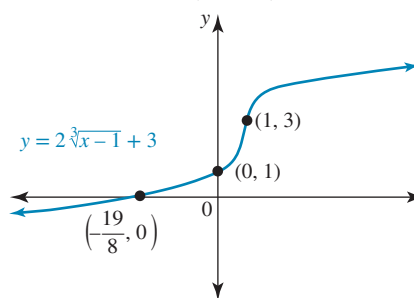

11 a $y = 3\sqrt{4x-9} - 6$

The domain requires $4x-9 \geq 0 \Rightarrow x \geq \frac{9}{4}$.

The maximal domain is $\left[\frac{9}{4}, \infty\right)$.

End point: when $4x-9 = 0$, $x = \frac{9}{4}$.

The end point is $\left(\frac{9}{4}, -6\right)$.

There is no y -intercept.

x -intercept: let $y = 0$.

$$\therefore 3\sqrt{4x-9} - 6 = 0$$

$$\therefore \sqrt{4x-9} = 2$$

$$\therefore 4x-9 = 4$$

$$\therefore 4x = 13$$

$$\therefore x = \frac{13}{4}$$

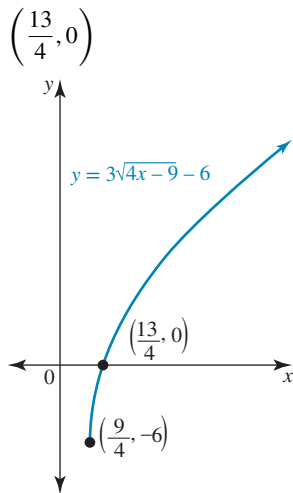

The range is $[-6, \infty)$.

- b** $y = (10 - 3x)^{\frac{1}{3}}$. This is the cube root function
 $y = \sqrt[3]{10 - 3x}$.

When $10 - 3x = 0$, $x = \frac{10}{3}$, so the point of inflection

is $(\frac{10}{3}, 0)$.

The point of inflection lies on the x -axis.

y -intercept: let $x = 0$.

$$\therefore y = \sqrt[3]{10} \Rightarrow (0, \sqrt[3]{10})$$

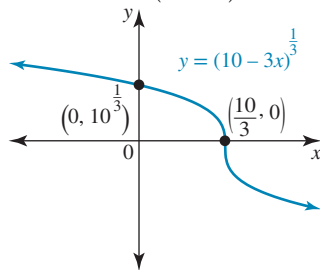

- 12 a** $(y - 2)^2 = 4(x - 3)$
 $\therefore y - 2 = \pm\sqrt{4(x - 3)}$
 $\therefore y = 2 \pm 2\sqrt{x - 3}$

The upper branch is the function with rule
 $y = 2\sqrt{x - 3} + 2$. Its domain is $[3, \infty)$.

Its end point is $(3, 2)$, so its range is $[2, \infty)$.

The other function is the lower branch $y = -2\sqrt{x - 3} + 2$
 with the same domain $[3, \infty)$ but range $(-\infty, 2]$.

- b** $y^2 + 2y + 2x = 5$

Completing the square:

$$(y^2 + 2y + 1) - 1 + 2x = 5$$

$$\therefore (y + 1)^2 = 6 - 2x$$

$$\therefore y + 1 = \pm\sqrt{6 - 2x}$$

$$\therefore y = \pm\sqrt{6 - 2x} - 1$$

The upper branch is the function with rule

$$y = \sqrt{6 - 2x} - 1 \text{ and end point } (3, -1).$$

Its domain requires $6 - 2x \geq 0 \Rightarrow x \leq 3$. The domain is
 $(-\infty, 3]$ and the range is $(-1, \infty]$.

The lower branch is the function with rule

$$y = -\sqrt{6 - 2x} - 1. \text{ Its domain is } (-\infty, 3] \text{ and its range}$$

is $(-\infty, -1]$.

- 13 a** $y = 1 - \sqrt{3x}$

Domain: $3x \geq 0 \Rightarrow x \geq 0$. The domain is $[0, \infty)$.

End point: $(0, 1)$, which is also the y -intercept

x -intercept: let $y = 0$.

$$\therefore 1 - \sqrt{3x} = 0$$

$$\therefore \sqrt{3x} = 1$$

$$\therefore 3x = 1$$

$$\therefore x = \frac{1}{3}$$

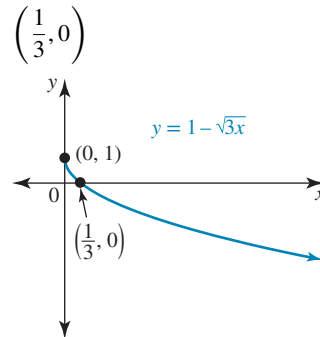

The range is $(-\infty, 1]$.

- b** $y = 2\sqrt{-x} + 4$

Domain: $-x \geq 0 \Rightarrow x \leq 0$

The domain is $(-\infty, 0]$.

End point: $(0, 4)$, which is also the y -intercept

x -intercept: let $y = 0$.

$$\therefore 2\sqrt{-x} + 4 = 0$$

$$\therefore \sqrt{-x} = -2$$

This is not possible, so there is no x -intercept (also possible
 to anticipate this as $a > 0$).

Let $x = -1$, then $y = 6$, so a point on the graph is $(-1, 6)$.

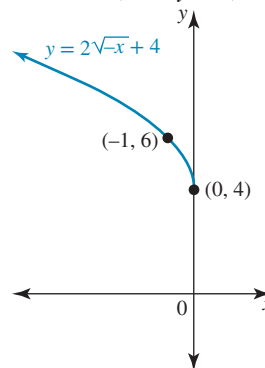

The range is $[4, \infty)$.

- c** $y = 2\sqrt{4 + 2x} + 3$

Domain: $4 + 2x \geq 0 \Rightarrow x \geq -2$, $[-2, \infty)$

End point: $(-2, 3)$

y -intercept: let $x = 0$.

$$\therefore y = 2\sqrt{4} + 3 = 7$$

$(0, 7)$

There will not be an x -intercept.

The range is $[3, \infty)$.

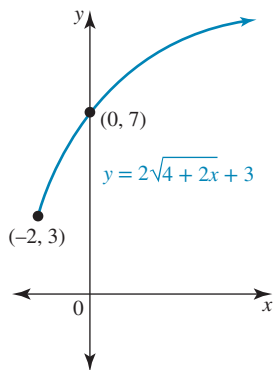

d $y = -\sqrt{3} - \sqrt{12 - 3x}$

Domain: $12 - 3x \geq 0 \Rightarrow x \leq 4, (-\infty, 4]$.

End point: $(4, -\sqrt{3})$

y-intercept: let $x = 0$.

$$\therefore y = -\sqrt{3} - \sqrt{12}$$

$$\therefore y = -\sqrt{3} - 2\sqrt{3}$$

$$\therefore y = -3\sqrt{3}$$

$$(0, -3\sqrt{3})$$

There is no x-intercept as the range is $(-\infty, -\sqrt{3}]$.

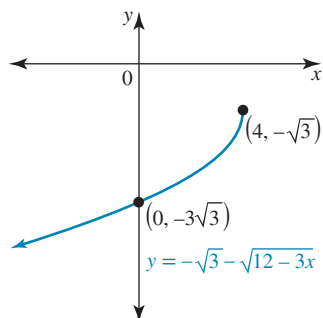

14 a $f: [5, \infty) \rightarrow R, f(x) = a\sqrt{x+b} + c$

The end point of the graph is $(5, -2)$, so

$$f(x) = a\sqrt{x-5} - 2.$$

The point $(6, 0)$ is on the graph, so $f(6) = 0$.

$$\therefore 0 = a\sqrt{6-5} - 2$$

$$\therefore 0 = a - 2$$

$$\therefore a = 2$$

Hence, $f(x) = 2\sqrt{x-5} - 2$ with $a = 2, b = -5, c = -2$.

b $f: (-\infty, 2) \rightarrow R, f(x) = \sqrt{ax+b} + c$

i Let $y = \sqrt{ax+b} + c$.

The end point is $(2, -2)$, so $a[2] + b = 0$ and $c = -2$.

$$\therefore b = -2a \text{ and } c = -2$$

$$y = \sqrt{ax - 2a} - 2$$

Substitute $(0, 0)$:

$$\therefore 0 = \sqrt{-2a} - 2$$

$$\therefore \sqrt{-2a} = 2$$

$$\therefore -2a = 4$$

$$\therefore a = -2$$

Since $b = -2a, b = 4$.

$$f(x) = \sqrt{-2x+4} - 2 \text{ with } a = -2, b = 4, c = -2.$$

ii Reflecting the graph in the x -axis would make the end point $(2, 2)$ and the range $(-\infty, 2]$. The graph would still pass through the origin.

The equation of the reflected graph would be

$$y = -\sqrt{-2x+4} + 2.$$

15 a $\{(x, y) : y = \sqrt[3]{x+2} - 1\}$

$$y = \sqrt[3]{x+2} - 1$$

Point of inflection $(-2, -1)$

y-intercept: let $x = 0$.

$$\therefore y = \sqrt[3]{2} - 1$$

$$(0, \sqrt[3]{2} - 1)$$

x-intercept: let $y = 0$.

$$\therefore 0 = \sqrt[3]{x+2} - 1$$

$$\therefore \sqrt[3]{x+2} = 1$$

$$\therefore x+2 = 1^3$$

$$\therefore x+2 = 1$$

$$\therefore x = -1$$

$$(-1, 0)$$

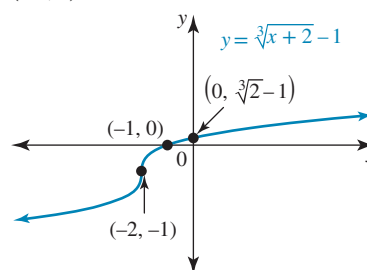

b $f(x) = \frac{1 - \sqrt[3]{x+8}}{2}$

Let $y = f(x)$.

$$\therefore y = \frac{1}{2} (1 - \sqrt[3]{x+8})$$

$$= \frac{1}{2} - \frac{1}{2} \sqrt[3]{x+8}$$

The implied domain is R and the range is R .

Point of inflection $(-8, \frac{1}{2})$

y-intercept: let $x = 0$.

$$\therefore y = \frac{1}{2} (1 - \sqrt[3]{8})$$

$$= \frac{1}{2} (1 - 2)$$

$$= -\frac{1}{2}$$

$$(0, -\frac{1}{2})$$

x-intercept: let $y = 0$.

$$\therefore 0 = \frac{1}{2} (1 - \sqrt[3]{x+8})$$

$$\therefore \sqrt[3]{x+8} = 1$$

$$\therefore x+8 = 1$$

$$\therefore x = -7$$

$$(-7, 0)$$

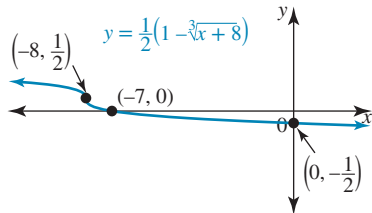

c $g: [-3, 6] \rightarrow \mathbb{R}, g(x) = \sqrt[3]{-x+5}$

End points: $g(-3) = \sqrt[3]{8} = 2$, so $(-3, 2)$ is an end point.

$g(6) = \sqrt[3]{-1} = -1$, so $(6, -1)$ is an end point.

Point of inflection: $(5, 0)$, which is also the x -intercept.

y -intercept: $g(0) = \sqrt[3]{5} \Rightarrow (0, \sqrt[3]{5})$

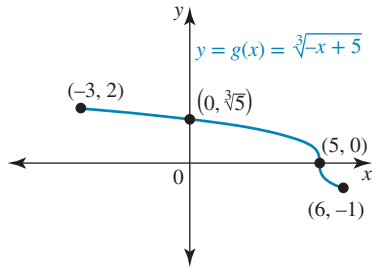

Domain $[-3, 6]$, range $[-1, 2]$.

d Let the equation be $y = a\sqrt[3]{x-h} + k$

The point of inflection is $(0, -2)$.

$$\therefore y = a\sqrt[3]{x} - 2$$

Substitute the point $(1, 0)$:

$$\therefore 0 = a\sqrt[3]{1} - 2$$

$$\therefore 0 = a - 2$$

$$\therefore a = 2$$

The equation is $y = 2\sqrt[3]{x} - 2$.

e Let the equation be $y = a\sqrt[3]{x-h} + k$.

The tangent is vertical at the point of inflection, so $(-1, -2)$ is the point of inflection.

$$\therefore y = a\sqrt[3]{x+1} - 2$$

Substitute the point $(-9, 5)$:

$$\therefore 5 = a\sqrt[3]{-8} - 2$$

$$\therefore 5 = -2a - 2$$

$$\therefore 2a = -7$$

$$\therefore a = -\frac{7}{2}$$

The equation is $y = -\frac{7\sqrt[3]{x+1}}{2} - 2$.

f $(y+2)^3 = 64x - 128$

Take the cube root of each side:

$$\therefore y+2 = \sqrt[3]{64x-128}$$

$$\therefore y = \sqrt[3]{64(x-2)} - 2$$

$$\therefore y = 4\sqrt[3]{(x-2)} - 2$$

The point of inflection is $(2, -2)$.

16 $y = \sqrt{(2-x)(x+3)}$

For the graph to exist, $(2-x)(x+3) \geq 0$.

Solve $(2-x)(x+3) = 0 \Rightarrow x = 2, -3$.

Sketch the graph to solve the inequality.

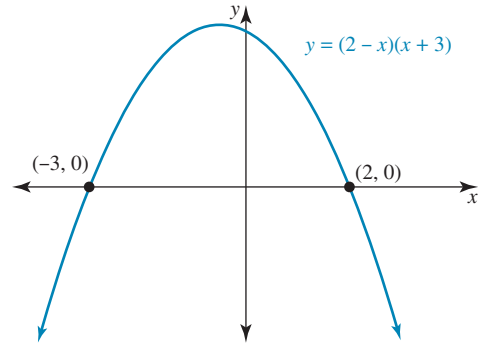

$$x \in [-3, 2]$$

17 a $y = x^{\frac{3}{4}}$

$$y = \sqrt[4]{x^3} \Rightarrow \text{4th root of } x^3$$

As the even root of the third quadrant section of the x^3 polynomial cannot be taken, the graph has one first quadrant branch with domain $\mathbb{R}^+ \cup \{0\}$.

As $4 > 3$, the root shape dominates. The graph contains the points $(0, 0)$ and $(1, 1)$, and lies above $y = x$ for $0 < x < 1$ and below $y = x$ for $x > 1$.

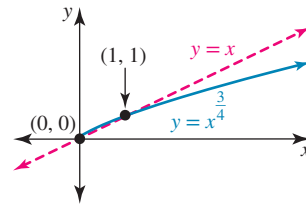

b $y = x^{\frac{4}{3}}$

Since $y = \sqrt[3]{x^4}$, the cube root of x^4 is required.

The x^4 polynomial lies in the first and second quadrants.

The cube root of both sections can be formed, so the graph has two branches and domain \mathbb{R} .

As $4 > 3$, the polynomial shape dominates. The graph contains the points $(0, 0)$, $(1, 1)$ and $(-1, 1)$, and lies below $y = x$ for $0 < x < 1$ and above $y = x$ for $x > 1$.

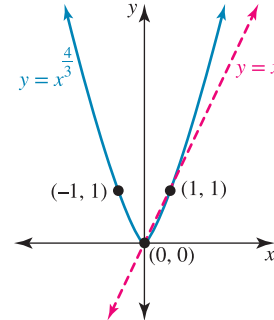

18 a $y = x^{\frac{1}{5}}$

$$y = \sqrt[5]{x} \Rightarrow \text{5th root of } x$$

The line $y = x$ lies in the first and third quadrants. The fifth root of both sections can be formed, so the graph has two branches and domain \mathbb{R} .

For the first quadrant, the graph contains the points $(0, 0)$ and $(1, 1)$, and lies above $y = x$ for $0 < x < 1$ and below $y = x$ for $x > 1$.

By symmetry for the third quadrant, the graph contains the points $(0, 0)$ and $(-1, -1)$, and lies below $y = x$ for $-1 < x < 0$ and above $y = x$ for $x < -1$.

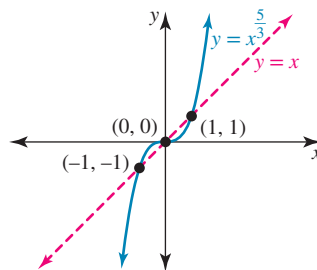
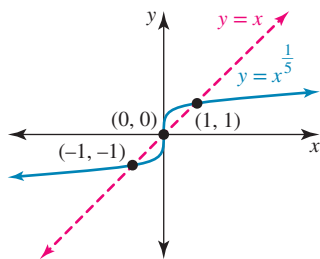

b $y = x^{\frac{1}{8}}$
 $y = \sqrt[8]{x} \Rightarrow$ 8th root of x
 As the even root of the third quadrant section of the $y = x$ line cannot be taken, the graph has one first quadrant branch with domain $R^+ \cup \{0\}$.
 The graph contains the points $(0, 0)$ and $(1, 1)$, and lies above $y = x$ for $0 < x < 1$ and below $y = x$ for $x > 1$.

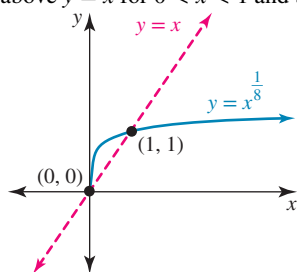

c $y = x^{\frac{3}{5}}$
 $\therefore y = \sqrt[5]{x^3}$
 The graph lies in both the first and third quadrants and has domain R and range R .
 The graph intersects the line $y = x$ at $(0, 0)$, $(1, 1)$ and $(-1, -1)$.
 As $3 < 5$, the root shape dominates the function $y = \sqrt[5]{x^3}$.

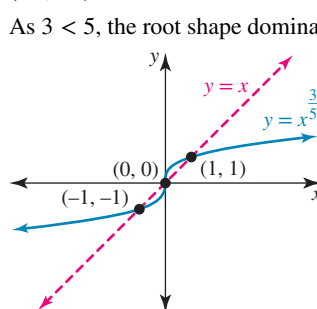

19 a $y = x^{\frac{5}{2}}$
 $\therefore y = \sqrt{x^5}$
 The graph of $y = x^{\frac{5}{2}}$ lies in the first and third quadrants. However, where $x^{\frac{5}{2}} < 0$, the square root of these values cannot be formed.

Therefore, the graph of $y = x^{\frac{5}{2}}$ lies only in the first quadrant and has domain $R^+ \cup \{0\}$ and range $R^+ \cup \{0\}$.

As $5 > 2$, the polynomial shape dominates the function $y = \sqrt{x^5}$.

The graph intersects the line $y = x$ at $(0, 0)$ and $(1, 1)$.

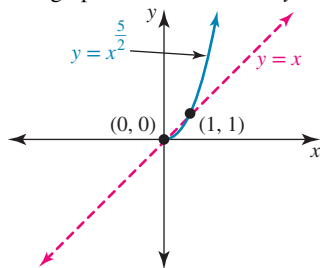

b $y = x^{\frac{5}{3}}$
 $\therefore y = \sqrt[3]{x^5}$
 The cube root of both the negative and positive sections of $y = x^5$ can be formed.

Therefore, the graph of $y = x^{\frac{5}{3}}$ lies in both the first and third quadrants and has domain R and range R .

The graph intersects the line $y = x$ at $(0, 0)$, $(1, 1)$ and $(-1, -1)$.

As $5 > 3$, the polynomial shape dominates the function $y = \sqrt[3]{x^5}$.

d $y = x^{0.25}$
 $\therefore y = x^{\frac{1}{4}}$
 $\therefore y = \sqrt[4]{x}$
 The line $y = x$ lies in the first and third quadrants. The fourth root of its negative sections cannot be formed. Therefore, the graph of $y = x^{0.25}$ lies only in the first quadrant and has domain $R^+ \cup \{0\}$ and range $R^+ \cup \{0\}$.
 The graph intersects the line $y = x$ at $(0, 0)$ and $(1, 1)$.
 As $1 < 4$, the root shape dominates the function $y = \sqrt[4]{x^1}$.

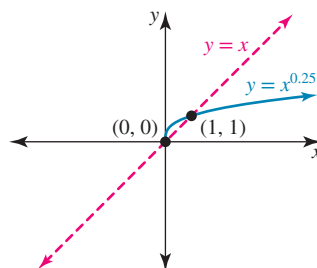

20 a $y = x^{\frac{1}{3}}$ is $y = \sqrt[3]{x}$. Its graph could be formed by drawing the line $y = x$ and finding the cube roots of appropriate y -values to construct the shape. The root shape dominates since $3 > 1$.

b The two graphs both contain the points $(1, 1)$, $(0, 0)$ and $(-1, -1)$. The line lies in quadrants 1 and 3. Since cube roots of negative numbers can be taken, the graph of $y = x^{\frac{1}{3}}$ will exist in both quadrants 1 and 3.

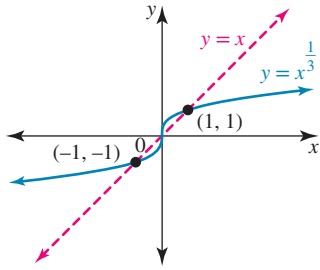

c $x^{\frac{1}{3}} - x$ when $\frac{1}{3} - x$.

From the diagram, this occurs for $0 < x < 1$ and if $x < -1$.

The solution set is $\{x: x < -1\} \cup \{x: 0 < x < 1\}$.

1.7 Exam questions

1 $f: D \rightarrow R, f(x) = \frac{3x+2}{5-x}$

$$f(x) = \frac{3x+2}{5-x} = \frac{-3(5-x)+17}{5-x}$$

$$f(x) = -3 + \frac{17}{5-x}$$

$x = 5$ is a vertical asymptote.

$y = -3$ is a horizontal asymptote.

The correct answer is **E**.

2 $a \in (0, \infty), b \in R$

$$h: [-a, 0] \cup (0, a) \rightarrow h(x) = \frac{a}{x} + b$$

$$h(a) = b + 1, h(-a) = b - 1$$

$x = 0$ is a vertical asymptote.

$y = b$ is a horizontal asymptote.

The correct answer is **D**.

3 $f(x) = \frac{x^2-5}{x-1}$ has maximal domain $R \setminus \{1\}$.

$x = 1$ is a vertical asymptote.

The correct answer is **A**.

1.8 Combinations of functions

1.8 Exercise

1 a $f(x) = \begin{cases} -\sqrt[3]{x}, & x < -1 \\ x^3, & -1 \leq x \leq 1 \\ 2-x, & x > 1 \end{cases}$

$f(-8)$: Use the rule $f(x) = -\sqrt[3]{x}$.

$$\begin{aligned} f(-8) &= -\sqrt[3]{(-8)} \\ &= 2 \end{aligned}$$

$f(-1)$: Use the rule $f(x) = x^3$.

$$\begin{aligned} f(-1) &= (-1)^3 \\ &= -1 \end{aligned}$$

$f(2)$: Use the rule $f(x) = 2-x$.

$$f(2) = 0$$

b $f(x) = -\sqrt[3]{x}$

If $x = -1, f(-1) = 1$. The point $(-1, 1)$ is open for the cube root function. The point $(-8, 2)$ lies on this branch.

$$f(x) = x^3$$

There is a stationary point of inflection at the origin. The points $(-1, -1)$ and $(1, 1)$ are closed points for this cubic.

$$f(x) = 2 - x$$

The point $(1, 1)$ is an open point for the line, and the point $(2, 0)$ lies on the line.

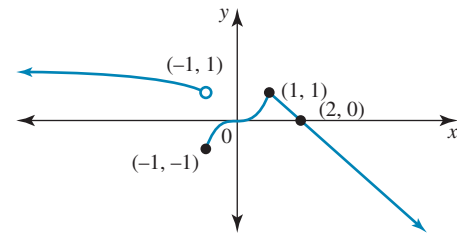

c i The function is not continuous at $x = -1$.

ii The domain is R and the range is R .

2 a $y = \begin{cases} -2x, & x \leq 0 \\ 4 - x^2, & x > 0 \end{cases}$

$y = -2x$ contains the points $(0, 0)$ (closed point) and $(-1, 2)$.

$y = 4 - x^2$ has an open turning point at $(0, 4)$, and the x -intercept in the restricted domain is $(2, 0)$.

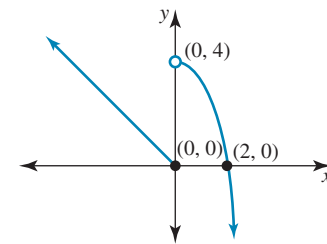

The domain is R and the range is R . The function is discontinuous at $x = 0$.

b $y = \begin{cases} \sqrt[3]{x}, & x < 1 \\ \frac{1}{x}, & x \geq 1 \end{cases}$

$y = \sqrt[3]{x}$ has an open point $(1, 1)$ and inflection point $(1, 1)$.

$y = \frac{1}{x}$ has a horizontal asymptote $y = 0$ (vertical asymptote is not in its domain) and a closed point $(1, 1)$.

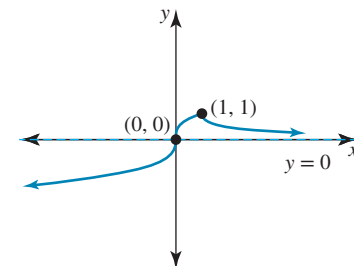

The domain is R and the range is $(-\infty, 1]$. There is no point where the graph is discontinuous.

3 $f(x) = \begin{cases} \frac{1}{(x+1)^2}, & x < -1 \\ x^2 - x, & -1 \leq x \leq 2 \\ 8 - 2x, & x > 2 \end{cases}$

a i Use the rule $f(x) = \frac{1}{(x+1)^2}$.

$$f(-2) = \frac{1}{(-1)^2} = 1$$

ii Use the rule $f(x) = x^2 - x$.

$$f(2) = (2)^2 - (2) = 2$$

b The truncus has a vertical asymptote $x = -1$ and horizontal asymptote $y = 0$.

The parabola has closed end points $(-1, 3)$ and $(2, 2)$, and x -intercepts at the origin and $(1, 0)$.

The line has an open end point $(2, 4)$ and x -intercept $(4, 0)$.

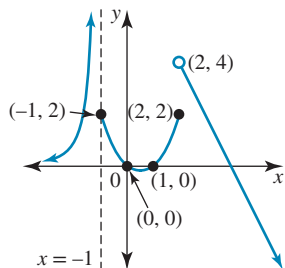

c The domain over which the function is continuous is $\mathbb{R} \setminus \{-1, 2\}$.

4 $f: \mathbb{R} \rightarrow \mathbb{R}, f(x) = \begin{cases} \frac{1}{9}x^3 + 5, & x < -3 \\ \sqrt{1-x}, & -3 \leq x \leq 1 \\ x-2, & x > 1 \end{cases}$

a The branch to the left of $x = 1$ has the rule $f(x) = \sqrt{1-x}$, so $f(1) = 0$.
The branch to the right of $x = 1$ has the rule $f(x) = x - 2$, so $f(1) \rightarrow -1$ (open circle).

These branches do not join, so the hybrid function is not continuous at $x = 1$.

b The cubic function's point of inflection is not in its restricted domain. The point $(-3, 2)$ is an open point.
The square root function has closed domain end points $(-3, 2)$ and $(1, 0)$.
The line has an open end point $(1, -1)$ and contains point $(2, 0)$.

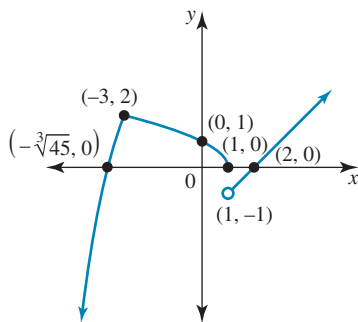

Many-to-one correspondence

c $f(x) = 4$
The graph shows only the linear branch has a point with $y = 4$.
Let $x - 2 = 4$
 $\therefore x = 6$

5 The line for which $x < 0$ has equation $y = x$, the horizontal line for $x \in (0, 4)$ is $y = 4$, and the line for $4 < x < 8$ is also $y = x$ closed at $x = 8$. The function is continuous, so one way to express its rule is

$$y = \begin{cases} x + 4, & x < 0 \\ 4, & 0 \leq x < 4 \\ x, & 4 \leq x \leq 8 \end{cases}$$

6 The left branch is a parabola on the domain section where $x < 0$.

Let its equation be $y = a(x+3)(x+1)$
Substitute point $(0, 4)$
 $\therefore 4 = a(3)(1)$
 $\therefore a = \frac{4}{3}$

The parabola branch has equation $y = \frac{4}{3}(x+3)(x+1)$.
The middle branch is $y = 4$ for the domain section $x \in [0, 2]$.
The line through points $(3, 2)$ and $(4, 0)$ has gradient $m = -2$.
Its equation is $y = -2(x-4)$.

The rule for the hybrid function could be expressed as

$$y = \begin{cases} \frac{4}{3}(x+3)(x+1), & x < 0 \\ 4, & 0 \leq x \leq 2 \\ -2x + 8, & x \geq 3 \end{cases}$$

7 $f(x) = -\sqrt{1+x}$ and $g(x) = -\sqrt{1-x}$
Domains: $x+1 \geq 0 \Rightarrow x \geq -1$ and $1-x \geq 0 \Rightarrow x \leq 1$
 $d_f = [-1, \infty)$ and $d_g = (-\infty, 1]$.

a Since $d_f = [-1, \infty)$, $d_g = (-\infty, 1]$, then $d_f \cap d_g = [-1, 1]$.
 $y = (f+g)(x)$
 $= f(x) + g(x)$
 $= -\sqrt{1+x} - \sqrt{1-x}$

The domain is the same as $d_f \cap d_g = [-1, 1]$.

The graph is obtained from $f(x) = -\sqrt{1+x}$ and $g(x) = -\sqrt{1-x}$

x	-1	0	1
$f(x)$	0	-1	$-\sqrt{2}$
$g(x)$	$-\sqrt{2}$	-1	0
$f(x) + g(x)$	$-\sqrt{2}$	-2	$-\sqrt{2}$

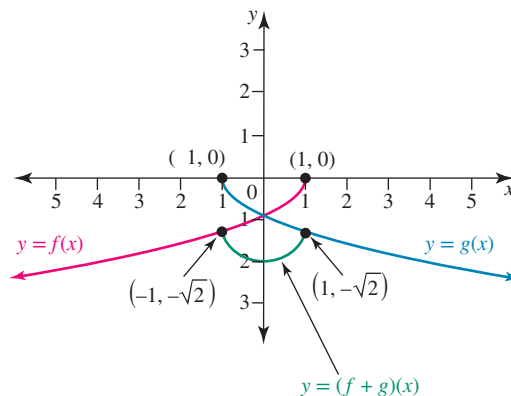

b The domain of fg is the same as $d_f \cap d_g = [-1, 1]$.

$$\begin{aligned} (fg)(x) &= f(x) \times g(x) \\ &= -\sqrt{1+x} \times -\sqrt{1-x} \\ &= \sqrt{(1+x)(1-x)} \\ &= \sqrt{1-x^2} \end{aligned}$$

This is the rule for a semicircle, top half, centre $(0, 0)$, radius 1. Therefore, the range of fg is $[0, 1]$.

8 $f(x) = x^3$ and $g(x) = x^2$
 $(f-g)(x) = f(x) - g(x)$
 $= x^3 - x^2$

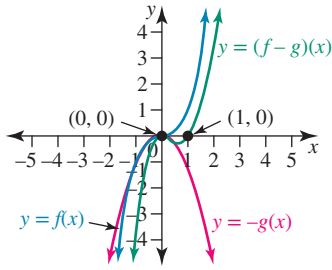

The graphs of f and g intersect when $x = 0, x = 1$, so these must be the x -intercepts of $f - g$.

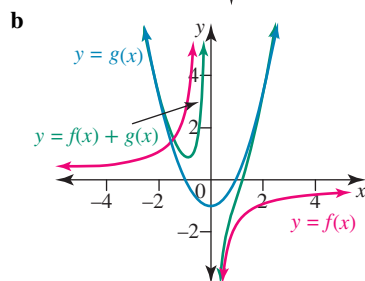
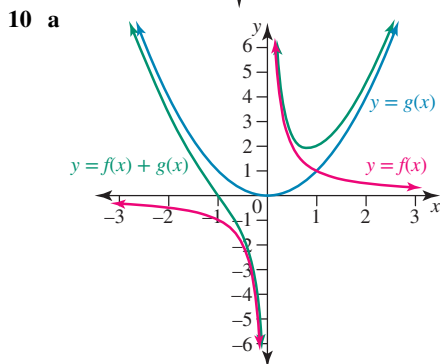
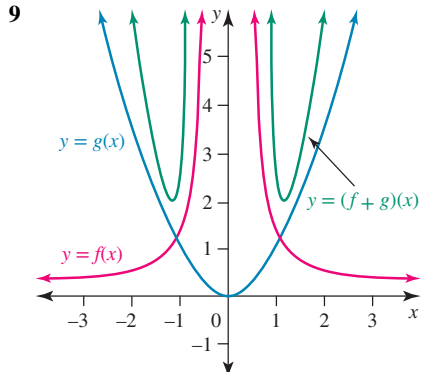

11 $f(x) = 5 - 2x$, $d_f = R$ and $g(x) = 2x - 2$, $d_g = R$.

a $y = (f + g)(x)$

Rule:

$$y = 5 - 2x + 2x - 2$$

$$\therefore y = 3$$

Domain:

$$d_{f+g} = d_f \cap d_g$$

$$\therefore d_{f+g} = R$$

The graph of $y = (f + g)(x)$ is the horizontal line through $(0, 3)$. Its range is $\{3\}$.

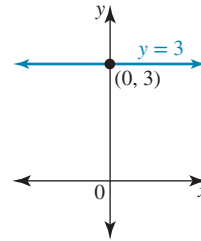

b $y = (f - g)(x)$

Rule:

$$y = 5 - 2x - (2x - 2)$$

$$\therefore y = 7 - 4x$$

Domain:

$$d_{f-g} = d_f \cap d_g$$

$$\therefore d_{f-g} = R$$

The graph of $y = (f - g)(x)$ is a straight line through $(0, 7)$

and $(\frac{7}{4}, 0)$. Its range is R .

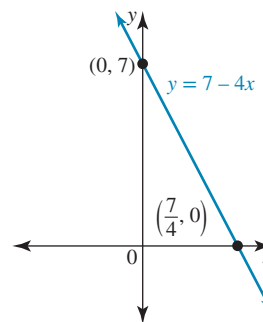

c $y = (fg)(x)$

Rule:

$$y = (5 - 2x)(2x - 2)$$

$$\therefore y = 2(5 - 2x)(x - 1)$$

Domain: $d_{fg} = d_f \cap d_g = R$

The graph is a concave down parabola with x -intercepts

$(\frac{5}{2}, 0)$ and $(1, 0)$, y -intercept $(0, -10)$.

$$\text{Turning point: } x = \frac{\frac{5}{2} + 1}{2} = \frac{7}{4}$$

$$y = 2 \left(5 - \frac{7}{2} \right) \left(\frac{7}{4} - 1 \right)$$

$$= 2 \times \frac{3}{2} \times \frac{3}{4}$$

$$= \frac{9}{4}$$

$(\frac{7}{4}, \frac{9}{4})$ is the maximum turning point.

The range is $(-\infty, \frac{9}{4}]$.

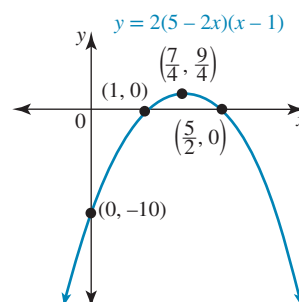

12 $f(x) = x^2 - 1$ and $g(x) = \sqrt{x+1}$

a i $(g-f)(3)$

$= g(3) - f(3)$

$= \sqrt{4} - 8$

$= -6$

ii $(gf)(8)$

$= g(8)f(8)$

$= \sqrt{9} \times 63$

$= 189$

b $d_f = R, d_g = [-1, \infty)$

$d_{f+g} = d_f \cap d_g$

$= [-1, \infty)$

c i Graph of $f+g$

Add the ordinates together.

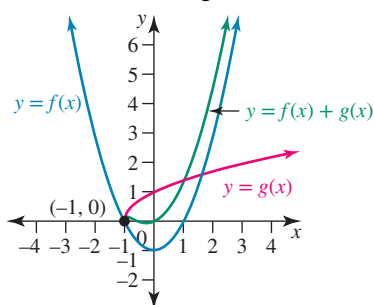

ii Graph of $g-f$

Subtract the ordinates.

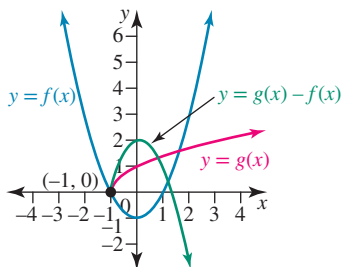

iii Graph of fg

Multiply the ordinates together.

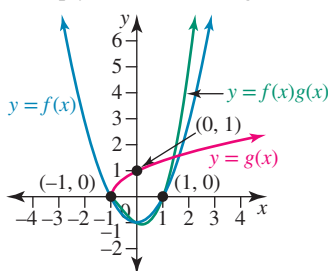

13 $y = x + \sqrt{-x}$

Draw the line $y_1 = x$ and the square root function $y_2 = \sqrt{-x}$.

The common domain is $(-\infty, 0]$.

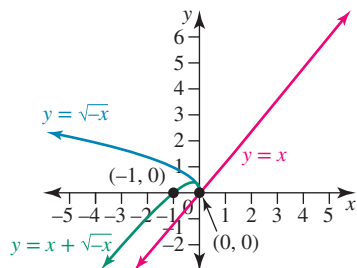

14 $y = x^2 - 1$

The parabola has turning points $(0, -1)$, and x -intercepts $(\pm 1, 0)$.

The graph of $y = (x^2 - 1)^2$ will have the same x -intercepts, but the point $(0, -1)$ will become the point $(0, 1)$ on this graph. This graph lies on or above the x -axis. Its domain is R and its range is $[0, \infty)$.

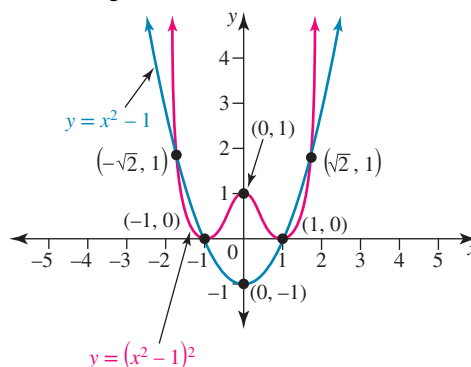

15 a $g(x) = (2x - 1)^3$. There is a stationary point of inflection at

$(\frac{1}{2}, 0)$.

$y = (g(x))^2$

Square ordinates

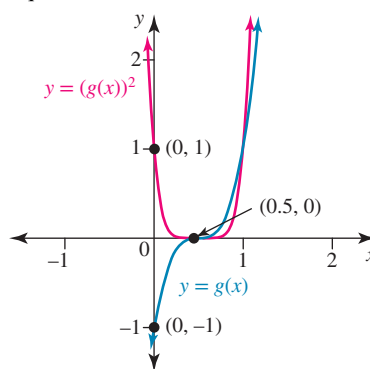

b The graphs of $y = f(x)$ and $y = (f(x))^2$ will intersect at places where $y = 0$ or $y = 1$.

For the function $f(x) = x^3 - 2x$, let $f(x) = 0$.

$\therefore x(x^2 - 2) = 0$

$\therefore x = 0, x = \pm\sqrt{2}$

Let $f(x) = 1$.

$\therefore x^3 - 2x = 1$

$\therefore x^3 - 2x - 1 = 0$

$\therefore (x+1)(x^2 - x - 1) = 0$

$\therefore x = -1$ or $x^2 - x - 1 = 0$

Consider $x^2 - x - 1 = 0$.

$x = \frac{1 \pm \sqrt{1+4}}{2}$

$= \frac{1 \pm \sqrt{5}}{2}$

The two graphs intersect at

$(0, 0), (\pm\sqrt{2}, 0), (-1, 1)$ and $(\frac{1 \pm \sqrt{5}}{2}, 1)$.

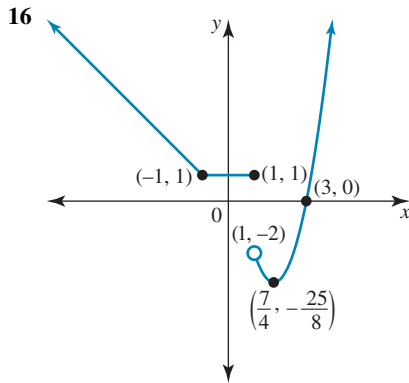

The minimum turning point of the parabolic branch needs to be obtained to form the range. The parabola $y = (2x - 1)(x - 3)$ has a minimum turning point at $(\frac{7}{4}, -\frac{25}{8})$.

The range of the hybrid function is $[-\frac{25}{8}, \infty)$.

17
$$f(x) = \begin{cases} x + a, & x \in (-\infty, -8] \\ \sqrt[3]{x} + 2, & x \in (-8, 8] \\ \frac{b}{x}, & x \in (8, \infty) \end{cases}$$

a The branches must join at $x = -8$.

Left of $x = -8, f(x) = x + a$

$$f(-8) = -8 + a$$

Right of $x = -8, f(x) = \sqrt[3]{x} + 2$

$$f(-8) = \sqrt[3]{(-8)} + 2 = 0$$

For continuity, $-8 + a = 0 \Rightarrow a = 8$.

The branches must also join at $x = 8$.

Left of $x = 8, f(x) = \sqrt[3]{x} + 2$

$$f(8) = \sqrt[3]{(8)} + 2 = 4$$

Right of $x = 8, f(x) = \frac{b}{x}$

$$f(8) = \frac{b}{8}$$

For continuity, $\frac{b}{8} = 4 \Rightarrow b = 32$.

$$f(x) = \begin{cases} x + 8, & x \in (-\infty, -8] \\ \sqrt[3]{x} + 2, & x \in (-8, 8] \\ \frac{32}{x}, & x \in (8, \infty) \end{cases}$$

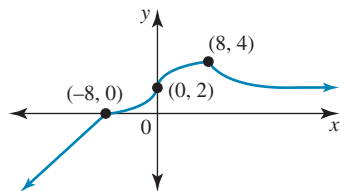

b $f(x) = k$ is a horizontal line.

Looking at the graph to determine in how many ways a horizontal line can intersect the graph gives the values for k .

- i No solution if $k > 4$
- ii One solution if $k = 4$ or $k \leq 0$
- iii Two solutions if $0 < k < 4$

c $\{x: f(x) = 1\}$

There will be two solutions, one on the cube root branch and one on the hyperbola branch.

$$\text{Let } \sqrt[3]{x} + 2 = 1$$

$$\therefore \sqrt[3]{x} = -1$$

$$\therefore x = -1$$

$$\text{Let } \frac{32}{x} = 1.$$

$$\therefore x = 32$$

The solution set is $\{-1, 32\}$.

1.8 Exam questions

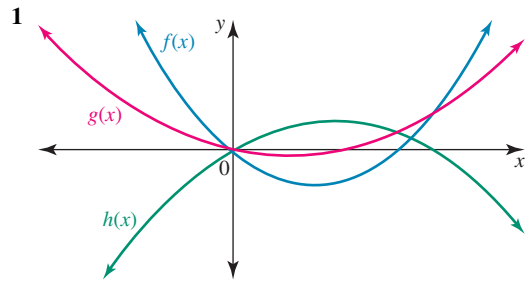

Using addition of ordinates,

$$h(x) = g(x) + (-f(x)) = g(x) - f(x).$$

The correct answer is E.

2 $(-\infty, -2) \cup (-1, \infty) = R \setminus (-2, -1)$

$$f(x) = \sqrt{x+3}: \text{dom } f = [-3, \infty] \text{ and } \text{ran } f = [0, \infty]$$

$$g(x) = \sqrt{1-x}: \text{dom } g = (-\infty, 1] \text{ and } \text{ran } g = [0, \infty]$$

$$\text{ran } f = [0, \infty]$$

$$\text{ran } g = [0, \infty]$$

$$y = f(x) - g(x) = \sqrt{x+3} - \sqrt{1-x}$$

$$\text{dom } f - g = \text{dom } f \cap \text{dom } g = [-3, 1] \text{ and } \text{ran } f \cap g = [-2, 2]$$

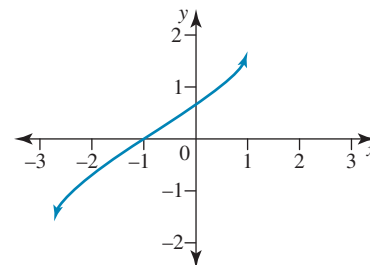

The correct answer is E.

3 $f(-1)$ does not exist and the range is

$$(-\infty, -2] \cup (-1, \infty) = R \setminus (-2, -1].$$

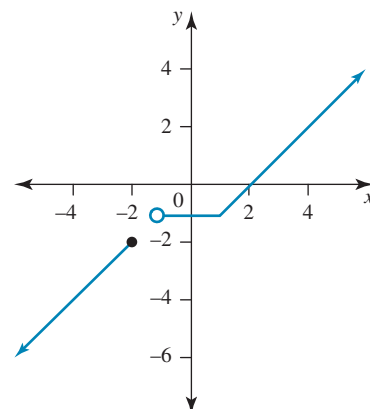

The correct answer is D.

1.9 Modelling and applications

1.9 Exercise

1 a

x	0	1	3	4
y	4	2	10	8

The data points increase and decrease, so they cannot be modelled by a one-to-one function. Neither a linear model nor an exponential model is possible.

The data is not oscillating, so it is unlikely to be trigonometric. The jump between $x = 1$ and $x = 3$ is a concern, but the data could be modelled by a polynomial such as a cubic with a turning point between $x = 1$ and $x = 3$. However, $y = x^n$ requires the point $(0, 0)$ to be on it, and that is not true for the data given.

b i $y = \frac{a}{x-2} + k$

Substitute the point $(0, 4)$:

$$\therefore 4 = \frac{a}{-2} + k$$

$$\therefore 8 = -a + 2k \quad [1]$$

Substitute the point $(3, 10)$:

$$\therefore 10 = \frac{a}{1} + k$$

$$\therefore 10 = a + k \quad [2]$$

Add the two equations:

$$3k = 18$$

$$\therefore k = 6$$

$$\therefore a = 4$$

The equation is $y = \frac{4}{x-2} + 6$.

ii The graph has a vertical asymptote at $x = 2$ and a horizontal asymptote at $y = 6$.

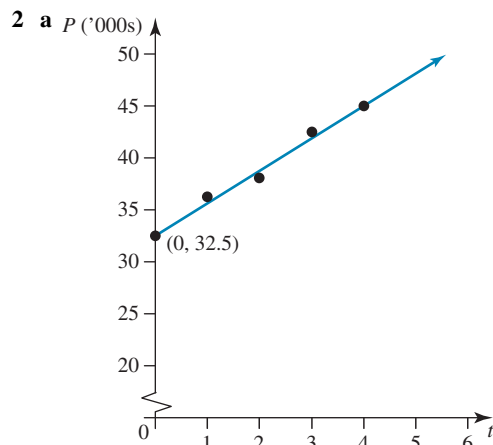
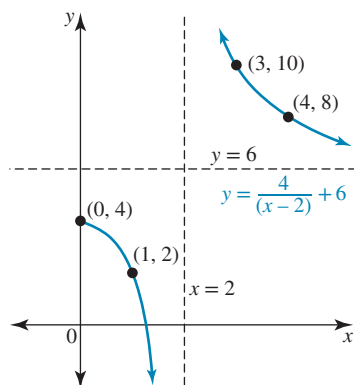

The data appears to be linear.

b $(2, 38.75)$ and $(4, 45)$

$$m = \frac{45 - 38.75}{4 - 2}$$

$$= \frac{6.25}{2}$$

$$= 3.125$$

$$P - 45 = 3.125(t - 4)$$

$$\therefore P = 3.125t - 12.5 + 45$$

$$\therefore P = 3.125t + 32.5$$

c Let $t = 0$.

$$\therefore P = 32.5$$

There were 32 500 bees in January.

d The gradient gives the rate of increase

The bees are increasing at 3.125 thousand per month.

3 a The point is $(0, 2)$ so $a = 2$.

b Reading from the diagram, the coordinates are $(2, 2)$.

c The turning point is $(5, 0)$, so let the equation be of the form $y = a(x - 5)^2$.

Substitute the point $(2, 2)$:

$$\therefore 2 = a(-3)^2$$

$$\therefore a = \frac{2}{9}$$

The equation is $y = \frac{2}{9}(x - 5)^2$, $2 \leq x \leq 9$

d For $0 < x < 1$, the line has gradient 2 and y -intercept at $y = 2$.

Its equation is $y = 2x + 2$.

The rule for the hybrid function can be expressed as

$$y = \begin{cases} 2x + 2, & -1 < x < 0 \\ 2, & 0 \leq x \leq 2 \\ \frac{2}{9}(x - 5)^2, & 2 < x \leq 9 \end{cases}$$

e There are three positions where the skateboarder would be at a height of 1.5 metres above the ground. One is when the person climbs the connecting ladder and the other two are on the parabolic ramp.

Consider $2x + 2 = 1.5$:

$$\therefore 2x = -0.5$$

$$\therefore x = -0.25$$

Consider $\frac{2}{9}(x - 5)^2 = 1.5$:

$$\therefore (x - 5)^2 = \frac{27}{4}$$

$$\therefore x = 5 \pm \frac{3\sqrt{3}}{2}$$

The answer is $x = 5 \pm \frac{3\sqrt{3}}{2}$ or $x = -\frac{1}{4}$.

4 a The garden area is the area of the entire square minus the area of the two right-angled triangles.

$$\begin{aligned}
 A &= 40 \times 40 - \frac{1}{2} \times x \times x - \frac{1}{2} \times (40 - x) \times 40 \\
 &= 1600 - \frac{1}{2}x^2 - 20(40 - x) \\
 &= 1600 - \frac{1}{2}x^2 - 800 + 20x \\
 &= -\frac{1}{2}x^2 + 20x + 800
 \end{aligned}$$

b Both $x > 0$ and $40 - x > 0$, since these are lengths. The restriction that needs to be placed is that $0 < x < 40$.

c Completing the square:

$$\begin{aligned}
 A &= -\frac{1}{2}(x^2 - 40x - 1600) \\
 &= -\frac{1}{2}((x^2 - 40x + 400) - 400 - 1600) \\
 &= -\frac{1}{2}((x - 20)^2 - 1000) \\
 &= -\frac{1}{2}(x - 20)^2 + 1000
 \end{aligned}$$

i 20

ii 1000 m^2 ; the greatest area is 1000 m^2 when $x = 20$.

5 a The stationary point of inflection at $x = 0 \Rightarrow x^3$ is a factor of the graph's equation.

The cuts at $x = \pm\sqrt{5} \Rightarrow x + \sqrt{5}$ and $x - \sqrt{5}$ are factors.

Let the equation be $y = ax^3(x + \sqrt{5})(x - \sqrt{5})$.

Substitute the point $(\sqrt{3}, -12\sqrt{3})$:

$$\begin{aligned}
 \therefore -12\sqrt{3} &= a(\sqrt{3})^3(\sqrt{3} - \sqrt{5})(\sqrt{3} + \sqrt{5}) \\
 \therefore -12\sqrt{3} &= a \times 3\sqrt{3} \times ((\sqrt{3})^2 - (\sqrt{5})^2) \\
 \therefore -12\sqrt{3} &= 3\sqrt{3}a \times (3 - 5) \\
 \therefore -12\sqrt{3} &= -6\sqrt{3}a \\
 \therefore a &= 2
 \end{aligned}$$

The equation is $y = 2x^3(x - \sqrt{5})(x + \sqrt{5})$.

b $y = 2x^3(x - \sqrt{5})(x + \sqrt{5})$

$$y = 2x^3(x - \sqrt{5})(x + \sqrt{5})$$

$$\therefore y = 2x^3(x^2 - 5)$$

$$\therefore y = 2x^5 - 10x^3$$

c i The maximum turning point on the graph of $y = g(x)$ has coordinates $(-\sqrt{3}, 12\sqrt{3})$. A horizontal translation of $\sqrt{3}$ units to the right is required for this point to have a x -coordinate of 0.

The minimum turning point on the graph of $y = g(x)$ has coordinates $(\sqrt{3}, -12\sqrt{3})$. A vertical translation of $12\sqrt{3} + 1$ units upward is required for this point to have a y -coordinate of 1.

ii The y -coordinate of point A is $12\sqrt{3} + (12\sqrt{3} + 1) = 24\sqrt{3} + 1$. The height of A above the water is $(24\sqrt{3} + 1) \approx 42.6$ metres.

iii B has an x -value of $\sqrt{3} + \sqrt{3} = 2\sqrt{3}$, so the coordinates of B are $(2\sqrt{3}, 1)$.

C is the point $(\sqrt{3}, 12\sqrt{3} + 1)$

6 $N: \mathbb{R}^+ \cup \{0\} \rightarrow \mathbb{R}, N(t) = \frac{at + b}{t + 2}$

a $N(t) = \frac{at + b}{t + 2}$

$$N(0) = 10$$

$$\therefore 10 = \frac{b}{2}$$

$$\therefore b = 20$$

$$N(5) = 30$$

$$\therefore 30 = \frac{5a + 20}{7}$$

$$\therefore 210 = 5a + 20$$

$$\therefore 5a = 190$$

$$\therefore a = 38$$

Hence, $a = 38, b = 20$.

b $N(t) = \frac{38t + 20}{t + 2}$

$$= \frac{38(t + 2) - 76 + 20}{t + 2}$$

$$= \frac{38(t + 2)}{t + 2} - \frac{56}{t + 2}$$

$$\therefore N(t) = 38 - \frac{56}{t + 2}, t \geq 0.$$

The graph is a hyperbola with horizontal asymptote $N = 38$.

The vertical asymptote $t = -2$ lies outside the domain.

The points $(0, 10)$ and $(5, 30)$ lie on the graph.

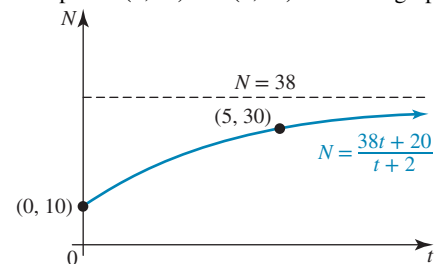

c The horizontal asymptote shows that as $t \rightarrow \infty, N \rightarrow 38$. The population of quolls will never exceed 38.

1.9 Exam questions

1 $V = lwh$

$$= (8 - 2x)(6 - 2x)x$$

Domain: $x \in (0, 3)$

Sketch the graph and find the turning point using CAS over the domain $x \in (0, 3)$.

TP = $(1.13, 24.26)$

Therefore, maximum volume occurs when $x = 1.1$.

The correct answer is **B**.

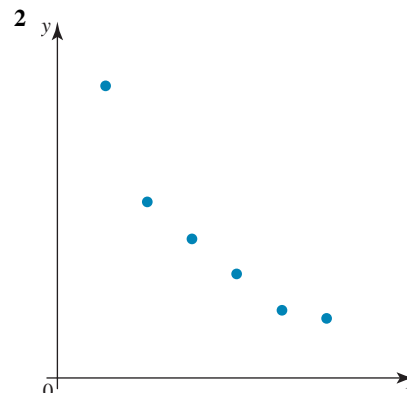

The shape of the graph is a hyperbola, $y = \frac{a}{x}$.

The correct answer is C.

- 3 a In triangle ODC, OC is of length $h - 4$ cm, $h > 4$.

Using Pythagoras' theorem,

$$(h - 4)^2 + r^2 = 4^2$$

$$\therefore r^2 = 16 - (h - 4)^2$$

$$\therefore r = \sqrt{16 - (h - 4)^2}, r > 0$$

$$\therefore r = \sqrt{8h - h^2} \quad [1 \text{ mark}]$$

b $V = \frac{1}{3}\pi r^2 h$

$$\therefore V = \frac{1}{3}\pi (8h - h^2) h$$

$$\therefore V = \frac{1}{3}\pi h^2 (8 - h) \quad [1 \text{ mark}]$$

$h > 0$ and $8 - h > 0$, so the restriction on h is $0 < h < 8$.

This would be seen on the graph to be the domain interval where $V > 0$. [1 mark]

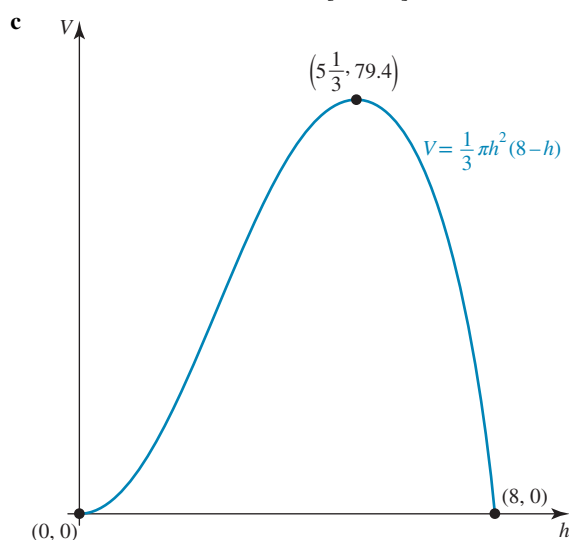

Award 1 mark for correct shape.

Award 1 mark for correct turning point and end points.

- d Using CAS, the greatest volume is 79 cm^3 .

The range is $R \setminus \{5\}$. [1 mark]

c $2m^4 - 5m^2 - 3 = 0$

Let $a = m^2$.

$$\therefore 2a^2 - 5a - 3 = 0$$

$$(2a + 1)(a - 3) = 0$$

$$(2m^2 + 1)(m^2 - 3) = 0$$

$$\therefore m^2 = -\frac{1}{2}, 3$$

$$m = \pm\sqrt{3}$$

d $-2x^3 + 12x^2 - 22x + 12 = 0$

$$x^3 - 6x^2 + 11x - 6 = 0$$

$$P(1) = 1 - 6 + 11 - 6 = 0$$

Therefore, $x - 1$ is a factor.

$$x^3 - 6x^2 + 11x - 6 = 0$$

$$(x - 1)(x^2 - 5x + 6) = 0$$

$$(x - 1)(x - 3)(x - 2) = 0$$

$$x = 1, 2, 3$$

- 2 a Let $P(m) = 4m^4 - 11m^3 - 19m^2 + 44m + 12$.

If $m - 2$ is a factor, then $P(2) = 0$.

$$P(2) = 4(2)^4 - 11(2)^3 - 19(2)^2 + 44(2) + 12$$

$$= 4 \times 16 - 11 \times 8 - 19 \times 4 + 88 + 12$$

$$= 64 - 88 - 76 + 88 + 12$$

$$= 76 - 88 - 76 + 88$$

$$= 0$$

$\therefore m - 2$ is a factor.

- b $4m^4 - 11m^3 - 19m^2 + 44m + 12$

$$= 4m^4 - 8m^3 - 3m^3 + 6m^2 - 25m^2 + 50m - 6m + 12$$

$$= 4m^3(m - 2) - 3m^2(m - 2) - 25m(m - 2) - 6(m - 2)$$

$$= (m - 2)(4m^3 - 3m^2 - 25m - 6)$$

Let $Q(m) = 4m^3 - 3m^2 - 25m - 6$.

Try different values for m to determine another factor.

$$Q(-2) = 4(-2)^3 - 3(-2)^2 - 25(-2) - 6$$

$$= 4 \times -8 - 3 \times 4 + 50 - 6$$

$$= -32 - 12 + 50 - 6$$

$$= 50 - 50$$

$$= 0$$

$\therefore m + 2$ is a factor

$$4m^3 - 3m^2 - 25m - 6$$

$$= 4m^3 + 8m^2 - 11m^2 - 22m$$

$$= 4m^2(m + 2) - 11m(m + 2) - 3(m + 2)$$

$$= (m + 2)(4m^2 - 11m - 3)$$

Substitute

$4m^3 - 3m^2 - 25m - 6 = (m + 2)(4m^2 - 11m - 3)$ back into the original factorisation.

$$4m^4 - 11m^3 - 19m^2 + 44m + 12$$

$$= (m - 2)(4m^3 - 3m^2 - 25m - 6)$$

$$= (m - 2)(m + 2)(4m^2 - 11m - 3)$$

$$= (m - 2)(m + 2)(4m + 1)(m - 3)$$

Hence, solve the equation

$$4m^4 - 11m^3 - 19m^2 + 44m + 12 = 0$$

$$(m - 2)(m + 2)(4m + 1)(m - 3) = 0$$

$$\therefore m = -\frac{1}{4}, \pm 2, 3$$

1.10 Review

1.10 Exercise

Technology free: short answer

1 a $3x^2 - 5x = 4$

$$3x^2 - 5x - 4 = 0$$

$$\Delta = (-5)^2 - 4 \times 3 \times -4$$

$$= 73$$

$$x = \frac{5 \pm \sqrt{73}}{6}$$

b $4x^3 - 8x^2 - 3x + 6 = 0$

$$4x^2(x - 2) - 3(x - 2) = 0$$

$$(x - 2)(4x^2 - 3) = 0$$

$$(x - 2)(2x - \sqrt{3})(2x + \sqrt{3}) = 0$$

$$x = 2, \pm \frac{\sqrt{3}}{2}$$

3 Let $P(x) = x^4 + ax^3 + bx^2 + cx - 6$.

Therefore, since $(x + 1)$ is a factor,

$$P(-1) = 0.$$

$$(-1)^4 + a(-1)^3 + b(-1)^2 + c(-1) - 6 = 0$$

$$1 - a + b - c - 6 = 0$$

$$-a + b - c = 5 \quad [1]$$

Therefore, since $(x + 2)$ is a factor,

$$P(-2) = 0.$$

$$(-2)^4 + a(-2)^3 + b(-2)^2 + c(-2) - 6 = 0$$

$$16 - 8a + 4b - 2c - 6 = 0$$

$$-8a + 4b - 2c = -10 \quad [2]$$

Therefore, since $(x + 3)$ is a factor,

$$P(-3) = 0.$$

$$(-3)^4 + a(-3)^3 + b(-3)^2 + c(-3) - 6 = 0$$

$$81 - 27a + 9b - 3c - 6 = 0$$

$$-27a + 9b - 3c = -75 \quad [3]$$

$$-a + b - c = 5 \quad [1]$$

$$-8a + 4b - 2c = -10 \quad [2]$$

$$-27a + 9b - 3c = -75 \quad [3]$$

$$2 \times [1] \Rightarrow -2a + 2b - 2c = 10$$

$$2 \times [1] - [2] \Rightarrow$$

$$6a - 2b = 20 \quad [4]$$

$$3 \times [1] \Rightarrow -3a + 3b - 3c = 15$$

$$3 \times [1] - [3] \Rightarrow$$

$$24a - 6b = 90 \quad [5]$$

$$3 \times [4] \Rightarrow 18a - 6b = 60$$

$$3 \times [4] - [5] \Rightarrow$$

$$-6a = -30$$

$$a = \frac{-30}{-6}$$

$$a = 5$$

Substitute $a = 5$ into equation [4]:

$$[4] \Rightarrow 6a - 2b = 20$$

$$6 \times 5 - 2b = 20$$

$$30 - 2b = 20$$

$$-2b = -10$$

$$b = \frac{-10}{-2}$$

$$b = 5$$

Substitute $a = 5$ and $b = 5$ into equation [1]:

$$[1] \Rightarrow -a + b - c = 5$$

$$-5 + 5 - c = 5$$

$$-c = 5$$

$$c = -5$$

$$\therefore a = 5, b = 5, c = -5$$

4 a $y = \frac{1}{81}(x-2)^4 - 1$

Quartic polynomial with maximum turning point $(2, -1)$

y-intercept: let $x = 0$.

$$y = \frac{1}{81}(-2)^4 - 1$$

$$= -\frac{65}{81}$$

$$\left(0, -\frac{65}{81}\right)$$

x-intercepts: let $y = 0$.

$$0 = \frac{1}{81}(x-2)^4 - 1$$

$$\therefore (x-2)^4 = 81$$

$$\therefore x-2 = \pm 3$$

$$\therefore x = -1, x = 5$$

$$(-1, 0), (5, 0)$$

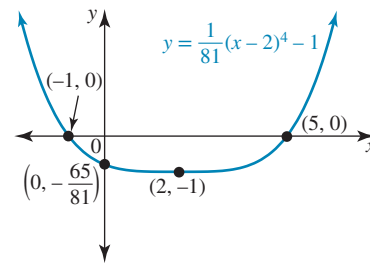

Domain R , range $[-1, \infty)$

b $y = 1 - \frac{4}{(x-2)^2}$

Truncus with asymptotes $x = 2, y = 1$

y-intercept: let $x = 0$.

$$y = 1 - \frac{4}{4} = 0$$

$(0, 0)$ is both an x- and a y-intercept.

By symmetry with the vertical asymptote, there is a second x-intercept at $(4, 0)$.

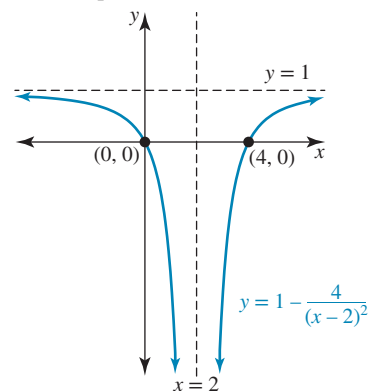

Domain $R \setminus \{2\}$, range $(-\infty, 1)$

c $y = (2x + 1)^3 + 8$

Cubic polynomial with stationary point of inflection

$$\text{at } \left(-\frac{1}{2}, 8\right)$$

y-intercept: let $x = 0$.

$$\therefore y = 9 \Rightarrow (0, 9)$$

x-intercept: let $y = 0$.

$$0 = (2x + 1)^3 + 8$$

$$\therefore (2x + 1)^3 = -8$$

$$\therefore 2x + 1 = -2$$

$$\therefore x = -\frac{3}{2}$$

$$\left(-\frac{3}{2}, 0\right)$$

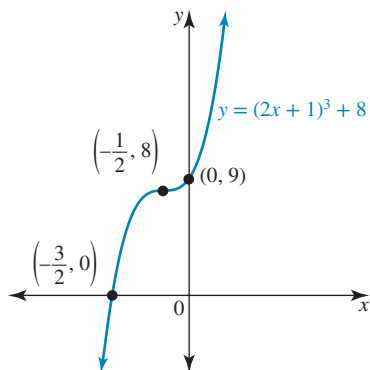

Domain R , range R

- 5 Use CAS to solve, or solve by hand.

$$m + n - p = -2 \quad [1]$$

$$3m + 5n - 2p = 1 \quad [2]$$

$$5m + 4n + 2p = 9 \quad [3]$$

$$2 - 2 \times [1] \Rightarrow$$

$$m + 3n = 5 \quad [4]$$

$$[2] + [3] \Rightarrow$$

$$8m + 9n = 10 \quad [5]$$

$$[5] - 3 \times [4] \Rightarrow$$

$$5m = -5$$

$$m = -1$$

Substitute $m = -1$ into equation [4]:

$$[4] \Rightarrow m + 3n = 5$$

$$-1 + 3n = 5$$

$$3n = 6$$

$$n = 2$$

Substitute $m = -1$ and $n = 2$ into equation [1]:

$$[1] \Rightarrow m + n - p = -2$$

$$-1 + 2 - p = -2$$

$$1 - p = -2$$

$$-p = -3$$

$$p = 3$$

$$\therefore m = -1, n = 2, p = 3$$

- 6 $2x + y - z = 7 \quad [1]$

$$-x - y + 3z = 1 \quad [2]$$

$$[1] + [2] \Rightarrow$$

$$x + 2z = 8 \quad [3]$$

Let $z = \lambda$ and substitute into [3]:

$$[3] \Rightarrow$$

$$x + 2z = 8$$

$$x + 2\lambda = 8$$

$$x = 8 - 2\lambda$$

Substitute $z = \lambda$ and $x = 8 - 2\lambda$ into equation [2]:

$$[2] \Rightarrow$$

$$2x + y - z = 7$$

$$2(8 - 2\lambda) + y - \lambda = 7$$

$$16 - 4\lambda + y - \lambda = 7$$

$$16 - 5\lambda + y = 7$$

$$y = 5\lambda - 9$$

$$\therefore x = 8 - 2\lambda, y = 5\lambda - 9, z = \lambda$$

- 7 a $f(x) = \begin{cases} \sqrt[3]{x+1}, & x \leq 0 \\ (3-x)(x+1), & 0 < x \leq 3 \\ x+3, & x > 3 \end{cases}$

$$y = \sqrt[3]{x+1}, x < 0$$

This is a cube root function.

$(-1, 0)$ is a point of inflection.

$(0, 1)$ is a closed end point for this function.

$$y = (3-x)(x+1), 0 \leq x \leq 3$$

This is a parabola with x -intercepts at $x = 3$ and $x = -1$, not in the domain.

There is a maximum turning point at $x = 1, y = 3$, i.e.

at $(1, 3)$.

$(0, 3)$ is an open end point and $(3, 0)$ is a closed end point

for the parabola.

$$y = x + 3, x > 3$$

This is a line with open end point $(3, 6)$ and passing through $(4, 7)$.

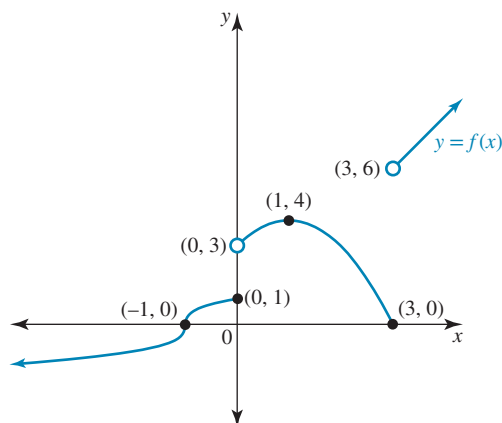

- b The hybrid function is discontinuous at $x = 0$ and $x = 3$.

- c The domain is R and the range is $R \setminus (4, 6)$.

- 8 a $f(x) = \sqrt{x+2}$ and $g(x) = \sqrt{4-x^2}$

$$\text{Domain of } f: x + 2 \geq 0 \Rightarrow x \geq -2$$

$$d_f = [-2, \infty)$$

$$\text{Domain of } g: 4 - x^2 \geq 0$$

$$\therefore 4 \geq x^2$$

$$\therefore x^2 \leq 4$$

$$\therefore -2 \leq x \leq 2$$

$$d_g = [-2, 2]$$

$$\text{Common domain: } d_f \cap d_g = [-2, \infty) \cap [-2, 2]$$

$$\therefore d_f \cap d_g = D = [-2, 2]$$

- b The graph of $y = f(x)$ is a square root function with end point $(-2, 0)$.

Since the domain is restricted to $[-2, 2]$, the other end point is $(2, 2)$.

The y -intercept is $(0, \sqrt{2})$.

The graph of $y = g(x)$ is a semicircle, centre $(0, 0)$, radius 2.

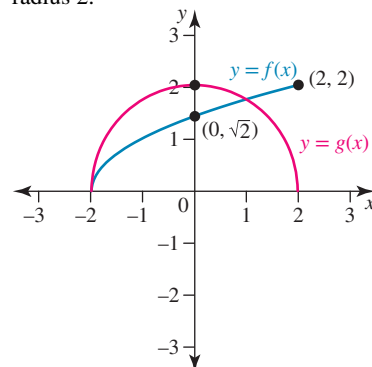

$$y = (f + g)(x)$$

The graph has domain D .

When $x = -2$,

$$f(-2) = 0, g(-2) = 0$$

$$\therefore (f + g)(-2) = 0$$

When $x = 0$,

$$f(0) = \sqrt{2}, g(0) = 2$$

$$\therefore (f + g)(0) = \sqrt{2} + 2 = 3.4$$

When $x = 2$,

$$f[2] = 2, g(0) = 0$$

$$\therefore (f + g)[2] = 2$$

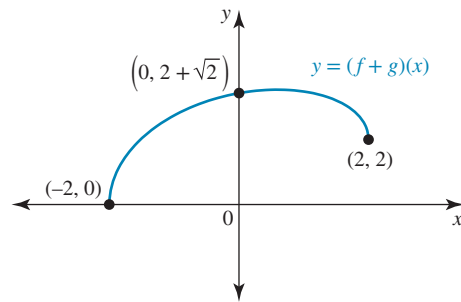

Technology active: multiple choice

- 9 Grouping two and two:

$$\begin{aligned} 4x^3 - 2x^2 - 36x + 18 &= 2x^2(2x - 1) - 18(2x - 1) \\ &= (2x - 1)(2x^2 - 18) \\ &= 2(2x - 1)(x^2 - 9) \\ &= 2(2x - 1)(x - 3)(x + 3) \end{aligned}$$

The correct answer is **D**.

- 10 $6x^3 - 5x^2 - 2x + 1$

$$\begin{aligned} &= 6x^3 - 6x^2 + x^2 - x - x + 1 \\ &= 6x^2(x - 1) + x(x - 1) - (x - 1) \\ &= (x - 1)(6x^2 + x - 1) \\ &= (x - 1)(3x - 1)(2x + 1) \\ \therefore (x - 1)(3x - 1)(2x + 1) &= 0 \\ x = 1, x = \frac{1}{2} \text{ and } x = \frac{1}{3} \end{aligned}$$

The correct answer is **A**.

- 11 $ax^3 + bx^2 + cx + d \equiv 3(x - 2)^3 + 2(x - 2)$
- $$\begin{aligned} &\equiv 3(x^3 - 6x^2 + 12x - 8) + 2(x - 2) \\ &\equiv 3x^3 - 18x^2 + 36x - 24 + 2x - 4 \\ &\equiv 3x^3 - 18x^2 + 38x - 28 \end{aligned}$$

$$\therefore a = 3, b = -18, c = 38, d = -28$$

The correct answer is **D**.

- 12 $2kx + (k + 2)y = 1$ [1]

$$4x + (5k + 1)y = 2$$
 [2]

$$[1] \Rightarrow (k + 2)y = 1 - 2kx$$

$$\begin{aligned} y &= \frac{1 - 2kx}{k + 2} \\ &= -\frac{2kx}{k + 2} + \frac{1}{k + 2} \end{aligned}$$

$$\therefore m = -\frac{2k}{k + 2}, y \text{ int} = \frac{1}{k + 2}$$

$$[2] \Rightarrow (5k + 1)y = 2 - 4x$$

$$y = \frac{2 - 4x}{5k + 1}$$

$$= -\frac{4x}{5k + 1} + \frac{2}{5k + 1}$$

$$\therefore m = -\frac{4}{5k + 1}, y \text{ int} = \frac{2}{5k + 1}$$

There are infinitely many solutions when both the gradients and y -intercepts are identical.

Gradients:

$$\frac{-2k}{k + 2} = \frac{-4}{5k + 1}$$

$$-2k(5k + 1) = -4(k + 2)$$

$$-10k^2 - 2k = -4k - 8$$

$$10k^2 - 2k - 8 = 0$$

$$5k^2 - k - 4 = 0$$

$$(5k + 4)(k - 1) = 0$$

$$k = -\frac{4}{5}, 1$$

y -intercepts:

$$\frac{1}{k + 2} = \frac{2}{5k + 1}$$

$$5k + 1 = 2(k + 2)$$

$$5k + 1 = 2k + 4$$

$$3k = 3$$

$$k = 1$$

Therefore, $k = 1$.

The correct answer is **E**.

- 13 The graph is a hyperbola with asymptotes $x = 2, y = -1$, so eliminate all options other than **A** or **B**. The hyperbola lies in the second and fourth quadrants defined by its asymptotes. The correct answer is **B**.

- 14 From the behaviour at the x -intercepts, the equation is of the form $y = a(x + 2)x^2(x - 3)$.

This is an even degree 6 polynomial, so $a < 0$.

A possible equation is $y = -(x + 2)x^2(x - 3)$, which can be written as $y = (x + 2)x^2(3 - x)$.

The correct answer is **C**.

- 15 The denominator cannot be zero. As it involves a cube root, that is the only restriction.

The domain is $\mathbb{R} \setminus \{64\}$.

The correct answer is **B**.

- 16 Of the choices, **C** is the most likely fit.

The correct answer is **C**.

- 17 Where the graphs intersect, there must be an x -intercept on the function $y = g(x) - f(x)$. There are two intersections.

The correct answer is **C**.

Technology active: extended response

- 18 a $(m^2 + 2)^2 - 13(m^2 + 2) + 42$

$$= m^4 + 4m^2 + 4 - 13m^2 - 26 + 42$$

$$\therefore am^4 + bm^3 + cm^2 + dm + e = m^4 - 9m^2 + 20$$

$$\therefore a = 1, b = 0, c = -9, d = 0 \text{ and } e = 20$$

- b $(m^2 + 2)^2 - 13(m^2 + 2) + 42 = 0$

$$m^4 - 9m^2 + 20 = 0$$

$$(m^2 - 4)(m^2 - 5) = 0$$

$$m^2 - 4 = 0, m^2 - 5 = 0$$

$$m^2 = 4, m^2 = 5$$

$$m = \pm 2, \pm \sqrt{5}$$

- 19 $(m + 1)x^2 + 2x + 3m = 0$

For two solutions, $\Delta > 0$.

$$\Delta = 2^2 - 4 \times (m + 1) \times 3m$$

$$= 4 - 12m(m + 1)$$

$$= 4 - 12m^2 - 12m$$

$$0 = -3m^2 - 3m + 1$$

$$m = \frac{3 \pm \sqrt{(-3)^2 - 4 \times -3 \times 1}}{-6}$$

$$= \frac{3 \pm \sqrt{21}}{-6}$$

$$\therefore \Delta > 0$$

$$-3m^2 - 3m + 1 > 0$$

As Δ is an upside down parabola, $\Delta > 0$ between the m -intercepts:

$$\therefore m \in \left(\frac{3 - \sqrt{21}}{-6}, \frac{3 + \sqrt{21}}{-6} \right) \text{ for the original equation to}$$

have two solutions.

20 $x - y + z + w = 5$

$$2x + y - z + 2w = 1$$

$$x + 2z - w = 0$$

$$2y - 3z - 2w = -11$$

Solve the system of equations using CAS:

$$x = 0, y = -2, z = 1, w = 2$$

21 a $y = ax^2 + bx + c$

As there is a turning point at $(3, 4)$, let the equation be

$$y = a(x - 3)^2 + 4.$$

Substitute the point $(2, 3)$:

$$\therefore 3 = a(-1)^2 + 4$$

$$\therefore a = -1$$

The equation is $y = -(x - 3)^2 + 4$.

Expanding,

$$y = -(x^2 - 6x + 9) + 4$$

$$\therefore y = -x^2 + 6x - 5$$

The answer is $a = -1, b = 6, c = -5$.

b $y = -x^2 + 6x - 5$

Let $y = 0$.

$$\therefore 0 = -x^2 + 6x - 5$$

$$\therefore x^2 - 6x + 5 = 0$$

$$\therefore (x - 1)(x - 5) = 0$$

$$\therefore x = 1 \text{ or } x = 5$$

A is the point $(1, 0)$ and B is the point $(5, 0)$.

c The length of AB is 4 units and the height of the triangle ABC is also 4 units.

The area of the triangle is $\frac{1}{2} \times 4 \times 4 = 8$ square units.

d i $y = ax^2 - 6ax + 8a + 3, a \in \mathbb{R} \setminus \{0\}$

Let $x = 2$

$$y = 4a - 12a + 8a + 3$$

$$= 3$$

Every parabola in this family passes through the point $(2, 3)$.

ii For two x -intercepts, $\Delta > 0$

$$\therefore (-6a)^2 - 4a(8a + 3) > 0$$

$$\therefore 36a^2 - 32a^2 - 12a > 0$$

$$\therefore 4a^2 - 12a > 0$$

$$\therefore 4a(a - 3) > 0$$

$$\therefore a < 0 \text{ or } a > 3$$

22 a $8 + 4x - 2x^2 - x^3$

$$= 4(2 + x) - x^2(2 - x)$$

$$= (2 + x)(4 - x^2)$$

$$= (2 + x)(2 + x)(2 - x)$$

$$= (2 + x)^2(2 - x)$$

b $y = 8 + 4x - 2x^2 - x^3$

$$\therefore y = (2 + x)^2(2 - x)$$

The graph touches the x -axis at $x = -2$ and cuts it at $x = 2$.

The y -intercept is $(0, 8)$ and the cubic function has a negative leading term.

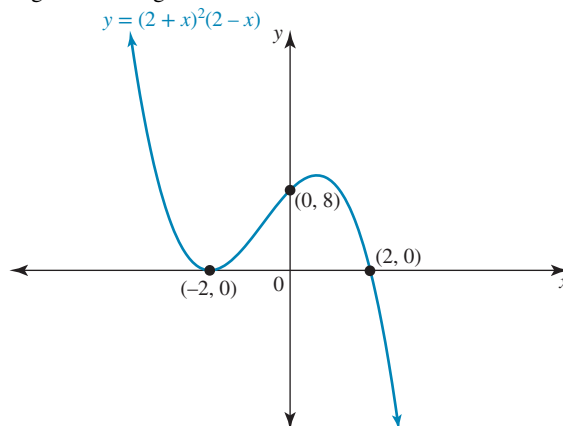

The maximum turning point lies in the interval between $x = -2$ and $x = 2$.

c i Square roots cannot be formed where the graph lies below the x -axis. For the interval $[-2, a]$, the largest value a can take so the square root function can be formed is $a = 2$.

ii $y = \sqrt{8 + 4x - 2x^2 - x^3}$ for $x \in [-2, 2]$

$$\therefore = \sqrt{(2 + x)^2(2 - x)}$$

$$\therefore = \sqrt{(2 + x)^2} \times \sqrt{2 - x}$$

$$\therefore = (2 + x)\sqrt{2 - x}$$

The polynomial function is the linear function with rule $f(x) = 2 + x, x \in [-2, 2]$, and the square root function has the rule $g(x) = \sqrt{2 - x}, x \in [-2, 2]$.

iii The range of function f is $[0, 4]$ and the range of function g is $[0, 2]$.

iv $f(x) = 2 + x, x \in [-2, 2]$ is linear with domain end points $(-2, 0)$ and $(2, 4)$, and y -intercept $(0, 0)$.

$g(x) = \sqrt{2 - x}, x \in [-2, 2]$ is a square root function with end point $(-2, 0)$, y -intercept $(0, \sqrt{2})$ and point $(-2, 2)$.

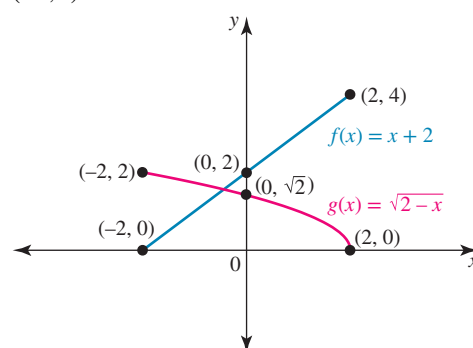

v The mountain range is the product of the two functions f and g .

$y = (fg)(x) = f(x)g(x)$ and $y = (fg)(x)$ has domain $[-2, 2]$.

Some values of this function are:

$$(fg)(-2) = 0 \times 2 = 0$$

$$(fg)(0) = \sqrt{2} \times 2 = 2\sqrt{2}$$

$(fg)[2] = 4 \times 0 = 0$
 and $(fg)(1) = 3 \times 1 = 3$.

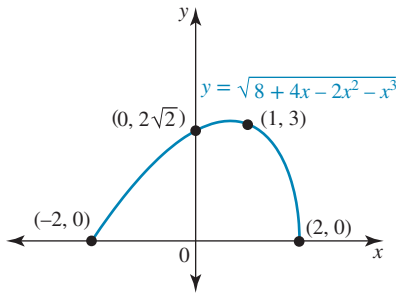

1.10 Exam questions

1 $f : [a, b) \rightarrow R, f(x) = \frac{1}{x}$
 $b > a > 0$
 $f(b) = \frac{1}{b} < \frac{1}{a} = f(a)$

The endpoint at $x = a$ is included, but the endpoint at $x = b$ is not included.

The range is $\left(\frac{1}{b}, \frac{1}{a}\right]$.

The correct answer is **D**.

2 $f : (-1, 2] \rightarrow R, f(x) = -x^2 + 2x - 3$
 End point included: $f(2) = -4 + 4 - 3 = -3$
 End point, not included: $f(-1) = -1 - 2 - 3 = -6$
 Turning points: $f'(x) = -2x + 2 = 0 \Rightarrow x = 1$
 $f(1) = -1 + 2 - 3 = -2$
 Range: $(-6, -2]$

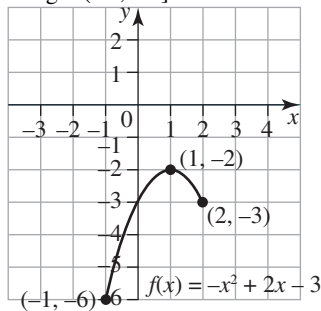

The correct answer is **C**.

3 $y_1 = kx - 4, y_2 = x^2 + 2x$
 $y_1 = y_2 \Rightarrow kx - 4 = x^2 + 2x$
 $x^2 + (2 - k)x + 4 = 0$
 $\Delta = (2 - k)^2 - 4 \times 1 \times 4$
 $= k^2 - 4k - 12$
 $= (k - 6)(k + 2)$
 $\Delta > 0 \Rightarrow k > 6 \text{ or } k < -2$
 The correct answer is **B**.

4 Consider the simultaneous equations:
 $-3x + my = m - 1$ [1]

$(m + 1)x - 10y = -8$ [2]

There will be an infinite number of solutions provided the gradients and y-intercepts of the two lines are equal.

First, rearrange the equations to determine the gradient of each line.

$-3x + my = m - 1$ [1]

$my = 3x + m - 1$
 $y = \frac{3}{m}x + \frac{m - 1}{m}$

Gradient = $\frac{3}{m}$

$(m + 1)x - 10y = -8$ [2]

$-10y = -(m + 1)x - 8$
 $y = \frac{m + 1}{10}x + \frac{4}{5}$

Gradient = $\frac{m + 1}{10}$

Solve for when the gradients are equal.

$\frac{3}{m} = \frac{m + 1}{10}$

$30 = m^2 + m$

$0 = m^2 + m - 30$

$= (m - 5)(m + 6)$

$m = 5, -6$

Now test each m value to see which one means that the y-intercepts are the same.

$m = 5:$

$-3x + 5y = 4$ [1]

$6x - 10y = -8$ [2]

If equation 1 is multiplied by -2 , it is the same as equation 2. Therefore, when $m = 5$, the equations are the same and there would be infinitely many solutions.

$m = -6.$

$-3x - 6y = -7$ [1]

$-5x - 10y = -8$ [2]

The gradients of both equations are the same; however, the y-intercepts are different.

So, when $m = 5$, there are an infinite number of solutions.

The correct answer is **B**.

5 $\begin{bmatrix} 3 & a \\ a + 2 & 5 \end{bmatrix} \begin{bmatrix} x \\ y \end{bmatrix} = \begin{bmatrix} 5 \\ a \end{bmatrix}$

$15 - a(a + 2) = 0$

$15 - a^2 - 2a = 0$

$(a + 5)(a - 3) = 0$

$a = -5, a = 3$ [1 mark]

If $a = -5$, $3x - 5y = 5$ and $-3x + 5y = -5$, lines are the same and there are infinite solutions.

If $a = 3$, $3x + 3y = 5$ and $5x + 5y = 3$, lines are parallel and there are no solutions.

No solutions, $a = 3$ [1 mark]

Topic 2 — Trigonometric functions

2.2 Trigonometric symmetry properties

2.2 Exercise

$$1 \text{ a } \tan\left(\frac{3\pi}{4}\right) = \tan\left(\pi - \frac{\pi}{4}\right) = -\tan\left(\frac{\pi}{4}\right) = -1$$

$$\text{b } \cos\left(\frac{5\pi}{6}\right) = \cos\left(\pi - \frac{\pi}{6}\right) = -\cos\left(\frac{\pi}{6}\right) = -\frac{\sqrt{3}}{2}$$

$$\text{c } \sin\left(-\frac{\pi}{4}\right) = -\sin\left(\frac{\pi}{4}\right) = -\frac{1}{\sqrt{2}}$$

$$\text{d } \cos\left(\frac{7\pi}{3}\right) = \cos\left(2\pi + \frac{\pi}{3}\right) = \cos\left(\frac{\pi}{3}\right) = \frac{1}{2}$$

$$\text{e } \tan\left(-\frac{\pi}{3}\right) = -\tan\left(\frac{\pi}{3}\right) = -\sqrt{3}$$

$$\text{f } \sin\left(\frac{11\pi}{6}\right) = \sin\left(2\pi - \frac{\pi}{6}\right) = -\sin\left(\frac{\pi}{6}\right) = -\frac{1}{2}$$

$$2 \text{ a } \tan\left(\frac{5\pi}{6}\right) = \tan\left(\pi - \frac{\pi}{6}\right) = -\tan\left(\frac{\pi}{6}\right) = -\frac{1}{\sqrt{3}}$$

$$\text{b } \cos\left(\frac{14\pi}{3}\right) = \cos\left(5\pi - \frac{\pi}{3}\right) = -\cos\left(\frac{\pi}{3}\right) = -\frac{1}{2}$$

$$\text{c } \tan\left(-\frac{5\pi}{4}\right) = -\tan\left(\frac{5\pi}{4}\right) \\ = -\tan\left(\pi + \frac{\pi}{4}\right) = -\tan\left(\frac{\pi}{4}\right) = -1$$

$$\text{d } \cos\left(-\frac{3\pi}{4}\right) = \cos\left(\frac{3\pi}{4}\right) = \cos\left(\pi - \frac{\pi}{4}\right) \\ = -\cos\left(\frac{\pi}{4}\right) = -\frac{1}{\sqrt{2}}$$

$$\text{e } \sin\left(-\frac{2\pi}{3}\right) = -\sin\left(\frac{2\pi}{3}\right) = -\sin\left(\pi - \frac{\pi}{3}\right) \\ = -\sin\left(\frac{\pi}{3}\right) = -\frac{\sqrt{3}}{2}$$

$$\text{f } \sin\left(\frac{17\pi}{6}\right) = \sin\left(\frac{5\pi}{6}\right) = \sin\left(\pi - \frac{\pi}{6}\right) = \sin\left(\frac{\pi}{6}\right) = \frac{1}{2}$$

$$3 \text{ a } \sin\left(\frac{7\pi}{3}\right) = \sin\left(2\pi + \frac{\pi}{3}\right) = \sin\left(\frac{\pi}{3}\right) = \frac{\sqrt{3}}{2}$$

$$\text{b } \cos\left(\frac{7\pi}{3}\right) = \cos\left(2\pi + \frac{\pi}{3}\right) = \cos\left(\frac{\pi}{3}\right) = \frac{1}{2}$$

$$\text{c } \tan\left(\frac{5\pi}{6}\right) = \tan\left(\pi - \frac{\pi}{6}\right) = -\tan\left(\frac{\pi}{6}\right) = -\frac{1}{\sqrt{3}} = -\frac{\sqrt{3}}{3}$$

$$\text{d } \sin(150^\circ) = \sin(180^\circ - 30^\circ) = \sin(30^\circ) = \frac{1}{2}$$

$$\text{e } \cos\left(\frac{7\pi}{6}\right) = \cos\left(\pi + \frac{\pi}{6}\right) = -\cos\left(\frac{\pi}{6}\right) = -\frac{\sqrt{3}}{2}$$

$$\text{f } \tan\left(-\frac{7\pi}{6}\right) = \tan\left(-\frac{\pi}{6}\right) = -\tan\left(\frac{\pi}{6}\right) = -\frac{1}{\sqrt{3}} = -\frac{\sqrt{3}}{3}$$

$$4 \text{ a } \cos\left(\frac{\pi}{2}\right) = 0$$

$$\text{b } \tan(270^\circ) = \text{undefined}$$

$$\text{c } \sin(-4\pi) = 0$$

$$\text{d } \tan(\pi) = 0$$

$$\text{e } \cos(-6\pi) = 1$$

$$\text{f } \sin\left(\frac{3\pi}{2}\right) = -1$$

$$5 \text{ a } \sin(\pi - \theta) = \sin(\theta)$$

$$\text{b } \cos(6\pi - \theta) = \cos(\theta)$$

$$\text{c } \tan(\pi + \theta) = \tan(\theta)$$

$$\text{d } \cos(-\theta) = \cos(\theta)$$

$$\text{e } \sin(180^\circ + \theta) = -\sin(\theta)$$

$$\text{f } \tan(720^\circ - \theta) = -\tan(\theta)$$

$$6 \text{ a } \cos\left(\frac{7\pi}{6}\right) + \cos\left(\frac{2\pi}{3}\right) = \cos\left(\pi + \frac{\pi}{6}\right) + \cos\left(\pi - \frac{\pi}{3}\right) \\ = -\cos\left(\frac{\pi}{6}\right) - \cos\left(\frac{\pi}{3}\right) \\ = -\frac{\sqrt{3}}{2} - \frac{1}{2} = -\frac{(\sqrt{3}+1)}{2}$$

$$\text{b } 2\sin\left(\frac{7\pi}{4}\right) + 4\sin\left(\frac{5\pi}{6}\right) = 2\sin\left(2\pi - \frac{\pi}{4}\right) + \\ 4\sin\left(\pi - \frac{\pi}{6}\right) \\ = -2\sin\left(\frac{\pi}{4}\right) + 4\sin\left(\frac{\pi}{6}\right) \\ = -2 \times \frac{\sqrt{2}}{2} + 4 \times \frac{1}{2} \\ = -\sqrt{2} + 2$$

$$\text{c } \sqrt{3}\tan\left(\frac{5\pi}{4}\right) - \tan\left(\frac{5\pi}{3}\right) = \sqrt{3}\tan\left(\pi + \frac{\pi}{4}\right) - \\ \tan\left(2\pi - \frac{\pi}{3}\right) \\ = \sqrt{3}\tan\left(\frac{\pi}{4}\right) + \tan\left(\frac{\pi}{3}\right) \\ = \sqrt{3} + \sqrt{3} = 2\sqrt{3}$$

$$\text{d } \sin^2\left(\frac{8\pi}{3}\right) + \sin\left(\frac{9\pi}{4}\right) = \sin^2\left(3\pi - \frac{\pi}{3}\right) + \sin\left(2\pi + \frac{\pi}{4}\right) \\ = \sin^2\left(\frac{\pi}{3}\right) + \sin\left(\frac{\pi}{4}\right) \\ = \left(\frac{\sqrt{3}}{2}\right)^2 + \frac{1}{\sqrt{2}} \\ = \frac{3 + 2\sqrt{2}}{4}$$

$$\text{e } 2\cos^2\left(-\frac{5\pi}{4}\right) - 1 = 2\cos^2\left(\frac{5\pi}{4}\right) - 1 \\ = 2\left(-\frac{1}{\sqrt{2}}\right)^2 - 1 \\ = 1 - 1 \\ = 0$$

$$\text{f } \frac{\tan\left(\frac{17\pi}{4}\right)\cos(-7\pi)}{\sin\left(-\frac{11\pi}{6}\right)} = \frac{\tan\left(4\pi + \frac{\pi}{4}\right)\cos(-\pi)}{-\sin\left(\frac{11\pi}{6}\right)} \\ = \frac{\tan\left(\frac{\pi}{4}\right) \times -1}{-\left[-\sin\left(\frac{\pi}{6}\right)\right]} \\ = (1 \times -1) \div \frac{1}{2} \\ = -2$$

$$7 \text{ a } \sin(2\pi - \theta) = -\sin(\theta) = -0.4695$$

$$\text{b } \cos(\pi - \alpha) = -\cos(\alpha) = -0.5592$$

$$\text{c } \tan(-\beta) = -\tan(\beta) = -0.2680$$

$$\text{d } \sin(\pi + \theta) = -\sin(\theta) = -0.4695$$

$$\text{e } \cos(2\pi - \alpha) = \cos(\alpha) = 0.5592$$

$$\text{f } \tan(\pi + \beta) = \tan(\beta) = 0.2680$$

$$8 \text{ a } \sin^2(\theta) + \cos^2(\theta) = 1$$

$$\cos^2(\theta) = 1 - \sin^2(\theta)$$

$$\cos(\theta) = \pm\sqrt{1 - \sin^2(\theta)}$$

$$\cos(\theta) = \pm\sqrt{1 - (0.4695)^2}$$

$$\cos(\theta) = \pm 0.8829$$

As we are dealing with the fourth quadrant,

$$\cos(\theta) = 0.8829.$$

Thus, $\cos(-\theta) = 0.8829$.

$$\text{b } \tan(\theta) = \frac{\sin(\theta)}{\cos(\theta)} = \frac{0.4695}{0.8829} = 0.5318$$

$$\tan(180^\circ - \theta) = -\tan(\theta) = -0.5318$$

$$\text{c } \sin^2(\alpha) + \cos^2(\alpha) = 1$$

$$\sin^2(\alpha) = 1 - \cos^2(\alpha)$$

$$\sin(\alpha) = \pm\sqrt{1 - \cos^2(\alpha)}$$

$$\sin(\alpha) = \pm\sqrt{1 - (0.5592)^2}$$

$$\sin(\alpha) = \pm 0.8290$$

As we are dealing with the first quadrant,

$$\sin(360^\circ + \alpha) = \sin(\alpha) = 0.8290.$$

$$\text{d } \tan(360^\circ - \alpha) = -\tan(\alpha)$$

$$\tan(360^\circ - \alpha) = -\frac{\sin(\alpha)}{\cos(\alpha)}$$

$$\tan(360^\circ - \alpha) = -\frac{0.8290}{0.5592}$$

$$\tan(360^\circ - \alpha) = -1.4825$$

$$9 \text{ a } \cos\left(\frac{\pi}{2} - \alpha\right) = \sin(\alpha)$$

$$\text{b } \tan(90^\circ + \alpha) = -\frac{1}{\tan(\alpha)}$$

$$\text{c } \sin(270^\circ - \alpha) = -\cos(\alpha)$$

$$\text{d } \tan\left(\frac{11\pi}{2} - \alpha\right) = \frac{1}{\tan(\alpha)}$$

$$\text{e } \cos\left(\frac{3\pi}{2} + \alpha\right) = \sin(\alpha)$$

$$\text{f } \sin(90^\circ - \alpha) = \cos(\alpha)$$

$$10 \text{ a } \sin\left(\frac{\pi}{2} + \theta\right) = \cos(\theta) = 0.8829$$

$$\text{b } \cos\left(\frac{3\pi}{2} - \theta\right) = -\sin(\theta)$$

$$\sin^2(\theta) + \cos^2(\theta) = 1$$

$$\sin^2(\theta) = 1 - \cos^2(\theta)$$

$$\sin(\theta) = \pm\sqrt{1 - \cos^2(\theta)}$$

$$\sin(\theta) = \pm\sqrt{1 - (0.8829)^2}$$

$$\sin(\theta) = 0.4696$$

$$\cos\left(\frac{3\pi}{2} - \theta\right) = -\sin(\theta) = -0.4696$$

$$\text{c } \tan\left(\frac{\pi}{2} - \theta\right) = \frac{\sin\left(\frac{\pi}{2} - \theta\right)}{\cos\left(\frac{\pi}{2} - \theta\right)}$$

$$= \frac{\cos(\theta)}{\sin(\theta)}$$

$$= \frac{0.8829}{0.4695}$$

$$= 1.8803$$

$$\text{d } \sin\left(\frac{3\pi}{2} + \alpha\right) = -\cos(\alpha)$$

$$\sin^2(\alpha) + \cos^2(\alpha) = 1$$

$$\cos^2(\alpha) = 1 - \sin^2(\alpha)$$

$$\cos(\alpha) = \pm\sqrt{1 - \sin^2(\alpha)}$$

$$\cos(\alpha) = \pm\sqrt{1 - (0.1736)^2}$$

$$\cos(\alpha) = 0.9848$$

$$\sin\left(\frac{3\pi}{2} + \alpha\right) = -\cos(\alpha) = -0.9848$$

$$\text{e } \sin\left(\frac{\pi}{2} - \alpha\right) = \cos(\alpha) = 0.9848$$

$$\text{f } \tan\left(\frac{3\pi}{2} + \alpha\right) = -\cot(\alpha)$$

$$\tan\left(\frac{3\pi}{2} + \theta\right) = \frac{-\sin\left(\frac{3\pi}{2} + \theta\right)}{\cos\left(\frac{3\pi}{2} + \theta\right)}$$

$$= \frac{-\cos(\theta)}{\sin(\theta)}$$

$$= \frac{-0.9848}{0.1736}$$

$$= -5.6729$$

$$11 \text{ a } \sin^2(\theta) + \cos^2(\theta) = 1$$

$$\cos^2(\theta) = 1 - \sin^2(\theta)$$

$$\cos(\theta) = \pm\sqrt{1 - \sin^2(\theta)}$$

$$\cos(\theta) = \pm\sqrt{1 - (0.8290)^2}$$

$$\cos(\theta) = \pm 0.5592$$

Since we are dealing with the first quadrant, $\cos(\theta) = 0.5592$.

$$\sin^2(\beta) + \cos^2(\beta) = 1$$

$$\sin^2(\beta) = 1 - \cos^2(\beta)$$

$$\sin(\beta) = \pm\sqrt{1 - \cos^2(\beta)}$$

$$\sin(\beta) = \pm\sqrt{1 - (0.7547)^2}$$

$$\sin(\beta) = \pm 0.6561$$

Since we are dealing with the first quadrant, $\sin(\beta) = 0.6561$.

$$\text{a } \sin(90^\circ - \theta) = \cos(\theta) = 0.5592$$

$$\text{b } \cos(270^\circ + \theta) = \sin(\theta) = 0.8290$$

$$\text{c } \tan(90^\circ + \theta) = \frac{\sin(90^\circ + \theta)}{\cos(90^\circ + \theta)}$$

$$= \frac{\cos(\theta)}{-\sin(\theta)}$$

$$= \frac{0.5592}{-0.8290}$$

$$= -0.6746$$

$$\text{d } \sin(270^\circ - \beta) = -\cos(\beta) = -0.7547$$

$$\text{e } \tan(90^\circ - \beta) = \frac{\sin(90^\circ - \beta)}{\cos(90^\circ - \beta)}$$

$$= \frac{\cos(\beta)}{\sin(\beta)}$$

$$= \frac{0.7547}{0.6561}$$

$$= 1.1503$$

$$\text{f } \cos(270^\circ - \beta) = -\sin(\beta) = -0.6561$$

$$12 \text{ a } \sin(2\pi - \theta) = -\sin(\theta) = -0.9511$$

$$\text{b } \sin(\pi - \theta) = \sin(\theta) = 0.9511$$

$$\text{c } \cos\left(\frac{\pi}{2} - \theta\right) = \sin(\theta) = 0.9511$$

$$\begin{aligned} \mathbf{d} \quad \tan(\theta) &= \frac{\sin(\theta)}{\cos(\theta)} \\ \sin^2(\theta) + \cos^2(\theta) &= 1 \\ \cos^2(\theta) &= 1 - \sin^2(\theta) \\ \cos(\theta) &= \sqrt{1 - \sin^2(\theta)} \\ \cos(\theta) &= \sqrt{1 - (0.9511)^2} \\ \cos(\theta) &= 0.3089 \\ \tan(\theta) &= \frac{\sin(\theta)}{\cos(\theta)} = \frac{0.9511}{0.3089} = 3.0792 \end{aligned}$$

$$\mathbf{e} \quad \cos(3\pi + \theta) = -\cos(\theta) = -0.3089$$

$$\mathbf{f} \quad \tan(2\pi - \theta) = -\tan(\theta) = -3.0792$$

$$\mathbf{13} \quad \mathbf{a} \quad \cos(180^\circ - \alpha) = -\cos(\alpha) = -0.8572$$

$$\mathbf{b} \quad \cos(-\alpha) = \cos(\alpha) = 0.8572$$

$$\mathbf{c} \quad \sin\left(\frac{3\pi}{2} + \alpha\right) = -\cos(\alpha) = -0.8572$$

$$\mathbf{d} \quad \tan(180^\circ - \alpha) = -\tan(\alpha)$$

$$\sin^2(\alpha) + \cos^2(\alpha) = 1$$

$$\sin^2(\alpha) = 1 - \cos^2(\alpha)$$

$$\sin(\alpha) = \sqrt{1 - \cos^2(\alpha)}$$

$$\sin(\alpha) = \sqrt{1 - (0.8572)^2}$$

$$\sin(\alpha) = 0.5150$$

$$\tan(\alpha) = \frac{\sin(\alpha)}{\cos(\alpha)} = \frac{0.5150}{0.8572} = 0.6008$$

$$\tan(180^\circ - \alpha) = -\tan(\alpha)$$

$$= -0.6008$$

$$\mathbf{e} \quad \cos(360^\circ - \alpha) = \cos(\alpha) = 0.8572$$

$$\mathbf{f} \quad \tan\left(\frac{\pi}{2} + \alpha\right) = \frac{\sin\left(\frac{\pi}{2} + \alpha\right)}{\cos\left(\frac{\pi}{2} + \alpha\right)}$$

$$= \frac{\cos(\alpha)}{-\sin(\alpha)}$$

$$= \frac{0.8572}{-0.5150}$$

$$= -1.6645$$

14 For the right angle triangle of (3, 4, 5) in the first quadrant,

$$\sin(\beta) = \frac{4}{5}, \cos(\beta) = \frac{3}{5} \text{ and } \tan(\beta) = \frac{4}{3}.$$

$$\mathbf{a} \quad \cos(\beta) = \frac{3}{5}$$

$$\mathbf{b} \quad \tan(\beta) = \frac{4}{3}$$

$$\mathbf{c} \quad \sin^2(\beta) + \cos^2(\beta) = \left(\frac{4}{5}\right)^2 + \left(\frac{3}{5}\right)^2$$

$$\sin^2(\beta) + \cos^2(\beta) = \frac{16}{25} + \frac{9}{25}$$

$$\sin^2(\beta) + \cos^2(\beta) = 1$$

$$\mathbf{d} \quad \cos^2(\beta) - \sin^2(\beta) = \left(\frac{3}{5}\right)^2 - \left(\frac{4}{5}\right)^2$$

$$\cos^2(\beta) - \sin^2(\beta) = \frac{9}{25} - \frac{16}{25} = -\frac{7}{25}$$

$$\mathbf{15} \quad \mathbf{a} \quad \sin(\theta) = \frac{5}{13}$$

$$\mathbf{b} \quad \tan(\theta) = \frac{5}{12}$$

$$\mathbf{c} \quad \cos(\theta) = \frac{12}{13}$$

$$\mathbf{d} \quad \sin(90^\circ - \theta) = \cos(\theta) = \frac{12}{13}$$

$$\mathbf{e} \quad \cos(90^\circ - \theta) = \sin(\theta) = \frac{5}{13}$$

$$\mathbf{f} \quad \tan(90^\circ - \theta) = \frac{1}{\tan(\theta)} = \frac{12}{5} = 2.4$$

$$\mathbf{16} \quad \mathbf{a} \quad \sin^2(x) + \cos^2(x) = 1$$

$$\frac{\sin^2(x)}{\cos^2(x)} + \frac{\cos^2(x)}{\cos^2(x)} = \frac{1}{\cos^2(x)}$$

$$\tan^2(x) + 1 = \frac{1}{\cos^2(x)} \text{ as required}$$

$$\mathbf{b} \quad \sin(x) = 0.6157$$

$$(0.6157)^2 + \cos^2(x) = 1$$

$$0.3791 + \cos^2(x) = 1$$

$$\cos^2(x) = 1 - 0.3791$$

$$\cos(x) = \sqrt{1 - 0.3791}$$

$$\cos(x) = 0.788$$

$$\tan^2(x) + 1 = \frac{1}{(0.788)^2}$$

$$\tan^2(x) = 1.6105 - 1$$

$$\tan(x) = \sqrt{0.6165} = 0.7814$$

$$\mathbf{17} \quad \mathbf{a} \quad v = 12 + 3 \sin\left(\frac{\pi t}{3}\right)$$

Initially $t = 0$.

$$v = 12 + 3 \sin(0) = 12 \text{ cm/s}$$

b When $t = 5$,

$$v = 12 + 3 \sin\left(\frac{5\pi}{3}\right)$$

$$v = 12 + 3 \sin\left(2\pi - \frac{\pi}{3}\right)$$

$$v = 12 - 3 \sin\left(\frac{\pi}{3}\right)$$

$$v = 12 - \frac{3\sqrt{3}}{2} \text{ cm/s}$$

c When $t = 12$,

$$v = 12 + 3 \sin\left(\frac{12\pi}{3}\right)$$

$$v = 12 + 3 \sin(4\pi) = 12 \text{ cm/s}$$

$$\mathbf{18} \quad h(t) = 0.5 \cos\left(\frac{\pi t}{12}\right) + 1.0$$

a At 6 am, $t = 0$.

$$h(0) = 0.5 \cos(0) + 1.0 = 1.5 \text{ m or } \frac{3}{2} \text{ m}$$

b At 2 pm, $t = 8$.

$$h(8) = 0.5 \cos\left(\frac{8\pi}{12}\right) + 1.0$$

$$h(8) = 0.5 \cos\left(\frac{4\pi}{3}\right) + 1.0$$

$$h(8) = 0.5 \cos\left(\pi - \frac{\pi}{3}\right) + 1.0$$

$$h(8) = 0.5 \cos\left(\frac{\pi}{3}\right) + 1.0$$

$$h(8) = \frac{1}{2} \times \frac{1}{2} + 1 = 0.75 \text{ m or } \frac{3}{4} \text{ m}$$

c At 10 pm, $t = 16$.

$$h(16) = 0.5 \cos\left(\frac{16\pi}{12}\right) + 1.0$$

$$h(16) = 0.5 \cos\left(\frac{4\pi}{3}\right) + 1.0$$

$$h(16) = 0.5 \cos\left(\pi + \frac{\pi}{3}\right) + 1.0$$

$$h(16) = -0.5 \cos\left(\frac{\pi}{3}\right) + 1.0$$

$$h(16) = -\frac{1}{2} \times \frac{1}{2} + 1 = 0.75 \text{ m or } \frac{3}{4} \text{ m}$$

2.2 Exam questions

1 $\sin\left(-\frac{4\pi}{3}\right) = -\sin\left(\frac{4\pi}{3}\right) = -\left(-\frac{\sqrt{3}}{2}\right) = \frac{\sqrt{3}}{2}$

The correct answer is **A**.

2 Option B is false since $\cos^3(\pi) + \sin^3(\pi) = (-1)^3 + 0^3 = -1$.
Therefore, A, C, D and E are true.

The correct answer is **B**.

3 It can be seen that A, B, C and D are true. E is false since $\sin(\pi + \theta) + \sin(2\pi - \theta) = -2\sin(\theta)$.

The correct answer is **E**.

2.3 Trigonometric equations

2.3 Exercise

1 a $2\cos(\theta) + \sqrt{3} = 0 \quad 0 \leq \theta \leq 2\pi$

$$\cos(\theta) = -\frac{\sqrt{3}}{2}$$

$\frac{\sqrt{3}}{2}$ suggests $\frac{\pi}{3}$. Since cos is negative,

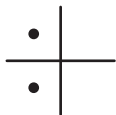

$$\theta = \pi - \frac{\pi}{6}, \pi + \frac{\pi}{6}$$

$$\theta = \frac{5\pi}{6}, \frac{7\pi}{6}$$

b $\tan(x) + \sqrt{3} = 0 \quad 0 \leq x \leq 720^\circ$

$$\tan(x) = -\sqrt{3}$$

$\sqrt{3}$ suggests 60° . Since tan is negative,

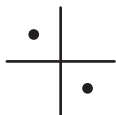

$$x = 180^\circ - 60^\circ, 360^\circ - 60^\circ, 540^\circ - 60^\circ, 720^\circ - 60^\circ$$

$$x = 120^\circ, 300^\circ, 480^\circ, 660^\circ$$

2 a $2\cos(3\theta) - \sqrt{2} = 0 \quad 0 \leq \theta \leq 2\pi$

$$\cos(3\theta) = \frac{\sqrt{2}}{2} \quad 0 \leq 3\theta \leq 6\pi$$

$\frac{\sqrt{2}}{2}$ suggests $\frac{\pi}{4}$. Since cos is positive,

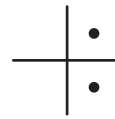

$$3\theta = \frac{\pi}{4}, 2\pi - \frac{\pi}{4}, 2\pi + \frac{\pi}{4}, 4\pi - \frac{\pi}{4}, 4\pi + \frac{\pi}{4}, 6\pi - \frac{\pi}{4}$$

$$3\theta = \frac{\pi}{4}, \frac{7\pi}{4}, \frac{9\pi}{4}, \frac{15\pi}{4}, \frac{17\pi}{4}, \frac{23\pi}{4}$$

$$\theta = \frac{\pi}{12}, \frac{7\pi}{12}, \frac{3\pi}{4}, \frac{5\pi}{4}, \frac{17\pi}{12}, \frac{23\pi}{12}$$

b $2\sin(2x + \pi) + \sqrt{3} = 0 \quad -\pi \leq x \leq \pi$

$$\sin(2x + \pi) = -\frac{\sqrt{3}}{2} \quad -\pi \leq 2x + \pi \leq 3\pi$$

$\frac{\sqrt{3}}{2}$ suggests $\frac{\pi}{3}$. Since sin is negative,

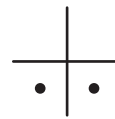

$$2x + \pi = -\pi + \frac{\pi}{3}, -\frac{\pi}{3}, \pi + \frac{\pi}{3}, 2\pi - \frac{\pi}{3}$$

$$2x + \pi = -\frac{2\pi}{3}, -\frac{\pi}{3}, \frac{4\pi}{3}, \frac{5\pi}{3}$$

$$2x = -\frac{2\pi}{3} - \pi, -\frac{\pi}{3} - \pi, \frac{4\pi}{3} - \pi, \frac{5\pi}{3} - \pi$$

$$2x = -\frac{5\pi}{3}, -\frac{4\pi}{3}, \frac{\pi}{3}, \frac{2\pi}{3}$$

$$x = -\frac{5\pi}{6}, -\frac{2\pi}{3}, \frac{\pi}{6}, \frac{\pi}{3}$$

3 a $\sqrt{2}\sin(\theta) = -1 \quad 0 \leq \theta \leq 2\pi$

$$\sin(\theta) = -\frac{1}{\sqrt{2}}$$

$\frac{1}{\sqrt{2}}$ suggests $\frac{\pi}{4}$. Since sin is negative,

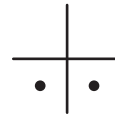

$$\theta = \pi + \frac{\pi}{4}, 2\pi - \frac{\pi}{4}$$

$$\theta = \frac{5\pi}{4}, \frac{7\pi}{4}$$

b $2\cos(\theta) = 1 \quad 0 \leq \theta \leq 2\pi$

$$\cos(\theta) = \frac{1}{2}$$

$\frac{1}{2}$ suggests $\frac{\pi}{3}$. Since cos is positive,

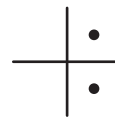

$$\theta = \frac{\pi}{3}, 2\pi - \frac{\pi}{3}$$

$$\theta = \frac{\pi}{3}, \frac{5\pi}{3}$$

$$\text{c } \tan(3\theta) - \sqrt{3} = 0 \quad 0 \leq \theta \leq 2\pi$$

$$\tan(3\theta) = \sqrt{3} \quad 0 \leq 3\theta \leq 6\pi$$

$\sqrt{3}$ suggests $\frac{\pi}{3}$. Since tan is positive,

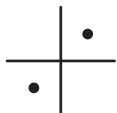

$$3\theta = \frac{\pi}{3}, \pi + \frac{\pi}{3}, 2\pi + \frac{\pi}{3}, 3\pi + \frac{\pi}{3}, 4\pi + \frac{\pi}{3}, 5\pi + \frac{\pi}{3}$$

$$3\theta = \frac{\pi}{3}, \frac{4\pi}{3}, \frac{7\pi}{3}, \frac{10\pi}{3}, \frac{13\pi}{3}, \frac{16\pi}{3}$$

$$\theta = \frac{\pi}{9}, \frac{4\pi}{9}, \frac{7\pi}{9}, \frac{10\pi}{9}, \frac{13\pi}{9}, \frac{16\pi}{9}$$

$$\text{d } \tan\left(\theta - \frac{\pi}{2}\right) + 1 = 0 \quad 0 \leq \theta \leq 2\pi$$

$$\tan\left(\theta - \frac{\pi}{2}\right) = -1 \quad -\frac{\pi}{2} \leq \theta - \frac{\pi}{2} \leq 2\pi - \frac{\pi}{2}$$

1 suggests $\frac{\pi}{4}$. Since tan is negative,

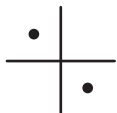

$$\theta - \frac{\pi}{2} = -\frac{\pi}{4}, \pi - \frac{\pi}{4}$$

$$\theta - \frac{\pi}{2} = -\frac{\pi}{4}, \frac{3\pi}{4}$$

$$\theta = -\frac{\pi}{4} + \frac{\pi}{2}, \frac{3\pi}{4} + \frac{\pi}{2}$$

$$\theta = \frac{\pi}{4}, \frac{5\pi}{4}$$

$$\text{4 a } 2 \cos(x) + 1 = 0 \quad 0^\circ \leq x \leq 360^\circ$$

$$2 \cos(x) = -1$$

$$\cos(x) = -\frac{1}{2}$$

$\frac{1}{2}$ suggests 60° . Since cos is negative,

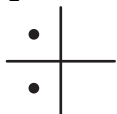

$$x = 180^\circ - 60^\circ, 180^\circ + 60^\circ$$

$$x = 120^\circ, 240^\circ$$

$$\text{b } 2 \sin(2x) + \sqrt{2} = 0 \quad 0^\circ \leq x \leq 360^\circ$$

$$\sin(2x) = -\frac{\sqrt{2}}{2} \quad 0^\circ \leq 2x \leq 720^\circ$$

$\frac{\sqrt{2}}{2}$ suggests 45° . Since sin is negative,

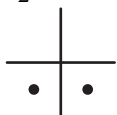

$$2x = 180^\circ + 45^\circ, 360^\circ - 45^\circ, 540^\circ + 45^\circ, 720^\circ - 45^\circ$$

$$2x = 225^\circ, 315^\circ, 585^\circ, 675^\circ$$

$$x = 112.5^\circ, 157.5^\circ, 292.5^\circ, 337.5^\circ$$

$$\text{5 a } 2 \sin(2\theta) + \sqrt{3} = 0 \quad -\pi \leq \theta \leq \pi$$

$$\sin(2\theta) = -\frac{\sqrt{3}}{2} \quad -2\pi \leq 2\theta \leq 2\pi$$

$\frac{\sqrt{3}}{2}$ suggests $\frac{\pi}{3}$. Since sin is negative,

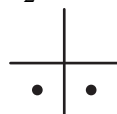

$$2\theta = -\pi + \frac{\pi}{3}, -\frac{\pi}{3}, \pi + \frac{\pi}{3}, 2\pi - \frac{\pi}{3}$$

$$2\theta = -\frac{2\pi}{3}, -\frac{\pi}{3}, \frac{4\pi}{3}, \frac{5\pi}{3}$$

$$\theta = -\frac{\pi}{3}, -\frac{\pi}{6}, \frac{2\pi}{3}, \frac{5\pi}{6}$$

$$\text{b } \sqrt{2} \cos(3\theta) = 1 \quad -\pi \leq \theta \leq \pi$$

$$\cos(3\theta) = \frac{1}{\sqrt{2}} \quad -3\pi \leq 3\theta \leq 3\pi$$

$\frac{1}{\sqrt{2}}$ suggests $\frac{\pi}{4}$. Since cos is positive,

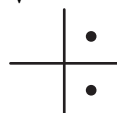

$$3\theta = -2\pi - \frac{\pi}{4}, -2\pi + \frac{\pi}{4}, -\frac{\pi}{4}, \frac{\pi}{4}, 2\pi - \frac{\pi}{4}, 2\pi + \frac{\pi}{4}$$

$$3\theta = -\frac{9\pi}{4}, -\frac{7\pi}{4}, -\frac{\pi}{4}, \frac{\pi}{4}, \frac{7\pi}{4}, \frac{9\pi}{4}$$

$$\theta = -\frac{3\pi}{4}, -\frac{7\pi}{12}, -\frac{\pi}{12}, \frac{\pi}{12}, \frac{7\pi}{12}, \frac{3\pi}{4}$$

$$\text{c } \tan(2\theta) + 1 = 0 \quad -\pi \leq \theta \leq \pi$$

$$\tan(2\theta) = -1 \quad -2\pi \leq 2\theta \leq 2\pi$$

1 suggests $\frac{\pi}{4}$. Since tan is negative,

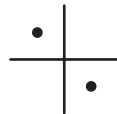

$$2\theta = -\pi - \frac{\pi}{4}, -\frac{\pi}{4}, \pi - \frac{\pi}{4}, 2\pi - \frac{\pi}{4}$$

$$2\theta = -\frac{5\pi}{4}, -\frac{\pi}{4}, \frac{3\pi}{4}, \frac{7\pi}{4}$$

$$\theta = -\frac{5\pi}{8}, -\frac{\pi}{8}, \frac{3\pi}{8}, \frac{7\pi}{8}$$

$$\text{d } 2 \cos(\theta) = 1 \quad -\pi \leq \theta \leq \pi$$

$$\cos(\theta) = \frac{1}{2}$$

$\frac{1}{2}$ suggests $\frac{\pi}{3}$. Since cos is positive,

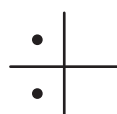

$$\theta = -\frac{\pi}{3}, \frac{\pi}{3}$$

$$6 \text{ a } 2 \sin\left(2x + \frac{\pi}{4}\right) = \sqrt{2} \quad -\pi \leq x \leq \pi$$

$$\sin\left(2x + \frac{\pi}{4}\right) = \frac{\sqrt{2}}{2} \quad -2\pi \leq 2x \leq 2\pi$$

$$\sin\left(2x + \frac{\pi}{4}\right) = \frac{\sqrt{2}}{2} \quad -2\pi + \frac{\pi}{4} \leq 2x + \frac{\pi}{4} \leq 2\pi + \frac{\pi}{4}$$

$\frac{\sqrt{2}}{2}$ suggests $\frac{\pi}{4}$. Since sin is positive,



$$2x + \frac{\pi}{4} = -2\pi + \frac{\pi}{4}, -\pi - \frac{\pi}{4}, \frac{\pi}{4}, \pi - \frac{\pi}{4}, 2\pi + \frac{\pi}{4}$$

$$2x + \frac{\pi}{4} = -\frac{7\pi}{4}, -\frac{5\pi}{4}, \frac{\pi}{4}, \frac{3\pi}{4}, \frac{9\pi}{4}$$

$$2x = -2\pi, -\frac{3\pi}{2}, 0, \frac{\pi}{2}, 2\pi$$

$$x = -\pi, -\frac{3\pi}{4}, 0, \frac{\pi}{4}, \pi$$

$$6 \text{ b } 2 \cos(x + \pi) = \sqrt{3} \quad -\pi \leq x \leq \pi$$

$$\cos(x + \pi) = \frac{\sqrt{3}}{2} \quad 0 \leq x + \pi \leq 2\pi$$

$\frac{\sqrt{3}}{2}$ suggests $\frac{\pi}{6}$. Since cos is positive



$$x + \pi = \frac{\pi}{6}, 2\pi - \frac{\pi}{6}$$

$$x + \pi = \frac{\pi}{6}, \frac{11\pi}{6}$$

$$x = \frac{\pi}{6} - \pi, \frac{11\pi}{6} - \pi$$

$$x = -\frac{5\pi}{6}, \frac{5\pi}{6}$$

$$6 \text{ c } \tan(x - \pi) = -1 \quad -\pi \leq x \leq \pi$$

$$\tan(x - \pi) = -1 \quad -2\pi \leq x - \pi \leq 0$$

It suggests $\frac{\pi}{4}$. Since tan is negative,

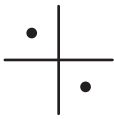

$$x - \pi = -\pi - \frac{\pi}{4}, -\frac{\pi}{4}$$

$$x - \pi = -\frac{5\pi}{4}, -\frac{\pi}{4}$$

$$x = -\frac{5\pi}{4} + \pi, -\frac{\pi}{4} + \pi$$

$$x = -\frac{\pi}{4}, \frac{3\pi}{4}$$

$$6 \text{ d } 2 \cos\left(3x - \frac{\pi}{2}\right) + \sqrt{3} = 0 \quad 0 \leq x \leq 2\pi$$

$$\cos\left(3x - \frac{\pi}{2}\right) = -\frac{\sqrt{3}}{2} \leq 3x \leq 6\pi$$

$$\cos\left(3x - \frac{\pi}{2}\right) = -\frac{\sqrt{3}}{2} \quad -\frac{\pi}{2} \leq 3x - \frac{\pi}{2} \leq 6\pi - \frac{\pi}{2}$$

$\frac{\sqrt{3}}{2}$ suggests $\frac{\pi}{6}$. Since cos is negative,

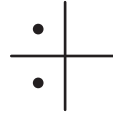

$$3x - \frac{\pi}{2} = \pi - \frac{\pi}{6}, \pi + \frac{\pi}{6}, 3\pi - \frac{\pi}{6}, 3\pi + \frac{\pi}{6},$$

$$5\pi - \frac{\pi}{6}, 5\pi + \frac{\pi}{6}$$

$$3x - \frac{\pi}{2} = \frac{5\pi}{6}, \frac{7\pi}{6}, \frac{17\pi}{6}, \frac{19\pi}{6}, \frac{29\pi}{6}, \frac{31\pi}{6}$$

$$3x = \frac{5\pi}{6} + \frac{\pi}{6}, \frac{7\pi}{6} + \frac{\pi}{6}, \frac{17\pi}{6} + \frac{\pi}{6}, \frac{19\pi}{6} + \frac{\pi}{6},$$

$$\frac{29\pi}{6} + \frac{\pi}{6}, \frac{31\pi}{6} + \frac{\pi}{6}$$

$$3x = \frac{4\pi}{3}, \frac{5\pi}{3}, \frac{10\pi}{3}, \frac{11\pi}{3}, \frac{16\pi}{3}, \frac{17\pi}{3}$$

$$x = \frac{4\pi}{9}, \frac{5\pi}{9}, \frac{10\pi}{9}, \frac{11\pi}{9}, \frac{16\pi}{9}, \frac{17\pi}{9}$$

$$7 \text{ a } 3 \sin(\theta) - 2 = 0 \quad 0 \leq \theta \leq 2\pi$$

$$\sin(\theta) = \frac{2}{3}$$

$\frac{2}{3}$ suggests 0.7297° . Since sin is positive,

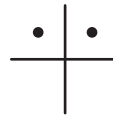

$$\theta = 0.7297, \pi - 0.7297$$

$$\theta = 0.73, 2.41$$

or solve on CAS

$$7 \text{ b } 7 \cos(x) - 2 = 0 \quad 0^\circ \leq x \leq 360^\circ$$

$$\cos(x) = \frac{2}{7}$$

$\frac{2}{7}$ suggests 73.3985° . Since cos is positive,

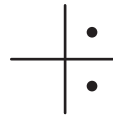

$$x = 73.3985^\circ, 360^\circ - 73.3985^\circ$$

$$x = 73.40^\circ, 286.60^\circ$$

or solve on CAS.

$$8 \text{ a } \sin(\theta) + 0.5768 = 0$$

$$\sin(\theta) = -0.5768$$

0.5768 suggests 36.2258° . Since sin is negative,

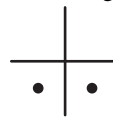

$$\theta = 180^\circ + 36.2258^\circ, 360^\circ - 36.2258^\circ$$

$$\theta = 215.23^\circ, 324.77^\circ$$

Or solve on CAS.

b $\sin(x) = 1 \Rightarrow x = -\frac{3\pi}{2}, \frac{\pi}{2}$ for $-2\pi \leq x \leq 2\pi$.

9 $\sin(3\theta) = \cos(2\theta)$

Using CAS:

$$\theta = 0.314, 1.571, 2.827, 4.084, 5.341$$

10 $2 \sin(2x) - 1 = -\frac{1}{2}x + 1$

Using CAS:

$$x = 0.526, 1.179$$

11 $\cos^2(\theta) - \sin(\theta)\cos(\theta) = 0 \quad 0 \leq \theta \leq 2\pi$

$$\cos(\theta)(\cos(\theta) - \sin(\theta)) = 0$$

$$\cos(\theta) = 0 \quad \text{or} \quad \cos(\theta) - \sin(\theta) = 0$$

$$\theta = \frac{\pi}{2}, \frac{3\pi}{2}$$

$$\cos(\theta) = \sin(\theta)$$

$$\frac{\cos(\theta)}{\cos(\theta)} = \frac{\sin(\theta)}{\cos(\theta)}$$

$$1 = \tan(\theta)$$

1 suggests $\frac{\pi}{4}$. Since tan is positive,

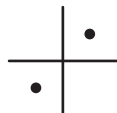

$$\theta = \frac{\pi}{4}, \pi + \frac{\pi}{4}$$

$$\theta = \frac{\pi}{4}, \frac{5\pi}{4}$$

Therefore, $\theta = \frac{\pi}{4}, \frac{\pi}{2}, \frac{5\pi}{4}, \frac{3\pi}{2}$.

12 $2\cos^2(\theta) + 3\cos(\theta) = -1 \quad 0 \leq \theta \leq 2\pi$

$$2\cos^2(\theta) + 3\cos(\theta) + 1 = 0 \quad 0 \leq \theta \leq 2\pi$$

$$(2\cos(\theta) + 1)(\cos(\theta) + 1) = 0$$

$$2\cos(\theta) + 1 = 0 \quad \text{or} \quad \cos(\theta) + 1 = 0$$

$$\cos(\theta) = -\frac{1}{2} \quad \cos(\theta) = -1 \text{ so } \theta = \pi$$

$\frac{1}{2}$ suggests $\frac{\pi}{3}$. Since cos is negative,

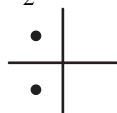

$$\theta = \pi - \frac{\pi}{3}, \pi + \frac{\pi}{3}$$

$$\theta = \frac{2\pi}{3}, \frac{4\pi}{3}$$

Therefore, $\theta = \frac{2\pi}{3}, \pi, \frac{4\pi}{3}$.

The sum of the solutions = $\frac{2\pi}{3} + \pi + \frac{4\pi}{3}$

$$= \frac{9\pi}{3}$$

$$= 3\pi$$

The correct answer is C.

13 a $\tan^2(\theta) - 1 = 0 \quad 0 \leq \theta \leq 2\pi$

$$(\tan(\theta) - 1)(\tan(\theta) + 1) = 0$$

$$\tan(\theta) - 1 = 0 \quad \text{or} \quad \tan(\theta) + 1 = 0$$

$$\tan(\theta) = 1 \quad \tan(\theta) = -1$$

$$\theta = \frac{\pi}{4}, \frac{5\pi}{4}$$

$$\theta = \frac{3\pi}{4}, \frac{7\pi}{4}$$

$$\theta = \frac{\pi}{4}, \frac{3\pi}{4}, \frac{5\pi}{4}, \frac{7\pi}{4}$$

b $4\sin^2(\theta) - (2 + 2\sqrt{3})\sin(\theta) + \sqrt{3} = 0 \quad 0 \leq \theta \leq 2\pi$

$$(2\sin(\theta) - \sqrt{3})(2\sin(\theta) - 1) = 0$$

$$2\sin(\theta) - \sqrt{3} = 0 \quad \text{or} \quad 2\sin(\theta) - 1 = 0$$

$$\sin(\theta) = \frac{\sqrt{3}}{2} \quad 2\sin(\theta) = \frac{1}{2}$$

$\frac{\sqrt{3}}{2}$ suggests $\frac{\pi}{3}$ and $\frac{1}{2}$ suggests $\frac{\pi}{6}$

Since sin is positive,

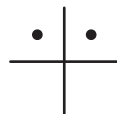

$$\theta = \frac{\pi}{3}, \pi - \frac{\pi}{3} \quad \theta = \frac{\pi}{6}, \pi - \frac{\pi}{6}$$

$$\theta = \frac{\pi}{3}, \frac{2\pi}{3} \quad \theta = \frac{\pi}{6}, \frac{5\pi}{6}$$

$$\theta = \frac{\pi}{6}, \frac{\pi}{3}, \frac{2\pi}{3}, \frac{5\pi}{6}$$

14 a $\sin(\alpha) - \cos^2(\alpha)\sin(\alpha) = 0 \quad -\pi \leq \alpha \leq \pi$

$$\sin(\alpha)(1 - \cos^2(\alpha)) = 0$$

$$\sin(\alpha)(1 - \cos(\alpha))(1 + \cos(\alpha)) = 0$$

$$\sin(\alpha) = 0 \quad 1 - \cos(\alpha) = 0 \quad \text{or} \quad 1 + \cos(\alpha) = 0$$

$$\alpha = -\pi, 0, \pi \quad \text{or} \quad \cos(\alpha) = 1 \quad \cos(\alpha) = -1$$

$$\alpha = 0 \quad \alpha = -\pi, \pi$$

Thus, $\alpha = -\pi, 0, \pi$.

b $\sin(2\alpha) = \sqrt{3}\cos(2\alpha) \quad -\pi \leq \alpha \leq \pi$

$$\frac{\sin(2\alpha)}{\cos(2\alpha)} = \sqrt{3} \frac{\cos(2\alpha)}{\cos(2\alpha)} \quad -2\pi \leq 2\alpha \leq 2\pi$$

$$\tan(2\alpha) = \sqrt{3}$$

$\sqrt{3}$ suggests $\frac{\pi}{3}$. Since tan is positive,

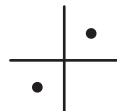

$$2\alpha = -2\pi + \frac{\pi}{3} - \pi + \frac{\pi}{3}, \frac{\pi}{3}, \pi + \frac{\pi}{3}$$

$$2\alpha = -\frac{5\pi}{3}, -\frac{2\pi}{3}, \frac{\pi}{3}, \frac{4\pi}{3}$$

$$\alpha = -\frac{5\pi}{6}, -\frac{\pi}{3}, \frac{\pi}{6}, \frac{2\pi}{3}$$

c $\sin^2(\alpha) = \cos^2(\alpha) \quad -\pi \leq \alpha \leq \pi$

$$\sin^2(\alpha) - \cos^2(\alpha) = 0$$

$$(\sin(\alpha) - \cos(\alpha))(\sin(\alpha) + \cos(\alpha)) = 0$$

$$\sin(\alpha) - \cos(\alpha) = 0 \quad \sin(\alpha) + \cos(\alpha) = 0$$

$$\sin(\alpha) = \cos(\alpha) \quad \text{or} \quad \sin(\alpha) = -\cos(\alpha)$$

$$\tan(\alpha) = 1 \quad \tan(\alpha) = -1$$

$$\alpha = -\frac{3\pi}{4}, \frac{\pi}{4}$$

$$\alpha = -\frac{\pi}{4}, \frac{3\pi}{4}$$

$$\alpha = -\frac{3\pi}{4}, -\frac{\pi}{4}, \frac{\pi}{4}, \frac{3\pi}{4}$$

$$\begin{aligned} \text{d } 4 \cos^2(\alpha) - 1 &= 0 & -\pi \leq \alpha \leq \pi \\ (2 \cos(\alpha))^2 - 1^2 &= 0 \\ (2 \cos(\alpha) - 1)(2 \cos(\alpha) + 1) &= 0 \\ 2 \cos(\alpha) - 1 = 0 & \quad 2 \cos(\alpha) + 1 = 0 \\ \cos(\alpha) = \frac{1}{2} & \quad \text{or} \quad \cos(\alpha) = -\frac{1}{2} \end{aligned}$$

$\frac{1}{2}$ suggests $\frac{\pi}{3}$. Since cos is both positive and negative, all four quadrants.

$$\alpha = -\pi + \frac{\pi}{3}, -\frac{\pi}{3}, \frac{\pi}{3}, \pi - \frac{\pi}{3}$$

$$\alpha = -\frac{2\pi}{3}, -\frac{\pi}{3}, \frac{\pi}{3}, \frac{2\pi}{3}$$

2.3 Exam questions

1 $\tan(\alpha) = d, \quad \alpha = \tan^{-1}(d), \quad 0 < x < \frac{5\pi}{4}$

$$\tan(2x) = d, \quad 0 < 2x < \frac{5\pi}{2}$$

$$2x = \alpha, \quad \pi + \alpha, \quad 2\pi + \alpha$$

$$\sum_{i=1}^3 (2x_i) = 3\pi + 3\alpha = 3(\pi + \alpha)$$

$$\sum_{i=1}^3 (x_i) = \frac{3(\pi + \alpha)}{2}$$

The correct answer is **E**.

2 $\sin(2x) = \frac{\sqrt{3}}{2}$

$$x = -\frac{5\pi}{6}, -\frac{2\pi}{3}, \frac{\pi}{6}, \frac{\pi}{3}, \frac{7\pi}{6} \dots$$

Add solutions together until the sum is equal to $-\pi$:

$$-\frac{5\pi}{6}, -\frac{2\pi}{3}, \frac{\pi}{6} + \frac{\pi}{3} = -\pi$$

The solution $x = \frac{\pi}{3}$ is included in the sum but the solution

$x = \frac{7\pi}{6}$ is not included in the sum; hence, $\frac{\pi}{3} \leq d < \frac{7\pi}{6}$.

The correct answer is **C**.

3 $2 \cos(2x) = -\sqrt{3}$ for $0 \leq x \leq \pi$

$$\cos(2x) = -\frac{\sqrt{3}}{2}$$

$$2x = \cos^{-1}\left(-\frac{\sqrt{3}}{2}\right)$$

$$2x = \frac{5\pi}{6}, \frac{7\pi}{6}$$

$$x = \frac{5\pi}{12}, \frac{7\pi}{12}$$

Award 1 mark for solving the trigonometric equation.

Award 1 mark for both of the correct values.

2.4 General solutions of trigonometric equations

2.4 Exercise

1 a $2 \sin(\theta) - \sqrt{3} = 0$

$$\sin(\theta) = \frac{\sqrt{3}}{2}$$

$$\frac{\sqrt{3}}{2} \text{ suggests } \frac{\pi}{3}.$$

$$\theta = 2n\pi + \frac{\pi}{3} \text{ and } (2n+1)\pi - \frac{\pi}{3}, n \in Z$$

$$= \frac{6n\pi + \pi}{3}, \frac{3(2n+1)\pi - \pi}{3}$$

$$= \frac{6n\pi + \pi}{3}, \frac{6n\pi + 2\pi}{3}, n \in Z$$

b $\sqrt{3} \tan(2\theta) + 1 = 0$

$$\tan(2\theta) = -\frac{1}{\sqrt{3}}$$

The basic angle for $-\frac{1}{\sqrt{3}}$ is $-\frac{\pi}{6}$ (quadrant 4).

$$2\theta = n\pi + \left(-\frac{\pi}{6}\right), n \in Z$$

$$= \frac{6n\pi - \pi}{6}$$

$$= \frac{6n\pi - \pi}{12}, n \in Z$$

For $\theta \in [-\pi, \pi]$, the solutions are:

$$n = -2; \quad \theta = -\frac{13\pi}{12} \text{ (outside the domain)}$$

$$n = -1; \quad \theta = -\frac{7\pi}{12}$$

$$n = 0; \quad \theta = -\frac{\pi}{12}$$

$$n = 1; \quad \theta = \frac{5\pi}{12}$$

$$n = 2; \quad \theta = \frac{11\pi}{12}$$

$$\therefore \theta = -\frac{7\pi}{12}, -\frac{\pi}{12}, \frac{5\pi}{12}, \frac{11\pi}{12}$$

2 a $2 \cos(x) + 1 = 0$

$$\cos(x) = -\frac{1}{2}$$

The basic angle for $-\frac{1}{2}$ is $\frac{2\pi}{3}$ (quadrant 2).

General solution:

$$x = 2n\pi \pm \frac{2\pi}{3}, n \in Z$$

$$= \frac{6n\pi \pm 2\pi}{3}, n \in Z$$

b $2 \sin(x) - \sqrt{2} = 0$

$$\sin(x) = \frac{\sqrt{2}}{2}$$

$$\frac{\sqrt{2}}{2} \text{ suggests } \frac{\pi}{4}.$$

$$\begin{aligned}\theta &= 2n\pi + \frac{\pi}{4} \text{ and } (2n+1)\pi - \frac{\pi}{4}, n \in Z \\ &= \frac{8n\pi + \pi}{4}, \frac{4(2n+1)\pi - \pi}{4} \\ &= \frac{8n\pi + \pi}{4}, \frac{8n\pi + 3\pi}{4}, n \in Z\end{aligned}$$

$$3 \quad 2 \sin(2x) + 1 = 0$$

$$\sin(2x) = -\frac{1}{2}$$

The basic angle for $-\frac{1}{2}$ is $-\frac{\pi}{6}$ (quadrant 4).

$$2\theta = 2n\pi + \left(-\frac{\pi}{6}\right) \text{ and } (2n+1)\pi - \left(-\frac{\pi}{6}\right), n \in Z$$

$$\begin{aligned}2\theta &= \frac{12n\pi - \pi}{6}, \frac{6(2n+1)\pi + \pi}{6} \\ &= \frac{12n\pi - \pi}{6}, \frac{12n\pi + 7\pi}{6}, n \in Z\end{aligned}$$

$$\theta = \frac{12n\pi - \pi}{12}, \frac{12n\pi + 7\pi}{12}, n \in Z$$

$$n = 0: \quad \theta = -\frac{\pi}{12}, \frac{7\pi}{12}$$

$$n = 1: \quad \theta = \frac{11\pi}{12}, \frac{19\pi}{12}$$

$$n = 2: \quad \theta = \frac{23\pi}{12}, \frac{31\pi}{12}$$

$$\therefore \theta = \frac{7\pi}{12}, \frac{11\pi}{12}, \frac{19\pi}{12}, \frac{23\pi}{12}$$

$$4 \quad \sqrt{3} \sin\left(x + \frac{\pi}{2}\right) = \cos\left(x + \frac{\pi}{2}\right)$$

$$\sqrt{3} \tan\left(x + \frac{\pi}{2}\right) = 1$$

$$\tan\left(x + \frac{\pi}{2}\right) = \frac{1}{\sqrt{3}}$$

$\frac{\pi}{6}$ is the base angle

General solution:

$$x + \frac{\pi}{2} = n\pi + \frac{\pi}{6}, n \in Z$$

$$x = n\pi - \frac{\pi}{3}$$

$$= \frac{3n\pi - \pi}{3}, n \in Z$$

$$n = -1: \quad x = -\frac{4\pi}{3}$$

$$n = 0: \quad x = -\frac{\pi}{3}$$

$$n = 1: \quad x = \frac{2\pi}{3}$$

$$\therefore x = -\frac{\pi}{3}, \frac{2\pi}{3}$$

$$5 \quad 2 \cos(2\theta) - 2 = 0$$

$$\cos(2\theta) = 1$$

$$2\theta = \dots - 2\pi, 0, 2\pi, 4\pi \dots$$

$$\theta = \dots - \pi, 0, \pi, 2\pi \dots$$

$$\therefore \theta = n\pi, n \in Z$$

$$6 \quad 3 \tan\left(2\theta + \frac{\pi}{6}\right) = 0$$

$$\tan\left(2\theta + \frac{\pi}{6}\right) = 0$$

$$2\theta + \frac{\pi}{6} = \dots - \pi, 0, \pi, 2\pi \dots$$

$$2\theta + \frac{\pi}{6} = n\pi, n \in Z$$

$$2\theta = n\pi - \frac{\pi}{6}$$

$$= \frac{6n\pi - \pi}{6}$$

$$\theta = \frac{6n\pi - \pi}{12}, n \in Z$$

2.4 Exam questions

$$1 \quad 2 \cos\left(2x - \frac{\pi}{3}\right) + 1 = 0$$

$$2 \cos\left(2x - \frac{\pi}{3}\right) = -1$$

$$\cos\left(2x - \frac{\pi}{3}\right) = -\frac{1}{2}$$

$$2x - \frac{\pi}{3} = 2k\pi \pm \cos^{-1}\left(-\frac{1}{2}\right)$$

$$2x - \frac{\pi}{3} = 2k\pi \pm \frac{2\pi}{3}$$

$$2x = 2k\pi + \pi, 2k\pi - \frac{\pi}{3}$$

$$2x = \pi(2k+1), \frac{\pi}{3}(6k-1)$$

$$x = \frac{\pi}{2}(2k+1), \frac{\pi}{6}(6k-1)$$

$$x = \frac{\pi}{6}(6k+3), \frac{\pi}{6}(6k-1), k \in Z$$

The correct answer is **D**.

$$2 \quad x - \frac{\pi}{3} = \sin^{-1}\left(\frac{\sqrt{3}}{2}\right) + 2\pi n \text{ and}$$

$$x - \frac{\pi}{3} = (2n+1)\pi - \sin^{-1}\left(\frac{\sqrt{3}}{2}\right), \text{ where } n \in Z \quad [1 \text{ mark}]$$

$$x - \frac{\pi}{3} = \frac{\pi}{3} + 2\pi n \text{ and } x - \frac{\pi}{3} = (2n+1)\pi - \frac{\pi}{3},$$

where $n \in Z$

$$x = \frac{2\pi}{3} + 2\pi n \text{ and } x = (2n+1)\pi \text{ where } n \in Z \quad [1 \text{ mark}]$$

$$3 \quad \sin(2x) = -1$$

$$2x = \sin^{-1}(-1)$$

$$2x = -\frac{\pi}{2} + 2n\pi, n \in Z$$

$$2x = \frac{-\pi + 4n\pi}{2}, n \in Z$$

$$x = \frac{-\pi + 4n\pi}{4}, n \in Z$$

$$x = n\pi - \frac{\pi}{4}, n \in Z$$

The correct answer is **C**.

2.5 The sine and cosine functions

2.5 Exercise

$$1 \quad \mathbf{a} \quad y = 6 \sin(8x)$$

$$\text{Period } \frac{2\pi}{8} = \frac{\pi}{4}, \text{ amplitude } 6$$

Mean position $y = 0$, so the range is $[-6, 6]$.

$$\mathbf{b} \quad y = 2 - 3 \cos\left(\frac{x}{4}\right)$$

Period $2\pi \div \frac{1}{4} = 8\pi$, amplitude 3

Mean position $y = 2$, so the range is $[-1, 5]$.

$$\mathbf{c} \quad y = -\sin(3x - 6)$$

Period $\frac{2\pi}{3}$, amplitude 1

Mean position $y = 0$, so the range is $[-1, 1]$.

$$\mathbf{d} \quad y = 3(5 + 2 \cos(6\pi x))$$

$$y = 15 + 6 \cos(6\pi x)$$

Period $\frac{2\pi}{6\pi} = \frac{1}{3}$, amplitude 6

Mean position $y = 15$, so the range is $[9, 21]$.

$$\mathbf{2} \quad \mathbf{a} \quad y = 2 \cos(4x) - 3, \quad 0 \leq x \leq 2\pi$$

Period $\frac{2\pi}{4} = \frac{\pi}{2}$

Amplitude 2

Mean position $y = -3$

Range $[-3 - 2, -3 + 2] = [-5, -1]$

No x -intercepts

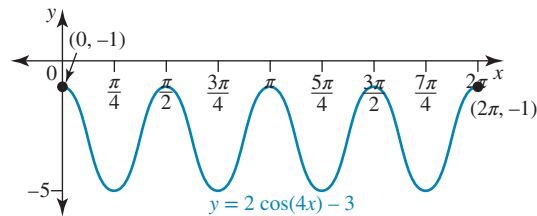

\mathbf{b} Let the equation be $y = a \sin(nx) + k$.

The period of the graph is 2.

$$\therefore \frac{2\pi}{n} = 2$$

$$\therefore n = \pi$$

The mean position is 5.

$$y = 5 \Rightarrow k = 5.$$

The range is $[-3, 13]$, which means the amplitude is 8.

As the graph has an inverted sine shape, $a = -8$.

The equation is $y = -8 \sin(\pi x) + 5$.

$$\mathbf{3} \quad f: [0, 2\pi] \rightarrow R, f(x) = 1 - 2 \sin\left(\frac{3x}{2}\right)$$

$$y = f(x) = 1 - 2 \sin\left(\frac{3x}{2}\right)$$

Period $2\pi \div \frac{3}{2} = \frac{4\pi}{3}$

Amplitude 2, inverted graph

Mean position $y = 1$

Range $[-1, 3]$

x -intercepts: let $y = 0$.

$$0 = 1 - 2 \sin\left(\frac{3x}{2}\right), \quad 0 \leq x \leq 2\pi$$

$$\therefore \sin\left(\frac{3x}{2}\right) = \frac{1}{2}, \quad 0 \leq \frac{3x}{2} \leq 3\pi$$

$$\therefore \frac{3x}{2} = \frac{\pi}{6}, \pi - \frac{\pi}{6}, 2\pi + \frac{\pi}{6}, 3\pi - \frac{\pi}{6}$$

$$\therefore \frac{3x}{2} = \frac{\pi}{6}, \frac{5\pi}{6}, \frac{13\pi}{6}, \frac{17\pi}{6}$$

$$\therefore 3x = \frac{\pi}{3}, \frac{5\pi}{3}, \frac{13\pi}{3}, \frac{17\pi}{3}$$

$$\therefore x = \frac{\pi}{9}, \frac{5\pi}{9}, \frac{13\pi}{9}, \frac{17\pi}{9}$$

y -intercept: let $x = 0$.

$$y = 1 - 2 \sin(0) = 1$$

$(0, 1)$

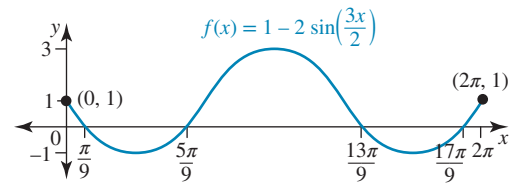

$$\mathbf{4} \quad f: \left[0, \frac{3\pi}{2}\right] \rightarrow R, f(x) = -6 \sin\left(3x - \frac{3\pi}{4}\right)$$

$$y = f(x) = -6 \sin\left(3x - \frac{3\pi}{4}\right)$$

$$\therefore y = -6 \sin\left(3\left(x - \frac{\pi}{4}\right)\right)$$

Horizontal translation $\frac{\pi}{4}$ units to the right

Period $\frac{2\pi}{3}$

The amplitude is 6, and the graph is inverted.

Mean position $y = 0$, so the range is $[-6, 6]$.

End points:

$$f(0) = -6 \sin\left(-\frac{3\pi}{4}\right)$$

$$= -6 \times \frac{-\sqrt{2}}{2}$$

$$= 3\sqrt{2}$$

$$f\left(\frac{3\pi}{2}\right) = -6 \sin\left(\frac{15\pi}{4}\right)$$

$$= -6 \times \frac{-\sqrt{2}}{2}$$

$$= 3\sqrt{2}$$

End points are $(0, 3\sqrt{2})$ and $\left(\frac{3\pi}{2}, 3\sqrt{2}\right)$.

x -intercepts: Either translate those of $y = -6 \sin(3x)$ $\frac{\pi}{4}$ units

to the right or solve $-6 \sin\left(3x - \frac{3\pi}{4}\right) = 0$.

Solving the equation:

$$\sin\left(3x - \frac{3\pi}{4}\right) = 0$$

$$\therefore 3x - \frac{3\pi}{4} = 0, \pi, 2\pi, 3\pi$$

$$\therefore 3x = \frac{3\pi}{4}, \frac{7\pi}{4}, \frac{11\pi}{4}, \frac{15\pi}{4}$$

$$\therefore x = \frac{\pi}{4}, \frac{7\pi}{12}, \frac{11\pi}{12}, \frac{5\pi}{4}$$

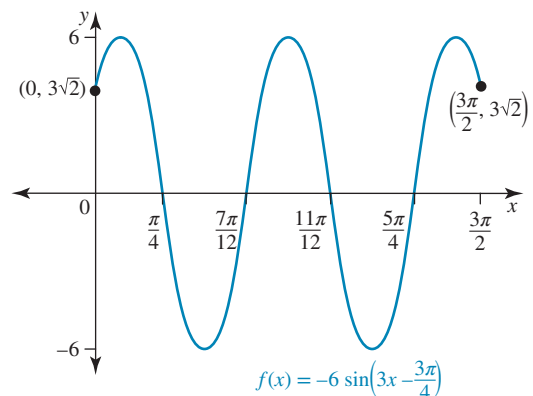

5 a $y = -7 \cos(4x)$, $0 \leq x \leq \pi$

Period $\frac{2\pi}{4} = \frac{\pi}{2}$, amplitude 7, graph is inverted, mean position $y = 0$, range $[-7, 7]$

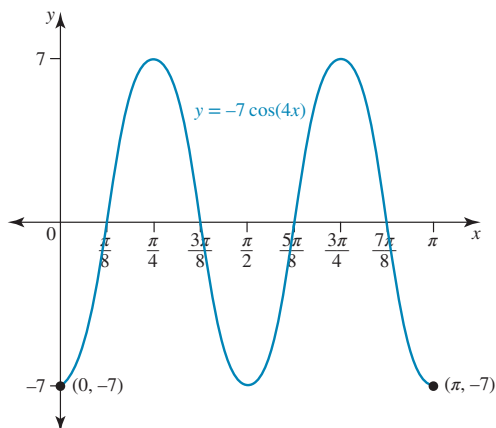

b $y = 5 - \sin(x)$, $0 \leq x \leq 2\pi$

Period 2π , amplitude 1, graph is inverted, mean position $y = 5$, range $[4, 6]$

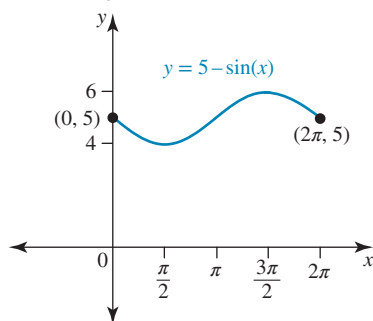

c $y = \frac{1}{2} \cos(2x) + 3$, $-\pi \leq x \leq 2\pi$

Period $\frac{2\pi}{2} = \pi$, amplitude $\frac{1}{2}$, mean position $y = 3$, range $[2.5, 3.5]$

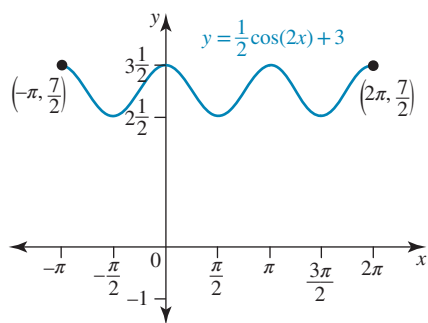

d $y = 2 - 4 \sin(3x)$, $0 \leq x \leq 2\pi$

Period $\frac{2\pi}{3}$, amplitude 4, graph is inverted, mean position $y = 2$, range $[-2, 6]$
 y-intercepts: let $y = 0$.
 $\therefore 0 = 2 - 4 \sin(3x)$, $0 \leq x \leq 2\pi$
 $\therefore \sin(3x) = \frac{1}{2}$, $0 \leq 3x \leq 6\pi$

$$\therefore 3x = \frac{\pi}{6}, \pi - \frac{\pi}{6}, 2\pi + \frac{\pi}{6}, 3\pi - \frac{\pi}{6}, 4\pi + \frac{\pi}{6}, 5\pi - \frac{\pi}{6}$$

$$\therefore 3x = \frac{\pi}{6}, \frac{5\pi}{6}, \frac{13\pi}{6}, \frac{17\pi}{6}, \frac{25\pi}{6}, \frac{29\pi}{6}$$

$$\therefore x = \frac{\pi}{18}, \frac{5\pi}{18}, \frac{13\pi}{18}, \frac{17\pi}{18}, \frac{25\pi}{18}, \frac{29\pi}{18}$$

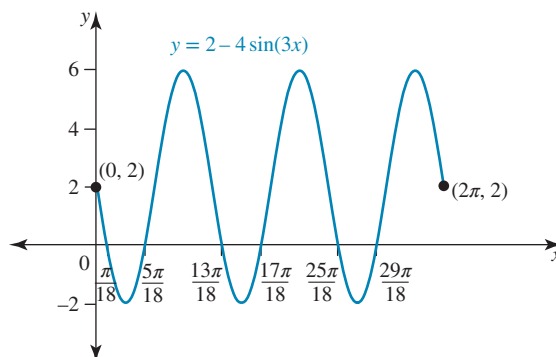

e $y = 2 \sin\left(x + \frac{\pi}{4}\right)$, $0 \leq x \leq 2\pi$

Period 2π , amplitude 2, horizontal shift $\frac{\pi}{4}$ to left, mean position $y = 0$, range $[-2, 2]$

y-intercept: let $x = 0$.

$$\therefore y = \sqrt{2}$$

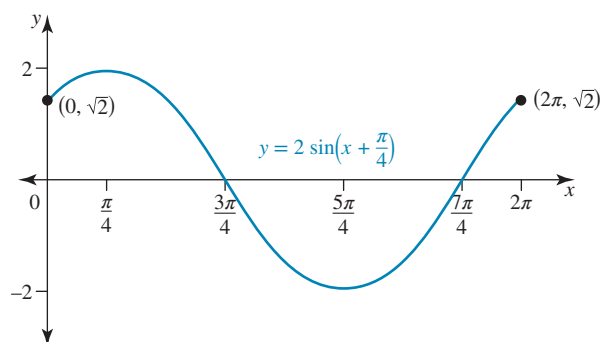

Points on $y = 2 \sin(x)$ are moved $\frac{\pi}{4}$ to the left.

f $y = -4 \cos\left(3x - \frac{\pi}{2}\right) + 4$, $-\frac{\pi}{2} \leq x \leq \frac{3\pi}{2}$

$$y = -4 \cos\left(3\left(x - \frac{\pi}{6}\right)\right) + 4$$

Period $\frac{2\pi}{3}$, amplitude 4, graph is inverted, horizontal translation $\frac{\pi}{6}$ to the right, mean position $y = 4$, range $[0, 8]$
 x-intercepts: let $y = 0$.

$$\therefore -4 \cos\left(3x - \frac{\pi}{2}\right) + 4 = 0, -\frac{\pi}{2} \leq x \leq \frac{3\pi}{2}$$

$$\therefore \cos\left(3x - \frac{\pi}{2}\right) = 1, -2\pi \leq 3x - \frac{\pi}{2} \leq 2\pi$$

$$\therefore 3x - \frac{\pi}{2} = -2\pi, -\pi, 0, \pi, 2\pi$$

$$\therefore 3x = -\frac{3\pi}{2}, -\frac{\pi}{2}, \frac{\pi}{2}, \frac{3\pi}{2}, \frac{5\pi}{2}$$

$$\therefore x = -\frac{\pi}{2}, -\frac{\pi}{6}, \frac{\pi}{6}, \frac{\pi}{2}, \frac{5\pi}{6}$$

y-intercepts: let $x = 0$.

$$y = 4$$

End points: let $x = -\frac{\pi}{2}$.

$$\begin{aligned} y &= -4 \cos\left(-\frac{3\pi}{2} - \frac{\pi}{2}\right) + 4 \\ &= -4 \cos(-2\pi) + 4 \\ &= 0 \end{aligned}$$

Let $x = \frac{3\pi}{2}$.

$$\begin{aligned} y &= -4 \cos\left(\frac{9\pi}{2} - \frac{\pi}{2}\right) + 4 \\ &= -4 \cos(4\pi) + 4 \\ &= 0 \end{aligned}$$

The end points are $\left(-\frac{\pi}{2}, 0\right)$ and $\left(\frac{3\pi}{2}, 0\right)$.

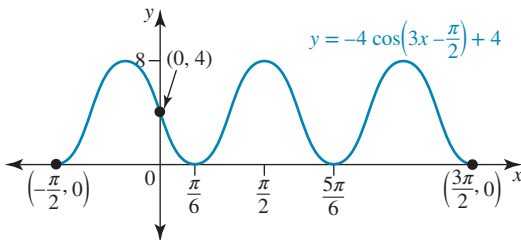

- 6 To find k , take the average of the maximum and minimum values (mean position): $k = \frac{3 + (-1)}{2} = 1$.

The amplitude is the distance from the mean position to the maximum (or minimum): amplitude = 2. This means that $a = 2$ (we were told the function is positive).

Substitute in the point:

$$\begin{aligned} y &= 2 \sin(x - h) + 1 \\ \sqrt{2} + 1 &= 2 \sin(\pi - h) + 1 \\ \sqrt{2} &= 2 \sin(\pi - h) \end{aligned}$$

$$\sin(\pi - h) = \frac{\sqrt{2}}{2}$$

$$\pi - h = \frac{\pi}{4} \quad (\text{only need to consider first quadrant})$$

$$h = \pi - \frac{\pi}{4}$$

$$= \frac{3\pi}{4}$$

Therefore, $y = 2 \sin\left(x - \frac{3\pi}{4}\right) + 1$.

The correct answer is A.

- 7 a i $2 \sin(2x) + \sqrt{3} = 0$ for $x \in [0, 2\pi]$

$$\therefore \sin(2x) = -\frac{\sqrt{3}}{2}, \quad 2x \in [0, 4\pi]$$

$$\therefore 2x = \pi + \frac{\pi}{3}, 2\pi - \frac{\pi}{3}, 3\pi + \frac{\pi}{3}, 4\pi - \frac{\pi}{3}$$

$$\therefore 2x = \frac{4\pi}{3}, \frac{5\pi}{3}, \frac{10\pi}{3}, \frac{11\pi}{3}$$

$$\therefore x = \frac{2\pi}{3}, \frac{5\pi}{6}, \frac{5\pi}{3}, \frac{11\pi}{6}$$

- ii Graph of $y = \sin(2x)$ for $x \in [0, 2\pi]$
Period π , amplitude 1, range $[-1, 1]$

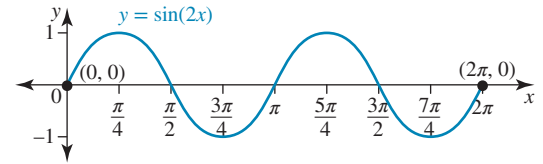

$$\text{iii } \left\{ x: \sin(2x) < -\frac{\sqrt{3}}{2}, 0 \leq x \leq 2\pi \right\}$$

Draw the line $y = -\frac{\sqrt{3}}{2}$ on the graph of $y = \sin(2x)$. At

their intersections, $\sin(2x) = -\frac{\sqrt{3}}{2}$; therefore,

$2 \sin(2x) + \sqrt{3} = 0$, the solutions to which were found in part ai as $x = \frac{2\pi}{3}, \frac{5\pi}{6}, \frac{5\pi}{3}, \frac{11\pi}{6}$.

The sine curve lies below the line for $\frac{2\pi}{3} < x < \frac{5\pi}{6}$ and $\frac{5\pi}{3} < x < \frac{11\pi}{6}$.

The solution set is

$$\left\{ x: \frac{2\pi}{3} < x < \frac{5\pi}{6} \right\} \cup \left\{ x: \frac{5\pi}{3} < x < \frac{11\pi}{6} \right\}.$$

- b The function $f(x) = 2 - 3 \cos\left(x + \frac{\pi}{12}\right)$ has a range $[-1, 5]$, so its maximum value is 5.

This occurs when $\cos\left(x + \frac{\pi}{12}\right) = -1$. The first positive solution occurs when $x + \frac{\pi}{12} = \pi$, giving the value

$$x = \frac{11\pi}{12} \text{ for when the function is at its greatest value.}$$

- 8 $y = \cos(2x) - 3 \cos(x)$ for $x \in [0, 2\pi]$.

$y = y_1 + y_2$ where $y_1 = \cos(2x)$ and $y_2 = -3 \cos(x)$

$y_1 = \cos(2x)$ has period π , amplitude 1, range $[-1, 1]$.

$y_2 = -3 \cos(x)$ has period 2π , amplitude 3, inverted graph, range $[-3, 3]$.

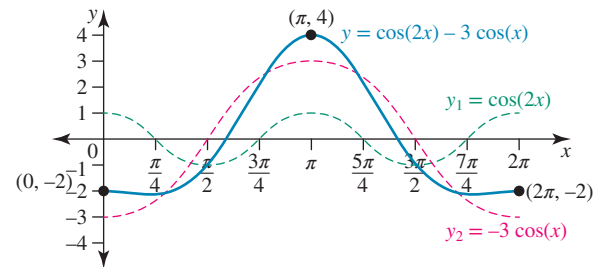

- 9 To sketch the graph of $y = (\sin(x))^2 = \sin^2(x)$ for $x \in [-\pi, \pi]$, remember that $(-1)^2 = 1, 0^2 = 0, 1^2 = 1$. The squared graph will not lie below the x -axis.

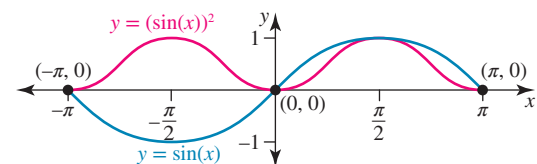

- 10 a $y = \sin(2x) - 4 \sin(x)$, $0 \leq x \leq 2\pi$

$y_1 = \sin(2x)$ has period π and amplitude 1.

$y_2 = -4 \sin(x)$ has period 2π and amplitude 4, and its graph is inverted.

The required graph is $y = y_1 + y_2$.

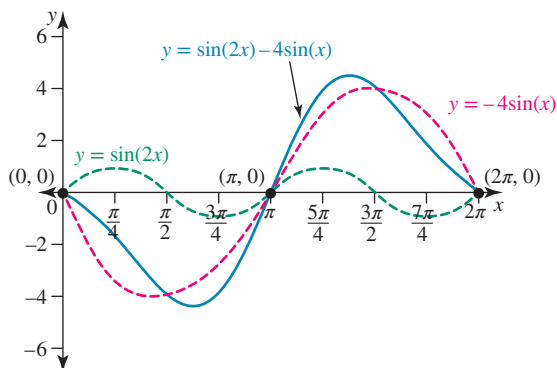

b $y = x + \sin(x)$, $0 \leq x \leq 2\pi$

Mixing an algebraic function with a trigonometric function creates a challenge with the scaling of the axes. This can be overcome by using the decimal approximations

$$\frac{\pi}{2} \approx 1.57, \pi \approx 3.14, \frac{3\pi}{2} \approx 4.71, 2\pi \approx 6.28$$

for these key points.

	$x = 0$	$x = \frac{\pi}{2}$	$x = \pi$	$x = \frac{3\pi}{2}$	$x = 2\pi$
$y_1 = x$	0	1.57	3.14	4.71	6.28
$y_2 = \sin(x)$	0	1	0	-1	0
$y = y_1 + y_2$	0	2.57	3.14	3.71	6.28

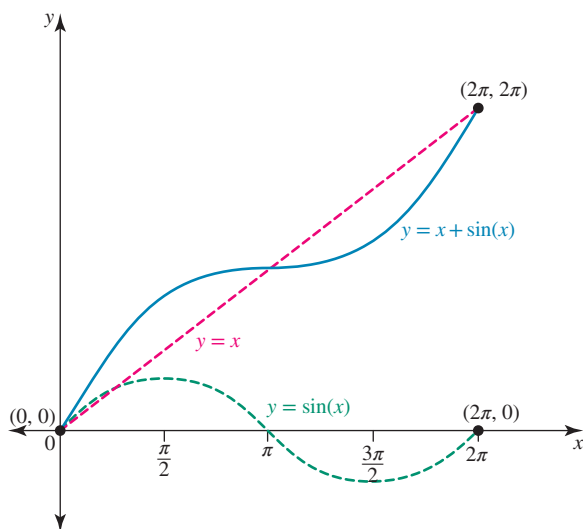

2.5 Exam questions

1 $f: R \rightarrow R, f(x) = 3 \sin\left(\frac{2x}{5}\right) - 2$

$$\text{Period } T = \frac{2\pi}{\frac{2}{5}} = 5\pi$$

$$\text{Range } [-3 - 2, 3 - 2] = [-5, 1]$$

The correct answer is **B**.

2 a $2 \cos(x) + 1 = 0$

$$2 \cos(x) = -1$$

$$\cos(x) = -\frac{1}{2}$$

$$x = \pi + \frac{\pi}{3}, \pi - \frac{\pi}{3}$$

$$x = \frac{2\pi}{3}, \frac{4\pi}{3}$$

Award 1 mark for finding one correct trigonometric value.

Award 1 mark for both correct answers.

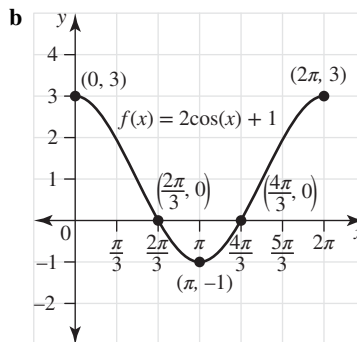

Award 1 mark for correct minimum and shape.

Award 1 mark for correct axial intercepts.

Award 1 mark for correct end points.

3 $f: R \rightarrow R, f(x) = 1 - 2 \cos\left(\frac{\pi x}{2}\right)$

$$T = \frac{2\pi}{\frac{\pi}{2}} = 4, \text{ range } [1 - 2, 1 + 2] = [-1, 3]$$

The correct answer is **B**.

2.6 The tangent function

2.6 Exercise

1 a $y = \tan(4x)$

$$\text{Period } \frac{\pi}{4}$$

$$\text{Asymptote when } 4x = \frac{\pi}{2} \Rightarrow x = \frac{\pi}{8}$$

b $y = 9 + 8 \tan\left(\frac{x}{7}\right)$

$$\text{Period } \pi \div \frac{1}{7} = 7\pi$$

$$\text{Asymptote when } \frac{x}{7} = \frac{\pi}{2} \Rightarrow x = \frac{7\pi}{2}$$

c $y = -\frac{3}{2} \tan\left(\frac{4x}{5}\right)$

$$\text{Period } \pi \div \frac{4}{5} = \frac{5\pi}{4}$$

$$\text{Asymptote when } \frac{4x}{5} = \frac{\pi}{2} \Rightarrow x = \frac{5\pi}{8}$$

d $y = 2 \tan(6\pi x + 3\pi)$

$$\text{Period } \frac{\pi}{6\pi} = \frac{1}{6}$$

$$\text{Asymptote when } 6\pi x + 3\pi = \frac{\pi}{2}$$

$$\therefore 6\pi x + 3\pi = \frac{\pi}{2} - 3\pi$$

$$\therefore 6\pi x = -\frac{5\pi}{2}$$

$$\therefore x = -\frac{5}{12}$$

For the first positive asymptote, add multiples of the period $\frac{1}{6}$.

$$-\frac{5}{12} + 3 \times \frac{1}{6} = \frac{1}{12}$$

The first positive asymptote is $x = \frac{1}{12}$.

2 $y = 3 \tan\left(\frac{x}{2}\right)$ for $x \in [-\pi, \pi]$

Period $\pi \div \frac{1}{2} = 2\pi$

First positive asymptote: $\frac{x}{2} = \frac{\pi}{2} \Rightarrow x = \pi$

For $x \in [-\pi, \pi]$, there is only one other asymptote at $x = \pi - 2\pi = -\pi$.

x -intercept midway between the two asymptotes is $x = 0$.

To illustrate the dilation effect, let $x = \frac{\pi}{3}$, then

$$y = 3 \tan\left(\frac{\pi}{6}\right) = \frac{3\sqrt{3}}{3} = \sqrt{3}.$$

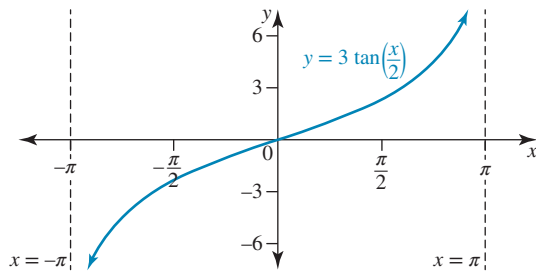

3 $y = -\tan(2x - \pi)$ for $x \in [-\pi, \pi]$.

$$y = -\tan\left(2\left(x - \frac{\pi}{2}\right)\right)$$

Period $\frac{\pi}{2}$

Horizontal shift $\frac{\pi}{2}$ units to the right and the graph is inverted.

An asymptote occurs when $2x - \pi = \frac{\pi}{2}$.

$$\therefore 2x = \frac{3\pi}{2}$$

$$\therefore x = \frac{3\pi}{4}$$

Other asymptotes at $x = \frac{3\pi}{4} - \frac{\pi}{2} = \frac{\pi}{4}$ and $x = \frac{\pi}{4} - \frac{\pi}{2} = -\frac{\pi}{4}$

and $x = -\frac{\pi}{4} - \frac{\pi}{2} = -\frac{3\pi}{4}$.

The asymptotes are $x = -\frac{3\pi}{4}$, $x = -\frac{\pi}{4}$, $x = \frac{\pi}{4}$, $x = \frac{3\pi}{4}$.

x -intercepts lie midway between the asymptotes as the mean position is $y = 0$.

They are at $x = -\frac{\pi}{2}$, $x = 0$, $x = \frac{\pi}{2}$ and at the end points $x = -\pi$, $x = \pi$.

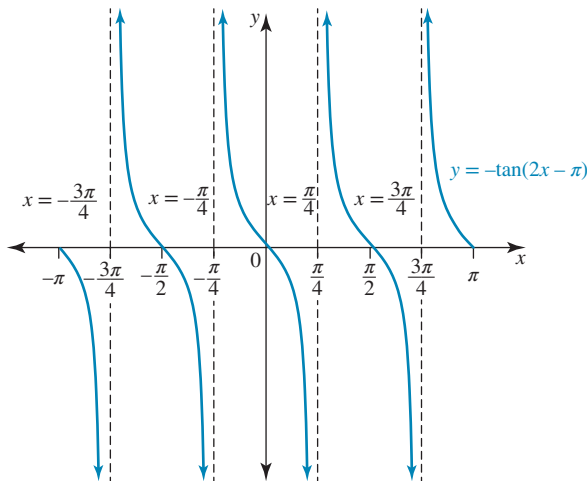

4 a $y = -\tan(2x)$, $x \in [0, \pi]$

Period $\frac{\pi}{2}$, graph is inverted.

Asymptotes when $2x = \frac{\pi}{2} \Rightarrow x = \frac{\pi}{4}$ and $x = \frac{\pi}{4} + \frac{\pi}{2} = \frac{3\pi}{4}$

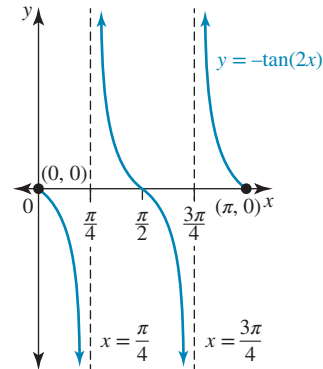

b $y = 3 \tan\left(x + \frac{\pi}{4}\right)$, $x \in [0, 2\pi]$

Period π , horizontal shift $\frac{\pi}{4}$ to the left. The asymptote

$y = \frac{\pi}{2}$ on $y = 3 \tan(x)$ is moved by this translation to

$x = \frac{\pi}{4}$. There must also be one other asymptote at

$$x = \frac{\pi}{4} + \pi \Rightarrow x = \frac{5\pi}{4}.$$

x -intercept midway between the pair of asymptotes is

$$x = \frac{3\pi}{4}. \text{ One other } x\text{-intercept is a period apart at } x = \frac{7\pi}{4}.$$

Others are outside the given domain.

End points: let $x = 0$ so $y = 3 \tan\left(\frac{\pi}{4}\right) = 3$.

Let $x = 2\pi$.

$$y = 3 \tan\left(2\pi + \frac{\pi}{4}\right)$$

$$= 3 \tan\left(\frac{\pi}{4}\right)$$

$$= 3$$

End points are $(0, 3)$ and $(2\pi, 3)$.

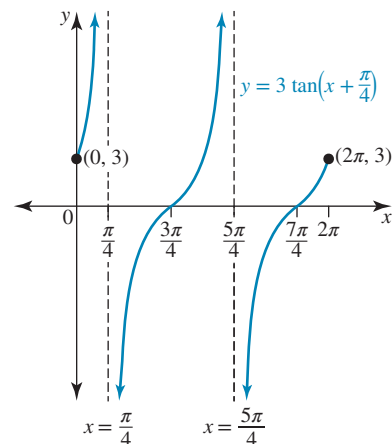

c $y = \tan\left(\frac{x}{3}\right) + \sqrt{3}$, $x \in [0, 6\pi]$

The period is 3π .

An asymptote occurs at $\frac{x}{3} = \frac{\pi}{2} \Rightarrow x = \frac{3\pi}{2}$. As the period is

3π , there is another asymptote at $x = \frac{3\pi}{2} + 3\pi = \frac{9\pi}{2}$.

The asymptotes are $x = \frac{3\pi}{2}, x = \frac{9\pi}{2}$.

The mean position is $y = \sqrt{3}$.

x -intercepts: let $y = 0$.

$$\therefore \tan\left(\frac{x}{3}\right) + \sqrt{3} = 0, x \in [0, 6\pi]$$

$$\therefore \tan\left(\frac{x}{3}\right) = -\sqrt{3}, \frac{x}{3} \in [0, 2\pi]$$

$$\therefore \frac{x}{3} = \pi - \frac{\pi}{3}, 2\pi - \frac{\pi}{3}$$

$$\therefore \frac{x}{3} = \frac{2\pi}{3}, \frac{5\pi}{3}$$

$$\therefore x = 2\pi, 5\pi$$

End points: let $x = 0$.

$$y = \tan(0) + \sqrt{3}$$

$$= \sqrt{3}$$

Let $x = 6\pi$.

$$y = \tan(2\pi) + \sqrt{3}$$

$$= \sqrt{3}$$

The end points are $(0, \sqrt{3})$ and $(6\pi, \sqrt{3})$.

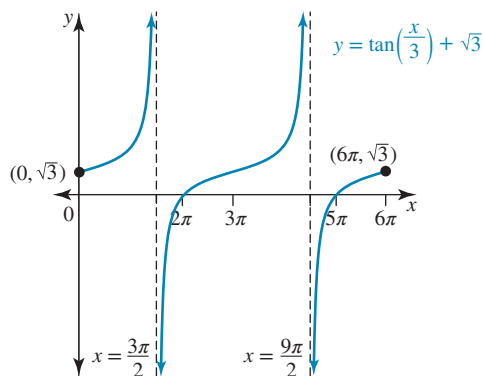

$$d \quad y = 5\sqrt{3} \tan\left(\pi x - \frac{\pi}{2}\right) - 5, x \in (-2, 3)$$

$$\therefore y = 5\sqrt{3} \tan\left(\pi\left(x - \frac{1}{2}\right)\right) - 5$$

Period $\frac{\pi}{\pi} = 1$, horizontal shift $\frac{1}{2}$ to the right, mean position $y = -5$.

An asymptote when

$$\pi x - \frac{\pi}{2} = \frac{\pi}{2}$$

$$\therefore \pi x = \pi$$

$$\therefore x = 1$$

Others are spaced 1 unit apart.

The asymptotes are $x = -2, x = -1, x = 0,$

$x = 1, x = 2, x = 3$

x -intercepts: let $y = 0$.

$$\therefore 5\sqrt{3} \tan\left(\pi x - \frac{\pi}{2}\right) - 5 = 0, x \in (-2, 3)$$

$$\therefore \tan\left(\pi x - \frac{\pi}{2}\right) = \frac{5}{5\sqrt{3}}$$

$$\therefore \tan\left(\pi x - \frac{\pi}{2}\right) = \frac{1}{\sqrt{3}}, \pi x - \frac{\pi}{2} \in \left(-\frac{5\pi}{2}, \frac{5\pi}{2}\right)$$

$$\therefore \pi x - \frac{\pi}{2} = \frac{\pi}{6}, \frac{7\pi}{6}, \frac{13\pi}{6} \text{ or } -\frac{5\pi}{6}, -\frac{11\pi}{6}$$

$$\therefore \pi x = \frac{2\pi}{3}, \frac{5\pi}{3}, \frac{8\pi}{3} \text{ or } -\frac{\pi}{3}, -\frac{4\pi}{3}$$

$$\therefore x = \frac{2}{3}, \frac{5}{3}, \frac{8}{3}, -\frac{1}{3}, -\frac{4}{3}$$

No end points as these are asymptotes.

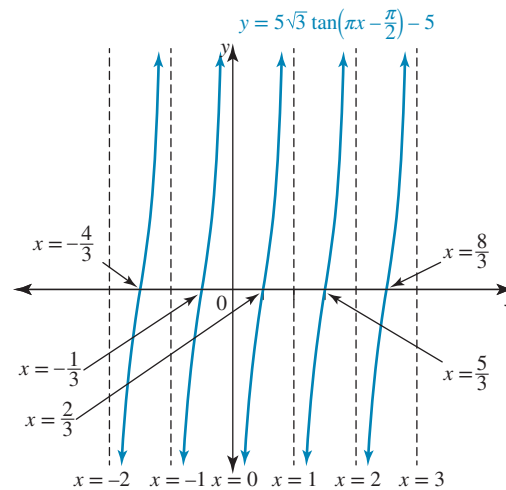

$$5 \quad y = 3 \tan(2\pi x) - \sqrt{3} \text{ for } -\frac{7}{8} \leq x \leq \frac{7}{8}$$

$$\text{Period } \frac{\pi}{2\pi} = \frac{1}{2}$$

Mean position $x = -\sqrt{3}$

An asymptote occurs at $2\pi x = \frac{\pi}{2} \Rightarrow x = \frac{1}{4}$.

Other asymptotes occur at $x = \frac{1}{4} + \frac{1}{2} = \frac{3}{4}$,

at $x = \frac{1}{4} - \frac{1}{2} = -\frac{1}{4}$, and at $x = -\frac{1}{4} - \frac{1}{2} = -\frac{3}{4}$.

The asymptotes are $x = -\frac{3}{4}, x = -\frac{1}{4}, x = \frac{1}{4}, x = \frac{3}{4}$.

x -intercepts: let $y = 0$.

$$3 \tan(2\pi x) - \sqrt{3} = 0$$

$$\therefore \tan(2\pi x) = \frac{\sqrt{3}}{3}, -\frac{7\pi}{4} \leq 2\pi x \leq \frac{7\pi}{4}$$

$$\therefore 2\pi x = \frac{\pi}{6}, \pi + \frac{\pi}{6} \text{ or } -\pi + \frac{\pi}{6}$$

$$\therefore 2\pi x = \frac{\pi}{6}, \frac{7\pi}{6} \text{ or } -\frac{5\pi}{6}$$

$$\therefore x = \frac{1}{12}, \frac{7}{12}, -\frac{5}{12}$$

End points: let $x = -\frac{7}{8}$.

$$y = 3 \tan\left(-\frac{7\pi}{4}\right)$$

$$= 3$$

Let $x = \frac{7}{8}$,

$$y = 3 \tan\left(\frac{7\pi}{4}\right)$$

$$= -3$$

The end points are $\left(-\frac{7}{8}, 3\right)$ and $\left(\frac{7}{8}, -3\right)$.

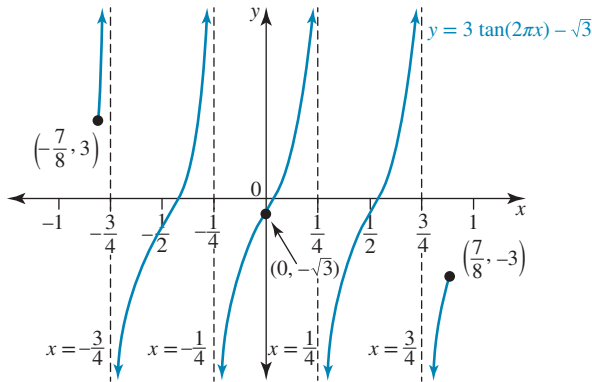

6 $y = 1 - \tan\left(x + \frac{\pi}{6}\right)$ for $0 \leq x \leq 2\pi$.

Period π , horizontal translation $\frac{\pi}{6}$ units to the left, graph is inverted.

Mean position $y = 1$

An asymptote when $x + \frac{\pi}{6} = \frac{\pi}{2} \Rightarrow x = \frac{\pi}{3}$

Other asymptotes are at $x = \frac{\pi}{3} + \pi = \frac{4\pi}{3}$ and

$x = \frac{\pi}{3} - \pi = -\frac{2\pi}{3}$, but the second one is not in the domain given.

The asymptotes are $x = \frac{\pi}{3}$, $x = \frac{4\pi}{3}$.

x -intercepts: let $y = 0$.

$$1 - \tan\left(x + \frac{\pi}{6}\right) = 0, 0 \leq x \leq 2\pi$$

$$\therefore \tan\left(x + \frac{\pi}{6}\right) = 1, \frac{\pi}{6} \leq x \leq 2\pi + \frac{\pi}{6}$$

$$\therefore x + \frac{\pi}{6} = \frac{\pi}{4}, \pi + \frac{\pi}{4}$$

$$\therefore x + \frac{\pi}{6} = \frac{\pi}{4}, \frac{5\pi}{4}$$

$$\therefore x = \frac{\pi}{12}, \frac{13\pi}{12}$$

End points: let $x = 0$.

$$y = 1 - \tan\left(\frac{\pi}{6}\right)$$

$$= 1 - \frac{\sqrt{3}}{3}$$

Let $x = 2\pi$.

$$y = 1 - \tan\left(2\pi + \frac{\pi}{6}\right)$$

$$= 1 - \tan\left(\frac{\pi}{6}\right)$$

$$= 1 - \frac{\sqrt{3}}{3}$$

End points are $\left(0, 1 - \frac{\sqrt{3}}{3}\right)$ and $\left(2\pi, 1 - \frac{\sqrt{3}}{3}\right)$.

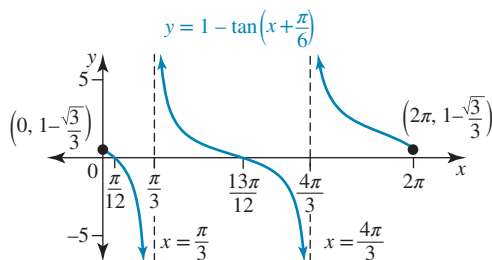

7 $y = a \tan(nx)$

The distance between the asymptotes at $x = \pm \frac{\pi}{3}$ is $\frac{2\pi}{3}$, so this is the period.

$$\therefore \frac{\pi}{n} = \frac{2\pi}{3}$$

$$\therefore 3 = 2n$$

$$\therefore n = \frac{3}{2}$$

The equation becomes $y = a \tan\left(\frac{3x}{2}\right)$.

Substitute the point $\left(-\frac{\pi}{6}, -\frac{1}{2}\right)$.

$$\therefore -\frac{1}{2} = a \tan\left(\frac{3}{2} \times \frac{-\pi}{6}\right)$$

$$\therefore -\frac{1}{2} = a \tan\left(-\frac{\pi}{4}\right)$$

$$\therefore -\frac{1}{2} = a \times -1$$

$$\therefore a = \frac{1}{2}$$

The equation is $y = \frac{1}{2} \tan\left(\frac{3x}{2}\right)$.

8 a As the x -intercepts lie midway between successive pairs of asymptotes, the mean position is $y = 0$. Hence, there has been no horizontal translation applied.

b The period is the distance between successive pairs of asymptotes. Using the asymptotes $x = -\frac{\pi}{4}$ and $x = \frac{\pi}{4}$ shows the period is $\frac{\pi}{2}$.

c Since only a 'possible' equation is required, let the equation be $y = a \tan(nx)$.

$$\frac{\pi}{n} = \frac{\pi}{2} \Rightarrow n = 2$$

The equation becomes $y = a \tan(2x)$.

Substitute the point $\left(\frac{\pi}{3}, \sqrt{3}\right)$.

$$\therefore \sqrt{3} = a \tan\left(\frac{2\pi}{3}\right)$$

$$\therefore \sqrt{3} = a \times -\sqrt{3}$$

$$\therefore a = -1$$

A possible equation could be $y = -\tan(2x)$.

To find another possible equation, let $y = a \tan(2(x - h))$.

The graph passes through the origin.

$$\therefore 0 = a \tan(-2h)$$

$$\therefore \tan(-2h) = 0$$

$$\therefore -\tan(2h) = 0$$

$$\therefore 2h = k\pi, k \in \mathbb{Z}$$

$$\therefore h = k\left(\frac{\pi}{2}\right), k \in \mathbb{Z}$$

Choosing $k = -2$, for example, the equation becomes $y = a \tan(2x + 2\pi)$.

Substitute the point $\left(\frac{\pi}{3}, \sqrt{3}\right)$.

$$\sqrt{3} = a \tan\left(\frac{2\pi}{3} + 2\pi\right)$$

$$\therefore \sqrt{3} = a \times -\sqrt{3}$$

$$\therefore a = -1$$

So the equation could be expressed as $y = -\tan(2x + 2\pi)$.

- 9 a The 13 points of intersections of the graphs of $y = \sin(2x)$ and $y = \tan(x)$ for $-2\pi \leq x \leq 2\pi$ are

$$(\pm 2\pi, 0), (\pm \pi, 0), (0, 0),$$

$$\left(-\frac{5\pi}{4}, -1\right), \left(-\frac{\pi}{4}, -1\right), \left(\frac{3\pi}{4}, -1\right), \left(\frac{7\pi}{4}, -1\right),$$

$$\left(-\frac{7\pi}{4}, 1\right), \left(-\frac{3\pi}{4}, 1\right), \left(\frac{\pi}{4}, 1\right), \left(\frac{5\pi}{4}, 1\right)$$

- b The solutions to $\sin(2x) = \tan(x)$ are the x -coordinates of the points of intersection of the graphs of $y = \sin(2x)$ and $y = \tan(x)$. These are integer multiples of π or odd integer multiples of $\frac{\pi}{4}$.

The general solution of the equation for $x \in R$ is

$$x = n\pi, n \in Z \text{ or } x = (2n + 1)\frac{\pi}{4}, n \in Z.$$

$$10 \text{ a } f(x) = \begin{cases} -\sin(x), & -2\pi \leq x \leq -\frac{\pi}{2} \\ \tan(x), & -\frac{\pi}{2} < x < \frac{\pi}{2} \\ \cos(x), & \frac{\pi}{2} \leq x \leq 2\pi \end{cases}$$

i $f\left(\frac{\pi}{3}\right) = \tan\left(\frac{\pi}{3}\right) = \sqrt{3}$

ii $f(\pi) = \cos(\pi) = -1$

iii $f\left(-\frac{\pi}{2}\right) = -\sin\left(-\frac{\pi}{2}\right) = 1$

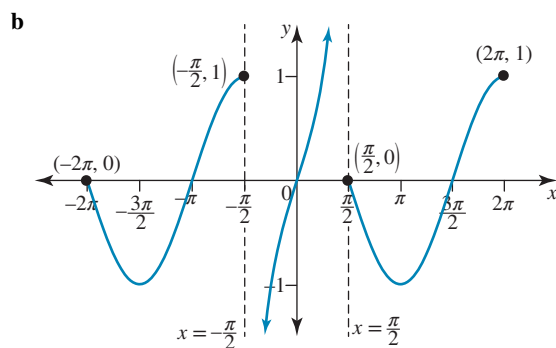

- c The function is not continuous at $x = \pm \frac{\pi}{2}$.
 d The domain is $[-2\pi, 2\pi]$ and the range is R .

2.6 Exam questions

1 Period = $\frac{\pi}{2} = 2$

The correct answer is **B**.

2 $y = \tan(ax + b)$

P $(1, \sqrt{3})$

$$\sqrt{3} = \tan(a + b)$$

$$a + b = \tan^{-1}(\sqrt{3}) = \frac{\pi}{3} \quad [1]$$

Q $(-1, -1)$

$$-1 = \tan(b - a)$$

$$b - a = \tan^{-1}(-1) = -\frac{\pi}{4} \quad [2]$$

[1] + [2]:

$$2b = \frac{\pi}{3} - \frac{\pi}{4} = \frac{\pi}{12}$$

$$b = \frac{\pi}{24}, a = \frac{\pi}{3} - \frac{\pi}{24} = \frac{7\pi}{24}$$

Award 1 mark for two correct equations.

Award 1 mark for the correct value of a .

Award 1 mark for the correct value of b .

3 $y = \tan(ax)$

The period of $y = \tan(ax)$ is $\frac{\pi}{a}$.

x -intercepts occur at multiples of the period, $\frac{n\pi}{a}, n \in Z$.

When $a = \frac{1}{2}$ the period is 2π , meaning that the x -intercepts

occur at $0, 2\pi, 4\pi$.

$$\therefore a = \frac{1}{2}$$

The correct answer is **C**.

2.7 Modelling and applications

2.7 Exercise

1 a Period is $2\pi \div \frac{\pi}{12} = 24$ hours.

b Mean position is $d = 12.5$ and amplitude is 1.5 .

Maximum height is $12.5 + 1.5 = 14$ metres

Minimum height is $12.5 - 1.5 = 11$ metres

c $d = 1.5 \sin\left(\frac{\pi t}{12}\right) + 12.5$

When $t = 0, d = 1.5 \sin(0) + 12.5 = 12.5$

The boat is 12.5 metres above the seabed.

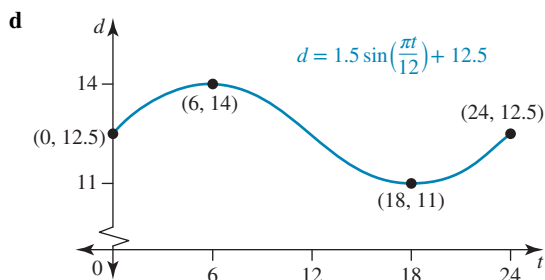

e Maximum height occurs when $t = 6$, so between $t = 4$ and $t = 8$ the depth exceeds a value of $d = h$ for a continuous interval of 4 hours.

$$\therefore h = 1.5 \sin\left(\frac{\pi}{12} \times 4\right) + 12.5$$

$$\therefore h = 1.5 \sin\left(\frac{\pi}{3}\right) + 12.5$$

$$\therefore h = 1.5 \times \frac{\sqrt{3}}{2} + 12.5$$

$$\therefore h = \frac{3\sqrt{3} + 50}{4} \approx 13.8 \text{ m}$$

f The first minimum after 12 hours (half a cycle) have passed occurs when $t = 18$. It will be safe to return to shore 18 hours after 9:30 am. This makes the time 3:30 am the following day.

2 a $h = a \cos(n(t - 0.5)) + c$

$$\text{Amplitude} = \frac{100 - 0}{2}$$

$$= 50$$

$$\text{Mean position} = \frac{100 + 0}{2}$$

$$= 50$$

$$\therefore c = 50$$

$$\text{Period} = 1$$

$$\frac{2\pi}{n} = 1$$

$$n = 2\pi$$

$$\therefore h = 50 \cos(2\pi(t - 0.5)) + 50$$

$$\mathbf{b} \quad 40 = 50 \cos(2\pi(t - 0.5)) + 50$$

$$t = 0.3 \text{ seconds}$$

$$\mathbf{3} \quad \mathbf{a} \quad h = 5 - 3.5 \cos\left(\frac{\pi t}{30}\right)$$

$$\text{When } t = 0, h = 5 - 3.5 \cos(0) = 5 - 3.5 = 1.5 \text{ m}$$

$$\mathbf{b} \quad h_{\max} = 5 - 3.5(-1) = 8.5 \text{ m}$$

$$\mathbf{c} \quad \text{Period} = \frac{2\pi}{\frac{\pi}{30}} = 60 \text{ s}$$

Therefore, 1 rotation takes 60 seconds.

$$\mathbf{d} \quad \text{Solve } 5 - 3.5 \cos\left(\frac{\pi t}{30}\right) = 7 \text{ for } 0 \leq t \leq 60.$$

$$t = 20.808, 39.192$$

$$\text{Time spent above } 7 \text{ m} = 39.192 - 20.808 = 18.4 \text{ seconds}$$

$$\mathbf{4} \quad \mathbf{a} \quad h(t) = a \sin(nt) + k$$

The range of the function is between 0.7 and 1.7 metres travelled in 2 seconds.

Midway between these values is 1.2, so $k = 1.2$ and the amplitude is 0.5. As the girl rises from mean position, $a = 0.5$.

It takes half a period for the function to range between its greatest and least values, so the period is 4.

$$\frac{2\pi}{n} = 4$$

$$\therefore n = \frac{\pi}{2}$$

$$\text{Hence, } a = 0.5, n = \frac{\pi}{2}, k = 1.2.$$

$$\mathbf{b} \quad h(t) = 0.5 \sin\left(\frac{\pi}{2}t\right) + 1.2$$

For $0 \leq t \leq 6$, one and a half cycles will be covered.

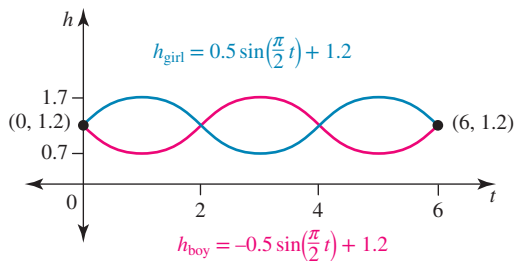

\mathbf{c} Let $h = 1.45$. From the graph there will be four intersections of the line $h = 1.45$ with the curve showing the girl's height.

$$0.5 \sin\left(\frac{\pi}{2}t\right) + 1.2 = 1.45$$

$$\therefore \sin\left(\frac{\pi}{2}t\right) = 0.5$$

$$\therefore \frac{\pi}{2}t = \frac{\pi}{6}, \frac{5\pi}{6}, \frac{13\pi}{6}, \frac{17\pi}{6}$$

$$\therefore t = \frac{1}{3}, \frac{5}{3}, \frac{13}{3}, \frac{17}{3}$$

The time interval between $\frac{1}{3}$ and $\frac{5}{3}$ is $\frac{4}{3}$, so over the first six seconds she is at 1.45 metres or higher for $\frac{8}{3}$ seconds.

\mathbf{d} The graph is shown in part \mathbf{b} ; its equation is

$$h_{\text{boy}} = -0.5 \sin\left(\frac{\pi}{2}t\right) + 1.2.$$

$$\mathbf{5} \quad h = 3 - 2.5 \sin\left(\frac{1}{2}(t - 1)\right)$$

\mathbf{a} At 7:30 am, $t = 0.5$, so $h = 3 - 2.5 \sin(-0.25) \approx 3.619$.

The water level is approximately 3.619 metres below the jetty.

\mathbf{b} Mean position is 3, amplitude is 2.5, so the distances below the jetty lie between $3 - 2.5 = 0.5$ and $3 + 2.5 = 5.5$.

The greatest distance below the jetty is 5.5 metres and the least distance is 0.5 metres.

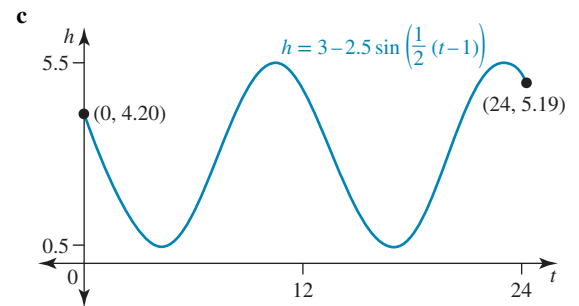

The first maximum occurs for $t \approx 10.42$ and the first minimum for $t \approx 4.14$. (Solve using CAS.)

\mathbf{d} The difference between low and high tide is 5 metres, so an additional 5 metres of rope is needed.

$$\mathbf{6} \quad \mathbf{a} \quad N(t) = 45 \sin\left(\frac{\pi t}{5}\right) - 35 \cos\left(\frac{\pi t}{3}\right) + 68 \quad 0 \leq t \leq 15$$

$$N(0) = 45 \sin\left(\frac{\pi(0)}{5}\right) - 35 \cos\left(\frac{\pi(0)}{3}\right) + 68$$

$$N(0) = 33$$

\mathbf{b} Sketch the graph on CAS and find the minimum.

The coordinates are (6.4643, 1.2529).

The quietest time is when $t = 6.4643$ or 6 hours and 28 minutes after 8 am, which is 2:28 pm.

\mathbf{c} When $t = 4$ (midday),

$$N(0) = 45 \sin\left(\frac{\pi(4)}{5}\right) - 35 \cos\left(\frac{\pi(4)}{3}\right) + 68$$

$$N(0) = 112$$

At midday there were 112 customers in line.

\mathbf{d} The maximum number of customers in the queue between 3 pm ($t = 7$) and 7 pm ($t = 11$) is 86.

2.7 Exam questions

$\mathbf{1}$ When $t = 0$, $h = 25$, and when $t = 30$, $h = 5$; amplitude is 10.

$$t = 60 = \frac{2\pi}{n}, n = \frac{\pi}{30}$$

$$h(t) = 15 + 10 \cos\left(\frac{\pi t}{30}\right)$$

The correct answer is **E**.

$$\mathbf{2} \quad T = 14 = \frac{2\pi}{n} \Rightarrow n = \frac{\pi}{7}$$

$$f(0) = 0, f(14) = 0$$

Range $[0, 10]$

This is only satisfied by $y = f(x) = 5 - 5 \cos\left(\frac{\pi t}{7}\right)$.

The correct answer is **B**.

$$3 \text{ a } h(t) = 14 + 8 \sin\left(\frac{\pi t}{12}\right), 0 \leq t \leq 24$$

$$h_{\min} = 14 - 8 \\ = 6 \text{ m}$$

$$b \text{ } h(t) = 14 + 8 \sin\left(\frac{\pi t}{12}\right) = 10$$

$$8 \sin\left(\frac{\pi t}{12}\right) = 10 - 14 = -4$$

$$\sin\left(\frac{\pi t}{12}\right) = -\frac{1}{2}$$

$$\frac{\pi t}{12} = \pi + \frac{\pi}{6}, 2\pi - \frac{\pi}{6}$$

$$= \frac{7\pi}{6}, \frac{11\pi}{6}$$

$$t = 14, 22$$

Award 1 mark for solving the trigonometric equation.

Award 1 mark for both correct values of t .

$$c \tan(\theta) = \frac{\sin(\theta)}{\cos(\theta)}$$

$$= \frac{\frac{1}{4}}{\frac{\sqrt{15}}{4}}$$

$$= \frac{1}{\sqrt{15}}$$

$$\tan(\pi + \theta) = \tan(\theta)$$

$$= \frac{1}{\sqrt{15}}$$

$$d \sin\left(\frac{\pi}{2} - \theta\right) = \cos(\theta)$$

$$= \frac{\sqrt{15}}{4}$$

$$3 \text{ a i } \sin^2(\alpha) + \cos^2(\alpha) = 1$$

$$\sin^2(\alpha) + \left(\frac{2}{3}\right)^2 = 1$$

$$\sin^2(\alpha) = 1 - \frac{4}{9}$$

$$\sin^2(\alpha) = \frac{5}{9}$$

$$\sin(\alpha) = \pm\sqrt{\frac{5}{9}}$$

$$\sin(\alpha) = \pm\frac{\sqrt{5}}{3}$$

However, since $\frac{3\pi}{2} \leq \alpha \leq 2\pi$ and \sin is negative in this quadrant,

$$\sin(\alpha) = -\frac{\sqrt{5}}{3}$$

$$ii \tan(\alpha) = \frac{\sin(\alpha)}{\cos(\alpha)}$$

$$= -\frac{\sqrt{5}}{3} \div \frac{2}{3}$$

$$= -\frac{\sqrt{5}}{3} \times \frac{3}{2}$$

$$= -\frac{\sqrt{5}}{2}$$

$$b \sin^2(\alpha) + \cos^2(\alpha) = \left(-\frac{\sqrt{5}}{3}\right)^2 + \left(\frac{2}{3}\right)^2$$

$$= \frac{5}{9} + \frac{4}{9}$$

$$= 1$$

$$\therefore \sin^2(\alpha) + \cos^2(\alpha) = 1$$

$$4 \text{ a } \cos(2x) = -1, -2\pi \leq x \leq 2\pi$$

Need to change the domain to be for that of the given variable:

$$\cos(2x) = -1, -4\pi \leq 2x \leq 4\pi$$

$$2x = -3\pi, -\pi, \pi, 3\pi$$

$$x = -\frac{3\pi}{2}, -\frac{\pi}{2}, \frac{\pi}{2}, \frac{3\pi}{2}$$

$$b \text{ } 4 \cos^2(\theta) - (2\sqrt{2} - 2) \cos(\theta) - \sqrt{2} = 0, 0 \leq \theta \leq 2\pi$$

$$(2 \cos(\theta) + 1)(2 \cos(\theta) - \sqrt{2}) = 0$$

2.8 Review

2.8 Exercise

Technology free: short answer

$$1 \text{ a } \sin\left(-\frac{2\pi}{3}\right) = -\sin\left(\frac{2\pi}{3}\right)$$

$$= -\sin\left(\frac{\pi}{3}\right)$$

$$= -\frac{\sqrt{3}}{2}$$

$$b \cos(7\pi) = \cos(\pi)$$

$$= -1$$

$$c \sin\left(\frac{11\pi}{6}\right) = -\sin\left(\frac{\pi}{6}\right)$$

$$= -\frac{1}{2}$$

$$d \tan\left(-\frac{\pi}{6}\right) = -\tan\left(\frac{\pi}{6}\right)$$

$$= -\frac{1}{\sqrt{3}}$$

$$2 \text{ a } \sin(-\theta) = -\sin(\theta)$$

$$= -0.25$$

$$b \sin^2(\theta) + \cos^2(\theta) = 1$$

$$\left(\frac{1}{4}\right)^2 + \cos^2(\theta) = 1$$

$$\frac{1}{16} + \cos^2(\theta) = 1$$

$$\cos^2(\theta) = \frac{15}{16}$$

$$\cos(\theta) = \pm\frac{\sqrt{15}}{4}$$

$$\cos(\theta) = \frac{\sqrt{15}}{4} \text{ } (\theta \text{ is in 1st quadrant})$$

$$\cos(3\pi + \theta) = \cos(\pi + \theta)$$

$$= -\cos(\theta)$$

$$= -\frac{\sqrt{15}}{4}$$

$$\begin{aligned}
 2 \cos(\theta) + 1 &= 0 & \text{or} & & 2 \cos(\theta) - \sqrt{2} &= 0 \\
 2 \cos(\theta) &= -1 & & & 2 \cos(\theta) &= \sqrt{2} \\
 \cos(\theta) &= -\frac{1}{2} & & & \cos(\theta) &= \frac{\sqrt{2}}{2} \\
 \theta &= \frac{2\pi}{3}, \frac{4\pi}{3} & & & \theta &= \frac{\pi}{4}, \frac{7\pi}{4} \\
 \therefore \theta &= \frac{\pi}{4}, \theta = \frac{2\pi}{3}, \theta = \frac{4\pi}{3}, \theta = \frac{7\pi}{4}
 \end{aligned}$$

c $\sqrt{3} \sin(2x) = -\cos(2x)$, $-\pi \leq x \leq \pi$
 Need to change the domain to be for that of the given variable:

$$\sqrt{3} \sin(2x) = -\cos(2x), -2\pi \leq 2x \leq 2\pi$$

$$\frac{\sin(2x)}{\cos(2x)} = -\frac{1}{\sqrt{3}}$$

$$\tan(2x) = -\frac{1}{\sqrt{3}}$$

The basic angle is $\frac{\pi}{6}$, tan is negative in 2nd and 4th quadrants.

$$2x = -\frac{7\pi}{6}, -\frac{\pi}{6}, \frac{5\pi}{6}, \frac{11\pi}{6}$$

$$x = -\frac{7\pi}{12}, -\frac{\pi}{12}, \frac{5\pi}{12}, \frac{11\pi}{12}$$

d $\sqrt{3} \sin(\theta) - 2 \sin(\theta) \cos(\theta) = 0$, $0 \leq \theta \leq 2\pi$

$$\sin(\theta) (\sqrt{3} - 2 \cos(\theta)) = 0$$

$$\sin(\theta) = 0 \quad \text{or} \quad \sqrt{3} - 2 \cos(\theta) = 0$$

$$\theta = 0, \pi, 2\pi \quad -2 \cos(\theta) = -\sqrt{3}$$

$$\cos(\theta) = \frac{\sqrt{3}}{2}$$

$$\theta = \frac{\pi}{6}, \frac{11\pi}{6}$$

$$\therefore \theta = 0, \theta = \frac{\pi}{6}, \theta = \pi, \theta = \frac{11\pi}{6}, \theta = 2\pi$$

e Need to change the domain to be for that of the given variable:

$$2 \sin\left(2\left(\theta + \frac{\pi}{12}\right)\right) + 1 = 0, -\pi \leq \theta \leq \pi$$

$$-\pi + \frac{\pi}{12} \leq \theta + \frac{\pi}{12} \leq \pi + \frac{\pi}{12}$$

$$\frac{-11\pi}{12} \leq \theta + \frac{\pi}{12} \leq \frac{13\pi}{12}$$

$$2 \left(\frac{-11\pi}{12}\right) \leq 2\left(\theta + \frac{\pi}{12}\right) \leq 2 \left(\frac{13\pi}{12}\right)$$

$$\frac{-11\pi}{6} \leq 2\left(\theta + \frac{\pi}{12}\right) \leq \frac{13\pi}{6}$$

$$2 \sin\left(2\left(\theta + \frac{\pi}{12}\right)\right) + 1 = 0$$

$$2 \sin\left(2\left(\theta + \frac{\pi}{12}\right)\right) = -1$$

$$\sin\left(2\left(\theta + \frac{\pi}{12}\right)\right) = -\frac{1}{2}$$

$$\theta + \frac{\pi}{12} = -\frac{5\pi}{12}, -\frac{\pi}{12}, \frac{7\pi}{12}, \frac{11\pi}{12}$$

$$\theta = -\frac{5\pi}{12} - \frac{\pi}{12}, -\frac{\pi}{12} - \frac{\pi}{12}, \frac{7\pi}{12} - \frac{\pi}{12}, \frac{11\pi}{12} - \frac{\pi}{12}$$

$$-\frac{\pi}{12}, \frac{11\pi}{12}, -\frac{\pi}{12}$$

$$\theta = -\frac{6\pi}{12}, -\frac{2\pi}{12}, \frac{6\pi}{12}, \frac{10\pi}{12}$$

$$\theta = -\frac{\pi}{2}, -\frac{\pi}{6}, \frac{\pi}{2}, \frac{5\pi}{6}$$

f $2 \cos\left(x + \frac{\pi}{6}\right) = \sqrt{2}$, over R

$$\cos\left(x + \frac{\pi}{6}\right) = \frac{\sqrt{2}}{2}$$

Therefore, the base is $\cos^{-1}\left(\frac{\sqrt{2}}{2}\right) = \frac{\pi}{4}$.

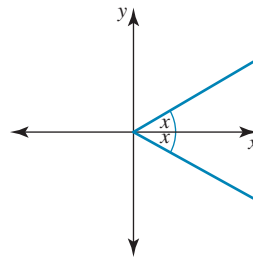

$$x + \frac{\pi}{6} = 2n\pi + \frac{\pi}{4}, 2n\pi - \frac{\pi}{4}$$

$$x = 2n\pi + \frac{\pi}{4} - \frac{\pi}{6}, 2n\pi - \frac{\pi}{4} - \frac{\pi}{6}$$

$$x = 2n\pi + \frac{3\pi}{12} - \frac{2\pi}{12}, 2n\pi - \frac{3\pi}{12} - \frac{2\pi}{12}$$

$$x = 2n\pi + \frac{\pi}{12}, 2n\pi - \frac{5\pi}{12} \text{ where } n \in Z$$

5 a $y = 3 \sin(2 - 5x) + 6$

$$\text{Period} = \frac{2\pi}{5}, \text{amplitude} = 3$$

b $y = 2 - 3 \tan(3x)$

$$\text{Period} = \frac{\pi}{3}$$

The first positive asymptote occurs when

$$3x = \frac{\pi}{2} \Rightarrow x = \frac{\pi}{6}$$

6 a $f: [-\pi, \pi] \rightarrow R, f(x) = 2 \sin(2x) + 1$

$$\text{Amplitude} = 2, \text{period} = \frac{2\pi}{2} = \pi$$

$$y\text{-intercept} = (1, 0)$$

$$\text{Maximum value} = 3, \text{minimum value} = -1$$

$$x\text{-intercepts, } y = 0:$$

$$0 = 2 \sin(2x) + 1 \quad -\pi \leq x \leq \pi$$

$$-\frac{1}{2} = \sin(2x) \quad -2\pi \leq 2x \leq 2\pi$$

Basic angle = $\frac{\pi}{6}$, sine is negative in 3rd and 4th quadrants.

$$2x = \pi + \frac{\pi}{6}, 2\pi - \frac{\pi}{6}, -\frac{\pi}{6}, -\pi + \frac{\pi}{6}$$

$$2x = \frac{7\pi}{6}, \frac{11\pi}{6}, -\frac{\pi}{6}, -\frac{5\pi}{6}$$

$$x = \frac{7\pi}{12}, \frac{11\pi}{12}, -\frac{\pi}{12}, -\frac{5\pi}{12}$$

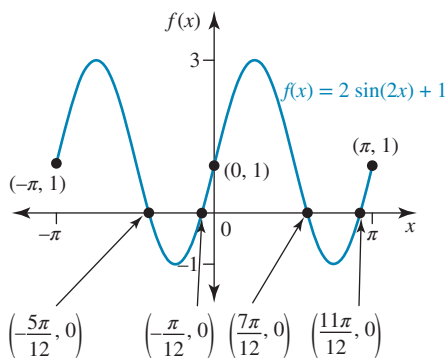

b $f: [0, 4\pi] \rightarrow \mathbb{R}, f(x) = 5 + 5 \cos\left(\frac{x}{2} - \frac{\pi}{4}\right)$

$$f(x) = 5 + 5 \cos\left(\frac{1}{2}\left(x - \frac{\pi}{2}\right)\right)$$

Period $2\pi \div \frac{1}{2} = 4\pi$, amplitude 5, mean position $y = 5$,

range $[0, 10]$, horizontal translation $\frac{\pi}{2}$ to right

End points:

$$f(0) = 5 + 5 \cos\left(-\frac{\pi}{4}\right)$$

$$= 5 + \frac{5\sqrt{2}}{2}$$

Since the end points are a period apart, $f(4\pi) = 5 + \frac{5\sqrt{2}}{2}$.

The end points are $\left(0, 5 + \frac{5\sqrt{2}}{2}\right)$ and $\left(4\pi, 5 + \frac{5\sqrt{2}}{2}\right)$.

x -intercepts: let $y = 0$.

$$5 + 5 \cos\left(\frac{x}{2} - \frac{\pi}{4}\right) = 0$$

$$\therefore \cos\left(\frac{x}{2} - \frac{\pi}{4}\right) = -1, \left(\frac{x}{2} - \frac{\pi}{4}\right) \in \left(-\frac{\pi}{4}, \frac{7\pi}{4}\right)$$

$$\therefore \frac{x}{2} - \frac{\pi}{4} = \pi$$

$$\therefore \frac{x}{2} = \frac{5\pi}{4}$$

$$\therefore x = \frac{5\pi}{2}$$

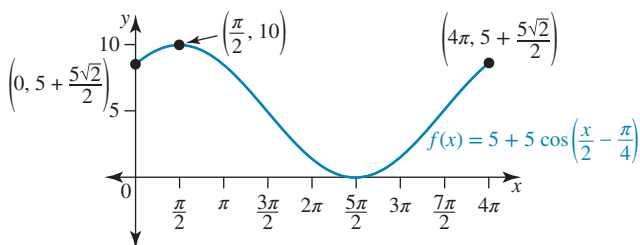

Technology active: multiple choice

7 $\cos(3\pi - \theta) = \cos(\pi - \theta)$
 $= -\cos(\theta)$
 $= -0.362$

The correct answer is **E**.

8 $\cos\left(-\frac{7\pi}{3}\right) = \cos\left(\frac{7\pi}{3}\right)$
 $= \cos\left(\frac{\pi}{3}\right)$
 $= \frac{1}{2}$

The correct answer is **A**.

9 $\cos\left(\frac{13\pi}{4}\right) - 2 \sin\left(\frac{5\pi}{6}\right) + \sqrt{3} \tan\left(\frac{4\pi}{3}\right)$
 $= \cos\left(\frac{5\pi}{4}\right) - 2 \sin\left(\frac{5\pi}{6}\right) + \sqrt{3} \tan\left(\frac{4\pi}{3}\right)$
 $= -\frac{1}{\sqrt{2}} - 2 \times \frac{1}{2} + \sqrt{3} \times \sqrt{3}$
 $= -\frac{1}{\sqrt{2}} - 1 + 3$
 $= 2 - \frac{1}{\sqrt{2}}$

The correct answer is **B**.

10 $\frac{2 \sin(\pi - \theta) \sin\left(\frac{\pi}{2} - \theta\right)}{2 - 2\cos^2(\theta)}$
 $= \frac{2 \sin(\theta) \cos(\theta)}{2(1 - \cos^2(\theta))}$
 $= \frac{\sin(\theta) \cos(\theta)}{\sin^2(\theta)}$
 $= \frac{\cos(\theta)}{\sin(\theta)}$
 $= \frac{1}{\tan(\theta)}$

The correct answer is **C**.

11 $\sin\left(\frac{3\pi}{2} - \theta\right) = -\cos(\theta)$
 $= -0.6402$

The correct answer is **B**.

12 Need to change the domain to be for that of the given variable

$$2 \cos\left(\theta - \frac{\pi}{2}\right) - 1 = 0, \quad 0 - \frac{\pi}{2} \leq \theta - \frac{\pi}{2} \leq 2\pi - \frac{\pi}{2}$$

$$-\frac{\pi}{2} \leq \theta - \frac{\pi}{2} \leq \frac{3\pi}{2}$$

$$2 \cos\left(\theta - \frac{\pi}{2}\right) - 1 = 0 \quad \text{or} \quad \theta - \frac{\pi}{2} = \frac{\pi}{3}$$

$$2 \cos\left(\theta - \frac{\pi}{2}\right) = 1 \quad \theta = \frac{\pi}{3} + \frac{\pi}{2}$$

$$\cos\left(\theta - \frac{\pi}{2}\right) = \frac{1}{2} \quad \theta = \frac{2\pi}{6} + \frac{3\pi}{6}$$

$$\theta - \frac{\pi}{2} = \frac{-\pi}{3} \quad \theta = \frac{5\pi}{6}$$

$$\theta = \frac{-\pi}{3} + \frac{\pi}{2}$$

$$\theta = \frac{-2\pi}{6} + \frac{3\pi}{6}$$

$$\theta = \frac{\pi}{6}$$

The correct answer is **A**.

$$\begin{aligned}
 13 \quad 2 \sin(x) - \sqrt{3} &= 0 \\
 2 \sin(x) &= \sqrt{3} \\
 \sin(x) &= \frac{\sqrt{3}}{2}
 \end{aligned}$$

Therefore, the base is $\sin^{-1}\left(\frac{\sqrt{3}}{2}\right) = \frac{\pi}{3}$.

Sine is positive in quadrants 1 and 2.

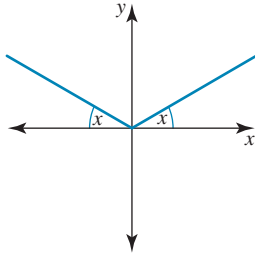

$$\begin{aligned}
 x &= 2n\pi + \frac{\pi}{3}, (2n+1)\pi - \frac{\pi}{3} \text{ where } n \in \mathbb{Z} \\
 &= \frac{6n\pi + \pi}{3}, \frac{3(2n+1)\pi - \pi}{3} \\
 &= \frac{6n\pi + \pi}{3}, \frac{6n\pi + 2\pi}{3}, n \in \mathbb{Z}
 \end{aligned}$$

The correct answer is **C**.

- 14 The asymptotes are π units apart, so the period is π . Eliminate options C and E.

The shape is not inverted, so eliminate A.

There is a horizontal shift $\frac{\pi}{2}$ to the right.

The correct answer is **D**.

15 $y = 2 \tan\left(\frac{\pi x}{4}\right) - 1$

First asymptote:

$$\begin{aligned}
 x &= \frac{\pi}{2n} \\
 &= \frac{\pi}{2 \times \frac{\pi}{4}} \\
 &= \frac{\pi}{\frac{\pi}{2}} \\
 &= 2
 \end{aligned}$$

The correct answer is **E**.

- 16 Amplitude is 8, mean position is $y = 3$, so the range is $[3 - 8, 3 + 8] = [-5, 11]$.

The correct answer is **D**.

Technology active: extended response

- 17 a Maximum temperature when

$$\cos\left(\frac{\pi t}{12}\right) = -1$$

Therefore, the maximum temperature is

$$\begin{aligned}
 T &= 2 - 6 \cos\left(\frac{\pi t}{12}\right) \\
 &= 2 - 6 \times -1 \\
 &= 2 + 6 \\
 &= 8^\circ\text{C}
 \end{aligned}$$

Minimum temperature when

$$\cos\left(\frac{\pi t}{12}\right) = 1$$

Therefore, the minimum temperature is

$$\begin{aligned}
 T &= 2 - 6 \cos\left(\frac{\pi t}{12}\right) \\
 &= 2 - 6 \times 1 \\
 &= 2 - 6 \\
 &= -4^\circ\text{C}
 \end{aligned}$$

- b Solve $2 - 6 \cos\left(\frac{\pi t}{12}\right) = 0$ on a calculator over the domain $0 \leq t \leq 24$.

$$\therefore t = 4.7019, t = 19.2981 \text{ hours}$$

4 hours and $0.7019 \times 60 = 42.12$ minutes after 4:00 am is 8:42 am.

19 hours and $0.2981 \times 60 = 17.88$ minutes after 4:00 am is 11:18 pm.

- c Maximum temperature when

$$\cos\left(\frac{\pi t}{12}\right) = -1$$

$$\frac{\pi t}{12} = \pi$$

$$t = \pi \times \frac{12}{\pi}$$

$$t = 12 \text{ hours}$$

12 hours after 4:00 am is 4:00 pm.

- d At 8:00 am, $t = 4$.

$$T = 2 - 6 \cos\left(\frac{\pi t}{12}\right)$$

$$= 2 - 6 \cos\left(\frac{4\pi}{12}\right)$$

$$= 2 - 6 \cos\left(\frac{\pi}{3}\right)$$

$$= 2 - 6 \times \frac{1}{2}$$

$$= 2 - 3$$

$$= -1^\circ\text{C}$$

- 18 a $y = -\cos(2x)$ and $y = \sqrt{3} \sin(2x)$ for $x \in \left[-\frac{\pi}{2}, \frac{\pi}{2}\right]$.

$y = -\cos(2x)$ has period π , amplitude 1, graph is inverted.

$y = \sqrt{3} \sin(2x)$ has period π , amplitude $\sqrt{3}$.

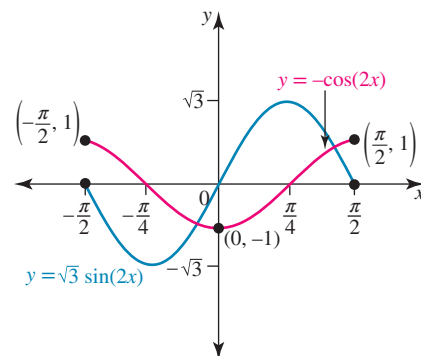

- b At the points of intersection, $\sqrt{3} \sin(2x) = -\cos(2x)$.

$$\therefore \frac{\sin(2x)}{\cos(2x)} = -\frac{1}{\sqrt{3}}$$

$$\therefore \tan(2x) = -\frac{\sqrt{3}}{3}$$

There are two points of intersection from the graph.

$$\therefore 2x = -\frac{\pi}{6}, \pi - \frac{\pi}{6}$$

$$\therefore 2x = -\frac{\pi}{6}, \frac{5\pi}{6}$$

$$\therefore x = -\frac{\pi}{12}, \frac{5\pi}{12}$$

Substitute these values in $y = -\cos(2x)$.

$$x = -\frac{\pi}{12}$$

$$y = -\cos\left(-\frac{\pi}{6}\right)$$

$$= -\frac{\sqrt{3}}{2}$$

$$x = \frac{5\pi}{12}$$

$$y = -\cos\left(\frac{5\pi}{6}\right)$$

$$= \frac{\sqrt{3}}{2}$$

The points of intersection are $\left(-\frac{\pi}{12}, -\frac{\sqrt{3}}{2}\right)$ and

$$\left(\frac{5\pi}{12}, \frac{\sqrt{3}}{2}\right).$$

$$\text{c } \left\{ x: \sqrt{3} \sin(2x) + \cos(2x) \geq 0, -\frac{\pi}{2} \leq x \leq \frac{\pi}{2} \right\}$$

$$\sqrt{3} \sin(2x) + \cos(2x) \geq 0 \Rightarrow \sqrt{3} \sin(2x) \geq -\cos(2x)$$

From the graph in part a, the sine curve lies above the cosine curve between the points of intersection.

$$\text{The solution set is } \left\{ x: -\frac{\pi}{12} \leq x \leq \frac{5\pi}{12} \right\}.$$

$$\text{d i } f(0) = 2 \sin\left(-\frac{\pi}{6}\right)$$

$$= -2 \sin\left(\frac{\pi}{6}\right)$$

$$= -2 \times \frac{1}{2}$$

$$= -1$$

$$f\left(\frac{\pi}{2}\right) = 2 \sin\left(2 \times \frac{\pi}{2} - \frac{\pi}{6}\right)$$

$$= 2 \sin\left(\frac{5\pi}{6}\right)$$

$$= 2 \sin\left(\frac{\pi}{6}\right)$$

$$= 2 \times \frac{1}{2}$$

$$= 1$$

ii The graph of

$$f(x) = 2 \sin\left(2x - \frac{\pi}{6}\right) = 2 \sin\left(2\left(x - \frac{\pi}{12}\right)\right)$$

is a horizontal translation of $\frac{\pi}{12}$ to the right of the graph of $y = \sin(2x)$.

Move the key points on $y = \sin(2x)$ according to this translation.

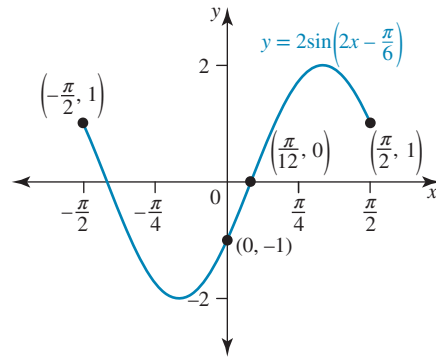

The x -intercepts of $y = \sqrt{3} \sin(2x)$ are translated to

$$x = -\frac{\pi}{2} + \frac{\pi}{12} = -\frac{5\pi}{12} \text{ and } x = 0 + \frac{\pi}{12} = \frac{\pi}{12}.$$

Hence, $2 \sin\left(2x - \frac{\pi}{6}\right) \geq 0$ for $-\frac{\pi}{2} \leq x \leq -\frac{5\pi}{12}$ and for $\frac{\pi}{12} \leq x \leq \frac{\pi}{2}$.

The solution set is

$$\left\{ x: -\frac{\pi}{2} \leq x \leq -\frac{5\pi}{12} \right\} \cup \left\{ x: \frac{\pi}{12} \leq x \leq \frac{\pi}{2} \right\}.$$

$$\text{19 a Maximum depth} = 2.5 + 2 = 4.5$$

$$\text{Minimum depth} = 2.5 - 2 = 0.5$$

$$\text{b Period} = \frac{2\pi}{\frac{\pi}{6}} = 12 \text{ hours}$$

$$\begin{aligned} \text{c } d(3) &= 2 \sin\left(\frac{3\pi}{6} - \frac{\pi}{3}\right) + 2.5 \\ &= 2 \sin\left(\frac{\pi}{6}\right) + 2.5 \\ &= 2 \times \frac{1}{2} + 2.5 \\ &= 3.5 \text{ m} \end{aligned}$$

$$\text{d } 4.2 = 2 \sin\left(\frac{\pi t}{6} - \frac{\pi}{3}\right) + 2.5$$

$$t = 3.94, 6.06 \text{ hours}$$

$$= 3 \text{ hours } 56 \text{ minutes, } 6 \text{ hours } 4 \text{ minutes}$$

The depths are recorded from 10 am, so the times that the depth is at least 4.2 m over a 24-hour period are from 1:56 pm to 4:04 pm and from 1:56 am to 4:04 am.

$$\text{20 a Amplitude} = \frac{28 - 22}{2} = 3$$

$$\therefore a = 3$$

$$\text{Mean position} = k = 25$$

$$\text{Period} = 12$$

$$\frac{2\pi}{n} = 12$$

$$n = \frac{\pi}{6}$$

$$T = 3 \cos\left(\frac{\pi}{6}(x - h)\right) + 25$$

Point (6, 28):

$$28 = 3 \cos\left(\frac{\pi}{6}(6 - h)\right) + 25$$

$$3 = 3 \cos\left(\frac{\pi}{6}(6 - h)\right)$$

$$1 = \cos\left(\frac{\pi}{6}(6 - h)\right)$$

$$0 = \frac{\pi}{6}(6 - h)$$

$$0 = 6 - h$$

$$h = 6$$

$$\therefore T = 3 \cos\left(\frac{\pi}{6}(x - 6)\right) + 25$$

b At 10 am, $t = 2$.

$$T = 3 \cos\left(\frac{\pi}{6}(2 - 6)\right) + 25$$

$$= 3 \cos\left(\frac{-4\pi}{6}\right) + 25$$

$$= 3 \cos\left(\frac{-2\pi}{3}\right) + 25$$

$$= 3 \cos\left(\frac{2\pi}{3}\right) + 25$$

$$= -3 \cos\left(\frac{\pi}{3}\right) + 25$$

$$= -3 \times \frac{1}{2} + 25$$

$$= 23.5^\circ\text{C}$$

c $24 = 3 \cos\left(\frac{\pi}{6}(x - 6)\right) + 25$

$$t = 2.35, 9.65, 14.35, 21.65$$

The times below 24°C in a 24-hour period are:

0 to 2.35, 9.65 to 14.35 and 21.65 to 24.

So the total time is 9.4 hours.

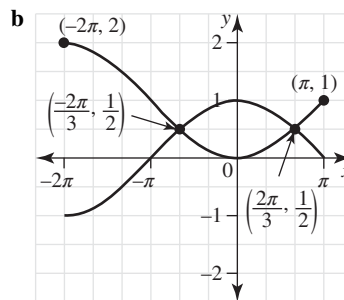

Award 1 mark for correct intersection points.

Award 1 mark for the correct graph.

3 Period $T = \frac{2\pi}{\left(\frac{2\pi}{3}\right)} = 3$

The correct answer is **C**.

4 a $(\tan(\theta) - 1)(\sin(\theta) - \sqrt{3}\cos(\theta))$
 $(\sin(\theta) + \sqrt{3}\cos(\theta)) = 0$

$$(\tan(\theta) - 1)(\tan(\theta) - \sqrt{3})(\tan(\theta) + \sqrt{3}) = 0$$

$$\tan(\theta) = 1, \pm\sqrt{3}$$

Award 1 mark for all three correct values.

b $(\tan(\theta) - 1)(\sin(\theta) - \sqrt{3}\cos(\theta))$
 $(\sin(\theta) + \sqrt{3}\cos(\theta)) = 0$

$$\Rightarrow (\tan(\theta) - 1)(\sin^2(\theta) - 3\cos^2(\theta)) = 0$$

$$\Rightarrow \tan(\theta) = 1, \tan(\theta) = -\sqrt{3}, \tan(\theta) = \sqrt{3}, 0 \leq \theta \leq \pi$$

$$\Rightarrow \theta = \frac{\pi}{4}, \frac{\pi}{3}, \frac{2\pi}{3}$$

Award 1 mark for the correct method.

Award 1 mark for all three correct values.

5 $f: R \rightarrow R, f(x) = 2 \sin(3x) - 3$

Period: $T = \frac{2\pi}{3}$

Range: $[-2, 2] - 3 = [-5, -1]$

The correct answer is **A**.

2.8 Exam questions

1 a $[-2, 2]$ [1 mark]

b Period $= \frac{2\pi}{2} = \pi$ [1 mark]

c $\sin(2x) = \frac{\sqrt{3}}{2}$

$$2x = \frac{\pi}{3} + 2k\pi, \frac{2\pi}{3} + 2k\pi, k \in Z \quad [2 \text{ marks}]$$

$$x = \frac{\pi}{6} + k\pi, \frac{\pi}{3} + k\pi, k \in Z \quad [1 \text{ mark}]$$

2 a $1 - \cos\left(\frac{x}{2}\right) = \cos\left(\frac{x}{2}\right)$ for $x \in [-2\pi, \pi]$

$$2 \cos\left(\frac{x}{2}\right) = 1$$

$$\cos\left(\frac{x}{2}\right) = \frac{1}{2}$$

$$\frac{x}{2} = \frac{\pi}{3}, -\frac{\pi}{3}$$

$$x = \frac{2\pi}{3}, -\frac{2\pi}{3}$$

Award 1 mark for solving.

Award 1 mark for the correct answers.

Topic 3 — Composite functions, transformations and inverses

3.2 Composite functions

3.2 Exercise

1 a $g(h(x)) = g(\sqrt{x})$
 $= 2\sqrt{x} - 3$

b $f \circ g(x) = f(g(x))$
 $= f(2x - 3)$
 $= -(2x - 3)^2 + 1$

2 a $g(h(x)) = g(1 - x^4)$
 $= (1 - x^4 - 3)^2$
 $= (-2 - x^4)^2$
 $= (x^4 + 2)^2$

b $h \circ f(x) = h(f(x))$
 $= h\left(\frac{1}{x+2}\right)$
 $= 1 - \left(\frac{1}{x+2}\right)^4$
 $= 1 - \frac{1}{(x+2)^4}$

3 $f(x) = (x - 1)(x + 3)$ and $g(x) = x^2$

	Dom	Ran
$f(x)$	R	$[-4, \infty)$
$g(x)$	R	$[0, \infty)$

For $f(g(x))$, the range of $g(x)$ is $[0, \infty)$, which is a subset of the domain of $f(x)$, which is R , so $f(g(x))$ exists.

$$f(g(x)) = (x^2 - 1)(x^2 + 3) = (x - 1)(x + 1)(x^2 + 3)$$

where dom = R

For $g(f(x))$, the range of $f(x)$ is $[-4, \infty)$, which is a subset of the domain of $g(x)$, which is R , so $g(f(x))$ exists.

$$g(f(x)) = ((x - 1)(x + 3))^2 = (x - 1)^2(x + 3)^2$$

where dom = R

4 $f(x) = 2x - 1$ and $g(x) = \frac{1}{x - 2}$

	Dom	Ran
$f(x)$	R	R
$g(x)$	$R \setminus \{2\}$	$R \setminus \{0\}$

For $f(g(x))$, the range of $g(x)$ is $R \setminus \{0\}$, which is a subset of the domain of $f(x)$, which is R , so $f(g(x))$ exists.

$$f(g(x)) = \frac{2}{x - 2} - 1 \text{ where dom} = R \setminus \{2\}$$

For $g(f(x))$, the range of $f(x)$ is R , which is not a subset of the domain of $g(x)$, which is $R \setminus \{2\}$, so $g(f(x))$ does not exist.

5 $f(x) = x^2 + 1$, $g(x) = \sqrt{x}$ and $h(x) = \frac{1}{x}$

	Dom	Ran
$f(x)$	R	$[1, \infty)$
$g(x)$	$[0, \infty)$	$[0, \infty)$
$h(x)$	$R \setminus \{0\}$	$R \setminus \{0\}$

a $f(g(x))$ exists because the range of $g(x)$, which is $[0, \infty)$, is a subset of the domain of $f(x)$, which is R .

$$\text{Dom} = [0, \infty)$$

b $g(f(x))$ exists because the range of $f(x)$, which is $[1, \infty)$, is a subset of the domain of $g(x)$, which is $[0, \infty)$.

$$\text{Dom} = R$$

c $h(g(x))$ does not exist because the range of $g(x)$, which is $[0, \infty)$, is not a subset of the domain of $h(x)$, which is $R \setminus \{0\}$.

d $h(f(x))$ does exist because the range of $f(x)$, which is $[1, \infty)$, is a subset of the domain of $h(x)$, which is $R \setminus \{0\}$.

$$\text{Dom} = R$$

6 $f(x) = x^2$, $g(x) = \sqrt{x}$ and $h(x) = -\frac{1}{x}$

	Dom	Ran
$f(x)$	R	$[0, \infty)$
$g(x)$	$[0, \infty)$	$[0, \infty)$
$h(x)$	$R \setminus \{0\}$	$R \setminus \{0\}$

a $f(g(x))$ exists because the range of $g(x)$, which is $[0, \infty)$ is a subset of the domain of $f(x)$, which is R .

$$\text{The rule is } f(g(x)) = f(\sqrt{x}) = (\sqrt{x})^2 = x \text{ where dom} = [0, \infty).$$

b $g(f(x))$ exists because the range of $f(x)$, which is $[0, \infty)$ is equal to the domain of $g(x)$, which is $[0, \infty)$.

$$\text{The rule is } g(f(x)) = g(x^2) = \sqrt{x^2} \text{ where dom} = R.$$

c $h(f(x))$ does not exist because the range of $f(x)$, which is $[0, \infty)$, is not a subset of the domain of $h(x)$, which is $R \setminus \{0\}$.

d $g(h(x))$ does not exist because the range of $h(x)$, which is $R \setminus \{0\}$, is not a subset of the domain of $g(x)$, which is $[0, \infty)$.

7 $f: R \rightarrow R$, $f(x) = x^2 + 1$ where ran = $[1, \infty)$

$$g: [-2, \infty) \rightarrow R$$
, $g(x) = \sqrt{x + 2}$ where ran = $[0, \infty)$

$f(g(x))$ exists because the range of $g(x)$, which is $[0, \infty)$, is a subset of the domain of $f(x)$, which is R .

$$f(g(x)) = f(\sqrt{x + 2}) = (\sqrt{x + 2})^2 + 1 = x + 3$$

where dom = $[-2, \infty)$ and ran = $[1, \infty)$.

8 $f: (0, \infty) \rightarrow R$, $f(x) = \frac{1}{x}$ where ran = $(0, \infty)$

$$g: R \setminus \{0\} \rightarrow R$$
, $g(x) = \frac{1}{x^2}$ where ran = $(0, \infty)$

a $g(f(x))$ exists because the range of $f(x)$, which is $(0, \infty)$, is a subset of the domain of $g(x)$, which is $\mathbb{R} \setminus \{0\}$.

b $g(f(x)) = g\left(\frac{1}{x}\right) = x^2$ where $\text{dom} = (0, \infty)$ and $\text{ran} = (0, \infty)$.

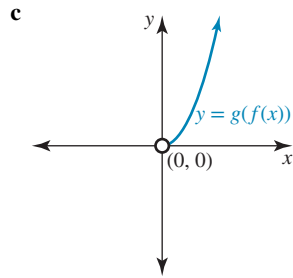

9 $f(x) = \sqrt{x+3}$ and $g(x) = 2x - 5$

	Dom	Ran
$f(x)$	$[-3, \infty)$	$[0, \infty)$
$g(x)$	\mathbb{R}	\mathbb{R}

a $f(g(x))$ is not defined because the range of $g(x)$, which is \mathbb{R} , is not contained in the domain of $f(x)$, which is $[-3, \infty)$.

b We want $\text{ran } g = [-3, \infty)$.

Solve $2x - 5 > -3$.

If the domain of $g(x)$ is restricted to $[1, \infty)$ to produce the function $h(x)$, then $f(h(x))$ exists, because the range of $h(x)$ will be $[-3, \infty)$, which equals the domain of $f(x)$.

$\therefore h(x) = 2x - 5, x \in [1, \infty)$

c $f(h(x)) = \sqrt{2x - 5 + 3} = \sqrt{2x - 2}$ where $x \in [1, \infty)$

10 $f(x) = x^2$ and $g(x) = \frac{1}{x-4}$

	Dom	Ran
$f(x)$	\mathbb{R}	$[0, \infty)$
$g(x)$	$\mathbb{R} \setminus \{4\}$	$\mathbb{R} \setminus \{0\}$

a $g(f(x))$ is not defined because the range of $f(x)$, which is $[0, \infty)$, is not contained in the domain of $g(x)$, which is $\mathbb{R} \setminus \{4\}$.

b We want $\text{ran } f \neq 4$.

Solve $x^2 \neq 4$.

If the domain of $f(x)$ is restricted to $\mathbb{R} \setminus \{-2, 2\}$ to produce the function $h(x)$, then $g(h(x))$ exists, because the range of $h(x)$ will be $\mathbb{R} \setminus \{4\}$, which equals the domain of $g(x)$.

$\therefore h(x) = x^2, x \in \mathbb{R} \setminus \{-2, 2\}$

c $g(h(x)) = \frac{1}{x^2 - 4}$ where $x \in \mathbb{R} \setminus \{-2, 2\}$

11 $g(x) = \frac{1}{(x-3)^2} - 2$ and $f(x) = \sqrt{x}$.

	Dom	Ran
$g(x)$	$\mathbb{R} \setminus \{3\}$	$(-2, \infty)$
$f(x)$	$[0, \infty)$	$[0, \infty)$

a $f(g(x))$ is not defined because the range of $g(x)$, which is $(-2, \infty)$, is not contained in the domain of $f(x)$, which is $[0, \infty)$.

b For $f(g(x))$ to have a domain for its existence:

$$\frac{1}{(x-3)^2} - 2 = 0$$

$$\frac{1}{(x-3)^2} = 2$$

$$(x-3)^2 = \frac{1}{2}$$

$$x-3 = \pm \frac{1}{\sqrt{2}}$$

$$x = \pm \frac{1}{\sqrt{2}} + 3$$

i.e. $x \in \left[3 - \frac{1}{\sqrt{2}}, 3\right) \cup \left(3, 3 + \frac{1}{\sqrt{2}}\right]$

12 $f: (-\infty, 2) \rightarrow \mathbb{R}, f(x) = \sqrt{2-x}$ and

$g: \mathbb{R} \rightarrow \mathbb{R}, g(x) = -\frac{1}{x-1} + 2$

	Dom	Ran
$f(x)$	$(-\infty, 2)$	$[0, \infty)$
$g(x)$	$\mathbb{R} \setminus \{1\}$	$\mathbb{R} \setminus \{2\}$

a $g(f(x))$ is not defined because the range of $f(x)$, which is $[0, \infty)$, is not contained in the domain of $g(x)$, which is $\mathbb{R} \setminus \{1\}$.

b For $g(f_1(x))$ to have a domain for its existence, the domain must be $(-\infty, 2] \setminus \{1\}$.

$f_1(x) = \sqrt{2-x}, x \in (-\infty, 2] \setminus \{1\}$

c $g(f_1(x)) = -\frac{1}{\sqrt{2-x}-1} + 2$ where $x \in (-\infty, 2] \setminus \{1\}$

13 $f: [4, \infty) \rightarrow \mathbb{R}, f(x) = \sqrt{x-4}$ and $g: \mathbb{R} \rightarrow \mathbb{R}, g(x) = x^2 - 2$

	Dom	Ran
$f(x)$	$[4, \infty)$	$[0, \infty)$
$g(x)$	\mathbb{R}	$[-2, \infty)$

a $g(f(x))$ exists because the range of $f(x)$, which is $[0, \infty)$, is the subset of the domain of $g(x)$, which is \mathbb{R} .

b $g(f(x)) = g(\sqrt{x-4}) = (\sqrt{x-4})^2 - 2 = x - 6$ where the domain is $[4, \infty)$.

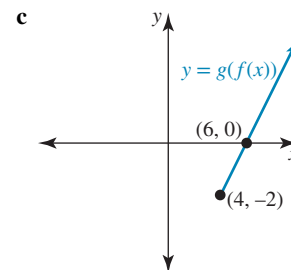

d $f(g(x))$ does not exist because the range of $g(x)$, which is $[-2, \infty)$, is not the subset of the domain of $f(x)$, which is $[4, \infty)$.

e If the domain of $g(x)$ is restricted to $(-\infty, -\sqrt{6}] \cup [\sqrt{6}, \infty)$, then a new function is formed, which is $g_1: (-\infty, -\sqrt{6}] \cup [\sqrt{6}, \infty) \rightarrow \mathbb{R}, g_1(x) = x^2 - 2$, so $f(g_1(x))$ exists.

$f \circ f_1(g(x)) = \sqrt{x^2 - 2} - 4 = \sqrt{x^2 - 6}$ where
 $x \in (-\infty, -\sqrt{6}] \cup [\sqrt{6}, \infty)$.

- 14 $f: [1, \infty) \rightarrow R, f(x) = -\sqrt{x} + k$ and
 $g: (-\infty, 2] \rightarrow R,$
 $g(x) = x^2 + k$

	Dom	Ran
$f(x)$	$[1, \infty)$	$(-\infty, -1 + k]$
$g(x)$	$(-\infty, 2]$	$[k, \infty)$

Ran $f \subseteq$ dom g , so $[1, \infty) \subseteq [k, \infty)$; therefore, $k \geq 1$.
 Ran $g \subseteq$ dom f , so $(-\infty, -1 + k] \subseteq (-\infty, 2]$; therefore, $k \leq 3$.
 Therefore, overall, $k \in [1, 3]$.

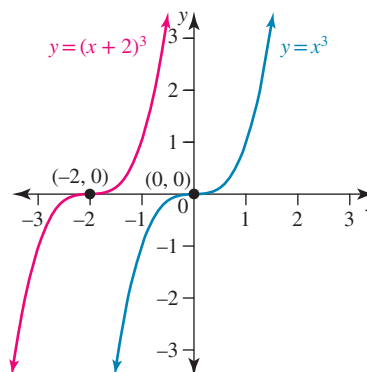

- ii $(-2, -8) \rightarrow (-4, -8)$
 c i $y = x^3$ has been reflected in the x -axis to produce $y = -x^3$.

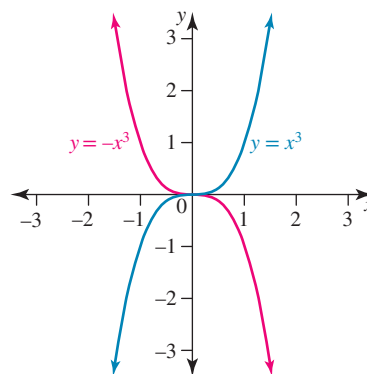

- ii $(-2, -8) \rightarrow (-2, 8)$
 d i $y = x^3$ has been translated up 1 unit or in the positive y -axis direction to produce $y = x^3 + 1$.

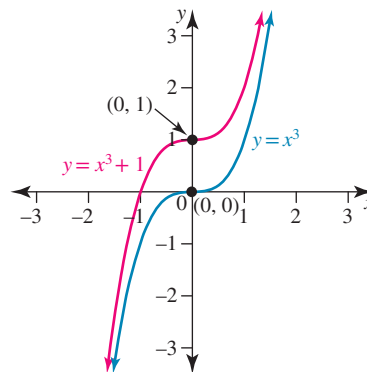

- ii $(-2, -8) \rightarrow (-2, -7)$
 2 a $y = \sin(x)$ has been dilated by a factor of 4 parallel to the y -axis or from the x -axis to produce $y = 4 \sin(x)$.

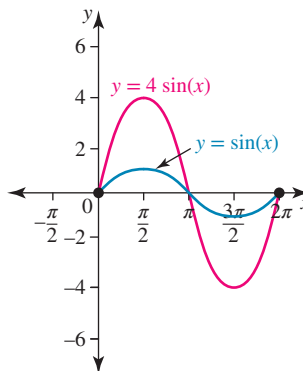

3.2 Exam questions

- 1 $g(f(-1)) = g(4) = 6$
 The correct answer is **D**.
 2 $f(x) = 2x, g(x + 2) = 3x + 1$
 $g(x) = 3(x - 2) + 1$
 $= 3x - 6 + 1$
 $= 3x - 5$
 $f(g(x)) = 2(3x - 5)$
 $= 6x - 10$
 The correct answer is **D**.
 3 $f(x) = 4x^2$
 $f(g(x)) = f(3x + 1)$
 $= 4(3x + 1)^2$
 $f(g(a)) = 4(3a + 1)^2$
 The correct answer is **A**.

3.3 Transformations

3.3 Exercise

- 1 a i $y = x^3$ has been dilated by a factor of 3 parallel to the y -axis or from the x -axis to produce $y = 3x^3$.

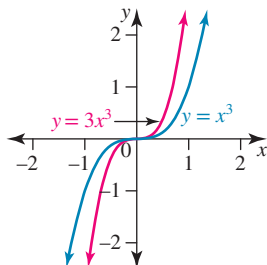

- ii $(-2, -8) \rightarrow (-2, -24)$
 b i $y = x^3$ has been translated 2 units to the left or in the negative x -direction to produce $y = (x + 2)^3$.

- b** $y = \sin(x)$ has been dilated by a factor of $\frac{1}{2}$ parallel to the x -axis or from the y -axis to produce $y = \sin(2x)$.

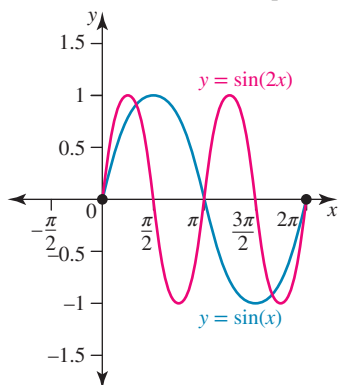

- c** $y = \sin(x)$ has been translated $\frac{\pi}{2}$ units to the left or in the negative x -direction to produce $y = \sin\left(x + \frac{\pi}{2}\right)$.

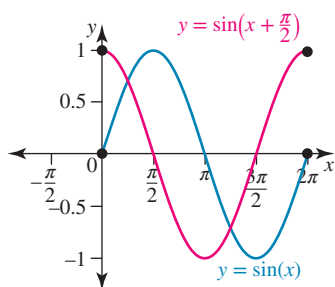

- d** $y = \sin(x)$ has been translated up 2 units or in the positive y -direction to produce $y = \sin(x) + 2$.

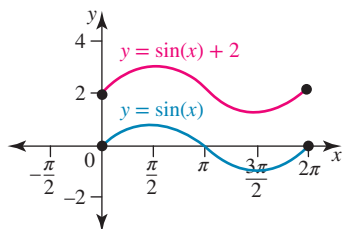

- 3 a** $y = \cos(x) \rightarrow y = \frac{1}{2} \cos(x)$

$y = \cos(x)$ has been dilated by a factor of $\frac{1}{2}$ parallel to the y -axis or from the x -axis.

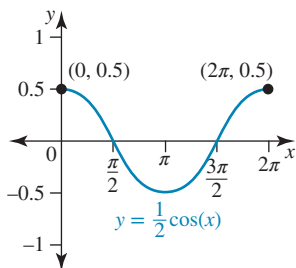

- b** $y = \cos(x) \rightarrow y = \cos(2x)$

$y = \cos(x)$ has been dilated by a factor of $\frac{1}{2}$ parallel to the x -axis or from the y -axis.

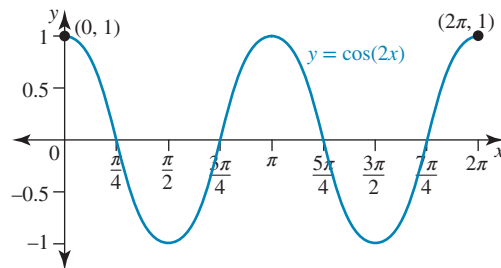

- c** $y = \cos(x) \rightarrow y = -\cos(x)$
 $y = \cos(x)$ has been reflected in the x -axis.

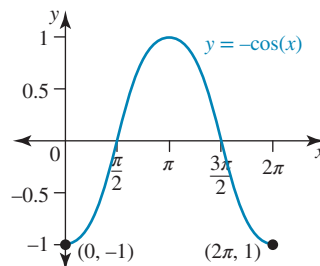

- d** $y = \cos(x) \rightarrow y = \cos(x) - 1$
 $y = \cos(x)$ has been translated down 1 unit or in the negative y -direction.

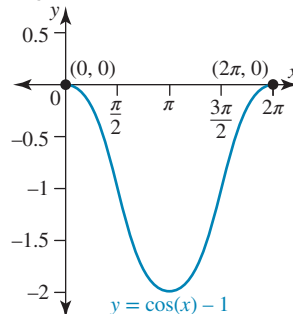

- 4 a** $y = \frac{1}{x} \rightarrow y = f(x - 2)$

$y = \frac{1}{x}$ has been translated by a factor of 2 parallel to the x -axis or in the positive x -direction.

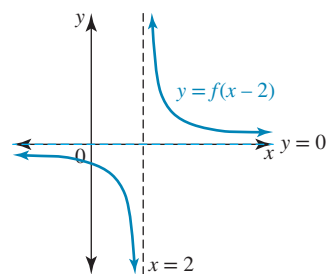

- b** $y = \frac{1}{x} \rightarrow y = -f(x)$

$y = \frac{1}{x}$ has been reflected in the x -axis.

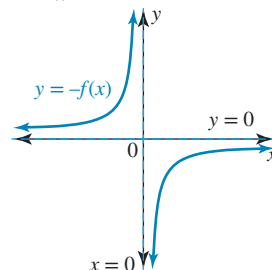

$$c \quad y = \frac{1}{x} \rightarrow y = 3f(x)$$

$y = \frac{1}{x}$ has been dilated by a factor of 3 parallel to the y -axis or from the x -axis.

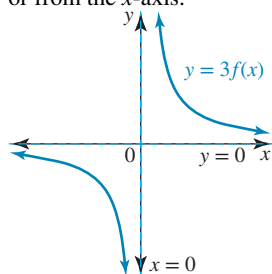

$$d \quad y = \frac{1}{x} \rightarrow y = f(2x)$$

$y = \frac{1}{x}$ has been dilated by a factor of $\frac{1}{2}$ parallel to the x -axis or from the y -axis.

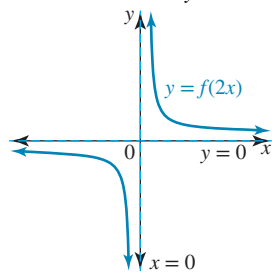

$$5 \quad y = \sin(x) \rightarrow y = -2 \sin \left[2x - \frac{\pi}{2} \right] + 1$$

$$y = \sin(x) \rightarrow y = -2 \sin \left[2 \left(x - \frac{\pi}{4} \right) \right] + 1$$

$y = \sin(x)$ has been

- reflected in the x -axis
- dilated by a factor of 2 parallel to the y -axis or from the x -axis
- dilated by a factor of $\frac{1}{2}$ parallel to the x -axis or from the y -axis
- translated $\frac{\pi}{4}$ units to the right or in the positive x -direction
- translated 1 unit up or in the positive y -direction.

$$6 \quad y = e^x \rightarrow y = \frac{1}{3} e^{\left(\frac{x+1}{2}\right)} - 2$$

$y = e^x$ has been

- dilated by a factor of $\frac{1}{3}$ parallel to the y -axis or from the x -axis
- dilated by a factor of 2 parallel to the x -axis or from the y -axis
- translated 1 unit to the left or in the negative x -direction
- translated 2 units down or in the negative y -direction.

$$7 \quad a \quad y = x^2 \rightarrow y = \frac{1}{3} (x+3)^2 - \frac{2}{3}$$

$y = x^2$ has been dilated by a factor of $\frac{1}{3}$ parallel to the y -axis or from the x -axis, translated 3 units to the left or in the negative x -direction, and translated $\frac{2}{3}$ units down or $\frac{2}{3}$ units in the negative y -direction.

$$b \quad y = x^3 \rightarrow y = -2(1-x)^3 + 1$$

$y = x^3$ has been reflected in the x - and y -axes, dilated by a factor of 2 parallel to the y -axis or from the x -axis, translated 1 unit to the right or in the positive x -direction, and translated 1 unit up or in the positive y -direction.

$$c \quad y = \frac{1}{x} \rightarrow y = \frac{3}{(2x+6)} - 1 \text{ or } y = \frac{3}{2(x+3)} - 1$$

$y = \frac{1}{x}$ has been dilated by a factor of 3 parallel to the y -axis

or from the x -axis, dilated by a factor of $\frac{1}{2}$ parallel to the x -axis or from the y -axis, translated 3 units to the left or in the negative x -direction, and translated 1 unit down or in the negative y -direction.

$$8 \quad a \quad (-2, 4) \rightarrow \left(-2, \frac{4}{3}\right) \rightarrow \left(-5, \frac{4}{3}\right) \rightarrow \left(-5, \frac{2}{3}\right)$$

$$b \quad (1, 1) \rightarrow (-1, -1) \rightarrow (-1, -2) \rightarrow (0, -2) \rightarrow (0, -1)$$

$$c \quad \left(2, \frac{1}{2}\right) \rightarrow (2, 1) \rightarrow (1, 1) \rightarrow (-2, 1) \rightarrow (-2, 0)$$

$$9 \quad a \quad y = \cos(x) \rightarrow y = 2 \cos \left[2 \left(x - \frac{\pi}{2} \right) \right] + 3$$

$y = \cos(x)$ has been dilated by a factor of 2 parallel to the y -axis or from the x -axis, dilated by a factor of $\frac{1}{2}$ parallel to the x -axis or from the y -axis, translated $\frac{\pi}{2}$ units to the right or $\frac{\pi}{2}$ units in the positive x -direction, and translated 3 units up or in the positive y -direction.

$$b \quad y = \tan(x) \rightarrow y = -\tan(-2x) + 1$$

$y = \tan(x)$ has been reflected in both axes, dilated by a factor of $\frac{1}{2}$ parallel to the x -axis or from the y -axis, and translated 1 unit up or in the positive y -direction.

$$c \quad y = \sin(x) \rightarrow y = \sin(3x - \pi) - 1 \text{ or}$$

$$y = \sin \left[3 \left(x - \frac{\pi}{3} \right) \right] - 1$$

$y = \sin(x)$ has been dilated by a factor of $\frac{1}{3}$ parallel to the x -axis or from the y -axis, translated $\frac{\pi}{3}$ units to the right or $\frac{\pi}{3}$ units in the positive x -direction and translated 1 unit down or 1 unit in the negative y -direction.

$$10 \quad g(x) = x^2 \text{ is reflected in the } y\text{-axis: } \rightarrow 1 \quad (-x)^2 = x^2 \text{ is translated 4 units to the right } \rightarrow (x-4)^2 \text{ is dilated by a factor}$$

of 2 from the y -axis $\rightarrow \left(\frac{x}{2} - 4\right)^2$ is translated 3 units down \rightarrow

$$\left(\frac{x}{2} - 4\right)^2 - 3 \text{ is dilated by a factor of } \frac{1}{3} \text{ from the } x\text{-axis } \rightarrow$$

$$\frac{1}{3} \left(\frac{x}{2} - 4\right)^2 - 1$$

$$\therefore f(x) = \frac{1}{3} \left(\frac{x-8}{2}\right)^2 - 1$$

Therefore, the correct answer is **A**.

$$11 \quad h(x) = \frac{1}{x} \text{ is dilated by a factor of 3 parallel to the}$$

$$x\text{-axis } \rightarrow \frac{1}{\frac{x}{3}} = \frac{3}{x}$$

$$\text{is translated up 2 units } \rightarrow \frac{3}{x} + 2$$

$$\text{is reflected in the } y\text{-axis } \rightarrow -\frac{3}{x} + 2$$

$$\text{is translated 1 unit to the left } \rightarrow -\frac{3}{x+1} + 2$$

$$\text{is reflected in the } x\text{-axis } \rightarrow \frac{3}{x+1} - 2$$

$$\therefore f(x) = \frac{3}{x+1} - 2$$

Therefore, the correct answer is **D**.

$$12 \quad h(x) = \sqrt[3]{x} \rightarrow \sqrt[3]{-x} \rightarrow \sqrt[3]{-(x-3)} \rightarrow \sqrt[3]{-\left(\frac{x}{2}-3\right)}$$

$$= \sqrt[3]{-\left(\frac{x-6}{2}\right)}$$

$$\text{Therefore, } f(x) = \sqrt[3]{-\left(\frac{x-6}{2}\right)}.$$

$$13 \quad h(x) = \frac{1}{x^2} \rightarrow \frac{1}{(x+2)^2} - 3 \rightarrow -\left(\frac{1}{(x+2)^2} - 3\right) \rightarrow$$

$$-3\left(\frac{1}{(x+2)^2} - 3\right) = -\frac{3}{(x+2)^2} + 9 \rightarrow -\frac{3}{(2-x)^2} + 9$$

$$\text{Therefore, } f(x) = -\frac{3}{(2-x)^2} + 9.$$

$$14 \quad f(x) = 2x^2 - 3 \rightarrow -2x^2 + 3 \rightarrow -2(3x)^2 + 3 = -18x^2 + 3 \rightarrow$$

$$-18(x-1)^2 + 1$$

$$\text{Therefore, } f(x) = -18(x-1)^2 + 1.$$

$$15 \quad h(x) = \frac{1}{x+2}$$

$$\rightarrow \frac{1}{2x+2}$$

$$\rightarrow \frac{1}{2(x+3)+2} - 3 = \frac{1}{2x+8} - 3$$

$$\rightarrow \frac{1}{-2x+8} - 3$$

$$\rightarrow 2\left(\frac{1}{-2x+8} - 3\right)$$

$$\rightarrow \frac{1}{-x+4} - 6$$

$$\text{Therefore, } f(x) = \frac{1}{4-x} - 6.$$

$$16 \quad y = \frac{2x-5}{x-1}$$

$$= \frac{2(x-1)-3}{x-1}$$

$$= \frac{2(x-1)}{x-1} - \frac{3}{x-1}$$

$$= 2 - \frac{3}{x-1}$$

$y = \frac{1}{x}$ has been reflected in the y -axis or the x -axis, dilated by

a factor of 3 parallel to the y -axis or from the x -axis, translated 1 unit to the right or in the positive x -direction, and translated 2 units up or in the positive y -direction.

dom = $R \setminus \{1\}$ and ran = $R \setminus \{2\}$.

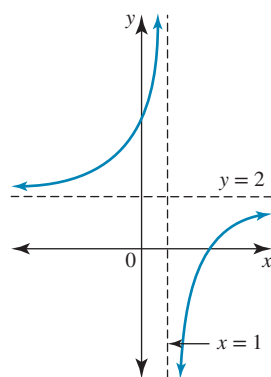

$$17 \quad y = 3 - \sqrt{\frac{5-x}{2}} \rightarrow y = \sqrt{x}$$

$$y = 3 - \sqrt{\frac{5-x}{2}}$$
 has been reflected in both axes, translated

5 units to the right or in the positive x -direction, dilated by a factor of $\frac{1}{2}$ parallel to the x -axis or from the y -axis, and translated up 3 units or in the positive y -direction.

$$18 \quad y = -2(3x-1)^2 + 5 \rightarrow y = (x-2)^2 - 1$$

$y = -2(3x-1)^2 + 5$ has been reflected in the x -axis, dilated by a factor of $\frac{1}{2}$ parallel to the y -axis or from the x -axis, dilated by a factor of 3 parallel to the x -axis or from the y -axis, translated 3 units to the left or in the negative x -direction, and translated $\frac{3}{2}$ units up or in the positive y -direction.

3.3 Exam questions

1 Since f passes through $(-2, 7)$, $f(-2) = 7$.

$$h(x) = f\left(\frac{x}{2}\right) + 5, h(-4) = f(-2) + 5 = 7 + 5 = 12$$

Alternatively, double the x -value and add 5 to the y -value:

$$f: (-2, 7) \rightarrow h: (-4, 12)$$

The correct answer is C.

2 $y = \sqrt{2x-5}$ reflected in the x -axis becomes $y = -\sqrt{2x-5}$.

Dilation by a factor of $\frac{1}{2}$ from the y -axis, that is parallel to the y -axis, replaces $x \rightarrow 2x$.

$$\text{Therefore, } f(x) = -\sqrt{4x-5}.$$

The correct answer is D.

3 To map $y = \sqrt{8x^3+1}$ onto the graph of $y = \sqrt{x^3+1}$, replace x with $\frac{x}{2}$, which represents dilation by a factor of 2 parallel to the x -axis or away from the y -axis.

The correct answer is A.

3.4 Inverse graphs

3.4 Exercise

1 a $y = (1-x)(x+5)$ and the inverse is $x = (1-y)(y+5)$.

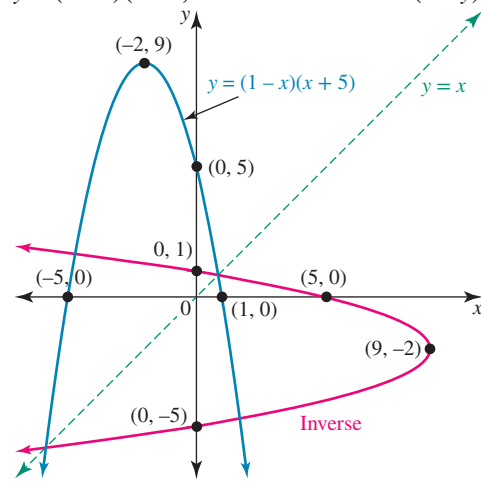

b $y = (1-x)(x+5)$ is a many-to-one mapping and is a function.

The inverse is a one-to-many mapping and is a relation.

c Function: $\text{dom} = \mathbb{R}$ and $\text{ran} = (-\infty, 9]$

Inverse: $\text{dom} = (-\infty, 9]$ and $\text{ran} = \mathbb{R}$

2 a and b

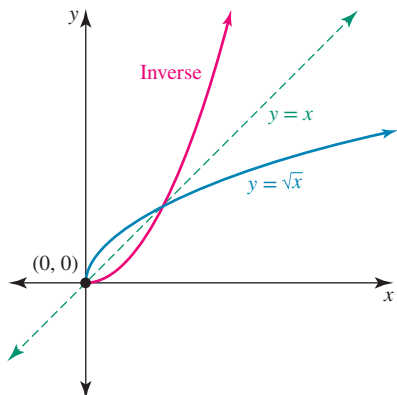

c $y = \sqrt{x}$ is a one-to-one mapping, so it is a function.
 $y = x^2, x \geq 0$ is a one-to-one mapping, so it is a function.

3 a

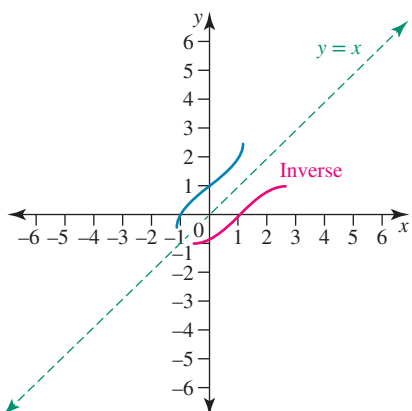

b

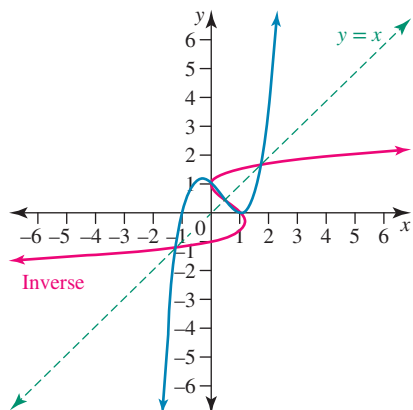

c

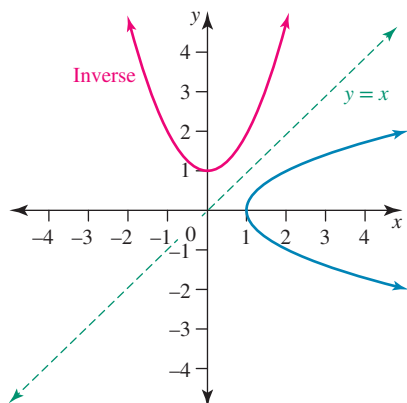

d

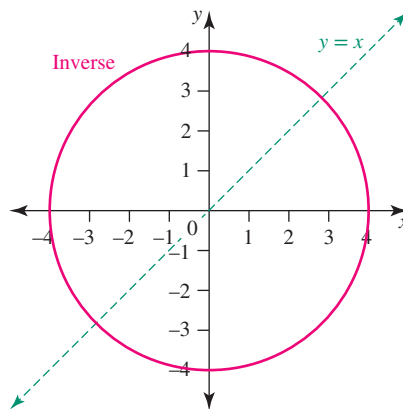

4 a and b

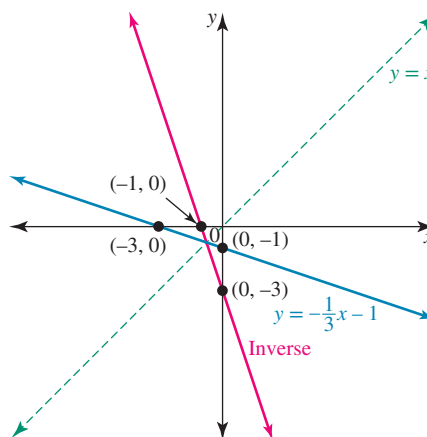

5 a $f(x) = \cos(x)$ is a many-to-one function.

b $g(x) = 1 - x^3$ is a one-to-one function.

c $h(x) = 4 - x^2$ is a many-to-one function.

d $k(x) = 2 + \frac{1}{x-3}$ is a one-to-one function.

6 A $y = x^2 - 1$ is a many-to-one function, so its inverse is a one-to-many relation.

B $y = \frac{1}{(x+2)^2}$ is a many-to-one relation, so its inverse is a one-to-many relation.

C $y = \frac{1}{x-1}$ is a one-to-one function, so its inverse is a one-to-one function.

D $y = x^3 - x^2$ is a many-to-one function, so its inverse is a one-to-many relation.

E $y = 10$ is a many-to-one function, so its inverse is a one-to-many relation.

Therefore, C is the correct answer.

7 A $y = x^2$ is a many-to-one function and $y = \pm\sqrt{x}$ is a one-to-many relation.

B $y = x^2, x \in (-\infty, 0]$ is a one-to-one function and $y = \sqrt{x}$ is a one-to-one function but not an inverse pair.

C Two one-to-one functions

D $y = x^2 + 1, x \in [0, \infty)$ is a one-to-one function and $y = -x^2 - 1, x \in [0, \infty)$ is a one-to-one function but not an inverse pair.

E $y = (x-2)^2$ is a many-to-one function and $y = \pm\sqrt{-x} - 2$ is a one-to-many relation. The two graphs are also not an inverse pair.

Therefore, C is the correct answer.

- 8 $x = (y - 2)^2$ has a turning point at $(0, 2)$ and cuts the x -axis at $(0, 4)$, so its inverse will have to have a turning point at $(2, 0)$ and cut the y -axis at $(4, 0)$.
Therefore, **A** is the correct answer.

9 a

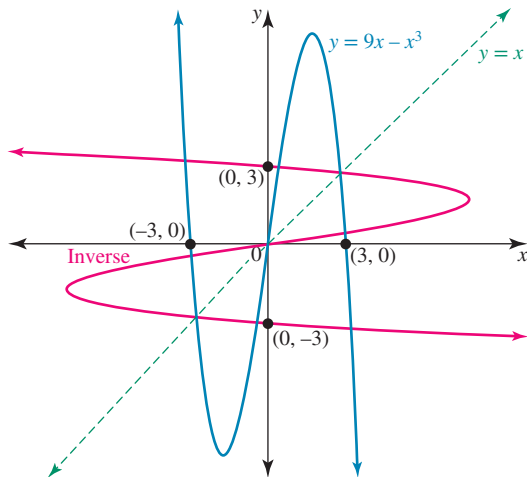

b POI = $(2.828, 2.828), (0, 0), (-2.828, -2.828)$

10 a

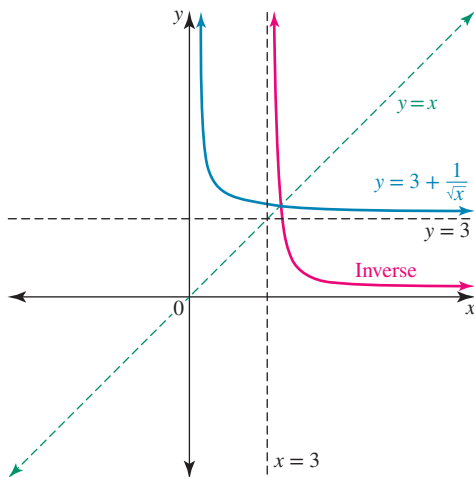

b POI = $(3.532, 3.532)$

- 11 a x -intercepts occur at $x = 1, x = -5$. The TP is halfway between them, so the x -value of the TP is $x = -2$. To obtain the maximum domain, we restrict the parabola about the TP. Therefore, $a = -2$.

b

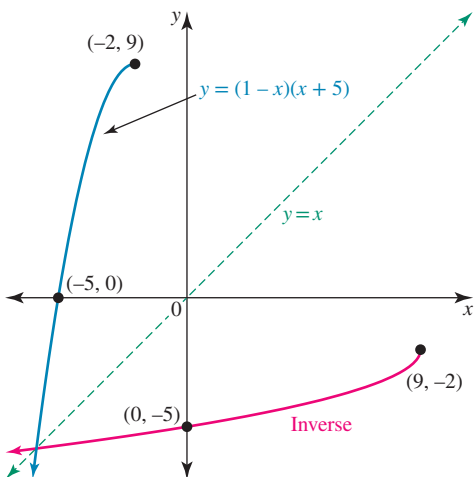

- c For $y = (1 - x)(x + 5)$, $\text{dom} = (-\infty, -2]$ and $\text{ran} = (-\infty, 9]$.
For $x = (1 - y)(y + 5)$, $\text{dom} = (-\infty, 9]$ and $\text{ran} = (-\infty, -2]$.

- 12 If the domain for $y = -(x - 3)^2$ is restricted to $[3, \infty)$, the inverse will be a function also.

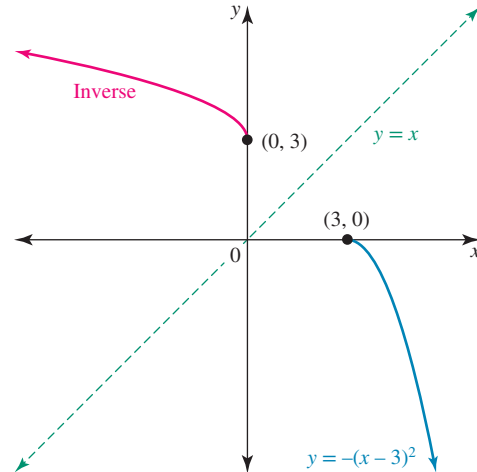

13 a and b

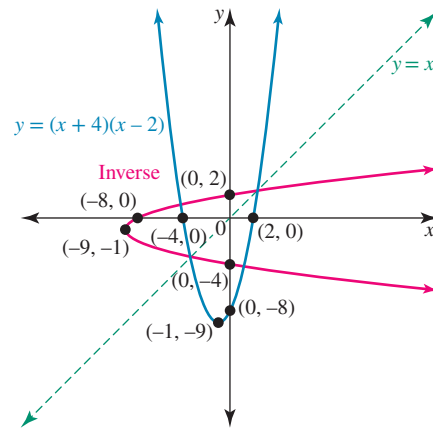

- b The parabola is a many-to-one mapping and the inverse is a one-to-many relation.

c The inverse is not a function as functions must be one-to-one or many-to-one mappings.

d Function: $\text{dom} = \mathbb{R}$ and $\text{ran} = [-9, \infty)$

Inverse: $\text{dom} = [-9, \infty)$ and $\text{ran} = \mathbb{R}$

e The largest domain for an inverse function is either $x \in (-\infty, -1]$ or $x \in [-1, \infty)$.

14 a

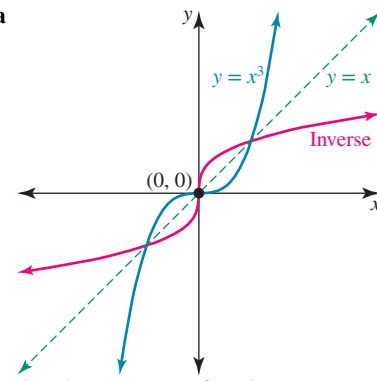

- b Graph: one-to-one function
Inverse: one-to-one function

c The inverse is a function because it is a one-to-one mapping.

d Graph: $\text{dom} = R$ and $\text{ran} = R$
Inverse: $\text{dom} = R$ and $\text{ran} = R$

15 a and b

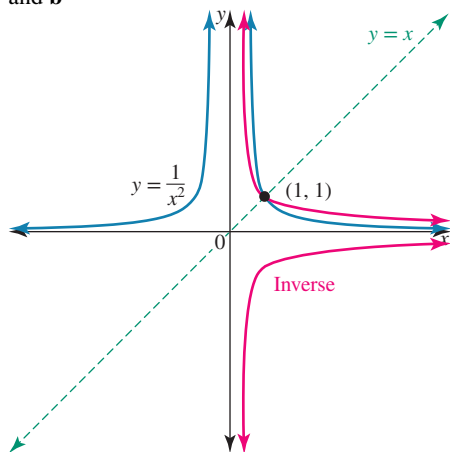

b Graph: many-to-one function
Inverse: one-to-many relation

c The restricted domain to produce an inverse function is $x \in (-\infty, 0)$.

d

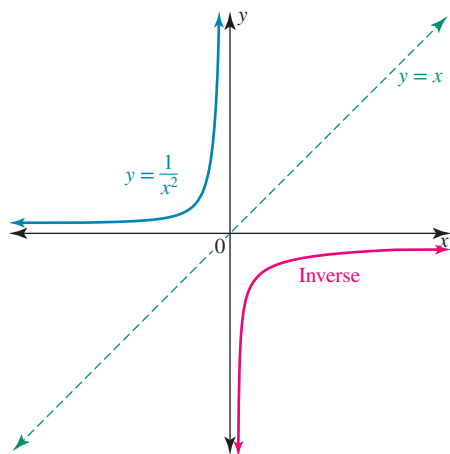

Graph: $\text{dom} = (-\infty, 0)$ and $\text{ran} = (0, \infty)$

Inverse: $\text{dom} = (0, \infty)$ and $\text{ran} = (-\infty, 0)$

16 $y = 2x^2 - 12x + 13$ has a turning point where:

$$y = 2 \left(x^2 - 6x + \frac{13}{2} \right)$$

$$y = 2 \left(x^2 - 6x + (3)^2 - (3)^2 + \frac{13}{2} \right)$$

$$y = 2(x - 3)^2 - 18 + 13$$

$$y = 2(x - 3)^2 - 5$$

TP = $(3, -5)$, so the largest possible domain for the inverse to be a function is $(-\infty, 3)$. Therefore, $a = 3$.

3.4 Exam questions

1 Reflect the original graph in the line $y = x$, so option C is the correct graph.

The correct answer is C.

2 $g: [-a, a] \rightarrow R, g(x) = \sin\left(2\left(x - \frac{\pi}{6}\right)\right)$

For the inverse to be a function, the original function must be a one-to-one function.

Only $a = \frac{\pi}{12}$ makes g a one-to-one function. Check with CAS.

The correct answer is A.

3 A line parallel to the y -axis crosses the graph at infinitely many points, so the graph of $x = -5$ is not a function.

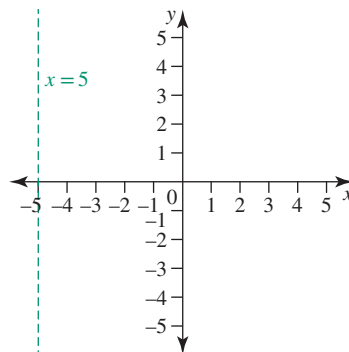

The correct answer is C.

3.5 Inverse functions

3.5 Exercise

1 $y = x^3$ is a one-to-one function with $\text{dom} = R$ and $\text{ran} = R$.

Inverse: swap x and y .

$$x = y^3$$

$$y = \sqrt[3]{x}$$

This is a one-to-one with $\text{dom} = R$ and $\text{ran} = R$.

2 $y = \frac{1}{x^2}$ is a many-to-one function with $\text{dom} = R \setminus \{0\}$ and $\text{ran} = (0, \infty)$.

Inverse: swap x and y .

$$x = \frac{1}{y^2}$$

$$\frac{1}{x} = y^2$$

$$\pm \frac{1}{\sqrt{x}} = y$$

This is a one-to-many relation and thus is not a function. $\text{dom} = (0, \infty)$ and $\text{ran} = R \setminus \{0\}$.

3 a $y = \frac{1}{3}(x - 3)$ is a one-to-one function where $\text{dom} = R$ and $\text{ran} = R$.

Inverse: swap x and y .

$$x = \frac{1}{3}(y - 3)$$

$$3x + 3 = y$$

$$y = 3(x + 1)$$

which is a one-to-one function where $\text{dom} = R$ and $\text{ran} = R$.

b $y = (x - 5)^2$ is a many-to-one function where $\text{dom} = R$ and $\text{ran} = [0, \infty)$.

Inverse: swap x and y .

$$x = (y - 5)^2$$

$$\pm \sqrt{x} = y - 5$$

$$y = 5 \pm \sqrt{x}$$

which is a one-to-many relation where $\text{dom} = [0, \infty)$ and $\text{ran} = R$.

c $y = \sqrt[3]{x + 1} - 2$, $\text{dom} = R$, $\text{ran} = R$

Inverse: swap x and y .

$$x = \sqrt[3]{y+1} - 2$$

$$x + 2 = \sqrt[3]{y+1}$$

$$(x+2)^3 = y+1$$

$$y = (x+2)^3 - 1$$

$y = \sqrt[3]{x+1} - 2$ is a one-to-one function; therefore, the inverse will also be a one-to-one function.

Inverse: domain = R , range = R

d $y = (x-1)^3$ is a one-to-one function where dom = R and ran = R .

Inverse: swap x and y .

$$x = (y-1)^3$$

$$\sqrt[3]{x} = y-1$$

$$y = \sqrt[3]{x} + 1$$

which is a one-to-one function where dom = R and ran = R .

e $y = \sqrt{x}$ is a one-to-one function where dom = $[0, \infty)$ and ran = $[0, \infty)$.

Inverse: swap x and y .

$$x = \sqrt{y}$$

$$x^2 = y \text{ where } x \in [0, \infty)$$

which is a one-to-one function where dom = $[0, \infty)$ and ran = $[0, \infty)$.

f $y = \frac{1}{(x-1)^2} + 2$ is a many-to-one function where

dom = $R \setminus \{1\}$ and ran = $(2, \infty)$.

Inverse: swap x and y .

$$x = \frac{1}{(y-1)^2} + 2$$

$$x-2 = \frac{1}{(y-1)^2}$$

$$\frac{1}{x-2} = (y-1)^2$$

$$\pm \frac{1}{\sqrt{x-2}} = y-1$$

$$y = 1 \pm \frac{1}{\sqrt{x-2}}$$

which is a one-to-many relation with dom = $(2, \infty)$ and ran = $R \setminus \{1\}$.

4 $f: (-\infty, 2) \rightarrow R, f(x) = -\frac{1}{(x-2)^2}$ is a one-to-one function

where ran = $(-\infty, 0)$.

Inverse: swap x and y .

$$x = -\frac{1}{(y-2)^2}$$

$$-x = \frac{1}{(y-2)^2}$$

$$-\frac{1}{x} = (y-2)^2$$

$$\pm \sqrt{-\frac{1}{x}} = y-2$$

$$-\sqrt{-\frac{1}{x}} = y-2 \text{ since } x \in (-\infty, 0)$$

$$2 - \sqrt{-\frac{1}{x}} = y$$

This is a one-to-one function where ran = $(-\infty, 2)$.

$$f^{-1}: (-\infty, 0) \rightarrow R, f^{-1}(x) = 2 - \sqrt{-\frac{1}{x}}$$

5 $f: [3, \infty) \rightarrow R, f(x) = \sqrt{x-3}$ is a one-to-one function where ran = $[0, \infty)$.

Inverse: swap x and y .

$$x = \sqrt{y-3}$$

$$x^2 = y-3$$

$$y = x^2 + 3 \text{ where } x \in [0, \infty) \text{ and } y \in [3, \infty)$$

$$f^{-1}: [0, \infty) \rightarrow R, f^{-1}(x) = x^2 + 3$$

6 $f(x) = \frac{1}{x+2}, x \neq -2$

Inverse: swap x and y .

$$x = \frac{1}{y+2}$$

$$\frac{1}{x} = y+2$$

$$y = \frac{1}{x} - 2$$

$$f^{-1}(x) = \frac{1}{x} - 2, x \neq 0$$

a $f(f^{-1}(x)) = \frac{1}{\frac{1}{x} - 2 + 2} = \frac{1}{\frac{1}{x}} = x$ as required.

b $f^{-1}(f(x)) = \frac{1}{\frac{1}{x+2}} - 2 = x+2-2 = x$ as required.

7 $k(x) = x^3 - 1$

Inverse: Let $y = k(x)$, swap x and y .

$$x = y^3 - 1$$

$$x+1 = y^3$$

$$y = \sqrt[3]{x+1}$$

$$k^{-1}(x) = \sqrt[3]{x+1}$$

a $k(k^{-1}(x)) = (\sqrt[3]{x+1})^3 - 1 = x+1-1 = x$ as required.

b $k^{-1}(k(x)) = \sqrt[3]{x^3 - 1 + 1} = \sqrt[3]{x^3} = x$ as required.

8 a $f(x) = (x+1)^2$ where dom = R and ran = $[0, \infty)$. This is a many-to-one function.

Inverse: swap x and y .

$$x = (y+1)^2$$

$$\pm \sqrt{x} = y+1$$

$$\pm \sqrt{x} - 1 = y \text{ where dom} = [0, \infty) \text{ and ran} = R$$

The inverse is not a function as $f(x)$ is not a one-to-one function.

b If the domain for the function is restricted to $[-1, \infty)$, it is a one-to-one function, so the inverse is also a function. Thus, $b = -1$.

c

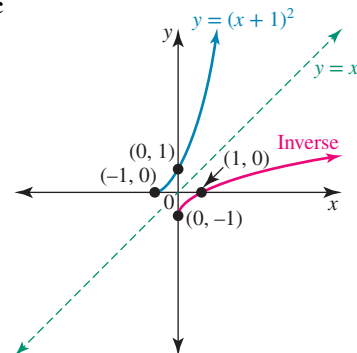

$$d \ f^{-1}: [0, \infty) \rightarrow \mathbb{R}, f^{-1}(x) = \sqrt{x} - 1$$

e The graphs do not intersect.

- 9 $f(x) = 2\sqrt{x+2}$ is a one-to-one mapping with $\text{dom} = [-2, \infty)$ and $\text{ran} = [0, \infty)$.

$f(x)$ and its inverse intersect where

$$\begin{aligned} 2\sqrt{x+2} &= x \\ 4(x+2) &= x^2 \\ 4x+8 &= x^2 \\ x^2-4x-8 &= 0 \\ x &= \frac{4 \pm \sqrt{(-4)^2 - 4 \times -8 \times 1}}{2} \end{aligned}$$

$$= \frac{4 \pm \sqrt{48}}{2}$$

$$= \frac{4 \pm 4\sqrt{3}}{2}$$

$$= 2 + 2\sqrt{3} \text{ as } x \in [-2, \infty)$$

When $x = 2 + 2\sqrt{3}$,

$$y = 2 + 2\sqrt{3}$$

$$\therefore \text{POI} = (2 + 2\sqrt{3}, 2 + 2\sqrt{3})$$

- 10 a $f: (-\infty, a] \rightarrow \mathbb{R}, f(x) = x^2 - 2x - 1$

To find the TP: $y = x^2 - 2x - 1$

$$y = x^2 - 2x + 1 - 2$$

$$y = (x-1)^2 - 2$$

The TP is at $(1, -2)$, so the largest possible value of a is 1.

Thus, $f: (-\infty, 1] \rightarrow \mathbb{R}, f(x) = x^2 - 2x - 1$.

b Inverse: swap x and y .

$$x = (y-1)^2 - 2$$

$$x+2 = (y-1)^2$$

$$\pm\sqrt{x+2} = y-1$$

$$y = -\sqrt{x+2} + 1 \text{ as } \text{dom } f = (-\infty, 1)$$

$$f^{-1}: [-2, \infty) \rightarrow \mathbb{R}, f^{-1}(x) = -\sqrt{x+2} + 1$$

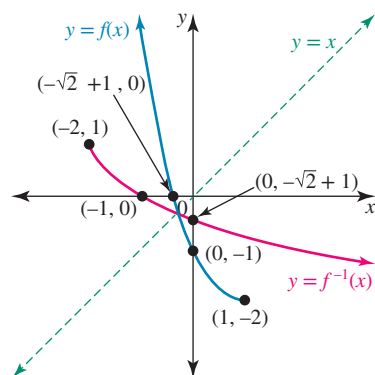

c $x = x^2 - 2x - 1$

$$0 = x^2 - 3x - 1$$

$$x = \frac{3 \pm \sqrt{(-3)^2 - 4 \times 1 \times -1}}{2}$$

$$= \frac{3 \pm \sqrt{13}}{2}$$

$$= \frac{3 - \sqrt{13}}{2}, \text{ dom } f = (-\infty, 1)$$

$$\text{Therefore, POI} = \left(\frac{3 - \sqrt{13}}{2}, \frac{3 - \sqrt{13}}{2} \right).$$

- 11 a $f: \mathbb{R} \rightarrow \mathbb{R}, f(x) = x^4$ is a many-to-one function. The inverse will be a one-to-many relation.

b $f: \mathbb{R} \rightarrow \mathbb{R}, f(x) = 2x^2 - 7x + 3$ is a many-to-one function. The inverse will be a one-to-many relation.

c $f: \mathbb{R} \setminus \{3\} \rightarrow \mathbb{R}, f(x) = \frac{1}{(x-3)^2} + 2$ is a many-to-one function. The inverse will be a one-to-many relation.

d $f: [-2, \infty) \rightarrow \mathbb{R}, f(x) = \sqrt{x+2}$ is a one-to-one function with $\text{dom} = [-2, \infty)$ and $\text{ran} = [0, \infty)$.

Inverse: swap x and y .

$$x = \sqrt{y+2}, x \in [0, \infty)$$

$$x^2 = y + 2$$

$$y = x^2 - 2 \text{ where } y \in [-2, \infty)$$

Thus, $f^{-1}: [0, \infty) \rightarrow \mathbb{R}, f^{-1}(x) = x^2 - 2$ where $y \in [-2, \infty)$.

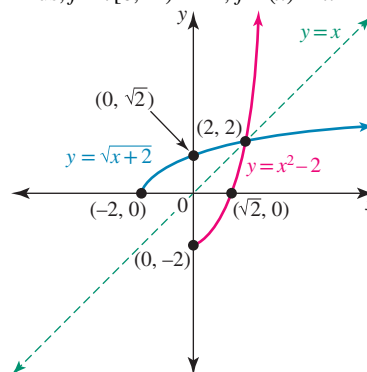

$$\begin{aligned} 12 \ f(x) &= \frac{4x-7}{x-2} \\ &= \frac{4(x-2)+1}{x-2} \\ &= \frac{4(x-2)}{x-2} + \frac{1}{x-2} \\ &= 4 + \frac{1}{x-2} \end{aligned}$$

$$f(x) = \frac{1}{x-2} + 4 \text{ where } \text{dom} = \mathbb{R} \setminus \{2\} \text{ and } \text{ran} = \mathbb{R} \setminus \{4\}$$

Inverse: swap x and y .

$$f^{-1}(x) = \frac{1}{x-4} + 2 \text{ where } \text{dom} = \mathbb{R} \setminus \{4\} \text{ and } \text{ran} = \mathbb{R} \setminus \{2\}$$

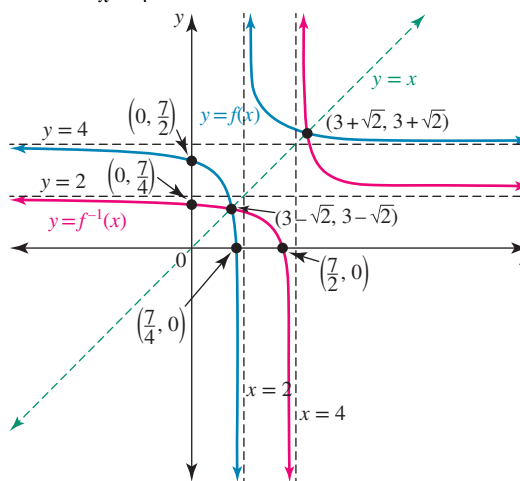

- 13 a $f(x) = (x+2)^2$. If the maximal domain is $(-\infty, -2]$, the inverse will be a function.

Inverse: swap x and y .

$$x = (y + 2)^2, x \in [0, \infty)$$

$$-\sqrt{x} = y + 2$$

$$y = -\sqrt{x} - 2 \text{ where } y \in (-\infty, -2]$$

Thus, $f^{-1}: [0, \infty) \rightarrow R, f^{-1}(x) = -\sqrt{x} - 2$ where $\text{ran} = (-\infty, -2]$.

14

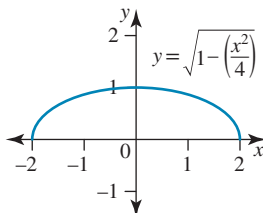

Two inverse functions are:

$$x = \sqrt{1 - \frac{y^2}{4}}$$

$$x^2 = 1 - \frac{y^2}{4}$$

$$x^2 + \frac{y^2}{4} = 1$$

$$\frac{y^2}{4} = 1 - x^2$$

$$\frac{y}{2} = \pm\sqrt{1 - x^2}$$

$$y = \pm 2\sqrt{1 - x^2}$$

Thus, we have

$f^{-1}: [0, 1] \rightarrow R, f^{-1}(x) = 2\sqrt{1 - x^2}$ where $\text{ran} = [0, 2]$ or

$f^{-1}: [0, 1] \rightarrow R, f^{-1}(x) = -2\sqrt{1 - x^2}$ where $\text{ran} = [-2, 0]$.

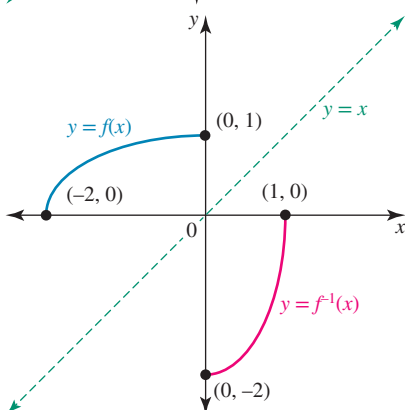
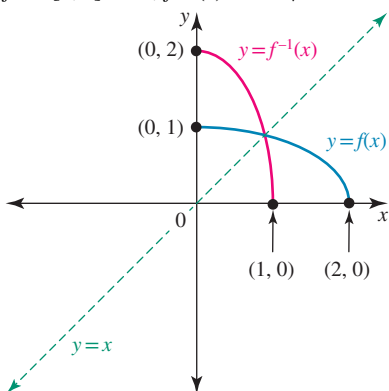

15 a $f(x) = x^2 - 10x + 25 = (x - 5)^2$, which is a many-to-one function. For the inverse to be a function, the domain must be restricted to $[5, \infty)$, so $a = 5$.

b Inverse: swap x and y .

$$x = (y - 5)^2 \text{ where } x \in [0, \infty)$$

$$\sqrt{x} = y - 5$$

$$y = \sqrt{x} + 5 \text{ where } y \in [5, \infty)$$

$f^{-1}: [0, \infty) \rightarrow R, f^{-1}(x) = \sqrt{x} + 5$ where $\text{ran} = [5, \infty)$

16 $f: [-2, 4) \rightarrow R, f(x) = 1 - \frac{x}{3}$

a $\text{dom} = [-2, 4)$ and $\text{ran} = \left(-\frac{1}{3}, \frac{5}{3}\right]$

b Inverse: swap x and y .

$$x = 1 - \frac{y}{3}$$

$$\frac{y}{3} = 1 - x$$

$$y = 3(1 - x)$$

$f^{-1}: \left(-\frac{1}{3}, \frac{5}{3}\right] \rightarrow R, f^{-1}(x) = 3(1 - x)$ where

$\text{ran} = [-2, 4)$

c

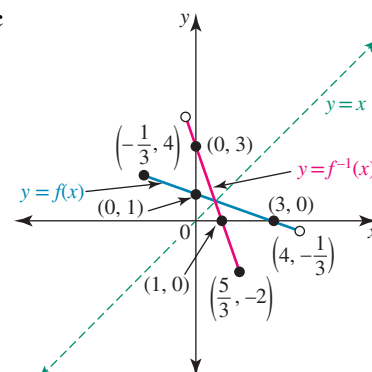

d $x = 1 - \frac{x}{3}$

$$3x = 3 - x$$

$$4x = 3$$

$$x = \frac{3}{4}$$

$\therefore \text{POI} = \left(\frac{3}{4}, \frac{3}{4}\right)$

17 a $f: D \rightarrow R, f(x) = \sqrt{1 - 3x}$

The maximal domain is $D = \left(-\infty, \frac{1}{3}\right]$.

b Inverse: swap x and y .

$$x = \sqrt{1 - 3y} \text{ where } x \in [0, \infty)$$

$$x^2 = 1 - 3y$$

$$3y = 1 - x^2$$

$$y = \frac{1}{3}(1 - x^2) \text{ where } \text{ran} = \left(-\infty, \frac{1}{3}\right]$$

$f^{-1}: [0, \infty) \rightarrow R, f^{-1}(x) = \frac{1}{3}(1 - x^2)$

where $\text{ran} = \left(-\infty, \frac{1}{3}\right]$

$$\begin{aligned}
 \text{c } x &= \sqrt{1-3x} \\
 x^2 &= 1-3x \\
 0 &= x^2 + 3x - 1 \\
 x &= \frac{-3 \pm \sqrt{(3)^2 - 4 \times 1 \times -1}}{2} \\
 &= \frac{-3 \pm \sqrt{13}}{2} \\
 &= \frac{-3 + \sqrt{13}}{2}, \text{ dom } f = [0, \infty) \\
 \therefore \text{POI} &= \left(\frac{-3 + \sqrt{13}}{2}, \frac{-3 + \sqrt{13}}{2} \right)
 \end{aligned}$$

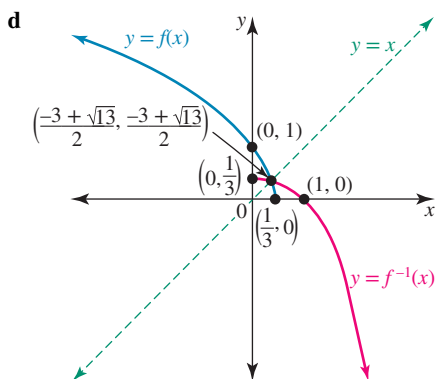

18 $f: [1, \infty) \rightarrow R, f(x) = \sqrt{x-1}$ where $\text{ran} = [0, \infty)$

a Inverse: swap x and y .

$$x = \sqrt{y-1} \quad x \geq 0, y \geq 1$$

$$y = x^2 + 1$$

$$f^{-1}: [0, \infty) \rightarrow R, f^{-1}(x) = x^2 + 1 \text{ where } \text{ran} = [1, \infty)$$

$$\begin{aligned}
 \text{b } f^{-1}(f(x)) &= f^{-1}(\sqrt{x-1}) \\
 &= (\sqrt{x-1})^2 + 1 \\
 &= x - 1 + 1 \\
 &= x \text{ where } \text{dom} = [1, \infty)
 \end{aligned}$$

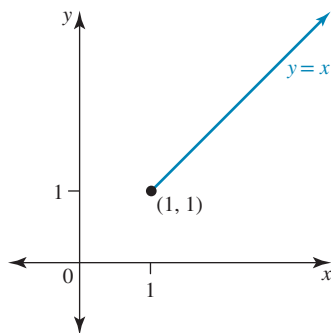

$$\begin{aligned}
 \text{c } f^{-1}\left(-f\left(\frac{x+2}{3}\right)\right) &= f^{-1}\left(-\sqrt{\frac{x+2}{3}-1}\right) \\
 &= f^{-1}\left(-\sqrt{\frac{x+2-3}{3}}\right) \\
 &= f^{-1}\left(-\sqrt{\frac{x-1}{3}}\right)
 \end{aligned}$$

$$\begin{aligned}
 &= \left(-\sqrt{\frac{x-1}{3}}\right)^2 + 1 \\
 &= \frac{x-1}{3} + 1 \\
 &= \frac{x-1+3}{3} \\
 &= \frac{x+2}{3}
 \end{aligned}$$

3.5 Exam questions

1 $f: (2, \infty) \rightarrow R$, where $f(x) = \frac{1}{(x-2)^2}$

$$\text{dom } f = (2, \infty) = \text{range } f^{-1} \text{ and } \text{dom } f^{-1} = (0, \infty) = \text{range } f$$

$$f: y = \frac{1}{(x-2)^2}$$

$$f^{-1}: x = \frac{1}{(y-2)^2} \Rightarrow (y-2)^2 = \frac{1}{x} \Rightarrow y = 2 \pm \frac{1}{\sqrt{x}}$$

Take the positive value, since $\text{range } f^{-1} = (2, \infty)$.

$$f^{-1}: (0, \infty) \rightarrow R, f^{-1}(x) = 2 + \frac{1}{\sqrt{x}}$$

Award 1 mark for transposing and rearranging the function.

Award 1 mark for the correct rule.

Award 1 mark for the correct domain of the inverse function.

VCAA Examination Report note:

Students appeared to manage this question confidently.

However, some students did not handle the algebraic manipulation correctly and others used incorrect notation, stating their final answer or in stating the domain.

2 $g: [3, \infty) \rightarrow R, g(x) = \sqrt{2x-6}$

$$\text{dom } g = \text{ran } g^{-1} = [3, \infty)$$

$$\text{dom } g^{-1} = \text{ran } g = [0, \infty)$$

$$g: y = \sqrt{2x-6}$$

$$g^{-1}: x = \sqrt{2y-6} \Rightarrow x^2 = 2y-6, y = g^{-1}(x) = \frac{x^2+6}{2}$$

$$g^{-1}: [0, \infty) \rightarrow R, g^{-1}(x) = \frac{x^2+6}{2}$$

The correct answer is **D**.

3 $f: (-2, \infty) \rightarrow R, f(x) = \frac{1}{\sqrt{x+2}}$

$$f: y = \frac{1}{\sqrt{x+2}}$$

$$f^{-1}: x = \frac{1}{\sqrt{y+2}}$$

$$\Rightarrow x^2 = \frac{1}{y+2} \Rightarrow y+2 = \frac{1}{x^2} \Rightarrow y = \frac{1}{x^2} - 2$$

$$\text{range } f = R^+ = \text{domain } f^{-1}$$

$$f^{-1}: R^+ \rightarrow R, f^{-1}(x) = \frac{1}{x^2} - 2$$

The correct answer is **A**.

3.6 Literal equations

3.6 Exercise

1 a $my - nx = 4x + kz$

$$my - kz = nx + 4x$$

$$my - kz = x(n + 4)$$

$$x = \frac{my - kz}{n + 4}$$

b $\frac{2p}{x} - \frac{m}{x-c} = \frac{3c}{x}$

$$2p(x - c) - mx = 3c(x - c)$$

$$2px - mx - 3cx = 2pc - 3c^2$$

$$x(2p - m - 3c) = 2pc - 3c^2$$

$$x = \frac{2pc - 3c^2}{2p - m - 3c}$$

2 $\frac{x - my}{px + y} = 2$

$$x - my = 2(px + y)$$

$$x - my = 2px + 2y$$

$$x - 2px = my + 2y$$

$$x(1 - 2p) = y(m + 2)$$

$$y = \frac{x(1 - 2p)}{m + 2}$$

3 a $\frac{kx + dy}{x + 3y} = -2k$

$$kx + dy = -2k(x + 3y)$$

$$kx + dy = -2kx - 6ky$$

$$kx + 2kx = -6ky - dy$$

$$3kx = -y(6k + d)$$

$$x = -\frac{y(6k + d)}{3k}$$

b $\frac{mx + ny}{p} = x + q$

$$mx - px = pq - ny$$

$$x(m - p) = pq - ny$$

$$x = \frac{pq - ny}{m - p}$$

c $\frac{m}{x} - k = \frac{3k}{x} + m$

$$m - kx = 3k + mx$$

$$m - 3k = mx + kx$$

$$m - 3k = x(m + k)$$

$$x = \frac{m - 3k}{m + k}$$

d $\frac{k}{m+x} = \frac{2d}{m-x}$

$$\frac{k}{m+x} = \frac{2d}{m-x}$$

$$k(m - x) = 2d(m + x)$$

$$km - kx = 2dm + 2dx$$

$$km - 2dm = 2dx + kx$$

$$m(k - 2d) = x(2d + k)$$

$$x = \frac{m(k - 2d)}{k + 2d}$$

4 b $\sqrt{ax} + cd = 3$

$$b\sqrt{ax} = 3 - cd$$

$$b^2ax = 9 - 6cd + c^2d^2$$

$$x = \frac{9 - 6cd + c^2d^2}{ab^2}$$

5 $x + y = 2k$ [1]

$$mx + ny = d$$
 [2]

From [1]:

$$y = 2k - x$$
 [3]

Substitute [3] into [2]:

$$mx + n(2k - x) = d$$

$$mx + 2nk - nx = d$$

$$mx - nx = d - 2nk$$

$$x(m - n) = d - 2nk$$

$$x = \frac{d - 2nk}{m - n}$$

Substitute $x = \frac{d - 2nk}{m - n}$ into [3]:

$$y = 2k - \frac{d - 2nk}{m - n}$$

$$y = \frac{2k(m - n) - d + 2nk}{m - n}$$

$$y = \frac{2km - d}{m - n}$$

6 a $nx - my = k$ [1]

$$nx + my = 2d$$
 [2]

[1] + [2]:

$$2nx = k + 2d$$

$$x = \frac{k + 2d}{2n}$$

Substitute $x = \frac{k + 2d}{2n}$ into [1]:

$$n\left(\frac{k + 2d}{2n}\right) - my = k$$

$$\frac{1}{2}(k + 2d) - my = k$$

$$\frac{1}{2}k + d - k = my$$

$$d - \frac{1}{2}k = my$$

$$y = \frac{2d - k}{2m}$$

b $nx + my = m$ [1]

$$mx + ny = n$$
 [2]

[1] $\times m$ and [2] $\times n$:

$$mnx + m^2y = m^2$$
 [3]

$$mnx + n^2y = n^2$$
 [4]

[3] - [4]:

$$m^2y - n^2y = m^2 - n^2$$

$$y(m^2 - n^2) = m^2 - n^2$$

$$y = \frac{m^2 - n^2}{m^2 - n^2}$$

$$y = 1$$

Substitute $y = 1$ into [1]:

$$nx + m(1) = m$$

$$nx = 0$$

$$x = 0$$

7 a $2mx + ny = 3k$ [1]

$mx + ny = -d$ [2]

[1] - [2]:

$$2mx - mx = 3k + d$$

$$mx = 3k + d$$

$$x = \frac{3k + d}{m}$$

Substitute $x = \frac{3k + d}{m}$ into [2]:

$$m \left(\frac{3k + d}{m} \right) + ny = -d$$

$$3k + d + ny = -d$$

$$ny = -2d - 3k$$

$$y = -\frac{2d + 3k}{n}$$

b $\frac{x}{2a} + \frac{y}{b} = 2$ [1]

$\frac{2x}{b} + \frac{4y}{a} = 8$ [2]

[1] $\times 2ab \Rightarrow xb + 2ay = 4ab$ [3]

[2] $\times ab \Rightarrow 2ax + 4by = 8ab$ [4]

[3] $\times 2a \Rightarrow 2abx + 4a^2y = 8a^2b$ [5]

[4] $\times b \Rightarrow 2abx + 4b^2y = 8ab^2$ [6]

[5] - [6]:

$$4a^2y - 4b^2y = 8a^2b - 8ab^2$$

$$a^2y - b^2y = 2a^2b - 2ab^2$$

$$y(a^2 - b^2) = 2ab(a - b)$$

$$y = \frac{2ab(a - b)}{(a - b)(a + b)}$$

$$= \frac{2ab}{a + b}$$

Substitute into [3]:

$$xb + 2a \left(\frac{2ab}{a + b} \right) = 4ab$$

$$xb + \frac{4a^2b}{a + b} = 4ab$$

$$xb(a + b) + 4a^2b = 4ab(a + b)$$

$$x(a + b) + 4a^2 = 4a(a + b)$$

$$x(a + b) = 4a^2 + 4ab - 4a^2$$

$$x = \frac{4ab}{a + b}$$

8 $2x - y + az = 4$ [1]

$(a + 2)x + y - z = 2$ [2]

$6x + (a + 1)y - 2z = 4$ [3]

Solve using CAS:

$$x = \frac{2(a + 2)}{a(a + 4)}, y = \frac{4(a + 2)}{a(a + 4)} \text{ and } z = \frac{4}{a}$$

3.6 Exam questions

1 $\frac{1}{x + a} = \frac{b}{x}$

$$x = b(x + a)$$

$$x = bx + ab$$

$$x - bx = ab$$

$$x(1 - b) = ab$$

$$x = \frac{ab}{1 - b}$$

The correct answer is **B**.

2 $mx + n = nx + m$

$$mx - nx = m - n$$

$$x(m - n) = m - n$$

$$x = 1$$

The correct answer is **E**.

3 $ax + by = r$ [1]

$ax - by = s$ [2]

[1] + [2]:

$$2ax = r + s$$

$$x = \frac{r + s}{2a}$$

[1] - [2]:

$$2by = r - s$$

$$y = \frac{r - s}{2b}$$

$$x = \frac{r + s}{2a}, y = \frac{-s + r}{2b}$$

The correct answer is **A**.

3.7 Review

3.7 Exercise

Technology free: short answer

1 $f(x) = \sqrt{x + 2}$ and $g(x) = 2x^2 - 5$

	Dom	Ran
$f(x)$	$[-2, \infty)$	$[0, \infty)$
$g(x)$	R	$[-5, \infty)$

Consider $f(g(x))$. The range of $g(x)$ is $[-5, \infty)$, which is not a subset of the domain of $f(x)$, which is $[-2, \infty)$. Therefore, $f(g(x))$ does not exist.

Consider $g(f(x))$. The range of $f(x)$ is $[0, \infty)$, which is a subset of the domain of $g(x)$, which is R . Therefore, $g(f(x))$ exists.

$$\begin{aligned} g(f(x)) &= g(\sqrt{x + 2}) \\ &= 2(\sqrt{x + 2})^2 - 5 \\ &= 2(x + 2) - 5 \\ &= 2x + 4 - 5 \\ &= 2x - 1 \end{aligned}$$

Domain of $g(f(x)) = \text{domain of } f(x) = [-2, \infty)$ The range is $[-5, \infty)$.

2 a In order to express $\frac{x-1}{x-2}$ in the form $\frac{m}{x-2} + n$, we need to

express $x-1$ in terms of $x-2$.

$$x-1 = x-2+1$$

Therefore,

$$\begin{aligned} \frac{x-1}{x-2} &= \frac{(x-2)+1}{x-2} \\ &= \frac{x-2}{x-2} + \frac{1}{x-2} \\ &= 1 + \frac{1}{x-2} \\ &= \frac{1}{x-2} + 1 \end{aligned}$$

So, $m = 1$ and $n = 1$.

b $y = \frac{1}{x} \rightarrow y = \frac{1}{x-2}$

Translation of 2 units to the right

$$y = \frac{1}{x-2} \rightarrow y = \frac{1}{x-2} + 1$$

Translation of 1 unit up

c $y = \frac{1}{x-2} + 1$

Asymptotes: $x = 2$ and $y = 1$

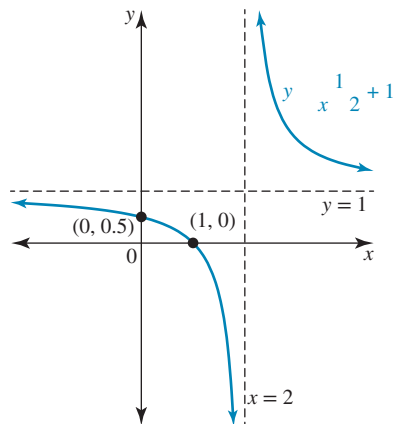

dom = $R \setminus \{2\}$ and ran = $R \setminus \{1\}$

d To find the rule for the inverse, swap x and y .

$$x = \frac{1}{y-2} + 1$$

$$x-1 = \frac{1}{y-2}$$

$$y-2 = \frac{1}{x-1}$$

$$y = \frac{1}{x-1} + 2$$

dom = $R \setminus \{1\}$ and ran = $R \setminus \{2\}$

e Since the inverse has a one-to-one correspondence, it is a one-to-one function.

f To find the POI of the inverse and the original graph, solve

$$x = \frac{x-1}{x-2}$$

$$x = \frac{x-1}{x-2}$$

$$x(x-2) = x-1$$

$$x^2 - 2x = x-1$$

$$x^2 - 3x + 1 = 0$$

$$x = \frac{3 \pm \sqrt{(-3)^2 - 4 \times 1 \times 1}}{2}$$

$$= \frac{3 \pm \sqrt{5}}{2}$$

$$\therefore \text{POI} = \left(\frac{3-\sqrt{5}}{2}, \frac{3-\sqrt{5}}{2} \right), \left(\frac{3+\sqrt{5}}{2}, \frac{3+\sqrt{5}}{2} \right)$$

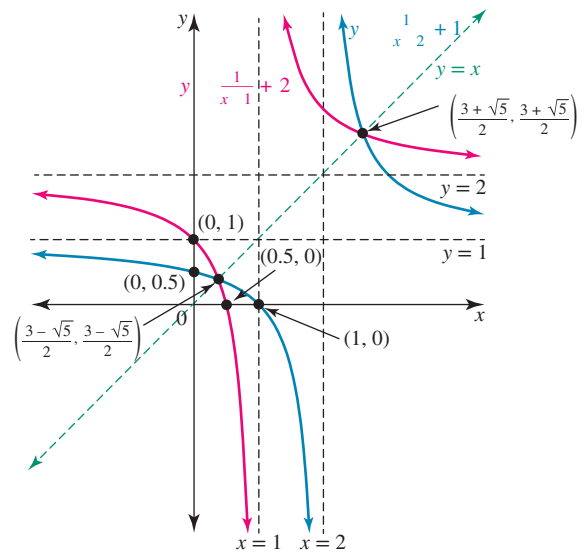

3 a $f: R \rightarrow R, f(x) = \frac{x^3}{3}$

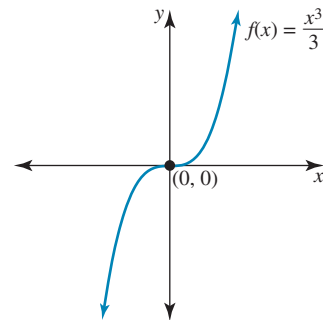

One-to-one inverse function

To find the rule for the inverse, swap x and y .

$$x = \frac{y^3}{3}$$

$$y^3 = 3x$$

$$y = \sqrt[3]{3x}$$

$$f^{-1}: R \rightarrow R, f^{-1}(x) = \sqrt[3]{3x}$$

b $f: \mathbb{R} \rightarrow \mathbb{R}, f(x) = 2x^4$

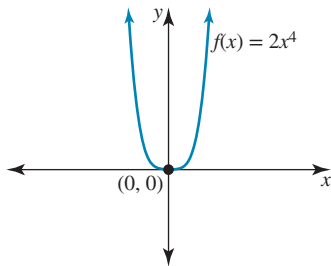

Not a function as a one-to-many mapping

c $f: \mathbb{R} \rightarrow \mathbb{R}, f(x) = (3x - 1)^2$

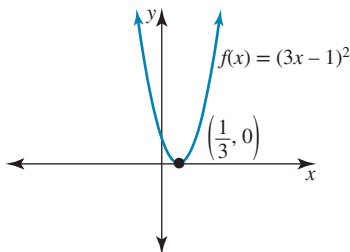

Not a function as a one-to-many mapping

d $f: [3, \infty) \rightarrow \mathbb{R}, f(x) = \sqrt{x - 3}$

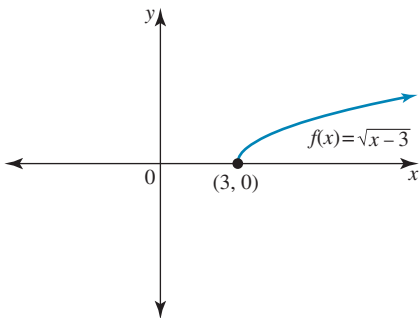

One-to-one inverse function

To find the rule for the inverse, swap x and y .

$$x = \sqrt{y - 3}$$

$$y - 3 = x^2$$

$$y = x^2 + 3$$

$$f^{-1}: [0, \infty) \rightarrow \mathbb{R}, f^{-1}(x) = x^2 + 3$$

4 a $f(x) = \sqrt{x}$

$$\rightarrow -\sqrt{x}$$

$$\rightarrow -\sqrt{\frac{x}{2}}$$

$$\rightarrow -\sqrt{\frac{x-3}{2}} - 1$$

$$\rightarrow -\frac{1}{2}\sqrt{\frac{x-3}{2}} - \frac{1}{2}$$

$$\therefore g(x) = -\frac{1}{2}\sqrt{\frac{x-3}{2}} - \frac{1}{2}$$

b $f(x) = (x - 2)^2$

$$\rightarrow (3x - 2)^2$$

$$\rightarrow -(3x - 2)^2$$

$$\rightarrow -(3(x + 3) - 2)^2 + 2 = -(3x + 7)^2 + 2$$

$$\therefore g(x) = -(3x + 7)^2 + 2$$

5 a $y = x^2 \rightarrow y = 3(2x - 5)^2 + 1$

$$y = 3(2x - 5)^2 + 1$$

$$= 3 \left(2 \left(x - \frac{5}{2} \right) \right)^2 + 1$$

Reading from left to right, the transformations are:

Dilation of factor 3 from the x -axis or parallel to the y -axis

Dilation of factor $\frac{1}{2}$ from the y -axis or parallel to the x -axis

Translation of $\frac{5}{2}$ units right and 1 unit up

Note: Other answers are possible.

b $y = -\sqrt[3]{\frac{5-x}{2}} + 1 \rightarrow \sqrt[3]{x}$

Need to undo all the existing transformations.

Translation down 1 unit:

$$y = -\sqrt[3]{\frac{5-x}{2}} + 1 \rightarrow y = -\sqrt[3]{\frac{5-x}{2}}$$

$$\text{Reflection in the } x\text{-axis: } y = -\sqrt[3]{\frac{5-x}{2}} \rightarrow y = \sqrt[3]{\frac{5-x}{2}}$$

$$\text{Reflection in the } y\text{-axis: } y = \sqrt[3]{\frac{5-x}{2}} \rightarrow y = \sqrt[3]{\frac{5+x}{2}}$$

Translation 5 units right:

$$y = \sqrt[3]{\frac{5+x}{2}} \rightarrow y = \sqrt[3]{\frac{5+(x-5)}{2}} = \sqrt[3]{\frac{x}{2}}$$

Dilation of factor $\frac{1}{2}$ from the y -axis or parallel to the x -axis:

$$y = \sqrt[3]{\frac{x}{2}} \rightarrow y = \sqrt[3]{\frac{2x}{2}} = \sqrt[3]{x}$$

Note: Other answers are possible.

6 Given that $\frac{5 - cd}{x + 2} = -\frac{2k}{x}$, solve the equation for x .

$$\frac{5 - cd}{x + 2} = -\frac{2k}{x}$$

$$\frac{5 - cd}{x + 2} \times \frac{x(x + 2)}{1} = -\frac{2k}{x} \times \frac{x(x + 2)}{1}$$

$$x(5 - cd) = -2k(x + 2)$$

$$5x - cdx = -2kx - 4k$$

$$5x - cdx + 2kx = -4k$$

$$x(5 - cd + 2k) = -4k$$

$$x = \frac{-4k}{5 - cd + 2k}$$

$$= \frac{4k}{cd - 2k - 5}$$

Technology active: multiple choice

7 Replace x with $h(x)$ in equation $g(x)$

$$g(h(x)) = 2(x + 1)^2 - 1$$

$$= 2(x^2 + 2x + 1) - 1$$

$$= 2x^2 + 4x + 2 - 1$$

$$= 2x^2 + 4x + 1$$

Therefore, the answer is **A**.

8

	Domain	Range
$f(x)$	$[1, \infty)$	$[1, \infty)$
$g(x)$	R	$[-1, \infty)$
$h(x)$	R	R

A: For $g(h(x))$ to be defined, $\text{ran } h \subseteq \text{dom } g$
 Since $R \subseteq R$, $g(h(x))$ is defined.

B: For $g(f(x))$ to be defined, $\text{ran } f \subseteq \text{dom } g$
 Since $[1, \infty) \subseteq R$, $g(f(x))$ is defined.

C: For $h(f(x))$ to be defined, $\text{ran } f \subseteq \text{dom } h$
 Since $[1, \infty) \subseteq R$, $h(f(x))$ is defined.

D: For $f(g(x))$ to be defined, $\text{ran } g \subseteq \text{dom } f$
 Since $[-1, \infty) \not\subseteq [1, \infty)$, $f(g(x))$ is not defined.

E: For $h(g(x))$ to be defined, $\text{ran } g \subseteq \text{dom } h$
 Since $[-1, \infty) \subseteq R$, $h(g(x))$ is defined.

Therefore, the correct answer is **D**.

9 For $g(h(x))$ to exist, $\text{ran } h \subseteq \text{dom } g$

Therefore, we want the range of $h(x)$ to be a subset of or equal to the domain of $g(x)$. So since the domain of $g(x)$ is $[1, \infty)$, the range of $h(x)$ must be a subset of $[1, \infty)$.

	Domain	Range
A	$R \setminus \{0\}$	$(1, \infty)$
B	R	$[0, \infty)$
C	$[-1, \infty)$	$(-\infty, 0]$
D	$R \setminus \{-1\}$	$R \setminus \{0\}$
E	R	R

Therefore, **A** is the only option where the domain range of $h(x)$ is a subset of or equal to the domain of $g(x)$ since $(1, \infty) \subseteq [1, \infty)$.

10 $y = -f(3x + 1) - 2$

$$= -f\left(3\left(x + \frac{1}{3}\right)\right) - 2$$

Transformations are:

Reflection in the x -axis. Point: $(3, 5) \rightarrow (3, -5)$

Dilation of factor $\frac{1}{3}$ from the y -axis or parallel to the x -axis.

Point: $(3, -5) \rightarrow (1, -5)$

Translation of $\frac{1}{3}$ units left and 2 units down.

Point: $(1, -5) \rightarrow \left(\frac{2}{3}, -7\right)$

So, the image of point $(3, 5)$ is $\left(\frac{2}{3}, -7\right)$.

Therefore, the answer is **C**.

11 Reflected in the x -axis: $y = \sin(x) \rightarrow y = -\sin(x)$

Dilated by a factor of 4 parallel to the y -axis or from the x -axis:

$$y = -\sin(x) \rightarrow y = -4 \sin(x)$$

Dilated by a factor of $\frac{1}{3}$ parallel to the x -axis or from the y -axis:

$$y = -4 \sin(x) \rightarrow y = -4 \sin(3x)$$

Therefore, the answer is **E**.

12 $f(x) = x^3 \rightarrow f(x) = \frac{1}{2}x^3$

Dilation by a factor of $\frac{1}{2}$ parallel to the y -axis or from the x -axis

$$f(x) = \frac{1}{2}x^3 \rightarrow f(x) = \frac{1}{2}(2x)^3$$

Dilation by a factor of $\frac{1}{2}$ parallel to the x -axis or from the y -axis

Translation of one unit in the positive x -direction

$$f(x) = \frac{1}{2}(2(x-1))^3 \rightarrow f(x) = \frac{1}{2}(2(x-1))^3 + 4$$

Translation of 4 units up

Therefore, the answer is **D**.

13 The rule for the graph shown would be $y = \frac{1}{x+1}$. Therefore, to find the rule for the inverse, swap x and y .

$$x = \frac{1}{y+1}$$

$$y+1 = \frac{1}{x}$$

$$y = \frac{1}{x} - 1$$

Therefore, the answer is **C**.

14 For $f(x)$ to have an inverse, it must be a one-to-one function.

Therefore, the domain needs to be restricted to make $f(x)$ a one-to-one function. To do this, first we need to find the turning point of the parabola.

$$f(x) = (x+1)(x-3)$$

$$= x^2 - 2x - 3$$

$$= (x^2 - 2x + 1) - 1 - 3$$

$$= (x-1)^2 - 4$$

Therefore, this parabola has a turning point at $(1, -4)$

Therefore, the maximal domain must be restricted to $[1, \infty)$

Therefore, the answer is **B**.

15 To find the rule for the inverse, swap x and y .

$$x = (y+1)^2$$

$$y+1 = \pm\sqrt{x}$$

$$y = \pm\sqrt{x} - 1$$

Next, we need to work out the domain and range of the inverse and then determine whether the positive or negative square root function is required.

$$\text{dom } f^{-1}(x) = \text{ran } f(x)$$

Therefore, the domain of $f^{-1}(x)$ is $[0, \infty)$.

$$\text{ran } f^{-1}(x) = \text{dom } f(x)$$

Therefore, the range of $f^{-1}(x)$ is $[-1, \infty)$ and the positive square root function is required.

$$\text{So, } f^{-1}: [0, \infty) \rightarrow R, f^{-1}(x) = \sqrt{x} - 1.$$

Therefore, the answer is **D**.

$$16 \quad \frac{p}{2x+n} = \frac{n}{2x+p}$$

$$p(2x+p) = n(2x+n)$$

$$2px + p^2 = 2nx + n^2$$

$$2px - 2nx = n^2 - p^2$$

$$x(2p-2n) = n^2 - p^2$$

$$x = \frac{n^2 - p^2}{(2p-2n)}$$

$$x = \frac{(n-p)(n+p)}{2(p-n)}$$

$$x = \frac{-(p-n)(n+p)}{2(p-n)}$$

$$x = \frac{-(n+p)}{2}$$

Therefore, the answer is **C**.

Technology active: extended response

17 a

	Dom	Ran
$f(x)$	R	$[-4, \infty)$
$g(x)$	$(2, \infty)$	$(0, \infty)$

For $f(g(x))$ to be defined, $\text{ran } g \subseteq \text{dom } f$.

Since $(0, \infty) \subseteq R$, $f(g(x))$ is defined.

b Replace x with $g(x)$ in equation $f(x)$.

$$\begin{aligned} f(g(x)) &= \left(\frac{1}{x-2}\right)^2 - 4 \\ &= \frac{1}{(x-2)^2} - 4 \end{aligned}$$

The domain of $f(g(x))$ will be equal to the domain of the inner function $g(x)$.

$$\text{dom} = (2, \infty)$$

Since $f(g(x))$ is a positive truncus and has an asymptote at $y = -4$, $\text{ran} = (-4, \infty)$.

c For $g(f(x))$ to be defined, $\text{ran } f \subseteq \text{dom } g$.

Since $[-4, \infty) \not\subseteq (2, \infty)$, $g(f(x))$ is not defined.

d To make $[-4, \infty)$, the range of $f(x)$, a subset of or equal to $(2, \infty)$, the domain of $g(x)$, it must be restricted to $(2, \infty)$.

Therefore, we want the range of $f(x)$ to be $(2, \infty)$. We then need to find the domain that gives this restriction.

$$x^2 - 4 = 2$$

$$x^2 = 6$$

$$x = \pm\sqrt{6}$$

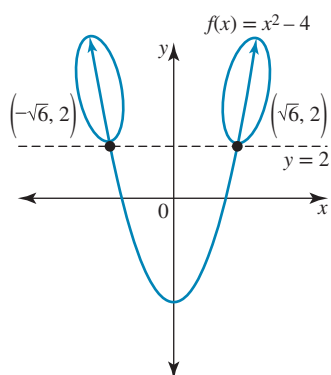

Therefore, for $x^2 - 4 > 2$, and the range of $f(x)$ to be restricted to $(2, \infty)$, $x \in (-\infty, -\sqrt{6}) \cup (\sqrt{6}, \infty)$.

Therefore,

$$f_1: (-\infty, -\sqrt{6}) \cup (\sqrt{6}, \infty) \rightarrow R, f_1(x) = x^2 - 4$$

$$\begin{aligned} \text{e } g(f_1(x)) &= \frac{1}{x^2 - 4 - 2} \\ &= \frac{1}{x^2 - 6} \end{aligned}$$

The domain of $g(f_1(x))$ will be the domain of the inner function $f_1(x)$.

Therefore, the domain is $(-\infty, -\sqrt{6}) \cup (\sqrt{6}, \infty)$.

$$18 \text{ a } f(x) = \sqrt{3(x-2)} - 1$$

Therefore, the graph has an end point at $(2, -1)$, so the maximal domain would be $[2, \infty)$.

$$\therefore D = [2, \infty)$$

$$\text{b } f(x) = \sqrt{x} \rightarrow f(x) = \sqrt{3x}$$

Dilated by a factor of $\frac{1}{3}$ parallel to the x -axis or from the y -axis

$$f(x) = \sqrt{3x} \rightarrow f(x) = \sqrt{3(x-2)}$$

Translated 2 units to the right or in the positive x -direction

$$f(x) = \sqrt{3(x-2)} \rightarrow f(x) = \sqrt{3(x-2)} - 1$$

Translated 1 unit down or in the negative y -direction

c To find the inverse, swap x and y .

$$x = \sqrt{3y-6} - 1$$

$$\sqrt{3y-6} = x + 1$$

$$3y - 6 = (x + 1)^2$$

$$3y = (x + 1)^2 + 6$$

$$y = \frac{1}{3}((x + 1)^2 + 6)$$

$$y = \frac{1}{3}(x + 1)^2 + 2$$

$$f^{-1}(x) = \frac{1}{3}(x + 1)^2 + 2$$

Since the domain of f is $[2, \infty)$, the range of f^{-1} is $[2, \infty)$.

Since the range of f is $[-1, \infty)$, the domain of f^{-1} is $[-1, \infty)$.

Therefore, $f^{-1}: [-1, \infty) \rightarrow R, f^{-1}(x) = \frac{1}{3}(x + 1)^2 + 2$.

d

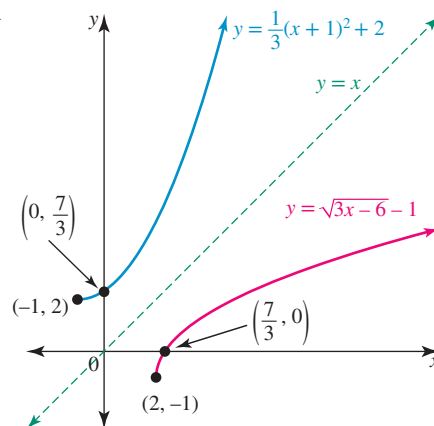

19 For $f: [3, \infty) \rightarrow R, f(x) = x^2 + k$, the domain is $[3, \infty)$. In order to work out the range, substitute $x = 3$ into $f(x)$.

$$f(3) = 3^2 + k$$

$$= 9 + k$$

Therefore, the endpoint is $(3, 9 + k)$ and the range is $[9 + k, \infty)$.

For $g: [2, \infty) \rightarrow R, g(x) = \frac{1}{x} + k$,

the domain is $[2, \infty)$. In order to work out the range, substitute $x = 2$ into $g(x)$.

$$g(2) = \frac{1}{2} + k$$

Therefore, the endpoint is $(2, \frac{1}{2} + k)$ and the range is

$$\left(k, \frac{1}{2} + k\right).$$

	Domain	Range
$f(x)$	$[3, \infty]$	$[9 + k, \infty]$
$g(x)$	$[2, \infty]$	$\left(k, \frac{1}{2} + k\right]$

For $f(g(x))$ to be defined, $\text{ran } g \subseteq \text{dom } f$.

Therefore, $\left(k, \frac{1}{2} + k\right) \subseteq [3, \infty)$.

So, $k \geq 3$.

For $g(f(x))$ to be defined, $\text{ran } f \subseteq \text{dom } g$.

Therefore, $[9 + k, \infty) \subseteq [2, \infty)$.

So,

$$9 + k \geq 2$$

$$k \geq -7$$

Therefore, applying both conditions, $k \geq 3$ and $k \geq -7$. The overall possible values for k such that both $f(g(x))$ and $g(f(x))$ are defined are $k \geq 3$.

- 20 a Positive parabola with a turning point at $(3, 0)$ or translated 3 units right

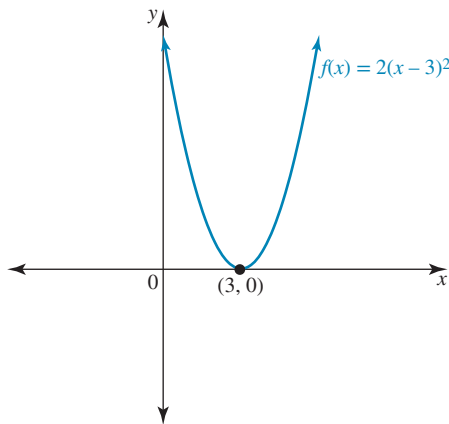

The domain of f is R and the range of f is $[0, \infty)$.

- b To find the rule for the inverse, swap x and y .

$$x = 2(y - 3)^2$$

$$(y - 3)^2 = \frac{x}{2}$$

$$y - 3 = \pm \sqrt{\frac{x}{2}}$$

$$y = \pm \sqrt{\frac{x}{2}} + 3$$

$\text{dom} = [0, \infty)$ and $\text{ran} = R$

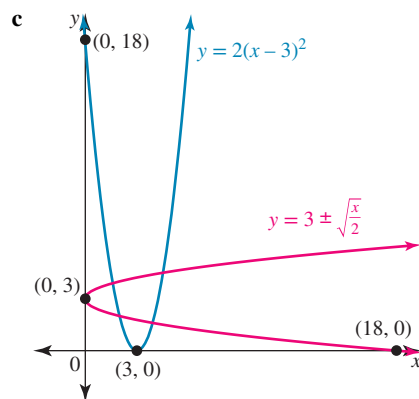

- d The domain of f needs to be restricted at its turning point so that the inverse is also a function. Therefore, the domain of f must be $[3, \infty)$.

- e Therefore, $f: [3, \infty) \rightarrow R, f(x) = 2(x - 3)^2$.

Since the range of f^{-1} is equal to the domain of f , it is $[3, \infty)$. Therefore, the positive square root function is required.

$$f^{-1}: [0, \infty) \rightarrow R, f(x) = \sqrt{\frac{x}{2}} + 3$$

- f POI: Solve $x = f(x)$.

$$x = 2(x - 3)^2$$

$$x = 2(x^2 - 6x + 9)$$

$$x = 2x^2 - 12x + 18$$

$$0 = 2x^2 - 13x + 18$$

$$0 = (2x - 9)(x - 2)$$

$$x = \frac{9}{2}, 2$$

Because $\text{ran } f^{-1} = [3, \infty)$, $x = \frac{9}{2}$.

$$\therefore \text{POI} = \left(\frac{9}{2}, \frac{9}{2}\right)$$

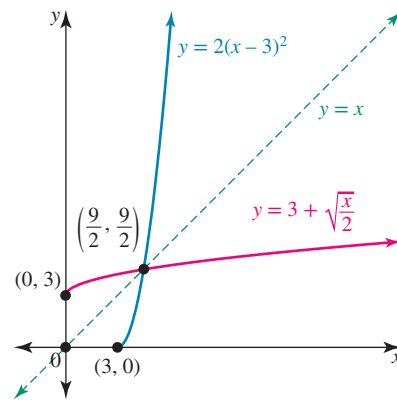

g $f(f^{-1}(x)) = 2\left(\sqrt{\frac{x}{2}} + 3 - 3\right)^2$

$$= 2\left(\sqrt{\frac{x}{2}}\right)^2$$

$$= 2 \times \frac{x}{2}$$

$$= x$$

3.7 Exam questions

1 $f(g(3)) = f(2) = 5$

The correct answer is **E**.

- 2 The inverse function is the graph reflected in the line $y = x$.

The correct answer is **E**.

- 3 A is on $f(x)$; P is on $g(x) = \frac{1}{2}f(x - 1)$.

Dilate by a factor of $\frac{1}{2}$ from the x -axis:

$$(x, y) \rightarrow \left(x, \frac{y}{2}\right), A(3, 2) \rightarrow (3, 1)$$

Translation of one unit in the positive x -direction:

$$\left(x, \frac{y}{2}\right) \rightarrow \left(x + 1, \frac{y}{2}\right), (3, 1) \rightarrow P(4, 1)$$

The correct answer is **C**.

$$4 \text{ a } f: R \setminus \left\{ \frac{1}{3} \right\} \rightarrow R, f(x) = \frac{1}{3x-1}$$

$$f: y = \frac{1}{3x-1}$$

Swap x and y .

$$f^{-1}: x = \frac{1}{3y-1}$$

$$3y-1 = \frac{1}{x}$$

$$y = f^{-1}(x) = \frac{1}{3x} + \frac{1}{3} = \frac{x+1}{3x}$$

Award 1 mark for swapping x and y and making y the subject.

Award 1 mark for the correct result.

$$\text{b Domain of } f^{-1} = \text{range of } f = R \setminus \{0\}$$

$$5 \text{ a } f: [0, \infty) \rightarrow R, f(x) = \sqrt{x+1}$$

$$\text{dom } f = [0, \infty), \text{ran } f = [1, \infty)$$

$$\text{b i } g: (-\infty, c] \rightarrow R, g(x) = x^2 + 4x + 3 = (x+2)^2 - 1$$

$$x^2 + 4x + 3 = (x+3)(x+1) \geq 0 \Rightarrow x = -3, -1$$

So $c = -3$, so the range of $g \subseteq [0, \infty)$.

Award 1 mark for finding the x -intercepts or a graph with the x -intercepts labelled.

Award 1 mark for the correct value of c .

ii Since $(-\infty, -3]$ is the domain of g , the range of g becomes $[0, \infty)$, which is the same as the domain of f .

Therefore, the range of f is the same as the range of

$f(g(x))$.

$$f(g(x))$$

$$= f(x^2 + 4x + 3)$$

$$= \sqrt{x^2 + 4x + 4}$$

$$= \sqrt{(x+2)^2}$$

$$= |x+2|$$

$$= -x-2 \text{ since } x \leq -3$$

$$\text{dom } f(g(x)) = \text{dom } g(x) = (-\infty, -3)$$

$$\text{So } \text{ran } f(g(x)) = [1, \infty).$$

$$\text{c } h: R \rightarrow R, h(x) = x^2 + 3$$

$$f(h(x))$$

$$= f(x^2 + 3)$$

$$= \sqrt{x^2 + 3 + 1}$$

$$= \sqrt{x^2 + 4}$$

$$\text{dom } (h(x)) = R$$

$$\text{ran } (h(x)) = [3, \infty)$$

$$\therefore \text{dom } (g(x)) = [3, \infty)$$

$$\text{ran } f(h(x)) = [2, \infty)$$

Topic 4 — Exponential and logarithmic functions

4.2 Logarithm laws and equations

4.2 Exercise

1 a $6^3 = 216$

$$\log_6(216) = 3$$

b $2^8 = 256$

$$\log_2(256) = 8$$

c $3^4 = 81$

$$\log_3(81) = 4$$

d $10^{-4} = 0.0001$

$$\log_{10}(0.0001) = -4$$

e $5^{-3} = 0.008$

$$\log_5(0.008) = -3$$

f $7^1 = 7$

$$\log_7(7) = 1$$

2 a $\log_7(49) + \log_2(32) - \log_5(125)$

$$= \log_7(7)^2 + \log_2(2)^5 - \log_5(5)^3$$

$$= 2 \log_7(7) + 5 \log_2(2) - 3 \log_5(5)$$

$$= 2 + 5 - 3$$

$$= 4$$

b $5 \log_{11}(6) - 5 \log_{11}(66)$

$$= 5(\log_{11}(6) - \log_{11}(66))$$

$$= 5 \left(\log_{11} \left(\frac{6}{66} \right) \right)$$

$$= 5 \left(\log_{11} \left(\frac{1}{11} \right) \right)$$

$$= 5 \log_{11}(11)^{-1}$$

$$= -5$$

c $\frac{\log_4(25)}{\log_4(625)}$

$$= \frac{\log_4(5)^2}{\log_4(5)^4}$$

$$= \frac{2 \log_4(5)}{4 \log_4(5)}$$

$$= \frac{1}{2}$$

d $\log_2 \left(\sqrt[7]{\frac{1}{128}} \right)$

$$= \log_2 \left((2^{-7})^{\frac{1}{7}} \right)$$

$$= \log_2(2)^{-1}$$

$$= -1$$

3 a $7 \log_4(x) - 9 \log_4(x) + 2 \log_4(x) = 0$

b $\log_7(2x - 1) + \log_7(2x - 1)^2$

$$= \log_7(2x - 1) + 2 \log_7(2x - 1)$$

$$= 3 \log_7(2x - 1)$$

c $\log_{10}(x - 1)^3 - 2 \log_{10}(x - 1)$

$$= 3 \log_{10}(x - 1) - 2 \log_{10}(x - 1)$$

$$= \log_{10}(x - 1)$$

4 a $\log_2(256) + \log_2(64) - \log_2(128)$

$$= \log_2 \left(\frac{256 \times 64}{128} \right)$$

$$= \log_2(2 \times 2^6)$$

$$= \log_2(2)^7$$

$$= 7 \log_2(2)$$

$$= 7$$

b $5 \log_7(49) - 5 \log_7(343)$

$$= 5(\log_7(49) - \log_7(343))$$

$$= 5 \log_7 \left(\frac{49}{343} \right)$$

$$= 5 \log_7 \left(\frac{7^2}{7^3} \right)$$

$$= 5 \log_7 \left(\frac{1}{7} \right)$$

$$= 5 \log_7(7)^{-1}$$

$$= -5 \log_7(7)$$

$$= -5$$

c $\log_4 \left(\sqrt[6]{\frac{1}{64}} \right)$

$$= \log_4((2)^{-6})^{\frac{1}{6}}$$

$$= \log_4(2)^{-1}$$

$$= \log_4(4)^{-\frac{1}{2}}$$

$$= -\frac{1}{2} \log_4(4)$$

$$= -\frac{1}{2}$$

d $\log_4 \left(\frac{16}{256} \right)$

$$= \log_4 \left(\frac{4^2}{4^4} \right)$$

$$= \log_4 \left(\frac{1}{16} \right)$$

$$= \log_4(4)^{-2}$$

$$= -2 \log_4(4)$$

$$= -2$$

e $\frac{\log_5(32)}{3 \log_5(16)}$

$$= \frac{\log_2(2)^5}{3 \log_2(2)^4}$$

$$= \frac{5 \log_2(2)}{12 \log_2(2)}$$

$$= \frac{5}{12}$$

f $\frac{6 \log_2(\sqrt[3]{x})}{\log_2(x^5)}$

$$= \frac{6 \log_2(x)^{\frac{1}{3}}}{\log_2(x^5)}$$

$$\begin{aligned}
 &= \frac{6 \log_2(x)^{\frac{1}{3}}}{\log_2(x)^5} \\
 &= \frac{2 \log_2(x)}{5 \log_2(x)} \\
 &= \frac{2}{5}
 \end{aligned}$$

5 a $\log_3(x-4) + \log_3(x-4)^2$

$$\begin{aligned}
 &= \log_3(x-4) + 2 \log_3(x-4) \\
 &= 3 \log_3(x-4)
 \end{aligned}$$

b $\log_e(2x+3)^3 - 2 \log_e(2x+3)$

$$\begin{aligned}
 &= 3 \log_e(2x+3) - 2 \log_e(2x+3) \\
 &= \log_e(2x+3)
 \end{aligned}$$

c $\log_5(x)^2 + \log_5(x)^3 - 5 \log_5(x)$

$$\begin{aligned}
 &= 2 \log_5(x) + 3 \log_5(x) - 5 \log_5(x) \\
 &= 0
 \end{aligned}$$

d $\log_4(5x+1) + \log_4(5x+1)^3 - \log_4(5x+1)^2$

$$\begin{aligned}
 &= \log_4(5x+1) + 3 \log_4(5x+1) - 2 \log_4(5x+1) \\
 &= 2 \log_4(5x+1)
 \end{aligned}$$

6 a $\log_5(125) = x$

$$5^x = 125$$

$$5^x = 5^3$$

$$\therefore x = 3$$

b $\log_4(x-1) + 2 = \log_4(x+4)$

$$\log_4(x-1) + 2 \log_4 4 = \log_4(x+4)$$

$$\log_4(x-1) + \log_4 4^2 = \log_4(x+4)$$

$$\log_4(16(x-1)) = \log_4(x+4)$$

$$16(x-1) = x+4$$

$$16x - 16 = x + 4$$

$$15x = 20$$

$$x = \frac{4}{3}$$

c $3(\log_2(x))^2 - 2 = 5 \log_2(x)$

$$3(\log_2(x))^2 - 5 \log_2(x) - 2 = 0$$

$$(3 \log_2(x) + 1)(\log_2(x) - 2) = 0$$

$$3 \log_2(x) + 1 = 0 \text{ or } \log_2(x) - 2 = 0$$

$$\log_2(x) = -\frac{1}{3} \quad \log_2(x) = 2$$

$$x = 2^{-\frac{1}{3}} \quad x = 4$$

d $\log_e(4x) + \log_e(x-3) = \log_e(7)$

$$\log_e(4x(x-3)) = \log_e(7)$$

$$4x(x-3) = 7$$

$$4x^2 - 12x - 7 = 0$$

$$(2x-7)(2x+1) = 0$$

$$x = \frac{7}{2}, -\frac{1}{2}$$

$$x = -\frac{1}{2} \text{ isn't a valid solution as } x > 3.$$

$$\text{Therefore, } x = \frac{7}{2}.$$

7 a $\log_3(x) = 5$

$$3^5 = x$$

$$x = 243$$

b $\log_3(x-2) - \log_3(5-x) = 2$

$$\log_3\left(\frac{x-2}{5-x}\right) = 2$$

$$3^2 = \frac{x-2}{5-x}$$

$$9 = \frac{x-2}{5-x}$$

$$9(5-x) = x-2$$

$$45 - 9x = x - 2$$

$$47 = 10x$$

$$x = \frac{47}{10}$$

8 a $\log_3(81) = x$

$$3^x = 81$$

$$3^x = 3^4$$

$$x = 4$$

b $\log_6\left(\frac{1}{216}\right) = x$

$$6^x = \frac{1}{216}$$

$$6^x = 6^{-3}$$

$$x = -3$$

c $\log_x(121) = 2$

$$x^2 = 121$$

$$x^2 = 11^2$$

$$x = 11$$

d $\log_2(-x) = 7$

$$2^7 = -x$$

$$128 = -x$$

$$x = -128$$

9 a $\log_e(2x-1) = -3$

$$e^{-3} = 2x - 1$$

$$e^{-3} + 1 = 2x$$

$$x = \frac{1}{2}(e^{-3} + 1)$$

b $\log_e\left(\frac{1}{x}\right) = 3$

$$\log_e(x)^{-1} = 3$$

$$-\log_e(x) = 3$$

$$\log_e(x) = -3$$

$$x = e^{-3}$$

c $\log_3(4x-1) = 3$

$$3^3 = 4x - 1$$

$$27 + 1 = 4x$$

$$28 = 4x$$

$$x = 7$$

d $\log_{10}(x) - \log_{10}(3) = \log_{10}(5)$

$$\log_{10}\left(\frac{x}{3}\right) = \log_{10}(5)$$

$$\frac{x}{3} = 5$$

$$x = 15$$

e $3 \log_{10}(x) + 2 = 5 \log_{10}(x)$

$$2 = 5 \log_{10}(x) - 3 \log_{10}(x)$$

$$2 = 2 \log_{10}(x)$$

$$1 = \log_{10}(x)$$

$$x = 10$$

$$\mathbf{f} \log_{10}(x^2) - \log_{10}(x+2) = \log_{10}(x+3)$$

$$\log_{10}\left(\frac{x^2}{x+2}\right) = \log_{10}(x+3)$$

$$\frac{x^2}{x+2} = x+3$$

$$x^2 = (x+3)(x+2)$$

$$x^2 = x^2 + 5x + 6$$

$$0 = 5x + 6$$

$$x = -\frac{6}{5}$$

$$\mathbf{10 a} \quad 2 \log_e(x) - \log_e(2x-3) = \log_e x - 2$$

$$\log_e(x)^2 - \log_e(2x-3) = \log_e(x-2)$$

$$\log_e\left(\frac{x^2}{2x-3}\right) = \log_e(x-2)$$

$$\frac{x^2}{2x-3} = x-2$$

$$x^2 = (x-2)(2x-3)$$

$$x^2 = 2x^2 - 7x + 6$$

$$0 = x^2 - 7x + 6$$

$$0 = (x-1)(x-6)$$

$$x = 1 \quad x = 6$$

$$\mathbf{b} \log_{10}(2x) - \log_{10}(x-1) = 1$$

$$\log_{10}\left(\frac{2x}{x-1}\right) = 1$$

$$10 = \frac{2x}{x-1}$$

$$10(x-1) = 2x$$

$$10x - 10 = 2x$$

$$10x - 2x = 10$$

$$8x = 10$$

$$x = \frac{5}{4}$$

$$\mathbf{c} \log_3(x) + 2 \log_3(4) - \log_3(2) = \log_3(10)$$

$$\log_3(x) + \log_3(4)^2 - \log_3(2) = \log_3(10)$$

$$\log_3(16x) - \log_3(2) = \log_3(10)$$

$$\log_3\left(\frac{16x}{2}\right) = \log_3(10)$$

$$8x = 10$$

$$x = \frac{5}{4}$$

$$\mathbf{d} \quad (\log_{10}(x))(\log_{10}(x)^2) - 5 \log_{10}(x) + 3 = 0$$

$$(\log_{10}(x))(2 \log_{10}(x)) - 5 \log_{10}(x) + 3 = 0$$

$$2(\log_{10}(x))^2 - 5 \log_{10}(x) + 3 = 0$$

$$\text{Let } a = \log_{10}(x).$$

$$2a^2 - 5a + 3 = 0$$

$$(2a-3)(a-1) = 0$$

$$\text{Substitute back for } a = \log_{10}(x).$$

$$(2 \log_{10}(x) - 3)(\log_{10}(x) - 1) = 0$$

$$2 \log_{10}(x) - 3 = 0 \quad \text{or} \quad \log_{10}(x) - 1 = 0$$

$$2 \log_{10}(x) = 3 \quad \log_{10}(x) = 1$$

$$\log_{10}(x) = \frac{3}{2} \quad 10^1 = x$$

$$x = 10^{\frac{3}{2}} \quad x = 10$$

$$\mathbf{e} \quad (\log_e(x))^2 = \log_e(x) + 2$$

$$(\log_e(x))^2 - \log_e(x) - 2 = 0$$

$$(\log_e(x) - 2)(\log_e(x) + 1) = 0$$

$$\log_e(x) - 2 = 0 \quad \text{or} \quad \log_e(x) + 1 = 0$$

$$\log_e(x) = 2 \quad \log_e(x) = -1$$

$$x = e^2 \quad x = e^{-1}$$

$$x = \frac{1}{e}$$

$$\mathbf{f} \log_6(x-3) + \log_6(x+2) = 1$$

$$\log_6(x-3)(x+2) = 1$$

$$6 = (x-3)(x+2)$$

$$6 = x^2 - x - 6$$

$$0 = x^2 - x - 12$$

$$0 = (x-4)(x+3)$$

$$x-4 = 0 \quad \text{or} \quad x+3 = 0$$

$$x = 4 \quad x = -3$$

$$\text{But } x > 3, \therefore x = 4$$

$$\mathbf{11 a} \quad \log_5(9) = \frac{\log_{10}(9)}{\log_{10}(5)}$$

$$\mathbf{b} \quad \log_{\frac{1}{2}}(12) = \frac{\log_{10}(12)}{\log_{10}\left(\frac{1}{2}\right)}$$

$$\mathbf{12 a i} \quad \log_7(12) = 1.2770 \quad (\text{using CAS})$$

$$\mathbf{ii} \quad \log_3\left(\frac{1}{4}\right) = -1.2619 \quad (\text{using CAS})$$

$$\mathbf{b} \quad z = \log_3(x)$$

$$3^z = x$$

$$\mathbf{i} \quad 2x = 2 \times 3^z$$

$$\mathbf{ii} \quad \log_x(27) = \frac{\log_3(27)}{\log_3(x)}$$

$$= \frac{\log_3(3)^3}{\log_3(x)}$$

$$= \frac{3 \log_3(3)}{\log_3(x)}$$

$$= \frac{3}{z}$$

$$\mathbf{13 a} \quad \log_5(7) = 1.7712$$

$$\mathbf{b} \quad \log_2\left(\frac{1}{121}\right) = -6.9189$$

$$\mathbf{14} \quad \text{If } n - \log_5(x), \text{ then } 5^n = x.$$

$$\mathbf{a} \quad 5x = 5 \times 5^n = 5^{n+1}$$

$$\mathbf{b} \quad \log_5(5x^2) = \log_5(5 \times (5^n)^2)$$

$$= \log_5(5 \times 5^{2n})$$

$$= \log_5(5)^{2n+1}$$

$$= (2n+1) \log_5(5)$$

$$= 2n+1$$

$$\mathbf{c} \quad \log_x(625)$$

$$= \frac{\log_5(625)}{\log_5(x)}$$

$$= \frac{\log_5(5^4)}{n}$$

$$= \frac{4}{n}$$

$$\mathbf{15 a} \quad e^{2x} - 3 = \log_e(2x+1)$$

$$\text{Solve using CAS.}$$

$$x = -0.463, 0.675$$

b $x^2 - 1 = \log_e(x)$

Solve using CAS.

$x = 0.451, 1$

16 $(3 \log_3(x))(5 \log_3(x)) = 11 \log_3(x) - 2$

Solve using CAS.

$x = 1.5518, 1.4422$

17 a $\log_{10}(y) = 2 \log_{10} 2 - 3 \log_{10}(x)$

$\log_{10}(y) = \log_{10} 2^2 - \log_{10}(x)^3$

$\log_{10}(y) = \log_{10} \left(\frac{4}{x^3} \right)$

$y = \frac{4}{x^3}$

b $\log_4(y) = -2 + 2 \log_4(x)$

$\log_4(y) = 2 \log_4(x) - 2 \log_4(4)$

$\log_4(y) = \log_4(x)^2 - \log_4(4^2)$

$\log_4(y) = \log_4 \left(\frac{x^2}{16} \right)$

$y = \frac{x^2}{16}$

18 a $\log_9(3xy) = 1.5$

$\log_9(3xy) = \frac{3}{2} \log_9 9$

$\log_9(3xy) = \log_9(3^2)^{\frac{3}{2}}$

$\log_9(3xy) = \log_9 3^3$

$3xy = 27$

$xy = 9$

$y = \frac{9}{x}$

b $\log_8 \left(\frac{2x}{y} \right) + 2 = \log_8(2)$

$\log_8 \left(\frac{2x}{y} \right) + 2 \log_8(8) = \log_8(2)$

$\log_8 \left(\frac{2x}{y} \right) + \log_8(8)^2 = \log_8(2)$

$\log_8 \left(\frac{128x}{y} \right) = \log_8(2)$

$\frac{128x}{y} = 2$

$y = 64x$

19 $8 \log_x(4) = \log_2(x)$

$\frac{8 \log_2(4)}{\log_2(x)} = \frac{\log_2(x)}{\log_2(2)}$

$8 \log_2(4) \times \log_2(2) = [\log_2(x)]^2$

$8 \log_2(2^2) \times \log_2(2) = [\log_2(x)]^2$

$16 \log_2(2) \times \log_2(2) = [\log_2(x)]^2$

$16 = [\log_2(x)]^2$

$\log_2(x) = \pm 4$

$x = 2^4, 2^{-4}$

$= 16, \frac{1}{16}$

20 a $3 \log_m(x) = 3 \log_m(27)$

$3 \log_m(x) = 3 \log_m(m) + \log_m(3)^3$

$3 \log_m(x) = 3 \log_m(m) + 3 \log_m(3)$

$\log_m(x) = \log_m(m) + \log_m(3)$

$\log_m(x) = \log_m(3m)$

$x = 3m$

b If $x = \log_{10}(m)$ and $y = \log_{10}(n)$, then $10^x = m$ and $10^y = n$

$\log_{10} \left(\frac{100n^2}{m^5\sqrt{n}} \right) = \log_{10} \left(\frac{100(10^y)^2}{(10^x)^5(10^{\frac{1}{2}})^2} \right)$

$= \log_{10} \left(\frac{10^2 \times 10^{2y}}{10^{5x} \times 10^{\frac{1}{2}} \times 10^{\frac{1}{2}}} \right)$

$= \log_{10} \left(\frac{10^2 \times 10^{\frac{3y}{2}}}{10^{5x}} \right)$

$= \log_{10} \left(10^{2 + \frac{3y}{2} - 5x} \right)$

$= \left(2 + \frac{3y}{2} - 5x \right) \log_{10}(10)$

$= 2 + \frac{3y}{2} - 5x$

21 a $13 + \log_9(0.2^{x^3}) > 7$

$x^3 \log_9(0.2) > -6$

$x^3 < -\frac{6}{\log_9(0.2)}$

$x < \sqrt[3]{-\frac{6}{\log_9(0.2)}}$

$x < 4.0956$

b $(2^{\log_4(5x)})^3 = 9$

$2^{3 \log_4(5x)} = 9$

$4^{\frac{1}{2} \times 3 \log_4(5x)} = 9$

$4^{\log_4((5x)^{\frac{3}{2}})} = 9$

$(5x)^{\frac{3}{2}} = 9$

$x = \frac{9^{\frac{2}{3}}}{5} = 0.8653$

22 a Let $y = f(x)$.

Switch x and y to find an inverse.

$x = e^{2y} + 2$

$x - 2 = e^{2y}$

$\log_e(x - 2) = 2y$

$\frac{1}{2} \log_e(x - 2) = y$

$f^{-1}(x) = \frac{1}{2} \log_e(x - 2)$

The domain of $f^{-1}(x)$ is the range of $f(x)$, which is $[2, \infty)$.

b $f(f^{-1}(x)) = e^{2 \times \frac{1}{2} \log_e(x-2)} + 2$

$= e^{\log_e(x-2)} + 2$

$= x - 2 + 2$

$= x$

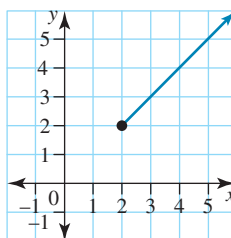

$$\begin{aligned}
 \text{c } f(-f^{-1}(2x)) &= e^{2x - \frac{1}{2} \log_e(2x-2)} + 2 \\
 &= e^{-\log_e(2x-2)} + 2 \\
 &= e^{\log_e\left(\frac{1}{2x-2}\right)} + 2 \\
 &= \frac{1}{2x-2} + 2 \\
 &= \frac{1}{2x-2} + \frac{2(2x-2)}{2x-2} \\
 &= \frac{4x-3}{2x-2}
 \end{aligned}$$

4.2 Exam questions

$$\begin{aligned}
 \text{1 } 2 \log_2(x+5) - \log_2(x+9) &= 1 \\
 \log_2(x+5)^2 - \log_2(x+9) &= 1 \\
 \log_2\left(\frac{(x+5)^2}{x+9}\right) &= 1 \\
 \frac{(x+5)^2}{x+9} &= 2^1 = 2 \\
 (x+5)^2 &= 2(x+9) \\
 x^2 + 10x + 25 &= 2x + 18 \\
 x^2 + 8x + 7 &= 0 \\
 (x+7)(x+1) &= 0 \\
 x &= -7, x = -1 \text{ but } x > -5 \\
 x &= -1 \text{ only}
 \end{aligned}$$

Award 1 mark for using the correct log laws.

Award 1 mark for solving.

Award 1 mark for only one correct answer.

VCAA Examination Report note:

Students confidently attempted this question; however, many incorrect uses of the logarithmic laws were observed. Those who did end up with the appropriate quadratic equation and solved it correctly did not always check the validity of their answers; these students failed to reject the solution $x = -7$.

$$\begin{aligned}
 \text{2 } \log_2(n+1) &= x, x \in \mathbb{Z}^+ \\
 \log_2(n+1) &= k, k \in \mathbb{Z}^+ \\
 n+1 &= 2^k, n = 2^k - 1 \\
 \text{The correct answer is B.} \\
 \text{3 By the change of base rule:} \\
 \log_a(b) &= \frac{1}{\log_b(a)} \\
 \log_x(y) + \log_y(z) &= \frac{1}{\log_y(x)} + \frac{1}{\log_z(y)}
 \end{aligned}$$

The correct answer is D.

4.3 Logarithmic scales

4.3 Exercise

$$\begin{aligned}
 \text{1 } L &= 10 \log_{10}\left(\frac{I}{10^{-12}}\right) \\
 \text{When } L &= 130 \text{ dB,}
 \end{aligned}$$

$$\begin{aligned}
 130 &= 10 \log_{10}\left(\frac{I}{10^{-12}}\right) \\
 13 &= \log_{10}(I \times 10^{12}) \\
 13 &= \log_{10}(I) + \log_{10}(10)^{12} \\
 13 &= \log_{10}(I) + 12 \log_{10}(10) \\
 13 &= \log_{10}(I) + 12 \\
 13 - 12 &= \log_{10}(I) \\
 1 &= \log_{10}(I) \\
 I &= 10
 \end{aligned}$$

The intensity is 10 watt/m².

$$\text{2 } L = 10 \log_{10}\left(\frac{I}{10^{-12}}\right)$$

When $I = 10^4$,

$$\begin{aligned}
 L &= 10 \log_{10}\left(\frac{10^4}{10^{-12}}\right) \\
 L &= 10 \log_{10}(10^4 \times 10^{12}) \\
 L &= 10 \log_{10}(10)^{16} \\
 L &= 160 \log_{10}(10) = 160 \text{ dB} \\
 \text{Loudness is } &160 \text{ dB.}
 \end{aligned}$$

$$\begin{aligned}
 \text{3 } \text{pH} &= -\log_{10}[\text{H}^+] \\
 \text{When } \text{H}^+ &= 0.001, \\
 \text{pH} &= -\log_{10}[0.001] \\
 \text{pH} &= -\log_{10}(10)^{-3} \\
 \text{pH} &= 3 \log_{10}(10) = 3 \\
 \text{Lemon juice has a pH of } &3, \text{ which is acidic.}
 \end{aligned}$$

$$\text{4 a } \text{pH} = -\log_{10}[\text{H}^+]$$

When $\text{pH} = 0$,

$$0 = -\log_{10}[\text{H}^+]$$

$$0 = \log_{10}[\text{H}^+]$$

$$10^0 = [\text{H}^+]$$

$$1 \text{ mole/litre} = [\text{H}^+]$$

b When $\text{pH} = 4$,

$$4 = -\log_{10}[\text{H}^+]$$

$$-4 = \log_{10}[\text{H}^+]$$

$$10^{-4} = [\text{H}^+]$$

$$0.0001 \text{ moles/litre} = [\text{H}^+]$$

$$\text{c } \text{pH} = -\log_{10}[\text{H}^+]$$

When $\text{pH} = 8$,

$$8 = -\log_{10}[\text{H}^+]$$

$$-8 = \log_{10}[\text{H}^+]$$

$$10^{-8} = [\text{H}^+]$$

$$10^{-8} \text{ moles/litre} = [\text{H}^+]$$

$$\text{d } \text{pH} = -\log_{10}[\text{H}^+]$$

When $\text{pH} = 12$,

$$12 = -\log_{10}[\text{H}^+]$$

$$-12 = \log_{10}[\text{H}^+]$$

$$10^{-12} = [\text{H}^+]$$

$$10^{-12} \text{ moles/litre} = [\text{H}^+]$$

$$\text{5 a } \text{pH} = -\log_{10}[\text{H}^+]$$

$$[\text{H}^+] = 0.000\,015\,8 \text{ moles/litre}$$

$$\text{pH} = -\log_{10}(0.000\,015\,8)$$

$$\text{pH} = 4.8$$

The hair conditioner has a pH of 4.8, which is acidic.

$$\begin{aligned} \text{b } \text{pH} &= -\log_{10} [\text{H}^+] \\ [\text{H}^+] &= 0.000\,002\,75 \text{ moles/litre} \\ \text{pH} &= -\log_{10} (0.000\,002\,75) \\ \text{pH} &= 5.56 \end{aligned}$$

The shampoo has a pH of 5.56, which is acidic.

$$\text{6 a } M = 0.67 \log_{10} \left(\frac{E}{K} \right)$$

If $M = 5.5$ and $E = 10^{13}$, then

$$5.5 = 0.67 \log_{10} \left(\frac{10^{13}}{K} \right)$$

$$8.2090 = \log_{10} \left(\frac{10^{13}}{K} \right)$$

$$10^{8.2090} = \frac{10^{13}}{K}$$

$$K = \frac{10^{13}}{10^{8.2090}}$$

$$K = 10^{4.7910} = 61\,801.640$$

Thus, $K \approx 61\,808 \text{ J}$.

$$\text{b } M = 0.67 \log_{10} \left(\frac{E}{K} \right)$$

When $M = 9$ and $E = 10^{17}$,

$$9 = 0.67 \log_{10} \left(\frac{10^{17}}{K} \right)$$

$$13.4328 = \log_{10} (10)^{17} - \log_{10} (K)$$

$$\log_{10} (K) = 17 \log_{10} (10) - 13.4328$$

$$\log_{10} (K) = 17 - 13.4328$$

$$\log_{10} (K) = 3.5672$$

$$10^{3.5672} = K$$

$$K = 3691.17 \text{ J}$$

$$\text{c } M = 0.67 \log_{10} \left(\frac{E}{K} \right)$$

When $M = 6.3$,

$$6.3 = 0.67 \log_{10} \left(\frac{E_{6.3}}{K} \right)$$

$$\frac{6.3}{0.67} = \log_{10} \left(\frac{E_{6.3}}{K} \right)$$

$$9.403 = \log_{10} \left(\frac{E_{6.3}}{K} \right)$$

$$10^{9.403} = \frac{E_{6.3}}{K}$$

$$252\,911\,074 K = E_{6.3}$$

When $M = 6.4$,

$$6.4 = 0.67 \log_{10} \left(\frac{E_{6.4}}{K} \right)$$

$$\frac{6.4}{0.67} = \log_{10} \left(\frac{E_{6.4}}{K} \right)$$

$$9.5522 = \log_{10} \left(\frac{E_{6.4}}{K} \right)$$

$$10^{9.5522} = \frac{E_{6.4}}{K}$$

$$3\,566\,471\,895 K = E_{6.4}$$

$$\begin{aligned} E_{6.4} : E_{6.3} &= 3\,566\,471\,895 K : 252\,911\,074 K \\ &= 1.4101 : 1 \end{aligned}$$

The magnitude 6.4 earthquake is 1.41 times bigger than the magnitude 6.3 earthquake.

$$\text{7 } L = 10 \log_{10} \left(\frac{I}{I_0} \right) = 10 \log_{10} \left(\frac{I}{10^{-12}} \right)$$

If $I = 20$,

$$L = 10 \log_{10} \left(\frac{20}{10^{-12}} \right)$$

$$L = 10 \log_{10} (20 \times 10^{12})$$

$$L = 10 \log_{10} (2 \times 10^{13})$$

$$L = 10 \log_{10} (2) + 10 \log_{10} (10^{13})$$

$$L = 10 \log_{10} (2) + (13 \times 10) \log_{10} (10)$$

$$L = 10 \log_{10} (2) + 130$$

$$L = 133.0103 \text{ dB}$$

If $I = 500$,

$$L = 10 \log_{10} \left(\frac{500}{10^{-12}} \right)$$

$$L = 10 \log_{10} (5 \times 10^2 \times 10^{12})$$

$$L = 10 \log_{10} (5 \times 10^{14})$$

$$L = 10 \log_{10} (5) + 10 \log_{10} (10)^{14}$$

$$L = 10 \log_{10} (5) + (10 \times 14) \log_{10} (10)$$

$$L = 10 \log_{10} (5) + 140$$

$$L = 146.9897 \text{ dB}$$

A 500-watt amplifier is $146.9897 - 133.0103 = 13.98 \text{ dB}$ louder than a 20-watt amplifier.

$$\text{8 a } N(t) = 0.5N_0$$

$$0.5N_0 = N_0 e^{-mt}$$

$$\frac{1}{2} = e^{-mt}$$

$$\log_e \left(\frac{1}{2} \right) = -mt$$

$$\log_e (2)^{-1} = -mt$$

$$-\log_e (2) = -mt$$

$$\log_e (2) = mt$$

$$t = \frac{\log_e (2)}{m} \text{ as required}$$

$$\text{b } N(t) = 0.3N_0$$

When $t = 5750$ years,

$$5750 = \frac{\log_e (2)}{m}$$

$$5750m = \log_e (2)$$

$$m = \frac{\log_e (2)}{5750} = 0.000\,121$$

$$0.3N_0 = N_0 e^{-0.000\,121t}$$

$$0.3 = e^{-0.000\,121t}$$

$$\log_e (0.3) = -0.000\,121t$$

$$\frac{\log_e (0.3)}{-0.000\,121} = t$$

$$t = 9987.55$$

The skeleton is 9988 years old.

$$\text{9 } m_2 - m_1 = 2.5 \log_{10} \left(\frac{b_1}{b_2} \right)$$

Sirius: $m_1 = -1.5$ and $b_1 = -30.3$

Venus: $m_2 = -4.4$ and $b_2 = ?$

$$\begin{aligned}
 -4.4 - (-1.5) &= 2.5 \log_{10} \left(\frac{-30.3}{b_2} \right) \\
 -2.9 &= 2.5 \log_{10} \left(\frac{-30.3}{b_2} \right) \\
 \frac{-2.9}{2.5} &= \log_{10} \left(\frac{-30.3}{b_2} \right) \\
 -1.16 &= \log_{10} \left(\frac{-30.3}{b_2} \right) \\
 10^{-1.16} &= \frac{-30.3}{b_2} \\
 b_2 &= \frac{-30.3}{10^{-1.16}} \\
 b_2 &= \frac{-30.3}{0.0692} \\
 &= -437.9683
 \end{aligned}$$

The brightness of Venus is -437.97 .

4.3 Exam questions

1 $n = 1200 \log_{10} \left(\frac{f_2}{f_1} \right)$ [1 mark]

$$f_1 = 256, f_2 = 512$$

$$n = 1200 \log_{10} \left(\frac{512}{256} \right)$$

$$n = 361 \text{ cents} \quad [1 \text{ mark}]$$

2 $L = 10 \log_{10} \left(\frac{I}{10^{-12}} \right)$

.22 rifle:

$$\begin{aligned}
 I &= (2.5 \times 10^{13}) I_0 \\
 &= 2.5 \times 10^{13} \times 10^{-12} \\
 &= 2.5 \times 10 \quad [1 \text{ mark}]
 \end{aligned}$$

$$L = 10 \log_{10} \left(\frac{2.5 \times 10}{10^{-12}} \right)$$

$$L = 10 (\log_{10} (2.5 \times 10) - \log_{10} (10)^{-12})$$

$$L = 10 (\log_{10} (2.5) + \log_{10} (10) + 12 \log_{10} (10))$$

$$L = 10 (\log_{10} (2.5) + 13)$$

$$L = 133.98 \quad [1 \text{ mark}]$$

The loudness of the gunshot is about 133.98 dB, so ear protection should be worn. [1 mark]

3 $M = 0.67 \log_{10} \left(\frac{E}{K} \right)$

San Francisco: $M_{SF} = 8.3$

$$8.3 = 0.67 \log_{10} \left(\frac{E_{SF}}{K} \right) \quad [1 \text{ mark}]$$

$$12.3881 = \log_{10} \left(\frac{E_{SF}}{K} \right)$$

$$10^{12.3881} = \frac{E_{SF}}{K} \quad [1 \text{ mark}]$$

South America: $M_{SA} = 4E_{SF}$

$$M_{SA} = 0.67 \log_{10} \left(\frac{4E_{SF}}{K} \right) \quad [1 \text{ mark}]$$

Substitute $10^{12.3881} = \frac{E_{SF}}{K}$.

$$M_{SA} = 0.67 \log_{10} (4 \times 10^{12.3881})$$

$$= 8.7 \quad [1 \text{ mark}]$$

The magnitude of the South American earthquake was 8.7.

4.4 Indicial equations

4.4 Exercise

1 a $3^{2x+1} \times 27^{2-x} = 81$

$$3^{2x+1} \times (3^3)^{2-x} = 3^4$$

$$3^{2x+1} \times 3^{6-3x} = 3^4$$

$$3^{7-x} = 3^4$$

Equating indices,

$$7 - x = 4$$

$$x = 3$$

b $10^{2x-1} - 5 = 0$

$$10^{2x-1} = 5$$

$$\log_{10}(5) = 2x - 1$$

$$\log_{10}(5) + 1 = 2x$$

$$x = \frac{1}{2} \log_{10}(5) + \frac{1}{2}$$

c $(4^x - 16)(4^x + 3) = 0$

$$4^x - 16 = 0 \quad \text{or} \quad 4^x + 3 = 0$$

$$4^x = 16 \quad \quad \quad 4^x = -3$$

$$4^x = 4^2 \quad \quad \quad \text{No solution}$$

$$x = 2$$

d $2(10^{2x}) - 7(10^x) + 3 = 0$

$$2(10^x)^2 - 7(10^x) + 3 = 0$$

$$(2(10^x - 1))(10^x - 3) = 0$$

$$2(10^x) - 1 = 0 \quad \text{or} \quad (10^x) - 3 = 0$$

$$10^x = \frac{1}{2}$$

$$10^x = 3$$

$$x = \log_{10} \left(\frac{1}{2} \right)$$

$$x = \log_{10}(3)$$

2 a $2^{x+3} - \frac{1}{64} = 0$

$$2^{x+3} = \frac{1}{64}$$

$$2^{x+3} = 2^{-6}$$

Equating indices,

$$x + 3 = -6$$

$$x = -9$$

b $2^{2x} - 9 = 0$

$$2^{2x} = 9$$

$$\log_2(9) = 2x$$

$$x = \frac{1}{2} \log_2(9)$$

c $3e^x - 5e^x - 2 = 0$

$$3(e^x) - 5e^x - 2 = 0$$

$$(3e^x + 1)(e^x - 2) = 0$$

$$3e^x + 1 = 0 \quad \text{or} \quad e^x - 2 = 0$$

$$3e^x = -1 \quad \quad \quad e^x = 2$$

No solution

$$x = \log_e(2)$$

d $e^{2x} - 5e^x = 0$

$$e^x(e^x - 5) = 0$$

$$e^x = 0 \quad \text{or} \quad e^x - 5 = 0$$

No solution

$$e^x = 5$$

$$x = \log_e(5)$$

3 a $7^{2x-1} = 5$

$$\log_7(5) = 2x - 1$$

$$\log_7(5) + 1 = 2x$$

$$x = \frac{1}{2} \log_7(5) + \frac{1}{2}$$

b $(3^x - 9)(3^x - 1) = 0$

$$3^x - 9 = 0 \quad \text{or} \quad 3^x - 1 = 0$$

$$3^x = 9 \quad 3^x = 1$$

$$3^x = 3^2 \quad 3^x = 3^0$$

$$x = 2 \quad x = 0$$

c $25^x - 5^x - 6 = 0$

$$(5^2)^x - 5^x - 6 = 0$$

$$(5^x)^2 - 5^x - 6 = 0$$

$$(5^x - 3)(5^x + 2) = 0$$

$$5^x - 3 = 0 \quad \text{or} \quad 5^x + 2 = 0$$

$$5^x = 3 \quad 5^x = -2$$

$$\log_5(3) = x \quad \text{No solution}$$

d $6(9^{2x}) - 19(9^x) + 10 = 0$

$$6(9^x)^2 - 19(9^x) + 10 = 0$$

$$(3(9^x) - 2)(2(9^x) - 5) = 0$$

$$3(9^x) - 2 = 0 \quad \text{or} \quad 2(9^x) - 5 = 0$$

$$3(9^x) = 2 \quad 2(9^x) = 5$$

$$(9^x) = \frac{2}{3} \quad (9^x) = \frac{5}{2}$$

$$x = \log_9\left(\frac{2}{3}\right) \quad x = \log_9\left(\frac{5}{2}\right)$$

4 a $16 \times 2^{2x+3} = 8^{-2x}$

$$2^4 \times 2^{2x+3} = 2^{3(-2x)}$$

$$2^{2x+3+4} = 2^{-6x}$$

$$2x + 7 = -6x$$

$$8x = -7$$

$$x = -\frac{7}{8}$$

b $2 \times 3^{x+1} = 4$

$$3^{x+1} = 2$$

$$\log_3(2) = x + 1$$

$$x = \log_3(2) - 1$$

c $2(5^x) - 12 = -\frac{10}{5^x}$

$$2(5^x)^2 - 12(5^x) + 10 = 0$$

$$(5^x)^2 - 6(5^x) + 5 = 0$$

$$(5^x - 1)(5^x - 5) = 0$$

$$5^x - 1 = 0 \quad \text{or} \quad 5^x - 5 = 0$$

$$5^x = 1 \quad 5^x = 5$$

$$5^x = 5^0 \quad 5^x = 5^1$$

$$x = 0 \quad x = 1$$

d $4^{x+1} = 3^{1-x}$

$$\log_e(4)^{x+1} = \log_e(3)^{1-x}$$

$$(x+1)\log_e(4) = (1-x)\log_e(3)$$

$$x\log_e(4) + \log_e(4) = \log_e(3) - x\log_e(3)$$

$$x\log_e(4) + x\log_e(3) = \log_e(3) - \log_e(4)$$

$$x(\log_e(4) + \log_e(3)) = \log_e\left(\frac{3}{4}\right)$$

$$x = \frac{\log_e\left(\frac{3}{4}\right)}{\log_e(4) + \log_e(3)}$$

$$x = \frac{\log_e\left(\frac{3}{4}\right)}{\log_e(12)}$$

5 a $2(2^{x-1} - 3) + 4 = 0$

$$2(2^{x-1} - 3) = -4$$

$$2^{x-1} - 3 = -2$$

$$2^{x-1} = 1$$

$$2^{x-1} = 2^0$$

$$x - 1 = 0$$

$$x = 1$$

b $2(5^{1-2x}) - 3 = 7$

$$2(5^{1-2x}) = 10$$

$$5^{1-2x} = 5$$

$$5^{1-2x} = 5^1$$

$$1 - 2x = 1$$

$$0 = 2x$$

$$x = 0$$

6 a $e^{x-2} - 2 = 7$

$$e^{x-2} = 9$$

$$\log_e(9) = x - 2$$

$$\log_e(9) + 2 = x$$

$$\log_e(3)^2 + 2 = x$$

$$x = 2\log_e(3) + 2$$

b $e^{\frac{x}{4}} - 1 = 3$

$$e^{\frac{x}{4}} + 1 = 3$$

$$e^{\frac{x}{4}} = 2$$

$$\log_e(2) = \frac{x}{4}$$

$$x = 4\log_e(2)$$

c $e^{2x} = 3e^x$

$$e^{2x} - 3e^x = 0$$

$$e^x(e^x - 3) = 0$$

$$e^x = 0 \quad \text{or} \quad e^x - 3 = 0$$

$$\text{No solution} \quad e^x = 3$$

$$x = \log_e(3)$$

d $e^{x^2} + 2 = 4$

$$e^{x^2} = 2$$

$$x^2 = \log_e(2)$$

$$x = \pm\sqrt{\log_e(2)}$$

7 a $e^{2x} = e^x + 12$

$$e^{2x} - e^x - 12 = 0$$

$$(e^x)^2 - (e^x) - 12 = 0$$

$$(e^x - 4)(e^x + 3) = 0$$

$$\begin{aligned}
 e^x - 4 = 0 & \quad \text{or} \quad e^x + 3 = 0 \\
 e^x = 4 & \quad \quad \quad e^x = -3 \\
 \log_e(4) = x & \quad \quad \quad \log_e(-3) = x \\
 2 \log_e(2) = x & \quad \quad \quad \text{No solution}
 \end{aligned}$$

$$\mathbf{b} \quad e^x = 12 - 32e^{-x}$$

$$\begin{aligned}
 e^x - 12 + 32e^{-x} &= 0 \\
 (e^x)^2 - 12(e^x) + 32 &= 0 \\
 (e^x - 4)(e^x - 8) &= 0 \\
 e^x - 4 = 0 & \quad \text{or} \quad e^x - 8 = 0 \\
 e^x = 4 & \quad \quad \quad e^x = 8 \\
 \log_e(4) = x & \quad \quad \quad \log_e(8) = x \\
 \log_e(2)^2 = x & \quad \quad \quad \log_e(2^3) = x \\
 2 \log_e(2) = x & \quad \quad \quad 3 \log_e(2) = x
 \end{aligned}$$

$$\mathbf{c} \quad e^{2x} - 4 = 2e^x$$

$$\begin{aligned}
 e^{2x} - 2e^x - 4 &= 0 \\
 e^x &= \frac{2 \pm \sqrt{(-2)^2 - 4(1)(-4)}}{2}
 \end{aligned}$$

$$e^x = \frac{2 \pm \sqrt{20}}{2}$$

$$e^x = \frac{2 \pm 2\sqrt{5}}{2}$$

$$e^x = 1 \pm \sqrt{5}$$

$$x = \log_e(1 \pm \sqrt{5})$$

Therefore, $x = \log_e(1 + \sqrt{5})$ as $1 - \sqrt{5} \not\geq 0$

$$\mathbf{d} \quad e^x - 12 = \frac{-5}{e^x}$$

$$\begin{aligned}
 e^{2x} - 12e^x + 5 &= 0 \\
 e^x &= \frac{12 \pm \sqrt{144 - 4(1)(5)}}{2}
 \end{aligned}$$

$$e^x = \frac{12 \pm \sqrt{144 - 20}}{2}$$

$$e^x = \frac{12 \pm \sqrt{124}}{2}$$

$$e^x = \frac{12 \pm 2\sqrt{31}}{2}$$

$$\begin{aligned}
 e^x &= 6 \pm \sqrt{31} \\
 x &= \log_e(6 \pm \sqrt{31})
 \end{aligned}$$

$$\mathbf{8} \quad (\log_3(4m))^2 = 25n^2$$

$$\log_3(4m) = \pm 5n$$

$$3^{-5n} = 4m \quad \text{or} \quad 3^{5n} = 4m$$

$$m = \frac{1}{4 \times 3^{5n}} \quad m = \frac{3^{5n}}{4}$$

$$\mathbf{9} \quad \mathbf{a} \quad x^{-1} - \frac{1}{1 - \frac{1}{1+x^{-1}}}$$

$$= x^{-1} - \frac{1}{1 - \frac{1}{1+\frac{1}{x}}}$$

$$= x^{-1} - \frac{1}{1 - \frac{1}{\frac{x+1}{x}}}$$

$$= x^{-1} - \frac{1}{1 - \frac{x}{x+1}}$$

$$= x^{-1} - \frac{1}{\frac{x+1-x}{x+1}}$$

$$= x^{-1} - \frac{1}{\frac{1}{x+1}}$$

$$= \frac{1}{x} - (x+1)$$

$$= \frac{1}{x} - x - 1$$

$$\mathbf{b} \quad 2^{3-4x} \times 3^{-4x+3} \times 6^{x^2} = 1$$

$$2^{3-4x} \times 3^{-4x+3} \times (2 \times 3)^{x^2} = 1$$

$$2^{3-4x} \times 3^{-4x+3} \times 2^{x^2} \times 3^{x^2} = 1$$

$$2^{x^2-4x+3} \times 3^{x^2-4x+3} = 1$$

$$6^{x^2-4x+3} = 6^0$$

$$x^2 - 4x + 3 = 0$$

$$(x-1)(x-3) = 0$$

$$x-1 = 0 \quad \text{or} \quad x-3 = 0$$

$$x = 1 \quad \quad \quad x = 3$$

$$\mathbf{10} \quad \mathbf{a} \quad e^{m-kx} = 2n$$

$$m - kx = \log_e(2n)$$

$$-kx = \log_e(2n) - m$$

$$x = \frac{\log_e(2n) - m}{-k}$$

$$= \frac{m - \log_e(2n)}{k}, \quad k \in \mathbb{R} \setminus \{0\}, n \in \mathbb{R}^+$$

$$\mathbf{b} \quad 8^{mx} \times 4^{2n} = 16$$

$$2^{3mx} \times 2^{2(2n)} = 2^4$$

$$2^{3mx+4n} = 2^4$$

$$3mx + 4n = 4$$

$$3mx = 4 - 4n$$

$$x = \frac{4 - 4n}{3m}, \quad m \in \mathbb{R} \setminus \{0\}$$

$$\mathbf{c} \quad 2e^{mx} = 5 + 4e^{-mx}$$

$$2(e^{mx})^2 - 5e^{mx} - 4 = 0$$

$$e^{mx} = \frac{5 \pm \sqrt{(-5)^2 - 4(2)(-4)}}{2(2)}$$

$$e^{mx} = \frac{5 \pm \sqrt{25 + 32}}{4}$$

$$e^{mx} = \frac{5 \pm \sqrt{57}}{4}$$

$$e^{mx} = \frac{5 + \sqrt{57}}{4}, \quad e^{mx} > 0$$

$$mx = \log_e\left(\frac{5 + \sqrt{57}}{4}\right)$$

$$x = \frac{1}{m} \log_e\left(\frac{5 + \sqrt{57}}{4}\right), \quad m \in \mathbb{R} \setminus \{0\}$$

$$\mathbf{11} \quad \mathbf{a} \quad 2^x < 0.3$$

$$\log_2(0.3) < x$$

$$-1.737 > x$$

$$x < -1.737$$

$$\mathbf{b} \quad (0.4)^x < 2$$

$$\log_{0.4}(2) < x$$

$$-0.756 < x$$

$$x > -0.756$$

$$\mathbf{12} \quad y = m(10)^{nx}$$

$$\text{When } x = 2, y = 20, \text{ so } 20 = m(10)^{2n}.$$

$$\text{When } x = 4, y = 200, \text{ so } 200 = m(10)^{4n}.$$

$$[2] \div [1]:$$

$$\frac{200}{20} = \frac{m(10)^{4n}}{m(10)^{2n}}$$

$$10 = 10^{2n}$$

$$\log_{10}(10) = 2n$$

$$1 = 2n$$

$$n = \frac{1}{2}$$

$$\text{Substitute } n = \frac{1}{2} \text{ into [1]:}$$

$$20 = m(10)^2 \left(\frac{1}{2}\right)$$

$$20 = 10m$$

$$m = 2$$

$$\mathbf{13} \quad y = ae^{-kx}$$

$$\text{When } x = 2, y = 3.033.$$

$$3.033 = ae^{-2k} \quad [1]$$

$$\text{When } x = 6, y = 1.1157.$$

$$1.1157 = ae^{-6k} \quad [2]$$

$$[1] \div [2]:$$

$$\frac{3.033}{1.1157} = \frac{ae^{-2k}}{ae^{-6k}}$$

$$2.7185 = e^{4k}$$

$$\log_e(2.7185) = 4k$$

$$\frac{1}{4} \log_e(2.7185) = k$$

$$k = 0.25$$

$$\text{Substitute } k = 0.25 \text{ into [1]:}$$

$$3.033 = ae^{-2(0.25)}$$

$$3.033 = ae^{-0.5}$$

$$\frac{3.033}{e^{-0.5}} = a$$

$$a = 5$$

$$\mathbf{14} \quad A = Pe^{rt}$$

$$\text{When } t = 5, A = \$12\,840.25.$$

$$12\,840.25 = Pe^{5r} \quad [1]$$

$$\text{When } t = 7, A = \$14\,190.66.$$

$$14\,190.66 = Pe^{7r} \quad [2]$$

$$[2] \div [1]:$$

$$\frac{14\,190.66}{12\,840.25} = \frac{Pe^{7r}}{Pe^{5r}}$$

$$1.1052 = e^{2r}$$

$$\log_e(1.1052) = 2r$$

$$\frac{1}{2} \log_e(1.1052) = r$$

$$0.05 = r$$

$$r = 5\%$$

$$\text{Substitute } r = 0.05 \text{ into [1]:}$$

$$12\,840.25 = Pe^{5(0.05)}$$

$$\frac{12\,840.25}{e^{0.25}} = P$$

$$P = \$10\,000$$

4.4 Exam questions

$$\mathbf{1} \quad y = a^{b-4x} + 2$$

$$y - 2 = a^{b-4x}$$

$$\log_a(y - 2) = b - 4x$$

$$4x = b - \log_a(y - 2)$$

$$x = \frac{1}{4}(b - \log_a(y - 2))$$

The correct answer is **A**.

$$\mathbf{2} \quad 3e^t = 5 + 8e^{-t}$$

$$\text{Let } u = e^t: \quad e^{-t} = \frac{1}{e^t} = \frac{1}{u}$$

$$3u = 5 + \frac{8}{u}$$

$$3u^2 = 5u + 8$$

$$3u^2 - 5u - 8 = 0$$

$$(3u - 8)(u + 1) = 0$$

$$u = e^t = \frac{8}{3} \text{ or } u = e^t = -1 \quad (\text{no solution})$$

$$t = \log_e\left(\frac{8}{3}\right)$$

Award 1 mark for solving for u .

Award 1 mark for rejecting one of the solutions.

Award 1 mark for the correct final value.

VCAA Assessment Report note:

This question was not answered well. Many students were unable to create the quadratic equation evolved from manipulating e^{-t} . Many students solved via the quadratic formula rather than using simpler factorising techniques. The feasibility of only one answer was generally well handled.

$$\mathbf{3} \quad 2^{3x-3} = 8^{2-x}$$

$$2^{3x-3} = (2^3)^{2-x}$$

$$= 2^{6-3x}$$

$$3x - 3 = 6 - 3x$$

$$6x = 9$$

$$x = \frac{3}{2}$$

Award 1 mark for correct manipulation of indices.

Award 1 mark for the correct answer.

VCAA Assessment Report note:

Some students chose to work with a common base of 8.

Students are reminded to simplify their final answer,

especially for fraction answers.

4.5 Logarithmic graphs

4.5 Exercise

1 a The graph cuts the x -axis when $y = 0$.

$$\log_e(x) + 3 = 0$$

$$\log_e(x) = -3$$

$$x = e^{-3}$$

When $x = 1$, $y = \log_e 1 + 3 = 3$.

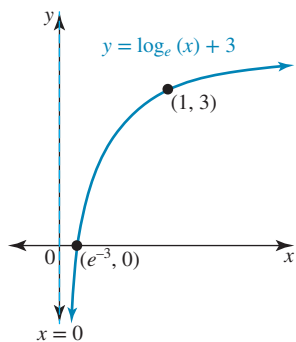

b The graph cuts the x -axis when $y = 0$.

$$\log_e(x) - 5 = 0$$

$$\log_e(x) = 5$$

$$x = e^5$$

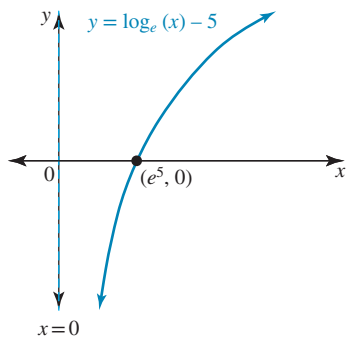

c The graph cuts the x -axis when $y = 0$.

$$\log_e(x) + 0.5 = 0$$

$$\log_e(x) = -0.5$$

$$x = e^{-0.5}$$

When $x = 1$, $y = \log_e(1) + 0.5 = 0.5$.

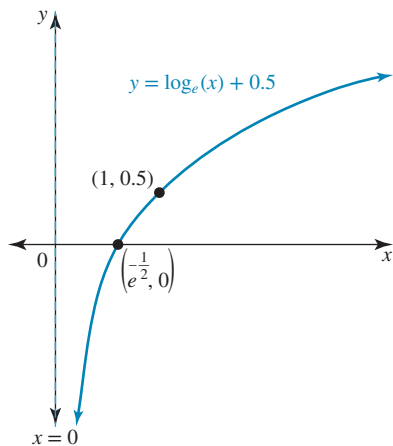

2 a The graph cuts the x -axis when $y = 0$.

$$\log_e(x - 4) = 0$$

$$e^0 = x - 4$$

$$1 = x - 4$$

$$x = 5$$

When $x = 10$,

$$y = \log_e(10 - 4) = \log_e(6).$$

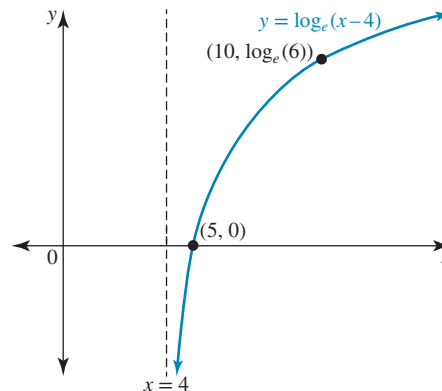

b The graph cuts the x -axis when $y = 0$.

$$\log_e(x + 2) = 0$$

$$e^0 = x + 2$$

$$1 \approx x + 2$$

$$x = -1$$

When $x = 0$,

$$y = \log_e(0 + 2) = \log_e(2).$$

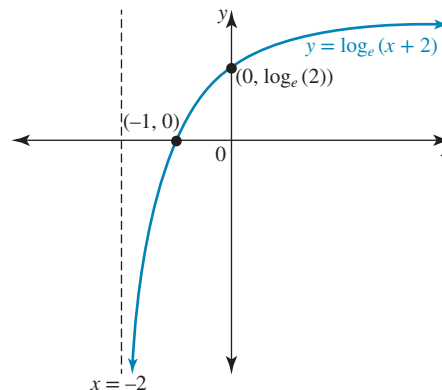

c The graph cuts the x -axis when $y = 0$.

$$\log_e(x + 0.5) = 0$$

$$e^0 = x + 0.5$$

$$1 \approx x + 0.5$$

$$x = 0.5$$

When $x = 0$,

$$y = \log_e(0 + 0.5) = \log_e(0.5).$$

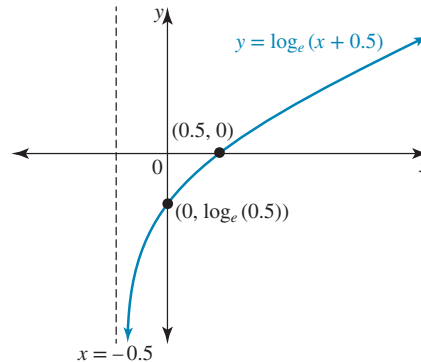

3 a The graph cuts the x -axis when $y = 0$.

$$\begin{aligned} \frac{1}{4} \log_e(x) &= 0 \\ \log_e(x) &= 0 \\ e^0 &= x \\ x &= 1 \end{aligned}$$

The graph does not cut the y -axis.

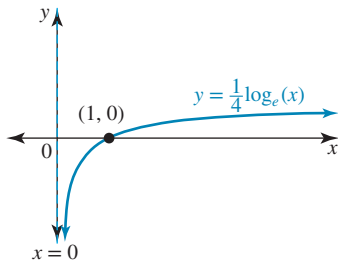

b The graph cuts the x -axis when $y = 0$.

$$\begin{aligned} 3 \log_e(x) &= 0 \\ \log_e(x) &= 0 \\ e^0 &= x \\ x &= 1 \end{aligned}$$

The graph does not cut the y -axis.

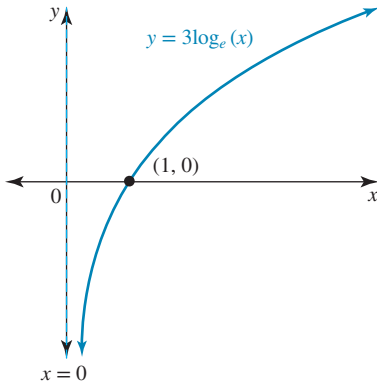

c The graph cuts the x -axis when $y = 0$.

$$\begin{aligned} 6 \log_e(x) &= 0 \\ \log_e(x) &= 0 \\ e^0 &= x \\ x &= 1 \end{aligned}$$

The graph does not cut the y -axis.

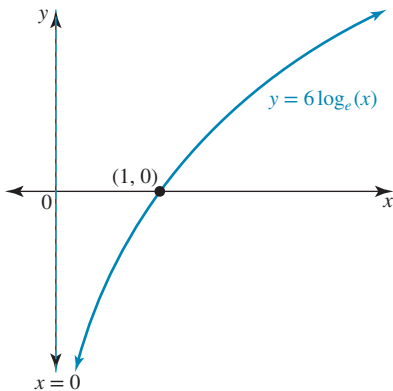

4 a The graph cuts the x -axis when $y = 0$.

$$\begin{aligned} \log_e(3x) &= 0 \\ e^0 &= 3x \\ 1 &= 3x \\ x &= \frac{1}{3} \end{aligned}$$

The graph does not cut the y -axis.

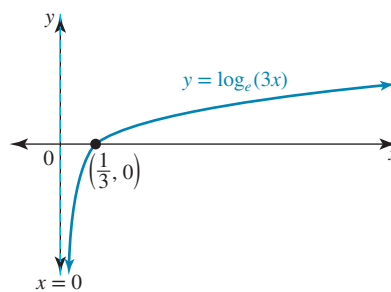

b The graph the cuts x -axis when $y = 0$.

$$\begin{aligned} \log_e\left(\frac{x}{4}\right) &= 0 \\ e^0 &= \frac{x}{4} \\ 1 &= \frac{x}{4} \\ x &= 4 \end{aligned}$$

The graph does not cut the y -axis.

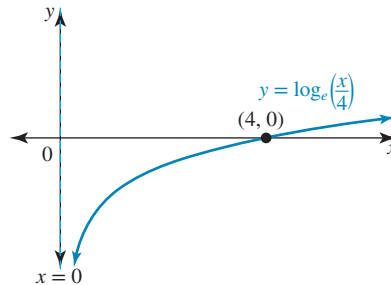

c The graph cuts the x -axis when $y = 0$.

$$\begin{aligned} \log_e(4x) &= 0 \\ e^0 &= 4x \\ 1 &= 4x \\ x &= \frac{1}{4} \end{aligned}$$

The graph does not cut the y -axis.

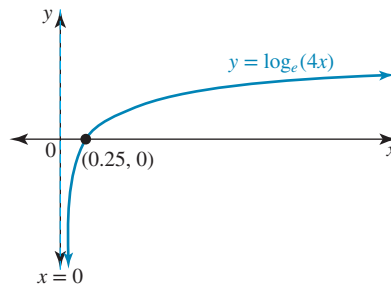

5 a The graph cuts the y -axis when $x = 0$.

$$\begin{aligned} y &= \log_e(4) \\ \text{Domain} &= (-4, \infty) \text{ and range} = R \end{aligned}$$

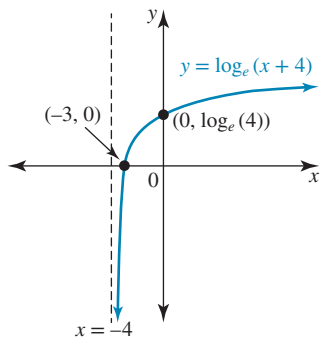

b The graph cuts the x -axis when $y = 0$.

$$\begin{aligned}\log_e(x) + 2 &= 0 \\ \log_e(x) &= -2 \\ x &= e^{-2}\end{aligned}$$

$$\begin{aligned}\text{When } x = 1, \\ y &= \log_e(1) + 2 \\ &= 2\end{aligned}$$

Domain = $(0, \infty)$ and range = R

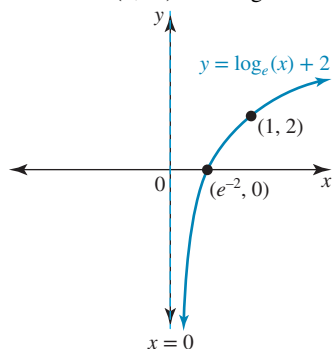

c The graph cuts the x -axis when $y = 0$.

$$\begin{aligned}4 \log_e(x) &= 0 \\ \log_e(x) &= 0 \\ e^0 &= x \\ x &= 1\end{aligned}$$

$$\begin{aligned}\text{When } x = 2, \\ y &= 4 \log_e(2).\end{aligned}$$

Domain = $(0, \infty)$ and range = R

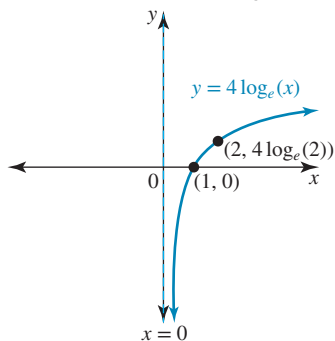

d The graph cuts the x -axis where $y = 0$.

$$\begin{aligned}-\log_e(x - 4) &= 0 \\ \log_e(x - 4) &= 0 \\ e^0 &= x - 4 \\ 1 + 4 &= x \\ x &= 5\end{aligned}$$

Domain = $(4, \infty)$ and range = R

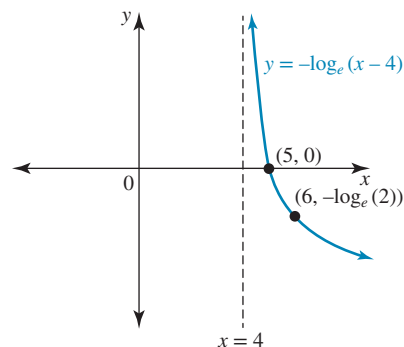

6 a $y = \log_3(x + 2) - 3$

The graph cuts the x -axis when $y = 0$.

$$\begin{aligned}\log_3(x + 2) - 3 &= 0 \\ \log_3(x + 2) &= 3 \\ 3^3 &= x + 2 \\ 27 &= x + 2 \\ x &= 25\end{aligned}$$

Domain = $(-2, \infty)$ and range = R

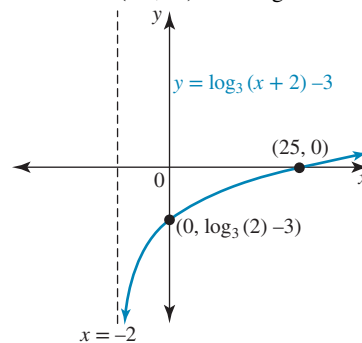

b $y = 3 \log_5(2 - x)$

The graph cuts the x -axis when $y = 0$.

$$\begin{aligned}3 \log_5(2 - x) &= 0 \\ \log_5(2 - x) &= 0 \\ 3^0 &= 2 - x \\ x &= 2 - 1 \\ x &= 1\end{aligned}$$

Domain = $(-\infty, 1)$ and range = R

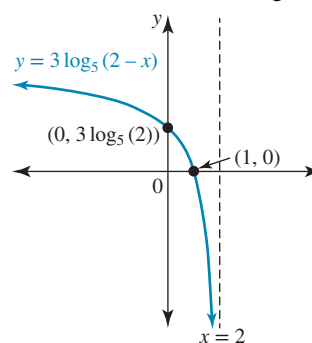

c $y = 2 \log_{10}(x + 1)$

The graph cuts the x -axis where $y = 0$.

$$\begin{aligned}2 \log_{10}(x + 1) &= 0 \\ \log_{10}(x + 1) &= 0 \\ 10^0 &= x + 1 \\ x &= 0\end{aligned}$$

Domain = $(-1, \infty)$ and range = R

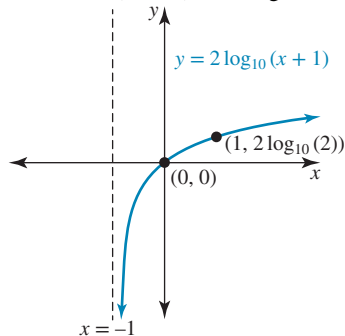

d $y = \log_2\left(\frac{-x}{2}\right)$

The graph cuts the x -axis when $y = 0$.

$$\log_2\left(\frac{-x}{2}\right) = 0$$

$$2^0 = \frac{-x}{2}$$

$$x = -2$$

Domain = $(-\infty, 0)$ and range = R

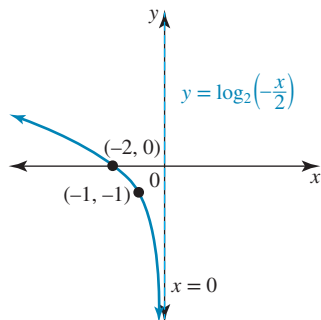

7 a The graph cuts the x -axis when $y = 0$.

$$1 - 2 \log_e(x - 1) = 0$$

$$2 \log_e(x - 1) = 1$$

$$\log_e(x - 1) = \frac{1}{2}$$

$$e^{\frac{1}{2}} = x - 1$$

$$x = 1 + e^{0.5}$$

The graph does not cut the y -axis.

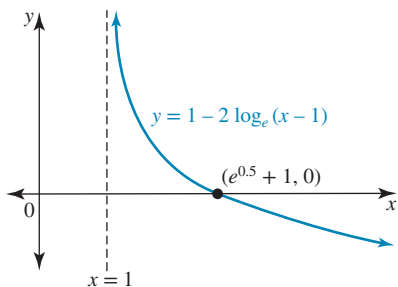

b The graph cuts the x -axis when $y = 0$.

$$\log_e(2x + 4) = 0$$

$$e^0 = 2x + 4$$

$$1 - 4 = 2x$$

$$x = -\frac{3}{2}$$

The graph cuts the y -axis when $x = 0$.

$$\log_e(2(0) + 4) = y$$

$$y = \log_e(4)$$

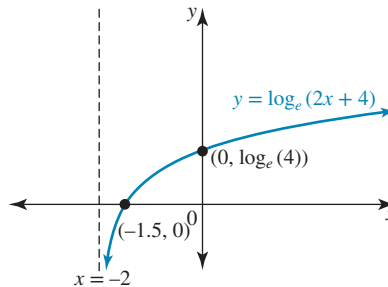

c The graph cuts the x -axis when $y = 0$.

$$\frac{1}{2} \log_e\left(\frac{x}{4}\right) + 1 = 0$$

$$\frac{1}{2} \log_e\left(\frac{x}{4}\right) = -1$$

$$\log_e\left(\frac{x}{4}\right) = -2$$

$$e^{-2} = \frac{x}{4}$$

$$x = 4e^{-2}$$

The graph does not cut the y -axis.

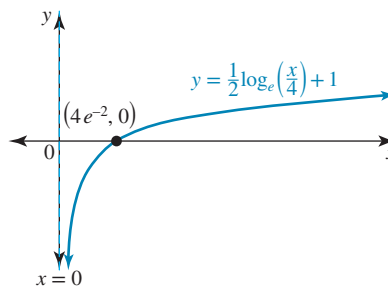

8 $y = \log_e(x - m) + n$

The vertical asymptote is $x = 2$, so $m = 2$.

$$y = \log_e(x - 2) + n$$

When $x = e + 2$, $y = 3$

$$3 = \log_e(e + 2 - 2) + n$$

$$3 = \log_e(e) + n$$

$$3 = 1 + n$$

$$n = 2$$

$$y = \log_e(x - 2) + 2$$

9 $y = a \log_e(x - h) + k$

The graph asymptotes to $x = -1$, so $h = -1$ and $y = a \log_e(x + 1) + k$.

The graph cuts the y -axis at $y = -2$.

$$(0, -2) \Rightarrow -2 = a \log_e(1) + k$$

$$k = -2$$

$$\therefore y = a \log_e(x + 1) - 2$$

The graph cuts the x -axis at $x = 1$.

$$(1, 0) \Rightarrow 0 = a \log_e(2) - 2$$

$$2 = a \log_e(2)$$

$$a = \frac{2}{\log_e(2)}$$

$$\text{Thus, } y = \frac{2}{\log_e(2)} \log_e(x + 1) - 2.$$

10 $y = p \log_e(x - q)$

When $x = 0$, $y = 0$.

$$0 = p \log_e(-q) \quad [1]$$

When $x = 1$, $y = -0.35$.

$$-0.35 = p \log_e(1 - q) \quad [2]$$

From [1]:

$$0 = \log_e(-q)$$

$$e^0 = -q$$

$$q = -1$$

Substitute $q = -1$ into [2]:

$$-0.35 = p \log_e(1 - (-1))$$

$$-0.35 = p \log_e(2)$$

$$\frac{-0.35}{\log_e(2)} = p$$

$$p = \frac{-7}{20 \log_e(2)}$$

The correct answer is **D**.

11 a $y = a \log_e(bx)$

When $x = 1$, $y = \log_e(2)$.

$$\log_e(2) = a \log_e(b) \quad [1]$$

When $x = 2$, $y = 0$.

$$0 = a \log_e(2b) \quad [2]$$

[2] - [1]:

$$0 - \log_e(2) = a \log_e(2b) - a \log_e(b)$$

$$-\log_e(2) = a (\log_e(2b) - \log_e(b))$$

$$-\log_e(2) = a \log_e\left(\frac{2b}{b}\right)$$

$$-\log_e(2) = a \log_e(2)$$

$$\frac{-\log_e(2)}{\log_e(2)} = a$$

$$a = -1$$

Substitute $a = -1$ into [1]:

$$\log_e(2) = -\log_e(b)$$

$$\log_e(2) = \log_e(b)^{-1}$$

$$\log_e(2) = \log_e\left(\frac{1}{b}\right)$$

$$2 = \frac{1}{b}$$

$$b = \frac{1}{2}$$

b When $x = 3$, $w = -\log_e\left(\frac{3}{2}\right) = -0.4055$.

12 $y = m \log_2(nx)$

When $x = -2$, $y = 3$.

$$3 = m \log_2(-2n) \quad [1]$$

When $x = -\frac{1}{2}$, $y = \frac{1}{2}$.

$$\frac{1}{2} = m \log_2\left(-\frac{n}{2}\right) \quad [2]$$

[1] - [2]:

$$3 - \frac{1}{2} = m \log_2(-2n) - m \log_2\left(-\frac{n}{2}\right)$$

$$\frac{5}{2} = m \left(\log_2(-2n) - \log_2\left(-\frac{n}{2}\right) \right)$$

$$\frac{5}{2} = m \left(\log_2\left(-2n \div -\frac{n}{2}\right) \right)$$

$$\frac{5}{2} = m \log_2(4)$$

$$\frac{5}{2} = m \log_2(2)^2$$

$$\frac{5}{2} = 2m$$

$$m = \frac{5}{4}$$

Substitute $m = \frac{5}{4}$ into [1]: $3 = \frac{5}{4} \log_2(-2n)$

$$\frac{12}{5} = \log_2(-2n)$$

$$2^{\frac{12}{5}} = -2n$$

$$-\frac{2^{\frac{12}{5}}}{2} = n$$

$$n = -2^{\frac{7}{5}}$$

Thus, $m = 1.25$ and $n = -2^{\frac{7}{5}}$ as required.

4.5 Exam questions

1 a

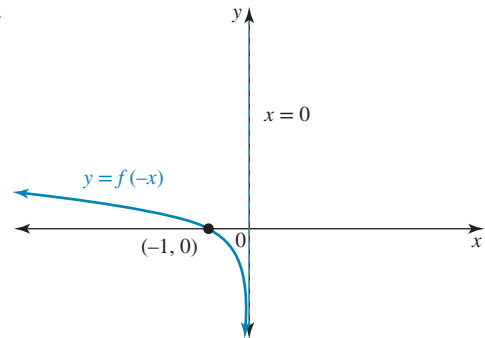

Award 1 mark for correct curve and labelled asymptote.

b

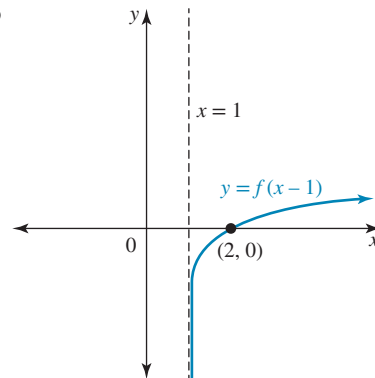

Award 1 mark for correct curve and labelled asymptote.

c

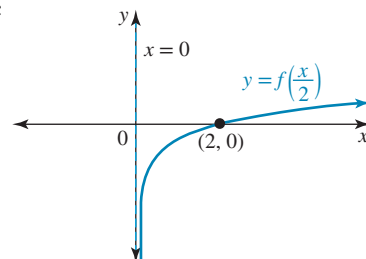

Award 1 mark for correct curve and labelled asymptote.

2 $f(x) = -\log_e(x+1)$

The correct answer is **E**.

- 3 The graph shown is $y = \log_e(1 - x)$. It has domain $(-\infty, 1)$ and range R .

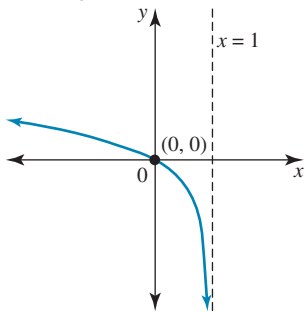

Hence, $a = -1$ and $b = 1$.
The correct answer is **D**.

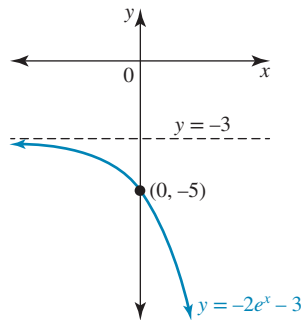

Domain R , range $(-\infty, -3)$

- b** $y = 4e^{-3x} - 4$
Asymptote: $y = -4$
y-intercept: let $x = 0$.
 $\therefore y = 4e^0 - 4$
 $\therefore y = 0$
 $(0, 0)$

The origin is also the x -intercept.

- Point: let $x = -\frac{1}{3}$.
 $\therefore y = 4e - 4 > 0$

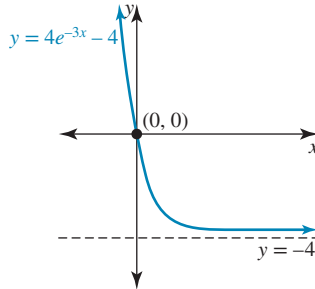

Domain R and range $(-4, \infty)$.

- c** $y = 5e^{x-2}$
Asymptote: $y = 0$
There is no x -intercept.
y-intercept: let $x = 0$.
 $\therefore y = 5e^{-2}$
 $(0, 5e^{-2})$
Point: let $x = 2$.
 $\therefore y = 5e^0$
 $\therefore y = 5$
 $(2, 5)$

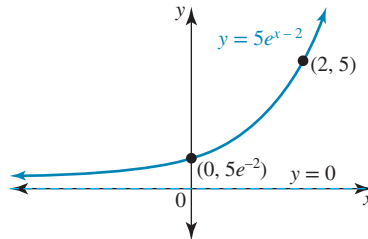

Domain R , range R^+

- 3 a** $y = \frac{4}{5} \times 10^x$
Asymptote: $y = 0$
y-intercept: let $x = 0$.

4.6 Exponential graphs

4.6 Exercise

1 $f(x) = -10^x$

a $f(2) = -10^2$
 $= -100$

- b** The graph of $y = 10^x$ contains $(0, 1)$ and $(1, 10)$.
The graph of $y = -10^x$ contains the points $(0, -1)$ and $(1, -10)$.
The graph of $y = 10^{-x}$ contains the points $(0, 1)$ and $(-1, 10)$.

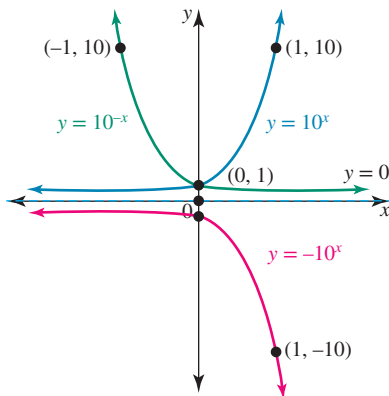

- c** $y = 10^{-x}$ can be expressed as $y = \left(\frac{1}{10}\right)^x$ or $y = 0.1^x$.

2 a $y = -2e^x - 3$

- Asymptote: $y = -3$
y-intercept: let $x = 0$.
 $\therefore y = -2e^0 - 3$
 $\therefore y = -5$
 $(0, -5)$

There will not be an x -intercept.

$$y = \frac{4}{5} \times 10^0 = \frac{4}{5}$$

$$\left(0, \frac{4}{5}\right)$$

Point: let $x = 1$.

$$y = \frac{4}{5} \times 10^1 = 8$$

(1, 8)

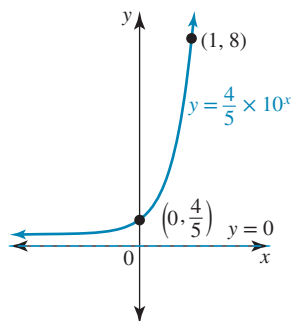

As $x \rightarrow \infty$, $y \rightarrow \infty$.

b $y = 3 \times 4^{-x}$

Asymptote: $y = 0$

y -intercept: let $x = 0$.

$$y = 3 \times 4^0 = 3$$

(0, 3)

Point: let $x = -1$.

$$y = 3 \times 4^1 = 12$$

(-1, 12)

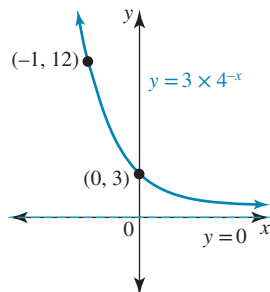

As $x \rightarrow \infty$, $y \rightarrow 0^+$.

c $y = -5 \times 3^{-\frac{x}{2}}$

Asymptote: $y = 0$

y -intercept: let $x = 0$.

$$y = -5 \times 3^0 = -5$$

(0, -5)

Point: let $x = -2$.

$$y = -5 \times 3^1 = -15$$

(-2, -15)

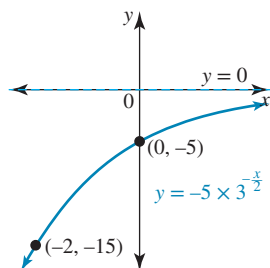

As $x \rightarrow \infty$, $y \rightarrow 0^-$.

d $y = -\left(\frac{2}{3}\right)^{-x}$

Asymptote: $y = 0$

y -intercept: let $x = 0$.

$$y = -\left(\frac{2}{3}\right)^0 = -1$$

(0, -1)

Point: let $x = 1$.

$$y = -\left(\frac{2}{3}\right)^{-1} = -\frac{3}{2}$$

(1, -1.5)

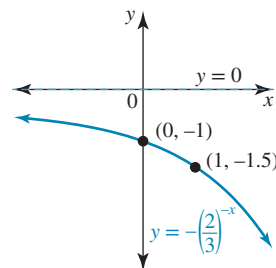

As $x \rightarrow \infty$, $y \rightarrow -\infty$.

4 a $y = e^x - 3$

Asymptote: $y = -3$

y -intercept: let $x = 0$.

$$y = e^0 - 3 = -2$$

(0, -2)

x -intercept: let $y = 0$.

$$e^x - 3 = 0$$

$$\therefore e^x = 3$$

$$\therefore x = \log_e(3)$$

$(\log_e(3), 0)$

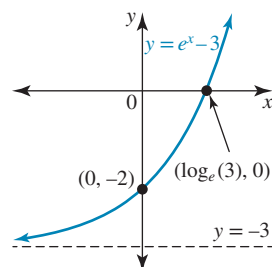

The range is $(-3, \infty)$.

b $y = -2e^{2x} - 1$

Asymptote: $y = -1$

y -intercept: let $x = 0$.

$$y = -2e^0 - 1 = -3$$

(0, -3)

No x -intercept

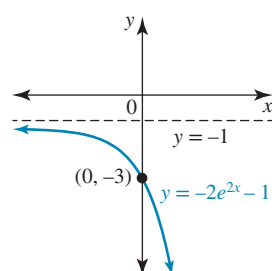

The range is $(-\infty, -1)$.

c $y = \frac{1}{2}e^{-4x} + 3$

Asymptote: $y = 3$

y-intercept: let $x = 0$.

$$y = \frac{1}{2}e^0 + 3 = 3.5$$

(0, 3.5)

No x-intercept

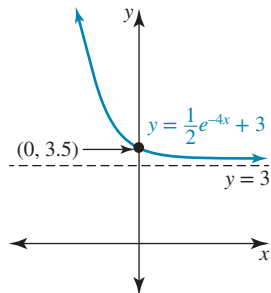

The range is $(3, \infty)$.

d $y = 4 - e^{2x}$

Asymptote: $y = 4$

y-intercept: let $x = 0$.

$$y = 4 - e^0 = 3$$

(0, 3)

x-intercept: let $y = 0$.

$$4 - e^{2x} = 0$$

$$\therefore e^{2x} = 4$$

$$\therefore 2x = \log_e(4)$$

$$\therefore x = \frac{1}{2} \log_e(4)$$

$$\left(\frac{1}{2} \log_e(4), 0\right) \text{ or } (\log_e(2), 0)$$

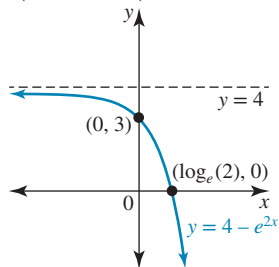

The range is $(-\infty, 4)$.

e $y = 4e^{2x-6} + 2$

$$\therefore y = 4e^{2(x-3)} + 2$$

Asymptote: $y = 2$

y-intercept: let $x = 0$.

$$y = 4e^{-6} + 2 \approx 2.01$$

(0, $4e^{-6} + 2$)

No x-intercept

Point: let $x = 3$.

$$\therefore y = 4e^0 + 2 = 6$$

(3, 6)

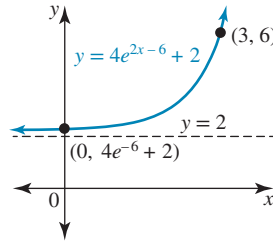

The range is $(2, \infty)$.

f $y = 1 - e^{-\frac{x+1}{2}}$

Asymptote: $y = 1$

y-intercept: let $x = 0$.

$$y = 1 - e^{-0.5} \approx 0.39$$

(0, $1 - e^{-0.5}$)

x-intercept: let $y = 0$.

$$1 - e^{-\frac{x+1}{2}} = 0$$

$$\therefore e^{-\frac{x+1}{2}} = 1$$

$$\therefore e^{-\frac{x+1}{2}} = e^0$$

$$\therefore -\frac{x+1}{2} = 0$$

$$\therefore x+1 = 0$$

$$\therefore x = -1$$

(-1, 0)

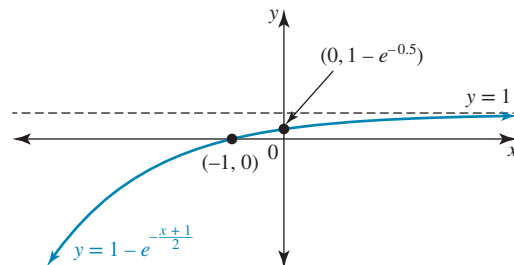

The range is $(-\infty, 1)$.

5 a $y = 2e^{1-3x} - 4$

Asymptote: $y = -4$

y-intercept: let $x = 0$.

$$\therefore y = 2e^1 - 4$$

(0, $2e - 4$)

This point lies above the asymptote, so there will be an x-intercept. Approximately, $2e - 4 = 1.4$.

x-intercept: let $y = 0$.

$$\therefore 2e^{1-3x} - 4 = 0$$

$$\therefore 2e^{1-3x} = 4$$

$$\therefore e^{1-3x} = 2$$

Convert to logarithm form.

$$\therefore 1 - 3x = \log_e(2)$$

$$\therefore 3x = 1 - \log_e(2)$$

$$\therefore x = \frac{1}{3}(1 - \log_e(2))$$

The x -intercept is $\left(\frac{1}{3}(1 - \log_e(2)), 0\right)$, which is approximately $(-0.1, 0)$.

Point: let $x = \frac{1}{3}$.

$$\therefore y = 2e^0 - 4$$

$$\therefore y = -2$$

$$\left(\frac{1}{3}, -2\right)$$

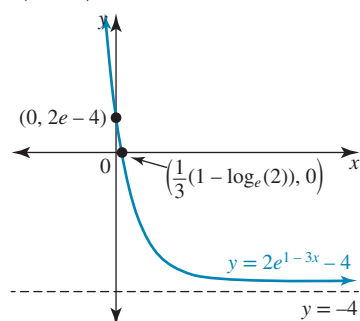

b $y = 3 \times 2^x - 24$

Asymptote: $y = -24$

y -intercept: let $x = 0$.

$$\therefore y = 3 \times 2^0 - 24$$

$$= -21$$

$$(0, -21)$$

x -intercept: let $y = 0$.

$$\therefore 3 \times 2^x - 24 = 0$$

$$\therefore 2^x = 8$$

$$\therefore x = 3$$

$$(3, 0)$$

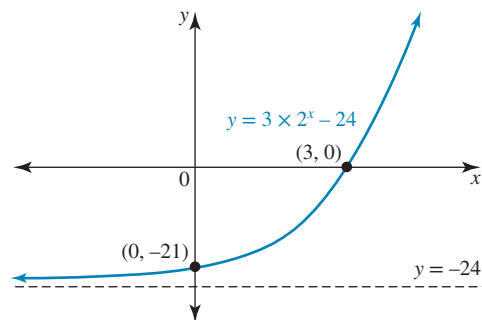

Domain R and range $(-24, \infty)$

6 a $y = ae^x + b$

From the graph, the asymptote is $y = 2$, so $b = 2$.

The equation becomes $y = ae^x + 2$.

The graph passes through the origin.

Substitute $(0, 0)$.

$$\therefore 0 = ae^0 + 2$$

$$\therefore 0 = a + 2$$

$$\therefore a = -2$$

The equation is $y = -2e^x + 2$ with $a = -2, b = 2$.

b $y = a \times 10^{4x}$

Substitute the point $(4, -20)$:

$$\therefore -20 = a \times 10^{4k} \quad [1]$$

Substitute the point $(8, -200)$:

$$\therefore -200 = a \times 10^{8k} \quad [2]$$

Divide equation [2] by equation [1]:

$$\therefore \frac{-200}{-20} = \frac{a \times 10^{8k}}{a \times 10^{4k}}$$

$$\therefore 10 = 10^{4k}$$

$$\therefore 1 = 4k$$

$$\therefore k = \frac{1}{4}$$

Substitute $k = \frac{1}{4}$ in equation [1]:

$$\therefore -20 = a \times 10^1$$

$$\therefore a = -2$$

The equation is $y = -2 \times 10^{\frac{x}{4}}$.

7 C

$$y = a \times e^{kx}$$

Substitute the point $(2, 36)$:

$$\therefore 36 = a \times e^{2k} \quad [1]$$

Substitute the point $(3, 108)$:

$$\therefore 108 = a \times e^{3k} \quad [2]$$

Divide equation [2] by equation [1]:

$$\therefore \frac{108}{36} = \frac{a \times e^{3k}}{a \times e^{2k}}$$

$$\therefore 3 = e^k$$

$$\therefore k = \log_e(3)$$

Substitute $e^k = 3$ in equation [1]:

$$36 = a \times e^{2k}$$

$$\therefore 36 = a \times (e^k)^2$$

$$\therefore 36 = a \times (3)^2$$

$$\therefore 36 = 9a$$

$$\therefore a = 4$$

Answer: $a = 4, k = \log_e(3)$

8 a $f(x) = ae^x + b$

Asymptote is $y = 11$ so $b = 11$.

The equation becomes $f(x) = ae^x + 11$.

The graph passes through the origin, so $f(0) = 0$.

$$\therefore ae^0 + 11 = 0$$

$$\therefore a + 11 = 0$$

$$\therefore a = -11$$

The rule for the function is $f(x) = -11e^x + 11$ with

$a = -11, b = 11$.

The domain of the graph is R , so as a mapping the function is written $f: R \rightarrow R, f(x) = -11e^x + 11$.

b $y = Ae^{nx} + k$

The asymptote is $y = 4$, so $k = 4$ and the equation becomes

$$y = Ae^{nx} + 4.$$

Substitute the point $(0, 5)$:

$$\therefore 5 = Ae^0 + 4$$

$$\therefore 5 = a + 4$$

$$\therefore a = 1$$

The equation becomes $y = e^{nx} + 4$.

Substitute the point $(-1, 4 + e^2)$:

$$\therefore 4 + e^2 = e^{-n} + 4$$

$$\therefore e^2 = e^{-n}$$

$$\therefore 2 = -n$$

$$\therefore n = -2$$

The equation is $y = e^{-2x} + 4$.

c i $y = 2^{x-b} + c$

Substitute the point $(0, -5)$:

$$-5 = 2^{-b} + c \quad [1]$$

Substitute the point $(3, 9)$:

$$9 = 2^{3-b} + c \quad [2]$$

Subtract equation [1] from equation [2]:

$$\therefore 14 = 2^{3-b} - 2^{-b}$$

$$\therefore 14 = 2^3 \times 2^{-b} - 2^{-b}$$

$$\therefore 14 = 8 \times 2^{-b} - 2^{-b}$$

$$\therefore 14 = 7 \times 2^{-b}$$

$$\therefore 2 = 2^{-b}$$

$$\therefore b = -1$$

Substitute $b = -1$ in equation [1]:

$$\therefore -5 = 2 + c$$

$$\therefore c = -7$$

Hence, $b = -1$, $c = -7$.

- ii** The equation of the graph is $y = 2^{x+1} - 7$. Its asymptote is $y = -7$ and the given points lie above this asymptote. Therefore, the range of the graph is $(-7, \infty)$.

d i $y = Ae^{x-2} + B$

The long-term behaviour $x \rightarrow -\infty$, $y \rightarrow -2$ means there is an asymptote at $y = -2$.

Therefore, $B = -2$ and the equation becomes

$$y = Ae^{x-2} - 2.$$

Substitute the point $(2, 10)$:

$$\therefore 10 = Ae^0 - 2$$

$$\therefore A = 12$$

Answer: $A = 12$, $B = -2$

- ii** The equation is $y = 12e^{x-2} - 2$.

Substitute the point $\left(a, 2\left(\frac{6}{e} - 1\right)\right)$:

$$\therefore 2\left(\frac{6}{e} - 1\right) = 12e^{a-2} - 2$$

$$\therefore 12e^{-1} - 2 = 12e^{a-2} - 2$$

$$\therefore e^{-1} = e^{a-2}$$

$$\therefore a - 2 = -1$$

$$\therefore a = 1$$

9 a $f(x) = 2 \log_e(3x + 3)$

Domain = $(-1, \infty)$ and range = R

Inverse: swap x and y .

$$x = 2 \log_e(3y + 3)$$

$$\frac{x}{2} = \log_e(3y + 3)$$

$$e^{\frac{x}{2}} = 3y + 3$$

$$e^{\frac{x}{2}} - 3 = 3y$$

$$y = \frac{1}{3}e^{\frac{x}{2}} - 1$$

$$f^{-1}(x) = \frac{1}{3}e^{\frac{x}{2}} - 1$$

Domain = R and range = $(-1, \infty)$

b $f(x) = \log_e(2(x-1)) + 2$

Domain = $(1, \infty)$ and range = R

Inverse: swap x and y .

$$x = \log_e(2(y-1)) + 2$$

$$x - 2 = \log_e(2(y-1))$$

$$e^{x-2} = 2(y-1)$$

$$\frac{1}{2}e^{x-2} = y - 1$$

$$y = \frac{1}{2}e^{x-2} + 1$$

$$f^{-1}(x) = \frac{1}{2}e^{x-2} + 1$$

Domain = R and range = $(1, \infty)$

c $f(x) = 2 \log_e(1-x) - 2$

Domain = $(-\infty, 1)$ and range = R

Inverse: swap x and y .

$$x = 2 \log_e(1-y) - 2$$

$$x + 2 = 2 \log_e(1-y)$$

$$\frac{1}{2}(x+2) = \log_e(1-y)$$

$$e^{\frac{x}{2}(x+2)} = 1-y$$

$$y = 1 - e^{\frac{1}{2}(x+2)}$$

$$f^{-1}(x) = 1 - e^{\frac{1}{2}(x+2)}$$

Domain = R and range = $(-\infty, 1)$

10 a

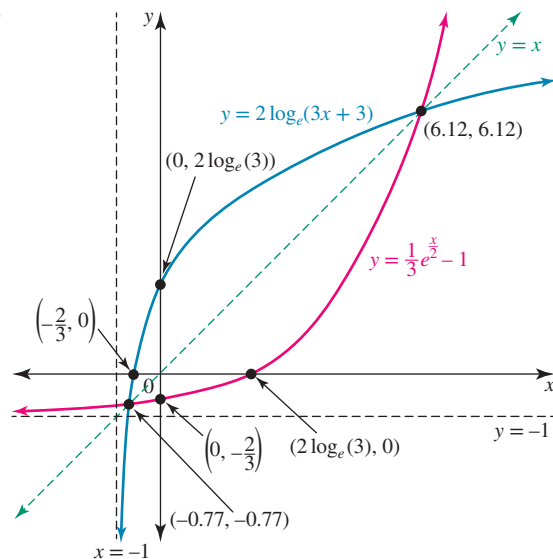

b

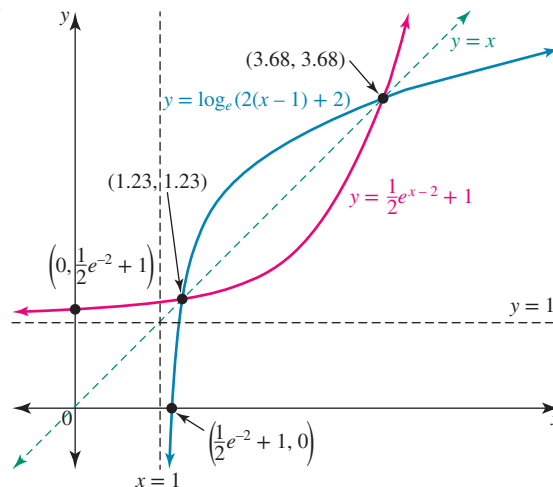

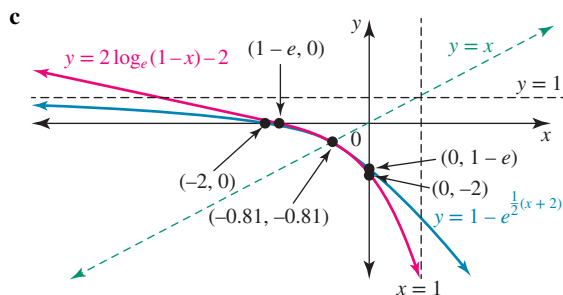

- 11 The domain is R for both $f(x) = 2^x$ and $g(x) = 2^{-x}$.

$$\Rightarrow d_f \cap d_g = R$$

The domain of $f - g$ is R .

$$y = (f - g)(x)$$

$$= f(x) - g(x)$$

$$= 2^x - 2^{-x}$$

To sketch the difference function, sketch it as

$y = f(x) + (-g(x))$ and add y-coordinates.

x	-1	0	1
$f(x)$	$\frac{1}{2}$	1	2
$-g(x)$	-2	-1	$-\frac{1}{2}$
$f(x) + (-g(x))$	$-1\frac{1}{2}$	0	$1\frac{1}{2}$

As $x \rightarrow \infty$, the graph of f dominates and as $x \rightarrow -\infty$, the graph of $-g$ dominates.

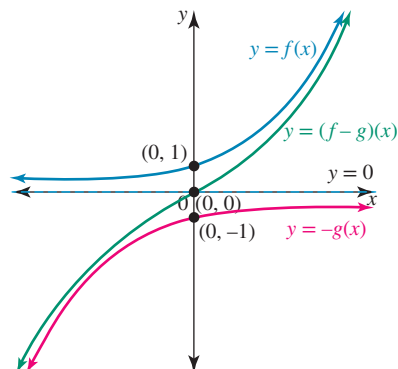

The range of the graph is R .

- 12 Draw the graphs of $y_1 = e^x$ and $y_2 = e^{-x}$ on the same of axes and add their ordinates.

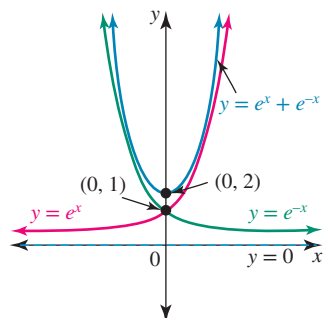

4.6 Exam questions

- 1 $f: R^+ \rightarrow R, f(x) = k \log_2(x), k \in R$

$$f^{-1}(1) = 8 \Leftrightarrow f(8) = 1$$

$$f(8) = k \log_2(8) = 1$$

$$\log_2(8) = \frac{1}{k}$$

$$2^{\frac{1}{k}} = 8 = 2^3$$

$$\frac{1}{k} = 3$$

$$k = \frac{1}{3}$$

The correct answer is **B**.

- 2 For the function $f, y = 3$ is a horizontal asymptote that crosses the y -axis at $(0, 2)$.

The inverse function f^{-1} has $x = 3$ as a vertical asymptote that crosses the x -axis at $(2, 0)$.

The correct answer is **E**.

- 3 All of A, B, C, and E are true, and D is false when $y = 0$.

$$2 - e^{-x} = 0 \Rightarrow e^{-x} = 2 \text{ or } e^{-x} = \frac{1}{2}, \text{ so } x = \log_e\left(\frac{1}{2}\right).$$

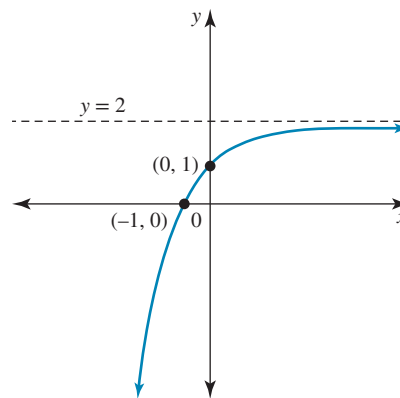

The correct answer is **D**.

4.7 Applications

4.7 Exercise

- 1 $A = Pe^{rt}$

Western Bank: $P = \$4200, r = 5\% = 0.05$ so $A = 4200e^{0.05t}$

Common Bank:

$P = \$5500, r = 4.5\% = 0.045$ so $A = 5500e^{0.045t}$

Investments equal in value when

$$\frac{e^{0.05t}}{e^{0.045t}} = \frac{5500}{4200}$$

$$e^{0.005t} = \frac{55}{42}$$

$$\log_e\left(\frac{55}{42}\right) = 0.005t$$

$$\log_e\left(\frac{55}{42}\right) \div 0.005 = t$$

$$t = 53.9327$$

It takes 54 years for the amounts to be equal.

$$2 \quad A = Pe^{rt}$$

When $t = 10$, $P = \$1000$ and $r = \frac{5}{100} = 0.05$,

$$A = 1000e^{0.05(10)}$$

$$A = \$1648.72$$

$$3 \quad a \quad A = Pe^{rt}$$

$$A = 3P, \quad t = 15$$

$$3P = Pe^{15r}$$

$$3 = e^{15r}$$

$$\log_e(3) = 15r$$

$$\frac{\log_e(3)}{15} = r$$

$$r = 0.0732$$

The interest rate of the investment is 7.32%.

$$b \quad A = Pe^{rt}$$

$$P = \$2000, \quad r = 4.5\% = 0.045, \quad A = \$9000$$

$$9000 = 2000e^{0.045t}$$

$$\frac{9000}{2000} = e^{0.045t}$$

$$\log_e\left(\frac{9}{2}\right) = 0.045t$$

$$\log_e\left(\frac{9}{2}\right) \div 0.045 = t$$

$$t = 33.42$$

It takes 33 years and 5 months for the investment to grow to \$9000.

$$4 \quad n(t) = \log_e(t + e^2), \quad t \geq 0$$

$$a \quad \text{Initially } t = 0, \quad n(0) = \log_e(e^2) = 2 \log_e(e) = 2$$

Initially there were 2 parts per million.

$$b \quad \text{When } t = 12, \quad n(12) = \log_e(12 + e^2) = 2.9647$$

After 12 hours there are 2.96 parts per million.

$$c \quad \text{When } n(t) = 4,$$

$$4 = \log_e(t + e^2)$$

$$e^4 = t + e^2$$

$$e^4 - e^2 = t$$

$$t = 47.2$$

It takes 47.2 hours before the four parts in a million of fungal bloom exists.

$$5 \quad a \quad P(t) = 83 - 65e^{-0.2t}, \quad t \geq 0$$

$$P(0) = 83 - 65e^0$$

$$= 18$$

There were 18 possums initially.

$$b \quad P(1) = 83 - 65e^{-0.2}$$

$$\approx 30$$

The population has increased by 12.

$$c \quad \text{Let } P = 36$$

$$\therefore 36 = 83 - 65e^{-0.2t}$$

$$\therefore 65e^{-0.2t} = 47$$

$$\therefore e^{-0.2t} = \frac{47}{65}$$

$$\therefore -0.2t = \log_e\left(\frac{47}{65}\right)$$

$$\therefore t = -5 \log_e\left(\frac{47}{65}\right)$$

$$\approx 1.62$$

The population doubled in 1.62 months.

$$d \quad P(t) = 83 - 65e^{-0.2t}, \quad t \geq 0$$

Horizontal asymptote at $P = 83$. Points $(0, 18)$, $(1, 30)$ and $(1.62, 36)$ lie on, or close to, the graph.

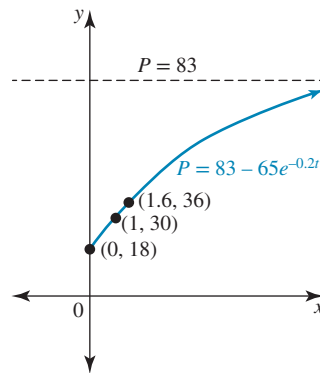

e The presence of the asymptote at $P = 83$ shows that as $t \rightarrow \infty$, $P \rightarrow 83$. The population can never exceed 83, so the population cannot grow to 100.

$$6 \quad P(t) = 200^{kt} + 1000$$

Initially $t = 0$, so $P(0) = 200^0 + 1000 = 1001$.

When $t = 8$ and $P = 3 \times 1001 = 3003$,

$$3003 = 200^{8k} + 1000$$

$$2003 = 200^{8k}$$

$$\log_e(2003) = \log_e(200)^{8k}$$

$$\log_e(2003) = 8k \log_e(200)$$

$$\frac{\log_e(2003)}{\log_e(200)} = 8k$$

$$\frac{\log_e(2003)}{8 \log_e(200)} = k$$

$$k = 0.1793$$

$$7 \quad P(t) = \frac{3}{4}(1 - e^{-kt}) \quad \text{and when } t = 3 \quad \text{and } P = \frac{1}{1500},$$

$$\frac{1}{1500} = \frac{3}{4}(1 - e^{-3k})$$

$$\frac{4}{4500} = 1 - e^{-3k}$$

$$e^{-3k} = 1 - \frac{4}{4500}$$

$$e^{-3k} = 0.999$$

$$\log_e(0.999) = -3k$$

$$-\frac{1}{3} \log_e(0.999) = k$$

$$k = 0.0003$$

$$8 \quad Q = Q_0 e^{-0.000124t}$$

$$a \quad \text{When } Q_0 = 100 \quad \text{and } t = 1000,$$

$$Q = 100e^{-0.000124(1000)}$$

$$Q = e^{-0.124}$$

$$Q = 88.3 \text{ milligrams}$$

$$b \quad \text{When } Q = \frac{1}{2}Q_0 = 50,$$

$$50 = 100e^{-0.000124t}$$

$$0.5 = e^{-0.000124t}$$

$$\log_e(0.5) = -0.000124t$$

$$\frac{\log_e(0.5)}{-0.000124} = t$$

$$t = 5589.897$$

It takes 5590 years for the amount of carbon-14 in the fossil to be halved.

$$9 \quad W = W_0(0.805)^t$$

a When $t = 10$,

$$W = W_0(0.805)^{10} = 0.11428W_0.$$

There are $0.114W_0$ words remaining after 10 millennia, or 88.57% of the words have been lost.

b $W = \frac{2}{3}W_0$ since one-third of the basic words have been lost.

$$\frac{2}{3}W_0 = W_0(0.805)^t$$

$$\frac{2}{3} = (0.805)^t$$

$$\log_e \left(\frac{2}{3} \right) = \log_e (0.805)^t$$

$$\log_e \left(\frac{2}{3} \right) = t \log_e (0.805)$$

$$\log_e \left(\frac{2}{3} \right) \div \log_e (0.805) = t$$

$$t = 1.87$$

It takes 1.87 millennia to lose a third of the basic words.

$$10 \quad F(t) = 10 + 2 \log_e(t + 2)$$

a When $t = 0$, $F(0) = 10 + 2 \log_e(2) = 11.3863$.

b When $t = 4$,

$$F(0) = 10 + 2 \log_e(4 + 2)$$

$$= 10 + 2 \log_e(6)$$

$$= 13.5835$$

c When $F = 15$,

$$15 = 10 + 2 \log_e(t + 2)$$

$$5 = 2 \log_e(t + 2)$$

$$\frac{5}{2} = \log_e(t + 2)$$

$$e^{\frac{5}{2}} = t + 2$$

$$e^{\frac{5}{2}} - 2 = t$$

$$t = 10.18$$

After 10.18 weeks Andrew's level of fitness is 15.

$$11 \quad Q = Q_0 e^{-0.000124t}$$

When $Q = 20\%$ of $Q_0 = 0.2Q_0$,

$$0.2Q_0 = Q_0 e^{-0.000124t}$$

$$0.2 = e^{-0.000124t}$$

$$\log_e(0.2) = -0.000124t$$

$$\frac{\log_e(0.2)}{-0.000124} = t$$

$$t = 12979$$

The age of the painting is 12979 years.

$$12 \quad R(x) = 800 \log_e \left(2 + \frac{x}{250} \right) \text{ and } C(x) = 300 + 2x$$

a $P(x) = R(x) - C(x)$

$$P(x) = 800 \log_e \left(2 + \frac{x}{250} \right) - 300 - 2x$$

b When $P(x) = 0$,

$$800 \log_e \left(2 + \frac{x}{250} \right) - 300 - 2x = 0$$

$$800 \log_e \left(2 + \frac{x}{250} \right) = 300 + 2x$$

$$x = 329.9728$$

$$x \approx 330$$

330 units are needed to break even.

$$13 \quad a \quad V = ke^{mt}$$

When $t = 0$, $V = 10000$.

$$10000 = ke^0$$

$$10000 = k$$

$$V = 10000e^{mt}$$

When $t = 12$, $V = 13500$.

$$13500 = 10000e^{12m}$$

$$1.35 = e^{12m}$$

$$\log_e(1.35) = 12m$$

$$\frac{1}{12} \log_e(1.35) = m$$

$$0.025 = m$$

$$V = 10000e^{0.025t}$$

b When $t = 18$, $V = 10000e^{0.025(18)} = \15685.58 .

c Profit = P

$$P = 1.375 \times 10000e^{0.025t} - 10000$$

$$P = 13750e^{0.025t} - 10000$$

d When $t = 24$,

$$P = 13750e^{0.025(24)} - 10000 = \$15059.38.$$

$$14 \quad a \quad P = a \log_e(t) + c$$

When $t = 1$, $P = 10000$.

$$10000 = a \log_e(1)$$

$$10000 = c$$

$$P = a \log_e(t) + 10000$$

When $t = 4$, $P = 6000$.

$$6000 = a \log_e(4) + 10000$$

$$-4000 = a \log_e(4)$$

$$\frac{-4000}{\log_e(4)} = a$$

$$a = -2885.4$$

b $P = -2885.4 \log_e(t) + 10000$

$$P = 10000 - 2885.4 \log_e(t)$$

When $t = 8$,

$$P = 10000 - 2885.4 \log_e(8) = 4000.$$

There are 4000 after 8 weeks.

c When $P = 1000$,

$$1000 = 10000 - 2885.4 \log_e(t)$$

$$2885.4 \log_e(t) = 9000$$

$$\log_e(t) = \frac{9000}{2885.4}$$

$$\log_e(t) = 3.1192$$

$$e^{3.1192} = t$$

$$t = 22.6$$

After 22.6 weeks there will be fewer than 1000 trout.

$$15 \quad a \quad M = a - \log_e(t + b)$$

When $t = 0$, $M = 7.8948$,

$$7.8948 = a - \log_e(b) \quad [1]$$

When $t = 80$, $M = 7.3070$,

$$7.3070 = a - \log_e(80 + b) \quad [2]$$

$$[1] - [2]$$

$$7.8948 - 7.3070 = a - \log_e(b) - (a - \log_e(80 + b))$$

$$0.5878 = a - \log_e(b) - a + \log_e(80 + b)$$

$$0.5878 = \log_e(80 + b) - \log_e(b)$$

$$0.5878 = \log_e \left(\frac{80 + b}{b} \right)$$

$$e^{0.5878} = \frac{(80 + b)}{b}$$

$$1.8b = 80 + b$$

$$0.8b = 80$$

$$b = 100$$

Substitute $b = 100$ into [1]:

$$7.8948 = a - \log_e(100)$$

$$7.8948 + \log_e(100) = a$$

$$12.5 = a$$

$$M = 12.5 - \log_e(t + 100)$$

Thus, $a = 12.5$ and $b = 100$.

b When $t = 90$,

$$M = 12.5 - \log_e(90 + 100)$$

$$M = 12.5 - \log_e(190)$$

$$M = 7.253 \text{ g}$$

$$2 \text{ a } C = A \log_e(kt)$$

When $t = 2$, $C = 0.1$,

$$0.1 = A \log_e(2k) \quad [1]$$

When $t = 30$, $C = 4$,

$$4 = A \log_e(30k) \quad [2]$$

[2] \div [1]:

$$\frac{A \log_e(30k)}{A \log_e(2k)} = \frac{4}{0.1}$$

$$\log_e(30k) = 40 \log_e(2k)$$

$$\log_e(30) + \log_e(k) = 40(\log_e(2) + \log_e(k))$$

$$\log_e(30) + \log_e(k) = 40 \log_e(2) + 40 \log_e(k)$$

$$\log_e(30) - 40 \log_e(2) = 40 \log_e(k) - \log_e(k)$$

$$\log_e(30) - 40 \log_e(2) = 39 \log_e(k)$$

$$-24.3247 = 39 \log_e(k)$$

$$\frac{-24.3247}{39} = \log_e(k)$$

$$-0.6237 = \log_e(k)$$

$$e^{-0.6237} = k$$

$$k = 0.536 \quad [1 \text{ mark}]$$

Substitute $k = 0.536$ into [1]:

$$0.1 = A \log_e(2 \times 0.536)$$

$$0.1 = 0.0695A$$

$$A = 1.439$$

$$C = 1.439 \log_e(0.536t) \quad [1 \text{ mark}]$$

b When $t = 15$,

$$C = 1.439 \log_e(0.536 \times 15) = 2.999 \text{ M}$$

The concentration after 15 minutes is 2.999 M. [1 mark]

c When $C = 10$ M,

$$10 = 1.439 \log_e(0.536t)$$

$$6.9493 = \log_e(0.536t)$$

$$e^{6.9493} = 0.536t$$

$$1042.4198 = 0.536t$$

$$t = 1945 \text{ (to the nearest second)}$$

After 1945 seconds, or 32 minutes and 25 seconds, the concentration is 10 M. [1 mark]

$$3 \text{ } T = 20 + 75e^{-0.062t}$$

a When $t = 0$, $T = 20 + 75 = 95$, so the initial temperature was 95 °C. [1 mark]

b The exponential function has a horizontal asymptote at $T = 20$, so as $t \rightarrow \infty$, $T = 20$.

The temperature approaches 20 °C. [1 mark]

c Let $T = 65$.

$$\therefore 65 = 20 + 75e^{-0.062t}$$

$$\therefore e^{-0.062t} = \frac{45}{75}$$

$$\therefore e^{-0.062t} = \frac{3}{5}$$

$$\therefore -0.062t = \log_e\left(\frac{3}{5}\right)$$

$$\therefore t = -\frac{1}{0.062} \log_e\left(\frac{3}{5}\right)$$

$$\therefore t \approx 8.24 \quad [1 \text{ mark}]$$

It takes approximately 8.24 minutes to cool to 65 °C.

4.7 Exam questions

$$1 \text{ a } c(t) = \frac{5}{2}te^{-\frac{3t}{2}}$$

$$c'(t) = \frac{5}{4}e^{-\frac{3t}{2}}(2 - 3t)$$

For maximum or minimum:

$$c'(t) = 0$$

$$\Rightarrow 2 - 3t = 0$$

$$t = \frac{2}{3}$$

$$c\left(\frac{2}{3}\right) = \frac{5}{3}e^{-1} = 0.61 \text{ mg/L}$$

Award 1 mark for the correct maximum value.

VCAA Assessment Report note:

This question was answered well. Some students had incorrect units, such as mm for milligrams. Some left their answers in exact form. Some found t correct to two decimal places and left their answer as 0.67.

b Solving using CAS:

$$c(t) = 0.5 \Rightarrow t_1 = 0.33$$

Award 1 mark for the correct time.

VCAA Assessment Report note:

This question was answered well. Some students gave two answers, 0.33 and 1.19, instead of only the first one, as specified in the question. Some students rounded incorrectly and gave 0.32 as their answer.

$$c \text{ } c(t) = 0.5 \Rightarrow t_1 = 0.3263 \text{ } t_2 = 1.1876$$

$$t_2 - t_1 = 1.1876 - 0.3263$$

$$= 0.86 \text{ hours}$$

Award 1 mark for finding the other time.

Award 1 mark for subtracting times, correct to 2 decimal places

VCAA Assessment Report note:

Students should always work to suitable accuracy in intermediate calculations to support rounding the answer to the required accuracy. Some students wrote down the two values but did not find the difference for the length of time. Some added the two values. Some students incorrectly converted the time to minutes.

d $T = A + Be^{-0.062t}$

As the temperature cannot exceed 85 °C, $A = 85$. [1 mark]

$T = 85 + Be^{-0.062t}$

Substitute (8.24, 65):

$\therefore 65 = 85 + Be^{-0.05 \times 8.24}$

$\therefore e^{-0.412} = -20$

$\therefore B = -20e^{0.412}$

$\therefore B \approx -30$ [1 mark]

e $T = 20 + 75e^{-0.062t}$

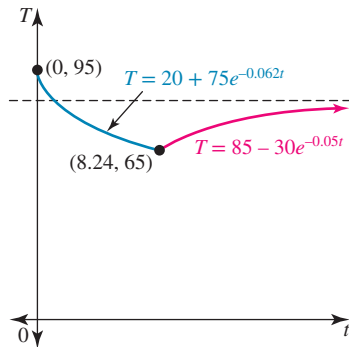

Award 1 mark for correct minimum and starting point.

Award 1 mark for correct graph shape.

Let $a = \log_4(x)$.

$2a^2 + 5a - 3 = 0$

$(2a - 1)(a + 3) = 0$

$2a - 1 = 0, a + 3 = 0$

$a = \frac{1}{2}, a = -3$

$\log_4(x) = \frac{1}{2}$

$x = 4^{\frac{1}{2}}$

$x = 2, \text{ since } x > 0$

$\log_4(x) = -3$

$x = 4^{-3}$

$x = \frac{1}{64}$

$\therefore x = 2, \frac{1}{64}$

b i $\log_2(y) = 2 \log_2(x) - 3$

$\log_2(y) = \log_2(x^2) - 3 \times \log_2(2)$

$\log_2(y) = \log_2(x^2) - \log_2(2^3)$

$\log_2(y) = \log_2\left(\frac{x^2}{8}\right)$

$y = \frac{x^2}{8}, (x > 0)$

ii $\log_3(9x) - \log_3(x^4y) = 2$

$\log_3(9x) - \log_3(x^4y) = 2 \times \log_3(3)$

$\log_3\left(\frac{9x}{x^4y}\right) = \log_3(3^2)$

$\log_3\left(\frac{9}{x^3y}\right) = \log_3(9)$

$\frac{9}{x^3y} = 9$

$y = \frac{1}{x^3}, (x > 0)$

c $\log_4\left(\frac{64q^2}{p^3\sqrt{q}}\right) = \log_4\left(\frac{64q^{\frac{3}{2}}}{p^3}\right)$

$= \log_4(64) + \log_4\left(q^{\frac{3}{2}}\right) - \log_4(p^3)$

$= \log_4(4^3) + \frac{3}{2} \log_4(q) - 3 \log_4(p)$

$= 3 \log_4(4) + \frac{3}{2} \log_4(q) - 3 \log_4(p)$

$= 3 + \frac{3}{2} \log_4(q) - 3 \log_4(p)$

Substitute in $\log_4(p) = x$ and $\log_4(q) = y$:

$\log_4\left(\frac{64q^2}{p^3\sqrt{q}}\right) = 3 + \frac{3}{2} \log_4(q) - 3 \log_4(p)$

$= 3 + \frac{3y}{2} - 3x$

$= 3 - 3x + \frac{3y}{2}$

2 a i $[H^+] = 0.01$

$= 10^{-2}$

$\text{pH} = -\log_{10}[H^+]$

$= -\log_{10}(10^{-2})$

4.8 Review

4.8 Exercise

Technology free: short answer

1 a i $2 \log_e(x) - \log_e(x-1) = \log_e(x-4)$

$\log_e(x)^2 = \log_e(x-4) + \log_e(x-1)$

$\log_e(x)^2 = \log_e((x-4)(x-1))$

$\log_e(x^2) = \log_e(x^2 - 5x + 4)$

$x^2 = x^2 - 5x + 4$

$0 = 4 - 5x$

$5x = 4$

$x = \frac{4}{5}$

ii $2 \log_e(x+2) - \log_e(x) = \log_e 3(x-1)$

$\log_e(x+2)^2 - \log_e(x) = \log_e(3x-3)$

$\log_e\left(\frac{(x+2)^2}{x}\right) = \log_e(3x-3)$

$\frac{(x+2)^2}{x} = 3x-3$

$(x+2)^2 = 3x^2 - 3x$

$x^2 + 4x + 4 = 3x^2 - 3x$

$-2x^2 + 7x + 4 = 0$

$2x^2 - 7x - 4 = 0$

$(2x+1)(x-4) = 0$

$2x+1 = 0, x-4 = 0$

$x = -\frac{1}{2}, x = 4$

Therefore, $x = 4$, since $x > 0$.

iii $2(\log_4(x))^2 = 3 - \log_4(x^5)$

$2(\log_4(x))^2 + 5 \log_4(x) - 3 = 0$

$$= -1 \times -2 \log_{10}(10)$$

$$= 2$$

Therefore, since $\text{pH} < 7$, vinegar is acidic.

ii $[\text{H}^+] = 10^{-11}$

$$\text{pH} = -\log_{10} [\text{H}^+]$$

$$= -\log_{10} (10^{-11})$$

$$= -1 \times -11 \log_{10}(10)$$

$$= 11$$

Therefore, since $\text{pH} < 7$, ammonia is basic.

b i $\text{pH} = 3$

$$-\log_{10} [\text{H}^+] = 3$$

$$\log_{10} [\text{H}^+] = -3$$

$$\log_{10} [\text{H}^+] = -3 \log_{10}(10)$$

$$\log_{10} [\text{H}^+] = \log_{10}(10^{-3})$$

$$[\text{H}^+] = 10^{-3}$$

$$= 0.001 \text{ moles/litre}$$

ii $\text{pH} = 14$

$$-\log_{10} [\text{H}^+] = 14$$

$$\log_{10} [\text{H}^+] = -14$$

$$\log_{10} [\text{H}^+] = -14 \log_{10}(10)$$

$$\log_{10} [\text{H}^+] = \log_{10}(10^{-14})$$

$$[\text{H}^+] = 10^{-14} \text{ moles/litre}$$

3 a $e^{2x} - 8e^x + 15 = 0$

$$(e^x)^2 - 8e^x + 15 = 0$$

$$\text{Let } a = e^x.$$

$$a^2 - 8a + 15 = 0$$

$$(a-3)(a-5) = 0$$

$$a = 3, a = 5$$

$$e^x = 3, e^x = 5$$

$$x = \log_e(3), x = \log_e(5)$$

b $2e^{2x} - 35 = 9e^x$

$$2e^{2x} - 9e^x - 35 = 0$$

$$2(e^x)^2 - 9e^x - 35 = 0$$

$$\text{Let } a = e^x.$$

$$2a^2 - 9a - 35 = 0$$

$$(2a+5)(a-7) = 0$$

$$2a+5=0, a-7=0$$

$$a = -\frac{5}{2}, a = 7$$

$$e^x = -\frac{5}{2}, e^x = 7$$

$$\therefore x = \log_e(7), (e^x > 0)$$

c $2^x + 18 \times 2^{-x} = 11$

$$2^x + \frac{18}{2^x} = 11$$

$$(2^x)^2 + 18 = 11 \times 2^x$$

$$(2^x)^2 - 11 \times 2^x + 18 = 0$$

$$\text{Let } a = 2^x.$$

$$a^2 - 11a + 18 = 0$$

$$(a-2)(a-9) = 0$$

$$a = 2, a = 9$$

$$2^x = 2, 2^x = 9$$

$$x = 1, x = \log_2(9)$$

4 a $3^{kx} \times 9^{2m} = 27$, where $k \in \mathbb{R} \setminus \{0\}$ and $m \in \mathbb{R}$

$$3^{kx} \times 9^{2m} = 27$$

$$3^{kx} \times (3^2)^{2m} = 3^3$$

$$3^{kx} \times 3^{4m} = 3^3$$

$$\therefore kx + 4m = 3$$

$$kx = 3 - 4m$$

$$x = \frac{3 - 4m}{k}, \text{ where } k \in \mathbb{R} \setminus \{0\} \text{ and } m \in \mathbb{R}$$

b $3e^{kx} - 4 = 6e^{-kx}$, where $k \in \mathbb{R} \setminus \{0\}$

$$3e^{kx} - 4 = 6e^{-kx}$$

$$3e^{kx} - 4 = \frac{6}{e^{kx}}$$

$$3(e^{kx})^2 - 4e^{kx} = 6$$

$$3(e^{kx})^2 - 4e^{kx} - 6 = 0$$

$$\text{Let } e^{kx} = a.$$

$$3a^2 - 4a - 6 = 0$$

$$\Delta = (-4)^2 - 4 \times 3 \times -6$$

$$= 88$$

$$a = \frac{4 \pm \sqrt{88}}{6}$$

$$= \frac{4 \pm 2\sqrt{22}}{6}$$

$$= \frac{2 \pm \sqrt{22}}{3}$$

$$\therefore e^{kx} = \frac{2 \pm \sqrt{22}}{3}$$

$$kx = \log_e \left(\frac{2 \pm \sqrt{22}}{3} \right)$$

$$kx = \log_e \left(\frac{2 + \sqrt{22}}{3} \right), \left(\text{as } \frac{2 - \sqrt{22}}{3} < 0 \right)$$

$$x = \frac{1}{k} \log_e \left(\frac{2 + \sqrt{22}}{3} \right), \text{ where } k \in \mathbb{R} \setminus \{0\}$$

5 a $y = \log_e(x-1) + 3$

$$x - \text{int} \Rightarrow (y = 0)$$

$$0 = \log_e(x-1) + 3$$

$$\log_e(x-1) = -3$$

$$e^{-3} = x-1$$

$$x = e^{-3} + 1$$

$$\Rightarrow (e^{-3} + 1, 0)$$

$$y - \text{int} \Rightarrow (x = 0)$$

$$y = \log_e(0-1) + 3$$

Therefore no y-intercept since for $\log_e(a)$, $a > 0$

Asymptote: $x = 1$

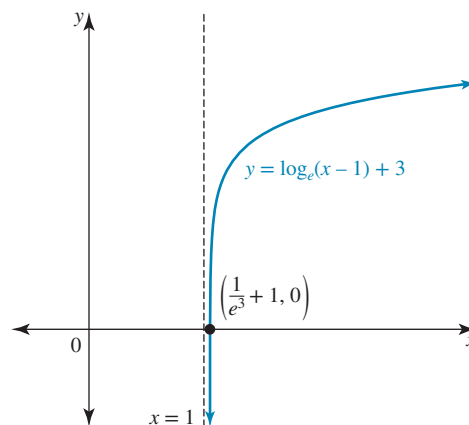

Dom = $(1, \infty)$ and ran = \mathbb{R}

b $y = \log_e(x+3) - 1$

$$x - \text{int} \Rightarrow (y = 0)$$

$$0 = \log_e(x+3) - 1$$

$$\log_e(x+3) = 1$$

$$e^1 = x+3$$

$$x = e - 3$$

$$\Rightarrow (e - 3, 0)$$

$$y - \text{int} \Rightarrow (x = 0)$$

$$y = \log_e(0+3) - 1$$

$$= \log_e(3) - 1$$

$$\Rightarrow (0, \log_e(3) - 1)$$

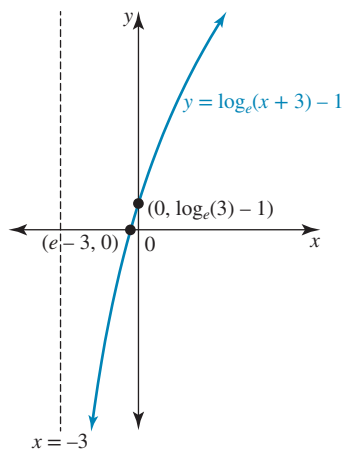
 Asymptote: $x = -3$

 Dom = $(-3, \infty)$ and ran = R

c $y = 2 \log_e(-x)$

$$x - \text{int} = (y = 0)$$

$$0 \Rightarrow 2 \log_e(-x)$$

$$\log_e(-x) = 0$$

$$-x = e^0$$

$$-x = 1$$

$$x = -1$$

$$\Rightarrow (-1, 0)$$

$$y - \text{int} \Rightarrow (x = 0)$$

$$y = 2 \log_e(0)$$

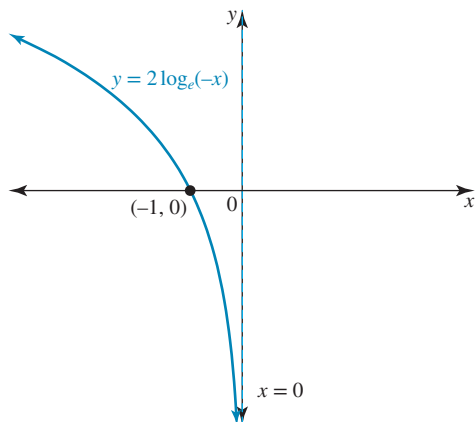
 Therefore no y -intercept since for $\log_e(a)$, $a > 0$
 Asymptote: $x = 0$

 Dom = $(-\infty, 0)$ and ran = R

d $y = -\log_e(x-4)$

$$x - \text{int} \Rightarrow (y = 0)$$

$$0 = -\log_e(x-4)$$

$$\log_e(x-4) = 0$$

$$x-4 = e^0$$

$$x = 1+4$$

$$x = 5$$

$$\Rightarrow (5, 0)$$

$$y - \text{int} \Rightarrow (x = 0)$$

$$y = -\log_e(0-4)$$

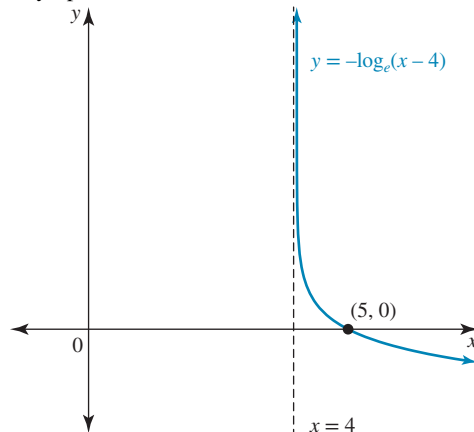
 Therefore no y -intercept since for $\log_e(a)$, $a > 0$
 Asymptote: $x = 4$

 Dom = $(4, \infty)$ and Ran = R

6 a $y = 6 \times 2^{x-1} - 12$

 Horizontal asymptote $y = -12$
 y -intercept: let $x = 0$.

$$y = 6 \times 2^{-1} - 12 = -9 \Rightarrow (0, -9).$$

 x -intercept: let $y = 0$.

$$6 \times 2^{x-1} - 12 = 0$$

$$\therefore 2^{x-1} = 2$$

$$\therefore x-1 = 1$$

$$\therefore x = 2$$

 $(2, 0)$

 Point: let $x = 1$, then $y = 6 - 12 = -6$.

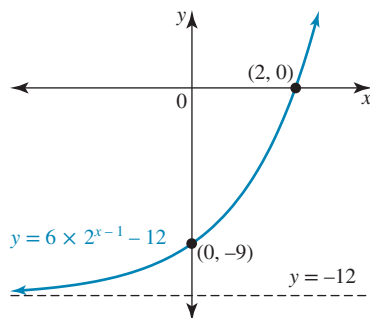
 $(1, -6)$

 Range $(-12, \infty)$

b $y = \frac{1}{2}(e^{3-x} + 5)$

$$\therefore y = \frac{1}{2}e^{-(x-3)} + \frac{5}{2}$$

 Horizontal asymptote $y = \frac{5}{2}$
 y -intercept: let $x = 0$.

$$y = \frac{1}{2}e^3 + \frac{5}{2} \approx 12.54$$

$$\left(0, \frac{1}{2}e^3 + \frac{5}{2}\right)$$

No x -intercept

Point: let $x = 3$, then $y = \frac{1}{2} + \frac{5}{2} = 3$. The point $(3, 3)$ is on the curve.

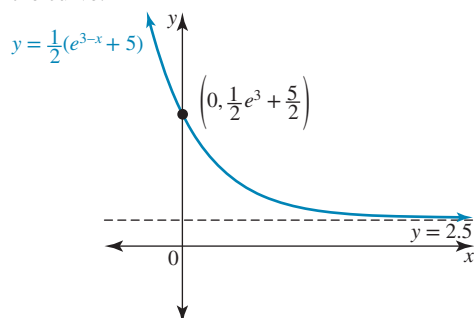

Range $(2.5, \infty)$

7 a $L = 90$

$$90 = 10 \log_{10} \left(\frac{I}{10^{-12}} \right)$$

$$\log_{10} \left(\frac{I}{10^{-12}} \right) = \frac{90}{10}$$

$$\log_{10} \left(\frac{I}{10^{-12}} \right) = 9$$

$$\frac{I}{10^{-12}} = 10^9$$

$$I = 10^9 \times 10^{-12}$$

$$I = 10^{-3}$$

$$= 0.001 \text{ watt/m}^2$$

b $I = 10^{-6}$

$$L = 10 \log_{10} \left(\frac{10^{-6}}{10^{-12}} \right)$$

$$= 10 \log_{10} (10^6)$$

$$= 10 \times 6 \log_{10} (10)$$

$$= 60 \text{ dB}$$

Technology active: multiple choice

8 $3 \log_e(5) + 2 \log_e(2) - \log_e(20)$

$$= \log_e(5)^3 + \log_e(2)^2 - \log_e(20)$$

$$= \log_e(125) + \log_e(4) - \log_e(20)$$

$$= \log_e \left(\frac{125 \times 4}{20} \right)$$

$$= \log_e(25)$$

$$= \log_e(5)^2$$

$$= 2 \log_e(5)$$

The correct answer is **D**.

9 $(2, 0) \Rightarrow$

$$0 = a \log_e(2b)$$

$$0 = \log_e(2b)$$

$$2b = 1$$

$$b = \frac{1}{2}$$

$$\therefore y = a \log_e \left(\frac{x}{2} \right)$$

$$\left(1, -3 \log_e \left(\frac{x}{2} \right) \right) \Rightarrow$$

$$-3 \log_e(2) = a \log_e \left(\frac{1}{2} \right)$$

$$3 \log_e(2)^{-1} = a \log_e \left(\frac{1}{2} \right)$$

$$3 \log_e \left(\frac{1}{2} \right) = a \log_e \left(\frac{1}{2} \right)$$

$$a = 3$$

$$\therefore y = 3 \log_e \left(\frac{x}{2} \right)$$

Therefore, to find m , substitute $x = 3$ into the equation.

$$y = 3 \log_e \left(\frac{x}{2} \right)$$

$$= 3 \log_e \left(\frac{3}{2} \right)$$

$$\therefore a = 3, b = \frac{1}{2}, m = 3 \log_e \left(\frac{3}{2} \right)$$

The correct answer is **E**.

10 $5 \log_{10}(x) - \log_{10}(x^2) = 1 + \log_{10}(y)$

$$5 \log_{10}(x) - 2 \log_{10}(x) = \log_{10}(10) + \log_{10}(y)$$

$$3 \log_{10}(x) = \log_{10}(10y)$$

$$\log_{10}(x)^3 = \log_{10}(10y)$$

$$x^3 = 10y$$

$$x = \sqrt[3]{10y}$$

The correct answer is **C**.

11 $3^{2x+1} - 4 \times 3^x + 1 = 0$

$$3^{2x} \times 3^1 - 4 \times 3^x + 1 = 0$$

$$3 \times 3^{2x} - 4 \times 3^x + 1 = 0$$

$$3 \times (3^x)^2 - 4 \times 3^x + 1 = 0$$

Let $a = 3^x$.

$$3a^2 - 4a + 1 = 0$$

$$(3a - 1)(a - 1) = 0$$

$$3a - 1 = 0, a - 1 = 0$$

$$a = \frac{1}{3}, a = 1$$

Therefore, substitute back into $a = 3^x$.

$$3^x = \frac{1}{3}, 3^x = 1$$

$$3^x = 3^{-1}, 3^x = 3^0$$

$$x = -1, x = 0$$

The correct answer is **A**.

12 $e^{(3 \log_e(x) - \log_e(3x))} = e^{(\log_e(x)^3 - \log_e(3x))}$

$$= e^{\log_e \left(\frac{x^3}{3x} \right)}$$

$$= e^{\log_e \left(\frac{x^2}{3} \right)}$$

$$= \frac{x^2}{3}$$

The correct answer is **E**.

13 Using the change of base rule,

$$\log_n(m) + \log_m(p) + \log_p(n)$$

$$= \frac{\log_m(m)}{\log_m(n)} + \frac{\log_p(p)}{\log_p(m)} + \frac{\log_n(n)}{\log_n(p)}$$

$$= \frac{1}{\log_m(n)} + \frac{1}{\log_p(m)} + \frac{1}{\log_n(p)}$$

The correct answer is **B**.

14

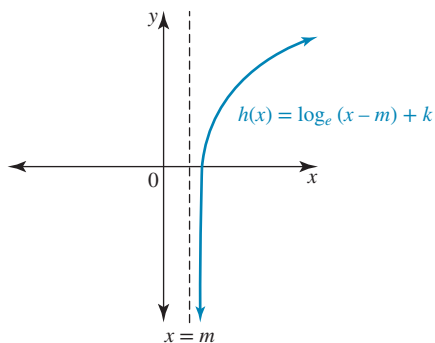

$h(x) = \log_e(x - m) + k$ has a maximal domain of (m, ∞) .
The correct answer is **E**.

15 $7e^{ax} = 3$

$$e^{ax} = \frac{3}{7}$$

$$e^{ax} = \frac{3}{7}$$

$$ax = \log_e\left(\frac{3}{7}\right)$$

$$x = \frac{1}{a} \log_e\left(\frac{3}{7}\right)$$

The correct answer is **C**.

16 $\log_e(4e^{3x}) = \log_e(4) + \log_e(e^{3x})$
 $= \log_e(4) + 3x \log_e(e)$
 $= \log_e(4) + 3x$

The correct answer is **E**.

 17 The asymptote is $y = 2$ and the graph passes through $(0, 1)$.

The equation is of the form $y = ae^{kx} + 2$.

Its orientation is $a < 0$, $k > 0$

The correct answer is **A**.

Technology active: extended response

 18 a i $f: y = \log_e(x + 5) + 1$, where $\text{dom} = (-5, \infty)$ and $\text{ran} = \mathbb{R}$.

To find the inverse f^{-1} : swap x and y and rearrange for y .

$$x = \log_e(y + 5) + 1$$

$$\log_e(y + 5) = x - 1$$

$$y + 5 = e^{(x-1)}$$

$$y = e^{(x-1)} - 5$$

Then the domain of f becomes the range of f^{-1} and the range of f becomes the domain of f^{-1} .

The inverse is $y = f^{-1}(x) = e^{(x-1)} - 5$, where $\text{dom} = \mathbb{R}$ and $\text{ran} = (-5, \infty)$.

ii

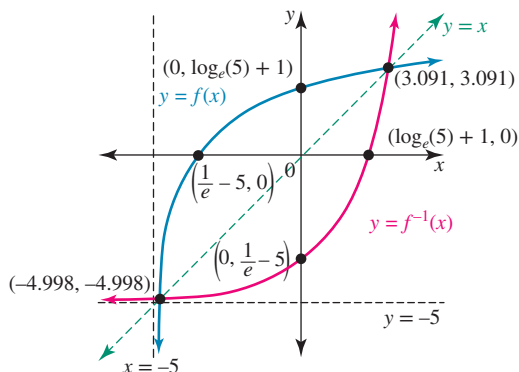
 iii Point of intersection(s) when $f(x) = x$

Solve on CAS for x .

$$\log_e(x + 5) + 1 = x$$

$$x = -4.998, x = 3.091$$

The points of intersection are $(-4.998, -4.998)$ and $(3.091, 3.091)$.

 b i $g(x) = \log_e(x - h) + k$

As $x = -2$ is a vertical asymptote, $h = -2$.

$$g(x) = \log_e(x + 2) + k$$

 ii When $x = 0$, $g(0) = 0$.

$$0 = \log_e(0 + 2) + k$$

$$0 = \log_e(2) + k$$

$$k = -\log_e(2) \text{ as required}$$

 iii $g(x) = \log_e(x + 2) - \log_e(2)$

$$= \log_e\left(\frac{x + 2}{2}\right)$$

 19 a When $Q_0 = 150$ milligrams and $t = 2000$,

$$Q = 150e^{-0.000124(2000)}$$

$$Q = 117.054 \text{ milligrams}$$

 b When $Q = 75$ milligrams,

$$75 = 150e^{-0.000124t}$$

$$0.5 = e^{-0.000124t}$$

$$-0.000124t = \log_e(0.5)$$

$$t = \frac{\log_e(0.5)}{-0.000124}$$

$$t = 5590$$

It takes 5590 years for the carbon-14 to be halved.

c $Q = \frac{Q_0}{n} = \frac{150}{n}$

$$\frac{150}{n} = 150e^{-0.000124t}$$

$$\frac{1}{n} = e^{-0.000124t}$$

$$\frac{1}{n} = \frac{1}{e^{0.000124t}}$$

$$n = e^{0.000124t}$$

When $n = 10$,

$$10 = e^{0.000124t}$$

$$0.000124t = \log_e(10)$$

$$t = \frac{\log_e(10)}{0.000124}$$

$$t = 18569$$

It takes 18 569 years.

 20 a $P = a \log_e(t) + b$

When $t = 1$, $P = 150$,

$$150 = a \log_e(1) + b$$

$$150 = a \times 0 + b$$

$$b = 150$$

$$\therefore P = a \log_e(t) + 150$$

When $t = 6$, $P = 6000$,

$$6000 = a \log_e(6) + 150$$

$$5850 = a \log_e(6)$$

$$a = \frac{5850}{\log_e(6)}$$

$$a = 3264.947$$

$$a = 3265$$

$$\therefore P = 3265 \log_e(t) + 150$$

$$a \approx 3265, b = 150$$

b In 2020, $t = 13$,

$$P = 3265 \log_e(13) + 150 \\ = 8525$$

Therefore, there were expected to be 8525 quokkas in 2020.

c i $P_R = P - 0.25P$

$$P_R = 0.75P$$

$$P_R = 0.75 (3265 \log_e(t) + 150)$$

$$P_R = 2448.75 \log_e(t) + 112.5$$

ii In 2020, $t = 13$,

$$P_R = 2448.75 \log_e(13) + 112.5$$

$$P_R = 6393$$

The revised population for 2020 is 6393 quokkas.

$$\therefore -0.3466t = \log_e\left(\frac{1}{20}\right)$$

$$\therefore t = -\frac{1}{0.3466} \log_e\left(\frac{1}{20}\right)$$

$$\therefore t \approx 8.64$$

As the graph is decreasing, the temperature will be less than 22°C when $t > 8.64$.

The temperature is less than 22°C from approximately 9:38 pm onwards. [1 mark]

e As $t \rightarrow \infty$, $T \rightarrow 18$, the horizontal asymptote value. In the long run, the temperature cools to 18°C . [1 mark]

3 a $N = 22 \times 2^t$

Let $N = 2816$.

$$\therefore 2816 = 22 \times 2^t$$

$$\therefore 2^t = 128$$

$$\therefore 2^t = 2^7$$

$$\therefore t = 7$$

In 7 days the number of bacteria reaches 2816. [1 mark]

b As $t \rightarrow \infty$, $N \rightarrow \infty$, so the number of bacteria will increase without limit. [1 mark]

c i $N = \frac{66}{1 + 2e^{-0.2t}}$

Let $t = 0$.

$$\therefore N = \frac{66}{1 + 2e^0}$$

$$\therefore N = \frac{66}{3}$$

$$\therefore N = 22 \quad [1 \text{ mark}]$$

Reconsider the first model, $N = 22 \times 2^t$.

If $t = 0$, $N = 22$. [1 mark]

Both models have an initial number of 22 bacteria.

ii As $t \rightarrow \infty$, $e^{-0.2t} \rightarrow 0$.

$$\text{Therefore } N \rightarrow \frac{66}{1 + 0} = 66.$$

The number of bacteria will never exceed 66. [1 mark]

4 a $P(t) = Ae^{kt}$

When $t = 0$, $P(0) = 200$,

$$200 = Ae^0$$

$$200 = A \times 1$$

$$A = 200 \quad [1 \text{ mark}]$$

$$\therefore P(t) = 200e^{kt}$$

When $t = 30$, $P(30) = 1000$,

$$1000 = 200e^{30k}$$

$$5 = e^{30k}$$

$$30k = \log_e(5)$$

$$k = \frac{\log_e(5)}{30}$$

$$k = 0.0536 \quad [1 \text{ mark}]$$

$$\therefore P(t) = 200e^{0.0536t}$$

b When $t = 60$,

$$Pr(60) = 200e^{0.0536(60)}$$

$$\approx 4986$$

Therefore, there were 4986 expected cases after 60 days. [1 mark]

c When $P(t) = 6000$,

$$P(t) = 200e^{0.0536t}$$

$$6000 = 200e^{0.0536t}$$

$$30 = e^{0.0536t}$$

$$0.0536t = \log_e(30)$$

4.8 Exam questions

1 $y = \log_e(x) + \log_e(2x)$

$$= \log_e(2x^2)$$

The correct answer is C.

2 $T = Ae^{-kt} + 18$

a When $t = 0$, $T = 98$.

$$\therefore 98 = A + 18$$

$$\therefore A = 80 \quad [1 \text{ mark}]$$

The rule becomes $T = 80e^{-kt} + 18$.

At 3 pm, $t = 2$ and $T = 58$.

$$\therefore 58 = 80e^{-2k} + 18$$

$$\therefore e^{-2k} = \frac{1}{2}$$

$$\therefore -2k = \log_e\left(\frac{1}{2}\right)$$

$$\therefore k = -\frac{1}{2} \log_e\left(\frac{1}{2}\right)$$

$$\therefore k \approx 0.3466 \quad [1 \text{ mark}]$$

b $T = 80e^{-0.3466t} + 18$

At 11 pm, $t = 10$.

$$\therefore T = 80e^{-3.466} + 18$$

$$\therefore T \approx 20.5 \quad [1 \text{ mark}]$$

The temperature is 20.5°C at 11 pm.

c $T = 80e^{-0.3466t} + 18$, $t \geq 0$

Horizontal asymptote at $T = 18$, contains the points $(0, 98)$, $(2, 58)$ and $(10, 20.5)$.

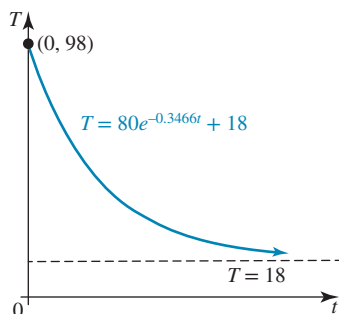

Award 1 mark for correct shape and starting point.

Award 1 mark for correct asymptote.

d $T = 22$; either use a CAS graphing screen or solve as follows.

$$22 = 80e^{-0.3466t} + 18$$

$$\therefore e^{-0.3466t} = \frac{1}{20}$$

$$t = \frac{\log_e(30)}{0.0536}$$

$$t = 63.5$$

It took 63.5 days for the number of cases to reach 6000.

[1 mark]

d When $P(t) = 38\,000$,

$$P(t) = 200e^{0.0536t}$$

$$38\,000 = 200e^{0.0536t}$$

$$190 = e^{0.0536t}$$

$$0.0536t = \log_e(190)$$

$$t = \frac{\log_e(190)}{0.0536}$$

$$t = 97.9$$

It took 97.9 days for 38 000 young people to be infected.

[1 mark]

5 Let $w = e^x$.

$$w^2 - 3w + 2 = 0$$

$$(w - 2)(w - 1) = 0 \quad [1 \text{ mark}]$$

$$w = 2 \text{ or } w = 1$$

$$e^x = 2 \text{ or } e^x = 1$$

$$x = \log_e(2) \text{ or } x = 0 \quad [1 \text{ mark}]$$

Topic 5 — Differentiation

5.2 Review of differentiation

5.2 Exercise

1 a $f(x) = (2 - x)^2 + 1$

$$\begin{aligned} f(x+h) &= (2 - (x+h))^2 + 1 \\ &= 4 - 4(x+h) + (x+h)^2 + 1 \\ &= 8 - 4x - 4h + x^2 + 2xh + h^2 + 1 \\ &= 9 - 4x - 4h + x^2 + 2xh + h^2 \end{aligned}$$

$$\begin{aligned} f(x-h) &= (2 - (x-h))^2 + 1 \\ &= 4 - 4(x-h) + (x-h)^2 + 1 \\ &= 8 - 4x + 4h + x^2 - 2xh + h^2 + 1 \\ &= 9 - 4x + 4h + x^2 - 2xh + h^2 \end{aligned}$$

$$f'(x) \approx \frac{f(x+h) - f(x-h)}{2h}$$

$$f'(x) \approx \frac{9 - 4x - 4h + x^2 + 2xh + h^2 - (9 - 4x + 4h + x^2 - 2xh + h^2)}{2h}$$

$$f'(x) \approx \frac{-8h + 4xh}{2h}$$

$$f'(x) \approx \frac{2h(-4 + 2x)}{2h}$$

$$f'(x) \approx -4 + 2x$$

b $x = 1$

$$\begin{aligned} f'(1) &= -4 + 2(1) \\ &= -2 \end{aligned}$$

2 a $f(x) = 12 - x$

$$\begin{aligned} f(x+h) &= 12 - (x+h) \\ &= 12 - x - h \end{aligned}$$

$$\begin{aligned} f(x-h) &= 12 - (x-h) \\ &= 12 - x + h \end{aligned}$$

$$f'(x) \approx \frac{f(x+h) - f(x-h)}{2h}$$

$$f'(x) \approx \frac{12 - x - h - (12 - x + h)}{2h}$$

$$f'(x) \approx \frac{-2h}{2h}$$

$$f'(x) \approx -1$$

b $f(x) = 3x^2 - 2x - 21$

$$\begin{aligned} f(x+h) &= 3(x+h)^2 - 2(x+h) - 21 \\ &= 3x^2 + 6xh + 3h^2 - 2x - 2h - 21 \end{aligned}$$

$$\begin{aligned} f(x-h) &= 3(x-h)^2 - 2(x-h) - 21 \\ &= 3x^2 - 6xh + 3h^2 - 2x + 2h - 21 \end{aligned}$$

$$f'(x) \approx \frac{f(x+h) - f(x-h)}{2h}$$

$$f'(x) \approx \frac{3x^2 + 6xh + 3h^2 - 2x - 2h - 21 - (3x^2 - 6xh + 3h^2 - 2x + 2h - 21)}{2h}$$

$$f'(x) \approx \frac{12xh - 4h}{2h}$$

$$f'(x) \approx \frac{2h(6x - 2)}{2h}$$

$$f'(x) \approx 6x - 2$$

$$3 \text{ a } f(x) = 4x^3 + \frac{1}{3x^2} + \frac{1}{2} = 4x^3 + \frac{1}{3}x^{-2} + \frac{1}{2}$$

$$f'(x) = 12x^2 - \frac{2}{3}x^{-3} = 12x^2 - \frac{2}{3x^3}$$

$$b \quad f(x) = \frac{2\sqrt{x} - x^4}{5x^3} = \frac{2}{5}x^{-\frac{5}{2}} - \frac{1}{5}x$$

$$f'(x) = -x^{-\frac{7}{2}} - \frac{1}{5} = -\frac{1}{x^{\frac{7}{2}}} - \frac{1}{5}$$

$$c \quad f(x) = (x+3)(x^2+1) = x^3 + 3x^2 + x + 3$$

$$f'(x) = 3x^2 + 6x + 1$$

$$d \quad f(x) = \frac{4 - \sqrt{x}}{\sqrt{x^3}} = 4x^{-\frac{3}{2}} - x^{-1}$$

$$f'(x) = -6x^{-\frac{5}{2}} + x^{-2} = -\frac{6}{x^{\frac{5}{2}}} + \frac{1}{x^2}$$

$$4 \text{ a } y = \frac{3}{4x^5} - \frac{1}{2x} + 4 = \frac{3}{4}x^{-5} - \frac{1}{2}x^{-1} + 4$$

$$\frac{dy}{dx} = -\frac{15}{4}x^{-6} + \frac{1}{2}x^{-2} = -\frac{15}{4x^6} + \frac{1}{2x^2}$$

$$b \quad f(x) = \frac{10x - 2x^3 + 1}{x^4} = 10x^{-3} - 2x^{-1} + x^{-4}$$

$$f'(x) = -30x^{-4} + 2x^{-2} - 4x^{-5} = -\frac{30}{x^4} + \frac{2}{x^2} - \frac{4}{x^5}$$

$$c \quad y = \sqrt{x} - \frac{1}{2\sqrt{x}} = x^{\frac{1}{2}} - \frac{1}{2}x^{-\frac{1}{2}}$$

$$\frac{dy}{dx} = \frac{1}{2}x^{-\frac{1}{2}} + \frac{1}{4}x^{-\frac{3}{2}} = \frac{1}{2\sqrt{x}} + \frac{1}{4x^{\frac{3}{2}}}$$

$$d \quad f(x) = \frac{(3-x)^3}{2x}$$

$$= \frac{27 - 27x + 9x^2 - x^3}{2x}$$

$$= \frac{27}{2}x^{-1} - \frac{27}{2} + \frac{9}{2}x - \frac{1}{2}x^2$$

$$f'(x) = -\frac{27}{2}x^{-2} + \frac{9}{2} - x$$

$$= -\frac{27}{2x^2} - x + \frac{9}{2}$$

$$5 \text{ a } f(x) = -\frac{1}{x^2} + 2x$$

$$= -x^{-2} + 2x$$

$$f'(x) = 2x^{-3} + 2$$

$$= \frac{2}{x^3} + 2$$

$$f'\left(-\frac{1}{2}\right) = \frac{2}{\left(-\frac{1}{2}\right)^3} + 2$$

$$= -16 + 2$$

$$= -14$$

$$b \quad f(x) = \frac{2x-4}{x} = 2 - 4x^{-1}$$

$$f'(x) = 4x^{-2} = \frac{4}{x^2}$$

$$\text{If } f'(x) = 1, \text{ then } \frac{4}{x^2} = 1$$

$$4 = x^2$$

$$x = \pm 2$$

$$\text{When } x = -2, f(x) = \frac{2(-2) - 4}{-2} = 4.$$

$$\text{When } x = 2, f(x) = \frac{2(2) - 4}{-2} = 0.$$

Therefore, gradient = 1 at (2, 0) and (-2, 4).

$$6 \text{ a } f(x) = x^2 - 3$$

$$f'(x) = 2x$$

$$f'(2) = 2(2) = 4$$

$$b \quad f(x) = (3-x)(x-4) = -x^2 + 7x - 12$$

$$f'(x) = -2x + 7$$

$$f'(1) = -2(1) + 7 = 5$$

$$c \quad f(x) = (x-2)^3$$

$$= x^3 - 3(x)^2(2) + 3(x)(2)^2 - (2)^3$$

$$= x^3 - 6x^2 + 12x - 8$$

$$f'(x) = 3x^2 - 12x + 12$$

$$f'(4) = 3(4)^2 - 12(4) + 12 = 12$$

$$d \quad f(x) = \sqrt{x} - \frac{3}{x} + 2x$$

$$= x^{\frac{1}{2}} - 3x^{-1} + 2x$$

$$f'(x) = \frac{1}{2}x^{-\frac{1}{2}} + 3x^{-2} + 2$$

$$= \frac{1}{2\sqrt{x}} + \frac{3}{x^2} + 2$$

$$f'(4) = \frac{1}{2\sqrt{4}} + \frac{3}{4^2} + 2 = \frac{1}{4} + \frac{3}{16} + 2$$

$$= \frac{4}{16} + \frac{3}{16} + \frac{32}{16} = \frac{39}{16}$$

$$7 \quad y = (x-a)(x^2-1) = x^3 - ax^2 - x + a$$

$$\frac{dy}{dx} = 3x^2 - 2ax - 1$$

$$x = -2, \frac{dy}{dx} = 3(-2)^2 - 2(-2)a - 1 = 12 + 4a - 1 = 11 + 4a$$

- 8 a The turning point is (-2, -9), so $f'(x)$ cuts the x -axis at $x = -2$. For $x < -2$, $f'(x)$ is negative, and for $x > -2$, $f'(x)$ is positive.

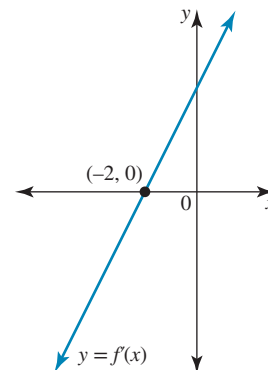

- b The domain of the gradient function shown is $x \in (-\infty, 2) \setminus \{-2\}$.

- 9 $f(x)$ has a stationary point of inflection at $x = -2$, so the turning point of $f'(x)$ is at $x = -2$. The parabola lies above the x -axis for all other values of x .

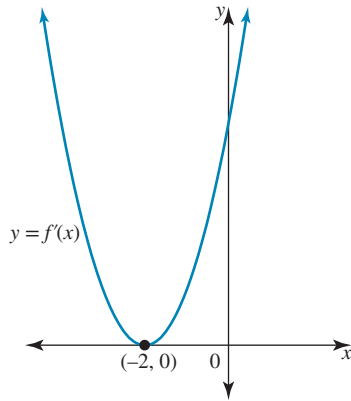

10 a i Domain = R

ii

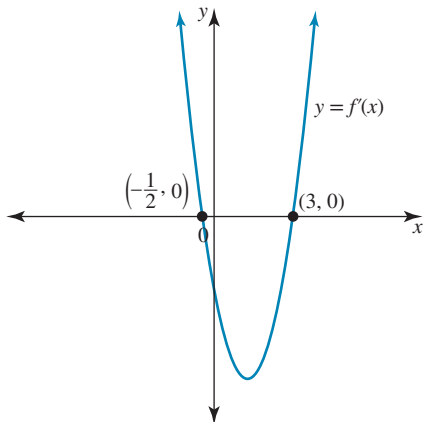

b i Domain = R

ii

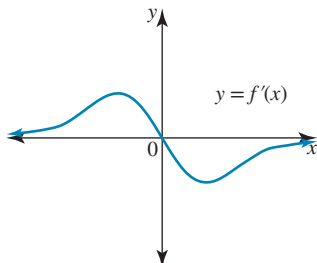

c i Domain = $(-\infty, 4) \setminus \{-2\}$

ii

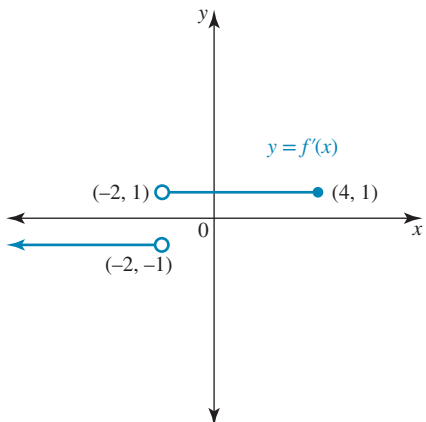

d i Domain = $R \setminus \{0\}$

ii

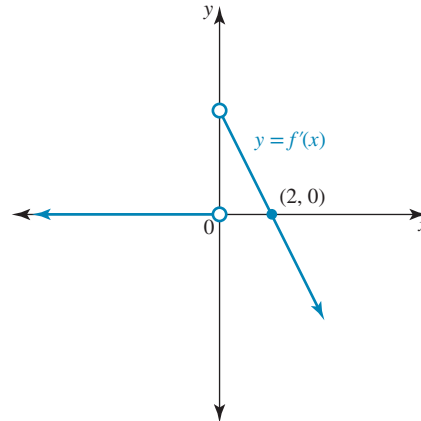

11 a $y = x(x-2)^2(x-4) = (x^2 - 4x)(x^2 - 4x + 4)$
 $= x^4 - 8x^3 + 20x^2 - 16x$

$$\frac{dy}{dx} = 4x^3 - 24x^2 + 40x - 16$$

$$x = 3, \frac{dy}{dx} = 4(3)^3 - 24(3)^2 + 40(3) - 16 = -4$$

Equation of the tangent that passes through $(x_1, y_1) \equiv (3, -3)$, where $m_T = -4$:

$$y - y_1 = m_T(x - x_1)$$

$$y + 3 = -4(x - 3)$$

$$y + 3 = -4x + 12$$

$$y = -4x + 9$$

b Equation of the line perpendicular to the tangent, where

$$m_P = \frac{1}{4}$$

$$y - y_1 = m_P(x - x_1)$$

$$y + 3 = \frac{1}{4}(x - 3)$$

$$y + 3 = \frac{1}{4}x - \frac{3}{4}$$

$$y = \frac{1}{4}x - \frac{15}{4}$$

12 a $f(x) = (x+1)(x+3) = x^2 + 4x + 3$

$$f'(x) = 2x + 4$$

$$f'(-5) = 2(-5) + 4 = -6$$

$$\text{When } x = -5, y = (-5 + 1)(-5 + 3) = 8.$$

Equation of the tangent that passes through the point $(x_1, y_1) \equiv (-5, 8)$, where $m_T = -6$:

$$y - y_1 = m_T(x - x_1)$$

$$y - 8 = -6(x + 5)$$

$$y - 8 = -6x - 30$$

$$y = -6x - 22$$

b $f(x) = 8 - x^3$

$$f'(x) = -3x^2$$

$$f'(a) = -3a^2$$

$$\text{When } x = a, y = 8 - a^3.$$

Equation of the tangent that passes through the point $(x_1, y_1) \equiv (a, 8 - a^3)$, where $m_T = -3a^2$:

$$y - y_1 = m_T(x - x_1)$$

$$y - (8 - a^3) = -3a^2(x - a)$$

$$y - 8 + a^3 = -3a^2x + 3a^3$$

$$y = -3a^2x + 2a^3 + 8$$

$$\text{c } f(x) = 2\sqrt{x} - 5 = 2x^{\frac{1}{2}} - 5$$

$$f'(x) = x^{-\frac{1}{2}} = \frac{1}{\sqrt{x}}$$

$$f'(3) = \frac{1}{\sqrt{3}}$$

$$\text{When } x = 3, y = 2\sqrt{3} - 5$$

Equation of the tangent that passes through the point

$$(x_1, y_1) \equiv (3, 2\sqrt{3} - 5), \text{ where } m_T = \frac{1}{\sqrt{3}}:$$

$$y - y_1 = m_T(x - x_1)$$

$$y - (2\sqrt{3} - 5) = \frac{1}{\sqrt{3}}(x - 3)$$

$$y - 2\sqrt{3} + 5 = \frac{1}{\sqrt{3}}x - \frac{3}{\sqrt{3}}$$

$$y = \frac{1}{\sqrt{3}}x - \frac{3}{\sqrt{3}} + 2\sqrt{3} - 5$$

$$y = \frac{\sqrt{3}}{3}x + \sqrt{3} - 5$$

$$\text{d } f(x) = -\frac{2}{x} - 4x = -2x^{-1} - 4x$$

$$f'(x) = 2x^{-2} - 4 = \frac{2}{x^2} - 4$$

$$f'(-2) = \frac{2}{(-2)^2} - 4 = -\frac{7}{2}$$

$$\text{When } x = -2, y = -\frac{2}{(-2)} - 4(-2) = 9$$

Equation of the tangent that passes through the point

$$(x_1, y_1) \equiv (-2, 9), \text{ where } m_T = -\frac{7}{2}:$$

$$y - y_1 = m_T(x - x_1)$$

$$y - 9 = -\frac{7}{2}(x + 2)$$

$$y - 9 = -\frac{7}{2}x - 7$$

$$y = -\frac{7}{2}x + 2$$

13 a Equation of the perpendicular line that passes through the

$$\text{point } (x_1, y_1) \equiv (-5, 8), \text{ where } m_P = \frac{1}{6}:$$

$$y - y_1 = m_P(x - x_1)$$

$$y - 8 = \frac{1}{6}(x + 5)$$

$$y - 8 = \frac{1}{6}x + \frac{5}{6}$$

$$y = \frac{1}{6}x + \frac{5}{6} + \frac{48}{6}$$

$$y = \frac{1}{6}x + \frac{53}{6}$$

b Equation of the perpendicular line that passes through the

$$\text{point } (x_1, y_1) \equiv (a, 8 - a^3), \text{ where } m_P = \frac{1}{3a^2}:$$

$$y - y_1 = m_P(x - x_1)$$

$$y - (8 - a^3) = \frac{1}{3a^2}(x - a)$$

$$y - 8 + a^3 = \frac{1}{3a^2}x - \frac{1}{3a^2}a$$

$$y = \frac{1}{3a^2}x - \frac{1}{3a} + 8 - a^3$$

c Equation of the perpendicular line that passes through the

$$\text{point } (x_1, y_1) \equiv (3, 2\sqrt{3} - 5), \text{ where } m_P = -\sqrt{3}:$$

$$y - y_1 = m_P(x - x_1)$$

$$y - (2\sqrt{3} - 5) = -\sqrt{3}(x - 3)$$

$$y - 2\sqrt{3} + 5 = -\sqrt{3}x + 3\sqrt{3}$$

$$y = -\sqrt{3}x + 5\sqrt{3} - 5$$

d Equation of the perpendicular line that passes through the

$$\text{point } (x_1, y_1) \equiv (-2, 9), \text{ where } m_P = \frac{2}{7}:$$

$$y - y_1 = m_P(x - x_1)$$

$$y - 9 = \frac{2}{7}(x + 2)$$

$$y - 9 = \frac{2}{7}x + \frac{4}{7}$$

$$y = \frac{2}{7}x + \frac{4}{7} + \frac{63}{7}$$

$$y = \frac{2}{7}x + \frac{67}{7}$$

14 a Any line parallel to $y = 3x + 4$ has a gradient of 3.

$$f(x) = -(x - 2)^2 + 3 = -x^2 + 4x - 4 + 3 = -x^2 + 4x - 1$$

$$f'(x) = -2x + 4$$

$$3 = -2x + 4$$

$$\frac{1}{2} = x$$

$$\text{When } x = \frac{1}{2}, y = -\left(\frac{1}{2}\right)^2 + 4\left(\frac{1}{2}\right) - 1 = -\frac{1}{4} + 1 = \frac{3}{4}$$

Equation of the tangent that passes through the point

$$(x_1, y_1) \equiv \left(\frac{1}{2}, \frac{3}{4}\right), \text{ where}$$

$$m_T = 3 \text{ is}$$

$$y - y_1 = m_T(x - x_1)$$

$$y - \frac{3}{4} = 3\left(x - \frac{1}{2}\right)$$

$$y - \frac{3}{4} = 3x - \frac{3}{2}$$

$$y = 3x - \frac{6}{4} + \frac{3}{4}$$

$$y = 3x - \frac{3}{4}$$

b A line perpendicular to $2y - 2 = -4x$ or $y = -2x + 1$ will

have a gradient of $\frac{1}{2}$.

$$f(x) = -\frac{2}{x^2} + 1 = -2x^{-2} + 1$$

$$f'(x) = 4x^{-3} = \frac{4}{x^3}$$

$$\frac{1}{2} = \frac{4}{x^3}$$

$$2 = \frac{x^3}{4}$$

$$8 = x^3$$

$$2 = x$$

$$x = 2, y = -\frac{2}{2^2} + 1 = -\frac{1}{2} + 1 = \frac{1}{2}$$

Equation of the perpendicular line that passes through the

$$\text{point } (x_1, y_1) \equiv \left(2, \frac{1}{2}\right), \text{ where } m_P = \frac{1}{2}:$$

$$y - y_1 = m_P(x - x_1)$$

$$y - \frac{1}{2} = \frac{1}{2}(x - 2)$$

$$y - \frac{1}{2} = \frac{1}{2}x - 1$$

$$y = \frac{1}{2}x - \frac{1}{2}$$

15 a, b

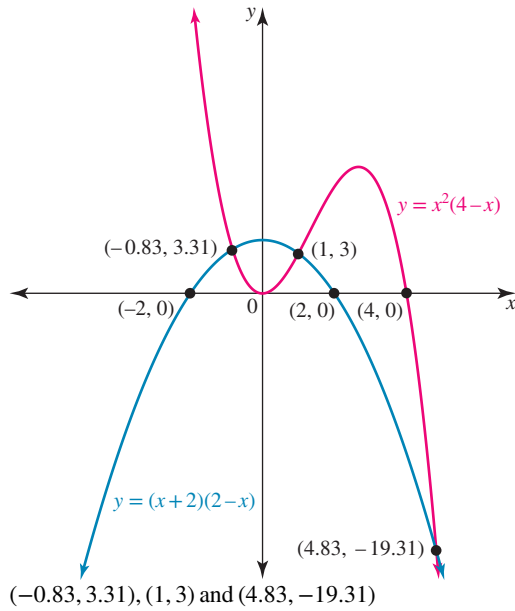
 $(-0.83, 3.31), (1, 3)$ and $(4.83, -19.31)$

c $f(x) = (x + 2)(2 - x) = 4 - x^2$

$$f(x + h) = ((x + h) + 2)(2 - (x + h))$$

$$f(x + h) = 4 - (x + h)^2 = 4 - x^2 - 2xh - h^2$$

$$f'(x) = \lim_{h \rightarrow 0} \frac{f(x + h) - f(x)}{h}$$

$$f'(x) = \lim_{h \rightarrow 0} \frac{4 - x^2 - 2xh - h^2 - 4 + x^2}{h}$$

$$f'(x) = \lim_{h \rightarrow 0} \frac{-2xh - h^2}{h}$$

$$f'(x) = \lim_{h \rightarrow 0} (-2x - h), h \neq 0$$

$$f'(x) = -2x$$

When $x = 1$, $f'(1) = -2(1) = -2$.

$$f(x) = x^2(4 - x) = 4x^2 - x^3$$

$$f(x + h) = 4(x + h)^2 - (x + h)^3$$

$$f(x + h) = 4(x^2 + 2xh + h^2) - (x^3 + 3x^2h + 3xh^2 + h^3)$$

$$f(x + h) = 4x^2 + 8xh + 4h^2 - x^3 - 3x^2h - 3xh^2 - h^3$$

$$f'(x) = \lim_{h \rightarrow 0} \frac{f(x + h) - f(x)}{h}$$

$$f'(x) = \lim_{h \rightarrow 0} \frac{4x^2 + 8xh + 4h^2 - x^3 - 3x^2h - 3xh^2 - h^3 - 4x^2 + x^3}{h}$$

$$f'(x) = \lim_{h \rightarrow 0} \frac{8xh + 4h^2 - 3x^2h - 3xh^2 - h^3}{h}$$

$$f'(x) = \lim_{h \rightarrow 0} (8x + 4h - 3x^2 - 3xh - h^2), h \neq 0$$

$$f'(x) = 8x - 3x^2$$

When $x = 1$, $f'(1) = 8(1) - 3(1)^2 = 5$.

16 a

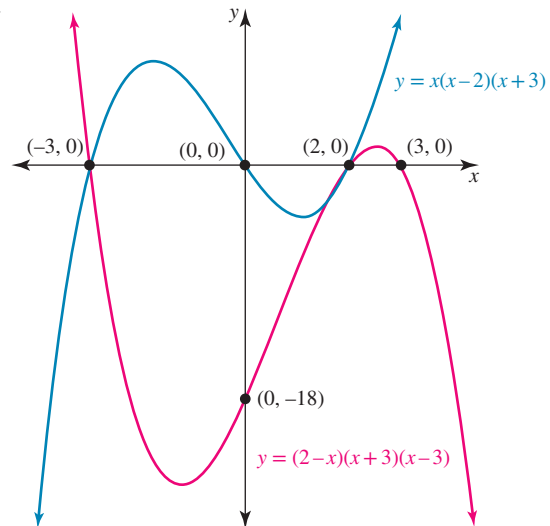

b The point of intersection is $\left(\frac{3}{2}, -\frac{27}{8}\right)$.

c $y = x(x - 2)(x + 3) = x^3 + x^2 - 6x$

$$\frac{dy}{dx} = 3x^2 + 2x - 6$$

When $x = \frac{3}{2}$,

$$\frac{dy}{dx} = 3\left(\frac{3}{2}\right)^2 + 2\left(\frac{3}{2}\right) - 6$$

$$= \frac{27}{4} - 3$$

$$= \frac{27}{4} - \frac{12}{4}$$

$$= \frac{15}{4}$$

The equation of the tangent that passes through the point $(x_1, y_1) \equiv \left(\frac{3}{2}, -\frac{27}{8}\right)$ and has a gradient of $m_T = \frac{15}{4}$ is

$$y - y_1 = m_T(x - x_1).$$

$$y + \frac{27}{8} = \frac{15}{4}\left(x - \frac{3}{2}\right)$$

$$y + \frac{27}{8} = \frac{15}{4}x - \frac{45}{8}$$

$$y = \frac{15}{4}x - \frac{45}{8} - \frac{27}{8}$$

$$y = \frac{15}{4}x - 9$$

The equation of the perpendicular line that passes through the point $(x_1, y_1) \equiv \left(\frac{3}{2}, -\frac{27}{8}\right)$ and has a gradient of

$$m_P = -\frac{4}{15} \text{ is:}$$

$$y - y_1 = m_P(x - x_1)$$

$$y + \frac{27}{8} = -\frac{4}{15}\left(x - \frac{3}{2}\right)$$

$$y + \frac{27}{8} = -\frac{4}{15}x + \frac{2}{5}$$

$$y = -\frac{4}{15}x + \frac{2}{5} - \frac{27}{8}$$

$$y = -\frac{4}{15}x - \frac{119}{40}$$

- 17 The tangent and perpendicular intersect where:

$$y = -2x + 5 \quad [1]$$

$$y = \frac{1}{2}x + \frac{5}{2} \quad [2]$$

$$[1] = [2]:$$

$$-2x + 5 = \frac{1}{2}x + \frac{5}{2}$$

$$-4x + 10 = x + 5$$

$$5 = 5x$$

$$x = 1$$

Substitute $x = 1$ into [1]:

$$y = -2(1) + 5 = 3$$

The general rule for the parabola is $y = ax^2 + bx + c$, and the

general rule for the derivative is $\frac{dy}{dx} = 2ax + b$.

When $x = 0$, $y = 4$, so $c = 4$ or $y = ax^2 + bx + 4$.

When $x = 1$, $y = 3$, so $3 = a + b + 4$ or $-1 = a + b$.

When $x = 0$, $\frac{dy}{dx} = 0$, so $0 = b$.

If $b = 0$, then for $-1 = a + b$, $a = -1$.

Hence, $y = 4 - x^2$ is the equation of the parabola.

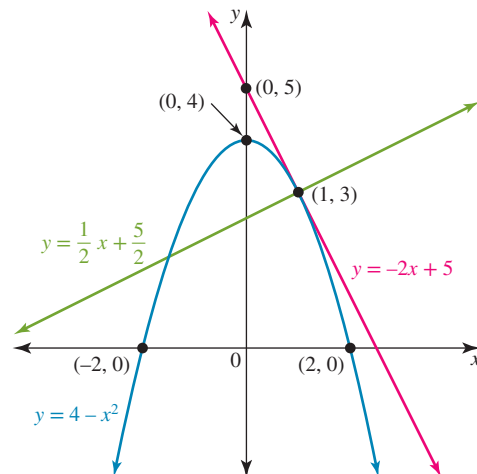

- 18 The tangent to the parabola at $x = 4$ is $y = -x + 6$. When

$x = 4$, $y = -4 + 6 = 2$. The parabola $y = ax^2 + bx + c$ passes through the points $(4, 2)$, $(0, -10)$ and $(2, 0)$.

At $(0, -10)$, $-10 = a(0)^2 + b(0) + c$, so $c = -10$.

$$0 = a(2)^2 + 2b - 10 \text{ or}$$

$$4a + 2b = 10 \Rightarrow 2a + b = 5 \quad [1]$$

At $(4, 2)$,

$$2 = a(4)^2 + 4b - 10 \text{ or}$$

$$16a + 4b = 12 \Rightarrow 4a + b = 3 \quad [2]$$

$$(2) - (1) \quad 2a = -2 \Rightarrow a = -1$$

Substitute $a = -1$ into [1]:

$$2(-1) + b = 5, \text{ so } b = 7.$$

The equation of the parabola is $y = -x^2 + 7x - 10$.

- 19 The tangent to a cubic function at $x = 2$ has the rule $y = 11x - 16$. If $x = 2$, then $y = 11(2) - 16 = 6$. The cubic passes through the points $(0, 0)$, $(-1, 0)$ and $(2, 6)$.

The general rule for the cubic is $y = ax^3 + bx^2 + cx + d$.

$$d = 0$$

$$\therefore y = ax^3 + bx^2 + cx$$

$$(-1, 0) \Rightarrow 0 = -a + b - c \quad [1]$$

$$(2, 6) \Rightarrow 6 = 8a + 4b + 2c \quad [2]$$

$$\frac{dy}{dx} = 3ax^2 + 2bx + c$$

$$m = 11, x = 2$$

$$11 = 12a + 4b + c \quad [3]$$

Using CAS to solve:

$$a = 1, b = 0, c = -1$$

$$\therefore y = x^3 - x$$

- 20 The line perpendicular to $y = 2\sqrt{x} = 2x^{\frac{1}{2}}$ has the equation

$y = -2x + m$. Thus, the gradient of the curve is $\frac{1}{2}$.

If $y = 2x^{\frac{1}{2}}$, then $\frac{dy}{dx} = x^{-\frac{1}{2}} = \frac{1}{\sqrt{x}}$.

$$\text{If } \frac{1}{\sqrt{x}} = \frac{1}{2},$$

$$\text{then } \sqrt{x} = 2 \Rightarrow x = 4.$$

When $x = 4$, $y = 2\sqrt{4} = 4$.

The perpendicular line passes through the point $(4, 4)$. Thus,

$$4 = -2(4) + m$$

$$4 = -8 + m$$

$$m = 12$$

5.2 Exam questions

1 $y = x^3 - ax^2 + 1$

$$x = 1 \quad y(1) = 1 - a + 1 = 2 - a$$

$$\frac{dy}{dx} = 3x^2 - 2ax, \quad x = 1 \quad \frac{dy}{dx} = 3 - 2a$$

$$T : y - (2 - a) = (3 - 2a)(x - 1)$$

$$\text{at } (0, 0) \quad -(2 - a) = -(3 - 2a)$$

$$a = 1$$

The correct answer is **B**.

- 2 The gradient is negative for $x < 5$, The gradient is positive for $x > 5$

The gradient is zero at $x = 0$ and $x = 5$

The correct answer is **A**.

- 3 The gradient is negative for $x \in \left(-3, \frac{5}{3}\right)$

The correct answer is **D**.

5.3 Differentiation of exponential functions

5.3 Exercise

1 a $y = e^{-\frac{1}{3}x}$

$$\frac{dy}{dx} = -\frac{1}{3}e^{-\frac{1}{3}x}$$

b $y = 3x^4 - e^{-2x^2}$

$$\frac{dy}{dx} = 12x^3 - e^{-2x^2}(-4x) = 12x^3 + 4xe^{-2x^2}$$

c $y = \frac{4e^x - e^{-x} + 2}{3e^{3x}}$

$$y = \frac{4}{3}e^{-2x} - \frac{1}{3}e^{-4x} + \frac{2}{3}e^{-3x}$$

$$\frac{dy}{dx} = -\frac{8}{3}e^{-2x} + \frac{4}{3}e^{-4x} - 2e^{-3x}$$

d $y = (e^{2x} - 3)^2$

$$y = e^{4x} - 6e^{2x} + 9$$

$$\frac{dy}{dx} = 4e^{4x} - 12e^{2x}$$

$$2 \text{ a } \frac{d}{dx} (5e^{-4x} + 2e) = -20e^{-4x}$$

$$\text{b } \frac{d}{dx} \left(e^{-\frac{1}{2}x} + \frac{1}{3}x^3 \right) = -\frac{1}{2}e^{-\frac{1}{2}x} + x^2$$

$$\text{c } \frac{d}{dx} \left(4e^{3x} - \frac{1}{2}e^{6\sqrt{x}} - 3e^{-3x+2} \right) = 12e^{3x} - \frac{3e^{6\sqrt{x}}}{2\sqrt{x}} + 9e^{-3x+2}$$

$$\text{d } \frac{d}{dx} \left(\frac{e^{5x} - e^{-x} + 2}{e^{2x}} \right) = \frac{d}{dx} (e^{3x} - e^{-3x} + 2e^{-2x}) \\ = 3e^{3x} + 3e^{-3x} - 4e^{-2x}$$

$$\text{e } \frac{d}{dx} \left(\frac{e^x(2 - e^{-3x})}{e^{-x}} \right) = \frac{d}{dx} (2e^{2x} - e^{-x}) = 4e^{2x} + e^{-x}$$

$$\text{f } \frac{d}{dx} ((e^{2x} + 3)(e^{-x} - 1)) = \frac{d}{dx} (e^x - e^{2x} + 3e^{-x} - 3) \\ = e^x - 2e^{2x} - 3e^{-x}$$

$$3 \quad f(x) = \frac{1}{2}e^{3x} + e^{-x}$$

$$f'(x) = \frac{3}{2}e^{3x} - e^{-x}$$

$$f'(0) = \frac{3}{2}e^0 - e^0 = \frac{1}{2}$$

$$4 \text{ a } \quad y = 2e^{-x}$$

$$\frac{dy}{dx} = -2e^{-x}$$

$$\frac{dy}{dx}_{x=0} = -2e^0 = -2$$

$$\text{b } \quad y = \frac{4}{e^{2x}} = 4e^{-2x}$$

$$\frac{dy}{dx} = -8e^{-2x}$$

$$\frac{dy}{dx}_{x=\frac{1}{2}} = -8e^{-2(\frac{1}{2})}$$

$$= -8e^{-1}$$

$$= -\frac{8}{e}$$

$$\text{c } \quad y = \frac{1}{2}e^{3x}$$

$$\frac{dy}{dx} = \frac{3}{2}e^{3x}$$

$$\frac{dy}{dx}_{x=\frac{1}{3}} = \frac{3}{2}e^{3(\frac{1}{3})} = \frac{3}{2}e$$

$$\text{d } \quad y = 2x - e^x$$

$$\frac{dy}{dx} = 2 - e^x$$

$$\frac{dy}{dx}_{x=0} = 2 - e^0 = 2 - 1 = 1$$

$$5 \text{ a } \quad y = e^{2x}$$

$$\frac{dy}{dx} = 2e^{2x}$$

$$\frac{dy}{dx}_{x=0} = 2e^{2(0)} = 2$$

$$\text{b i } \text{ When } x = 0, y = e^0 = 1.$$

The equation of the tangent that passes through $(x_1, y_1) \equiv (0, 1)$ with $m_T = 2$ is:

$$y - y_1 = m_T(x - x_1)$$

$$y - 1 = 2x$$

$$y = 2x + 1$$

ii Therefore, the equation of the perpendicular line is

$$y = -\frac{1}{2}x + 1.$$

$$6 \quad y = e^{-3x} + 4$$

$$\frac{dy}{dx} = -3e^{-3x}$$

$$\frac{dy}{dx}_{x=0} = -3e^{-3(0)} = -3$$

$$\text{When } x = 0, y = e^0 + 4 = 5.$$

The equation of the tangent that passes through

$$(x_1, y_1) \equiv (0, 5) \text{ with } m_T = -3 \text{ is:}$$

$$y - y_1 = m_T(x - x_1)$$

$$y - 5 = -3x$$

$$y = -3x + 5$$

The equation of the perpendicular line that passes through

$$(x_1, y_1) \equiv (0, 5) \text{ with } m_P = \frac{1}{3} \text{ is:}$$

$$y - y_1 = m_P(x - x_1)$$

$$y - 5 = \frac{1}{3}x$$

$$y = \frac{1}{3}x + 5$$

$$7 \quad y = e^{-3x} - 2$$

$$m_T = \frac{dy}{dx} = -3e^{-3x}$$

$$\text{When } x = 0, m_T = -3e^{-3(0)} = -3 \text{ and } m_P = \frac{1}{3}$$

$$\text{When } x = 0, y = e^{-3(0)} - 2 = 1 - 2 = -1$$

The equation of the tangent with $m_T = -3$ that passes through the point $(x_1, y_1) = (0, -1)$ is:

$$y - y_1 = m_T(x - x_1)$$

$$y + 1 = -3(x - 0)$$

$$y = -3x - 1$$

The equation of the perpendicular line with $m_P = \frac{1}{3}$ that passes through the point $(x_1, y_1) = (0, -1)$ is:

$$y - y_1 = m_P(x - x_1)$$

$$y + 1 = \frac{1}{3}(x - 0)$$

$$y = \frac{1}{3}x - 1$$

$$8 \quad y = e^{\sqrt{x}} + 1$$

$$\frac{dy}{dx} = \frac{e^{\sqrt{x}}}{2\sqrt{x}}$$

$$x = 3, \frac{dy}{dx} = \frac{e^{\sqrt{3}}}{2\sqrt{3}}$$

$$\text{When } x = 3, y = e^{\sqrt{3}} + 1.$$

The equation of tangent that passes through the point

$$(x_1, y_1) \equiv (3, e^{\sqrt{3}} + 1) \text{ with } m_T = \frac{e^{\sqrt{3}}}{2\sqrt{3}} \text{ is:}$$

$$y - y_1 = m_T(x - x_1)$$

$$y - e^{\sqrt{3}} - 1 = \frac{e^{\sqrt{3}}}{2\sqrt{3}}(x - 3)$$

$$y = \frac{e^{\sqrt{3}}}{2\sqrt{3}}x - \frac{3e^{\sqrt{3}}}{2\sqrt{3}} + e^{\sqrt{3}} + 1$$

The equation of perpendicular line that passes through

$(3, e^{\sqrt{3}} + 1)$ with $m_P = -\frac{2\sqrt{3}}{e^{\sqrt{3}}}$ is:

$$y - y_1 = m_P(x - x_1)$$

$$y - e^{\sqrt{3}} - 1 = -\frac{2\sqrt{3}}{e^{\sqrt{3}}}(x - 3)$$

$$y = -\frac{2\sqrt{3}}{e^{\sqrt{3}}}x + \frac{6\sqrt{3}}{e^{\sqrt{3}}} + e^{\sqrt{3}} + 1$$

9 $y = e^{x^2+3x-4}$

$$\frac{dy}{dx} = (2x + 3)e^{x^2+3x-4}$$

$$\frac{dy}{dx}_{x=1} = (2(1) + 3)e^{1^2+3(1)-4}$$

$$\frac{dy}{dx}_{x=1} = 5e^0 = 5$$

When $x = 1$, $y = e^{1^2+3(1)-4} = e^0 = 1$.

The equation of tangent that passes through $(x_1, y_1) \equiv (1, 1)$ with $m_T = 5$ is:

$$y - y_1 = m_T(x - x_1)$$

$$y - 1 = 5(x - 1)$$

$$y = 5x - 4$$

10 $y = e^{-2x}$

$$m_T = \frac{dy}{dx} = -2e^{-2x}$$

When $x = -\frac{1}{2}$, $m_T = -2e^{-2(-\frac{1}{2})} = -2e$.

When $x = -\frac{1}{2}$, $y = e^{-2(-\frac{1}{2})} = e$.

The equation of tangent with $m_T = -2e$ that passes through the point $(x_1, y_1) = (-\frac{1}{2}, e)$ is:

$$y - y_1 = m_T(x - x_1)$$

$$y - e = -2e \left(x + \frac{1}{2} \right)$$

$$y = -2ex - e + e$$

$$y = -2ex$$

The correct answer is **E**.

11 a $y = 2e^{-2x} + 1$ [1]

$$y = x^3 - 3x$$
 [2]

The point of intersection occurs where [1] = [2].

$$2e^{-2x} + 1 = x^3 - 3x$$

$$x \approx 1.89$$

$$y = (1.8854)^3 - 3(1.8854)$$

$$y \approx 1.05$$

Therefore, POI = (1.89, 1.05).

b $m_T = \frac{dy}{dx} = 3x^2 - 3$

When $x = 1.8854$, $m_T = 3(1.8854)^2 - 3 \approx 7.66$.

12 $f(x) = 3^{2x-4}$

Using CAS technology:

$$f'(x) = 2 \log_e(3) \times 3^{2x-4}$$

$$f'(2) = 2 \log_e(3) \times 3^{2(2)-4}$$

$$f'(2) = 2 \log_e(3)$$

13 a $f(x) = e^{-2x+3} - 2e$

$$f'(x) = -2e^{-2x+3}$$

$$f'(-2) = -2e^{-2(-2)+3} = -2e^7$$

b $-2e^{-2x+3} = -2$

$$e^{-2x+3} = 1$$

$$e^{-2x+3} = e^0$$

Equating indices,

$$-2x + 3 = 0$$

$$-2x = -3$$

$$x = \frac{3}{2}$$

14 a $f(x) = \frac{e^{3x} + 2}{e^x} = e^{2x} + 2e^{-x}$

$$f'(x) = 2e^{2x} - 2e^{-x}$$

$$f'(1) = 2e^2 - 2e^{-1} = 2e^2 - \frac{2}{e}$$

b $2e^{2x} - 2e^{-x} = 0$

$$e^{2x} - e^{-x} = 0$$

$$e^{-x}(e^{3x} - 1) = 0$$

$$e^{-x} = 0 \text{ or } e^{3x} - 1 = 0$$

$$\text{Not possible } e^{3x} = 1$$

$$e^{3x} = e^0$$

$$x = 0$$

15 a $A = A_0e^{-0.69t}$

When $t = 0$, $A = 2$.

$$2 = A_0e^{-0.69(0)}$$

$$2 = A_0$$

Thus, $A = 2e^{-0.69t}$.

b $\frac{dA}{dt} = -0.69 \times 2e^{-0.69t}$

$$\frac{dA}{dt} = -1.38e^{-0.69t}$$

When $t = 0$, $\frac{dA}{dt} = -1.38e^{-0.69(0)} = -1.38$.

16 $f(x) = Ae^x + Be^{-3x}$

$$f'(x) = Ae^x - 3Be^{-3x}$$

When $f'(x) = 0$,

$$Ae^x - 3Be^{-3x} = 0$$

$$e^{-3x}(Ae^{4x} - 3B) = 0$$

$e^{-3x} \neq 0$, no real solution

$$0 = Ae^{4x} - 3B$$

So,

$$3B = Ae^{4x}$$

$$e^{4x} = \frac{3B}{A}$$

5.3 Exam questions

1 $y = 2e^{-3x}$

$$\frac{dy}{dx} = -6e^{-3x} \quad [1 \text{ mark}]$$

2 $y = e^{ax}$, $a \neq 0$

At $x = c$, $y = e^{ac}$ and $P(c, e^{ac})$

$$\frac{dy}{dx} = ae^{ax} \text{ at } x = c, m_T = ae^{ac}$$

Tangent: $y - e^{ac} = ae^{ac}(x - c)$ passes through the origin (0, 0).

$$y = axe^{ac} - cae^{ac} + e^{ac}$$

$$\therefore 0 = -cae^{ac} + e^{ac}$$

$$e^{ac} = cae^{ac}$$

$$\Rightarrow ca = 1$$

$$\Rightarrow c = \frac{1}{a}$$

The correct answer is B.

3 Simplify:

$$y = \frac{e^{2x}}{e^x} + \frac{e^{-2x}}{e^x}$$

$$= e^x + e^{-3x} \quad [1 \text{ mark}]$$

$$\frac{dy}{dx} = e^x - 3e^{-3x} \quad [1 \text{ mark}]$$

5.4 Applications of exponential functions

5.4 Exercise

1 a $f(x) = e^{2x} + qe^x + 3$

When $x = 0$, $f(0) = 0$, so

$$e^{2(0)} + qe^0 + 3 = 0$$

$$1 + q + 3 = 0$$

$$q + 4 = 0$$

$$q = -4$$

b $f(x) = e^{2x} - 4e^x + 3$

The graph cuts the x -axis where $y = 0$.

$$e^{2x} - 4e^x + 3 = 0$$

$$(e^x)^2 - 4(e^x) + 3 = 0$$

$$(e^x - 3)(e^x - 1) = 0$$

$$e^x - 3 = 0 \quad \text{or} \quad e^x - 1 = 0$$

$$e^x = 3 \quad e^x = 1$$

$$x = \log_e 3 \quad e^x = e^0$$

$$x = 0$$

Thus, $(m, 0) = (\log_e 3, 0)$.

c $f'(x) = 2e^{2x} - 4e^x$

d $f'(0) = 2e^{2(0)} - 4e^0 = 2 - 4 = -2$

2 a $f(x) = e^{-2x} + ze^{-x} + 2$

$$f(0) = 0$$

$$e^{-2(0)} + ze^0 + 2 = 0$$

$$1 + z + 2 = 0$$

$$z + 3 = 0$$

$$z = -3$$

b $y = f(x) = e^{-2x} - 3e^{-x} + 2$

The graph cuts the x -axis where $y = 0$.

$$e^{-2x} - 3e^{-x} + 2 = 0$$

$$(e^{-x})^2 - 3(e^{-x}) + 2 = 0$$

$$(e^{-x} - 1)(e^{-x} - 2) = 0$$

$$e^{-x} - 1 = 0 \quad \text{or} \quad e^{-x} - 2 = 0$$

$$e^{-x} = 1 \quad e^{-x} = 2$$

$$e^{-x} = e^0 \quad -x = \log_e 2$$

$$x = 0 \quad x = -\log_e 2$$

Thus, $(n, 0) = (-\log_e 2, 0)$.

c $f(x) = e^{-2x} - 3e^{-x} + 2$

$$f'(x) = -2e^{-2x} + 3e^{-x}$$

d $f'(0) = -2e^{-2(0)} + 3e^0 = -2 + 3 = 1$

3 a $M = Ae^{-0.00152t}$

When $t = 0$, $M = 20$.

$$20 = Ae^{-0.00152(0)}$$

$$20 = A$$

Thus, $M = 20e^{-0.00152t}$.

b $\frac{dM}{dt} = -0.00152(20)e^{-0.00152t}$

$$\frac{dM}{dt} = -0.0304e^{-0.00152t}$$

c When $t = 30$,

$$\frac{dM}{dt} = -0.0304e^{-0.00152(30)}$$

$$\frac{dM}{dt} = -0.0291$$

The rate of decay is 0.0291 g/year.

4 a $I = I_0e^{-0.0022d}$

When $d = 315$,

$$I = I_0e^{-0.0022(315)}$$

$$I = 0.5I_0$$

b $\frac{dI}{dd} = -0.0022I_0e^{-0.0022d}$

When $d = 315$,

$$\frac{dI}{dd} = -0.0022I_0e^{-0.0022(315)}$$

$$\frac{dI}{dd} = -0.0022I_0 \times 0.05$$

$$\frac{dI}{dd} = -0.0011I_0$$

Intensity is decreasing at a rate of $0.0011I_0$.

5 a $A = A_0e^{-kt}$

When $t = 0$, $A = 120$.

$$120 = A_0e^{-k(0)}$$

$$120 = A_0$$

Thus, $A = 120e^{-kt}$.

b $\frac{dA}{dt} = -120ke^{-kt}$

$$\frac{dA}{dt} = -k \times 120e^{-kt}$$

$$\frac{dA}{dt} = -k \times A$$

$$\frac{dA}{dt} \alpha A$$

c $A = 120e^{-kt}$

$$90 = 120e^{-2k}$$

$$\frac{3}{4} = e^{-2k}$$

$$-2k = \log_e \left(\frac{3}{4} \right)$$

$$k = -\frac{1}{2} \log_e \left(\frac{3}{4} \right)$$

$$k = \frac{1}{2} \log_e \left(\frac{4}{3} \right)$$

d $A = 120e^{kt}$, $k = \frac{1}{2} \log_e \left(\frac{4}{3} \right)$

$$\frac{dA}{dt} = -120(0.1438)e^{-kt}, \text{ where } k = 0.1438$$

$$\frac{dA}{dt} = -17.38e^{-kt}$$

When $t = 5$,

$$\frac{dA}{dt} = -17.38e^{5 \times 0.1438} = -8.408 \text{ units/min}$$

Therefore, the gas is decomposing at a rate of 8.408 units/min.

- e As $t \rightarrow \infty$, $A \rightarrow 0$. Technically the graph approaches the line $A = 0$ (with asymptotic behaviour, so it never reaches $A = 0$ exactly). However, the value of A would be so small that in effect, after a long period of time, there will be no gas left.
- 6 a** $L = L_0 e^{0.599t}$
 When $t = 0$, $L = 11$.
 $11 = L_0 e^{0.599(0)}$
 $11 = L_0$
 So $L = 11e^{0.599t}$.
- b** $\frac{dL}{dt} = 0.599 \times 11e^{0.599t}$
 $\frac{dL}{dt} = 6.589e^{0.599t}$
- c** When $t = 3$,
 $\frac{dL}{dt} = 6.589e^{0.599(3)} = 39.742$ mm/month
 When the bilby is 3 months old, it is growing at a rate of 39.742 mm/month.
- 7 a** $P = P_0 e^{0.016t}$
 When $t = 0$, $P = 8.2$ million.
 $8.2 = P_0 e^{0.016(0)}$
 $8.2 = P_0$
 Thus, $P = 8.2e^{0.016t}$.
 In 2015, $t = 2015 - 1950 = 65$.
 $P = 8.2e^{0.016(65)} = 23.2$ million
- b** $20 = 8.2e^{0.016t}$
 Solve for t using CAS:
 $t = 55.72$
 Therefore, the population reaches 20 million in September 2005.
- c** $\frac{dP}{dt} = 0.016 \times 8.2e^{0.016t}$
 $\frac{dP}{dt} = 0.1312e^{0.016t}$
 When 2000, $t = 2000 - 1950 = 50$.
 $\frac{dP}{dt} = 0.1312e^{0.016(50)} = 0.29199$
 The change in population is 0.29 million/year.
- d** $\frac{dP}{dt} = 0.016 \times 8.2e^{0.016t}$
 $\frac{dP}{dt} = 0.1312e^{0.016t}$
 $0.1312e^{0.016t} > 0.4$
 Solve using CAS:
 $0.1312e^{0.016t} > 0.4$
 $t > 69.67$
 Therefore, the rate of increase exceeds 400 000 people per year in 2019.
- 8 a** $h = 0.295(e^x + e^{-x})$
 Height of post at $x = 0.6$, so
 $h = 0.295(e^{0.6} + e^{-0.6})$
 $h = 0.6994$ m
 Height of chain at lowest point, $x = 0$:
 $h = 0.295(e^0 + e^0) = 0.295(2) = 0.59$ m
 The amount of sag is $0.6994 - 0.59 = 0.1094$ metres or 10.94 centimetres.
- b** $h = 0.295(e^x + e^{-x})$
 $\frac{dh}{dx} = 0.295(e^x - e^{-x})$
 When $x = 0.6$
 $\frac{dh}{dx} = 0.295(e^{0.6} - e^{-0.6})$
 $\frac{dh}{dx} = 0.3756 \approx 0.4$ metres
 If θ is the angle the chain makes with the post,
 $\tan(\theta) = 0.3756$
 $\theta = \tan^{-1}(0.3756)$
 $\theta = 20.6^\circ$
- 9 a** The graph cuts the y -axis where $x = 0$.
 $f(0) = e^0 - 0.5e^{2(0)} = 1 - 0.5 = 0.5$
 Therefore, $(0, 0.5)$
- b** $f'(x) = -e^{-x} + e^{-2x}$
- c** $f'(x) = 0$
 $-e^{-x} + e^{-2x} = 0$
 $e^{-x}(e^{-x} - 1) = 0$
 $e^{-x} - 1 = 0$ as $e^{-x} > 0$ for all x
 $e^{-x} = 1$
 $e^{-x} = e^0$
 $x = 0$
 Maximum TP at $(0, 0.5)$
- d** $f'(x) = -e^{-x} + e^{-2x}$
 When $x = -\log_e(2)$,
 $f'(-\log_e(2)) = -e^{\log_e(2)} + e^{-2(-\log_e(2))}$
 $= -2 + e^{\log_e(2^2)}$
 $= -2 + 4$
 $= 2$
 Let θ be the angle that the graph makes with the positive direction of the x -axis.
 $\tan(\theta) = 2$
 $\theta = \tan^{-1}(2)$
 $\theta = 63.4^\circ$
- e** $m_T = f'(x) = -e^{-x} + e^{-2x}$
 $m_T = f'(1) = -e^{-1} + e^{-2(1)} = -0.2325$
 $f(1) = e^{-1} - 0.5e^{-2(1)} = 0.3002$
 The equation of the tangent with $m_T = -0.2325$ that passes through the point
 $(x_1, y_1) = (1, 0.3002)$ is given by:
 $y - y_1 = m_T(x - x_1)$
 $y - 0.3002 = -0.2325(x - 1)$
 $y - 0.3002 = -0.2325x + 0.2325$
 $y = -0.2325x + 0.5327$
- f** $m_N = \frac{1}{0.2325} = 4.3011$
 Equation of the perpendicular line with $m_P = 4.3011$ that passes through the point
 $(x_1, y_1) = (1, 0.3002)$ is given by:
 $y - y_1 = m_P(x - x_1)$
 $y - 0.3002 = 4.3011(x - 1)$
 $y - 0.3002 = 4.3011x - 4.3011$
 $y = 4.3011x - 4.0009$

$$10 \text{ a } y = \frac{x^2 - 5}{2e^{x^2}}$$

$$\frac{dy}{dx} = -\frac{x^3 - 6x}{e^{x^2}}$$

$$\text{b When } \frac{dy}{dx} = 0,$$

$$-\frac{x^3 - 6x}{e^{x^2}} = 0$$

$$x^3 - 6x = 0$$

$$x(x^2 - 6) = 0$$

$$x = 0 \text{ or } x^2 - 6 = 0$$

$$x^2 - (\sqrt{6})^2 = 0$$

$$(x - \sqrt{6})(x + \sqrt{6}) = 0$$

$$x - \sqrt{6} = 0 \text{ or } x + \sqrt{6} = 0$$

$$x = \sqrt{6} \quad x = -\sqrt{6}$$

$$\text{When } x = \pm\sqrt{6}; y = \frac{(\pm\sqrt{6})^2 - 5}{2e^{(\pm\sqrt{6})^2}} = \frac{6 - 5}{2e^6} = \frac{1}{2e^6}$$

$$\text{The coordinates are } \left(\pm\sqrt{6}, \frac{1}{2e^6}\right)$$

$$\text{c When } x = 1.5, \frac{dy}{dx} = -\frac{(1.5)^3 - 6(1.5)}{e^{(1.5)^2}} = 0.593$$

$$11 \text{ a } T = T_0 e^{kt}$$

$$\text{When } t = 0, T = 30$$

$$30 = T_0 e^{k(0)}$$

$$30 = T_0$$

$$\text{Thus, } T = 30e^{kt}$$

$$\text{b When } t = 7 \text{ days and } k = 0.388,$$

$$T = 30e^{0.387(7)}$$

$$T = 30e^{2.709}$$

$$T = 450\,000$$

$$\text{c } \frac{dT}{dt} = 0.387 \times 30e^{0.387t}$$

$$\frac{dT}{dt} = 11.61e^{0.387t}$$

$$\text{When } t = 3,$$

$$\frac{dT}{dt} = 11.61e^{0.387(3)} = 37072.2/\text{day}$$

$$\text{d } C = C_0 e^{mt}$$

$$\text{When } t = 0, C = 450$$

$$450 = C_0 e^{m(0)}$$

$$450 = C_0$$

$$\text{So } C = 450e^{mt}$$

$$\text{e When } t = 7,$$

$$C = 450 - \frac{90}{100} \times 450$$

$$C = 450 - 405$$

$$C = 45$$

$$45\,000 \text{ cane toads remain after 7 days.}$$

$$\text{f } 45 = 450e^{7m}$$

$$0.1 = e^{7m}$$

$$\log_e(0.1) = 7m$$

$$\frac{1}{7} \log_e(0.1) = m$$

$$m = -\frac{1}{7} \log_e(10)$$

$$(m = -0.3289)$$

$$C = 450e^{-0.3289t}$$

$$\frac{dC}{dt} = -0.3289 \times 450e^{-0.3289t}$$

$$\frac{dC}{dt} = -148.0233e^{-0.3289t}$$

$$\text{When } t = 4,$$

$$\frac{dC}{dt} = -148.0233e^{-0.3289(4)} = -39.710\,156 \text{ thousand/day}$$

After 4 days, the rate of decline is 39 711 cane toads per day.

5.4 Exam questions

$$1 \text{ a When } t = 0, T = 95 - 20 = 75.$$

$$75 = T_0 e^{-2(0)}$$

$$75 = T_0$$

$$\text{So } T = 75e^{-2t}.$$

[1 mark]

$$\text{b } T = 75e^{-0.034t}$$

$$\frac{dT}{dt} = -0.034 \times 75e^{-0.034t}$$

$$\frac{dT}{dt} = -2.55e^{-0.034t}$$

$$\text{When } t = 15,$$

$$\frac{dT}{dt} = -2.55e^{-0.034(15)} = -1.531 \text{ }^\circ\text{C/min} \quad [1 \text{ mark}]$$

Therefore, the temperature is decreasing at a rate of 1.531 $^\circ\text{C/min}$.

$$2 \text{ a } y = Ae^{-x^2}$$

$$\text{When } x = 0, y = 5$$

$$5 = Ae^0$$

$$A = 5$$

$$\text{Thus, } y = 5e^{-x^2}.$$

[1 mark]

$$\text{b } \frac{dy}{dx} = -2x \times 5e^{-x^2}$$

$$\frac{dy}{dx} = -10xe^{-x^2}$$

[1 mark]

$$\text{c i When}$$

$$x = -0.5, \frac{dy}{dx} = -10(-0.5)e^{-(-0.5)^2} = 3.89 \quad [1 \text{ mark}]$$

$$\text{ii When } x = 1, \frac{dy}{dx} = -10(1)e^{-(1)^2} = -3.68 \quad [1 \text{ mark}]$$

$$3 \text{ a}$$

$$P = P_0 e^{-kh}$$

$$\text{When } h = 0.5, P = 66.7 \rightarrow 66.7 = P_0 e^{-0.5k}.$$

$$\text{When } h = 1.5, P = 52.3 \rightarrow 52.3 = P_0 e^{-1.5k}.$$

[1 mark]

$$\text{Solve using CAS: } P_0 = 75.32 \text{ cm of mercury, } k = 0.24 \quad [1 \text{ mark}]$$

$$\text{So } P = 75.32e^{-0.24h}.$$

$$\text{b } P = 75.32e^{-0.24h}$$

$$\frac{dP}{dh} = -0.24 \times 75.32e^{-0.24h}$$

$$\frac{dP}{dh} = -18.0768e^{-0.24h}$$

$$\text{When } h = 5,$$

$$dPdh = -18.0768e^{-0.24(5)} = -5.44 \text{ cm of mercury/km} \quad [1 \text{ mark}]$$

The rate is falling at 5.44 cm of mercury/km.

5.5 Differentiation of trigonometric functions

5.5 Exercise

- 1 a $\frac{d}{dx}(5x + 3 \cos(x) + 5 \sin(x)) = 5 - 3 \sin(x) + 5 \cos(x)$
 b $\frac{d}{dx}(\sin(3x + 2) - \cos(3x^2)) = 3 \cos(3x + 2) + 6x \sin(3x^2)$
 c $\frac{d}{dx}\left(\frac{1}{3} \sin(9x)\right) = \cos(9x)$
 d $\frac{d}{dx}(5 \tan(2x) - 2x^5) = 10 \sec^2(2x) - 10x^4$
 e $\frac{d}{dx}\left(8 \tan\left(\frac{x}{4}\right)\right) = 2 \sec^2\left(\frac{x}{4}\right)$
 f $\frac{d}{dx}(\tan(9x^\circ)) = \frac{d}{dx}\left(\tan\left(\frac{\pi x}{20}\right)\right) = \frac{\pi}{20} \sec^2\left(\frac{\pi x}{20}\right)$
- 2 a $y = 2 \cos(3x)$
 $\frac{dy}{dx} = -6 \sin(3x)$
 b $y = \cos(x^\circ)$
 $y = \cos\left(\frac{\pi x}{180}\right)$
 $\frac{dy}{dx} = -\frac{\pi}{180} \sin\left(\frac{\pi x}{180}\right)$
 c $y = 3 \cos\left(\frac{\pi}{2} - x\right)$
 $\frac{dy}{dx} = 3 \sin\left(\frac{\pi}{2} - x\right)$
 d $y = -4 \sin\left(\frac{x}{3}\right)$
 $\frac{dy}{dx} = -\frac{4}{3} \cos\left(\frac{x}{3}\right)$
 e $y = \sin(12x^\circ)$
 $y = \sin\left(\frac{\pi x}{15}\right)$
 $\frac{dy}{dx} = \frac{\pi}{15} \cos\left(\frac{\pi x}{15}\right)$
 f $y = 2 \sin\left(\frac{\pi}{2} + 3x\right)$
 $\frac{dy}{dx} = 6 \cos\left(\frac{\pi}{2} + 3x\right)$
 g $y = -\frac{1}{2} \tan(5x^2)$
 $\frac{dy}{dx} = -\frac{1}{2} \times 10x \times \sec^2(5x^2)$
 $= -5x \sec^2(5x^2)$
 h $y = \tan(20x)$
 $\frac{dy}{dx} = 20 \sec^2(20x)$
- 3 $\frac{\sin(x)\cos^2(2x) - \sin(x)}{\sin(x)\sin(2x)}$
 $= \frac{\cos^2(2x) - 1}{\sin(2x)}, \sin(x) \neq 0$
 $= \frac{-\sin^2(2x)}{\sin(2x)}$
 $= -\sin(2x), \sin(2x) \neq 0$
 Thus,
 $\frac{d}{dx}\left(\frac{\sin(x)\cos^2(2x) - \sin(x)}{\sin(x)\sin(2x)}\right) = \frac{d}{dx}(-\sin(2x)) = -2 \cos(2x)$

- 4 $y = -\cos(x)$
 $m_T = \frac{dy}{dx} = \sin(x)$
 When $x = \frac{\pi}{2}$, $m_T = \sin\left(\frac{\pi}{2}\right) = 1$
 When $x = \frac{\pi}{2}$, $y = -\cos\left(\frac{\pi}{2}\right) = 0$
 The equation of the tangent with $m_T = 1$ that passes through the point $(x_1, y_1) = \left(\frac{\pi}{2}, 0\right)$ is given by:
 $y - y_1 = m_T(x - x_1)$
 $y - 0 = 1\left(x - \frac{\pi}{2}\right)$
 $y = x - \frac{\pi}{2}$
- 5 $y = \tan(2x)$
 $m_T = \frac{dy}{dx} = 2 \sec^2(2x)$
 When $x = -\frac{\pi}{8}$, $m_T = \frac{2}{\cos^2\left(-\frac{\pi}{4}\right)} = \frac{2}{\left(\frac{1}{\sqrt{2}}\right)^2} = 2 \div \frac{1}{2} = 4$
 When $x = -\frac{\pi}{8}$, $y = \tan\left(-\frac{\pi}{4}\right) = -1$
 The equation of the tangent with $m_T = 4$ that passes through the point $(x_1, y_1) = \left(-\frac{\pi}{8}, -1\right)$ is given by:
 $y - y_1 = m_T(x - x_1)$
 $y + 1 = 4\left(x + \frac{\pi}{8}\right)$
 $y = 4x + \frac{\pi}{2} - 1$
- 6 When $x = \frac{\pi}{6}$, $y = 3 \cos\left(\frac{\pi}{6}\right) = 3 \times \frac{\sqrt{3}}{2} = \frac{3\sqrt{3}}{2}$
 $m_T = \frac{dy}{dx} = -3 \sin(x)$
 When $x = \frac{\pi}{6}$, $m_T = -3 \sin\left(\frac{\pi}{6}\right) = -3 \times \frac{1}{2} = -\frac{3}{2}$
 The equation of the tangent with $m_T = -\frac{3}{2}$ that passes through the point $(x_1, y_1) = \left(\frac{\pi}{6}, \frac{3\sqrt{3}}{2}\right)$ is given by:
 $y - y_1 = m_T(x - x_1)$
 $y - \frac{3\sqrt{3}}{2} = -\frac{3}{2}\left(x - \frac{\pi}{6}\right)$
 $y - \frac{3\sqrt{3}}{2} = -\frac{3}{2}x + \frac{\pi}{4}$
 $y = -\frac{3}{2}x + \frac{\pi}{4} + \frac{3\sqrt{3}}{2}$
- 7 When $x = \frac{\pi}{4}$, $y = 2 \tan\left(\frac{\pi}{4}\right) = 2$
 $m_T = \frac{dy}{dx} = 2 \sec^2(x)$
 When $x = \frac{\pi}{4}$, $m_T = 2 \sec^2\left(\frac{\pi}{4}\right) = \frac{2}{\cos^2\left(\frac{\pi}{4}\right)} = 2 \div \frac{1}{2} = 4$
 The equation of the tangent with $m_T = 4$ that passes through the point $(x_1, y_1) = \left(\frac{\pi}{4}, 2\right)$ is given by:
 $y - y_1 = m_T(x - x_1)$
 $y - 2 = 4\left(x - \frac{\pi}{4}\right)$

$$y - 2 = 4x - \pi$$

$$y = 4x + 2 - \pi$$

8 a $y = \sin(3x)$

When $x = \frac{2\pi}{3}$, $y = \sin\left(3 \times \frac{2\pi}{3}\right) = \sin(2\pi) = 0$.

$$m_T = \frac{dy}{dx} = 3 \cos(3x)$$

When

$$x = \frac{2\pi}{3}, m_T = 3 \cos\left(3 \times \frac{2\pi}{3}\right) = 3 \cos(2\pi)$$

$$= 3 \text{ and } m_P = -\frac{1}{3}.$$

The equation of the tangent with $m_T = 3$ that passes through the point

$$(x_1, y_1) = \left(\frac{2\pi}{3}, 0\right) \text{ is given by:}$$

$$y - y_1 = m_T(x - x_1)$$

$$y - 0 = 3\left(x - \frac{2\pi}{3}\right)$$

$$y = 3x - 2\pi$$

The equation of the perpendicular line with $m_P = -\frac{1}{3}$ that passes through the point

$$(x_1, y_1) = \left(\frac{2\pi}{3}, 0\right) \text{ is given by:}$$

$$y - y_1 = m_P(x - x_1)$$

$$y - 0 = -\frac{1}{3}\left(x - \frac{2\pi}{3}\right)$$

$$y = -\frac{1}{3}x + \frac{2\pi}{9}$$

b $y = \cos\left(\frac{x}{2}\right)$

When $x = \pi$, $y = \cos\left(\frac{\pi}{2}\right) = 0$.

$$m_T = \frac{dy}{dx} = -\frac{1}{2} \sin\left(\frac{x}{2}\right)$$

When $x = \pi$, $m_T = -\frac{1}{2} \sin\left(\frac{\pi}{2}\right) = -\frac{1}{2}$ and $m_N = 2$.

The equation of the tangent with $m_T = -\frac{1}{2}$ that passes through the point $(x_1, y_1) = (\pi, 0)$ is given by:

$$y - y_1 = m_T(x - x_1)$$

$$y - 0 = -\frac{1}{2}(x - \pi)$$

$$y = -\frac{1}{2}x + \frac{\pi}{2}$$

The equation of the perpendicular line with $m_P = 2$ that passes through the point $(x_1, y_1) = (\pi, 0)$ is given by:

$$y - y_1 = m_P(x - x_1)$$

$$y - 0 = 2(x - \pi)$$

$$y = 2x - 2\pi$$

9 a $\frac{\sin(x) \cos(x) + \sin^2(x)}{\sin(x) \cos(x) + \cos^2(x)} = \frac{\sin(x)(\cos(x) + \sin(x))}{\cos(x)(\sin(x) + \cos(x))}$

$$= \frac{\sin(x)}{\cos(x)} \text{ prov } \sin(x) \neq -\cos(x)$$

$$= \tan(x)$$

b $\frac{d}{dx} \left(\frac{\sin(x) \cos(x) + \sin^2(x)}{\sin(x) \cos(x) + \cos^2(x)} \right) = \frac{d}{dx} (\tan(x)) = \sec^2(x)$

10 $y = -2 \sin\left(\frac{x}{2}\right)$ for $x \in [0, 2\pi]$

$$\frac{dy}{dx} = -\cos\left(\frac{x}{2}\right)$$

$$\frac{1}{2} = -\cos\left(\frac{x}{2}\right)$$

$$-\frac{1}{2} = \cos\left(\frac{x}{2}\right) \text{ for } \frac{x}{2} \in [0, \pi]$$

$\frac{1}{2}$ suggests $\frac{\pi}{3}$. Since \cos is negative, the second quadrant.

$$\frac{x}{2} = \pi - \frac{\pi}{3}$$

$$\frac{x}{2} = \frac{2\pi}{3}$$

$$x = \frac{4\pi}{3}$$

When $x = \frac{4\pi}{3}$, $y = -2 \sin\left(\frac{4\pi}{3} \times \frac{1}{2}\right)$

$$= -2 \sin\left(\frac{2\pi}{3}\right)$$

$$= -2 \sin\left(\pi - \frac{\pi}{3}\right)$$

$$= -2 \sin\left(\frac{\pi}{3}\right) = -\sqrt{3}$$

The point is $\left(\frac{4\pi}{3}, -\sqrt{3}\right)$.

The correct answer is **A**.

11 a $f(x) = \sin(x) - \cos(x)$

$$f(0) = \sin(0) - \cos(0) = -1$$

b $f(x) = 0$

$$\sin(x) - \cos(x) = 0$$

$$\sin(x) = \cos(x)$$

$$\tan(x) = 1$$

1 suggests $\frac{\pi}{4}$. Since \tan is positive, 1st and 3rd quadrants.

$$x = \frac{\pi}{4}, \pi + \frac{\pi}{4}$$

$$x = \frac{\pi}{4}, \frac{5\pi}{4}$$

c $f'(x) = \cos(x) + \sin(x)$

d $f'(x) = 0$

$$\cos(x) + \sin(x) = 0$$

$$\sin(x) = -\cos(x)$$

$$\tan(x) = -1$$

1 suggests $\frac{\pi}{4}$. Since \tan is negative, 2nd and 4th quadrants.

$$x = \pi - \frac{\pi}{4}, 2\pi - \frac{\pi}{4}$$

$$x = \frac{3\pi}{4}, \frac{7\pi}{4}$$

12 a $f(x) = \sqrt{3} \cos(x) + \sin(x)$

$$f(0) = \sqrt{3} \cos(0) + \sin(0) = \sqrt{3}$$

b $f(x) = 0$

$$\sqrt{3} \cos(x) + \sin(x) = 0$$

$$\sin(x) = -\sqrt{3} \cos(x)$$

$$\tan(x) = -\sqrt{3}$$

$\sqrt{3}$ suggests $\frac{\pi}{3}$. Since tan is negative 2nd and 4th quadrants.

$$x = -\frac{\pi}{3}, \pi - \frac{\pi}{3}$$

$$x = -\frac{\pi}{3}, \frac{2\pi}{3}$$

c $f'(x) = -\sqrt{3} \sin(x) + \cos(x)$

d $f'(x) = 0$

$$-\sqrt{3} \sin(x) + \cos(x) = 0$$

$$\cos(x) = \sqrt{3} \sin(x)$$

$$1 = \sqrt{3} \tan(x)$$

$$\frac{1}{\sqrt{3}} = \tan(x)$$

$\frac{1}{\sqrt{3}}$ suggests $\frac{\pi}{6}$. Since tan is positive, 1st and 3rd quadrants.

$$x = -\pi + \frac{\pi}{6}, \frac{\pi}{6}$$

$$x = -\frac{5\pi}{6}, \frac{\pi}{6}$$

- 13 On CAS, solve $f'(x) = 0$, $-\frac{\pi}{2} \leq x \leq \frac{\pi}{2}$.
 $x = 0.243, 0.804$.

The points where the gradient is zero are (0.243, 1.232) and (0.804, 0.863).

- 14 On CAS, solve $f'(x) = 0$, $0 \leq x \leq \frac{\pi}{2}$.

$$x = -0.524, 0.524$$

The points where the gradient is zero are (-0.524, 0.342) and (0.524, -0.342).

- 15 $y = \sin(2x)$

$$\frac{dy}{dx} = 2 \cos(2x)$$

Let θ be the angle that the curve makes with the positive direction of the x -axis.

$$\tan \theta = 2 \cos\left(2 \times \frac{\pi}{2}\right)$$

$$\tan \theta = 2 \cos(\pi)$$

$$\tan \theta = -2$$

$$\theta = \tan^{-1}(-2)$$

$$\theta = 116.6^\circ$$

- 16 $f(x) = \sin(2x)$ so $f'(x) = 2 \cos(2x)$

$$f(x) = \cos(2x)$$
 so $f'(x) = -2 \sin(2x)$

When the gradients are equal,

$$2 \cos(2x) = -2 \sin(2x) \text{ where } x \in [-\pi, \pi]$$

$$\cos(2x) = -\sin(2x) \text{ where } 2x \in [-2\pi, 2\pi]$$

$$\frac{\cos(2x)}{\cos(2x)} = \frac{-\sin(2x)}{\cos(2x)}$$

$$1 = -\tan(2x)$$

$$-1 = \tan(2x)$$

1 suggests $\frac{\pi}{4}$. Since tan is negative, 2nd and 4th quadrants.

$$2x = -\pi - \frac{\pi}{4}, -\frac{\pi}{4}, \pi - \frac{\pi}{4} \text{ and } 2\pi - \frac{\pi}{4}$$

$$2x = -\frac{5\pi}{4}, -\frac{\pi}{4}, \frac{3\pi}{4} \text{ and } \frac{7\pi}{4}$$

$$x = -\frac{5\pi}{8}, -\frac{\pi}{8}, \frac{3\pi}{8} \text{ and } \frac{7\pi}{8}$$

5.5 Exam questions

- 1 Although the function is continuous at $x = 0$, so that $\sin(0) = 0$, it is not differentiable at $x = 0$. [1 mark]

This is because there is a sharp point at $x = 0$.

The correct answer is **B**.

- 2 Let $u = \cos(2x)$.

$$\therefore y = h(u)$$

$$\frac{du}{dx} = -2 \sin(2x)$$

$$\frac{dy}{du} = h'(u)$$

$$\frac{dy}{dx} = \frac{dy}{du} \times \frac{du}{dx}$$

$$= h'(u) \times -2 \sin(2x)$$

$$= -2h'(\cos(2x))(\sin(2x))$$

The correct answer is **D**.

- 3 $f(x) = e^{\sin(2x)}$

$$f'(x) = 2 \cos(2x) e^{\sin(2x)}$$

$$f'\left(\frac{\pi}{2}\right) = 2 \cos(\pi) e^{\sin(\pi)} = -2$$

The correct answer is **D**.

5.6 Applications of trigonometric functions

5.6 Exercise

- 1 a $A = \frac{1}{2} ab \sin(c)$

$$A = \frac{1}{2}(6)(7) \sin(\theta)$$

$$A = 21 \sin(\theta) \text{ as required}$$

b $\frac{dA}{d\theta} = 21 \cos(\theta)$

c When $\theta = \frac{\pi}{3}$; $A = 21 \cos\left(\frac{\pi}{3}\right) = 21 \times \frac{1}{2} = 10.5$.

The rate of change is $10.5 \text{ cm}^2/\text{radian}$

- 2 a $L(t) = 2 \sin(\pi t) + 10$

$$\text{When } t = 0; L(0) = 2 \sin(0) + 10 = 10.$$

b $\frac{dL}{dt} = 2\pi \cos(\pi t)$

c When $t = 1$ second, $\frac{dL}{dt} = -2\pi \text{ cm/s}$.

- 3 a The period of the function is $2\pi \div \frac{\pi}{6} = 12$ hours.

b Low tide occurs when $\sin\left(\frac{\pi t}{6}\right) = -1$, so

$$H_{\text{low tide}} = 1.5 + 0.5(-1) = 1 \text{ m.}$$

$$1.5 + 0.5 \sin\left(\frac{\pi t}{6}\right) = 1$$

$$0.5 \sin\left(\frac{\pi t}{6}\right) = -0.5$$

$$\sin\left(\frac{\pi t}{6}\right) = -1$$

1 suggests $\frac{\pi}{2}$. Since sin is negative, 3rd quadrant.

$$\frac{\pi t}{6} = \pi + \frac{\pi}{2}$$

$$\frac{\pi t}{6} = \frac{3\pi}{2}$$

$$t = \frac{3\pi}{2} \times \frac{6}{\pi} = 9 \text{ or } 3 \text{ pm}$$

Low tide = 1 metre at 3 pm

$$\text{c } \frac{dH}{dt} = \frac{\pi}{6} \times \frac{1}{2} \cos\left(\frac{\pi t}{6}\right) = \frac{\pi}{12} \cos\left(\frac{\pi t}{6}\right)$$

d At 7.30 am, $t = 1.5$ hours.

$$\begin{aligned} \frac{dH}{dt} &= \frac{\pi}{12} \cos\left(\frac{\pi}{6} \times \frac{3}{2}\right) = \frac{\pi}{12} \cos\left(\frac{\pi}{4}\right) = \frac{\pi}{12} \times \frac{\sqrt{2}}{2} \\ &= \frac{\sqrt{2}\pi}{24} \end{aligned}$$

$$\text{e } \frac{\pi}{12} \cos\left(\frac{\pi t}{6}\right) = \frac{\sqrt{2}\pi}{24}$$

$$\cos\left(\frac{\pi t}{6}\right) = \frac{\sqrt{2}\pi}{24} \times \frac{12}{\pi} = \frac{\sqrt{2}}{2}$$

$\frac{\sqrt{2}}{2}$ suggests $\frac{\pi}{4}$. Since cos is positive, 1st and 4th quadrants.

$$\frac{\pi t}{6} = \frac{\pi}{4}, 2\pi - \frac{\pi}{4}$$

$$\frac{\pi t}{6} = \frac{\pi}{4}, \frac{7\pi}{4}$$

$$t = \frac{\pi}{4} \times \frac{6}{\pi}, \frac{7\pi}{4} \times \frac{6}{\pi}$$

$$t = \frac{3}{2}, \frac{21}{2}$$

The second time is when $t = 10.5$ hours or at 4.30 pm.

$$\text{4 a } 2 \sin(4x) + 1 = \frac{1}{2}$$

$$2 \sin(4x) = -\frac{1}{2}$$

$$\sin(4x) = -\frac{1}{4}$$

$x \approx 0.849, 1.508$

b Max/min values occur when $f'(x) = 0$.

$$f'(x) = 8 \cos(4x)$$

$$0 = 8 \cos(4x)$$

$$0 = \cos(4x)$$

0 suggests $\frac{\pi}{2}, \frac{3\pi}{2}$.

$$4x = \frac{\pi}{2}, \frac{3\pi}{2}$$

$$x = \frac{\pi}{8}, \frac{3\pi}{8}$$

Maximum when

$$x = \frac{\pi}{8}, f\left(\frac{\pi}{8}\right) = 2 \sin\left(\frac{\pi}{2}\right) + 1 = 2 + 1 = 3$$

Minimum when

$$x = \frac{3\pi}{8}, f\left(\frac{3\pi}{8}\right) = 2 \sin\left(\frac{3\pi}{2}\right) + 1 = -2 + 1 = -1$$

The coordinates are $\left(\frac{\pi}{8}, 3\right), \left(\frac{3\pi}{8}, -1\right)$.

$$\text{c } f'\left(\frac{\pi}{4}\right) = 8 \cos\left(4 \times \frac{\pi}{4}\right) = -8$$

d The rate of change is positive for $\left(0, \frac{\pi}{8}\right) \cup \left(\frac{3\pi}{8}, \frac{\pi}{2}\right)$.

5 a $BD = a \sin(\theta)$ and $CD = a \cos(\theta)$.

b Length of sleepers required is
 $= 2a \sin(\theta) + 2 + a + 2 + a \cos(\theta)$
 $= 2a \sin(\theta) + a \cos(\theta) + a + 4$

$$\text{c } \frac{dL}{d\theta} = 2a \cos(\theta) - a \sin(\theta)$$

d $a = 2 \Rightarrow L = 4 \sin(\theta) + 2 \cos(\theta) + 6$

Using CAS:

$$\frac{dL}{d\theta} = 0, \theta = 1.1^\circ$$

6 a

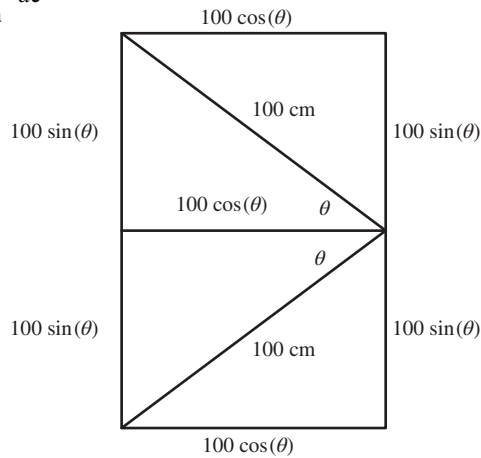

$$\begin{aligned} L &= 3 \times 100 \cos(\theta) + 4 \times 100 \sin(\theta) + 2 \times 100 \\ L &= 300 \cos(\theta) + 400 \sin(\theta) + 200 \text{ as required} \end{aligned}$$

$$\text{b } \frac{dL}{d\theta} = -300 \sin(\theta) + 400 \cos(\theta)$$

c Maximum length occurs when $\frac{dL}{d\theta} = 0$.

$$-300 \sin(\theta) + 400 \cos(\theta) = 0$$

$$400 \cos(\theta) = 300 \sin(\theta)$$

$$400 = 300 \tan(\theta)$$

$$\frac{4}{3} = \tan(\theta)$$

$$\tan^{-1}\left(\frac{4}{3}\right) = \theta$$

$$\theta = 0.93^\circ$$

$$L_{\max} = 300 \cos(0.9273) + 400 \sin(0.9273) + 200$$

$$L_{\max} = 700 \text{ cm}$$

Therefore, the maximum length is 700 cm and this occurs when $\theta = 0.93^\circ$.

7 a

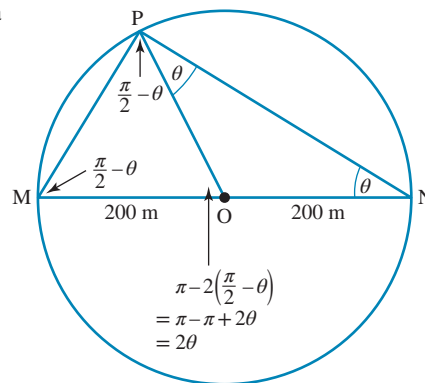

Distance \div time = velocity

Distance = velocity \times time

Distance \div velocity = time

$$\text{So } d(\text{NP}) = 400 \cos(\theta).$$

$$T_{\text{obstacles}} = \frac{400 \cos(\theta)}{2}$$

$$T_{\text{obstacles}} = 200 \cos(\theta)$$

$$d_{\text{MP}} = 200 \times 2\theta$$

$$d_{\text{MP}} = 400\theta$$

$$T_{\text{hurdles}} = \frac{400\theta}{5} = 80\theta$$

$$T_{\text{total}} = T_{\text{obstacles}} + T_{\text{hurdles}}$$

$$T_{\text{total}} = 200 \cos(\theta) + 80\theta$$

$$T_{\text{total}} = 40(5 \cos(\theta) + 2\theta) \text{ as required}$$

$$\mathbf{b} \quad T = 40(5 \cos(\theta) + 2\theta)$$

$$\frac{dT}{d\theta} = 40(-5 \sin(\theta) + 2)$$

$$0 = 40(-5 \sin(\theta) + 2)$$

$$0 = -5 \sin(\theta) + 2$$

$$5 \sin(\theta) = 2$$

$$\sin(\theta) = \frac{2}{5}$$

$$\theta = \sin^{-1}\left(\frac{2}{5}\right) \quad 0 < \theta < \frac{\pi}{2}$$

$$\theta = 0.4115$$

$$\mathbf{c} \quad T_{\text{max}} = 40(5 \cos(0.4115) + 2(0.4115))$$

$$T_{\text{max}} = 216.2244 \text{ seconds}$$

$$T_{\text{max}} = 3 \text{ mins } 36 \text{ seconds}$$

$$\mathbf{8} \quad \mathbf{a} \quad y = \frac{7}{2} \cos\left(\frac{\pi x}{20}\right) + \frac{5}{2} \quad 0 \leq x \leq 20$$

$$y_{\text{max}} = \frac{7}{2} \times 1 + \frac{5}{2} = 6 \text{ m}$$

$$\mathbf{b} \quad \frac{dy}{dx} = -\frac{7\pi}{40} \sin\left(\frac{\pi x}{20}\right)$$

$$\mathbf{c} \quad \mathbf{i} \quad \text{When } x = 5, \frac{dy}{dx} = -\frac{7\pi}{40} \sin\left(\frac{\pi}{4}\right) = -0.3888.$$

$$\mathbf{ii} \quad \text{When } x = 10, \frac{dy}{dx} = -\frac{7\pi}{40} \sin\left(\frac{\pi}{2}\right) = -0.5498.$$

$$\mathbf{d} \quad \mathbf{i} \quad \text{When } y = 0,$$

$$\frac{7}{2} \cos\left(\frac{\pi x}{20}\right) + \frac{5}{2} = 0$$

$$7 \cos\left(\frac{\pi x}{20}\right) + 5 = 0$$

$$7 \cos\left(\frac{\pi x}{20}\right) = -5$$

$$\cos\left(\frac{\pi x}{20}\right) = -\frac{5}{7}$$

$$\frac{\pi x}{20} = \cos^{-1}\left(-\frac{5}{7}\right)$$

$$\frac{\pi x}{20} = 2.3664$$

$$x = \frac{2.3664 \times 20}{\pi}$$

$$x = 15 \text{ m}$$

$$\mathbf{ii} \quad \text{When } x = 15.0649,$$

$$\frac{dy}{dx} = -\frac{7\pi}{40} \sin\left(\frac{\pi \times 15.0649}{20}\right)$$

$$\frac{dy}{dx} = -0.3848$$

If θ is the required angle,

$$\tan(\theta) = -0.3848$$

$$\theta = \tan^{-1}(-0.3848)$$

$$\theta = 180^\circ - 21.05^\circ$$

$$\theta = 158.95^\circ$$

$$\mathbf{9} \quad \mathbf{a} \quad h(x) = 10 \cos\left(\frac{7x}{2}\right) - 5x + 90 \quad 0 \leq x \leq 4.5$$

$$\text{When } x = 0, h(0) = 10 \cos(0) - 5(0) + 90 = 100 \text{ cm.}$$

$$\text{When } x = 4.5, h(4.5) = 10 \cos\left(\frac{7 \times 4.5}{2}\right) - 5(4.5) + 90 = 57.5 \text{ cm}$$

Therefore, the coordinates are (0, 100) and (4.5, 57.5).

$$\mathbf{b} \quad h'(x) = -35 \sin\left(\frac{7x}{2}\right) - 5$$

Minimum value occurs when $h'(x) = 0$.

$$-35 \sin\left(\frac{7x}{2}\right) - 5 = 0$$

$$\sin\left(\frac{7x}{2}\right) = -\frac{1}{7}$$

$$\frac{7x}{2} = \sin^{-1}\left(-\frac{1}{7}\right)$$

$\frac{1}{7}$ suggests 0.1433. Since sin is negative, 3rd quadrant.

$$\frac{7x}{2} = \pi + 0.1433$$

$$\frac{7x}{2} = 3.2849$$

$$x \approx 0.94$$

$$x = 0.9386, h(0.9386) = 10 \cos\left(\frac{7 \times 0.9386}{2}\right) - 5(0.9386) + 90$$

$$h(0.9386) = 75.41 \text{ cm}$$

The coordinates are (0.94, 75.41)

\mathbf{c} When $x = 0.4$,

$$h'(0.4) = -35 \sin\left(\frac{7 \times 0.4}{2}\right) - 5$$

$$h'(0.4) = -39.5$$

$$\mathbf{10} \quad \mathbf{a} \quad h(x) = 2.5 - 2.5 \cos\left(\frac{x}{4}\right) - 5 \leq x \leq 5$$

$$h(5) = 2.5 - 2.5 \cos\left(\frac{5}{4}\right)$$

$$h(5) = 1.7117$$

The maximum depth is 1.7 metres.

$$\mathbf{b} \quad \frac{dh}{dx} = \frac{2.5}{4} \sin\left(\frac{x}{4}\right)$$

$$\frac{dh}{dx} = 0.625 \sin\left(\frac{x}{4}\right)$$

\mathbf{c} When $x = 3$,

$$\frac{dh}{dx} = 0.625 \sin\left(\frac{3}{4}\right)$$

$$\frac{dh}{dx} = 0.426$$

\mathbf{d} When $\frac{dh}{dx} = 0.58$,

$$0.58 = 0.625 \sin\left(\frac{x}{4}\right)$$

$$0.928 = \sin\left(\frac{x}{4}\right) \quad \frac{-5}{4} \leq \frac{x}{4} \leq \frac{5}{4}$$

0.928 suggests 1, 1890. Since sin is positive, 1st quadrant because of the domain.

$$\frac{x}{4} = 1.1890$$

$$x = 4.756 \text{ metres}$$

5.6 Exam questions

1 a

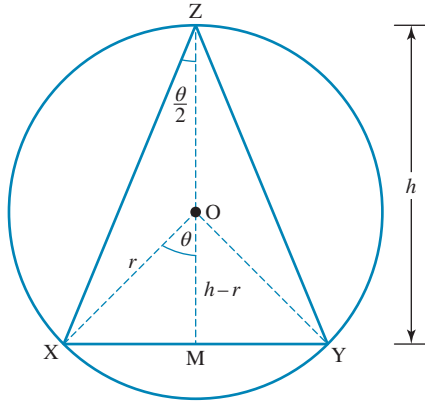

$\angle XOY = 2\theta$ because the angle at the centre of the circle is twice the angle at the circumference.

$$\angle XOM = \angle YOM = \frac{1}{2} \times 2\theta$$

$$\angle XOM = \theta \text{ as required}$$

[1 mark]

b $XM = r \sin(\theta)$

$$\frac{XM}{h-r} = \tan(\theta)$$

$$\frac{r \sin(\theta)}{h-r} = \frac{\sin(\theta)}{\cos(\theta)}$$

$$\frac{r}{h-r} = \frac{1}{\cos(\theta)}$$

$$\frac{h-r}{r} = \cos(\theta)$$

$$\frac{h}{r} - 1 = \cos(\theta)$$

$$\frac{h}{r} = \cos(\theta) + 1$$

[1 mark]

c $r = 3 \text{ cm}, \frac{h}{3} = \cos(\theta) + 1$

$$h = 3 \cos(\theta) + 3$$

$$\frac{dh}{d\theta} = -3 \sin(\theta)$$

[1 mark]

d When $\theta = \frac{\pi}{6}, \frac{dh}{d\theta} = -3 \sin\left(\frac{\pi}{6}\right) = -\frac{3}{2}$.

[1 mark]

2 a $P = -2 \cos(mt) + n$

When $t = 0, P = 4$

$$4 = -2 \cos(0) + n$$

$$4 + 2 = n$$

$$n = 6$$

[1 mark]

The period, m:

$$\frac{3}{2} = \frac{2\pi}{m}$$

$$3m = 4\pi$$

$$m = \frac{4\pi}{3}$$

[1 mark]

b $P = -2 \cos\left(\frac{4\pi t}{3}\right) + 6$

$$\frac{dP}{dt} = \frac{8\pi}{3} \sin\left(\frac{4\pi t}{3}\right)$$

[1 mark]

c When $t = 0.375,$

$$\frac{dP}{dt} = \frac{8\pi}{3} \sin\left(\frac{4\pi \times 0.375}{3}\right)$$

$$= \frac{8\pi}{3} \sin\left(\frac{\pi}{2}\right) = \frac{8\pi}{3} \text{ m/min}$$

[1 mark]

3 a $x(t) = 1.5 \sin\left(\frac{\pi t}{3}\right) + 1.5 \quad 0 \leq t \leq 12$

$$y(t) = 2.0 - 2.0 \cos\left(\frac{\pi t}{3}\right) \quad 0 \leq t \leq 12$$

[1 mark]

Solve $x(t) = y(t)$ on CAS.

The first time the emissions are equal is at $t = 1.9222$ or 1 hour and 55 minutes after 6 am. So at 7.55 am the emissions are both 2.86 units.

[1 mark]

b i $T(t) = x(t) + y(t)$

$$T(t) = 1.5 \sin\left(\frac{\pi t}{3}\right) + 1.5 + 2 - 2 \cos\left(\frac{\pi t}{3}\right)$$

$$T(t) = 3.5 + 1.5 \sin\left(\frac{\pi t}{3}\right) - 2 \cos\left(\frac{\pi t}{3}\right)$$

[1 mark]

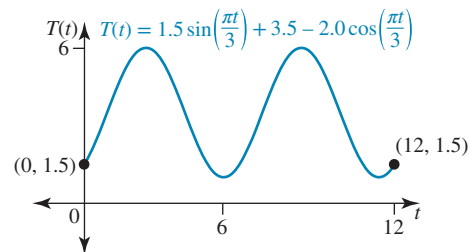

[1 mark]

ii Maximum emission of 6 units at $t = 2.3855$ or 2 hours and 23 minutes after 6 am, which is 8.23 am, and at $t = 8.3855$ or 8 hours and 23 minutes after 6 am, which is 2.23 pm.

[1 mark]

Minimum emission of 1 unit at $t = 5.3855$ or 5 hours and 23 minutes after 6 am, which is 11.23 am, and again at $t = 11.3855$ or 11 hours and 23 minutes after 6 am, which is 5.23 pm.

[1 mark]

c As the emissions range is 1–6 units, they lie within the required range.

[1 mark]

5.7 Differentiation and application of logarithmic functions

5.7 Exercise

1 a $\frac{d}{dx} \left(7 \log_e \left(\frac{x}{3} \right) \right) = \frac{7}{x}$

b $\frac{d}{dx} \left(2 \log_e (x^3 + 2x^2 - 1) \right) = \frac{2(3x^2 + 4x)}{x^3 + 2x^2 - 1}$

c $\frac{d}{dx} \left(3 \log_e (e^{2x} - e^{-x}) \right) = \frac{3(2e^{2x} + e^{-x})}{(e^{2x} - e^{-x})}$
 $= \frac{3e^{-x}(2e^{3x} + 1)}{e^{-x}(e^{3x} - 1)} = \frac{3(2e^{3x} + 1)}{(e^{3x} - 1)}$

d $\frac{d}{dx} \left(\log_e (x^3 - 3x^2 + 7x - 1) \right) = \frac{3x^2 - 6x + 7}{x^3 - 3x^2 + 7x - 1}$

2 a $\frac{d}{dx} \left(4 \log_e \left(\frac{x}{2} \right) \right) = \frac{4}{x}$

b $\frac{d}{dx} \left(-6 \log_e (\cos(x)) \right) = 6 \frac{\sin(x)}{\cos(x)} = 6 \tan(x)$

3 a $y = -5 \log_e(2x)$

$$\frac{dy}{dx} = -5 \times \frac{1}{x}$$

$$\frac{dy}{dx} = -\frac{5}{x}, x \in (0, \infty)$$

b $y = \log_e\left(\frac{1}{x-2}\right)$

$$= \log_e(x-2)^{-1}$$

$$= -\log_e(x-2)$$

$$\frac{dy}{dx} = -\frac{1}{x-2}, x \in (2, \infty)$$

c $y = \log_e\left(\frac{x+3}{x+1}\right) = \log_e(x+3) - \log_e(x+1)$

$$\frac{dy}{dx} = \frac{1}{x+3} - \frac{1}{x+1}$$

$$= \frac{x+1 - (x+3)}{(x+3)(x+1)}$$

$$= -\frac{2}{(x+3)(x+1)}$$

for $x \in (-\infty, -3) \cup (-1, \infty)$

d $y = \log_e(x^2 - x - 6)$

$$\frac{dy}{dx} = \frac{2x-1}{x^2-x-6}, x \in (-\infty, -2) \cap (3, \infty)$$

4 a Dom = $(2, \infty)$ and ran = R

b The graph cuts the x -axis where $y = 0$.

$$2 \log_e(x-2) = 0$$

$$\log_e(x-2) = 0$$

$$e^0 = x-2$$

$$1 = x-2$$

$$x = 3$$

Thus, $(a, 0) = (3, 0)$, so $a = 3$.

c $y = 2 \log_e(x-2)$

$$\frac{dy}{dx} = \frac{2}{x-2}$$

When $x = 3$, $m_T = \frac{dy}{dx} = \frac{2}{(3-2)} = 2$.

The equation of the tangent with $m_T = 2$ that passes through $(x_1, y_1) = (3, 0)$ is given by

$$y - y_1 = m_T(x - x_1)$$

$$y - 0 = 2(x - 3)$$

$$y = 2x - 6$$

d The equation of the perpendicular line with $m_P = -\frac{1}{2}$ that passes through $(x_1, y_1) = (3, 0)$ is given by

$$y - y_1 = m_P(x - x_1)$$

$$y - 0 = -\frac{1}{2}(x - 3)$$

$$y = -\frac{1}{2}x + \frac{3}{2}$$

5 a $y = \log_e(2x-2)$

The gradient of the tangent is $m_T = \frac{dx}{dy} = \frac{2}{2x-2} = \frac{1}{x-1}$.

When $x = 1.5$, $m_T = \frac{1}{1.5-1} = 2$.

The equation of the tangent with $m_T = 2$ that passes through $(x_1, y_1) = (1.5, 0)$ is given by

$$y - y_1 = m_T(x - x_1)$$

$$y - 0 = 2(x - 1.5)$$

$$y = 2x - 3$$

b $y = 3 \log_e(x)$

The gradient of the tangent is $m_T = \frac{dy}{dx} = \frac{3}{x}$

When $x = e$, $m_T = \frac{3}{e}$

The equation of the tangent with $m_T = \frac{3}{e}$ that passes through $(x_1, y_1) = (e, 3)$ is given by

$$y - y_1 = m_T(x - x_1)$$

$$y - 3 = \frac{3}{e}(x - e)$$

$$y - 3 = \frac{3}{e}x - 3$$

$$y = \frac{3}{e}x$$

6 $y = 4 \log_e(3x-1)$

$$\frac{dy}{dx} = \frac{12}{3x-1}$$

If the tangent is parallel to $6x - y + 2 = 0$ or $y = 6x + 2$, then the gradient is 6.

$$m_T = \frac{12}{3x-1} = 6$$

$$12 = 6(3x-1)$$

$$12 = 18x - 6$$

$$18 = 18x$$

$$1 = x$$

When $x = 1$, $y = 4 \log_e(3(1) - 1) = 4 \log_e(2)$.

The equation of the tangent with $m_T = 6$ that passes through $(x_1, y_1) = (1, 4 \log_e(2))$ is given by

$$y - y_1 = m_T(x - x_1)$$

$$y - 4 \log_e(2) = 6(x - 1)$$

$$y - 4 \log_e(2) = 6x - 6$$

$$y = 6x + 4 \log_e(2) - 6$$

7 a $y = 2 \log_e(2x)$

$$\frac{dy}{dx} = \frac{2}{x}$$

b The gradient of the tangent at $\left(\frac{e}{2}, 2\right)$ is $m_T = 2 \div \frac{e}{2} = \frac{4}{e}$.

The equation of the tangent with $m_T = \frac{4}{e}$ that passes

through $(x_1, y_1) = \left(\frac{e}{2}, e\right)$ is given by

$$y - y_1 = m_T(x - x_1)$$

$$y - e = \frac{4}{e}\left(x - \frac{e}{2}\right)$$

$$y - e = \frac{4}{e}x - 2$$

$$y = \frac{4}{e}x - 2 + e$$

8 $y = x$ is a tangent to $y = \log_e(x-1) + b$.

The gradient of the tangent is $m_T = 1$.

Also, the gradient of the tangent is $m_T = \frac{dy}{dx} = \frac{1}{x-1}$.

Thus,

$$\frac{1}{x-1} = 1$$

$$1 = x - 1$$

$$x = 2$$

When $x = 2$, $y = 2$.

$$2 = \log_e(2 - 1) + b$$

$$2 = \log_e(1) + b$$

$$b = 2$$

$$\text{Thus } y = \log_e(x - 1) + 2.$$

The correct answer is **A**.

9 $y = -2x + k$ is perpendicular to $y = \log_e(2(x - 1))$.

The gradient of the perpendicular line is $m_P = -2$.

The gradient of the tangent is $m_T = \frac{1}{2}$.

Also, the gradient of the tangent is $m_T = \frac{dy}{dx} = \frac{1}{x-1}$.

Thus,

$$\frac{1}{x-1} = \frac{1}{2}$$

$$x - 1 = 2$$

$$x = 3$$

When $x = 3$, $y = \log_e(2(3 - 1)) = \log_e(4) \approx 1.3863$.

$$1.3863 = -2(3) + k$$

$$7.3863 = k$$

$$k = 7.4$$

Thus, $y = -2x + 7.4$.

10 Use CAS for this question

a $\frac{d}{dx}(2 \log_5(x))$ given $x = 5$ is $\frac{2}{5} \log_5(e)$.

b $\frac{d}{dx}\left(\frac{1}{3} \log_3(x+1)\right)$ given $x = 2$ is $\frac{1}{9} \log_3(e)$.

c $\frac{d}{dx}(\log_6(x^2 - 3))$ given $x = 3$ is $\log_6(e)$.

d $\frac{d}{dx}\left(\frac{1}{2} \log_6(x^2)\right)$ given $x = e$ is $\frac{1}{e}$.

11 The equation of the tangent is $y = m_T x + c$.

When $y = 0$, $x = 0.3521$

$$0 = 0.3521m_T + c$$

$$-0.3521m_T = c$$

Thus,

$$y = m_T x - 0.3521m_T$$

$$y = m_T(x - 0.3521)$$

But $m_T = \frac{dy}{dx} = \frac{2}{2x-1}$.

Thus, $y = \frac{2}{2x-1}(x - 0.3521)$.

At $x = n$, $y = \frac{2}{2n-1}(n - 0.3521)$. [1]

Also at $x = n$, $y = \log_e(2n - 1)$. [2]

[1] = [2]:

$$\frac{2}{2n-1}(n - 0.3521) = \log_e(2n - 1)$$

$$n = 2 \text{ as } n \text{ is an integer}$$

2 $y = \log_e(2x)$

$$\frac{dy}{dx} = \frac{1}{x} = 2$$

$$x = \frac{1}{2}$$

$$y = \log_e(1) = 0$$

$$P\left(\frac{1}{2}, 0\right)$$

Tangent :

$$y - 0 = 2\left(x - \frac{1}{2}\right)$$

$$y = 2x - 1$$

The tangent crosses the y -axis at $y = -1$.

The correct answer is **C**.

3 $f(x) = \log_e(x) + \log_e(2)$

$$f'(x) = \frac{1}{x} \quad [1 \text{ mark}]$$

$$f'(1) = 1 \quad [1 \text{ mark}]$$

5.8 Review

5.8 Exercise

Technology free: short answer

- 1 a** Stationary points occur at $x = 0$ and $x = 2$, so these will be the x -intercepts on the gradient graph. The original graph is a positive cubic, so the gradient graph will be a positive parabola.

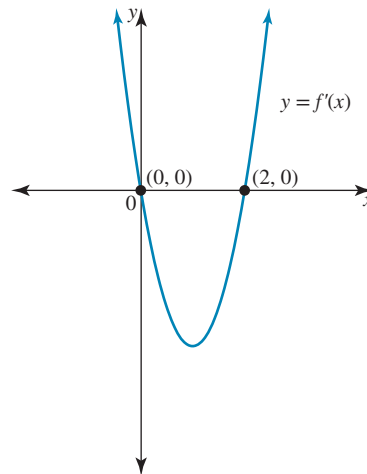

b i $\frac{d}{dx}\left(\log_e\left(\frac{x+2}{x-3}\right)\right)$

$$= \frac{d}{dx}(\log_e(x+2) - \log_e(x-3))$$

$$= \frac{1}{x+2} - \frac{1}{x-3}$$

$$= \frac{x-3}{(x+2)(x-3)} - \frac{x+2}{(x+2)(x-3)}$$

$$= \frac{x-3-(x+2)}{(x+2)(x-3)}$$

$$= \frac{-5}{(x+2)(x-3)}$$

5.7 Exam questions

1 $f(x) = -\log_e(x+2)$

$$f(0) = -\log_e(2)$$

$$c = -\log_e(2)$$

T : when $x = 0$ has $c = -\log_e(2)$

The correct answer is **C**.

Restrictions on x :

$$\frac{x+2}{x-3} > 0$$

$$\frac{x+2}{x-3} \times (x-3)^2 > 0 \times (x-3)^2$$

$$(x+2)(x-3) > 0$$

$$\therefore x \in (-\infty, -2) \cup (3, \infty)$$

ii $\frac{d}{dx} (\log_e(x+2)^2)$

$$= \frac{d}{dx} (2 \log_e(x+2))$$

$$= \frac{2}{x+2}$$

Restrictions on x :

$$(x+2)^2 > 0 \text{ for all values except } x = -2$$

Therefore, $x \in \mathbb{R} \setminus \{-2\}$

2 a $f(x) = 3 \sin(2x) - 4$

$$f'(x) = 6 \cos(2x)$$

b $f'\left(\frac{\pi}{3}\right) = 6 \cos\left(\frac{2\pi}{3}\right)$

$$= 6 \times -\frac{1}{2}$$

$$= -3$$

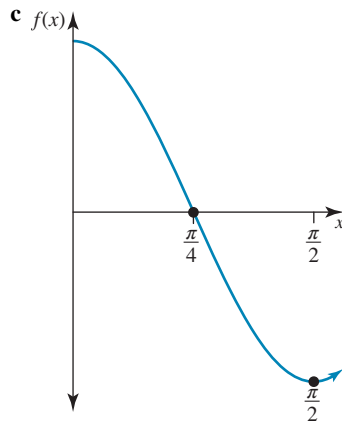

The gradient is positive for $\left\{x: 0 \leq x < \frac{\pi}{4}\right\}$.

3 $y = -3 \cos\left(\frac{\pi x}{6}\right) + 7$

$$m_T = \frac{dy}{dx} = \frac{\pi}{2} \sin\left(\frac{\pi x}{6}\right)$$

When $x = 3$, $m_T = \frac{\pi}{2} \sin\left(\frac{\pi}{2}\right) = \frac{\pi}{2}$ and $m_P = -\frac{2}{\pi}$.

When $x = 3$, $y = -3 \cos\left(\frac{\pi(3)}{6}\right) + 7 = 7$.

The equation of the tangent with $m_T = \frac{\pi}{2}$ and $(x_1, y_1) = (3, 7)$

is given by:

$$y - y_1 = m_T(x - x_1)$$

$$y - 7 = \frac{\pi}{2}(x - 3)$$

$$y = \frac{\pi}{2}x - \frac{3\pi}{2} + 7$$

The equation of the line perpendicular to the curve with

$m_P = -\frac{2}{\pi}$ and $(x_1, y_1) = (3, 7)$ is given by:

$$y - y_1 = m_P(x - x_1)$$

$$y - 7 = -\frac{2}{\pi}(x - 3)$$

$$y = -\frac{2}{\pi}x + \frac{6}{\pi} + 7$$

4 $x - 2y = 5$

$$2y = x - 5$$

$$y = \frac{x}{2} - \frac{5}{2}$$

$$m_P = \frac{1}{2}, \therefore m_T = -2$$

$$f(x) = x^2 - 2x + 3$$

$$f'(x) = 2x - 2$$

$$-2 = 2x - 2$$

$$x = 0$$

$$f(0) = (0 - 1)^2 + 2$$

$$= 1 + 2$$

$$= 3$$

The equation of the tangent with $m = -2$ that touches the curve at $(0, 3)$ is given by:

$$y - 3 = -2(x - 0)$$

$$y = -2x + 3$$

5 a

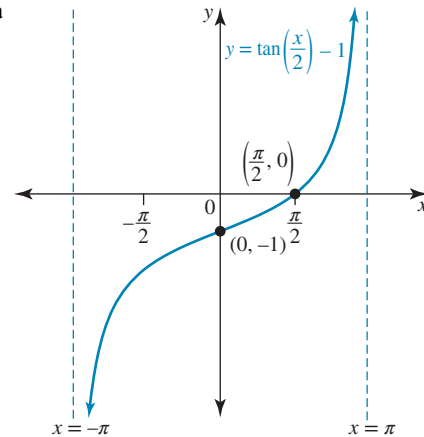

b $f'(x) = \frac{1}{2} \sec^2\left(\frac{x}{2}\right)$

$$= \frac{1}{2 \left(\cos\left(\frac{x}{2}\right)\right)^2}$$

$$f'\left(\frac{\pi}{3}\right) = \frac{1}{2 \left(\cos\left(\frac{\pi}{6}\right)\right)^2}$$

$$= \frac{1}{2 \left(\frac{\sqrt{3}}{2}\right)^2}$$

$$= \frac{2}{3}$$

6 a $f(x) = ke^{x^2}$

$$f'(x) = 2xke^{x^2}$$

$$f'(4) = 8ke^{16}$$

$$\therefore 8ke^{16} = 4e^{16}$$

$$\therefore k = \frac{1}{2}$$

b $f'(x) = xe^{x^2}$

$$f'(2) = 2e^{2^2} = 2e^4$$

c $m_T = f'(2) = 2e^4$

$$m_P = -\frac{1}{2e^4}$$

$$f(2) = \frac{1}{2}e^4$$

Equation of the line perpendicular to the curve with

$$m_P = -\frac{1}{2e^4} \text{ and passing through } \left(2, \frac{1}{2}e^4\right):$$

$$y - \frac{1}{2}e^4 = -\frac{1}{2e^4}(x - 2)$$

$$y = -\frac{x}{2e^4} + \frac{1}{e^4} + \frac{1}{2}e^4$$

Technology active: multiple choice

7 $f(x) = m \cos(3x)$

$$f'(x) = -3m \sin(3x)$$

$$f'\left(\frac{\pi}{6}\right) = -3m \sin\left(\frac{\pi}{2}\right)$$

$$f'\left(\frac{\pi}{6}\right) = -3m = -3$$

So $m = 1$.

The correct answer is **A**.

8 $y = e^{-x} + 3$

$$\frac{dy}{dx} = -e^{-x}$$

When $x = 0$,

$$\frac{dy}{dx} = -e^0 = -1$$

The correct answer is **C**.

9 $y = \frac{\sqrt[3]{x} - 4x^2}{2x^3}$

$$= \frac{x^{-\frac{8}{3}}}{2} - 2x^{-1}$$

$$\frac{dy}{dx} = -\frac{8}{3} \times \frac{x^{-\frac{11}{3}}}{2} - (-1) \times 2x^{-2}$$

$$= -\frac{4}{3x^{\frac{11}{3}}} + \frac{2}{x^2}$$

The correct answer is **C**.

10 $\frac{d}{dx} \left(\frac{\sin^3(\theta) + \sin(\theta)\cos^2(\theta)}{\cos(\theta)} \right)$

$$= \frac{d}{dx} \left(\frac{\sin(\theta)[\sin^2(\theta) + \cos^2(\theta)]}{\cos(\theta)} \right)$$

$$= \frac{d}{dx} \left(\frac{\sin(\theta)}{\cos(\theta)} \right)$$

$$= \frac{d}{dx}(\tan(\theta))$$

$$= \frac{1}{\cos^2(\theta)}$$

The correct answer is **E**.

11 $y = \log_e\left(\frac{2}{x}\right)$

$$\frac{dy}{dx} = \log_e(2x^{-1})$$

$$\frac{dy}{dx} = \frac{-2x^{-2}}{2x^{-1}}$$

$$\frac{dy}{dx} = \frac{-2x^{-2+1}}{2}$$

$$\frac{dy}{dx} = -\frac{1}{x}$$

The correct answer is **E**.

12 $y = 2 \tan(3x)$

$$\frac{dy}{dx} = \frac{6}{\cos^2(3x)}$$

The correct answer is **C**.

13 $d_{\text{high}} = 6 + 2(1) = 8 \text{ m}$

$$d_{\text{low}} = 6 + 2(-1) = 4 \text{ m}$$

The correct answer is **C**.

14 $d = 6 + 2 \cos\left(\frac{\pi t}{6}\right)$

$$\frac{dd}{dt} = -\frac{\pi}{3} \sin\left(\frac{\pi t}{6}\right)$$

When $t = 4$ hours or 2 pm,

$$\frac{dd}{dt} = -\frac{\pi}{3} \sin\left(\frac{2\pi}{3}\right)$$

$$\frac{dd}{dt} = -\frac{\pi}{3} \sin\left(\frac{\pi}{3}\right)$$

$$\frac{dd}{dt} = -\frac{\sqrt{3}\pi}{6}$$

The correct answer is **A**.

15 $y = 2x - e^{-2x}$

$$m_T = \frac{dy}{dx} = 2 + 2e^{-2x}$$

$$\text{When } x = 0, m_T = 2 + 2e^0 = 4$$

$$\text{When } x = 0, y = 2(0) - e^0 = -1$$

The equation of the tangent with $m_T = 4$ and $(x_1, y_1) = (0, -1)$ is given by:

$$y - y_1 = m_T(x - x_1)$$

$$y + 1 = 4(x - 0)$$

$$y = 4x - 1$$

The correct answer is **D**.

16 $y = \log_e(x + 5)$

$$\text{When } x = e - 5,$$

$$y = \log_e(e - 5 + 5)$$

$$= \log_e(e)$$

$$= 1$$

$$\Rightarrow (e - 5, 1)$$

$$\text{Gradient of tangent} = m_T = \frac{dy}{dx} = \frac{1}{x + 5}$$

When $x = e - 5$,

$$m_T = \frac{1}{e - 5 + 5}$$

$$= \frac{1}{e}$$

$$\therefore y = \frac{1}{e}x + c$$

Substitute in point $(e - 5, 1)$.

$$1 = \frac{1}{e}(e - 5) + c$$

$$1 = 1 - \frac{5}{e} + c$$

$$c = \frac{5}{e}$$

$$\Rightarrow y = \frac{1}{e}x + \frac{5}{e}$$

$$ey = x + 5$$

The correct answer is **B**.

Technology active: extended response

17 a $y = f(x) = a \sin(x) + b \cos(x)$

 When $x = 0$, $y = 7$; thus,

$$7 = a \sin(0) + b \cos(0)$$

$$b = 7$$

$$y = a \sin(x) + 7 \cos(x)$$

 When $x = \frac{\pi}{2}$, $y = 3$; thus,

$$3 = a \sin\left(\frac{\pi}{2}\right) + 7 \cos\left(\frac{\pi}{2}\right)$$

$$a = 3$$

$$y = 3 \sin(x) + 7 \cos(x)$$

- b** The maximum and minimum values of the function over the given domain can be determined using a graph page on CAS. They are found to be 7.6 and -7.6 respectively. Therefore, the range is $[-7.6, 7.6]$.

c $f(x) = 0 \quad 0 \leq x \leq 2\pi$

$$3 \sin(x) + 7 \cos(x) = 0$$

$$3 \sin(x) = -7 \cos(x)$$

$$3 \tan(x) = -7$$

$$\tan(x) = -\frac{7}{3}$$

$$x = 1.9757, 5.1173$$

d $f'(x) = 3 \cos(x) - 7 \sin(x)$

$$f'(1.9757) = 3 \cos(1.9757) - 7 \sin(1.9757) = -7.616$$

$$f'(5.1173) = 3 \cos(5.1173) - 7 \sin(5.1173) = 7.616$$

- 18 a** M and P are the end points of the function

$$y = 2 \sin(2x) + \frac{5}{2}$$

$$x = 0, y = 2 \sin(0) + \frac{5}{2} = \frac{5}{2}$$

$$x = \pi, y = 2 \sin(2\pi) + \frac{5}{2} = \frac{5}{2}$$

$$M\left(0, \frac{5}{2}\right)$$

$$P\left(\pi, \frac{5}{2}\right)$$

b $y = 2 \sin(2x) + \frac{5}{2}$

$$\frac{dy}{dx} = 4 \cos(2x)$$

c When $x = \frac{2\pi}{3}$,

$$y = 2 \sin\left(\frac{4\pi}{3}\right) + \frac{5}{2}$$

$$= 2 \times -\frac{\sqrt{3}}{2} + \frac{5}{2}$$

$$= -\sqrt{3} + \frac{5}{2}$$

$$\therefore t = \frac{5}{2} - \sqrt{3}$$

d When $x = \frac{2\pi}{3}$, $\frac{dy}{dx} = 4 \cos\left(\frac{4\pi}{3}\right) = 4 \times -\frac{1}{2} = -2$.

$$\therefore m_T = -2$$

$$\therefore m_P = \frac{1}{2}$$

The gradient of the track is 0.5.

e $y = \frac{1}{2}x + c$

 The value of c can be found by substituting the point

$$\left(\frac{2\pi}{3}, \frac{5}{2} - \sqrt{3}\right).$$

$$\frac{5}{2} - \sqrt{3} = \frac{1}{2} \times \frac{2\pi}{3} + c$$

$$c = \frac{5}{2} - \sqrt{3} - \frac{\pi}{3}$$

$$\therefore y = \frac{1}{2}x + \frac{5}{2} - \sqrt{3} - \frac{\pi}{3}$$

19 a $B = B_0 e^{kt}$

 When $t = 0$, $B = 1.5$ units.

$$1.5 = B_0 e^{k(0)}$$

$$B_0 = 1.5$$

b $B = 1.5e^{kt}$

$$\frac{dB}{dt} = 1.5ke^{kt}$$

$$\therefore 0.55 = 1.5ke^{4k}$$

 Solving this equation by using CAS yields the solution $k = 0.1791$.

c $B(t) = A_0 e^{ht}$

 When $t = 10$,

$$A_0 e^{10h} = 9 \quad [1]$$

 When $t = 14$,

$$A_0 e^{14h} = 7 \quad [2]$$

$$(2) \div (1) \Rightarrow \frac{e^{14h}}{e^{10h}} = \frac{7}{9}$$

$$e^{4h} = \frac{7}{9}$$

$$4h = \log_e\left(\frac{7}{9}\right)$$

$$h = \frac{1}{4} \log_e\left(\frac{7}{9}\right) = -0.0628$$

Substitute into [2]:

$$A_0 e^{14 \times -0.0628} = 7$$

$$A_0 = 16.8696$$

d $B(t) = 16.8696e^{-0.0628t}$

$$B'(t) = -1.0599e^{-0.0628t}$$

$$B'(14) = -1.0599e^{-0.0628 \times 14}$$

$$= -0.44$$

Therefore, the rate of decrease of the biomass is 0.44 units/day.

20 a $P = P_0 e^{kt}$

 When $t = 0$, $P = 500$, so

$$500 = P_0 e^{k(0)}$$

$$500 = P_0$$

 Thus, $P = 500e^{kt}$

 When $t = 7.2$, $P = 1000$, so

$$1000 = 500e^{k(7.2)}$$

$$2 = e^{7.2k}$$

$$\log_e(2) = 7.2k$$

$$\frac{1}{7.2} \log_e(2) = k$$

$$k = 0.0963$$

 So $P = 500e^{0.0963t}$

b When $t = 50$, $P = 500e^{0.0963(50)} = 61\,673$.

 $P = 62\,000$ bacterial cells to the nearest thousand.

$$c \frac{dP}{dt} = 0.0963 \times 500e^{0.0963t}$$

$$\frac{dP}{dt} = 48.15e^{0.0963t}$$

$$\text{When } t = 30, \frac{dP}{dt} = 48.15e^{0.0963(30)} \\ = 865.5 \text{ bacterial cells/hour.}$$

$$d \ P = Q_0e^{mt}$$

$$\text{When } t = 0, P = 61\,673, \text{ so}$$

$$61\,673 = Q_0e^{m(0)}$$

$$61\,673 = Q_0$$

$$Q_0 = 62\,000$$

$$e \ \text{If } m = -0.2008, P = 62\,000e^{-0.2008t}$$

$$\frac{dp}{dt} = -0.2008 \times 62\,000e^{-0.2008t}$$

$$\frac{dp}{dt} = -12\,449.6e^{-0.2008t}$$

$$t = 10, \frac{dp}{dt} = -12\,449.6e^{-0.2008 \times 10} \\ = -1671.44$$

The rate of decrease is 1671 bacterial cells/hour.

$$3 \ y = x^2 - 5$$

Positive x -intercept: A $(\sqrt{5}, 0)$, y -intercept B $(0, -5)$

$$\text{Gradient } m_{AB} = \frac{-5 - 0}{0 - \sqrt{5}} = \frac{5}{\sqrt{5}} = \sqrt{5}$$

$$\frac{dy}{dx} = 2x = \sqrt{5} \Rightarrow x = \frac{\sqrt{5}}{2}$$

The correct answer is **D**.

$$4 \ a \ f : [0, 8\pi] \rightarrow R, f(x) = 2 \cos\left(\frac{x}{2}\right) + \pi$$

$$\text{Period} = \frac{2\pi}{\frac{1}{2}} = 4\pi, \text{ range } [-2 + \pi, 2 + \pi]$$

Award 1 mark for the correct period.

Award 1 mark for the correct range.

VCAA Assessment Report note:

This question was answered well. However, some students included round brackets instead of square brackets for the range. Range $= [2 + \pi, -2 + \pi]$ was occasionally seen. Some students gave approximate answers instead of exact answers.

$$b \ f'(x) = -\sin\left(\frac{x}{2}\right)$$

Award 1 mark for the correct derivative.

VCAA Assessment Report note:

This question was answered well. Some students did not write an equation, leaving their answer as $-\sin\left(\frac{x}{2}\right)$.

Others made errors when using the chain rule. Some had their technology in degree mode rather than radian mode.

$$c \ f(\pi) = 2 \cos\left(\frac{\pi}{2}\right) + \pi = \pi.$$

$$f'(\pi) = -\sin\left(\frac{\pi}{2}\right) = -1, P(\pi, \pi)$$

$$T : y - \pi = -1(x - \pi)$$

$$y = -x + 2\pi$$

Award 1 mark for the correct tangent equation.

VCAA Assessment Report note:

This question was answered well. Students were not required to show any working. The answer could be obtained directly using technology. Some left their answer as $-x + 2\pi$.

$$d \ f'(x) = -\sin\left(\frac{x}{2}\right) = 1 \text{ and } 0 \leq x \leq 8\pi$$

$$x = 3\pi, 7\pi,$$

$$f(3\pi) = \pi, f(7\pi) = \pi$$

$$T_1 : y - \pi = 1(x - 3\pi)$$

$$y = x - 2\pi$$

$$T_2 : y - \pi = 1(x - 7\pi)$$

$$y = x - 6\pi$$

Award 1 mark for each correct tangent equation. 2 marks total.

VCAA Assessment Report note:

Once students found $x = 3\pi$ or $x = 7\pi$ the rest of the question could be completed using technology. Some students gave only one of the equations of the tangents.

5.8 Exam questions

$$1 \ a \ f(x) = x^2 + 3x + 5$$

$f(1) = 1 + 3 + 5 = 9 \neq 0$, so the point $P(1, 0)$ is not on the graph of $y = f(x)$

Award 1 mark for the correct explanation.

$$b \ i \ Q(a, f(a))$$

$$m(PQ) = \frac{f(a) - 0}{a - 1} = \frac{a^2 + 3a + 5}{a - 1}$$

Award 1 mark for the correct answer.

$$ii \ f'(x) = 2x + 3, f'(a) = 2a + 3$$

Award 1 mark for equating and solving.

$$iii \ f'(a) = m$$

$$-(a^2 + 3a + 5) = (2a + 3)(1 - a)$$

$$-a^2 - 3a - 5 = -2a^2 - a + 3$$

$$a^2 - 2a - 8 = 0$$

$$(a - 4)(a + 2) = 0$$

$$a = -2, 4$$

Award 1 mark for equating and solving.

Award 1 mark for both correct values of a .

$$iv \ a = 4f'(4) = 11 \quad y = 11(x - 1) = 11x - 11$$

or

$$a = -2f'(-2) = -1 \quad y = -1(x - 1) = 1 - x$$

Award 1 mark for the correct tangent.

c The turning point on the graph of f at $x = -\frac{3}{2}$ needs to be above the point P ,

$$\text{so translate } f, \frac{3}{2} + 1 = \frac{5}{2} \text{ so that } k = \frac{5}{2}.$$

Award 1 mark for the correct method.

Award 1 mark for the correct value of k .

$$2 \ \text{The gradient is negative for } x \in (-\infty, -2) \cup \left(\frac{1}{3}, \infty\right)$$

The correct answer is **C**.

$$\mathbf{e} \quad f(x) = 2f'(x) + \pi$$

$$2 \cos\left(\frac{\pi}{2}\right) + \pi = -2 \sin\left(\frac{\pi}{2}\right) + \pi$$

$$2 \cos\left(\frac{\pi}{2}\right) = -2 \sin\left(\frac{x}{2}\right)$$

$$\tan\left(\frac{x}{2}\right) = -1, \quad 0 \leq x \leq 8\pi$$

$$\frac{x}{2} = \frac{3\pi}{4}, \frac{7\pi}{4}, \frac{11\pi}{4}, \frac{15\pi}{4}$$

$$x = \frac{3\pi}{2}, \frac{7\pi}{2}, \frac{11\pi}{2}, \frac{15\pi}{2}$$

Award 1 mark for solving the tangent equation.

Award 1 mark for all four correct solutions.

VCAA Assessment Report note:

Some students gave $x = \frac{\pi}{2}, \frac{5\pi}{2}, \frac{9\pi}{2}, \frac{13\pi}{2}$ as the answer.

Others tried solving $2f'(x) + \pi = 0$ instead of $2f'(x) + \pi = f(x)$.

$$\mathbf{5} \quad y = x^2 \Rightarrow \frac{dy}{dx} = 2x, \quad \left. \frac{dy}{dx} \right|_{x=2} = 4P(2, 4)$$

$$T: y - 4 = 4(x - 2)$$

$$= 4x - 8$$

$$y = 4x - 4$$

When $x = 3$, $y = 12 - 4 = 8$

$(3, 8)$ lies on the tangent.

The correct answer is **B**.

Topic 6 — Further differentiation and applications

6.2 The chain rule

6.2 Exercise

1 a $y = \sqrt{x^2 - 7x + 1} = (x^2 - 7x + 1)^{\frac{1}{2}}$

$$\frac{dy}{dx} = \frac{1}{2}(2x - 7)(x^2 - 7x + 1)^{-\frac{1}{2}} = \frac{2x - 7}{2\sqrt{x^2 - 7x + 1}}$$

b $y = (3x^2 + 2x - 1)^3$

$$\frac{dy}{dx} = 3(6x + 2)(3x^2 + 2x - 1)^2 = 6(3x + 1)(3x^2 + 2x - 1)^2$$

c $y = \sin^2(x) = (\sin(x))^2$

$$\frac{dy}{dx} = 2 \cos(x) \sin(x)$$

d $y = e^{\cos(3x)}$

$$\frac{dy}{dx} = -3 \sin(3x)e^{\cos(3x)}$$

2 a $y = g(x) = 3(x^2 + 1)^{-1}$

Let $u = x^2 + 1$ so $\frac{du}{dx} = 2x$.

Let $y = 3u^{-1}$ so $\frac{dy}{du} = -3u^{-2} = -\frac{3}{u^2}$.

$$\frac{dy}{dx} = \frac{dy}{du} \times \frac{du}{dx}$$

$$\frac{dy}{dx} = -\frac{3}{u^2} \times 2x = -\frac{6x}{(x^2 + 1)^2}$$

b $y = g(x) = e^{\cos(x)}$

Let $u = \cos(x)$ so $\frac{du}{dx} = -\sin(x)$.

Let $y = e^u$ so $\frac{dy}{du} = e^u$.

$$\frac{dy}{dx} = \frac{dy}{du} \times \frac{du}{dx}$$

$$\frac{dy}{dx} = e^u \times -\sin(x) = -\sin(x)e^{\cos(x)}$$

c $y = g(x) = \sqrt{(x+1)^2 + 2} = (x^2 + 2x + 3)^{\frac{1}{2}}$

Let $u = x^2 + 2x + 3$ so $\frac{du}{dx} = 2x + 2$.

Let $y = u^{\frac{1}{2}}$ so $\frac{dy}{du} = \frac{1}{2}u^{-\frac{1}{2}} = \frac{1}{2\sqrt{u}}$.

$$\frac{dy}{dx} = \frac{dy}{du} \times \frac{du}{dx}$$

$$\frac{dy}{dx} = \frac{1}{2\sqrt{u}} \times 2(x+1) = \frac{x+1}{\sqrt{x^2 + 2x + 3}}$$

d $y = g(x) = \frac{1}{\sin^2(x)} = (\sin(x))^{-2}$

Let $u = \sin(x)$ so $\frac{du}{dx} = \cos(x)$.

Let $y = u^{-2}$ so $\frac{dy}{du} = -2u^{-3} = -\frac{2}{u^3}$.

$$\frac{dy}{dx} = \frac{dy}{du} \times \frac{du}{dx}$$

$$\frac{dy}{dx} = -\frac{2}{u^3} \times \cos(x) = -\frac{2 \cos(x)}{\sin^3(x)}$$

e $y = f(x) = \sqrt{x^2 - 4x + 5} = (x^2 - 4x + 5)^{\frac{1}{2}}$

Let $u = x^2 - 4x + 5$ so $\frac{du}{dx} = 2x - 4$.

Let $y = u^{\frac{1}{2}}$ so $\frac{dy}{du} = \frac{1}{2}u^{-\frac{1}{2}} = \frac{1}{2\sqrt{u}}$.

$$\frac{dy}{dx} = \frac{dy}{du} \times \frac{du}{dx}$$

$$\frac{dy}{dx} = \frac{1}{2\sqrt{u}} \times 2(x-2) = \frac{x-2}{\sqrt{x^2 - 4x + 5}}$$

f $y = f(x) = 3 \cos(x^2 - 1)$

Let $u = x^2 - 1$ so $\frac{du}{dx} = 2x$.

Let $y = 3 \cos(u)$ so $\frac{dy}{du} = -3 \sin(u)$.

$$\frac{dy}{dx} = \frac{dy}{du} \times \frac{du}{dx}$$

$$\frac{dy}{dx} = -3 \sin(u) \times 2x = -6x \sin(x^2 - 1)$$

3 a $y = f(x) = 5e^{3x^2 - 1}$

Let $u = 3x^2 - 1$ so $\frac{du}{dx} = 6x$.

Let $y = 5e^u$ so $\frac{dy}{du} = 5e^u$.

$$\frac{dy}{dx} = \frac{dy}{du} \times \frac{du}{dx}$$

$$\frac{dy}{dx} = 5e^u \times 6x = 30xe^{3x^2 - 1}$$

b $y = f(x) = \left(x^3 - \frac{2}{x^2}\right)^{-2} = (x^3 - 2x^{-2})^{-2}$

Let $u = x^3 - 2x^{-2}$ so $\frac{du}{dx} = 3x^2 + 4x^{-3} = \left(3x^2 + \frac{4}{x^3}\right)$.

Let $y = u^{-2}$ so $\frac{dy}{du} = -2u^{-3} = -\frac{2}{u^3}$.

$$\frac{dy}{dx} = \frac{dy}{du} \times \frac{du}{dx}$$

$$\begin{aligned} \frac{dy}{dx} &= -\frac{2}{u^3} \times \left(3x^2 + \frac{4}{x^3}\right) \\ &= -\frac{2}{\left(x^3 - \frac{2}{x^2}\right)^3} \times \left(\frac{3x^5 + 4}{x^3}\right) \\ &= -\frac{6x^5 + 8}{x^3 \left(x^3 - \frac{2}{x^2}\right)^3} \end{aligned}$$

c $y = f(x) = \frac{\sqrt{2-x}}{2-x} = \frac{1}{\sqrt{2-x}} = (2-x)^{-\frac{1}{2}}$

Let $u = 2 - x$ so $\frac{du}{dx} = -1$.

Let $y = u^{-\frac{1}{2}}$ so $\frac{dy}{du} = -\frac{1}{2}u^{-\frac{3}{2}} = -\frac{1}{2u^{\frac{3}{2}}}$.

$$\frac{dy}{dx} = \frac{dy}{du} \times \frac{du}{dx}$$

$$\frac{dy}{dx} = -\frac{1}{2u^{\frac{3}{2}}} \times -1 = \frac{1}{2(2-x)^{\frac{3}{2}}}$$

- d** $y = f(x) = \cos^3(2x + 1) = (\cos(2x + 1))^3$
 Let $u = \cos(2x + 1)$ so $\frac{du}{dx} = -2 \sin(2x + 1)$.
 Let $y = u^3$ so $\frac{dy}{du} = 3u^2$.
 $\frac{dy}{dx} = \frac{dy}{du} \times \frac{du}{dx}$
 $\frac{dy}{dx} = 3u^2 \times -2 \sin(2x + 1) = -6 \sin(2x + 1) \cos^2(2x + 1)$
 $\frac{dy}{dx} = \frac{dy}{du} \times \frac{du}{dx}$
 $\frac{dy}{dx} = 3u^2 \times -2 \sin(2x + 1) = -6 \sin(2x + 1) \cos^2(2x + 1)$
- 4 a** $\frac{d}{dx} (\sqrt{\log_e(3 - 2x)}) = \frac{d}{dx} (\log_e(3 - 2x))^{\frac{1}{2}}$
 $= \frac{-2}{(3 - 2x)} \times \frac{1}{2} (\log_e(3 - 2x))^{-\frac{1}{2}}$
 $= \frac{-1}{(3 - 2x)\sqrt{\log_e(3 - 2x)}}$
 $= \frac{-1}{(2x - 3)\sqrt{\log_e(3 - 2x)}}$
- b** $\frac{d}{dx} \left(\frac{1}{2} \log_e(\sqrt{x - 2}) \right) = \frac{d}{dx} \left(\frac{1}{2} \log_e(x - 2)^{\frac{1}{2}} \right)$
 $= \frac{d}{dx} \left(\frac{1}{2} \times \frac{1}{2} \log_e(x - 2) \right)$
 $= \frac{1}{4} \times \frac{1}{x - 2}$
 $= \frac{1}{4(x - 2)}$
- 5** $y = \sin^3(x) = (\sin(x))^3$
 $\frac{dy}{dx} = 3 \cos(x) \sin^2(x)$
 When $x = \frac{\pi}{3}$, $\frac{dy}{dx} = 3 \cos\left(\frac{\pi}{3}\right)$
 $= 3 \times \frac{1}{2} \times \left(\frac{\sqrt{3}}{2}\right)^2 = \frac{9}{8}$
- 6 a** $f(x) = \tan(4x + \pi)$
 $f'(x) = \frac{4}{\cos^2(4x + \pi)}$
 $f'\left(\frac{\pi}{4}\right) = \frac{4}{\cos^2\left(4\left(\frac{\pi}{4}\right) + \pi\right)} = \frac{4}{\cos^2(2\pi)} = 4$
- b** $f(x) = (2 - x)^{-2}$
 $f'(x) = -2(-1)(2 - x)^{-3} = \frac{2}{(2 - x)^3}$
 $f'\left(\frac{1}{2}\right) = \frac{2}{\left(2 - \frac{1}{2}\right)^3} = 2 \div \frac{27}{8} = \frac{16}{27}$
- c** $f(x) = e^{2x^2}$
 $f'(x) = 4xe^{2x^2}$
 $f'(-1) = 4(-1)e^{2(-1)^2} = -4e^2$
- d** $f(x) = \sqrt[3]{(3x^2 - 2)^4} = (3x^2 - 2)^{\frac{4}{3}}$
 $f'(x) = \frac{4}{3}(3x^2 - 2)^{\frac{1}{3}} \times 6x = 8x\sqrt[3]{3x^2 - 2}$
 $f'(1) = 8(1)\sqrt[3]{3(1)^2 - 2} = 8$
- 7 a** $y = e^{\sin^2(x)}$
 $\frac{dy}{dx} = 2 \cos(x) \sin(x) e^{\sin^2(x)}$
 When $x = \frac{\pi}{2}$, $\frac{dy}{dx} = 2 \cos\left(\frac{\pi}{4}\right) \sin\left(\frac{\pi}{4}\right) e^{\sin^2\left(\frac{\pi}{4}\right)}$
 $= 2 \times \frac{\sqrt{2}}{2} \times \frac{\sqrt{2}}{2} e^{\left(\frac{\sqrt{2}}{2}\right)^2}$
 $= e^{\frac{1}{2}} = \sqrt{e}$
- b** $f(x) = (\cos(3x) - 1)^5$
 $f'(x) = 5 \times -3 \sin(3x) (\cos(3x) - 1)^4$
 $= -15 \sin(3x) (\cos(3x) - 1)^4$
 $f'\left(\frac{\pi}{2}\right) = -15 \sin\left(\frac{3\pi}{2}\right) \left(\cos\left(\frac{3\pi}{2}\right) - 1\right)^4$
 $= -15(-1)(-1^4) = 15$
- 8 a** $f(x) = g[\cos(x)]$
 $f'(x) = -\sin(x)g'[\cos(x)]$
- b** $f(x) = g(2x^3)$
 $f'(x) = 6x^2g'(2x^3)$
- c** $f(x) = g(3e^{2x+1})$
 $f'(x) = 6e^{2x+1}g'(3e^{2x+1})$
- d** $f(x) = g(\sqrt{2x^2 - x}) = g\left((2x^2 - x)^{\frac{1}{2}}\right)$
 $f'(x) = \frac{1}{2}(4x - 1)(2x^2 - x)^{-\frac{1}{2}}g'\left((2x^2 - x)^{\frac{1}{2}}\right)$
 $= \frac{4x - 1}{2\sqrt{2x^2 - x}}g'\left(\sqrt{2x^2 - x}\right)$
- 9 a** $f(x) = [h(x)]^{-2}$ so $f'(x) = -2h'(x)[h(x)]^{-3}$
- b** $f(x) = \sin^2[h(x)]$ so $f'(x) = 2h'(x)\sin[h(x)]$
- c** $f(x) = \sqrt[3]{2h(x) + 3}$ so $f'(x) = \frac{1}{3}(2h'(x))(2h(x) + 3)^{-\frac{2}{3}}$
 $= \frac{2h'(x)}{3(2h(x) + 3)^{\frac{2}{3}}}$
- d** $f(x) = -2e^{h(x)+4}$ so $f'(x) = -2h'(x)e^{h(x)+4}$
- 10** $f(x) = \frac{1}{x^2}$ so $g(x) = f(f(x)) = \frac{1}{\left(\frac{1}{x^2}\right)^2} = x^4$
 $g'(x) = 4x^3$
- 11 a** $y = \frac{1}{(2x - 1)^2} = (2x - 1)^{-2}$
 $\frac{dy}{dx} = -2(2)(2x - 1)^{-3} = -\frac{4}{(2x - 1)^3}$
- b** When $x = 1$, $\frac{dy}{dx} = -\frac{4}{(2 - 1)^3} = -4$.
 When $x = 1$, $y = \frac{1}{(2 - 1)^3} = 1$.

The equation of the tangent with $m_T = -4$ that passes through the point $(x_1, y_1) \equiv (1, 1)$ is given by

$$\begin{aligned} y - y_1 &= m_T(x - x_1) \\ y - 1 &= -4(x - 1) \\ y - 1 &= -4x + 4 \\ y &= -4x + 5 \end{aligned}$$

12 $f(x) = (x - 1)^3$ and $g(x) = e^x$

a $f(g(x)) = f(e^x) = (e^x - 1)^3$

b $h(x) = (e^x - 1)^3$ and $h'(x) = 3e^x(e^x - 1)^2$

c At $(0, 0)$, $h'(0) = 3e^0(e^0 - 1)^2 = 0$.

The equation of the tangent is $y = 0$.

13 $f(x) = \sin^2(2x) = (\sin(2x))^2$

$$f'(x) = 4 \cos(2x) \sin(2x), \quad 0 \leq x \leq \pi$$

$$0 = 4 \cos(2x) \sin(2x), \quad 0 \leq 2x \leq 2\pi$$

$\cos(2x) = 0$ or $\sin(2x) = 0$

$$2x = \frac{\pi}{2}, \frac{3\pi}{2} \quad 2x = 0, \pi, 2\pi$$

$$x = \frac{\pi}{4}, 3\pi/4 \quad x = 0, \frac{\pi}{2}, \pi$$

$$f(0) = \sin^2(2(0)) = 0$$

$$f\left(\frac{\pi}{4}\right) = \sin^2\left(2\left(\frac{\pi}{4}\right)\right) = 1$$

$$f\left(\frac{\pi}{2}\right) = \sin^2\left(2\left(\frac{\pi}{2}\right)\right) = 0$$

$$f\left(\frac{3\pi}{4}\right) = \sin^2\left(2\left(\frac{3\pi}{4}\right)\right) = 1$$

$$f(\pi) = \sin^2(2(\pi)) = 0$$

Therefore, the coordinates are

$$(0, 0), \left(\frac{\pi}{4}, 1\right), \left(\frac{\pi}{2}, 0\right), \left(\frac{3\pi}{4}, 1\right), (\pi, 0).$$

14 $z = 4y^2 - 5$ and $y = \sin(3x)$

$$z = 4(\sin(3x))^2 - 5$$

$$\frac{dz}{dx} = 4(2)(3 \cos(3x))(\sin(3x)) = 24 \cos(3x) \sin(3x)$$

15 $f(x) = 2 \sin(x)$ and $h(x) = e^x$

a i $m(x) = f(h(x)) = f(e^x) = 2 \sin(e^x)$

ii $n(x) = h(f(x)) = h(2 \sin(x)) = e^{2 \sin(x)}$

b $m'(x) = 2e^x \cos(e^x)$ and $n'(x) = 2 \cos(x)e^{2 \sin(x)}$

Solve using CAS for $0 \leq x \leq 3$.

$$m'(x) = n'(x)$$

$$2e^x \cos(e^x) = 2 \cos(x)e^{2 \sin(x)}$$

$$e^x \cos(e^x) = \cos(x)e^{2 \sin(x)}$$

$$x = 1.555, 2.105, 2.372$$

16 a $m(n(x)) = m(x^2 + 4x - 5) = 3^{x^2 + 4x - 5}$

b $\frac{d}{dx} (3^{x^2 + 4x - 5}) = 1.0986(2x + 4)3^{x^2 + 4x - 5}$
 $= 2.1972(x + 2)3^{x^2 + 4x - 5}$

When $x = 1$,

$$\begin{aligned} \frac{d}{dx} (3^{x^2 + 4x - 5}) 6.5916 &= 2.1972(1 + 2)3^{(1)^2 + 4(1) - 5} \\ &= 2.1972 \times 3 \times 3^0 = 6.5916 \end{aligned}$$

17 a $g(x) = f(h(x)) = f(2x - 1) = \sqrt[3]{2x - 1}$

b $g(x) = (2x - 1)^{\frac{2}{3}}$ so $g'(x) = \frac{2}{3}(2)(2x - 1)^{-\frac{1}{3}} = \frac{4}{3\sqrt[3]{2x - 1}}$

c m_T at $x = 1$: $g'(1) = \frac{4}{3\sqrt[3]{2(1) - 1}} = \frac{4}{3}$

The equation of the tangent with $m_T = \frac{4}{3}$ that passes through $(x_1, y_1) = (1, 1)$ is given by

$$\begin{aligned} y - y_1 &= m_T(x - x_1) \\ y - 1 &= \frac{4}{3}(x - 1) \\ y &= \frac{4}{3}x - \frac{4}{3} + 1 \\ y &= \frac{4}{3}x - \frac{1}{3} \end{aligned}$$

$$m_T \text{ at } x = 0: g'(0) = \frac{4}{3\sqrt[3]{2(0) - 1}} = -\frac{4}{3}$$

The equation of the tangent with $m_T = -\frac{4}{3}$ that passes through $(x_1, y_1) = (0, 1)$ is given by

$$\begin{aligned} y - y_1 &= m_T(x - x_1) \\ y - 1 &= -\frac{4}{3}(x - 0) \\ y &= -\frac{4}{3}x + 1 \end{aligned}$$

d The tangents intersect where

$$y = \frac{4}{3}x - \frac{1}{3} \quad [1]$$

$$y = -\frac{4}{3}x + 1 \quad [2]$$

$$[1] = [2]$$

$$\frac{4}{3}x - \frac{1}{3} = -\frac{4}{3}x + 1$$

$$\frac{8}{3}x = 1 + \frac{1}{3}$$

$$\frac{8}{3}x = \frac{4}{3}$$

$$x = \frac{4}{3} \times \frac{3}{8} = \frac{1}{2}$$

$$\text{When } x = \frac{1}{2}, y = \frac{4}{3} \left(\frac{1}{2}\right) - \frac{1}{3} = \frac{2}{3} - \frac{1}{3} = \frac{1}{3}.$$

The tangents intersect at $\left(\frac{1}{2}, \frac{1}{3}\right)$

18 a $(2 \log_e(x))^2 = 2 \log_e(x)$

$$(2 \log_e(x))^2 - 2 \log_e(x) = 0$$

$$2 \log_e(x) (2 \log_e(x) - 1) = 0$$

$$\log_e(x) = 0 \text{ or } 2 \log_e(x) - 1 = 0$$

$$e^0 = x \quad 2 \log_e(x) = 1$$

$$x = 1 \quad \log_e(x) = 0.5$$

$$x = e^{0.5}$$

$$\text{When } x = 1, y = 2 \log_e(1) = 0.$$

$$\text{When } x = e^{0.5}, y = 2 \log_e(e)^{0.5} = 1.$$

The points of intersection are $(1, 0)$ and $(e^{0.5}, 1)$.

b If $y = (2 \log_e(x))^2$,

$$\frac{dy}{dx} = 2 \left(\frac{2}{x}\right) (2 \log_e(x)) = \frac{8 \log_e(x)}{x}$$

$$\text{At } (1, 0), \frac{dy}{dx} = \frac{8 \log_e(1)}{1} = 0.$$

$$\text{If } y = 2 \log_e(x),$$

$$\frac{dy}{dx} = \frac{2}{x}$$

$$\text{At } (1, 0), \frac{dy}{dx} = \frac{2}{1} = 2.$$

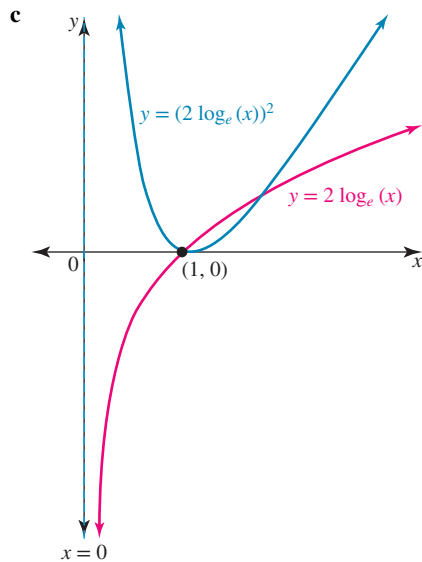

- d $2 \log_e(x) > (2 \log_e(x))^2$ when $\{x : 1 < x < e^{0.5}\}$.
- 19 a $h(x) = \sqrt{x^2 - 16}$ and $g(x) = x - 3$
 $h(g(x)) = \sqrt{(x-3)^2 - 16}$
 $h(g(x)) = \sqrt{x^2 - 6x + 9 - 16}$
 $h(g(x)) = \sqrt{x^2 - 6x - 7}$
 $h(g(x)) = \sqrt{(x-7)(x+1)}$
 If $h(g(x)) = \sqrt{(x+m)(x+n)}$, then $m = -7$ and $n = 1$.
- b Maximum domain for $(x-7)(x+1) \geq 0$
-
- $\{x : x \leq -1\} \cup \{x : x \geq 7\}$
- c $\frac{d}{dx}(h(g(x))) = \frac{d}{dx}(\sqrt{x^2 - 6x - 7})$
 $\frac{d}{dx}(h(g(x))) = \frac{d}{dx}(x^2 - 6x - 7)^{\frac{1}{2}}$
 $\frac{d}{dx}(h(g(x))) = \frac{1}{2}(2x - 6)(x^2 - 6x - 7)^{-\frac{1}{2}}$
 $\frac{d}{dx}(h(g(x))) = \frac{x - 3}{\sqrt{x^2 - 6x - 7}}$

d When $x = -2$, gradient $= \frac{-2 - 3}{\sqrt{(-2)^2 - 6(-2) - 7}}$
 $= \frac{-5}{\sqrt{4 + 12 - 7}}$
 $= -\frac{5}{3}$

- 20 $y = g(f(x)) = g\left(\frac{1}{x}\right) = \frac{1}{x} - \frac{1}{\left(\frac{1}{x}\right)^2} = \frac{1}{x} - x^2$
 $\frac{dy}{dx} = -x^{-2} - 2x = -\frac{1}{x^2} - 2x$
 The perpendicular equation is given by
 $y = -x + a$, so $m_P = -1$ and $m_T = 1$.
 $\frac{dy}{dx} = 1$
 $-\frac{1}{x^2} - 2x = 1$
 $-1 - 2x^3 = x^2$
 $0 = 2x^3 + x^2 + 1$

Let $P(x) = 2x^3 + x^2 + 1$.

$$P(-1) = 2(-1)^3 + (-1)^2 + 1 = 0$$

$(x + 1)$ is a factor.

$$2x^3 + x^2 + 1 = (x + 1)(2x^2 - x + 1)$$

The quadratic can't be factorised.

$$x + 1 = 0$$

$$x = -1$$

$$\text{If } x = -1, y = \frac{1}{-1} - (-1)^2 = -2 \text{ and } -2 = 1 + a \Rightarrow a = -3.$$

6.2 Exam questions

1 $f(x) = e^{g(x^2)}$

$$f'(x) = \frac{d}{dx}(g(x^2)) e^{g(x^2)}$$

$$f'(x) = 2xg'(x^2) e^{g(x^2)}$$

The correct answer is C.

2 $y = (5x + 1)^7$

Apply the chain rule.

$$\frac{dy}{dx} = 7 \times 5(5x + 1)^6$$

$$= 35(5x + 1)^6 \quad [1 \text{ mark}]$$

3 $y = f(x) = \sqrt{x^2 + 3}$

$$y = \sqrt{u} = u^{\frac{1}{2}} \text{ where } u = x^2 + 3 \text{ (chain rule)}$$

$$\frac{dy}{du} = \frac{1}{2}u^{-\frac{1}{2}} = \frac{1}{2\sqrt{u}} \quad \frac{du}{dx} = 2x$$

$$\frac{dy}{dx} = \frac{dy}{du} \frac{du}{dx}$$

$$f'(x) = \frac{dy}{dx} = \frac{x}{\sqrt{x^2 + 3}}$$

$$f'(1) = \frac{1}{\sqrt{1 + 3}} = \frac{1}{2}$$

Award 1 mark for using the chain rule.

Award 1 mark for the correct derivative.

Award 1 mark for the correct final answer.

VCAA Examination Report note:

Many students only gave the expression for $f'(x)$, not the specific value of $f'(1)$. Students should also note that

$$\frac{1}{\sqrt{4}} \neq \pm \frac{1}{2}, \quad \frac{1}{\sqrt{4}} = \frac{1}{2}.$$

6.3 The product rule

6.3 Exercise

1 a $f(x) = \sin(3x) \cos(3x)$

$$f'(x) = -3 \sin(3x) \sin(3x) + 3 \cos(3x) \cos(3x)$$

$$f'(x) = 3 \cos^2(3x) - 3 \sin^2(3x)$$

b $f(x) = x^2 e^{3x}$

$$f'(x) = 3x^2 e^{3x} + 2x e^{3x}$$

c $f(x) = (x^2 + 3x - 5)e^{5x}$

$$f'(x) = 5(x^2 + 3x - 5)e^{5x} + (2x + 3)e^{5x}$$

$$f'(x) = (5x^2 + 17x - 22)e^{5x}$$

$$\begin{aligned} \text{d } f(x) &= \sqrt{x^2 - 1} \tan(3x) \\ &= (x^2 - 1)^{\frac{1}{2}} \tan(3x) \end{aligned}$$

$$\begin{aligned} f'(x) &= (x^2 - 1)^{\frac{1}{2}} \times 3 \sec^2(3x) + \tan(3x) \times \frac{1}{2}(x^2 - 1)^{-\frac{1}{2}} \times 2x \\ &= 3\sqrt{x^2 - 1} \sec^2(3x) + \frac{x \tan(3x)}{\sqrt{x^2 - 1}} \end{aligned}$$

$$2 \text{ a } y = x^2 e^{5x}$$

$$\text{Let } u = x^2 \text{ and } v = e^{5x}, \text{ so } \frac{du}{dx} = 2x \text{ and } \frac{dv}{dx} = 5e^{5x}.$$

$$\frac{dy}{dx} = u \frac{dv}{dx} + v \frac{du}{dx}$$

$$\frac{dy}{dx} = 5x^2 e^{5x} + 2xe^{5x}$$

$$\text{b } y = e^{2x+1} \tan(2x)$$

$$\text{Let } u = e^{2x+1} \text{ and } v = \tan(2x), \text{ so}$$

$$\frac{du}{dx} = 2e^{2x+1} \text{ and } \frac{dv}{dx} = \frac{2}{\cos^2(2x)}.$$

$$\frac{dy}{dx} = u \frac{dv}{dx} + v \frac{du}{dx}$$

$$\frac{dy}{dx} = \frac{2e^{2x+1}}{\cos^2(2x)} + 2e^{2x+1} \tan(2x)$$

$$\frac{dy}{dx} = \frac{2e^{2x+1}}{\cos^2(2x)} + \frac{2e^{2x+1} \sin(2x)}{\cos(2x)}$$

$$\frac{dy}{dx} = \frac{2e^{2x+1} + 2e^{2x+1} \sin(2x) \cos(2x)}{\cos^2(2x)}$$

$$\frac{dy}{dx} = \frac{2e^{2x+1} (1 + \sin(2x) \cos(2x))}{\cos^2(2x)}$$

$$\frac{dy}{dx} = 2e^{2x+1} \sec^2(2x) + 2e^{2x+1} \tan(2x)$$

$$\text{c } y = x^{-2}(2x + 1)^3$$

$$\text{Let } u = x^{-2} \text{ and } v = (2x + 1)^3$$

$$\text{so } \frac{du}{dx} = -2x^{-3} \text{ and } \frac{dv}{dx} = 3(2)(2x + 1)^2 = 6(2x + 1)^2.$$

$$\frac{dy}{dx} = u \frac{dv}{dx} + v \frac{du}{dx}$$

$$\frac{dy}{dx} = 6x^{-2}(2x + 1)^2 - 2x^{-3}(2x + 1)^3$$

$$\frac{dy}{dx} = \frac{6(2x + 1)^2}{x^2} - \frac{2(2x + 1)^3}{x^3}$$

$$\frac{dy}{dx} = \frac{6x(2x + 1)^2 - 2(2x + 1)^3}{x^3}$$

$$\frac{dy}{dx} = \frac{2(2x + 1)^2 (3x - (2x + 1))}{x^3}$$

$$\frac{dy}{dx} = \frac{2(2x + 1)^2 (x - 1)}{x^3}$$

$$\text{d } y = x \cos(x)$$

$$\text{Let } u = x \text{ and } v = \cos(x), \text{ so } \frac{du}{dx} = 1 \text{ and } \frac{dv}{dx} = -\sin(x).$$

$$\frac{dy}{dx} = u \frac{dv}{dx} + v \frac{du}{dx}$$

$$\frac{dy}{dx} = -x \sin(x) + \cos(x)$$

$$\text{e } y = 2\sqrt{x}(4 - x) = 2x^{\frac{1}{2}}(4 - x)$$

$$\text{Let } u = 2x^{\frac{1}{2}} \text{ and } v = 4 - x, \text{ so } \frac{du}{dx} = x \text{ and } \frac{dv}{dx} = -1.$$

$$\frac{dy}{dx} = u \frac{dv}{dx} + v \frac{du}{dx}$$

$$\frac{dy}{dx} = 2\sqrt{x}(-1) + \frac{4 - x}{\sqrt{x}}$$

$$\frac{dy}{dx} = \frac{-2x + 4 - x}{\sqrt{x}}$$

$$\frac{dy}{dx} = \frac{4 - 3x}{\sqrt{x}}$$

$$\text{f } y = \sin(2x - \pi) e^{-3x}$$

$$\text{Let } u = \sin(2x - \pi) \text{ and } v = e^{-3x},$$

$$\text{so } \frac{du}{dx} = 2 \cos(2x - \pi) \text{ and } \frac{dv}{dx} = -3e^{-3x}.$$

$$\frac{dy}{dx} = u \frac{dv}{dx} + v \frac{du}{dx}$$

$$\frac{dy}{dx} = -3e^{-3x} \sin(2x - \pi) + 2e^{-3x} \cos(2x - \pi)$$

$$3 \text{ a } y = 3x^{-2} e^{x^2}$$

$$\text{Let } u = 3x^{-2} \text{ and } v = e^{x^2}, \text{ so } \frac{du}{dx} = -6x^{-3} \text{ and } \frac{dv}{dx} = 2xe^{x^2}.$$

$$\frac{dy}{dx} = u \frac{dv}{dx} + v \frac{du}{dx}$$

$$\frac{dy}{dx} = 3x^{-2} \times 2xe^{x^2} + e^{x^2} \times -6x^{-3}$$

$$\frac{dy}{dx} = \frac{6e^{x^2}}{x} - \frac{6e^{x^2}}{x^3}$$

$$\frac{dy}{dx} = \frac{6e^{x^2} (x^2 - 1)}{x^3}$$

$$\text{b } y = e^{2x} \sqrt{4x^2 - 1} = e^{2x} (4x^2 - 1)^{\frac{1}{2}}$$

$$\text{Let } u = e^{2x} \text{ and } v = (4x^2 - 1)^{\frac{1}{2}}, \text{ so}$$

$$\frac{du}{dx} = 2e^{2x} \text{ and } \frac{dv}{dx} = 4x(4x^2 - 1)^{-\frac{1}{2}} = \frac{4x}{\sqrt{4x^2 - 1}}.$$

$$\frac{dy}{dx} = u \frac{dv}{dx} + v \frac{du}{dx}$$

$$\frac{dy}{dx} = \frac{4xe^{2x}}{\sqrt{4x^2 - 1}} + 2e^{2x} \sqrt{4x^2 - 1}$$

$$\frac{dy}{dx} = \frac{4xe^{2x} + 2e^{2x} (4x^2 - 1)}{\sqrt{4x^2 - 1}}$$

$$\frac{dy}{dx} = \frac{2e^{2x} (4x^2 + 2x - 1)}{\sqrt{4x^2 - 1}}$$

$$\text{c } y = x^2 \sin^3(2x) = x^2 (\sin(2x))^3$$

$$\text{Let } u = x^2 \text{ and } v = (\sin(2x))^3, \text{ so}$$

$$\frac{du}{dx} = 2x \text{ and } \frac{dv}{dx} = 6 \cos(2x) \sin^2(2x).$$

$$\frac{dy}{dx} = u \frac{dv}{dx} + v \frac{du}{dx}$$

$$\frac{dy}{dx} = 6x^2 \cos(2x) \sin^2(2x) + 2x \sin^3(2x)$$

$$\frac{dy}{dx} = 2x \sin^2(2x) (3x \cos(2x) + \sin(2x))$$

$$\mathbf{d} \quad y = (x-1)^4 (3-x)^{-2}$$

Let $u = (x-1)^4$ and $v = (3-x)^{-2}$, so

$$\frac{du}{dx} = 4(x-1)^3 \text{ and } \frac{dv}{dx} = -2(3-x)^{-3} \times -1 = \frac{2}{(3-x)^3}.$$

$$\begin{aligned} \frac{dy}{dx} &= u \frac{dv}{dx} + v \frac{du}{dx} \\ &= \frac{2(x-1)^4}{(3-x)^3} + \frac{4(x-1)^3}{(3-x)^2} \\ &= \frac{2(x-1)^4 + (3-x)4(x-1)^3}{(3-x)^3} \\ &= \frac{2(x-1)^3(x-1+2(3-x))}{(3-x)^3} \\ &= \frac{2(x-1)^3(5-x)}{(3-x)^3} \\ &= \frac{2(x-1)^3(x-5)}{(x-3)^3} \end{aligned}$$

$$\mathbf{e} \quad y = (3x-2)^2 g(x)$$

Let $u = (3x-2)^2$ and $v = g(x)$, so

$$\frac{du}{dx} = 6(3x-2) \text{ and } \frac{dv}{dx} = g'(x).$$

$$\frac{dy}{dx} = u \frac{dv}{dx} + v \frac{du}{dx}$$

$$\frac{dy}{dx} = (3x-2)^2 g'(x) + 6(3x-2)g(x)$$

$$\frac{dy}{dx} = (3x-2)((3x-2)g'(x) + 6g(x))$$

$$\mathbf{f} \quad y = -e^{5x} g(\sqrt{x})$$

Let $u = -e^{5x}$ and $v = g(\sqrt{x})$, so

$$\frac{du}{dx} = -5e^{5x} \text{ and } \frac{dv}{dx} = \frac{g'(x)}{2\sqrt{x}}.$$

$$\frac{dy}{dx} = u \frac{dv}{dx} + v \frac{du}{dx}$$

$$\frac{dy}{dx} = -\frac{e^{5x}g'(x)}{2\sqrt{x}} - 5e^{5x}g(\sqrt{x})$$

$$\frac{dy}{dx} = -\frac{e^{5x}(g'(\sqrt{x}) + 10\sqrt{x}g(\sqrt{x}))}{2\sqrt{x}}$$

$$\mathbf{4} \quad \mathbf{a} \quad y = (x^2 - 3x + 7) \log_e(2x - 1)$$

$$\frac{dy}{dx} = (x^2 - 3x + 7) \times \frac{2}{(2x-1)} + (2x-3) \log_e(2x-1)$$

$$\frac{dy}{dx} = (2x-3) \log_e(2x-1) + \frac{2(x^2 - 3x + 7)}{(2x-1)}, \quad x \in \left(\frac{1}{2}, \infty\right)$$

$$\mathbf{b} \quad y = \sin(x) \log_e(x^2)$$

$$\frac{dy}{dx} = \sin(x) \times \frac{2x}{x^2} + \cos(x) \log_e(x^2)$$

$$\frac{dy}{dx} = \frac{2 \sin(x)}{x} + \cos(x) \log_e(x^2)$$

$$\frac{dy}{dx} = \frac{x \cos(x) \log_e(x^2) + 2 \sin(x)}{x}, \quad x \in (0, \infty)$$

$$\mathbf{5} \quad f(x) = 2x^4 \cos(2x)$$

$$f'(x) = -4x^4 \sin(2x) + 8x^3 \cos(2x)$$

$$f'\left(\frac{\pi}{2}\right) = 8\left(\frac{\pi}{2}\right)^3 \cos\left(2 \times \frac{\pi}{2}\right) - 4\left(\frac{\pi}{2}\right)^4 \sin\left(2 \times \frac{\pi}{2}\right)$$

$$= \frac{8\pi^3}{8}(-1)$$

$$= -\pi^3$$

$$\mathbf{6} \quad \mathbf{a} \quad f(x) = xe^x$$

$$f'(x) = xe^x + e^x$$

$$f'(-1) = -e^{-1} + e^{-1}$$

$$= 0$$

$$\mathbf{b} \quad f(x) = x(x^2 + x)^4$$

$$f'(x) = 4x(2x+1)(x^2+x)^3 + (x^2+x)^4$$

$$= (x^2+x)^3(x^2+x+8x^2+4x)$$

$$= (x^2+x)^3(9x^2+5x)$$

$$f'(1) = (1^2+1)^3(9(1)^2+5(1))$$

$$= 112$$

$$\mathbf{c} \quad f(x) = (1-x) \tan^2(x)$$

$$f'(x) = \frac{2(1-x)\tan(x)}{\cos^2(x)} - \tan^2(x)$$

$$f'\left(\frac{\pi}{3}\right) = \frac{2 \times \left(1 - \frac{\pi}{3}\right) \tan\left(\frac{\pi}{3}\right)}{\left(\frac{1}{2}\right)^2} - \left[\tan\left(\frac{\pi}{3}\right)\right]^2$$

$$= \frac{2 \times \left(1 - \frac{\pi}{3}\right) \times \sqrt{3}}{\frac{1}{4}} - (\sqrt{3})^2$$

$$= 8\sqrt{3}\left(1 - \frac{\pi}{3}\right) - 3$$

$$\mathbf{d} \quad f(x) = \sqrt{x} \sin(2x^2) = x^{\frac{1}{2}} \sin(2x^2)$$

$$f'(x) = 4x^{\frac{3}{2}} \cos(2x^2) + \frac{\sin(2x^2)}{2\sqrt{x}}$$

$$f'(x) = \frac{8x^2 \cos(2x^2) + \sin(2x^2)}{2\sqrt{x}}$$

$$f'(\sqrt{\pi}) = \frac{8(\sqrt{\pi})^2 \cos(2(\sqrt{\pi})^2) + \sin(2(\sqrt{\pi})^2)}{2\sqrt{(\sqrt{\pi})}}$$

$$= \frac{8\pi \cos(2\pi) + \sin(2\pi)}{2\sqrt{\sqrt{\pi}}}$$

$$= \frac{8\pi(1) + (0)}{2\sqrt{\sqrt{\pi}}}$$

$$= \frac{8\pi}{2\sqrt{\sqrt{\pi}}}$$

$$= \frac{8\pi}{\pi^{\frac{1}{4}}}$$

$$= 8\pi^{\frac{3}{4}}$$

$$\mathbf{7} \quad \mathbf{a} \quad f(x) = (x+1) \sin(x)$$

$$f'(x) = (x+1) \cos(x) + \sin(x) \times 1$$

$$f'(0) = \sin(0) + \cos(0)$$

$$= 0 + 1$$

$$= 1$$

$$\mathbf{b} \quad y = 2x \tan(2x)$$

$$\text{Let } u = 2x \text{ and } v = \tan(2x), \text{ so } \frac{du}{dx} = 2 \text{ and } \frac{dv}{dx} = \frac{2}{\cos^2(2x)}.$$

$$\frac{dy}{dx} = u \frac{dv}{dx} + v \frac{du}{dx}$$

$$\frac{dy}{dx} = \frac{4x}{\cos^2(2x)} + 2 \tan(2x)$$

When $x = \frac{\pi}{12}$,

$$\frac{dy}{dx} = \frac{4\left(\frac{\pi}{12}\right)}{\cos^2\left(\frac{\pi}{6}\right)} + 2 \tan\left(\frac{\pi}{6}\right)$$

$$\frac{dy}{dx} = \frac{\pi}{3} \times \frac{1}{\cos^2\left(\frac{\pi}{6}\right)} + 2 \times \frac{1}{\sqrt{3}}$$

$$\frac{dy}{dx} = \frac{\pi}{3} \times \frac{1}{\left(\frac{\sqrt{3}}{2}\right)^2} + \frac{2}{\sqrt{3}}$$

$$\frac{dy}{dx} = \frac{\pi}{3} \times \frac{4}{3} + \frac{2\sqrt{3}}{3}$$

$$\frac{dy}{dx} = \frac{4\pi}{9} + \frac{2\sqrt{3}}{3} = \frac{4\pi + 6\sqrt{3}}{9}$$

8 $y = 2^x \sin(x)$

$$\frac{dy}{dx} = 2^x \cos(x) + \log_e(2) \times 2^x \sin(x)$$

When $x = \frac{\pi}{2}$,

$$\frac{dy}{dx} = 2^{\frac{\pi}{2}} \cos\left(\frac{\pi}{2}\right) + \log_e(2) \times 2^{\frac{\pi}{2}} \sin\left(\frac{\pi}{2}\right) \approx 2.06$$

9 $y = f(x) = x^4 e^{-3x}$

Let $u = x^4$ and $v = e^{-3x}$, so $\frac{du}{dx} = 4x^3$ and $\frac{dv}{dx} = -3e^{-3x}$.

$$\frac{dy}{dx} = u \frac{dv}{dx} + v \frac{du}{dx}$$

$$\frac{dy}{dx} = -3x^4 e^{-3x} + 4x^3 e^{-3x}$$

$$\frac{dy}{dx} = e^{-3x} (-3x^4 + 4x^3) = e^{-3x} (4x^3 - 3x^4)$$

If $\frac{dy}{dx} = e^{-3x} (ax^3 + bx^4)$, then $a = 4$ and $b = -3$.

Therefore, the correct answer is C.

10 Let $y = f(x) = 2x^2(1-x)^3$.

$$\begin{aligned} f'(x) &= 2x^2 \times -3(1-x)^2 + (1-x)^3 \times 4x \\ &= -6x^2(1-x)^2 + 4x(1-x)^3 \\ &= -2x(1-x)^2(3x-2(1-x)) \\ &= -2x(1-x)^2(5x-2) \end{aligned}$$

If $f'(x) = 0$,

$$-2x(1-x)^2(5x-2) = 0$$

$$x = 0 \text{ or } 1-x = 0 \text{ or } 5x-2 = 0$$

$$x = 0, 1, \frac{2}{5}$$

$$f'(0) = 2(0)^2(1-0)^3 = 0$$

$$f'(1) = 2(1)^2(1-1)^3 = 0$$

$$f'\left(\frac{2}{5}\right) = 2\left(\frac{2}{5}\right)^2\left(1-\frac{2}{5}\right)^3$$

$$= 2 \times \frac{4}{25} \times \frac{27}{125}$$

$$= \frac{216}{3125}$$

Therefore, the coordinates are $(0, 0)$, $(1, 0)$, $\left(\frac{2}{5}, \frac{216}{3125}\right)$.

11 a $f(x) = e^{-\frac{x}{2}} \sin(x)$

$$f(x) = 0 \text{ for } x \in [0, 3\pi]$$

$$e^{-\frac{x}{2}} \sin(x) = 0$$

$\sin(x) = 0$ since $e^{-\frac{x}{2}} > 0$ for all x

$$x = 0, \pi, 2\pi, 3\pi$$

b Max/min values occur when $f'(x) = 0$.

$$f'(x) = e^{-\frac{x}{2}} \cos(x) - \frac{1}{2} e^{-\frac{x}{2}} \sin(x)$$

$$0 = e^{-\frac{x}{2}} \left(\cos(x) - \frac{1}{2} \sin(x) \right)$$

$$-\frac{1}{2} \sin(x) + \cos(x) = 0 \text{ since } e^{-\frac{x}{2}} > 0 \text{ for all } x$$

$$\cos(x) = \frac{1}{2} \sin(x)$$

$$1 = \frac{1}{2} \tan(x)$$

$$2 = \tan(x)$$

$$x = 1.11, 4.25, 7.39$$

12 a $y = -\cos(x) \tan(x)$

$$y = -\cos(x) \times \frac{\sin(x)}{\cos(x)}$$

$$y = -\sin(x), \cos(x) \neq 0$$

$$\frac{dy}{dx} = -\cos(x)$$

b $y = -\cos(x) \tan(x)$

Let $u = -\cos(x)$ and $v = \tan(x)$, so

$$\frac{du}{dx} = \sin(x) \text{ and } \frac{dv}{dx} = \sec^2(x) = \frac{1}{\cos^2(x)}$$

$$\frac{dy}{dx} = u \frac{dv}{dx} + v \frac{du}{dx}$$

$$\frac{dy}{dx} = -\cos(x) \times \frac{1}{\cos^2(x)} + \tan(x) \sin(x)$$

$$\frac{dy}{dx} = -\frac{1}{\cos(x)} + \frac{\sin(x)}{\cos(x)} \times \sin(x) \text{ prov } \cos(x) \neq 0$$

$$\frac{dy}{dx} = \frac{\sin^2(x) - 1}{\cos(x)}$$

$$\frac{dy}{dx} = \frac{1 - \cos^2(x) - 1}{\cos(x)}$$

$$\frac{dy}{dx} = -\frac{\cos(x) \cos(x)}{\cos(x)}$$

$$\frac{dy}{dx} = -\cos(x), \cos(x) \neq 0$$

13 a $y = f(x) = (x-a)^2 g(x)$

Let $u = (x-a)^2$ and $v = g(x)$, so

$$\frac{du}{dx} = 2(x-a) \text{ and } \frac{dv}{dx} = g'(x)$$

$$\frac{dy}{dx} = u \frac{dv}{dx} + v \frac{du}{dx}$$

$$\frac{dy}{dx} = (x-a)^2 g'(x) + 2(x-a)g(x)$$

b $f(x) = g(x) \sin(2x)$ where $g(x) = ax^2$

Let $u = ax^2$ and $v = \sin(2x)$,

$$\text{so } \frac{du}{dx} = 2ax \text{ and } \frac{dv}{dx} = 2 \cos(2x)$$

$$\frac{dy}{dx} = u \frac{dv}{dx} + v \frac{du}{dx}$$

$$\frac{dy}{dx} = 2ax^2 \cos(2x) + 2ax \sin(2x)$$

$$\begin{aligned}\frac{dy}{dx} \Big|_{x=\frac{\pi}{2}} &= 2a \left(\frac{\pi}{2}\right)^2 \cos(\pi) + 2a \left(\frac{\pi}{2}\right) \sin(\pi) = -3\pi \\ &-\frac{\pi^2}{2}a + 0 = -3\pi \\ \pi^2 a &= 6\pi \\ a &= \frac{6}{\pi}\end{aligned}$$

14 $y = (x^2 + 1)e^{3x}$

$$m_T = \frac{dy}{dx} = 3(x^2 + 1)e^{3x} + 2xe^{3x}$$

When $x = 0$, $m_T = 3(0 + 1)e^{3(0)} + 2(0)e^{3(0)} = 3$.

When $x = 0$, $y = (0 + 1)e^{3(0)} = 1$.

The equation of the tangent with $m_T = 3$ that passes through $(x_1, y_1) = (0, 1)$ is given by

$$y - y_1 = m_T(x - x_1)$$

$$y - 1 = 3(x - 0)$$

$$y = 3x + 1$$

15 $y = xe^x$

Let $u = x$ and $v = e^x$, so $\frac{du}{dx} = 1$ and $\frac{dv}{dx} = e^x$.

$$\frac{dy}{dx} = u \frac{dv}{dx} + v \frac{du}{dx}$$

$$\frac{dy}{dx} = xe^x + e^x = e^x(x + 1)$$

When $x = 1$, $m_T = \frac{dy}{dx} = e^1(1 + 1) = 2e$ and $m_N = -\frac{1}{2e}$.

When $x = 1$, $y = (1)e^1 = e$.

The equation of the tangent with $m_T = 2e$ that passes through the point $(x_1, y_1) = (1, e)$ is given by

$$y - y_1 = m_T(x - x_1)$$

$$y - e = 2e(x - 1)$$

$$y - e = 2ex - 2e$$

$$y = 2ex - e$$

The equation of the perpendicular with $m_P = -\frac{1}{2e}$ that passes through the point $(x_1, y_1) = (1, e)$ is given by

$$y - y_1 = m_P(x - x_1)$$

$$y - e = -\frac{1}{2e}(x - 1)$$

$$y - e = -\frac{1}{2e}x + \frac{1}{2e}$$

$$y = -\frac{1}{2e}x + \frac{1}{2e} + e$$

$$y = -\frac{1}{2e}x + \left(\frac{1 + 2e^2}{2e}\right)$$

16 a $y = e^{-x^2}(1 - x)$

The graph cuts the y -axis where $x = 0$, $y = e^0(1 - 0) = 1$.

The graph cuts the x -axis where $y = 0$.

$$e^{-x^2}(1 - x) = 0$$

$$1 - x = 0 \text{ as } e^{-x^2} > 0 \text{ for all } x$$

$$x = 1$$

Therefore, the coordinates are $(0, 1)$ and $(1, 0)$.

b $\frac{dy}{dx} = -e^{-x^2} - 2xe^{-x^2}(1 - x)$

$$= -e^{-x^2}(1 + 2x(1 - x))$$

$$= -e^{-x^2}(1 + 2x - 2x^2)$$

$$\frac{dy}{dx} = e^{x^2}(2x^2 - 2x - 1)$$

$$0 = e^{x^2}(2x^2 - 2x - 1)$$

$$0 = 2x^2 - 2x - 1 \text{ as } e^{x^2} > 0 \text{ for all } x$$

$$x = \frac{2 \pm \sqrt{(-2)^2 - 4(2)(-1)}}{2(2)}$$

$$= \frac{2 \pm \sqrt{12}}{4}$$

$$x = -0.366, 1.366$$

When $x = -0.366$, $y = e^{-(-0.366^2)}(1 + 0.366) = 1.1947$.

When $x = 1.366$, $y = e^{-(1.366^2)}(1 - 1.366) = -0.057$.

Therefore, the coordinates are $(-0.366, 1.195)$ and $(1.366, -0.057)$.

c When $x = 1$, $m_T = e^{-(1)^2}(2(1)^2 - 2(1) - 1) = -\frac{1}{e}$.

The equation of the tangent with $m_T = -\frac{1}{e}$ that passes through $(x_1, y_1) \equiv (1, 0)$ is given by

$$y - y_1 = m_T(x - x_1)$$

$$y - 0 = -\frac{1}{e}(x - 1)$$

$$y = -\frac{1}{e}x + \frac{1}{e}$$

d When $x = 0$, $m_T = e^{-0^2}(2(0)^2 - 2(0) - 1) = -1$, so $m_P = 1$.

The equation of the perpendicular with $m_P = 1$ that passes through $(x_1, y_1) \equiv (0, 1)$ is given by

$$y - y_1 = m_P(x - x_1)$$

$$y - 1 = x$$

$$y = x + 1$$

e The tangent and perpendicular intersect where

$$x + 1 = -\frac{1}{e}x + \frac{1}{e}$$

$$x = -0.462$$

$$\therefore y = -0.462 + 1$$

$$= 0.538$$

$$\text{POI} = (-0.46, 0.54)$$

17 a When $x = -2$, $y = (4(-2)^2 - 5(-2))e^{-2} = 26e^{-2} \approx 3.5187$, so they have made the correct decision.

b The graph cuts the x -axis where $y = 0$.

$$(4x^2 - 5x)e^x = 0$$

$$x(4x - 5) = 0 \text{ as } e^x > 0 \text{ for all } x$$

$$x = 0 \text{ or } 4x - 5 = 0$$

$$4x = 5$$

$$x = \frac{5}{4}$$

T is the point $\left(\frac{5}{4}, 0\right)$.

c $y = (4x^2 - 5x)e^x$

Let $u = 4x^2 - 5x$ and $v = e^x$, so $\frac{du}{dx} = 8x - 5$ and $\frac{dv}{dx} = e^x$.

$$\frac{dy}{dx} = u \frac{dv}{dx} + v \frac{du}{dx}$$

$$\frac{dy}{dx} = (4x^2 - 5x)e^x + (8x - 5)e^x$$

$$\frac{dy}{dx} = (4x^2 - 5x + 8x - 5)e^x$$

$$\frac{dy}{dx} = (4x^2 + 3x - 5)e^x$$

Stationary points occur when $\frac{dy}{dx} = 0$.

$$(4x^2 + 3x - 5)e^x = 0$$

$$4x^2 + 3x - 5 = 0 \text{ as } e^x > 0 \text{ for all } x$$

$$x = \frac{-3 \pm \sqrt{(3)^2 - 4(4)(-5)}}{2(4)}$$

$$x = \frac{-3 \pm \sqrt{9 + 80}}{8}$$

$$x = \frac{-3 \pm \sqrt{89}}{8}$$

Point B: When $x = \frac{-3 + \sqrt{89}}{8} \approx 0.804$,

$$y = (4(0.804)^2 - 5(0.804))e^{0.804} \approx -3.205.$$

B has the coordinates (0.804, -3.205).

18 a $y = f(x) = 3x^3 e^{-2x}$

Let $u = 3x^3$ and $v = e^{-2x}$, so $\frac{du}{dx} = 9x^2$ and $\frac{dv}{dx} = -2e^{-2x}$.

$$\frac{dy}{dx} = u \frac{dv}{dx} + v \frac{du}{dx}$$

$$\frac{dy}{dx} = -6x^3 e^{-2x} + 9x^2 e^{-2x}$$

$$\frac{dy}{dx} = 3e^{-2x}(3x^2 - 2x^3)$$

If $\frac{dy}{dx} = ae^{-2x}(bx^2 + cx^3)$, then $a = 3$, $b = 3$ and $c = -2$.

b Stationary points occur where $\frac{dy}{dx} = 0$.

$$3e^{-2x}(3x^2 - 2x^3) = 0$$

$$x^2(3 - 2x) = 0 \text{ as } e^{-2x} > 0 \text{ for all } x$$

$$x = 0 \text{ or } 3 - 2x = 0$$

$$3 = 2x$$

$$\frac{3}{2} = x$$

If $x = 0$, $y = 0$.

$$\text{If } x = \frac{3}{2}, y = 3 \left(\frac{3}{2} \right)^3 e^{-2(\frac{3}{2})} = \frac{81}{8} e^{-3} = \frac{81}{8e^3}.$$

The stationary point (0, 0) is a point of inflection and the

stationary point $\left(\frac{3}{2}, \frac{81}{8e^3} \right)$ is a maximum turning point.

c When $x = 1$, $y = 3(1)^3 e^{-2(1)} = 3e^{-2} = \frac{3}{e^2}$.

When $x = 1$,

$$m_T = \frac{dy}{dx} = 3e^{-2(1)}(3(1)^2 - 2(1)^3) = 3e^{-2} = \frac{3}{e^2}.$$

The equation of the tangent with $m_T = \frac{3}{e^2}$ that passes

through the point $(x_1, y_1) = \left(1, \frac{3}{e^2} \right)$ is given by

$$y - y_1 = m_T(x - x_1)$$

$$y - \frac{3}{e^2} = \frac{3}{e^2}(x - 1)$$

$$y - \frac{3}{e^2} = \frac{3}{e^2}x - \frac{3}{e^2}$$

$$y = \frac{3}{e^2}x$$

19 a i $\frac{CD}{3} = \sin(\theta)$

$$CD = 3 \sin(\theta)$$

ii $\frac{AD}{3} = \frac{BD}{3} = \cos(\theta)$

$$AD = BD = 3 \cos(\theta)$$

b $S = 4 \times \frac{1}{2} \times 6 \cos(\theta) \times 3 \sin(\theta) + (6 \cos(\theta))^2$

$$S = 36 \cos(\theta) \sin(\theta) + 36 \cos^2(\theta)$$

$$S = 36 (\cos^2(\theta) + \cos(\theta) \sin(\theta)) \text{ as required}$$

c Let $S_1 = 36 \cos^2(\theta) = 36 (\cos(\theta))^2$.

$$\text{So } \frac{dS_1}{d\theta} = 2 \times 36 \times -\sin(\theta) \cos(\theta) = -72 \sin(\theta) \cos(\theta)$$

$$\text{Let } S_2 = 36 \cos(\theta) \sin(\theta).$$

Let $u = 36 \cos(\theta)$ and $v = \sin(\theta)$, so

$$\frac{du}{d\theta} = -36 \sin(\theta) \text{ and } \frac{dv}{d\theta} = \cos(\theta).$$

$$\frac{dS_2}{d\theta} = u \frac{dv}{d\theta} + v \frac{du}{d\theta}$$

$$\frac{dS_2}{d\theta} = 36 \cos(\theta) \cos(\theta) - 36 \sin(\theta) \sin(\theta)$$

$$\frac{dS_2}{d\theta} = 36(\cos^2(\theta) - \sin^2(\theta))$$

$$S = S_1 + S_2$$

$$\frac{dS}{d\theta} = \frac{dS_1}{d\theta} + \frac{dS_2}{d\theta}$$

$$\frac{dS}{d\theta} = -72 \sin(\theta) \cos(\theta) + 36(\cos^2(\theta) - \sin^2(\theta))$$

$$\frac{dS}{d\theta} = -72 \sin(\theta) \cos(\theta) + 36 \cos^2(\theta) - 36 \sin^2(\theta)$$

$$\frac{dS}{d\theta} = -72 \sin(\theta) \cos(\theta) + 36 \cos^2(\theta) - 36(1 - \cos^2(\theta))$$

$$\frac{dS}{d\theta} = -72 \sin(\theta) \cos(\theta) + 36 \cos^2(\theta) - 36 + 36 \cos^2(\theta)$$

$$\frac{dS}{d\theta} = 72 \cos^2(\theta) - 72 \sin(\theta) \cos(\theta) - 36$$

6.3 Exam questions

1 $y = x^2 \sin(x)$ using the product rule.

$$\frac{dy}{dx} = x^2 \frac{d}{dx}(\sin(x)) + \sin(x) \frac{d}{dx}(x^2)$$

$$\frac{dy}{dx} = x^2 \cos(x) + 2x \sin(x)$$

$$= x(x \cos(x) + 2 \sin(x)) \quad [1 \text{ mark}]$$

2 $f(x) = x^2 e^{5x}$

Using the product rule:

$$u = x^2 \quad v = e^{5x}$$

$$\frac{du}{dx} = 2x \quad \frac{dv}{dx} = 5e^{5x}$$

$$f'(x) = 2xe^{5x} + 5x^2 e^{5x}$$

$$f'(1) = 2e^5 + 5e^5$$

$$= 7e^5$$

Award 1 mark for using the product rule.

Award 1 mark for the correct result.

VCAA Assessment Report note:

This question was well answered. Most students correctly identified the product rule but did not evaluate (as instructed) or their answers were incomplete. An incorrect combination of the product and chain rule resulted in an answer of $10xe^{5x}$ as a common error.

$$3 \quad y = x^2 \log_e(x)$$

$$u = x^2 \quad v = \log_e(x)$$

$$\frac{du}{dx} = 2x \quad \frac{dv}{dx} = \frac{1}{x}$$

$$\frac{dy}{dx} = u \frac{dv}{dx} + v \frac{du}{dx} \text{ (product rule)}$$

$$\frac{dy}{dx} = x^2 \times \frac{1}{x} + 2x \log_e(x)$$

$$\frac{dy}{dx} = x + 2x \log_e(x) = x(1 + 2 \log_e(x))$$

Award 1 mark for using the product rule.

Award 1 mark for the correct result.

VCAA Assessment Report note:

Some students did not simplify the expression or incorrectly combined the terms to obtain $3x \log_e(x)$.

$$\begin{aligned} &= \frac{-(x^2 + 2x + 1)}{(x^2 - 1)^2} \\ &= \frac{-(x + 1)^2}{(x^2 - 1)^2} \\ &= \frac{-(x + 1)^2}{(x + 1)^2(x - 1)^2} \\ &= -\frac{1}{(x - 1)^2} \end{aligned}$$

$$3 \quad a \quad y = \frac{\sin(x)}{\sqrt{x}}$$

$$\text{Let } u = \sin(x) \text{ and } v = \sqrt{x} = x^{\frac{1}{2}},$$

$$\text{so } \frac{du}{dx} = \cos(x) \text{ and } \frac{dv}{dx} = \frac{1}{2}x^{-\frac{1}{2}} = \frac{1}{2\sqrt{x}}.$$

$$\frac{dy}{dx} = \frac{v \frac{du}{dx} - u \frac{dv}{dx}}{v^2}$$

$$\frac{dy}{dx} = \left(\sqrt{x} \cos(x) - \frac{\sin(x)}{2\sqrt{x}} \right) \div (\sqrt{x})^2$$

$$\frac{dy}{dx} = \frac{2x \cos(x) - \sin(x)}{2\sqrt{x}} \times \frac{1}{x}$$

$$\frac{dy}{dx} = \frac{2x \cos(x) - \sin(x)}{2x\sqrt{x}}$$

$$b \quad y = \frac{\tan(2x)}{e^x}$$

$$\text{Let } u = \tan(2x) \text{ and } v = e^x, \text{ so}$$

$$\frac{du}{dx} = \frac{2}{\cos^2(2x)} \text{ and } \frac{dv}{dx} = e^x.$$

$$\frac{dy}{dx} = \frac{v \frac{du}{dx} - u \frac{dv}{dx}}{v^2}$$

$$\frac{dy}{dx} = \left(\frac{2e^x}{\cos^2(2x)} - e^x \tan(2x) \right) \div e^{2x}$$

$$\frac{dy}{dx} = \left(\frac{2e^x}{\cos^2(2x)} - \frac{e^x \sin(2x)}{\cos(2x)} \right) \times \frac{1}{e^{2x}}$$

$$\frac{dy}{dx} = \frac{e^x(2 - \sin(2x)\cos(2x))}{\cos^2(2x)} \times \frac{1}{e^{2x}}$$

$$\frac{dy}{dx} = \frac{2 - \sin(2x)\cos(2x)}{e^x \cos^2(2x)}$$

$$c \quad y = f(x) = \frac{(5-x)^2}{\sqrt{5-x}} = \frac{(5-x)^2}{(5-x)^{\frac{1}{2}}}$$

$$\text{Let } u = (5-x)^2 \text{ and } v = (5-x)^{\frac{1}{2}},$$

$$\text{so } \frac{du}{dx} = -2(5-x)$$

$$= 2x - 10 \text{ and}$$

$$\frac{dv}{dx} = -\frac{1}{2}(5-x)^{-\frac{1}{2}} = -\frac{1}{2\sqrt{5-x}}$$

$$\frac{dy}{dx} = \frac{v \frac{du}{dx} - u \frac{dv}{dx}}{v^2}$$

$$\frac{dy}{dx} = \left(\frac{-2(5-x)\sqrt{5-x}}{1} + \frac{(5-x)^2}{2\sqrt{5-x}} \right) \div (5-x)$$

6.4 The quotient rule

6.4 Exercise

$$1 \quad a \quad y = \frac{e^{2x}}{e^x + 1}$$

$$\text{Let } u = e^{2x} \text{ and } v = e^x + 1$$

$$\text{So } \frac{du}{dx} = 2e^{2x} \text{ and } \frac{dv}{dx} = e^x$$

$$\frac{dy}{dx} = \frac{v \frac{du}{dx} - u \frac{dv}{dx}}{v^2}$$

$$\frac{dy}{dx} = \frac{2e^{2x}(e^x + 1) - e^{2x} \times e^x}{(e^x + 1)^2}$$

$$\frac{dy}{dx} = \frac{2e^{3x} + 2e^{2x} - e^{3x}}{(e^x + 1)^2}$$

$$\frac{dy}{dx} = \frac{e^{3x} + 2e^{2x}}{(e^x + 1)^2}$$

$$b \quad y = \frac{\cos(3t)}{t^3}$$

$$\text{Let } u = \cos(3t) \text{ and } v = t^3,$$

$$\text{so } \frac{du}{dt} = -3 \sin(3t) \text{ and } \frac{dv}{dt} = 3t^2.$$

$$\frac{dy}{dt} = \frac{v \frac{du}{dt} - u \frac{dv}{dt}}{v^2}$$

$$\frac{dy}{dt} = \frac{-3t^3 \sin(3t) - 3t^2 \cos(3t)}{t^6}$$

$$\frac{dy}{dt} = \frac{-3t^2(t \sin(3t) + \cos(3t))}{t^6}$$

$$\frac{dy}{dt} = \frac{-3(t \sin(3t) + \cos(3t))}{t^4}, t \neq 0$$

$$2 \quad y = \frac{x+1}{x^2-1}$$

$$\text{Let } u = x+1 \text{ and } v = x^2-1,$$

$$\text{so } \frac{du}{dx} = 1 \text{ and } \frac{dv}{dx} = 2x.$$

$$\frac{dy}{dx} = \frac{v \frac{du}{dx} - u \frac{dv}{dx}}{v^2}$$

$$= \frac{(x^2-1) - 2x(x+1)}{(x^2-1)^2}$$

$$= \frac{x^2-1-2x^2-2x}{(x^2-1)^2}$$

$$\frac{dy}{dx} = \left(\frac{-4(5-x)^2 + (5-x)^2}{2\sqrt{5-x}} \right) \div (5-x)$$

$$\frac{dy}{dx} = \frac{(5-x)^2 - 4(5-x)^2}{2\sqrt{5-x}(5-x)}$$

$$\frac{dy}{dx} = \frac{5-x-20+4x}{2\sqrt{5-x}}$$

$$\frac{dy}{dx} = \frac{3x-15}{2\sqrt{5-x}}$$

$$\frac{dy}{dx} = -\frac{3(5-x)}{2\sqrt{5-x}}$$

$$\frac{dy}{dx} = -\frac{3\sqrt{5-x}}{2}$$

$$\mathbf{d} \quad y = \frac{\sin^2(x^2)}{x}$$

Let $u = (\sin(x^2))^2$ and $v = x$, so

$$\frac{du}{dx} = 4x \cos(x) \sin(x) \text{ and } \frac{dv}{dx} = 1.$$

$$\frac{dy}{dx} = \frac{v \frac{du}{dx} - u \frac{dv}{dx}}{v^2}$$

$$\frac{dy}{dx} = \frac{4x^2 \cos(x^2) \sin(x^2) - \sin^2(x^2)}{x^2}$$

$$\mathbf{e} \quad y = \frac{3x-1}{2x^2-3}$$

Let $u = 3x-1$ and $v = 2x^2-3$, so $\frac{du}{dx} = 3$ and $\frac{dv}{dx} = 4x$.

$$\frac{dy}{dx} = \frac{v \frac{du}{dx} - u \frac{dv}{dx}}{v^2}$$

$$\frac{dy}{dx} = \frac{3(2x^2-3) - 4x(3x-1)}{(2x^2-3)^2}$$

$$\frac{dy}{dx} = \frac{6x^2 - 9 - 12x^2 + 4x}{(2x^2-3)^2}$$

$$\frac{dy}{dx} = \frac{-6x^2 + 4x - 9}{(2x^2-3)^2}$$

$$\mathbf{f} \quad y = f(x) = \frac{x-4x^2}{2\sqrt{x}}$$

Let $u = x-4x^2$ and $v = 2x^{\frac{1}{2}}$, so $\frac{du}{dx} = 1-8x$ and $\frac{dv}{dx} = x^{-\frac{1}{2}} = \frac{1}{\sqrt{x}}$.

$$\frac{dy}{dx} = \frac{v \frac{du}{dx} - u \frac{dv}{dx}}{v^2}$$

$$\frac{dy}{dx} = \frac{2\sqrt{x}(1-8x) - \frac{x-4x^2}{\sqrt{x}}}{(2\sqrt{x})^2}$$

$$\frac{dy}{dx} = \frac{2x(1-8x) - (x-4x^2)}{4x\sqrt{x}}$$

$$\frac{dy}{dx} = \frac{2x - 16x^2 - x + 4x^2}{4x\sqrt{x}}$$

$$\frac{dy}{dx} = \frac{x - 12x^2}{4x\sqrt{x}}$$

$$\frac{dy}{dx} = \frac{1}{4\sqrt{x}} - 3\sqrt{x}$$

$$\mathbf{4} \quad \mathbf{a} \quad y = \frac{e^x}{\cos(2x+1)}$$

Let $u = e^x$ and $v = \cos(2x+1)$, so

$$\frac{du}{dx} = e^x \text{ and } \frac{dv}{dx} = -2 \sin(2x+1).$$

$$\frac{dy}{dx} = \frac{v \frac{du}{dx} - u \frac{dv}{dx}}{v^2}$$

$$\frac{dy}{dx} = \frac{e^x \cos(2x+1) + 2e^x \sin(2x+1)}{\cos^2(2x+1)}$$

$$\mathbf{b} \quad y = \frac{e^{-x}}{x-1}$$

Let $u = e^{-x}$ and $v = x-1$, so $\frac{du}{dx} = -e^{-x}$ and $\frac{dv}{dx} = 1$.

$$\frac{dy}{dx} = \frac{v \frac{du}{dx} - u \frac{dv}{dx}}{v^2}$$

$$\frac{dy}{dx} = \frac{-e^{-x}(x-1) - e^{-x}}{(x-1)^2}$$

$$\frac{dy}{dx} = \frac{-e^{-x}x + e^{-x} - e^{-x}}{(x-1)^2}$$

$$\frac{dy}{dx} = -\frac{xe^{-x}}{(x-1)^2}$$

$$\mathbf{c} \quad y = \frac{3\sqrt{x}}{x+2}$$

Let $u = 3x^{\frac{1}{2}}$ and $v = x+2$, so $\frac{du}{dx} = \frac{3}{2\sqrt{x}}$ and $\frac{dv}{dx} = 1$.

$$\frac{dy}{dx} = \frac{v \frac{du}{dx} - u \frac{dv}{dx}}{v^2}$$

$$\frac{dy}{dx} = \left(\frac{3(x+2)}{2\sqrt{x}} - 3\sqrt{x} \right) \div (x+2)^2$$

$$\frac{dy}{dx} = \frac{3(x+2) - 6x}{2\sqrt{x}(x+2)^2}$$

$$\frac{dy}{dx} = \frac{3x+6-6x}{2\sqrt{x}(x+2)^2}$$

$$\frac{dy}{dx} = \frac{6-3x}{2\sqrt{x}(x+2)^2}$$

$$\mathbf{d} \quad y = \frac{\cos(3x)}{\sin(3x)}$$

Let $u = \cos(3x)$ and $v = \sin(3x)$, so

$$\frac{du}{dx} = -3 \sin(3x) \text{ and } \frac{dv}{dx} = 3 \cos(3x).$$

$$\frac{dy}{dx} = \frac{v \frac{du}{dx} - u \frac{dv}{dx}}{v^2}$$

$$\frac{dy}{dx} = \frac{-3 \sin^2(3x) - 3 \cos^2(3x)}{\sin^2(3x)}$$

$$\frac{dy}{dx} = \frac{-3(\sin^2(3x) + \cos^2(3x))}{\sin^2(3x)}$$

$$\frac{dy}{dx} = -\frac{3}{\sin^2(3x)}$$

$$\mathbf{e} \quad y = \frac{x-2}{2x^2-x-6}$$

Let $u = x-2$ and $v = 2x^2-x-6$, so

$$\frac{du}{dx} = 1 \text{ and } \frac{dv}{dx} = 4x-1.$$

$$\frac{dy}{dx} = \frac{v \frac{du}{dx} - u \frac{dv}{dx}}{v^2}$$

$$\frac{dy}{dx} = \frac{2x^2 - x - 6 - (x-2)(4x-1)}{(2x^2 - x - 6)^2}$$

$$\frac{dy}{dx} = \frac{2x^2 - x - 6 - 4x^2 + 9x - 2}{(2x^2 - x - 6)^2}$$

$$\frac{dy}{dx} = \frac{-2x^2 + 8x - 8}{(2x^2 - x - 6)^2}$$

$$\frac{dy}{dx} = -\frac{2(x^2 - 4x + 4)}{(2x+3)^2(x-2)^2}$$

$$\frac{dy}{dx} = -\frac{2(x-2)^2}{(2x+3)^2(x-2)^2}$$

$$\frac{dy}{dx} = -\frac{2}{(2x+3)^2}, x \neq 2$$

$$\mathbf{f} \quad y = \frac{1 - e^{2x}}{1 + e^{2x}}$$

Let $u = 1 - e^{2x}$ and $v = 1 + e^{2x}$, so

$$\frac{du}{dx} = -2e^{2x} \text{ and } \frac{dv}{dx} = 2e^{2x}.$$

$$\frac{dy}{dx} = \frac{v \frac{du}{dx} - u \frac{dv}{dx}}{v^2}$$

$$\frac{dy}{dx} = \frac{-2e^{2x}(1 + e^{2x}) - 2e^{2x}(1 - e^{2x})}{(1 + e^{2x})^2}$$

$$\frac{dy}{dx} = \frac{-2e^{2x} - 2e^{4x} - 2e^{2x} + 2e^{4x}}{(1 + e^{2x})^2}$$

$$\frac{dy}{dx} = -\frac{4e^{2x}}{(1 + e^{2x})^2}$$

$$\mathbf{5} \quad \mathbf{a} \quad y = \frac{\log_e(x^2)}{(2x-1)}.$$

Let $u = \log_e(x^2)$, so $\frac{du}{dx} = \frac{2x}{x^2} = \frac{2}{x}$.

Let $v = 2x - 1$, so $\frac{dv}{dx} = 2$.

$$\frac{dy}{dx} = \frac{v \frac{du}{dx} - u \frac{dv}{dx}}{v^2}$$

$$\frac{dy}{dx} = \frac{(2x-1) \times \frac{2}{x} - 2 \log_e(x^2)}{(2x-1)^2}$$

$$\frac{dy}{dx} = \left(\frac{2(2x-1)}{x} - 2 \log_e(x^2) \right) \times \frac{1}{(2x-1)^2}$$

$$\frac{dy}{dx} = \frac{2(2x-1) - 2x \log_e(x^2)}{x(2x-1)^2}$$

$$\mathbf{b} \quad y = \frac{2 \log_e(2x)}{e^{2x} + 1}$$

Let $u = 2 \log_e(2x)$, so $\frac{du}{dx} = \frac{2}{x}$.

Let $v = e^{2x} + 1$, so $\frac{dv}{dx} = 2e^{2x}$.

$$\frac{dy}{dx} = \frac{v \frac{du}{dx} - u \frac{dv}{dx}}{v^2}$$

$$\frac{dy}{dx} = \frac{\frac{2}{x}(e^{2x} + 1) - 4e^{2x} \log_e(2x)}{(e^{2x} + 1)^2}$$

$$\frac{dy}{dx} = \frac{2(e^{2x} + 1) - 4xe^{2x} \log_e(2x)}{x(e^{2x} + 1)^2}$$

$$\frac{dy}{dx} = \frac{2e^{2x} + 2 - 4xe^{2x} \log_e(2x)}{x(e^{2x} + 1)^2}$$

$$\mathbf{6} \quad \mathbf{a} \quad y = f(x) = \frac{x+2}{\sin(g(x))}$$

Let $u = x + 2$ and $v = \sin(g(x))$, so

$$\frac{du}{dt} = 1 \text{ and } \frac{dv}{dt} = g'(x) \cos(g(x)).$$

$$\frac{dy}{dt} = \frac{v \frac{du}{dt} - u \frac{dv}{dt}}{v^2}$$

$$\frac{dy}{dt} = \frac{\sin(g(x)) - (x+2)g'(x)\cos(g(x))}{\sin^2(g(x))}$$

$$\mathbf{b} \quad y = f(x) = \frac{g(e^{-2x})}{e^x}$$

Let $u = g(e^{-2x})$ and $v = e^x$, so

$$\frac{du}{dx} = -2e^{-2x}g'(e^{-2x}) \text{ and } \frac{dv}{dx} = e^x.$$

$$\frac{dy}{dx} = \frac{v \frac{du}{dx} - u \frac{dv}{dx}}{v^2}$$

$$\begin{aligned} &= \frac{e^x \times -2e^{-2x}g'(e^{-2x}) - e^x g(e^{-2x})}{(e^x)^2} \\ &= \frac{-2e^{-2x}g'(e^{-2x}) - g(e^{-2x})}{e^x} \end{aligned}$$

$$\mathbf{7} \quad y = \frac{\sin(x)}{e^{2x}}$$

Let $u = \sin(x)$ and $v = e^{2x}$,

so $\frac{du}{dx} = \cos(x)$ and $\frac{dv}{dx} = 2e^{2x}$.

$$\frac{dy}{dx} = \frac{v \frac{du}{dx} - u \frac{dv}{dx}}{v^2}$$

$$\frac{dy}{dx} = \frac{e^{2x} \cos(x) - 2e^{2x} \sin(x)}{e^{4x}}$$

$$\frac{dy}{dx} = \frac{e^{2x}(\cos(x) - 2 \sin(x))}{e^{4x}}$$

$$\frac{dy}{dx} = \frac{\cos(x) - 2 \sin(x)}{e^{2x}}$$

When $x = 0$, $\frac{dy}{dx} = \frac{\cos(0) - 2 \sin(0)}{e^{2(0)}} = 1$.

$$\mathbf{8} \quad \mathbf{a} \quad y = \frac{2x}{x^2 + 1}$$

Let $u = 2x$ and $v = x^2 + 1$, so $\frac{du}{dx} = 2$ and $\frac{dv}{dx} = 2x$.

$$\frac{dy}{dx} = \frac{v \frac{du}{dx} - u \frac{dv}{dx}}{v^2}$$

$$\frac{dy}{dx} = \frac{2(x^2 + 1) - 2x(2x)}{(x^2 + 1)^2}$$

$$\frac{dy}{dx} = \frac{2x^2 + 2 - 4x^2}{(x^2 + 1)^2}$$

$$\frac{dy}{dx} = \frac{2 - 2x^2}{(x^2 + 1)^2} = \frac{2(1 - x^2)}{(x^2 + 1)^2}$$

When $x = 1$, $\frac{dy}{dx} = \frac{2(1 - 1^2)}{(1^2 + 1)^2} = 0$.

$$\mathbf{b} \quad y = \frac{\sin(2x + \pi)}{\cos(2x + \pi)}$$

Let $u = \sin(2x + \pi)$ and $v = \cos(2x + \pi)$, so

$$\frac{du}{dx} = 2 \cos(2x + \pi) \text{ and } \frac{dv}{dx} = -2 \sin(2x + \pi).$$

$$\frac{dy}{dx} = \frac{v \frac{du}{dx} - u \frac{dv}{dx}}{v^2}$$

$$\frac{dy}{dx} = \frac{2 \cos^2(2x + \pi) + 2 \sin^2(2x + \pi)}{\cos^2(2x + \pi)}$$

$$\frac{dy}{dx} = \frac{2(\cos^2(2x + \pi) + \sin^2(2x + \pi))}{\cos^2(2x + \pi)}$$

$$\frac{dy}{dx} = \frac{2}{\cos^2(2x + \pi)}$$

$$\text{When } x = \frac{\pi}{2}, \frac{dy}{dx} = \frac{2}{\cos^2(2\pi)} = \frac{2}{1^2} = 2.$$

$$\text{c } y = \frac{x+1}{\sqrt{3x+1}}$$

Let $u = x + 1$ and $v = (3x + 1)^{\frac{1}{2}}$, so

$$\frac{du}{dx} = 1 \text{ and } \frac{dv}{dx} = \frac{3}{2\sqrt{3x+1}}$$

$$\frac{dy}{dx} = \frac{v \frac{du}{dx} - u \frac{dv}{dx}}{v^2}$$

$$\frac{dy}{dx} = \frac{\sqrt{3x+1} - \frac{3(x+1)}{2\sqrt{3x+1}}}{(\sqrt{3x+1})^2}$$

$$\frac{dy}{dx} = \frac{2(3x+1) - 3(x+1)}{2\sqrt{3x+1}(3x+1)}$$

$$\frac{dy}{dx} = \frac{6x+2-3x-3}{2\sqrt{3x+1}(3x+1)}$$

$$\frac{dy}{dx} = \frac{3x-1}{2\sqrt{3x+1}(3x+1)}$$

$$\begin{aligned} \text{When } x = 5, \frac{dy}{dx} &= \frac{3(5) - 1}{2\sqrt{3(5)+1}(3(5)+1)} \\ &= \frac{14}{2(4)(16)} \\ &= \frac{7}{64} \end{aligned}$$

$$\text{d } y = \frac{5-x^2}{e^x}$$

Let $u = 5 - x^2$ and $v = e^x$, so $\frac{du}{dx} = -2x$ and $\frac{dv}{dx} = e^x$.

$$\frac{dy}{dx} = \frac{v \frac{du}{dx} - u \frac{dv}{dx}}{v^2}$$

$$\frac{dy}{dx} = \frac{-2xe^x - e^x(5-x^2)}{(e^x)^2}$$

$$\frac{dy}{dx} = \frac{-2xe^x - 5e^x + 5e^x x^2}{e^{2x}}$$

$$\frac{dy}{dx} = \frac{5x^2 - 2x - 5}{e^x}$$

$$\text{When } x = 0, \frac{dy}{dx} = -\frac{5}{e^0} = -5.$$

$$\text{9 a } y = \frac{2x}{(3x+1)^{\frac{3}{2}}}$$

Let $u = 2x$ and $v = (3x + 1)^{\frac{3}{2}}$, so

$$\frac{du}{dx} = 2 \text{ and } \frac{dv}{dx} = \frac{9}{2}\sqrt{3x+1}.$$

$$\frac{dy}{dx} = \frac{v \frac{du}{dx} - u \frac{dv}{dx}}{v^2}$$

$$\frac{dy}{dx} = \frac{2(3x+1)^{\frac{3}{2}} - 9x(3x+1)^{\frac{1}{2}}}{\left((3x+1)^{\frac{3}{2}}\right)^2}$$

$$\frac{dy}{dx} = \frac{2(3x+1)^{\frac{3}{2}} - 9x(3x+1)^{\frac{1}{2}}}{(3x+1)^3}$$

$$\text{When } x = 1, \frac{dy}{dx} = \frac{2(4)^{\frac{3}{2}} - 9(1)(4)^{\frac{1}{2}}}{(4)^3} = -\frac{1}{32}.$$

$$\text{b } y = \frac{e^x}{x^2 + 2}$$

Let $u = e^x$ and $v = x^2 + 2$, so $\frac{du}{dx} = e^x$ and $\frac{dv}{dx} = 2x$.

$$\frac{dy}{dx} = \frac{v \frac{du}{dx} - u \frac{dv}{dx}}{v^2}$$

$$\frac{dy}{dx} = \frac{e^x(x^2 + 2) - 2xe^x}{(x^2 + 2)^2}$$

$$\frac{dy}{dx} = \frac{e^x x^2 + 2e^x - 2xe^x}{(x^2 + 2)^2}$$

$$\frac{dy}{dx} = \frac{e^x(x^2 - 2x + 2)}{(x^2 + 2)^2}$$

$$\text{When } x = 0, m_T = \frac{dy}{dx} = \frac{e^0(0^2 - 2(0) + 2)}{(0^2 + 2)^2} = \frac{2}{4} = \frac{1}{2}.$$

$$\text{When } x = 0, y = \frac{e^0}{0^2 + 2} = \frac{1}{2}.$$

The equation of the tangent with $m_T = \frac{1}{2}$ that passes

through $(x_1, y_1) = \left(0, \frac{1}{2}\right)$ is given by

$$y - y_1 = m_T(x - x_1)$$

$$y - \frac{1}{2} = \frac{1}{2}(x - 0)$$

$$y = \frac{1}{2}x + \frac{1}{2}$$

$$\text{10 a } y = \frac{2x-1}{3x^2+1}$$

$$\frac{dy}{dx} = \frac{-6x^2 + 6x + 2}{(3x^2 + 1)^2}$$

$$\text{b } \frac{-6x^2 + 6x + 2}{(3x^2 + 1)^2} = 0.875$$

$$x = -0.1466 \text{ or } 0.5746$$

$$\text{11 a } y = f(x) = \frac{\sin(2x-3)}{e^x}$$

Stationary points occur where $\frac{dy}{dx} = 0$.

$$\frac{dy}{dx} = \frac{2 \cos(2x-3) - \sin(2x-3)}{e^x}$$

$$0 = \frac{2 \cos(2x-3) - \sin(2x-3)}{e^x}$$

$$0 = 2 \cos(2x-3) - \sin(2x-3)$$

$$x = 0.25(6.2832n + 8.2143) \text{ where } n \in \mathbb{Z}$$

For the given domain, let $n = -2, -1$.

$$x = -1.088, 0.483$$

$$\text{When } x = -1.088, y = \frac{\sin(2(-1.088) - 3)}{e^{-1.088}} = 2.655.$$

$$\text{When } x = 0.483, y = \frac{\sin(2(0.483) - 3)}{e^{0.483}} = -0.552.$$

Thus, $a = -1.088$, $b = 2.655$, $c = 0.483$ and $d = -0.552$.

$$\text{b } \frac{dy}{dx}_{x=1} = \frac{2 \cos(2-3) - \sin(2-3)}{e^1} = 0.707$$

$$12 \quad \frac{d}{dx} \left(\frac{1 + \cos(x)}{1 - \cos(x)} \right)$$

If $y = \frac{1 + \cos(x)}{1 - \cos(x)}$, let $u = 1 + \cos(x)$ and $v = 1 - \cos(x)$.

$$\frac{du}{dx} = -\sin(x) \text{ and } \frac{dv}{dx} = \sin(x)$$

$$\frac{dy}{dx} = \frac{v \frac{du}{dx} - u \frac{dv}{dx}}{v^2}$$

$$\frac{dy}{dx} = \frac{(1 - \cos(x)) \times -\sin(x) - (1 + \cos(x)) \times \sin(x)}{(1 - \cos(x))^2}$$

$$= \frac{-\sin(x)(1 - \cos(x) + 1 + \cos(x))}{(1 - \cos(x))^2}$$

$$= \frac{-2 \sin(x)}{(-(\cos(x) - 1))^2}$$

$$= -\frac{2 \sin(x)}{(\cos(x) - 1)^2}$$

$$13 \quad y = f(x) = \frac{\sqrt{2x-1}}{\sqrt{2x+1}}$$

Let $u = \sqrt{2x-1}$ and $v = \sqrt{2x+1}$, so

$$\frac{du}{dx} = \frac{1}{\sqrt{2x-1}} \text{ and } \frac{dv}{dx} = \frac{1}{\sqrt{2x+1}}.$$

$$\frac{dy}{dx} = \frac{v \frac{du}{dx} - u \frac{dv}{dx}}{v^2}$$

$$\frac{dy}{dx} = \left(\frac{\sqrt{2x+1}}{\sqrt{2x-1}} - \frac{\sqrt{2x-1}}{\sqrt{2x+1}} \right) \div (\sqrt{2x+1})^2$$

$$\frac{dy}{dx} = \frac{(2x+1) - (2x-1)}{\sqrt{2x-1}\sqrt{2x+1}(2x+1)}$$

$$\frac{dy}{dx} = \frac{2x+1-2x+1}{\sqrt{4x^2-1}(2x+1)}$$

$$\frac{dy}{dx} = \frac{2}{\sqrt{4x^2-1}(2x+1)}$$

If $f'(m) = \frac{2}{5\sqrt{15}}$, then

$$\frac{dy}{dx}_{x=m} = \frac{2}{\sqrt{4m^2-1}(2m+1)} = \frac{2}{5\sqrt{15}}$$

Then $2m+1 = 5$ or $4m^2-1 = 15$.

$$2m = 4 \quad 4m^2 = 16$$

$$m = 2 \quad m^2 = 4$$

$$m = \pm 2$$

$$\therefore m = 2$$

The correct answer is **B**.

$$14 \quad y = \frac{e^{-3x}}{e^{2x} + 1}$$

Let $u = e^{-3x}$ and $v = e^{2x} + 1$, so $\frac{du}{dx} = -3e^{-3x}$ and $\frac{dv}{dx} = 2e^{2x}$.

$$\frac{dy}{dx} = \frac{v \frac{du}{dx} - u \frac{dv}{dx}}{v^2}$$

$$\frac{dy}{dx} = \frac{-3e^{-3x}(e^{2x} + 1) - 2e^{2x}(e^{-3x})}{(e^{2x} + 1)^2}$$

$$\frac{dy}{dx} = \frac{-3e^{-x} - 3e^{-3x} - 2e^{-x}}{(e^{2x} + 1)^2}$$

$$\frac{dy}{dx} = \frac{-5e^{-x} - 3e^{-3x}}{(e^{2x} + 1)^2}$$

$$\frac{dy}{dx} = \frac{e^{-x}(-5 - 3e^{-2x})}{(e^{2x} + 1)^2}$$

If $\frac{dy}{dx} = \frac{e^{-x}(a + be^{-2x})}{(e^{2x} + 1)^2}$, then $a = -5$ and $b = -3$.

$$15 \quad y = f(x) = \frac{10x}{x^2 + 1}$$

Let $u = 10x$ and $v = x^2 + 1$, so $\frac{du}{dx} = 10$ and $\frac{dv}{dx} = 2x$.

$$\frac{dy}{dx} = \frac{v \frac{du}{dx} - u \frac{dv}{dx}}{v^2}$$

$$\frac{dy}{dx} = \frac{10(x^2 + 1) - 20x^2}{(x^2 + 1)^2}$$

$$\frac{dy}{dx} = \frac{10 - 10x^2}{(x^2 + 1)^2}$$

$$\frac{dy}{dx} < 0$$

$$\frac{10 - 10x^2}{(x^2 + 1)^2} < 0$$

$$10 - 10x^2 < 0$$

$$1 - x^2 < 0$$

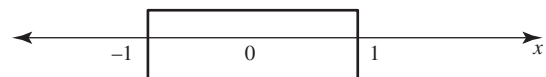

Thus, $\{x : x < -1\} \cup \{x : x > 1\}$ gives a negative gradient.

$$16 \quad \text{a } y = \frac{x-5}{x^2-5x-14}$$

Functions undefined when

$$x^2 + 5x - 14 = 0$$

$$(x+7)(x-2) = 0$$

$$x+7 = 0 \text{ or } x-2 = 0$$

$$x = -7 \quad x = 2$$

$$\text{b } y = \frac{x-5}{x^2+5x-14}$$

Let $u = x-5$ and $v = x^2+5x-14$, so

$$\frac{du}{dx} = 1 \text{ and } \frac{dv}{dx} = 2x+5.$$

$$\frac{dy}{dx} = \frac{v \frac{du}{dx} - u \frac{dv}{dx}}{v^2}$$

$$\frac{dy}{dx} = \frac{x^2+5x-14 - (x-5)(2x+5)}{(x^2+5x-14)^2}$$

$$\frac{dy}{dx} = \frac{x^2+5x-14 - (2x^2-5x-25)}{(x^2+5x-14)^2}$$

$$\frac{dy}{dx} = \frac{x^2+5x-14-2x^2+5x+25}{(x^2+5x-14)^2}$$

$$\frac{dy}{dx} = \frac{-x^2+10x+11}{(x^2+5x-14)^2}$$

When $\frac{dy}{dx} = 0$,

$$\frac{-x^2 + 10x + 11}{(x^2 + 5x - 14)^2} = 0$$

$$-x^2 + 10x + 11 = 0$$

$$11 + 10x - x^2 = 0$$

$$(11 - x)(1 + x) = 0$$

$$11 - x = 0 \text{ or } 1 + x = 0$$

$$x = 11 \quad x = -1$$

When $x = -1$, $y = \frac{-1 - 5}{(-1)^2 + 5(-1) - 14} = \frac{-6}{-18} = \frac{1}{3}$.

When $x = 11$, $y = \frac{11 - 5}{(11)^2 + 5(11) - 14} = \frac{6}{121 + 55 - 14} = \frac{6}{162} = \frac{1}{27}$

Therefore, the coordinates are $\left(-1, \frac{1}{3}\right)$, $\left(11, \frac{1}{27}\right)$.

c When $x = 1$, $y = \frac{1 - 5}{(1)^2 + 5(1) - 14} = \frac{-4}{-8} = \frac{1}{2}$ so

$$(x_1, y_1) \equiv \left(1, \frac{1}{2}\right)$$

When $x = 1$, $m_T = \frac{dy}{dx} = \frac{-(1)^2 + 10(1) + 11}{((1)^2 + 5(1) - 14)^2} = \frac{20}{64} = \frac{5}{16}$.

The equation of the tangent is

$$y - y_1 = m_T(x - x_1)$$

$$y - \frac{1}{2} = \frac{5}{16}(x - 1)$$

$$y - \frac{1}{2} = \frac{5}{16}x - \frac{5}{16}$$

$$y = \frac{5}{16}x - \frac{5}{16} + \frac{8}{16}$$

$$y = \frac{5}{16}x + \frac{3}{16}$$

2 $f: (-2, \infty) \rightarrow R$, $f(x) = \frac{x}{x+2}$ using the quotient rule.

Let $u = x$, $v = x + 2$.

$$u'(x) = 1 \quad v'(x) = 1$$

$$f'(x) = \frac{1(x+2) - x}{(x+2)^2}$$

$$f'(x) = \frac{2}{(x+2)^2}, \text{ for } x > -2$$

Award 1 mark for using the quotient rule.

Award 1 mark for the correct result.

VCAA Examination Report note:

This question was well handled. Students choosing to use the quotient rule tended to progress better than those using the product rule.

Some very poor algebraic slips were made. The most common was 'cancelling' $x + 2$ in the numerator with $x + 2$ in the denominator. Others unnecessarily expanded $(x + 2)^2$ and did so incorrectly.

3 $y = \frac{\cos(x)}{x^2 + 2}$

Using the quotient rule:

$$u = \cos(x) \quad v = x^2 + 2$$

$$\frac{du}{dx} = -\sin(x) \quad \frac{dv}{dx} = 2x$$

$$\frac{dy}{dx} = \frac{-(x^2 + 2)\sin(x) - 2x\cos(x)}{(x^2 + 2)^2}$$

Award 1 mark for using the quotient rule.

Award 1 mark for the correct result.

VCAA Assessment Report note:

Most students were able to confidently apply the quotient rule. However, many students did not obtain full marks due to errors caused by, for example, a denominator of $x^4 + 4$ as the supposed expansion of $(x^2 + 2)^2$. Students should very carefully consider the placement and usage of brackets. For example, the expression $x^2 + 2 \times -\sin(x^2)$ is not equivalent to $(x^2 + 2) \times -\sin(x)$.

6.4 Exam questions

1 $f(x) = \frac{e^x}{\cos(x)}$

Using the quotient rule:

$$f'(x) = \frac{e^x \cos(x) - e^x(-\sin(x))}{\cos^2(x)}$$

$$f'(x) = \frac{e^x(\cos(\pi) + \sin(\pi))}{\cos^2(\pi)}$$

$$f'(\pi) = \frac{e^\pi(\cos(\pi) + \sin(\pi))}{\cos^2(\pi)}$$

$$f'(\pi) = \frac{e^\pi(-1 + 0)}{(-1)^2}$$

$$f'(\pi) = -e^\pi$$

Award 1 mark for using the quotient rule.

Award 1 mark for the correct substitution and final answer.

VCAA Examination Report note:

Students competently applied the quotient rule; however, many were unable to carry out the required evaluation, often omitting it completely. Students who opted to use the product and chain rules tended to make little progress due to confusion with negative signs or negative exponents. Students should take care with legibility, for example, to distinguishing clearly the variable x and the constant π .

6.5 Curve sketching

6.5 Exercise

1 a $f(x) = \frac{2x^3}{3} + \frac{3x^2}{2} - 2x + 4$

Stationary points occur where $f'(x) = 0$.

$$f'(x) = 2x^2 + 3x - 2$$

$$0 = 2x^2 + 3x - 2$$

$$0 = (2x - 1)(x + 2)$$

Either $2x - 1 = 0$ or $x + 2 = 0$

$$x = \frac{1}{2}$$

$$x = -2$$

$$\begin{aligned} f\left(\frac{1}{2}\right) &= \frac{2}{3}\left(\frac{1}{2}\right)^3 + \frac{3}{2}\left(\frac{1}{2}\right)^2 - 2\left(\frac{1}{2}\right) + 4 \\ &= \frac{1}{12} + \frac{3}{8} + 3 \\ &= \frac{2}{24} + \frac{9}{24} + \frac{72}{24} \\ &= \frac{83}{24} \end{aligned}$$

$$\begin{aligned}
 f(-2) &= \frac{2}{3}(-2)^3 + \frac{3}{2}(-2)^2 - 2(-2) + 4 \\
 &= -\frac{16}{3} + 14 \\
 &= -\frac{16}{3} + \frac{42}{3} \\
 &= \frac{26}{3}
 \end{aligned}$$





When

$$x = -3, f'(-3) = 2(-3)^2 + 3(-3) - 2 = 18 - 9 - 2 = 7 \text{ (+ve)}$$

$$x = -1, f'(-1) = 2(-1)^2 + 3(-1) - 2 = 2 - 3 - 2 = -3 \text{ (-ve)}$$

$$x = 0, f'(0) = 2(0)^2 + 3(0) - 2 = 0 + 0 - 2 = -2 \text{ (-ve)}$$

$$x = 1, f'(1) = 2(1)^2 + 3(1) - 2 = 2 + 3 - 2 = 3 \text{ (+ve)}$$

$x < -2$	$x = -2$	$-1 < x < \frac{1}{2}$	$x = \frac{1}{2}$	$x > \frac{1}{2}$
				

Maximum TP at $\left(-2, \frac{26}{3}\right)$

Minimum TP at $\left(\frac{1}{2}, \frac{83}{24}\right)$

b $y = ax^2 + bx + c$

When $x = 0, y = -8$, so $c = -8$.

$$y = ax^2 + bx - 8$$

$$\frac{dy}{dx} = 2ax + b$$

When $x = -1, y = -5$; $-5 = a(-1)^2 + b(-1) - 8$
 $3 = a - b$ [1]

When $x = -1, \frac{dy}{dx} = 2a(-1) + b = 0$.

$$-2a + b = 0$$
 [2]

$$[1] + [2]$$

$$-a = 3$$

$$a = -3$$

Substitute $a = -3$ into [1], so $3 = -3 - b \Rightarrow b = -6$.

Therefore, $a = -3, b = -6, c = -8$.

2 a $y = x(x+2)^2$

Stationary points occur where $\frac{dy}{dx} = 0$.

$$\frac{dy}{dx} = (x+2)^2 + 2x(x+2)$$

$$0 = (x+2)(x+2+2x)$$

$$0 = (x+2)(3x+2)$$

$$x+2 = 0 \text{ or } 3x+2 = 0$$

$$x = -2 \quad x = -\frac{2}{3}$$

When $x = -2, y = (-2)(-2+2) = 0$.





When $x = -\frac{2}{3}, y = \left(-\frac{2}{3}\right)\left(-\frac{2}{3}+2\right)^2$

$$= -\frac{2}{3} \times \frac{16}{9} = -\frac{32}{27}$$

When $x = -3, \frac{dy}{dx} = (-3+2)(3(-3)+2) = 7$.

When $x = -1, \frac{dy}{dx} = (-1+2)(3(-1)+2) = -1$.

When $x = 0, \frac{dy}{dx} = (0+2)(3(0)+2) = 4$.

x	$x < -2$	$x = -2$	$-2 < x < -\frac{2}{3}$	$x = -\frac{2}{3}$	$x > -\frac{2}{3}$
$\frac{dy}{dx}$					

Maximum TP at $(-2, 0)$

Minimum TP at $\left(-\frac{2}{3}, -\frac{32}{27}\right)$

b $y = x^3 + 3x^2 - 24x + 5$

Stationary points occur where $\frac{dy}{dx} = 0$.

$$\frac{dy}{dx} = 3x^2 + 6x - 24$$

$$0 = 3x^2 + 6x - 24$$

$$0 = x^2 + 2x - 8$$

$$0 = (x+4)(x-2)$$

$$x+4 = 0 \text{ or } x-2 = 0$$

$$x = -4 \quad x = 2$$





When $x = -4, y = (-4)^3 + 3(-4)^2 - 24(-4) + 5 = 85$.

When $x = 2, y = (2)^3 + 3(2)^2 - 24(2) + 5 = -23$.

When $x = -5, \frac{dy}{dx} = 3(-5)^2 + 6(-5) - 24$
 $= 75 - 30 - 24 = +ve$

When $x = -1, \frac{dy}{dx} = 3(-1)^2 + 6(-1) - 24 = -ve$.

When $x = 3, \frac{dy}{dx} = 3(3)^2 + 6(3) - 24 = 27 + 18 - 24$
 $= +ve$

x	$x < -4$	$x = -4$	$-4 < x < 2$	$x = 2$	$x > 2$
$\frac{dy}{dx}$					

Maximum TP at $(-4, 85)$

Minimum TP at $(2, -23)$

c $y = \frac{x^2}{x+1}$

Stationary points occur where $\frac{dy}{dx} = 0$.

$$\frac{dy}{dx} = \frac{2x(x+1) - x^2}{(x+1)^2}$$

$$\frac{dy}{dx} = \frac{2x^2 + 2x - x^2}{(x+1)^2}$$

$$\frac{dy}{dx} = \frac{x^2 + 2x}{(x+1)^2}$$

$$0 = \frac{x^2 + 2x}{(x+1)^2}$$

$$0 = x(x+2)$$

$$x = 0 \text{ or } x + 2 = 0$$

$$x = -2$$

When $x = -2, y = \frac{(-2)^2}{-2+1} = -4$.

When $x = 0$, $y = \frac{(0)^2}{0+1} = 0$.

When $x = -3$, $\frac{dy}{dx} = \frac{(-3)^2 + 2(-3)}{(-3+1)^2} = \frac{3}{4}$.

When $x = -0.5$, $\frac{dy}{dx} = \frac{(-0.5)^2 + 2(-0.5)}{(-0.5+1)^2} = -3$.

When $x = 1$, $\frac{dy}{dx} = \frac{(1)^2 + 2(1)}{(1+1)^2} = \frac{3}{4}$.

x	$x < -2$	$x = -2$	$-2 < x < 0$	$x = 0$	$x > 0$
$\frac{dy}{dx}$					

Maximum TP at $(-2, -4)$

Minimum TP at $(0, 0)$

d $y = (x - 1)e^{-x}$

Stationary points occur where $\frac{dy}{dx} = 0$.

$$\frac{dy}{dx} = e^{-x} - (x - 1)e^{-x}$$

$$\frac{dy}{dx} = e^{-x} - xe^{-x} + e^{-x}$$

$$\frac{dy}{dx} = 2e^{-x} - xe^{-x}$$

$$0 = e^{-x}(2 - x)$$

$2 - x = 0$ as $e^{-x} > 0$ for all x

$$x = 2$$

$x = 2, y = (2 - 1)e^{-2} = e^{-2}$

When $x = 1$, $\frac{dy}{dx} = e^{-1}(2 - 1) = \frac{1}{e}$.

When $x = 3$, $\frac{dy}{dx} = e^{-3}(2 - 3) = -\frac{1}{e^3}$.

e

x	$x < 2$	$x = 2$	$x > 2$
$\frac{dy}{dx}$			

Maximum TP at $(2, e^{-2})$

3 $y = f(x) = 16x^2 - x^4$

a Stationary points occur where $\frac{dy}{dx} = 0$.

$$\frac{dy}{dx} = 32x - 4x^3$$

$$0 = 4x(8 - x^2)$$

$$0 = 4x(2\sqrt{2} - x)(2\sqrt{2} + x)$$

$x = 0$ or $2\sqrt{2} - x = 0$ or $2\sqrt{2} + x = 0$

$$x = 2\sqrt{2} \quad x = -2\sqrt{2}$$

When $x = \pm 2\sqrt{2}$, $y = 16(\pm 2\sqrt{2})^2 - (\pm 2\sqrt{2})^4$
 $= 128 - 64$
 $= 64$

Stationary points at $(\pm 2\sqrt{2}, 64)$, so $(2\sqrt{2}, 64)$ is a stationary point.

b When $x = -3$, $\frac{dy}{dx} = 32(-3) - 4(-3)^3 = 12$.

When $x = -1$, $\frac{dy}{dx} = 32(-1) - 4(-1)^3 = -28$.

When $x = 1$, $\frac{dy}{dx} = 32(1) - 4(1)^3 = 28$.

When $x = 3$, $\frac{dy}{dx} = 32(3) - 4(3)^3 = -12$.

See the table at the bottom of the page.*

Therefore, $(2\sqrt{2}, 64)$ is a maximum TP.

c The other stationary points are $(-2\sqrt{2}, 64)$, which is a maximum, and $(0, 0)$, which is a minimum.

4 a $y = x^3 + ax^2 + bx - 11$

Stationary point when $x = 1$ and $x = \frac{5}{3}$

$$\frac{dy}{dx} = 3x^2 + 2ax + b$$

$$\frac{dy}{dx_{x=1}} = 3(1)^2 + 2a(1) + b = 0$$

$$3 + 2a + b = 0$$

$$2 + b = -3 \quad [1]$$

$$\frac{dy}{dx_{x=\frac{5}{3}}} = 3\left(\frac{5}{3}\right)^2 + 2a\left(\frac{5}{3}\right) + b = 0$$

$$\frac{25}{3} + \frac{10}{3}a + b = 0$$

$$10a + 3b = -25 \quad [2]$$

$$[1] \times 3$$

$$6a + 3b = -9 \quad [3]$$

$$[2] - [3]$$

$$4a = -16$$

$$a = -4$$

Substitute $a = -4$ into [1]:

$$2(-4) + b = -3$$

$$-8 + b = -3$$

$$b = 5$$

b When $x = 1$, $y = (1)^3 - 4(1)^2 + 5(1) - 11 = -9$

When $x = \frac{5}{3}$, $y = \left(\frac{5}{3}\right)^3 - 4\left(\frac{5}{3}\right)^2 + 5\left(\frac{5}{3}\right) - 11$

$$= \frac{125}{27} - \frac{100}{9} + \frac{15}{3} - 11$$

$$= \frac{125}{27} - \frac{300}{27} + \frac{135}{27} - \frac{2700}{27}$$

$$= -\frac{247}{27}$$

When $x = 0$, $\frac{dy}{dx} = 3(0)^2 - 8(0) + 5 = +ve$.

When $x = 1.5$, $\frac{dy}{dx} = 3(1.5)^2 - 8(1.5) + 5 = -0.25$.

When $x = 2$, $\frac{dy}{dx} = 3(2)^2 - 8(2) + 5 = +1$.

$x < 1$	$x = 1$	$1 < x < \frac{5}{3}$	$x = \frac{5}{3}$	$x > \frac{5}{3}$

***3 b**

x	$x < -2\sqrt{2}$	$x = -2\sqrt{2}$	$-2\sqrt{2} < x < 0$	$x = 0$	$0 < x < 2$	$x = 2\sqrt{2}$	$x > 2\sqrt{2}$
$\frac{dy}{dx}$							

Maximum TP at (1, -9)

Minimum TP at $(\frac{5}{3}, -\frac{247}{27})$

5 a $y = f(x) = 2x^3 - x^2 = x^2(2x - 1)$

The graph cuts the y-axis where $x = 0, y = 0$.

The graph cuts the x-axis where $y = 0$.

$$x^2(2x - 1) = 0$$

$$x = 0 \text{ or } 2x - 1 = 0$$

$$x = \frac{1}{2}$$

$$\text{When } x = \frac{1}{2}, y = 2\left(\frac{1}{2}\right)^3 - \left(\frac{1}{2}\right)^2 = 0.$$

Stationary points occur where $\frac{dy}{dx} = 0$.

$$\frac{dy}{dx} = 6x^2 - 2x = 0$$

$$3x^2 - x = 0$$

$$x(3x - 1) = 0$$

$$x = 0 \text{ or } 3x - 1 = 0$$

$$x = \frac{1}{3}$$

$$\text{When } x = \frac{1}{3}, y = 2\left(\frac{1}{3}\right)^3 - \left(\frac{1}{3}\right)^2 = \frac{2}{27} - \frac{3}{27} = -\frac{1}{27}.$$

$$\text{When } x = -1, \frac{dy}{dx} = 6(-1)^2 - 2(-1) = 8.$$

$$\text{When } x = \frac{1}{4}, \frac{dy}{dx} = 6\left(\frac{1}{4}\right)^2 - 2\left(\frac{1}{4}\right) = \frac{3}{8} - \frac{4}{8} = -\frac{1}{8}.$$

$$\text{When } x = 1, \frac{dy}{dx} = 6(1)^2 - 2(1) = +ve.$$

$x < 0$	$x = 0$	$0 < x < \frac{1}{3}$	$x = \frac{1}{3}$	$x > \frac{1}{3}$

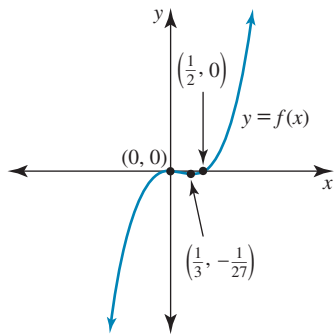

b Dom $x \in [0, \frac{1}{3}]$

6 a $y = f(x) = -\frac{1}{4}(x - 4)^3 + 2$

The graph cuts the y-axis where $x = 0, y = 14 + 2 = 16$.

The graph cuts the x-axis where $y = 0$.

$$(x - 4)^3 = 8$$

$$x - 4 = 2$$

$$x = 6$$

Stationary points occur where $\frac{dy}{dx} = 0$.

$$\frac{dy}{dx} = -\frac{3}{4}(x - 4)^2$$

$$0 = -\frac{3}{4}(x - 4)^2$$

$$x - 4 = 0$$

$$x = 4$$

$$\text{When } x = 4, y = -\frac{1}{4}(4 - 4)^3 + 2 = 2.$$

$$\text{When } x = 0, \frac{dy}{dx} = -\frac{3}{4}(0 - 4)^2 = -12.$$

$$\text{When } x = 5, \frac{dy}{dx} = -\frac{3}{4}(5 - 4)^2 = -\frac{3}{4}.$$

x	$x < 4$	$x = 4$	$x > 4$
$\frac{dy}{dx}$			

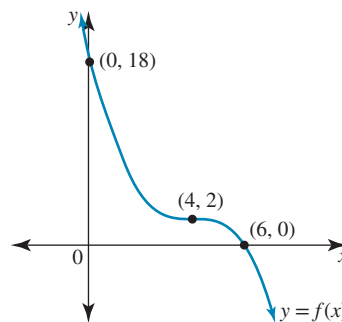

b $y = g(x) = 2x^3 - x^2, x \in [-1, 1]$

The graph cuts the y-axis where $x = 0, y = 0$.

The graph cuts the x-axis where $y = 0$.

$$x^2(2x - 1) = 0$$

$$x = 0 \text{ or } 2x - 1 = 0$$

$$x = 0 \quad x = \frac{1}{2}$$

Stationary points occur where $\frac{dy}{dx} = 0$.

$$\frac{dy}{dx} = 6x^2 - 2x = 2x(3x - 1)$$

$$0 = 2x(3x - 1)$$

$$x = 0 \text{ or } 3x - 1 = 0$$

$$x = \frac{1}{3}$$

$$\text{When } x = -1, \frac{dy}{dx} = 2(-1)(3(-1) - 1) = +8.$$

$$\text{When } x = 0.1, \frac{dy}{dx} = 2(0.1)(3(0.1) - 1) = -0.06.$$

$$\text{When } x = 1, \frac{dy}{dx} = 2(1)(3(1) - 1) = 4.$$

x	$x < 0$	$x = 0$	$0 < x < \frac{1}{3}$	$x = \frac{1}{3}$	$x > \frac{1}{3}$
$\frac{dy}{dx}$					

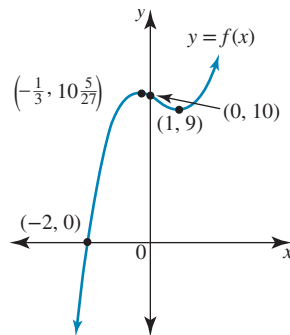
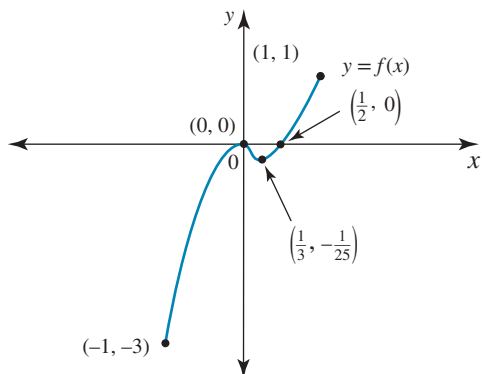

c $y = h(x) = x^3 - x^2 - x + 10$

The graph cuts the y-axis where $x = 0, y = 10$.

The graph cuts the x-axis where $y = 0$.

$$x^3 - x^2 - x + 10 = 0$$

Let $P(x) = x^3 - x^2 - x + 10$.

$$P(2) = 2^3 - 2^2 - 2 + 10 \neq 0$$

$$P(-2) = (-2)^3 - (-2)^2 + 2 + 10 = -8 - 4 + 12 = 0$$

$(x + 2)$ is a factor.

$$x^3 - x^2 - x + 10 = (x + 2)(x^2 - 3x + 5)$$

$x^2 - 3x + 5$ cannot be further factorised as $\Delta < 0$.

$$(x + 2)(x^2 - 3x + 5) = 0$$

$$x + 2 = 0$$

$$x = -2$$

Stationary points occur where $\frac{dy}{dx} = 0$.

$$\frac{dy}{dx} = 3x^2 - 2x - 1$$

$$0 = (3x + 1)(x - 1)$$

$$3x + 1 = 0 \text{ or } x - 1 = 0$$

$$x = -\frac{1}{3} \quad x = 1$$

When $x = -1, \frac{dy}{dx} = 3(-1)^2 - 2(-1) - 1 = 4$.

When $x = 0, \frac{dy}{dx} = 3(0)^2 - 2(0) - 1 = -1$.

When $x = 2, \frac{dy}{dx} = 2(2)^2 - 2(2) - 1 = 3$.

x	$x < -\frac{1}{3}$	$x = -\frac{1}{3}$	$-\frac{1}{3} < x < 1$	$x = 1$	$x > 1$
$\frac{dy}{dx}$	/	—	\	—	/

d $y = f(x) = x^4 - 6x^2 + 8$

The graph cuts the y-axis where $x = 0, y = 8$.

The graph cuts the x-axis where $y = 0$.

$$x^4 - 6x^2 + 8 = 0$$

$$(x^2 - 2)(x^2 - 4) = 0$$

$$(x - \sqrt{2})(x + \sqrt{2})(x - 2)(x + 2) = 0$$

$$x - \sqrt{2} = 0 \text{ or } x + \sqrt{2} = 0 \text{ or } x - 2 = 0 \text{ or } x + 2 = 0$$

$$x = \sqrt{2} \quad x = -\sqrt{2} \quad x = 2 \quad x = -2$$

Stationary points occur where $\frac{dy}{dx} = 0$.

$$\frac{dy}{dx} = 4x^3 - 12x$$

$$0 = 4x(x^2 - 3)$$

$$0 = 4x(x - \sqrt{3})(x + \sqrt{3})$$

$$x = 0 \text{ or } x - \sqrt{3} = 0 \text{ or } x + \sqrt{3} = 0$$

$$x = \sqrt{3} \quad x = -\sqrt{3}$$

When $x = -2, \frac{dy}{dx} = 4(-2)^3 - 12(-2)$.

When $x = -1, \frac{dy}{dx} = 4(-1)^3 - 12(-1)$.

When $x = 1, \frac{dy}{dx} = 4(1)^3 - 12(1)$.

When $x = 2, \frac{dy}{dx} = 4(2)^3 - 12(2)$.

See the table at the bottom of the page.*

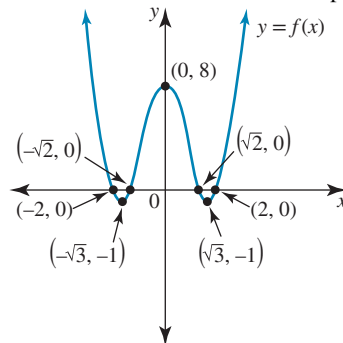

*6 d

x	$x < -\sqrt{3}$	$x = -\sqrt{3}$	$-\sqrt{3} < x < 0$	$x = 0$	$0 < x < \sqrt{3}$	$x = \sqrt{3}$	$x > \frac{1}{3}$
$\frac{dy}{dx}$	\	—	/	—	\	—	/

$$e \ y = f(x) = (x+3)^3(4-x)$$

The graph cuts the y-axis where $x = 0$, $y = (3)^3(4) = 108$.

The graph cuts the x-axis where $y = 0$.

$$(x+3)^3(4-x) = 0$$

$$x+3 = 0 \text{ or } 4-x = 0$$

$$x = -3 \quad x = 4$$

Stationary points occur where $\frac{dy}{dx} = 0$.

$$\frac{dy}{dx} = 3(x+3)^2(4-x) - (x+3)^3$$

$$0 = (x+3)^2 \{3(4-x) - (x+3)\}$$

$$0 = (x+3)^2(12-3x-x-3)$$

$$0 = (x+3)^2(9-4x)$$

$$x+3 = 0 \text{ or } 9-4x = 0$$

$$x = -3 \quad x = \frac{9}{4}$$

$$\text{When } x = -4, \frac{dy}{dx} = (-4+3)^2(9-4(-4)) = 25.$$

$$\text{When } x = 0, \frac{dy}{dx} = (0+3)^2(9-4(0)) = 81.$$

$$\text{When } x = 3, \frac{dy}{dx} = (3+3)^2(9-4(3)) = -18.$$

x	$x < -3$	$x = -3$	$-3 < x < \frac{9}{4}$	$x = \frac{9}{4}$	$x > \frac{9}{4}$
$\frac{dy}{dx}$	/	—	/	—	\

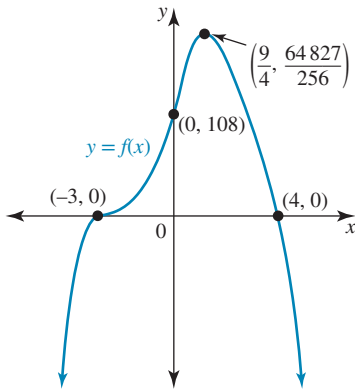

$$f \ y = f(x) = x^3 - 4x^2 - 3x + 12$$

The graph cuts the y-axis where $x = 0$, $y = 12$.

The graph cuts the x-axis where $y = 0$.

$$x^3 - 4x^2 - 3x + 12 = 0$$

$$x^2(x-4) - 3(x-4) = 0$$

$$(x-4)(x^2-3) = 0$$

$$(x-4)(x-\sqrt{3})(x+\sqrt{3}) = 0$$

$$x-4 = 0 \text{ or } x-\sqrt{3} = 0 \text{ or } x+\sqrt{3} = 0$$

$$x = 4 \quad x = \sqrt{3} \quad x = -\sqrt{3}$$

Stationary points occur where $\frac{dy}{dx} = 0$.

$$\frac{dy}{dx} = 3x^2 - 8x - 3$$

$$0 = (3x+1)(x-3)$$

$$3x+1 = 0 \text{ or } x-3 = 0$$

$$x = -\frac{1}{3} \quad x = 3$$

$$\text{When } x = -1, \frac{dy}{dx} = 3(-1)^2 - 8(-1) - 3 = 8.$$

$$\text{When } x = 0, \frac{dy}{dx} = 3(0)^2 - 8(0) - 3 = -3.$$

$$\text{When } x = 4, \frac{dy}{dx} = 3(4)^2 - 8(4) - 3 = 13.$$

x	$x < -\frac{1}{3}$	$x = -\frac{1}{3}$	$-\frac{1}{3} < x < 3$	$x = 3$	$x > 3$
$\frac{dy}{dx}$	/	—	\	—	/

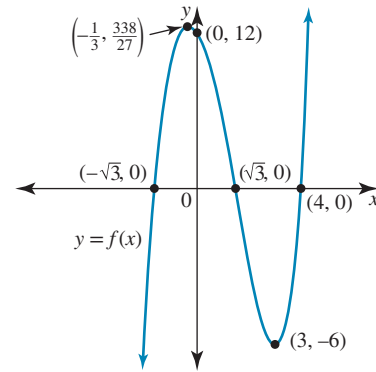

$$7 \ a \ f(x) = -x^4 + 2x^3 + 11x^2 - 12x = x(-x^3 + 2x^2 + 11x - 12)$$

$$\text{Let } P(x) = -x^3 + 2x^2 + 11x - 12.$$

$$P(1) = -(1)^3 + 2(1)^2 + 11(1) - 12 = 0$$

$(x-1)$ is a factor.

$$\begin{aligned} -x^3 + 2x^2 + 11x - 12 &= (x-1)(-x^2 + x + 12) \\ &= (x-1)(4-x)(x+3) \end{aligned}$$

$$\begin{aligned} \text{Thus, } f(x) &= -x^4 + 2x^3 + 11x^2 - 12x \\ &= x(x-1)(4-x)(x+3) \end{aligned}$$

The graph cuts the y-axis where $x = 0$, $y = 0$.

The graph cuts the x-axis where $y = 0$.

$$x(x-1)(4-x)(x+3) = 0$$

$$x = 0 \text{ or } x-1 = 0 \text{ or } 4-x = 0 \text{ or } x+3 = 0$$

$$x = 1 \quad x = 4 \quad x = -3$$

Stationary points occur where $f'(x) = 0$.

$$f'(x) = -4x^3 + 6x^2 + 22x - 12 = -2(2x^3 - 3x^2 - 11x + 6)$$

$$\text{Let } P(x) = 2x^3 - 3x^2 - 11x + 6.$$

$$P(-2) = 2(-2)^3 - 3(-2)^2 - 11(-2) + 6$$

$$= -16 - 12 + 22 + 6 = 0$$

Thus, $(x+2)$ is a factor.

$$\begin{aligned} -2(2x^3 - 3x^2 - 11x + 6) &= -2(x+2)(2x^2 - 7x + 3) \\ &= -2(x+2)(2x-1)(x-3) \end{aligned}$$

Stationary points at $-2(x+2)(2x-1)(x-3) = 0$ where

$$x+2 = 0 \text{ or } 2x-1 = 0 \text{ or } x-3 = 0$$

$$x = -2 \quad x = \frac{1}{2} \quad x = 3$$

$$\text{When } x = -2, f(-2) = -2(-2-1)(4+2)(-2+3) = 36.$$

When

$$x = \frac{1}{2}, f\left(\frac{1}{2}\right) = \frac{1}{2}\left(\frac{1}{2}-1\right)\left(4-\frac{1}{2}\right)\left(\frac{1}{2}+3\right) = -\frac{49}{16}.$$

$$\text{When } x = 3, f(3) = 3(3-1)(4-3)(3+3) = 36.$$

$$\text{If } x = -3, f'(-3) = -4(-3)^3 + 6(-3)^2 + 22(-3) - 12$$

$$= 108 + 54 - 66 - 12 = -24$$

$$\text{If } x = 0, f'(0) = -4(0)^3 + 6(0)^2 + 22(0) - 12 = -12$$

$$\text{If } x = 1, f'(1) = -4(1)^3 + 6(1)^2 + 22(1) - 12$$

$$= -4 + 6 + 22 - 12 = 12$$

If $x = 4$, $f'(4) = -4(4)^3 + 6(4)^2 + 22(4) - 12$
 $= -256 + 64 + 88 - 12 = 108$

See the table at the bottom of the page.*

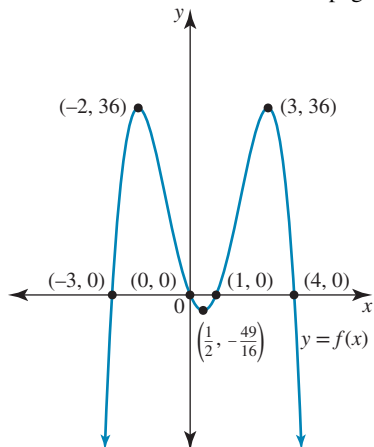

b $x \in (-\infty, -2] \cup \left[\frac{1}{2}, 3\right]$

8 a $f(x) = \frac{1}{2}(2x - 3)^4(x + 1)^5$

The graph cuts the y -axis where $f(0) = \frac{1}{2}(-3)^4(1)^5 = \frac{81}{2}$.

The graph cuts the y -axis where $y = 0$.

$$\frac{1}{2}(2x - 3)^4(x + 1)^5 = 0$$

$$2x - 3 = 0 \text{ or } x + 1 = 0$$

$$x = \frac{3}{2} \quad x = -1$$

Stationary points occur where $f'(x) = 0$.

$$f'(x) = \frac{1}{2}[(2x - 3)^4 \times 5(x + 1)^4 + (x + 1)^5 \times 4(2x - 3)^3 \times 2]$$

$$= \frac{1}{2}(x + 1)^4(2x - 3)^3(5(2x - 3) + 8(x + 1))$$

$$= \frac{1}{2}(x + 1)^4(2x - 3)^3(18x - 7)$$

$$0 = \frac{1}{2}(x + 1)^4(2x - 3)^3(18x - 7)$$

$$x = \frac{3}{2}, -1, \frac{7}{18}$$

$$\Rightarrow \left(\frac{3}{2}, 0\right), (-1, 0), \left(\frac{7}{18}, 63.02\right)$$

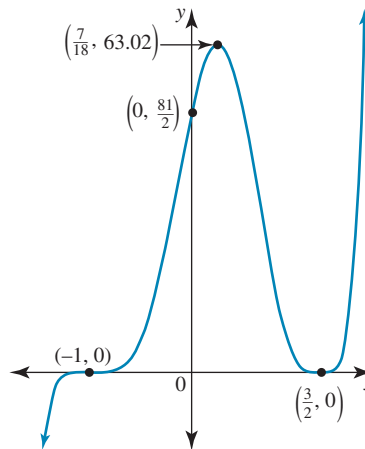

b Strictly decreasing for $x \in \left[\frac{7}{18}, \frac{3}{2}\right]$

9 $y = \frac{1}{10x} + \log_e(x)$

The turning point occurs where $\frac{dy}{dx} = 0$.

$$\frac{1}{x} - \frac{1}{10x^2} = 0$$

$$\frac{10x - 1}{10x^2} = 0$$

$$10x - 1 = 0$$

$$10x = 1$$

$$x = 0.1$$

When $x = 0.1$, $y = \frac{1}{10(0.1)} + \log_e\left(\frac{1}{10}\right)$

$$= 1 + \log_{e(1)} - \log_e(10) = 1 - \log_e(10)$$

Minimum TP at $(0.1, 1 - \log_e(10))$

10 a $f(x) = 2x \log_e(x)$

Local max/min values occur where $f'(x) = 0$.

$$f'(x) = \frac{2x}{x} + 2 \log_e(x) = 2 + 2 \log_e(x)$$

$$0 = 2 + 2 \log_e(x)$$

$$-2 = 2 \log_e(x)$$

$$-1 = \log_e(x)$$

$$x = e^{-1}$$

When $x = 0.1$, $f'(x) = 2 \log_e(0.1) + 2 = -2.6052$.

When $x = 1$, $f'(x) = 2 \log_e(1) + 2 = 2$.

x	$x < e^{-1}$	$x = e^{-1}$	$x > e^{-1}$
$f'(x)$	↘	=	↗

When $x = e^{-1}$,

$$y = 2e^{-1} \log_e(e^{-1})$$

$$y = -2e^{-1}$$

$$y = -\frac{2}{e}$$

$\left(\frac{1}{e}, -\frac{2}{e}\right)$ is a local minimum TP.

*7 a

$x < -2$	$x = -2$	$-2 < x < \frac{1}{2}$	$x = \frac{1}{2}$	$\frac{1}{2} < x < 3$	$x = 3$	$x > 3$
↗	—	↘	—	↗	—	↘

Maximum TP

Minimum TP

Maximum TP

$$\mathbf{b} \quad y = f(x) = \frac{\log_e(2x)}{x}$$

$$\text{Let } u = \log_e(2x), \text{ so } \frac{du}{dx} = \frac{1}{x}.$$

$$\text{Let } v = x, \text{ so } \frac{dv}{dx} = 1.$$

$$\frac{dy}{dx} = \frac{v \frac{du}{dx} - u \frac{dv}{dx}}{v^2}$$

$$\frac{dy}{dx} = \frac{x \times \frac{1}{x} - \log_e(2x) \times 1}{x^2}$$

$$\frac{dy}{dx} = \frac{1 - \log_e(2x)}{x^2}$$

Max/min values occur where $\frac{dy}{dx} = 0$.

$$\frac{1 - \log_e(2x)}{x^2} = 0$$

$$1 - \log_e(2x) = 0$$

$$1 = \log_e(2x)$$

$$e^1 = 2x$$

$$x = \frac{1}{2}e$$

$$\text{When } x = 0.6, \frac{dy}{dx} = \frac{1 - \log_e(2 \times 0.6)}{(0.6)^2} = 1.7649.$$

$$\text{When } x = 2, \frac{dy}{dx} = \frac{1 - \log_e(2 \times 2)}{(2)^2} = -0.0966.$$

x	$x < \frac{1}{2}e$	$x = \frac{1}{2}e$	$x > \frac{1}{2}e$
$\frac{dy}{dx}$	/	—	\

$$\text{When } x = \frac{1}{2}e, y = \log_e(e) \div \frac{1}{2}e = \frac{2}{e}.$$

There is a local maximum at $\left(\frac{e}{2}, \frac{2}{e}\right)$.

$$\mathbf{c} \quad f(x) = x \log_e\left(\frac{3}{x}\right)$$

$$f'(x) = \log_e\left(\frac{3}{x}\right) + x \times \left(-\frac{1}{x}\right)$$

$$f'(x) = \log_e\left(\frac{3}{x}\right) - 1$$

Max/min values occur where $f'(x) = 0$.

$$\log_e\left(\frac{3}{x}\right) - 1 = 0$$

$$\log_e\left(\frac{3}{x}\right) = 1$$

$$\frac{3}{x} = e$$

$$x = \frac{3}{e}$$

$$\text{When } x = 1, f'(1) = \log_e(3) - 1 = 0.0986.$$

$$\text{When } x = 2, f'(1) = \log_e(1.5) - 1 = -0.5945.$$

x	$x < \frac{3}{e}$	$x = \frac{3}{e}$	$x > \frac{3}{e}$
$f'(x)$	/	—	\

$$\text{When } x = \frac{3}{e}, f\left(\frac{3}{e}\right) = \frac{3}{e} \log_e\left(3 \div \frac{3}{e}\right) = \frac{3}{e} \log_e(e) = \frac{3}{e}.$$

There is a local maximum at $\left(\frac{3}{e}, \frac{3}{e}\right)$.

$$\mathbf{d} \quad f(x) = x - \log_e(\sqrt{x-2})$$

$$= x - \frac{1}{2} \log_e(x-2)$$

$$f'(x) = 1 - \frac{1}{2(x-2)}$$

Max/min values occur when $f'(x) = 0$.

$$0 = 1 - \frac{1}{2(x-2)}$$

$$1 = \frac{1}{2(x-2)}$$

$$2(x-2) = 1$$

$$x-2 = \frac{1}{2}$$

$$x = \frac{5}{2}$$

$$\text{When } x = \frac{9}{4}, f'\left(\frac{9}{4}\right) = -1.$$

When $x = 3, f'(3) = \frac{1}{2}$.

	$\frac{9}{4}$	$\frac{5}{2}$	3
x	-1	0	$\frac{1}{2}$
$f'(x)$	\	—	/

$$x = \frac{5}{2}, f\left(\frac{5}{2}\right) = \frac{5}{2} - \frac{1}{2} \log_e\left(\frac{1}{2}\right)$$

$$= \frac{5}{2} + \frac{1}{2} \log_e(2)$$

There is a local minimum at $\left(\frac{5}{2}, \frac{5}{2} + \frac{1}{2} \log_e(2)\right)$.

11 a

x	$x < -1$	$x = -1$	$-1 < x < 3$	$x = 3$	$x > 3$
$\frac{dy}{dx}$	/	—	\	—	/

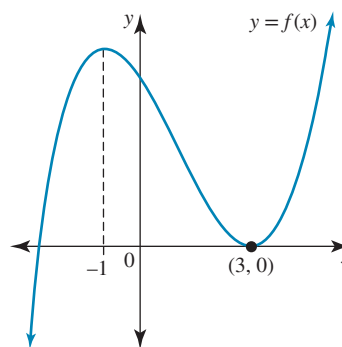

b

x	$x < -1$	$x = -1$	$-1 < x < 3$
$\frac{dy}{dx}$	\	—	\

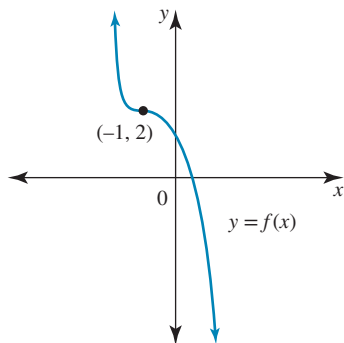

12 a $y = x^3 + bx + c$
 When $x = 2$, $y = -8$.
 $-8 = (2)^3 + 2b + c$
 $-16 = 2b + c$ [1]

$$\frac{dy}{dx} = 3x^2 + b$$

Stationary point at $(2, -8)$:

$$0 = 3(2)^2 + b$$

$$0 = 12 + b$$

$$-12 = b$$

Substitute $b = -12$ into [1]:

$$-16 = 2(-12) + c$$

$$-16 = -24 + c$$

$$8 = c$$

$$y = x^3 - 12x + 8$$

b $y = ax^2 + bx + 15$

When $x = 1.5$, $y = 6$.

$$6 = a\left(\frac{3}{2}\right)^2 + \left(\frac{3}{2}\right)b + 15$$

$$-9 = \frac{9}{4}a + \frac{3}{2}b$$

$$-36 = 9a + 6b$$

$$-12 = 3a + 2b$$
 [1]

$$\frac{dy}{dx} = 2ax + b$$

Stationary point at $(1.5, 6)$:

$$0 = 2a\left(\frac{3}{2}\right) + b$$

$$0 = 3a + b$$
 [2]

[1] - [2]

$$-12 = b$$

Substitute $b = -12$ into [2]:

$$0 = 3a - 12$$

$$12 = 3a$$

$$4 = a$$

$$y = 4x^2 - 12x + 15$$

c $y = x^3 + bx^2 + cx + d$

When $x = -3$, $y = -10$.

$$-10 = (-3)^3 + b(-3)^2 - 3c + d$$

$$-10 = -27 + 9b - 3c + d$$

$$17 = 9b - 3c + d$$
 [1]

When $x = 1$, $y = 6$.

$$6 = (1)^3 + b(1)^2 + c + d$$

$$6 = 1 + b + c + d$$

$$5 = b + c + d$$
 [2]

Stationary point at $(-3, -10)$:

$$\frac{dy}{dx} = 3x^2 + 2bx + c$$

$$0 = 3(-3)^2 + 2(-3)b + c$$

$$-27 = -6b + c$$
 [3]

[1] - [2]

$$12 = 8b - 4c$$

$$3 = 2b - c$$
 [4]

[3] + [4]

$$-24 = -4b$$

$$6 = b$$

Substitute $b = 6$ into [3]:

$$-27 = -6(6) + c$$

$$-27 = -36 + c$$

$$9 = c$$

Substitute $b = 6$ and $c = 9$ into [2]:

$$5 = 6 + 9 + d$$

$$5 = 15 + d$$

$$-10 = d$$

$$y = x^3 + 6x^2 + 9x - 10$$

13 a $f(x) = \frac{1}{4x} + x$ where $x \in \left[-2, -\frac{1}{4}\right]$

End points: $f(-2) = \frac{1}{4(-2)} - 2 = -\frac{17}{8}$ and

$$f\left(-\frac{1}{4}\right) = \frac{1}{4\left(-\frac{1}{4}\right)} - \frac{1}{4} = -\frac{5}{4}$$

The end points are $\left(-2, -\frac{17}{8}\right)$ and $\left(-\frac{1}{4}, -\frac{5}{4}\right)$.

b Stationary points occur where $f'(x) = 0$.

$$f(x) = \frac{1}{4}x^{-1} + x$$

$$f'(x) = -\frac{1}{4x^2} + 1$$

$$0 = -\frac{1}{4x^2} + 1$$

$$0 = 4x^2 - 1$$

$$0 = (2x - 1)(2x + 1)$$

$$x = \pm\frac{1}{2}$$

But $x \in \left[-2, -\frac{1}{4}\right]$, so $x = -\frac{1}{2}$.

If $x = -1$, $f'(-1) = -\frac{1}{4(-1)^2} + 1 = \frac{3}{4}$.

If $x = -\frac{3}{8}$, $f'\left(-\frac{3}{8}\right) = -\frac{1}{4\left(-\frac{3}{8}\right)^2} + 1 = -\frac{16}{9} + 1 = \frac{-7}{9}$.

$x < 1$	$x = 1$	$1 < x < \frac{5}{3}$	$x = \frac{5}{3}$	$x > \frac{5}{3}$
/	—	\	—	/

Maximum TP at $\left(-\frac{1}{2}, -1\right)$

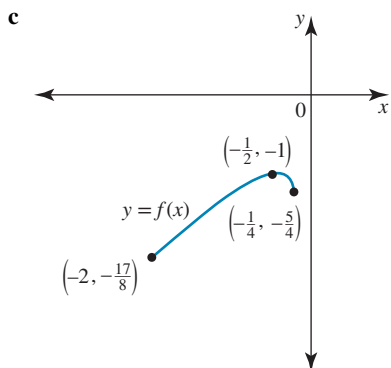

d Absolute minimum = $-\frac{17}{8}$, absolute maximum -1

14 $f(x) = 2x^3 - 8x = 2x(x^2 - 4) = 2x(x - 2)(x + 2)$

The graph cuts the y -axis where $x = 0$, $y = 0$.

The graph cuts the x -axis where $y = 0$.

$$2x(x - 2)(x + 2) = 0$$

$$x = 0 \text{ or } x - 2 = 0 \text{ or } x + 2 = 0$$

$$x = 2 \quad x = -2$$

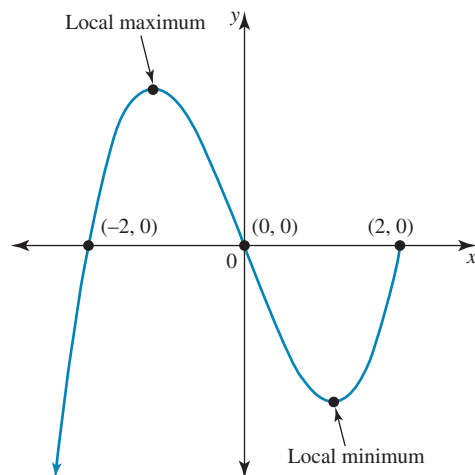

No absolute minimum; the absolute maximum occurs when

$$f'(x) = 0 \text{ for } x \leq 2.$$

$$f'(x) = 6x^2 - 8$$

$$0 = 6x^2 - 8$$

$$\frac{4}{3} = x^2$$

$$-\frac{2}{\sqrt{3}} = x$$

$$f\left(-\frac{2}{\sqrt{3}}\right) = 2\left(-\frac{2}{\sqrt{3}}\right)^3 - 8\left(-\frac{2}{\sqrt{3}}\right)$$

$$= -\frac{16}{3\sqrt{3}} + \frac{16}{\sqrt{3}}$$

$$= -\frac{16}{3\sqrt{3}} + \frac{48}{3\sqrt{3}}$$

$$= \frac{32}{3\sqrt{3}}$$

Therefore, there is no absolute minimum, and the absolute

maximum is $\frac{32}{3\sqrt{3}}$.

15 a $y = \frac{1}{2}(x - 1)^2 - 2$, $0 \leq x \leq 5$

The graph has a turning point at $(1, -2)$ and cuts the y -axis

at $(0, -\frac{3}{2})$.

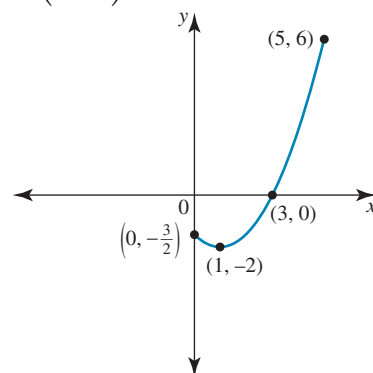

The absolute minimum is -2 and the absolute maximum is 6 .

b $y = x^3 - 2x^2 = x^2(x - 2)$, $-2 \leq x \leq 3$

The graph cuts the y -axis at $(0, 0)$ and the x -axis at $(0, 0)$ and

$(2, 0)$. There are turning points at $(0, 0)$ and $(\frac{4}{3}, -\frac{32}{27})$.

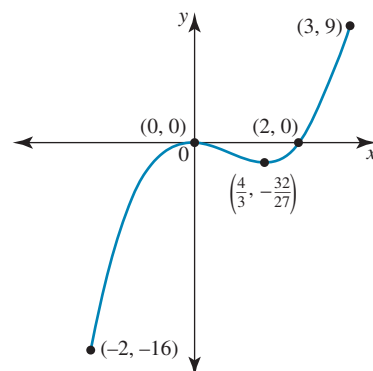

The absolute minimum is -16 and the absolute maximum is 9 .

c $y = 4 - x^3$, $x \leq 2$

The graph cuts the y -axis at $(0, 4)$ and the x -axis at

$(\sqrt[3]{4}, 0)$. There is a point of inflection at $(0, 4)$.

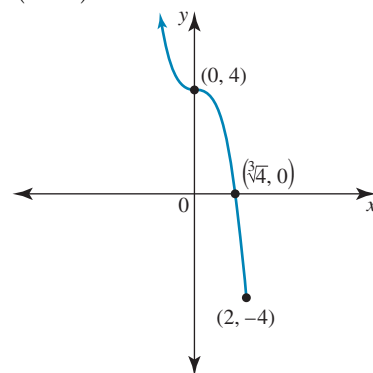

No absolute maximum, and the absolute minimum is -4 .

16 $y = f(x) = 2\sqrt{x} + \frac{1}{x}$, $0.25 \leq x \leq 5$.

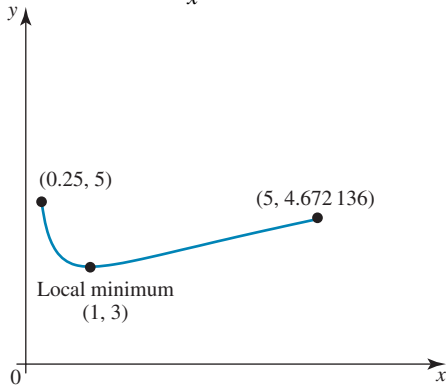

a When $x = 0.25$, $f(0.25) = 2\sqrt{0.25} + \frac{1}{0.25} = 5$, which is point A.

When $x = 5$, $f(5) = 2\sqrt{5} + 0.2 (= 4.672)$, which is point C.

Stationary point B occurs where $f'(x) = 0$.

$$f'(x) = \frac{1}{\sqrt{x}} - \frac{1}{x^2}$$

$$0 = \frac{1}{\sqrt{x}} - \frac{1}{x^2}$$

$$0 = x^2 - \sqrt{x}$$

$$0 = \sqrt{x} \left(x^{\frac{3}{2}} - 1 \right)$$

$$x^{\frac{3}{2}} - 1 = 0$$

$$x^{\frac{3}{2}} = 1$$

$$x = 1$$

When $x = 1$, $f(1) = 2\sqrt{1} + \frac{1}{1} = 3$.

Therefore, A = (0.25, 5), B = (1, 3), C = (5, 2√5 + 0.2).

b The absolute maximum occurs at A.

c The absolute minimum is 3 and the absolute maximum is 5.

17 $y = f(x) = xe^x$

a Stationary points occur where $\frac{dy}{dx} = 0$.

$$\frac{dy}{dx} = e^x + xe^x = e^x(1+x)$$

$$0 = e^x(1+x)$$

$x + 1 = 0$ as $e^x > 0$ for all x

$$x = -1$$

When $x = -1$, $y = -e^{-1} = -\frac{1}{e}$.

When $x = -2$, $\frac{dy}{dx} = e^{-2}(1-2) = \frac{-1}{e^2}$.

When $x = 0$, $\frac{dy}{dx} = e^0(1+1) = 2$.

x	$x < -1$	$x = -1$	$x > -1$
$\frac{dy}{dx}$	\searrow	---	\nearrow

Minimum TP at $\left(-1, -\frac{1}{e}\right)$

b $f'(x) > 0$ for $x \in (-1, \infty)$.

c The absolute minimum is $-\frac{1}{e}$ and there is no absolute maximum.

18 a

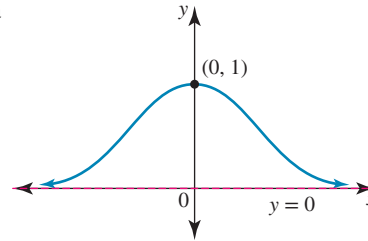

b $y = 20e^{-2x^2-4x+1}$

$$\frac{dy}{dx} = 20(-4x-4)e^{-2x^2-4x+1} = -80(x+1)e^{-2x^2-4x+1}$$

Stationary points occur where $\frac{dy}{dx} = 0$.

$$-80(x+1)e^{-2x^2-4x+1} = 0$$

$$x + 1 = 0 \text{ as } e^{-2x^2-4x+1} > 0 \text{ for all } x$$

$$x = -1$$

When $x = -2$, $\frac{dy}{dx} = -80(-2+1)e^{-2(-2)^2-4(-2)+1} = 80e$.

When $x = 0$, $\frac{dy}{dx} = -80(0+1)e^1 = -80e$.

x	$x < -1$	$x = -1$	$x > -1$
$\frac{dy}{dx}$	\nearrow	---	\searrow

The function is strictly increasing when $x \in (-\infty, -1]$.

19 a The graph cuts the x -axis where $y = 0$.

$$\frac{1}{x^2} - 2 \log_e(x+3) = 0$$

$$\frac{1}{x^2} = 2 \log_e(x+3)$$

By calculator, $x = -1.841$ and -0.795 .

Therefore, the coordinates are $(-1.841, 0)$ and $(-0.795, 0)$.

b $y = \frac{1}{x^2} - 2 \log_e(x+3)$

$$y = x^{-2} - 2 \log_e(x+3)$$

$$\frac{dy}{dx} = -2x^{-3} - \frac{2}{x+3}$$

$$\frac{dy}{dx} = -\frac{2}{x^3} - \frac{2}{x+3}$$

$$\frac{dy}{dx} = \frac{-2(x+3) - 2x^3}{x^3(x+3)}$$

$$\frac{dy}{dx} = -\frac{(2x^3 + 2x + 6)}{x^3(x+3)}$$

$$\text{At } (-1.841, 0), \quad m_T = -\frac{(2(-1.841)^3 + 2(-1.841) + 6)}{(-1.841)^3(-1.841 + 3)}$$

$$= -1.1989$$

The equation of the tangent with $m_T = -1.1989$ that passes through $(x_1, y_1) = (-1.841, 0)$ is given by

$$\begin{aligned} y - y_1 &= m_T(x - x_1) \\ y - 0 &= -1.1989(x + 1.841) \\ y &= -1.1989x - 2.2072 \end{aligned}$$

$$\begin{aligned} \text{At } (-0.795, 0), m_T &= -\frac{(2(-0.795)^3 + 2(-0.795) + 6)}{(-0.795)^3(-0.795 + 3)} \\ &= 3.0725 \end{aligned}$$

The equation of the tangent with $m_T = 3.0735$ that passes through $(x_1, y_1) = (-0.795, 0)$ is given by

$$\begin{aligned} y - y_1 &= m_T(x - x_1) \\ y - 0 &= 3.0735(x + 0.795) \\ y &= 3.0735x + 2.4434 \end{aligned}$$

c Minimum TP occurs when $\frac{dy}{dx} = 0$.

$$\begin{aligned} -\frac{(2x^3 + 2x + 6)}{x^3(x + 3)} &= 0 \\ 2x^3 + 2x + 6 &= 0 \\ x^3 + x + 6 &= 0 \\ x &= -1.2134 \text{ since } x < 0 \end{aligned}$$

When $x = -1.2134$,

$$y = \frac{1}{(-1.2134)^2} - 2 \log_e(-1.2134 + 3) = -0.4814.$$

Minimum TP is $(-1.2134, -0.4814)$.

20 a The graph cuts the x -axis where $y = 0$.

$$\begin{aligned} -\frac{1}{x^2} - 8 \log_e(x) &= 0 \\ -8 \log_e(x) &= \frac{1}{x^2} \\ x &= 0.3407 \text{ or } 0.8364 \end{aligned}$$

Therefore, the coordinates are $(0.3407, 0)$ and $(0.8364, 0)$.

b $y = -\frac{1}{x^2} - 8 \log_e(x)$

$$y = -x^{-2} - 8 \log_e(x)$$

$$\frac{dy}{dx} = 2x^{-3} - \frac{8}{x}$$

$$\frac{dy}{dx} = \frac{2}{x^3} - \frac{8}{x}$$

$$\frac{dy}{dx} = \frac{2 - 8x^2}{x^3}$$

$$\text{When } x = 0.3407, \frac{dy}{dx} = \frac{2 - 8(0.3407)^2}{(0.3407)^3} = 27.09.$$

$$\text{When } x = 0.8364, \frac{dy}{dx} = \frac{2 - 8(0.8364)^2}{(0.8364)^3} = -6.15.$$

c At $(1, -1)$, $m_T = \frac{dy}{dx} = \frac{2 - 8(1)^2}{(1)^3} = -6$.

The equation of the tangent with $m_T = -6$ that passes through $(x_1, y_1) = (1, -1)$ is given by

$$\begin{aligned} y - y_1 &= m_T(x - x_1) \\ y + 1 &= -6(x - 1) \end{aligned}$$

$$y + 1 = -6x + 6$$

$$y = -6x + 5$$

The equation of the perpendicular line with $m_P = \frac{1}{6}$ that passes through $(x_1, y_1) = (1, -1)$ is given by

$$\begin{aligned} y - y_1 &= m_P(x - x_1) \\ y + 1 &= \frac{1}{6}(x - 1) \end{aligned}$$

$$y + 1 = \frac{1}{6}x - \frac{1}{6}$$

$$y = \frac{1}{6}x - \frac{7}{6} \text{ or } x - 6y = 7$$

d TP occurs where $\frac{dy}{dx} = 0$.

$$\frac{2 - 8x^2}{x^3} = 0$$

$$2 - 8x^2 = 0$$

$$1 - 4x^2 = 0$$

$$(1 - 2x)(1 + 2x) = 0$$

$$1 - 2x = 0 \quad \text{or} \quad 1 + 2x = 0$$

$$1 = 2x \quad \quad \quad 2x = -1$$

$$x = \frac{1}{2} \quad \quad \quad x = -\frac{1}{2} \text{ but } x > 0$$

$$\text{When } x = 0.5, y = -\frac{1}{(0.5)^2} - 8 \log_e(0.5) = -4 + 8 \log_e(2).$$

$$\text{Maximum TP at } \left(\frac{1}{2}, -4 + 8 \log_e(2)\right)$$

21 a $f(x) = (a - x)^2(x - 2)$ where $a > 2$

This is a positive cubic with a turning point at $(a, 0)$.

Stationary points occur where $f'(x) = 0$.

$$f'(x) = -2(a - x)(x - 2) + (a - x)^2$$

$$f'(x) = -(a - x)(2(x - 2) - (a - x))$$

$$f'(x) = -(a - x)(3x - 4 - a)$$

$$0 = (a - x)(3x - 4 - a)$$

$$a - x = 0 \text{ or } 3x - 4 - a = 0$$

$$x = a \quad \quad x = \frac{a + 4}{3}$$

$$\text{When } x = a, y = (a - a)^2(a - 2) = 0.$$

$$\text{When } x = \frac{a + 4}{3},$$

$$y = \left(a - \frac{a + 4}{3}\right)^2 \left(\frac{a + 4}{3} - 2\right)$$

$$= \left(\frac{3a - a - 4}{3}\right)^2 \left(\frac{a + 4 - 6}{3}\right)$$

$$= \left(\frac{2(a - 2)}{3}\right)^2 \left(\frac{a - 2}{3}\right)$$

$$= \frac{4(a - 2)^3}{27}$$

Therefore, stationary points are $(a, 0)$ and

$$\left(\frac{a + 4}{3}, \frac{4(a - 2)^3}{27}\right).$$

b See the table at the bottom of the page.*

Minimum TP at $(a, 0)$ and a maximum TP at

$$\left(\frac{a+4}{3}, \frac{4(a-2)^3}{27}\right)$$

c $(3, 4) = \left(\frac{a+4}{3}, \frac{4(a-2)^3}{27}\right)$

$$\frac{a+4}{3} = 3$$

$$a+4=9$$

$$a=5$$

22 a $f(x) = (x-a)(x-b)^3$ where $a < b$

This is a quartic graph with a stationary point of inflection at $x = b$ since $(x-b)$ is raised to the power of 3.

The graph cuts the x -axis where $f(x) = 0$.

$$(x-a)(x-b)^3 = 0$$

$$x-a=0 \text{ or } x-b=0$$

$$x=a \quad x=b$$

Stationary points are $(a, 0)$ and $(b, 0)$.

b Stationary points occur where $f'(x) = 0$.

$$f'(x) = (x-b)^3 + 3(x-a)(x-b)^2$$

$$f'(x) = (x-b)^2(x-b+3x-3a)$$

$$f'(x) = (x-b)^2(4x-3a-b)$$

$$0 = (x-b)^2(4x-3a-b)$$

$$x-b=0 \text{ or } 4x-3a-b=0$$

$$x=b \quad x = \frac{3a+b}{4}$$

When $x = b$, $f(b) = (b-a)(b-b)^3 = 0$. This is a point of inflection.

When $x = \frac{3a+b}{4}$,

$$\begin{aligned} f\left(\frac{3a+b}{4}\right) &= \left(\frac{3a+b}{4} - a\right) \left(\frac{3a+b}{4} - b\right)^3 \\ &= \left(\frac{3a+b-4a}{4}\right) \left(\frac{3a+b-4b}{4}\right)^3 \\ &= -\left(\frac{a-b}{4}\right) \left(\frac{3a-3b}{4}\right)^3 \\ &= -\frac{27(a-b)^4}{256} \end{aligned}$$

Stationary points are $(b, 0)$, $\left(\frac{3a+b}{4}, \frac{-27(a-b)^4}{256}\right)$.

c See the table at the bottom of the page.*

There is a minimum TP at $\left(\frac{3a+b}{4}, \frac{-27(a-b)^4}{256}\right)$ and a stationary point of inflection at $(b, 0)$.

d $(3, -27) \equiv \left(\frac{3a+b}{4}, \frac{-27(a-b)^4}{256}\right)$

$$\frac{3a+b}{4} = 3$$

$$3a+b=12 \quad [1]$$

$$-\frac{27(a-b)^4}{256} = -27$$

$$\frac{(a-b)^4}{256} = 1$$

$$(a-b)^4 = 256$$

$$a-b = \pm 4 \text{ but } a <$$

$$a-b = -4 \quad [2]$$

$$[1] + [2]$$

$$4a = 8$$

$$a = 2$$

Substitute $a = 2$ into [2], so $2 - b = -4 \Rightarrow b = 6$.

6.5 Exam questions

1 $f(x) = x^3 + ax^2 + bx$

$$f'(x) = 3x^2 + 2ax + b$$

$$f'(-1) = 0 \Rightarrow 3 - 2a + b = 0 \quad [1]$$

$$f'(3) = 0 \Rightarrow 27 + 6a + b = 0 \quad [2]$$

$$[2] - [1]: 24 + 8a = 0$$

$$\Rightarrow a = -3$$

$$b = 2a - 3 = -9$$

The correct answer is **D**.

2 $f: R \rightarrow R$, $f(x) = ax^3 - bx^2 + cx$, $a, b, c \in R^+$

$$f'(x) = 3ax^2 - 2bx + c \neq 0$$

There will be no stationary points when $\Delta < 0$.

$$\Rightarrow \Delta = (-2b)^2 - 4 \times 3a \times c < 0$$

$$4b^2 - 12ac < 0 \text{ or } c > \frac{b^2}{3a}$$

The correct answer is **D**.

3 a $f: R \rightarrow R$, $f(x) = x^3 - 5x$

$$f'(x) = 3x^2 - 5 = 0$$

$$\Rightarrow x = \pm \frac{\sqrt{15}}{3}, f\left(\frac{\sqrt{15}}{3}\right) = -\frac{10\sqrt{15}}{9},$$

$$f\left(-\frac{\sqrt{15}}{3}\right) = \frac{10\sqrt{15}}{9}$$

$$\text{TP} \left(\frac{\sqrt{15}}{3}, -\frac{10\sqrt{15}}{9}\right), \left(-\frac{\sqrt{15}}{3}, \frac{10\sqrt{15}}{9}\right)$$

Award 1 mark for setting the derivative equal to zero.

Award 1 mark for both correct turning points.

*21 b

x	$x = a - 1$	$x = a$	$x = \frac{2a+2}{3}$	$x = \frac{a+4}{3}$	$x = \frac{a+4}{3} + 1 = \frac{a+7}{3}$
$\frac{dy}{dx}$					

*22 c

x	$x = \frac{3a+b-4}{4}$	$x = \frac{3a+b}{4}$	$x = \frac{3a+5b}{8}$	$x = b$	$x = b + 1$
$\frac{dy}{dx}$					

b i $A(-1, f(-1)) = (-1, 4), B(1, f(1)) = (1, -4)$

$$m_{AB} = \frac{4 - (-4)}{-1 - 1} = -4$$

$$y - 4 = -4(x + 1)$$

$$y - 4 = -4x - 4$$

$$y = -4x$$

Award 1 mark for calculating the correct gradient.

Award 1 mark for the correct equation.

ii $d_{AB} = \sqrt{(4 - (-4))^2 + (-1 - 1)^2}$
 $= \sqrt{68}$
 $= 2\sqrt{17}$

Award 1 mark for the correct distance.

6.6 Maximum and minimum problems

6.6 Exercise

1 The point is $(x_1, y_1) \equiv (x, y)$. Let $(x_2, y_2) \equiv (0, 0)$.

Minimum distance:

$$D = \sqrt{(x_2 - x_1)^2 + (y_2 - y_1)^2}$$

$$= \sqrt{(x - 0)^2 + (y - 0)^2}$$

$$= \sqrt{x^2 + (2x - 5)^2}$$

$$= \sqrt{5x^2 - 20x + 25}$$

$$\frac{dD}{dx} = 0 \text{ gives minimum distance.}$$

$$\frac{dD}{dx} = \frac{1}{2} (5x^2 - 20x + 25)^{-\frac{1}{2}} \times (10x - 20)$$

$$0 = \frac{10x - 20}{2\sqrt{5x^2 - 20x + 25}}$$

$$0 = 10x - 20$$

$$10x = 20$$

$$x = 2$$

$$y = 2 \times 2 - 5$$

$$= -1$$

$$\text{Distance} = \sqrt{5x^2 - 20x + 25}$$

$$= \sqrt{5(2)^2 - 20(2) + 25}$$

$$= \sqrt{5} \text{ units}$$

2 If $y = 2\sqrt{x}$ and the point $(x_1, y_1) = (5, 0)$, the minimum distance is given by

$$D = \sqrt{(x - x_1)^2 + (y - y_1)^2}$$

$$D = \sqrt{(x - 5)^2 + (2\sqrt{x} - 0)^2}$$

$$D = \sqrt{x^2 - 10x + 25 + 4x}$$

$$D = \sqrt{x^2 - 6x + 25}$$

The minimum distance occurs when $\frac{dD}{dx} = 0$.

$$\frac{dD}{dx} = \frac{1}{2} \times \frac{2x - 6}{\sqrt{x^2 - 6x + 25}}$$

$$\frac{dD}{dx} = \frac{x - 3}{\sqrt{x^2 - 6x + 25}}$$

$$0 = \frac{x - 3}{\sqrt{x^2 - 6x + 25}}$$

$$0 = x - 3$$

$$x = 3$$

$$\text{When } x = 3, y = 2\sqrt{3}$$

$$D_{\min} = \sqrt{3^2 - 6(3) + 25} = 4 \text{ units}$$

3 Let one number be m and the other number be n . P is the product of the two numbers.

$$m + n = 32$$

$$m = 32 - n \quad [1]$$

$$P = mn \quad [2]$$

Substitute [1] into [2]:

$$P = n(32 - n)$$

$$P = 32n - n^2$$

Max/min values occur where $\frac{dP}{dn} = 0$.

$$\frac{dP}{dn} = 32 - 2n$$

$$0 = 32 - 2n$$

$$2n = 32$$

$$n = 16$$

Substitute $n = 16$ into [1]:

$$m = 32 - 16 = 16$$

Therefore, both numbers are 16.

4 a $V = x(16 - 2x)(10 - 2x)$

$$V = x(160 - 42x + 4x^2)$$

$$V = 4x^3 - 42x^2 + 160x$$

b Maximum volume occurs when $\frac{dV}{dx} = 0$.

$$\frac{dV}{dx} = 12x^2 - 84x + 160 = 0$$

$$3x^2 - 26x + 40 = 0$$

$$(3x - 20)(x - 2) = 0$$

$$x = 2, \frac{20}{3}$$

$$x = 2, (0 < x < 5)$$

Therefore, height = 2 cm, width = 6 cm and length = 12 cm.

$$V_{\max} = 2(16 - 2(2))(10 - 2(2))$$

$$= 2 \times 12 \times 6$$

$$= 144 \text{ cm}^3$$

5 a Area = rectangular area plus triangular area

$$A = 2xy + \frac{1}{2} \times 2x \times x$$

$$A = 2xy + x^2$$

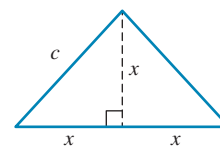

By Pythagoras,

$$x^2 + x^2 = c^2$$

$$2x^2 = c^2$$

$$\sqrt{2}x = c, \quad c > 0$$

$$\text{Perimeter} = 150 = 2x + 2y + 2\sqrt{2}x$$

$$75 = y + (1 + \sqrt{2})x$$

$$75 - (1 + \sqrt{2})x = y$$

$$\text{Thus, } A = 2x(75 - (1 + \sqrt{2})x) + x^2.$$

$$A = 150x - (2\sqrt{2} + 2)x^2 + x^2$$

$$A = 150x - (2\sqrt{2} + 1)x^2 \text{ as required}$$

b Greatest area occurs when $\frac{dA}{dx} = 0$.

$$\frac{dA}{dx} = 150 - 2(2\sqrt{2} + 1)x$$

$$0 = 150 - 2(2\sqrt{2} + 1)x$$

$$150 = 2(2\sqrt{2} + 1)x$$

$$\frac{75}{2\sqrt{2} + 1} = x$$

$$x = 19.59$$

$$\text{Width} = 2x = 39.2 \text{ cm}$$

$$\text{Height} = 75 - (1 + \sqrt{2})(19.59) + 19.59 = 47.3 \text{ cm}$$

c Width = 30 cm

$$\text{Height} = 75 - (1 + \sqrt{2})(15) + 15 = 53.8 \text{ cm}$$

6 a $A = lw$ [1]

$$2l + 5w = 550$$

$$2l = 550 - 5w$$

$$l = \frac{1}{2}(550 - 5w) \quad [2]$$

Substitute [2] into [1]:

$$A = \frac{1}{2}w(550 - 5w)$$

$$A = \frac{550w}{2} - \frac{5w^2}{2}$$

Max/min values occur where $\frac{dA}{dw} = 0$.

$$\frac{dA}{dw} = \frac{550}{2} - 5w$$

$$0 = \frac{550}{2} - 5w$$

$$5w = \frac{550}{2}$$

$$w = \frac{550}{10}$$

$$w = 55 \text{ m}$$

Substitute $w = 55$ into [2]:

$$l = \frac{1}{2}(550 - 5(55))$$

$$l = \frac{275}{2}$$

$$l = 137.5 \text{ m}$$

b $A_{\max} = 137.5 \times 55 = 7562.5 \text{ m}^2$

7 a $P = 96 = 2(2.5b) + 2(2a)$

$$96 = 5b + 4a$$

$$48 = 2.5b + 2a$$

$$48 - 2.5b = 2a$$

$$24 - 1.25b = a \quad [1]$$

$$A = ab + 2.5ab = 3.5ab \quad [2]$$

Substitute [1] into [2]:

$$A = 3.5b(24 - 1.25b)$$

$$A = 84b - 4.375b^2$$

Maximum area occurs where $\frac{dA}{dx} = 0$.

$$\frac{dA}{dx} = 84 - 8.75b$$

$$0 = 84 - 8.75b$$

$$8.75b = 84$$

$$b = 9.6$$

Substitute $b = 9.6$ into [1]:

$$24 - 1.25(9.6) = a$$

$$12 = a$$

b $A_{\max} = 3.5(9.6)(12) = 403.2 \text{ m}^2$

8 The area of the pool is given by $A = 2lR + \frac{\pi}{2}R^2$, where A is a constant.

The perimeter of the pool is given by

$$P = 2l + 2R + \pi R = 2l + (2 + \pi)R.$$

From the area equation, $A - \frac{\pi}{2}R^2 = 2lR$.

$$A - \frac{\pi}{2}R^2 = 2lR$$

$$\frac{2A - \pi R^2}{2} = 2lR$$

$$\frac{2A - \pi R^2}{4R} = l$$

Substitute $l = \frac{2A - \pi R^2}{4R}$ into the perimeter equation.

$$P = 2 \left(\frac{2A - \pi R^2}{4R} \right) + (2 + \pi)R$$

$$P = \frac{2A - \pi R^2 + 2(2 + \pi)R^2}{2R}$$

$$P = \frac{2A - \pi R^2 + 2\pi R^2 + 4R^2}{2R}$$

$$P = \frac{2A + \pi R^2 + 4R^2}{2R}$$

$$P = \frac{A}{R} + \frac{(\pi + 4)}{2}R$$

Minimum value occurs when $\frac{dP}{dR} = 0$.

$$\frac{dP}{dR} = -\frac{A}{R^2} + \frac{\pi + 4}{2}$$

$$0 = \frac{-2A + (\pi + 4)R^2}{2R^2}$$

$$0 = -2A + (\pi + 4)R^2$$

$$2A = (\pi + 4)R^2$$

$$\frac{2A}{\pi + 4} = R^2$$

$$\sqrt{\frac{2A}{\pi + 4}} = R, \quad R > 0$$

Substitute $R = \sqrt{\frac{2A}{\pi + 4}}$ into $A - \frac{\pi}{2}R^2 = 2lR$.

$$A - \frac{\pi}{2} \left(\frac{2A}{\pi + 4} \right) = 2l \left(\sqrt{\frac{2A}{\pi + 4}} \right)$$

$$A - \frac{\pi A}{\pi + 4} = 2l \left(\sqrt{\frac{2A}{\pi + 4}} \right)$$

$$\frac{A(\pi + 4) - \pi A}{\pi + 4} = 2l \left(\sqrt{\frac{2A}{\pi + 4}} \right)$$

$$\frac{2A}{\pi + 4} = l \left(\sqrt{\frac{2A}{\pi + 4}} \right)$$

$$\frac{2A}{\pi + 4} \div \left(\sqrt{\frac{2A}{\pi + 4}} \right) = l$$

$$\sqrt{\frac{2A}{\pi + 4}} = l$$

If both l and $R = \sqrt{\frac{2A}{\pi + 4}}$, the perimeter is a minimum.

9 $P(t) = 200te^{-\frac{t}{4}} + 400, 0 \leq t \leq 12$

a Initially $t = 0$.

$$P(0) = 200(0)e^0 + 400 = 400 \text{ birds}$$

b Largest number of birds when $P'(t) = 0$

$$P'(t) = 200e^{-\frac{t}{4}} - 50te^{-\frac{t}{4}} = 0$$

$$e^{-\frac{t}{4}}(4 - t) = 0$$

$$4 - t = 0 \text{ as } e^{-\frac{t}{4}} > 0 \text{ for all } t$$

$$t = 4$$

At the end of December the population was at its largest.

c $P(4) = 200(4)e^{-1} + 400 = 694$ birds

10 a $A(t) = 1000 - 12te^{\frac{4-t^3}{8}}, t \in [0, 6]$

$$A(0) = 1000 - 12(0)e^{\frac{4-0^3}{8}} = \$1000$$

b The least amount of money occurs when $A'(t) = 0$.

$$A'(t) = 12t \times \frac{-3}{8}t^2 e^{\frac{4-t^3}{8}} + 12e^{\frac{4-t^3}{8}}$$

$$A'(t) = \frac{-9}{2}t^3 e^{\frac{4-t^3}{8}} + 12e^{\frac{4-t^3}{8}}$$

$$A'(t) = e^{\frac{4-t^3}{8}} \left(12 - \frac{9}{2}t^3 \right)$$

$$0 = e^{\frac{4-t^3}{8}} \left(12 - \frac{9}{2}t^3 \right)$$

$$12 - \frac{9}{2}t^3 = 0 \text{ as } e^{\frac{4-t^3}{8}} > 0 \text{ for all } t$$

$$\frac{9}{2}t^3 = 12$$

$$t^3 = \frac{24}{9}$$

$$t^3 = \frac{8}{3}$$

$$t = \sqrt[3]{\frac{8}{3}}$$

$$t = 1.387$$

$$A(1.387) = 1000 - 12(1 - 0.387)e^{\frac{4-1.3887^3}{8}} = \$980.34$$

c The least amount of money occurred 1.387 years after 1 January 2016, which is May 2017.

d $A(6) = 1000 - 12(6)e^{\frac{4-6^3}{8}} = \1000

11 $SA_{\text{cylinder}} = 220\pi = 2\pi rh + 2\pi r^2$

$$V_{\text{cylinder}} = \pi r^2 h \quad [1]$$

$$110 = rh + r^2$$

$$110 - r^2 = rh$$

$$\frac{110}{r} - r = h \quad [2]$$

Substitute [2] into [1]:

$$V = \pi r^2 \left(\frac{110}{r} - r \right)$$

$$V = 110\pi r - \pi r^3$$

Max/min values occur when $\frac{dV}{dr} = 0$.

$$\frac{dV}{dr} = 110\pi - 3\pi r^2$$

$$0 = 110\pi - 3\pi r^2$$

$$3r^2 = 110$$

$$r^2 = \frac{110}{3}$$

$$r = \sqrt{\frac{110}{3}} r > 0$$

$$r = 6.06 \text{ cm}$$

Substitute $r = 6.06$ into [1]:

$$h = \frac{110}{6.055} - 6.06 = 12.11 \text{ cm}$$

$$V_{\text{max}} = \pi (6.06)^2 (12.11) = 1395.04 \text{ cm}^3$$

12 By Pythagoras,

$$r^2 + (h - 12)^2 = 12^2$$

$$r^2 = 144 - (h^2 - 24h + 144)$$

$$r^2 = 24h - h^2$$

$$V_{\text{cone}} = \frac{1}{3}\pi r^2 h$$

$$V_{\text{cone}} = \frac{1}{3}\pi h (24h - h^2)$$

$$V_{\text{cone}} = 8\pi h^2 - \frac{1}{3}\pi h^3$$

$$\frac{dV}{dh} = 16\pi h - \pi h^2$$

Maximum volume occurs when $\frac{dV}{dh} = 0$.

$$16\pi h - \pi h^2 = 0$$

$$h(16 - h) = 0$$

$$h = 0 \text{ or } 16 - h = 0$$

$$h = 16, (h > 0)$$

$$V_{\text{max}} = \frac{16\pi}{3} (24(16) - (16)^2) = 2145 \text{ cm}^3$$

13

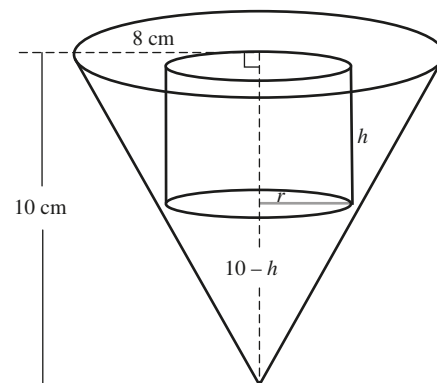

By similar triangles, $r : 8$ as $10 - h : h$.

$$\frac{r}{8} = \frac{10 - h}{10}$$

$$10r = 80 - 8h$$

$$8h = 80 - 10r$$

$$h = 10 - \frac{5}{4}r$$

$$V_{\text{cylinder}} = \pi r^2 h$$

$$V_{\text{cylinder}} = \pi r^2 \left(10 - \frac{5}{4}r\right)$$

$$V_{\text{cylinder}} = 10\pi r^2 - \frac{5}{4}\pi r^3$$

$$\frac{dV}{dr} = 20\pi r - \frac{15}{4}\pi r^2$$

Maximum volume occurs when $\frac{dV}{dr} = 0$.

$$20\pi r - \frac{15}{4}\pi r^2 = 0$$

$$20r - \frac{15}{4}r^2 = 0$$

$$r \left(20 - \frac{15}{4}r\right) = 0$$

$$r = 0 \text{ or } 20 - \frac{15}{4}r = 0$$

$$r = \frac{80}{15} = \frac{16}{3} \text{ cm, } r > 0$$

$$h = 10 - \frac{5}{4} \left(\frac{16}{3}\right) = 10 - \frac{20}{3} = \frac{10}{3} \text{ cm}$$

$$V_{\text{max}} = \pi \left(\frac{16}{3}\right)^2 \left(\frac{10}{3}\right) = 298 \text{ cm}^3$$

14 Speed = $\frac{\text{distance}}{\text{time}}$

Rowing:

$$5 = \frac{AB}{t_r} = \frac{\sqrt{x^2 + 16}}{t_r}$$

$$t_r = \frac{\sqrt{x^2 + 16}}{5}$$

Walking:

$$8 = \frac{8-x}{t_w}$$

$$t_w = \frac{(8-x)}{8}$$

The time for the total journey is

$$T = t_r + t_w = \frac{\sqrt{x^2 + 16}}{5} + \frac{8-x}{8}$$

$$\frac{dT}{dx} = \frac{2x}{10\sqrt{x^2 + 16}} - \frac{1}{8}$$

$$\frac{dT}{dx} = \frac{x}{5\sqrt{x^2 + 16}} - \frac{1}{8}$$

Minimum time occurs when $\frac{dT}{dx} = 0$.

$$\frac{x}{5\sqrt{x^2 + 16}} - \frac{1}{8} = 0$$

$$\frac{x}{5\sqrt{x^2 + 16}} = \frac{1}{8}$$

$$8x = 5\sqrt{x^2 + 16}$$

$$64x^2 = 25(x^2 + 16)$$

$$64x^2 = 25x^2 + 400$$

$$64x^2 - 25x^2 = 400$$

$$39x^2 = 400$$

$$x = \sqrt{\frac{400}{39}} = 3.2 \text{ km}$$

Therefore, the rower will row to a point that is 3.2 km to the right of point O.

6.6 Exam questions

1 $A = l \times w$

$$= x \times y$$

$$A(x) = x(4 - x^2)$$

$$= 4x - x^3$$

$$\frac{dA}{dx} = 4 - 3x^2 = 0 \text{ for max/min}$$

$$\Rightarrow x^2 = \frac{4}{3} \Rightarrow u = \frac{2}{\sqrt{3}} \text{ since } u > 0$$

$$A_{\text{max}} = A\left(\frac{2}{\sqrt{3}}\right) = \frac{2}{\sqrt{3}} \left(4 - \frac{4}{3}\right) = \frac{16}{3\sqrt{3}} = \frac{16\sqrt{3}}{9}$$

The correct answer is E.

2 a $s(x) = d_{\text{OP}}$

$$= \sqrt{x^2 + y^2}$$

$$= \sqrt{x^2 + (2x - 4)^2}$$

$$= \sqrt{5x^2 - 16x + 16}$$

$$s = (5x^2 - 16x + 16)^{\frac{1}{2}}$$

$$\frac{ds}{dx} = \frac{1}{2}(5x^2 - 16x + 16)^{-\frac{1}{2}} \times (10x - 16)$$

$$= \frac{10x - 16}{2\sqrt{5x^2 - 16x + 16}}$$

Minimum value occurs where $\frac{ds}{dx} = 0$

$$0 = \frac{10x - 16}{2\sqrt{5x^2 - 16x + 16}}$$

$$= 10x - 16$$

$$16 = 10x$$

$$x = \frac{8}{5}$$

$$y = 2 \times \frac{8}{5} - 4$$

$$= -\frac{4}{5}$$

$$P\left(\frac{8}{5}, -\frac{4}{5}\right)$$

Award 1 mark for correctly deriving $\frac{ds}{dx}$.

Award 1 mark for the correct value of x .

Award 1 mark for the correct value of y .

VCAA Examination Report note:

Students who tackled this question by finding an expression for OP in terms of x , then setting the derivative to zero, often had difficulty finding the derivative correctly, which ended up with an incorrect x value. However, most students calculated a y coordinate. Some students opted for a solution by working with similar triangles. A common incorrect response for P was $(2, 0)$, which is the point of intersection of the line $y = 2x - 4$ and the x -axis, while others incorrectly assumed the point P to be midway between the line segment formed by $y = 2x - 4$ and its axial intercepts.

$$\begin{aligned}
 \text{b } s\left(\frac{8}{5}\right) &= \sqrt{\left(\frac{8}{5}\right)^2 + \left(2 \times \frac{8}{5} - 4\right)^2} \\
 &= \sqrt{\left(\frac{8}{5}\right)^2 + \left(-\frac{4}{5}\right)^2} \\
 &= \sqrt{\frac{64 + 16}{25}} \\
 &= \sqrt{\frac{80}{25}} \\
 &= \frac{\sqrt{16 \times 5}}{5} \\
 d_{OP} &= \frac{4\sqrt{5}}{5}
 \end{aligned}$$

Award 1 mark for correctly using the distance formula.

Award 1 mark for the correct answer.

VCAA Examination Report note:

This question was attempted well. Some students misquoted the distance formula or made arithmetic errors in their calculations.

$$\begin{aligned}
 \text{3 } A &= 2 \times A_{\text{triangle}} + A_{\text{rectangle}} \\
 &= 2 \times \frac{1}{2}bh + lw
 \end{aligned}$$

$$b = p \cos(x), \quad h = p \sin(x)$$

$$l = p, \quad w = h = p \sin(x)$$

$$\begin{aligned}
 A &= p \cos(x) \times p \sin(x) + p \times p \sin(x) \\
 &= p^2 (\cos(x) \sin(x) + \sin(x))
 \end{aligned}$$

$$\frac{dA}{dx} = p^2 (2 \cos^2(x) + \cos(x) - 1) = 0$$

$$\text{since } 0 < x < \frac{\pi}{2}, \quad x = \frac{\pi}{3}.$$

The correct answer is **D**.

6.7 Rates of change

6.7 Exercise

1 a By similar triangles,

$$r : 4 \text{ as } h : 12$$

$$\frac{r}{4} = \frac{h}{12}$$

$$r = \frac{1}{3}h$$

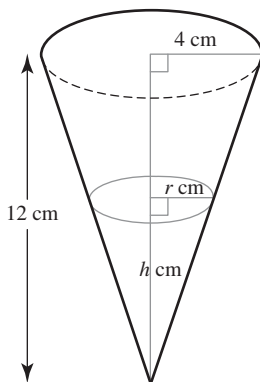

$$\begin{aligned}
 \text{b } V &= \frac{1}{3}\pi r^2 h \\
 V &= \frac{1}{3}\pi \left(\frac{1}{3}h\right)^2 h \\
 V &= \frac{\pi}{27}h^3
 \end{aligned}$$

$$\text{c } \frac{dV}{dh} = \frac{\pi}{9}h^2$$

When $h = 5$ cm,

$$\frac{dV}{dh} = \frac{\pi}{9}(5)^2 = \frac{25\pi}{9} \text{ cm}^3/\text{cm}$$

$$\text{2 a } V_{\text{sphere}} = \frac{4}{3}\pi r^3$$

$$\frac{dV}{dr} = 4\pi r^2$$

When $r = 10$ cm,

$$\frac{dV}{dr} = 4\pi(10)^2 = 400\pi \text{ cm}^3/\text{cm}$$

b $SA_{\text{cube}} = 6x^2$ where x is the side length of the cube.

$$\frac{d(SA)}{dx} = -12x \text{ as the cube is melting.}$$

When $x = 6$ mm,

$$\frac{d(SA)}{dx} = -12(6) = -72 \text{ mm}^2/\text{mm}$$

$$\text{3 } V = \frac{2}{3}t^2(15 - t), \quad 0 \leq t \leq 10$$

$$\text{a } \text{When } t = 10, \quad V = \frac{2}{3}(10)^2(15 - 10) = 333\frac{1}{3} \text{ mL.}$$

$$\text{b } \frac{dV}{dt} = -\frac{2}{3}t^2 + \frac{4}{3}t(15 - t)$$

$$\frac{dV}{dt} = 20t - \frac{4}{3}t^2 - \frac{2}{3}t^2 = 20t - 2t^2$$

c When $t = 3$ seconds,

$$\frac{dV}{dt} = 20(3) - 2(3)^2 = 60 - 18 = 42 \text{ mL/s}$$

d The flow is greatest when $\frac{d}{dx} \left(\frac{dV}{dt} \right) = 0$.

$$\frac{d}{dx} \left(\frac{dV}{dt} \right) = 20 - 4t$$

$$0 = 20 - 4t$$

$$4t = 20$$

$$t = 5$$

$$\text{When } t = 5, \quad \frac{dV}{dt} = 20(5) - 2(5)^2 = 50 \text{ mL/s.}$$

4 a Initially $t = 0$.

$$x = 2(0)^2 - 8(0) = 0$$

The particle is at the origin initially.

$$\text{b } v = \frac{dx}{dt} = 4t - 8$$

c When $t = 0$,

$$v = \frac{dx}{dt} = 4(0) - 8 = -8$$

Initially the particle is moving with a velocity of 8 m/s to the left.

When $v = 0$	When $t = 2$
$0 = 4t - 8$	$x = 2(2)^2 - 8(2)$
$8 = 4t$	$x = -8 \text{ m}$
$2 = t$	

It is at rest after 2 seconds and is 8 metres to the left of the origin.

d When at the origin, $x = 0$.

$$2t^2 - 8t = 0$$

$$2t(t - 4) = 0$$

$$t = 0 \text{ or } t - 4 = 0$$

$$t = 4$$

As expressed in **a** the particle is initially at the origin, then it is there again after 4 seconds.

Initially it is at the origin, then it travels 8 metres to the left, and at $t = 4$ it is back at the origin again, so a total of 16 metres has been travelled.

e Average speed = $\frac{16 - 0}{4 - 0} = 4$ m/s

f Average velocity = $\frac{v_4 - v_0}{4} = \frac{8 - 8}{4} = 0$ m/s

5 a $x(t) = -\frac{1}{3}t^3 + t^2 + 8t + 1$ and $v(t) = -t^2 + 2t + 8$

Initially $t = 0$.

$$x(0) = -\frac{1}{3}(0)^3 + (0)^2 + 8(0) + 1 \text{ and } v(0) = -(0)^2 + 2(0) + 8$$

$$x(0) = 1 \quad v(0) = 8 \text{ m/s}$$

Initially the particle is 1 metre to the right of the origin travelling at 8 metres per second.

b The particle changes its direction of motion when $v = 0$.

$$-t^2 + 2t + 8 = 0$$

$$(4 - t)(2 + t) = 0$$

$$t = 4, -2$$

$$t = 4, t \geq 0$$

$$x(4) = -\frac{1}{3}(4)^3 + (4)^2 + 8(4) + 1 = -\frac{64}{3} + 49$$

$$= -\frac{64}{3} + \frac{147}{3} = 27\frac{2}{3} \text{ m}$$

c $a(t) = \frac{dv}{dt} = -2t + 2$

$$a(4) = -2(4) + 2 = -6 \text{ m/s}^2$$

6 $N = \frac{110}{t}, t > 0$

a $\frac{dN}{dt} = -\frac{110}{t^2}$

When $t = 5$ months,

$$\frac{dN}{dt} = -\frac{110}{(5)^2} = -4.4 \text{ rabbits per month.}$$

The population is decreasing at 4.4 rabbits per month.

b When $t = 1$, $N = 110$ and when $t = 5$, $N = 22$

The average rate of change is

$$\frac{22 - 110}{5 - 1} = -\frac{88}{4} = -22 \text{ rabbits/month.}$$

c As $t \rightarrow \infty$, $N \rightarrow 0$, so the rabbit population will effectively reach zero in the long run.

7 $V = 0.4(8 - t)^3, 0 \leq t \leq 8$

a $\frac{dV}{dt} = -1.2(8 - t)^2$

When $t = 3$ minutes,

$$\frac{dV}{dt} = -1.2(8 - 3)^2 = -30 \text{ litres/min}$$

Water is leaving the bath at a rate of 30 L/min.

b When $t = 0$, $V = 0.4(8)^3 = 204.8$ and when $t = 3$, $V = 0.4(5)^3 = 50$.

The average rate of change is

$$\frac{204.8 - 50}{3 - 0} = -51.6 \text{ litres/minute.}$$

c $\frac{dV}{dt} = R(x)$

$$R'(x) = 0$$

$$R'(x) = -2.4(8 - t) \times -1$$

$$0 = 2.4(8 - t)$$

$$t = 8$$

$t = 8$ corresponds to a minimum; therefore, the maximum rate is when $t = 0$.

The rate of water leaving is greatest at the beginning, which is when $t = 0$.

8 $h = 50t - 4t^2$

a $\frac{dh}{dt} = 50 - 8t$

When $t = 3$ seconds,

$$\frac{dh}{dt} \Big|_{t=3} = 50 - 8(3) = 50 - 24 = 26 \text{ m/s}$$

b When $t = 5$ seconds,

$$v_{t=5} = \frac{dh}{dt} = 50 - 8(5) = 10 \text{ m/s}$$

c When $v = -12$ m/s,

$$-12 = 50 - 8t$$

$$8t = 62$$

$$t = 7.75$$

After 7.75 seconds the velocity of the ball is 12 m/s and it is travelling downwards.

d When $v = 0$,

$$50 - 8t = 0$$

$$8t = 50$$

$$t = 6.25 \text{ seconds}$$

The velocity is zero after 6.25 seconds.

e The greatest height is obtained when the velocity is zero.

$$h_{t=6.25} = 50(6.25) - 4(6.25)^2 = 156.25 \text{ metres}$$

f When the ball strikes the ground, $h = 0$.

$$0 = 50t - 4t^2$$

$$0 = 25t - 2t^2$$

$$0 = t(25 - 2t)$$

$$t = 0 \text{ or } 25 - 2t = 0$$

Initially $2t = 25$

$$t = 12.5$$

The ball strikes the ground after 12.5 seconds.

$$v_{t=12.5} = 50 - 8(12.5) = -50 \text{ m/s}$$

The ball hits the ground with a speed of 50 m/s.

9 $N(t) = \frac{2t}{(t + 0.5)^2} + 0.5$

a Initially $t = 0$.

$$N(0) = \frac{2(0)}{(0 + 0.5)^2} + 0.5 = 0.5 \text{ hundred thousand or } 50 \text{ thousand}$$

b $N(t) = \frac{2t}{(t + 0.5)^2} + 0.5$

Let $u = 2t$ and $v = (t + 0.5)^2$.

$$\frac{du}{dt} = 2 \quad \frac{dv}{dt} = 2(t + 0.5) = 2t + 1$$

$$\begin{aligned}
 N'(t) &= \frac{v \frac{du}{dt} - u \frac{dv}{dt}}{v^2} \\
 &= \frac{2(t+0.5)^2 - 2t(2t+1)}{(t+0.5)^4} \\
 &= \frac{2t^2 + 2t + 0.5 - 4t^2 - 2t}{(t+0.5)^4} \\
 &= \frac{-2t^2 + 0.5}{(t+0.5)^4}
 \end{aligned}$$

c The maximum number of viruses occurs when $\frac{dN}{dt} = 0$.

$$\frac{-2t^2 + 0.5}{(t+0.5)^4} = 0$$

$$-2t^2 + 0.5 = 0$$

$$2t^2 = 0.5$$

$$t^2 = 0.25$$

$$t = 0.5, \quad t \geq 0$$

$$N(1) = \frac{2(0.5)}{(0.5+0.5)^2} + 0.5 = 150\,000 \text{ after half an hour}$$

d When $t = 10$,

$$\frac{dN}{dt} \Big|_{t=10} = \frac{-2(10)^2 + 0.5}{(10+0.5)^4} = -\frac{199.5}{10.5^4} = -0.01641$$

After 10 hours the viruses were changing at a rate of -1641 viruses per hour

10 $N = 220 - \frac{150}{t+1}$

a When $N = 190$

$$190 = 220 - \frac{150}{t+1}$$

$$220 - 190 = \frac{150}{t+1}$$

$$30(t+1) = 150$$

$$t+1 = 5$$

$$t = 4$$

$$\frac{dN}{dt} = \frac{150}{(t+1)^2}$$

$$t = 4, \quad \frac{dN}{dt} = \frac{150}{(4+1)^2}$$

$$= \frac{150}{25}$$

$$= 6$$

Therefore, after 4 years, butterflies are growing at a rate of 6 butterflies per year.

b The growth rate is 12 butterflies per year.

$$\frac{dN}{dt} = \frac{150}{(t+1)^2}$$

$$12 = \frac{150}{(t+1)^2}$$

$$12(t+1)^2 = 150$$

$$(t+1)^2 = 12.5$$

$$t+1 = 3.54, \quad t \geq 0$$

$$t = 2.54 \text{ years}$$

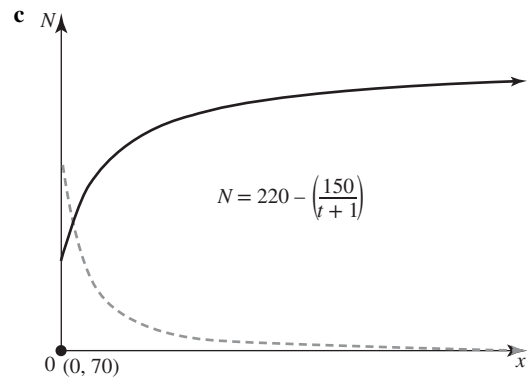

As $t \rightarrow \infty$, $N \rightarrow 220$ and $\frac{dN}{dt} \rightarrow 0$.

11 $x(t) = 2t^2 - 16t - 18, \quad t \leq 0$

a When $t = 2$ seconds,

$$x(2) = 2(2)^2 - 16(2) - 18 = -42$$

The particle is 42 metres to the left of the origin.

b $\frac{dv}{dt} = 4t - 16$

When $t = 2$ seconds,

$$\frac{dv}{dt} \Big|_{t=2} = 4(2) - 16 = -8$$

The speed is 8 m/s.

c When $t = 0$, $\frac{dv}{dt} = -16$ and when $t = 2$, $\frac{dv}{dt} = -8$.

The average velocity is $\frac{-16 + -8}{2 - 0} = -12$ m/s

d When $x(t) = 0$,

$$2t^2 - 16t - 18 = 0$$

$$t^2 - 8t - 9 = 0$$

$$(t-9)(t+1) = 0$$

$$t-9 = 0$$

$$t = 9 \text{ as } t \geq 0$$

$$\frac{dv}{dt} \Big|_{t=9} = 4(9) - 16 = 20 \text{ m/s}$$

Therefore, it reaches O after 9 seconds at 20 m/s.

12 $x = \frac{2}{3}t^3 - 4t^2, \quad t \geq 0$

a $v = \frac{dx}{dt} = 2t^2 - 8t$

When $t = 0$,

$$x_{t=0} = \frac{2}{3}(0)^3 - 4(0)^2 = 0$$

$$v_{t=0} = 2(0)^2 - 8(0) = 0$$

The particle starts from rest at the origin.

b When $v = 0$,

$$2t^2 - 8t = 0$$

$$t^2 - 4t = 0$$

$$t(t-4) = 0$$

$$t = 0 \text{ or } t - 4 = 0$$

$$\text{Initially } t = 4$$

$$x_{t=4} = \frac{2}{3}(4)^3 - 4(4)^2 = \frac{128}{3} - \frac{192}{3} = -\frac{64}{3} = -21\frac{1}{3}$$

The velocity is zero after 4 seconds when the particle is $21\frac{1}{3}$ metres to the left of the origin.

c When $x = 0$,

$$\frac{2}{3}t^3 - 4t^2 = 0$$

$$t^2 \left(\frac{2}{3}t - 4 \right) = 0$$

$$t = 0 \text{ or } \frac{2}{3}t - 4 = 0$$

$$\text{Initially } \frac{2}{3}t = 4$$

$$t = 6$$

The particle is at the origin again after 6 seconds.

d When $t = 6$ seconds,

$$v_{t=6} = 2(6)^2 - 8(6) = 72 - 48 = 24 \text{ m/s}$$

$$a = \frac{dv}{dt} = 4t - 8$$

$$a_{t=6} = 4(6) - 8 = 24 - 8 = 16 \text{ m/s}^2$$

At the origin the particle's speed is 24 m/s and its acceleration is 16 m/s².

13 a

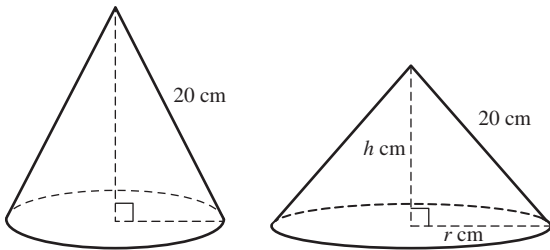

By Pythagoras,

$$r^2 + h^2 = 20^2$$

$$r^2 = 400 - h^2$$

$$r = \sqrt{400 - h^2}, \quad r > 0$$

b $V = \frac{1}{3}\pi r^2 h$

$$V = \frac{1}{3}\pi (400 - h^2) h$$

$$V = \frac{400\pi h}{3} - \frac{\pi h^3}{3}$$

c $\frac{dV}{dh} = \frac{400\pi}{3} - \pi h^2$

When $h = 8$ cm,

$$\frac{dV}{dh} = \frac{400\pi}{3} - \pi(8)^2$$

$$\frac{dV}{dh} = \frac{400\pi}{3} - \frac{192\pi}{3} = \frac{208\pi}{3} \text{ cm}^3/\text{cm}$$

14

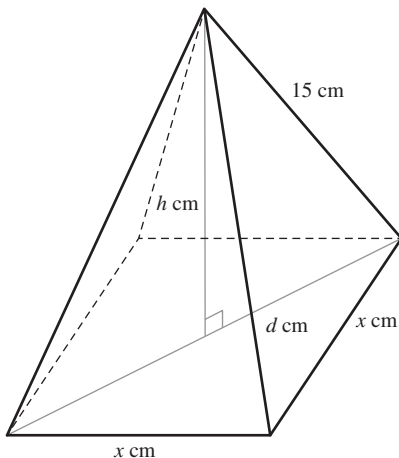

a $V = \frac{1}{3}x^2 h$

By Pythagoras,

$$d^2 = x^2 + x^2$$

$$d^2 = 2x^2$$

$$d = \sqrt{2}x \text{ m}, \quad x > 0$$

b By Pythagoras,

$$12^2 = h^2 + \left(\frac{\sqrt{2}}{2}x \right)^2$$

$$144 = h^2 + \frac{1}{2}x^2$$

$$144 - h^2 = \frac{1}{2}x^2$$

$$288 - 2h^2 = x^2 \text{ as required}$$

$$V = \frac{1}{3}x^2 h$$

$$V = \frac{1}{3}(288 - 2h^2) h$$

$$V = \frac{1}{3}(288h - 2h^3)$$

c $\frac{dV}{dh} = \frac{1}{3}(288 - 6h^2)$

When $h = 3\sqrt{3}$ metres,

$$\frac{dV}{dh} = \frac{1}{3}(288 - 6(3\sqrt{3})^2)$$

$$= \frac{1}{3}(288 - 6 \times 27)$$

$$= \frac{126}{3}$$

$$= 42 \text{ m}^3/\text{m}$$

15 $V_{\text{cone}} = \frac{1}{3}\pi r^2 h$

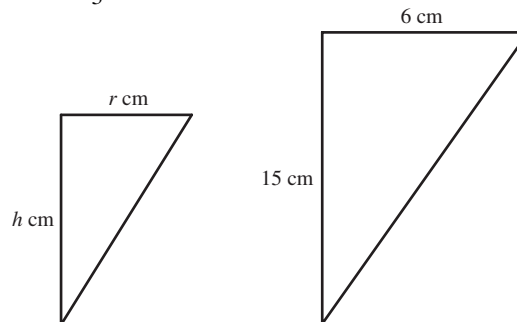

By similar triangles, $r : 6$ as $h : 15$.

$$V_{\text{cone}} = \frac{1}{3}\pi \left(\frac{2h}{5} \right)^2 h$$

$$V = \frac{4\pi}{25}h^3$$

$$\frac{dV}{dh} = \frac{4\pi}{25}h^2$$

a When $h = \frac{15}{2}$,

$$\frac{dV}{dh} = \frac{4\pi}{25} \left(\frac{15}{2} \right)^2 = 9\pi \text{ cm}^3/\text{cm}$$

b The container is one-third full. When full, the volume is $180\pi \text{ cm}^3$, so one-third will be $60\pi \text{ cm}^3$.

$$60\pi = \frac{1}{3}\pi \left(\frac{2h}{5}\right)^2 h$$

$$180 = \frac{4}{25}h^3$$

$$180 \times \frac{25}{4} = h^3$$

$$h^3 = 1125$$

$$h = 5 \times 3^{\frac{2}{3}}$$

$$\frac{dV}{dh} = \frac{4\pi}{25} \left(5 \times 3^{\frac{2}{3}}\right)^2 = 12 \times 3^{\frac{1}{3}}\pi \text{ cm}^3/\text{cm}$$

$$16 \text{ a } y = \frac{3t}{(4+t^2)}$$

Let $u = 3t$ and $v = 4 + t^2$.

$$\frac{du}{dt} = 3 \quad \frac{dv}{dt} = 2t$$

$$\frac{dy}{dt} = \frac{v \frac{du}{dt} - u \frac{dv}{dt}}{v^2}$$

$$\frac{dy}{dt} = \frac{3(4+t^2) - 3t(2t)}{(4+t^2)^2}$$

$$\frac{dy}{dt} = \frac{12 + 3t^2 - 6t^2}{(4+t^2)^2}$$

$$\frac{dy}{dt} = \frac{12 - 3t^2}{(4+t^2)^2}$$

$$\frac{dy}{dt} = \frac{3(4-t^2)}{(4+t^2)^2}$$

b The maximum concentration of painkiller in the blood occurs when $\frac{dy}{dt} = 0$.

$$0 = \frac{3(4-t^2)}{(4+t^2)^2}$$

$$0 = 3(4-t^2)$$

$$0 = 4-t^2$$

$$t = 2, -2$$

$$t = 2, \quad t > 0$$

$$t = 2, \quad y = \frac{3(2)}{(4+2^2)} = 0.75 \text{ mg/L}$$

Therefore, the maximum concentration is 0.75 mg/L after 2 hours.

$$c \quad 0.5 = \frac{3t}{(4+t^2)}$$

$$2 + \frac{1}{2}t^2 = 3t$$

$$t^2 - 6t + 2 = 0$$

$$t = \frac{6 \pm \sqrt{(6)^2 - (4)(1)(2)}}{2(1)}$$

$$t = \frac{6 \pm \sqrt{36 - 16}}{2}$$

$$t = \frac{6 + 2\sqrt{5}}{2} \approx 5.24 \text{ hours} \quad (t > 2)$$

$$d \quad \frac{dy}{dt} \Big|_{t=1} = \frac{3(4-1^2)}{(4+1^2)^2}$$

$$\frac{dy}{dt} \Big|_{t=1} = \frac{9}{25}$$

$$\frac{dy}{dt} \Big|_{t=1} = 0.36 \text{ mg/L/h}$$

$$e \quad \frac{dy}{dt} = \frac{3(4-t^2)}{(4+t^2)^2}$$

$$-0.06 = \frac{3(4-t^2)}{(4+t^2)^2}$$

$$t = 2.45 \text{ and } 6 \text{ hours}$$

(solved on CAS)

6.7 Exam questions

$$1 \quad f: R \setminus \{4\} \rightarrow R, \quad f(x) = \frac{a}{x-4}$$

$$f(8) = \frac{a}{4}, \quad f(6) = \frac{a}{2}$$

$$\frac{f(8) - f(6)}{8 - 6} = \frac{\frac{a}{4} - \frac{a}{2}}{2}$$

$$= \frac{1}{2} \left(\frac{a - 2a}{4} \right) = -\frac{a}{8}$$

The correct answer is **E**.

$$2 \quad f(x) = x^2 - 2x$$

$$f(a) = a^2 - 2a, \quad f(1) = 1 - 2 = -1$$

$$\frac{f(a) - f(1)}{a - 1} = \frac{a^2 - 2a + 1}{a - 1} = \frac{(a-1)^2}{a-1} = a-1$$

Since $a > 1$,

$$a - 1 = 8 \Rightarrow a = 9$$

The correct answer is **A**.

$$3 \quad y = 2e^{-x+1} \sin(x-1)$$

Using the product rule:

$$\begin{aligned} \frac{dy}{dx} &= u \frac{dv}{dx} + v \frac{du}{dx} \\ &= 2e^{-x+1} \cos(x-1) - 2e^{-x+1} \sin(x-1) \\ &= 2e^{-x+1} (\cos(x-1) - \sin(x-1)) \end{aligned}$$

When $x = 1$,

$$\begin{aligned} \frac{dy}{dx} &= 2e^0 (\cos(0) - \sin(0)) \\ &= 2(1 - 0) \\ &= 2 \end{aligned}$$

The correct answer is **D**.

6.8 Newton's method

6.8 Exercise

$$1 \quad f(x) = x^3 + x - 5$$

$$f'(x) = 3x^2 + 1$$

$$x_1 = 1 - \frac{f(1)}{f'(1)}$$

$$\begin{aligned}\therefore x_1 &= 1 - \frac{(-3)}{4} \\ &= 1.75\end{aligned}$$

$$\begin{aligned}x_2 &= \text{Ans} - \frac{f(\text{Ans})}{f'(\text{Ans})} \\ &= 1.542\,944\,79\end{aligned}$$

$$\begin{aligned}x_3 &= \text{Ans} - \frac{f(\text{Ans})}{f'(\text{Ans})} \\ &= 1.516\,391\,18\end{aligned}$$

$$\begin{aligned}x_4 &= \text{Ans} - \frac{f(\text{Ans})}{f'(\text{Ans})} \\ &= 1.515\,980\,33\end{aligned}$$

$$\begin{aligned}x_5 &= \text{Ans} - \frac{f(\text{Ans})}{f'(\text{Ans})} \\ &= 1.515\,980\,23\end{aligned}$$

Therefore, $x = 1.5160$ (4 d.p.).

2 Let $f(x) = x^3 - 6x - 12$.

$$\begin{aligned}f(1) &= 1^3 - 6(1) - 12 \\ &= -17 \\ &< 0\end{aligned}$$

$$\begin{aligned}f(2) &= 2^3 - 6(2) - 12 \\ &= -16 \\ &< 0\end{aligned}$$

$$\begin{aligned}f(3) &= 3^3 - 6(3) - 12 \\ &= -3 \\ &< 0\end{aligned}$$

$$\begin{aligned}f(4) &= 4^3 - 6(4) - 12 \\ &= 28 \\ &> 0\end{aligned}$$

As there is a sign change between $x = 3$ and $x = 4$, the solution to the equation must lie between these values. Most likely it is closer to 3, as $f(3)$ is closer to 0 than $f(4)$.

Let $x_0 = 3$.

$$f(x) = x^3 - 6x - 12$$

$$f'(x) = 3x^2 - 6$$

$$x_1 = 3 - \frac{f(3)}{f'(3)}$$

$$\begin{aligned}\therefore x_1 &= 3 - \frac{-3}{21} \\ &= 3.142\,857\,14\end{aligned}$$

$$\begin{aligned}x_2 &= \text{Ans} - \frac{f(\text{Ans})}{f'(\text{Ans})} \\ &= 3.134\,961\,76\end{aligned}$$

$$\begin{aligned}x_3 &= \text{Ans} - \frac{f(\text{Ans})}{f'(\text{Ans})} \\ &= 3.134\,936\,75\end{aligned}$$

Therefore, $x = 3.135$ (3 d.p.).

3 $f(x) = 2 \log_e(x - 2) + 1$

$$f'(x) = \frac{2}{x-2}$$

The x -intercept for $f(x) = 2 \log_e(x - 2)$ is $x = 3$, so if the function is translated up 1 unit, the root will be located in the interval $(2, 3]$.

Start with $x_0 = 2.5$.

$$x_1 = 2.5 - \frac{f(2.5)}{f'(2.5)}$$

$$\begin{aligned}\therefore x_1 &= 2.5 - \frac{2 \log_e(0.5) + 1}{\frac{2}{0.5}} \\ &= 2.596\,573\,6\end{aligned}$$

$$x_2 = \text{Ans} - \frac{f(\text{Ans})}{f'(\text{Ans})}$$

$$= 2.606\,448\,48$$

$$x_3 = \text{Ans} - \frac{f(\text{Ans})}{f'(\text{Ans})}$$

$$= 2.606\,530\,7$$

$$x_4 = \text{Ans} - \frac{f(\text{Ans})}{f'(\text{Ans})}$$

$$= 2.606\,530\,7$$

Therefore, $x = 2.607$ (3 d.p.).

4 If $x^3 = 10$, then $x = \sqrt[3]{10}$.

$$\therefore f(x) = x^3 - 10$$

$$f'(x) = 3x^2$$

As $2^3 = 8$ and $3^3 = 27$, the solution to $x = \sqrt[3]{10}$ lies between 2 and 3, and closer to 2.

Let $x_0 = 2$.

$$x_1 = 2 - \frac{f(2)}{f'(2)}$$

$$\begin{aligned}\therefore x_1 &= 2 - \frac{(-2)}{12} \\ &= 2.166\,666\,7\end{aligned}$$

$$x_2 = \text{Ans} - \frac{f(\text{Ans})}{f'(\text{Ans})}$$

$$= 2.154\,504$$

$$x_3 = \text{Ans} - \frac{f(\text{Ans})}{f'(\text{Ans})}$$

$$= 2.154\,434$$

Therefore, $\sqrt[3]{10} = 2.15$ (2 d.p.).

5 $f(x) = \cos(3x) - \sin(x)$

$$f'(x) = -3 \sin(3x) - \cos(x)$$

$$x_0 = 0$$

$$x_1 = 0 - \frac{f(0)}{f'(0)}$$

$$\begin{aligned}\therefore x_1 &= 0 - \frac{\cos(0) - \sin(0)}{-3 \sin(0) - \cos(0)} \\ &= 1\end{aligned}$$

$$x_2 = \text{Ans} - \frac{f(\text{Ans})}{f'(\text{Ans})}$$

$$= -0.900\,524$$

$$x_3 = \text{Ans} - \frac{f(\text{Ans})}{f'(\text{Ans})}$$

$$= -0.716\,125$$

The correct answer is **B**.

6 $f(x) = e^x - 2x^2 - 5$

$$f'(x) = e^x - 4x$$

Let $x_0 = 3$.

$$x_1 = 3 - \frac{f(3)}{f'(3)}$$

$$\begin{aligned}\therefore x_1 &= 3 - \frac{(-2)}{12} \\ &= 3.360\,453\,9\end{aligned}$$

$$x_2 = \text{Ans} - \frac{f(\text{Ans})}{f'(\text{Ans})}$$

$$= 3.281\,227$$

$$x_3 = \text{Ans} - \frac{f(\text{Ans})}{f'(\text{Ans})}$$

$$= 3.275\,628$$

$$x_4 = \text{Ans} - \frac{f(\text{Ans})}{f'(\text{Ans})}$$

$$= 3.275\ 601\ 09$$

Therefore, $x = 3.276$ (3 d.p.).

6.8 Exam questions

1 $f(x) = 2 - x^2 - \sin(x)$
 $f'(x) = -2x - \cos(x)$ [1 mark]

Let $x_0 = 1$.
 $x_1 = 1 - \frac{f(1)}{f'(1)}$
 $\therefore x_1 = 1 - \frac{(1 - \sin(1))}{-2 - \cos(1)}$
 $= 1.062\ 406$

$x_2 = \text{Ans} - \frac{f(\text{Ans})}{f'(\text{Ans})}$
 $= 1.061\ 549\ 9$
 Therefore, $x = 1.062$ (3 d.p.) [1 mark]

2 If $x^4 = 12$, then $x = \sqrt[4]{12}$.
 $\therefore f(x) = x^4 - 12$
 $f'(x) = 4x^3$ [1 mark]

As $1^4 = 1$ and $2^4 = 16$, the solution to $x = \sqrt[4]{12}$ lies between 1 and 2, and closer to 2. [1 mark]

Let $x_0 = 2$.
 $x_1 = 2 - \frac{f(2)}{f'(2)}$
 $\therefore x_1 = 2 - \frac{4}{32}$
 $= 1.875$

$x_2 = \text{Ans} - \frac{f(\text{Ans})}{f'(\text{Ans})}$
 $= 1.861\ 361\ 1$

$x_3 = \text{Ans} - \frac{f(\text{Ans})}{f'(\text{Ans})}$
 $= 1.861\ 209\ 74$

Therefore, $\sqrt[4]{12} = 1.86$ (2 d.p.) [1 mark]

3 Let $f(x) = x^4 - 5x - 8$.
 $f(0) = 0^4 - 5(0) - 8$
 $= -8$
 < 0
 $f(-1) = (-1)^4 - 5(-1) - 8$
 $= -2$
 < 0
 $f(-2) = (-2)^4 - 5(-2) - 8$
 $= 18$
 > 0

As there is a sign change between $x = -1$ and $x = -2$, the solution to the equation must lie between these values. Most likely it is closer to -1 , as $f(-1)$ is closer to 0 than $f(-2)$.

[1 mark]
 Let $x_0 = -1$.
 $f(x) = x^4 - 5x - 8$
 $f'(x) = 4x^3 - 5$ [1 mark]

$x_1 = -1 - \frac{f(-1)}{f'(-1)}$
 $\therefore x_1 = -1 - \frac{-3}{21}$
 $= -1.222\ 222$

$x_2 = \text{Ans} - \frac{f(\text{Ans})}{f'(\text{Ans})}$
 $= -1.194\ 373\ 21$

$x_3 = \text{Ans} - \frac{f(\text{Ans})}{f'(\text{Ans})}$
 $= -1.193\ 793\ 76$

Therefore, $x = -1.194$ (3 d.p.) [1 mark]

6.9 Review

6.9 Exercise

Technology free: short answer

1 a $y = ax \cos(3x)$

$$\frac{dy}{dx} = -3ax \sin(3x) + a \cos(3x)$$

When $x = \pi$, $\frac{dy}{dx} = -3a\pi \sin(3\pi) + a \cos(3\pi) = -a$

$\therefore -a = -5$

$\therefore a = 5$

b $y = 5x \cos(3x)$

$$\frac{dy}{dx} = -15x \sin(3x) + 5 \cos(3x)$$

When $x = \frac{\pi}{3}$, $y = 5 \times \frac{\pi}{3} \cos(\pi) = -\frac{5\pi}{3}$

and $\frac{dy}{dx} = -15 \times \frac{\pi}{3} \sin\left(3 \times \frac{\pi}{3}\right) + 5 \cos\left(3 \times \frac{\pi}{3}\right) = -5$

$m_T = -5$

$m_P = \frac{1}{5}$

$\therefore y = \frac{1}{5}x + c$

The value of c can be determined by substituting in the

point $\left(\frac{\pi}{3}, -\frac{5\pi}{3}\right)$.

$$-\frac{5\pi}{3} = \frac{\pi}{15} + c$$

$$c = -\frac{26\pi}{15}$$

$$\therefore y = \frac{1}{5}x - \frac{26\pi}{15}$$

2 a $f(x) = 4x^3 - 6x^2 + 3$

$f(0) = 3$

$f(2) = 11$

The end points are therefore (0, 3) and (2, 11).

b $f(x) = 4x^3 - 6x^2 + 3$

$f'(x) = 12x^2 - 12x$

$12x^2 - 12x = 0$

$12x(x - 1) = 0$

$x = 0, 1$

$f(0) = 3$

$f(1) = 1$

The stationary points are therefore (0, 3) and (1, 1).

To determine the nature of the stationary points, the gradient of the curve on either side of these points must be found.

x	-1	0	$\frac{1}{2}$	1	3
$f'(x)$	24	0	-3	0	72
	/	—	\	—	/

The point (0, 3) is a maximum turning point, and (1, 1) is a minimum turning point.

- c With the coordinates of the end points and stationary points, the graph can be sketched.

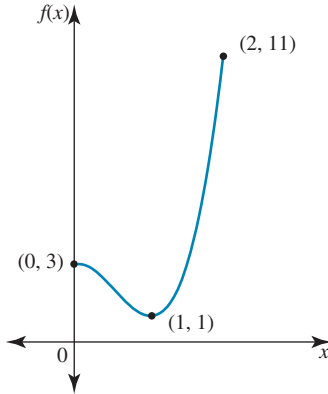

- d The absolute minimum occurs where the value of the y -coordinate is less than any other y -coordinate of the function. The absolute maximum occurs where the value of the y -coordinate is greater than any other y -coordinate of the function. The function has an absolute minimum of 1 and an absolute maximum of 11, which can be seen from the graph in part c.

- 3 a Average rate of change

$$\begin{aligned} &= \frac{f(x_2) - f(x_1)}{x_2 - x_1} \\ &= \frac{f(2) - f(0)}{2 - 0} \\ &= \frac{13 - 5}{2} \\ &= 4 \end{aligned}$$

- b A function is strictly increasing over an interval if, for every increasing x -value in the interval, the function increases also. Hence, the function is strictly increasing over the domain $x \in [-1, 0] \cup [1, 2]$.

- 4 a $f(x) = 6 \log_e(x^2 - 4x + 8)$

$$\begin{aligned} f'(x) &= 6 \times \frac{2x - 4}{x^2 - 4x + 8} \\ &= \frac{12(x - 2)}{x^2 - 4x + 8} \end{aligned}$$

$f(x)$ has a stationary point when $f'(x) = 0$:

$$\begin{aligned} f'(x) &= 0 \\ \frac{12(x - 2)}{x^2 - 4x + 8} &= 0 \\ 12(x - 2) &= 0 \\ x &= 2 \end{aligned}$$

When $x = 2$,

$$\begin{aligned} f(2) &= 6 \log_e(2^2 - 4 \times 2 + 8) \\ &= 6 \log_e(4 - 8 + 8) \\ &= 6 \log_e(4) \\ &= 6 \log_e(2^2) \\ &= 12 \log_e(2) \\ &\Rightarrow (2, 12 \log_e(2)) \end{aligned}$$

$$\begin{aligned} \text{b } f'(1) &= \frac{12(1 - 2)}{1^2 - 4(1) + 8} \\ &= \frac{-12}{5} \end{aligned}$$

$$\begin{aligned} f'(3) &= \frac{12(3 - 2)}{3^2 - 4(3) + 8} \\ &= \frac{12}{5} \end{aligned}$$

x	1	2	3
$f'(x)$	$-\frac{12}{5}$	0	$\frac{12}{5}$
Slope	\	—	/

Therefore, there is a local maximum at $x = 2$.

- 5 a $f(x) = \sqrt{x^2 - 1}$ and $g(x) = x + 3$

$$f(g(x)) = f(x + 3)$$

$$f(g(x)) = \sqrt{(x + 3)^2 - 1}$$

$$f(g(x)) = \sqrt{x^2 + 6x + 9 - 1}$$

$$f(g(x)) = \sqrt{x^2 + 6x + 8}$$

$$f(g(x)) = \sqrt{(x + 2)(x + 4)}$$

If $f(g(x)) = \sqrt{(x + m)(x + n)} = \sqrt{(x + 2)(x + 4)}$, then $m = 2$ and $n = 4$.

- b $h(x) = f(g(x)) = \sqrt{x^2 + 6x + 8} = (x^2 + 6x + 8)^{\frac{1}{2}}$

$$h'(x) = \frac{1}{2}(2x + 6)(x^2 + 6x + 8)^{-\frac{1}{2}}$$

$$h'(x) = \frac{x + 3}{\sqrt{x^2 + 6x + 8}} = \frac{x + 3}{\sqrt{(x + 2)(x + 4)}}$$

- 6 a $f(x) = x^4 e^{-3x}$

$$f'(x) = 4x^3 e^{-3x} - 3x^4 e^{-3x}$$

$$f'(x) = e^{-3x}(4x^3 - 3x^4)$$

If $f'(x) = e^{-3x}(mx^4 + nx^3) = e^{-3x}(-3x^4 + 4x^3)$, then $m = -3$ and $n = 4$.

- b Stationary points occur where $f'(x) = 0$.

$$e^{-3x}(4x^3 - 3x^4) = 0$$

$$x^3(4 - 3x) = 0 \text{ as } e^{-3x} > 0 \text{ for all } x$$

$$x = 0 \text{ or } 4 - 3x = 0$$

$$4 = 3x$$

$$x = \frac{4}{3}$$

When $x = 0$, $y = 0$, so (0, 0) is a stationary point.

When $x = \frac{4}{3}$, $y = \left(\frac{4}{3}\right)^4 e^{-3 \times \frac{4}{3}} = \frac{256}{81e^4}$, so $\left(\frac{4}{3}, \frac{256}{81e^4}\right)$ is a stationary point.

Technology active: multiple choice

- 7 $y = e^{3 \cos(5x)}$

$$\frac{dy}{dx} = -15 \sin(5x) e^{3 \cos(5x)}$$

The correct answer is C.

$$8 \quad y = e^{ax} \sin(bx)$$

$$\frac{dy}{dx} = ae^{ax} \sin(bx) + be^{ax} \cos(bx)$$

The correct answer is **A**.

$$9 \quad y = \frac{\cos(7t)}{t^2}$$

Let $u = \cos(7t)$ and $v = t^2$, so $\frac{du}{dt} = -7 \sin(7t)$ and $\frac{dv}{dt} = 2t$.

$$\frac{dy}{dx} = \frac{v \frac{du}{dx} - u \frac{dv}{dx}}{v^2}$$

$$\frac{dy}{dx} = \frac{-7t^2 \sin(7t) - 2t \cos(7t)}{t^4}$$

The correct answer is **A**.

$$10 \quad y = x \log_e(5x)$$

$$\frac{dy}{dx} = 1 \times \log_e(5x) + x \times \frac{1}{x}$$

$$= \log_e(5x) + 1$$

The correct answer is **C**.

$$11 \quad y = f(e^{4x})$$

$$\frac{dy}{dx} = 4e^{4x} f'(e^{4x})$$

The correct answer is **C**.

$$12 \quad y = \sqrt{7 - 2f(x)} = (7 - 2f(x))^{\frac{1}{2}}$$

$$\frac{dy}{dx} = \frac{1}{2} \times -2f'(x)(7 - 2f(x))^{-\frac{1}{2}}$$

$$\frac{dy}{dx} = -\frac{f'(x)}{(7 - 2f(x))^{\frac{1}{2}}} = -\frac{f'(x)}{\sqrt{7 - 2f(x)}}$$

The correct answer is **E**.

$$13 \quad f(x) = x^3 + 2x^2 - 15x + 7$$

$$f'(x) = 3x^2 + 4x - 15$$

To find the stationary points, let $f'(x) = 0$. This can be solved using CAS to give $x = -3, \frac{5}{3}$.

$$f(3) = 43$$

$$f\left(\frac{5}{3}\right) = -\frac{211}{27}$$

The stationary points are therefore $(-3, 43)$ and

$$\left(\frac{5}{3}, -\frac{211}{27}\right).$$

The correct answer is **A**.

14 The absolute maximum of a function is the point at which the y -coordinate is greater than any other point on the graph. In this case, the absolute maximum is 3.

The correct answer is **C**.

$$15 \quad y = f(x) = (x - a)^3 g(x)$$

$$\frac{dy}{dx} = 3(1)(x - a)^2 g(x) + (x - a)^3 g'(x)$$

The correct answer is **E**.

$$16 \quad f(x) = x \cos(x) - x^2$$

$$f'(x) = -x \sin(x) + \cos(x) - 2x$$

Let $x_0 = 1$.

$$x_1 = 1 - \frac{f(1)}{f'(1)}$$

$$\therefore x_1 = 1 - \frac{\cos(1) - 1}{-\sin(1) + \cos(1) - 2}$$

$$= 0.800\ 233$$

$$x_2 = \text{Ans} - \frac{f(\text{Ans})}{f'(\text{Ans})}$$

$$= 0.744\ 094$$

The correct answer is **D**.

Technology active: extended response

$$17 \text{ a} \quad h = 10 \cos\left(\frac{\pi(x - 67)}{100}\right) + 5$$

$$\frac{dh}{dx} = -\frac{\pi}{100} \times 10 \sin\left(\frac{\pi(x - 67)}{100}\right)$$

$$= -\frac{\pi}{10} \sin\left(\frac{\pi(x - 67)}{100}\right)$$

b Max/min values occur when $\frac{dh}{dx} = 0$

$$-\frac{\pi}{10} \sin\left(\frac{\pi(x - 67)}{100}\right) = 0$$

$$\sin\left(\frac{\pi(x - 67)}{100}\right) = 0$$

$$\frac{\pi(x - 67)}{100} = 0, \pi$$

$$x - 67 = 0, \frac{100}{\pi} \times \pi$$

$$x - 67 = 0, 100$$

$$x = 67, 167$$

When $x = 67$,

$$h = 10 \cos\left(\frac{\pi(67 - 67)}{100}\right) + 5$$

$$h = 10 \cos(0) + 5 = 15$$

Maximum at $(67, 15)$

When $x = 167$,

$$h = 10 \cos\left(\frac{\pi(167 - 67)}{100}\right) + 5$$

$$h = 10 \cos(\pi) + 5 = -10 + 5 = -5$$

Minimum at $(167, -5)$

The maximum height above the platform is 15 m and the minimum height is 5 m.

These answers could also have been found using a graph page on CAS.

c i When $x = 50$,

$$\frac{dh}{dx} = -\frac{\pi}{10} \sin\left(\frac{-17\pi}{100}\right) = 0.16$$

ii When $x = 100$,

$$\frac{dh}{dx} = -\frac{\pi}{10} \sin\left(\frac{67\pi}{100}\right) = -0.27$$

$$18 \text{ a} \quad \sin(x) = \frac{h}{20} \text{ so } 20 \sin(x) = h$$

$$\text{b} \quad \cos(x) = \frac{b_1}{20} \text{ so } 20 \cos(x) = b_1$$

$$b = 2b_1 + 10 = 40 \cos(x) + 10$$

$$\text{c} \quad A = \frac{1}{2}(40 \cos(x) + 10 + 10) \times 20 \sin(x)$$

$$= 10 \sin(x)(40 \cos(x) + 20)$$

$$= 200 \sin(x)(2 \cos(x) + 1) \text{ as required}$$

$$\text{d} \quad \frac{dA}{dx} = 200 \cos(x)(2 \cos(x) + 1) - 400 \sin(x) \sin(x)$$

$$= 400 \cos^2(x) - 400 \sin^2(x) + 200 \cos(x)$$

$$= 400 \cos^2(x) - 400(1 - \cos^2(x)) + 200 \cos(x)$$

$$= 400 \cos^2(x) - 400 + 400 \cos^2(x) + 200 \cos(x)$$

$$= 800 \cos^2(x) + 200 \cos(x) - 400$$

Maximum area occurs when $\frac{dA}{dx} = 0$.

$$800 \cos^2(x) + 200 \cos(x) - 400 = 0$$

$$4 \cos^2(x) + \cos(x) - 2 = 0$$

$$\cos(x) = \frac{-1 \pm \sqrt{1^2 - 4(4)(-2)}}{2(4)}$$

$$\cos(x) = \frac{-1 \pm \sqrt{33}}{8}$$

$$\cos(x) = 0.59307 \quad 0 < x < \frac{\pi}{2}$$

$$x = 0.936$$

$$A_{\max} = 200 \sin(0.936)(2 \cos(0.936) + 1)$$

$$= 352 \text{ cm}^2$$

19 a $V = -0.5t^2 - t + 1.5$

$$\frac{dV}{dt} = -t - 1$$

After 0.2 hours, $t = 0.2$ and $\frac{dV}{dt} = -0.2 - 1 = -1.2$. The water is leaking from the vessel at a rate of 1.2 mL/hour.

b When $t = 0$, $V = 1.5$. Therefore, half the initial volume is 0.75 mL.

$0.75 = -0.5t^2 - t + 1.5$ can then be solved using CAS to give $t = 0.58$ hours. (The other answer given by CAS of $t = -2.58$ is discarded, as it is negative.)

c Average rate of change

$$= \frac{V_2 - V_1}{t_2 - t_1}$$

$$= \frac{0.75 - 1.5}{0.58}$$

$$= -1.29 \text{ mL/h}$$

d The rate of flow is given by $\frac{dV}{dt} = -t - 1$. Over the domain

$t \in [0, 1]$, it is clear that $\frac{dV}{dt}$ will be greatest when $t = 1$, that is after 1 hour.

20 a $145 = 2Lr + \frac{1}{2}\pi r^2$

$$145 - \frac{1}{2}\pi r^2 = 2Lr$$

$$290 - \pi r^2 = 4Lr$$

$$\frac{290 - \pi r^2}{4r} = L$$

$$P = 2L + 2r + \frac{1}{2} \times 2\pi r$$

$$P = 2L + 2r + \pi r$$

$$P = 2 \left(\frac{290 - \pi r^2}{4r} \right) + (2 + \pi)r$$

$$P = \frac{290 - \pi r^2}{2r} + (2 + \pi)r \text{ as required}$$

b $P = \frac{290 - \pi r^2}{2r} + (2 + \pi)r$

$$P = 145r^{-1} - \frac{\pi}{2}r + (2 + \pi)r$$

$$\frac{dP}{dr} = -145r^{-2} - \frac{\pi}{2} + 2 + \pi$$

$$\frac{dP}{dr} = -\frac{145}{r^2} - \frac{\pi}{2} + 2 + \pi$$

Minimum value occurs when $\frac{dP}{dr} = 0$.

$$-\frac{145}{r^2} + \frac{\pi}{2} + 2 = 0$$

c $\frac{\pi}{2} + 2 = \frac{145}{r^2}$

$$2 + \frac{\pi}{2} = \frac{145}{r^2}$$

$$r^2 = \frac{145}{(2 + \frac{\pi}{2})}$$

$$r = \pm \sqrt{\frac{145}{(2 + \frac{\pi}{2})}}$$

$$r = 6.4 \text{ metres as } r > 0$$

$$P_{\min} = \frac{290 - \pi(6.4)^2}{2(6.4)} + (2 + \pi)(6.4) = 45.5 \text{ metres}$$

$$L = \frac{290 - \pi r^2}{4r} = 6.4 \text{ metres}$$

A radius and length of 6.4 metres produces a minimum perimeter of 45.5 metres.

6.9 Exam questions

1 $y = (-3x^3 + x^2 - 64)^3$

$$\frac{dy}{dx} = 3(-9x^2 + 2x)(-3x^3 + x^2 - 64)^2$$

$$= -3(9x^2 - 2x)(3x^3 - x^2 + 64)^2 \quad [1 \text{ mark}]$$

VCAA Examination Report note:

Students generally recognised the need to deploy the chain rule; however, a significant number of students could not be awarded the mark. Poor use of brackets (or lack of brackets) resulted in an incorrect expression. For example, the expression $3(-3x^3 + x^2 - 64)^2(-9x^2 + 2x)$ is not equivalent to $3(-3x^3 + x^2 - 64)^2 - 9x^2 + 2x$. Transcription errors (especially with exponents) and arithmetic errors with unnecessary expansions were also observed.

2 $y = x^2 \sin(x)$

$$u = x^2 \quad v = \sin(x) \text{ (product rule)}$$

$$\frac{du}{dx} = 2x \quad \frac{dv}{dx} = \cos(x)$$

$$\frac{dy}{dx} = u \frac{dv}{dx} + v \frac{du}{dx}$$

$$\frac{dy}{dx} = x^2 \cos(x) + 2x \sin(x)$$

$$\frac{dy}{dx} = x(x \cos(x) + 2 \sin(x))$$

Award 1 mark for using the product rule.

Award 1 mark for the correct answer.

VCAA Assessment Report note:

Although this question was generally very well handled, some students made errors in an attempt to factorise, which was not necessary.

3 $A(m) = \frac{1}{2}m(9 - m^2)$

$$= \frac{1}{2}(9m - m^3)$$

$$\frac{dA}{dm} = \frac{1}{2}(9 - 3m^2) = 0$$

$$m = \sqrt{3}, m > 0$$

$$A(\sqrt{3}) = 3\sqrt{3}$$

The correct answer is **D**.

$$4 \quad f(x) = 3x^2 - 2\sqrt{x+1}$$

$$f(3) = 27 - 2\sqrt{4} = 23 \quad f(0) = -2$$

$$\frac{f(3) - f(0)}{3 - 0} = \frac{23 + 2}{3 - 0} = \frac{25}{3}$$

The correct answer is **D**.

$$5 \text{ a} \quad y = f(x) = \frac{3x(x-30)^2}{2000}, \quad x \in [0, 30]$$

$$\frac{dy}{dx} = \frac{9(x-10)(x-30)}{2000}, \quad x \in (0, 30) \quad [1 \text{ mark}]$$

VCAA Examination Report note:

Other equivalent forms were acceptable.

This question was answered well. Common incorrect

answers were $\frac{9x(x-30)(x-15)}{500}$ and $\frac{9(x^2 - 40x + 30)}{2000}$.

$$b \quad m = \frac{dy}{dx}$$

$$\text{Solving } \frac{dm}{dx} \leq 0 \Rightarrow x \in (0, 20] \quad [1 \text{ mark}]$$

VCAA Examination Report note:

This question was not done well. Most students interpreted the question as asking where the function modelling the hill was strictly decreasing, rather than the gradient of the hill and so the most common incorrect response was $[10, 30]$ or a combination of round and square brackets with those two values.

$$c \quad g(x) = f(x) + 3 = \frac{3x(x-30)^2}{2000} + 3 \quad [1 \text{ mark}]$$

VCAA Examination Report note:

This question was generally well done. Some students did not give an equation. Others added 10, instead of 3, to f .

$$d \quad \text{Average gradient } \frac{f(30) - f(10)}{30 - 10} = \frac{0 - 6}{20} = \frac{-3}{10}$$

$$\text{Solving } \frac{dy}{dx} = \frac{9(x-10)(x-30)}{2000} = \frac{-3}{10}$$

$$\text{gives } x = \frac{60 \pm 10\sqrt{3}}{3}.$$

Award 1 mark for calculation of the average gradient.

Award 1 mark for solving the derivative equal to the average gradient.

Award 1 mark for the correct answer.

VCAA Examination Report note:

A common incorrect answer for the average gradient was $\frac{3}{10}$.

Some students used $\frac{1}{30-10} \int_{10}^{30} h(x) dx$.

instead of $\frac{1}{30-10} \int_{10}^{30} h'(x) dx$.

Some students gave approximate answers for the x values, 14.23 and 25.77.

Other students did not use brackets correctly, giving

$$x = \frac{\pm 10(\sqrt{3} + 6)}{3} \text{ as their answer. Another common}$$

incorrect answer was $\frac{6 \pm 10\sqrt{3}}{3}$.

$$e \text{ i} \quad g'(a) = \frac{9(a-10)(a-30)}{2000} \quad [1 \text{ mark}]$$

VCAA Examination Report note:

Common incorrect answers were

$$\frac{9a^2}{2000} - \frac{9a}{50} + \frac{27}{50}, \frac{3}{2000}a^2 - \frac{9}{100}a - \frac{10}{a} + \frac{27}{20}$$

$$\text{and } \frac{3a^2 - 180a^2 + 2700a - 20000}{2000a}.$$

Some students used $\frac{f(a) - 10}{a}$ instead of $\frac{h(a) - 10}{a}$.

Other students wrote $\frac{b-10}{a}$.

The answer had to be given in terms of a .

ii At the point (a, b) , the gradient of the straight section and the gradient of the curve are equal (smooth join).

Also, the y -values are equal.

$$g'(a) = \frac{9(a-10)(a-30)}{2000} = \frac{10-b}{0-a} \text{ and } b = g(a)$$

Solving gives $a = 11.12, b = 8.95 \Rightarrow A(11.12, 8.95)$.

Award 1 mark for each equation (up to 2 marks).

Award 1 mark for the correct answer.

VCAA Examination Report note:

Many students did not equate the correct expressions.

Some students found the value of a but not the value of b . Other students rounded their answers incorrectly, giving $(11.11, 8.94)$.

$$iii \quad g'(11.12) = -0.09485 \quad [1 \text{ mark}]$$

$$= -0.1$$

VCAA Examination Report note:

Students who obtained the correct value for a in Question 2eii were generally successful with this question.

Topic 7 — Anti-differentiation

7.2 Anti-differentiation

7.2 Exercise

$$1 \text{ a } \int -2x^3 dx$$

$$= -\frac{2x^{3+1}}{4} + c$$

$$= -\frac{x^4}{2} + c$$

$$b \int \frac{1}{2}\sqrt[4]{x} dx$$

$$= \int \frac{1}{2}x^{\frac{1}{4}} dx$$

$$= \frac{\frac{1}{2}x^{\frac{1}{4}+1}}{\frac{5}{4}} + c$$

$$= \frac{2}{5}x^{\frac{5}{4}} + c$$

$$c \int -\frac{3}{2x^2} dx$$

$$= \int -\frac{3}{2}x^{-2} dx$$

$$= -\frac{\frac{3}{2}x^{-2+1}}{-1} + c$$

$$= \frac{3}{2}x^{-1} + c$$

$$= \frac{3}{2x} + c$$

$$d \int \frac{4}{\sqrt[3]{x^2}} dx$$

$$= \int 4x^{-\frac{2}{3}} dx$$

$$= \frac{4x^{-\frac{2}{3}+1}}{\frac{1}{3}} + c$$

$$= 12x^{\frac{1}{3}} + c$$

$$2 \text{ a } f'(x) = \frac{3}{2}x - 4x^2 + 2x^3$$

$$f(x) = \frac{3}{4}x^2 - \frac{4}{3}x^3 + \frac{1}{2}x^4 + c$$

$$b \int \left(\frac{3}{\sqrt{x}} - 4x^3 + \frac{2}{5x^3} \right) dx$$

$$= \int \left(3x^{-\frac{1}{2}} - 4x^3 + \frac{2}{5}x^{-3} \right) dx$$

$$= 6x^{\frac{1}{2}} - x^4 - \frac{1}{5}x^{-2}$$

$$= 6\sqrt{x} - x^4 - \frac{1}{5x^2}$$

$$c \int x(x-3)(2x+5) dx$$

$$= \int (2x^3 - x^2 - 15x) dx$$

$$= \frac{1}{2}x^4 - \frac{1}{3}x^3 - \frac{15}{2}x^2 + c$$

$$d \int \frac{3x^3 - x}{2\sqrt{x}} dx$$

$$= \int \left(\frac{3}{2}x^{\frac{5}{2}} - \frac{1}{2}x^{\frac{1}{2}} \right) dx$$

$$= \frac{3}{7}x^{\frac{7}{2}} - \frac{1}{3}x^{\frac{3}{2}} + c$$

$$3 \text{ a } \int \left(\frac{2}{\sqrt{x}} + \frac{3}{x^2} - \frac{1}{2x^3} \right) dx$$

$$= \int \left(2x^{-\frac{1}{2}} + 3x^{-2} - \frac{1}{2}x^{-3} \right) dx$$

$$= 4x^{\frac{1}{2}} - 3x^{-1} + \frac{1}{4}x^{-2} + c$$

$$= 4\sqrt{x} - \frac{3}{x} + \frac{1}{4x^2} + c$$

$$b \int (x+1)(2x^2-3x+4) dx$$

$$= \int (2x^3 - x^2 + x + 4) dx$$

$$= \frac{1}{2}x^4 - \frac{1}{3}x^3 + \frac{1}{2}x^2 + 4x + c$$

$$4 \text{ a } f'(x) = x^2 - \frac{1}{x^2}$$

$$f'(x) = x^2 - x^{-2}$$

$$f(x) = \frac{1}{3}x^3 + x^{-1} + c$$

$$f(x) = \frac{1}{3}x^3 + \frac{1}{x} + c$$

$$5 \text{ a } \int x^3 dx = \frac{1}{4}x^4 + c$$

$$b \int \left(7x^2 - \frac{2}{5x^3} \right) dx = \int \left(7x^2 - \frac{2}{5}x^{-3} \right) dx$$

$$= \frac{7}{3}x^3 + \frac{1}{5}x^{-2} + c$$

$$c \int (4x^3 - 7x^2 + 2x - 1) dx = x^4 - \frac{7}{3}x^3 + x^2 - x + c$$

$$d \int (2\sqrt{x})^3 dx$$

$$= \int 8x^{\frac{3}{2}} dx$$

$$= 8 \times \frac{2}{5}x^{\frac{5}{2}} + c$$

$$= \frac{16}{5}\sqrt{x^5} + c$$

$$= \frac{16}{5}x^2\sqrt{x} + c$$

$$6 \text{ a } \int (3x-5)^5 dx = \frac{(3x-5)^6}{3 \times 6} = \frac{1}{18} (3x-5)^6 + c$$

$$\begin{aligned} \text{b } \int \frac{1}{(2x-3)^{\frac{5}{2}}} dx &= \int (2x-3)^{-\frac{5}{2}} dx \\ &= \frac{(2x-3)^{-\frac{3}{2}}}{2 \times -\frac{3}{2}} \\ &= -\frac{1}{3(2x-3)^{\frac{3}{2}}} + c \end{aligned}$$

$$\begin{aligned} \text{c } \int (2x+3)^4 dx &= \frac{(2x+3)^5}{2 \times 5} \\ &= \frac{1}{10} (2x+3)^5 + c \end{aligned}$$

$$\begin{aligned} \text{d } \int (1-2x)^{-5} dx &= \frac{(1-2x)^{-4}}{-2 \times -4} \\ &= \frac{1}{8} (1-2x)^{-4} \\ &= \frac{1}{8(1-2x)^4} + c \end{aligned}$$

$$\begin{aligned} 7 \frac{dy}{dx} &= x^3 - 3\sqrt{x} = x^3 - 3x^{\frac{1}{2}} \\ y &= \frac{1}{4}x^4 - 3 \times \frac{2}{3}x^{\frac{3}{2}} + c \\ y &= \frac{1}{4}x^4 - 2x\sqrt{x} + c \end{aligned}$$

The correct answer is **B**.

$$\begin{aligned} 8 \frac{dy}{dx} &= \frac{x^3 + 3x^2 - 3}{x^2} = x + 3 - 3x^{-2} \\ y &= \frac{1}{2}x^2 + 3x + 3x^{-1} + c \\ y &= \frac{1}{2}x^2 + 3x + \frac{3}{x} + c \end{aligned}$$

The correct answer is **D**.

$$\begin{aligned} 9 \text{ a } \int (3x-1)^3 dx &= \int ((3x)^3 - 3(3x)^2(1) + 3(3x)(1)^2 - 1^3) dx \\ &= \int (27x^3 - 27x^2 + 9x - 1) dx \\ &= \frac{27}{4}x^4 - 9x^3 + \frac{9}{2}x^2 - x + c \end{aligned}$$

$$\begin{aligned} \text{b } \int \frac{1}{4x^3} dx &= \int \frac{1}{4}x^{-3} dx \\ &= -\frac{1}{8}x^{-2} + c \\ &= -\frac{1}{8x^2} + c \end{aligned}$$

$$\text{c } \int \left(x^{\frac{5}{2}} - 3x^{\frac{2}{5}} \right) dx = \frac{2}{7}x^{\frac{7}{2}} - \frac{15}{7}x^{\frac{7}{5}} + c$$

$$\begin{aligned} \text{d } \int \frac{x^4 - 2x}{x^3} dx &= \int (x - 2x^{-2}) dx \\ &= \frac{1}{2}x^2 + 2x^{-1} + c \\ &= \frac{1}{2}x^2 + \frac{2}{x} + c \end{aligned}$$

$$\begin{aligned} \text{e } \int \sqrt{x} (2x - \sqrt{x}) dx &= \int \left(2x^{\frac{3}{2}} - x \right) dx \\ &= \frac{4}{5}x^{\frac{5}{2}} - \frac{1}{2}x^2 + c \end{aligned}$$

$$\begin{aligned} \text{f } \int \sqrt{4-x} dx &= \int (4-x)^{\frac{1}{2}} dx \\ &= -\frac{2}{3} (4-x)^{\frac{3}{2}} + c \end{aligned}$$

$$\begin{aligned} 10 \frac{dy}{dx} &= \sqrt{x} + \frac{1}{\sqrt{x}} = x^{\frac{1}{2}} + x^{-\frac{1}{2}} \\ y &= \frac{2}{3}x^{\frac{3}{2}} + 2x^{\frac{1}{2}} + c \\ y &= \frac{2}{3}x\sqrt{x} + 2\sqrt{x} + c \end{aligned}$$

The correct answer is **E**.

$$\begin{aligned} 11 \text{ a } \int \left(2x^2 + \frac{1}{x} \right)^3 dx &= \int \left((2x^2)^3 + 3(2x^2)^2 \left(\frac{1}{x} \right) + 3(2x^2) \left(\frac{1}{x} \right)^2 + \left(\frac{1}{x} \right)^3 \right) dx \\ &= \int (8x^6 + 12x^3 + 6 + x^{-3}) dx \\ &= \frac{8}{7}x^7 + 3x^4 + 6x - \frac{1}{2}x^{-2} + c \\ &= \frac{8}{7}x^7 + 3x^4 + 6x - \frac{1}{2x^2} + c \end{aligned}$$

$$\begin{aligned} 12 \text{ a } \int (\sqrt{x} - x)^2 dx &= \int \left((\sqrt{x})^2 - 2(\sqrt{x})(x) + (x)^2 \right) dx \\ &= \int \left(x - 2x^{\frac{3}{2}} + x^2 \right) dx \\ &= \frac{1}{2}x^2 - \frac{4}{5}x^{\frac{5}{2}} + \frac{1}{3}x^3 + c \end{aligned}$$

$$\begin{aligned} \text{b } \int \left(\sqrt{x} + \frac{1}{\sqrt{x}} \right)^3 dx &= \int \left(\left(\frac{1}{x^2} \right)^3 + 3 \left(\frac{1}{x^2} \right)^2 \left(x^{-\frac{1}{2}} \right) + 3 \left(\frac{1}{x^2} \right) \left(x^{-\frac{1}{2}} \right)^2 + \left(x^{-\frac{1}{2}} \right)^3 \right) dx \\ &= \int \left(x^{\frac{3}{2}} + 3x^{\frac{1}{2}} + 3x^{-\frac{1}{2}} + x^{-\frac{3}{2}} \right) dx \\ &= \frac{2}{5}x^{\frac{5}{2}} + 2x^{\frac{3}{2}} + 6x^{\frac{1}{2}} - 2x^{-\frac{1}{2}} + c \end{aligned}$$

$$\begin{aligned} 13 \text{ a } \int (2x+3)(3x-2) dx &= \int (6x^2 + 5x - 6) dx \\ &= 2x^3 + \frac{5}{2}x^2 - 6x \end{aligned}$$

$$\begin{aligned} \text{b } \int \frac{x^3 + x^2 + 1}{x^2} dx &= \int (x + 1 + x^{-2}) dx \\ &= \frac{1}{2}x^2 + x - x^{-1} \\ &= \frac{1}{2}x^2 + x - \frac{1}{x} \end{aligned}$$

$$\begin{aligned}
 \text{c } & \int \left(2\sqrt{x} - \frac{4}{\sqrt{x}} \right) dx \\
 &= \int \left(2x^{\frac{1}{2}} - 4x^{-\frac{1}{2}} \right) dx \\
 &= 2 \times \frac{2}{3} x^{\frac{3}{2}} - 4 \times 2x^{\frac{1}{2}} \\
 &= \frac{4}{3} x^{\frac{3}{2}} - 8x^{\frac{1}{2}} \\
 &= \frac{4}{3} x\sqrt{x} - 8\sqrt{x}
 \end{aligned}$$

$$\begin{aligned}
 \text{d } & \int \left(x^3 - \frac{2}{x^3} \right)^2 dx \\
 &= \int \left((x^3)^2 - 2(x^3) \left(\frac{2}{x^3} \right) + \left(\frac{2}{x^3} \right)^2 \right) dx \\
 &= \int \left(x^6 - 4 + 4x^{-6} \right) dx \\
 &= \frac{1}{7} x^7 - 4x - \frac{4}{5} x^{-5} \\
 &= \frac{1}{7} x^7 - 4x - \frac{4}{5x^5}
 \end{aligned}$$

$$\begin{aligned}
 \text{e } & \int 2(1-4x)^{-3} dx \\
 &= 2 \int (1-4x)^{-3} dx \\
 &= 2 \left(\frac{(1-4x)^{-2}}{-2 \times -4} \right) \\
 &= \frac{1}{4(1-4x)^2}
 \end{aligned}$$

$$\begin{aligned}
 \text{f } & \int \frac{2}{(2x-3)^{\frac{5}{2}}} dx \\
 &= \int 2(2x-3)^{-\frac{5}{2}} dx \\
 &= 2 \int (2x-3)^{-\frac{5}{2}} dx \\
 &= 2 \left(-\frac{1}{3} (2x-3)^{-\frac{3}{2}} \right) \\
 &= -\frac{2}{3(2x-3)^{\frac{3}{2}}}
 \end{aligned}$$

$$\begin{aligned}
 \text{14 } & \int \frac{x^2}{\sqrt{x^3+1}} dx \\
 &= \frac{2}{3} (x^3+1)^{\frac{1}{2}} + c \\
 &= \frac{2}{3} \sqrt{x^3+1} + c
 \end{aligned}$$

$$\begin{aligned}
 \text{15 } & \int 2(3x+5)^{\frac{1}{2}} (7x^2+4x-1) dx \\
 &= \frac{4}{405} (3x+5)^{\frac{3}{2}} (135x^2-72x+35) + c
 \end{aligned}$$

$$\begin{aligned}
 \text{16 } & y = (3x^2+2x-4)^3 \\
 \frac{dy}{dx} &= 3(6x+2)(3x^2+2x-4)^2 \\
 \frac{dy}{dx} &= 6(3x+1)(3x^2+2x-4)^2
 \end{aligned}$$

Therefore,

$$\begin{aligned}
 \int (3x+1)(3x^2+2x-4)^2 dx &= \frac{1}{6} \int 6(3x+1)(3x^2+2x-4)^2 \\
 &= \frac{1}{6} (3x^2+2x-4)^3
 \end{aligned}$$

$$\begin{aligned}
 \text{17 } & y = \left(7x + \sqrt{x} - \frac{1}{\sqrt{x}} \right)^4 \\
 & y = \left(7x + x^{\frac{1}{2}} - x^{-\frac{1}{2}} \right)^4
 \end{aligned}$$

$$\frac{dy}{dx} = 4 \left(7 + \frac{1}{2} x^{-\frac{1}{2}} + \frac{1}{2} x^{-\frac{3}{2}} \right) \left(7x + \sqrt{x} - \frac{1}{\sqrt{x}} \right)^3$$

$$\frac{dy}{dx} = 4 \left(7 + \frac{1}{2\sqrt{x}} + \frac{1}{2\sqrt{x^3}} \right) \left(7x + \sqrt{x} - \frac{1}{\sqrt{x}} \right)^3$$

Therefore,

$$\begin{aligned}
 & \int \left(7 + \frac{1}{2\sqrt{x}} + \frac{1}{2\sqrt{x^3}} \right) \left(7x + \sqrt{x} - \frac{1}{\sqrt{x}} \right)^3 dx \\
 &= \frac{1}{4} \int 4 \left(7 + \frac{1}{2\sqrt{x}} + \frac{1}{2\sqrt{x^3}} \right) \left(7x + \sqrt{x} - \frac{1}{\sqrt{x}} \right)^3 dx \\
 &= \frac{1}{4} \left(7x + \sqrt{x} - \frac{1}{\sqrt{x}} \right)^4
 \end{aligned}$$

$$\text{18 } y = \sqrt{x^2+1} = (x^2+1)^{\frac{1}{2}}$$

$$\frac{dy}{dx} = \frac{1}{2} (2x)(x^2+1)^{-\frac{1}{2}}$$

$$\frac{dy}{dx} = \frac{x}{\sqrt{x^2+1}}$$

$$\begin{aligned}
 \int \frac{5x}{\sqrt{x^2+1}} dx &= 5 \int \frac{x}{\sqrt{x^2+1}} dx \\
 &= 5\sqrt{x^2+1} + c
 \end{aligned}$$

$$\text{19 } y = (5x^2+2x-1)^4$$

$$\frac{dy}{dx} = 4(10x+2)(5x^2+2x-1)^3$$

$$\frac{dy}{dx} = 8(5x+1)(5x^2+2x-1)^3$$

$$\begin{aligned}
 \int 16(5x+1)(5x^2+2x-1)^3 dx &= 2 \int 8(5x+1)(5x^2+2x-1)^3 dx \\
 &= 2(5x^2+2x-1)^4
 \end{aligned}$$

$$\text{20 } y = \sqrt{5x^3+4x^2} = (5x^3+4x^2)^{\frac{1}{2}}$$

$$\frac{dy}{dx} = \frac{1}{2} (15x^2+8x)(5x^3+4x^2)^{-\frac{1}{2}}$$

$$\frac{dy}{dx} = \frac{15x^2+8x}{2\sqrt{5x^3+4x^2}}$$

$$\begin{aligned}
 & \int \frac{15x^2+8x}{\sqrt{5x^3+4x^2}} dx \\
 &= 2 \int \frac{15x^2+8x}{2\sqrt{5x^3+4x^2}} dx \\
 &= 2\sqrt{5x^3+4x^2}
 \end{aligned}$$

7.2 Exam questions

$$\begin{aligned}
 1 \quad & \int (4 - 2x)^{-5} dx \\
 &= \frac{(4 - 2x)^{-4}}{-2 \times -4} \\
 &= \frac{1}{8(4 - 2x)^4}
 \end{aligned}$$

Award 1 mark for the correct power.

Award 1 mark for the correct factor out the front.

$$\begin{aligned}
 2 \quad & a, b, m \text{ and } n \in \mathbb{Z}^+ \\
 & \frac{d}{dx}(ax^m) = max^{m-1} = \int bx^n dx = \frac{b}{n+1}x^{n+1} \\
 & \Rightarrow \frac{b}{a} = m(n+1)x^{m-n-2} \Rightarrow m - n - 2 = 0
 \end{aligned}$$

Since $\frac{b}{a} = m(n+1)$ and m, n are both integers, it is clear that

$\frac{b}{a}$ is an integer.

$$n = 1, m = 3: \quad \frac{b}{a} = 6, \quad \frac{m}{n} = 3$$

$$n = 2, m = 4: \quad \frac{b}{a} = 12, \quad \frac{m}{n} = 2$$

$$n = 3, m = 5: \quad \frac{b}{a} = 20, \quad \frac{m}{n} = \frac{5}{3}$$

The correct answer is **D**.

$$\begin{aligned}
 3 \quad & \int \left(3x^4 - \frac{2}{x^2}\right) dx = \int 3x^4 dx - \int \frac{2}{x^2} dx \\
 &= \int 3x^4 dx - \int 2x^{-2} dx \\
 &= \frac{3x^5}{5} + \frac{2}{x} + c \quad [1 \text{ mark}]
 \end{aligned}$$

7.3 Anti-derivatives of exponential and trigonometric functions
7.3 Exercise

$$1 \quad \mathbf{a} \quad \int (x^4 - e^{-4x}) dx = \frac{1}{5}x^5 + \frac{1}{4}e^{-4x} + c$$

$$\mathbf{b} \quad \int \left(\frac{1}{2}e^{2x} - \frac{2}{3}e^{-\frac{x}{2}}\right) dx = \frac{1}{4}e^{2x} + \frac{4}{3}e^{-\frac{x}{2}} + c$$

$$\begin{aligned}
 2 \quad & \int (e^{2x} - e^{-3x})^3 dx \\
 &= \int \left((e^{2x})^3 - 3(e^{2x})^2(e^{-3x}) + 3(e^{2x})(e^{-3x})^2 - (e^{-3x})^3\right) dx \\
 &= \int (e^{6x} - 3e^x + 3e^{-4x} - e^{-9x}) dx \\
 &= \frac{1}{6}e^{6x} - 3e^x - \frac{3}{4}e^{-4x} + \frac{1}{9}e^{-9x} + c
 \end{aligned}$$

$$\begin{aligned}
 3 \quad & \int \left(e^{\frac{x}{2}} - \frac{1}{e^x}\right)^2 dx \\
 &= \int \left(\left(e^{\frac{x}{2}}\right)^2 - 2\left(e^{\frac{x}{2}}\right)\left(\frac{1}{e^x}\right) + \left(\frac{1}{e^x}\right)^2\right) dx \\
 &= \int \left(e^x - 2e^{-\frac{x}{2}} + e^{-2x}\right) dx \\
 &= e^x + 4e^{-\frac{x}{2}} - \frac{1}{2}e^{-2x} + c \\
 &= e^x + \frac{4}{e^{\frac{x}{2}}} - \frac{1}{2e^{2x}} + c
 \end{aligned}$$

$$\begin{aligned}
 4 \quad \mathbf{a} \quad & \int \left(\frac{1}{2} \cos(3x + 4) - 4 \sin\left(\frac{x}{2}\right)\right) dx \\
 &= \frac{1}{6} \sin(3x + 4) + 8 \cos\left(\frac{x}{2}\right) + c
 \end{aligned}$$

$$\begin{aligned}
 \mathbf{b} \quad & \int \left(\cos\left(\frac{2x}{3}\right) - \frac{1}{4} \sin(5 - 2x)\right) dx \\
 &= \frac{3}{2} \sin\left(\frac{2x}{3}\right) - \frac{1}{8} \cos(5 - 2x)
 \end{aligned}$$

$$\begin{aligned}
 5 \quad \mathbf{a} \quad & \int \left(\sin\left(\frac{x}{2}\right) - 3 \cos\left(\frac{x}{2}\right)\right) dx \\
 &= -2 \cos\left(\frac{x}{2}\right) - 6 \sin\left(\frac{x}{2}\right) + c
 \end{aligned}$$

$$\begin{aligned}
 \mathbf{b} \quad & f'(x) = 7 \cos(2x) - \sin(3x) \\
 & f(x) = \frac{7}{2} \sin(2x) + \frac{1}{3} \cos(3x) + c
 \end{aligned}$$

$$6 \quad \mathbf{a} \quad \int \left(e^{\frac{x}{3}} + \sin\left(\frac{x}{3}\right) + \frac{x}{3}\right) dx = 3e^{\frac{x}{3}} - 3 \cos\left(\frac{x}{3}\right) + \frac{1}{6}x^2 + c$$

$$\mathbf{b} \quad \int (\cos(4x) + 3e^{-3x}) dx = \frac{1}{4} \sin(4x) - e^{-3x} + c$$

$$\begin{aligned}
 7 \quad & \int \left(\frac{1}{4x^2} + \sin\left(\frac{3\pi x}{2}\right)\right) dx \\
 &= \int \left(\frac{1}{4}x^{-2} + \sin\left(\frac{3\pi x}{2}\right)\right) dx \\
 &= -\frac{1}{4}x^{-1} - \frac{2}{3\pi} \cos\left(\frac{3\pi x}{2}\right) \\
 &= -\frac{1}{4x} - \frac{2}{3\pi} \cos\left(\frac{3\pi x}{2}\right)
 \end{aligned}$$

$$\begin{aligned}
 8 \quad & \frac{dy}{dx} = \cos(2x) - e^{-3x} \\
 & y = \frac{1}{2} \sin(2x) + \frac{1}{3} e^{-3x} + c
 \end{aligned}$$

$$9 \quad \mathbf{a} \quad \int (2e^{3x} - \sin(2x)) dx = \frac{2}{3}e^{3x} + \frac{1}{2} \cos(2x) + c$$

$$\begin{aligned}
 \mathbf{b} \quad & \int \frac{e^{2x} + 3e^{-5x}}{2e^x} dx = \int \left(\frac{1}{2}e^x + \frac{3}{2}e^{-6x}\right) dx \\
 &= \frac{1}{2}e^x - \frac{1}{4}e^{-6x} + c
 \end{aligned}$$

$$\mathbf{c} \quad \int (0.5 \cos(2x + 5) - e^{-x}) dx = \frac{1}{4} \sin(2x + 5) + e^{-x} + c$$

$$\begin{aligned}
 \mathbf{d} \quad & \int (e^x - e^{2x})^2 dx \\
 &= \int \left((e^x)^2 - 2(e^x)(e^{2x}) + (e^{2x})^2\right) dx \\
 &= \int (e^{2x} - 2e^{3x} + e^{4x}) dx \\
 &= \frac{1}{2}e^{2x} - \frac{2}{3}e^{3x} + \frac{1}{4}e^{4x} + c
 \end{aligned}$$

$$10 \quad \int \frac{e^{2x} + e^x - 1}{e^x + 1} dx = e^x - x + \log_e(e^x + 1) + c$$

$$11 \quad \int ae^{bx} dx = -3e^{3x} + c$$

$$\frac{a}{b}e^{bx} + c = -3e^{3x} + c$$

$$b = 3 \text{ and } \frac{a}{3} = -3$$

$$a = -9$$

$$12 \quad f'(x) = a \sin(mx) - be^{nx}$$

$$f(x) = \cos(2x) - 2e^{-2x} + 3$$

$$f'(x) = -2 \sin(2x) + 4e^{-2x}$$

Therefore, $a = -2$, $b = -4$, $m = 2$ and $n = -2$

$$13 \quad \mathbf{a} \quad \frac{dH}{dt} = 1 + \frac{\pi^2}{9} \sin\left(\frac{\pi t}{45}\right)$$

$$H(t) = t - \left(\frac{45}{\pi} \times \frac{\pi^2}{9}\right) \cos\left(\frac{\pi t}{45}\right)$$

$$H(t) = t - 5\pi \cos\left(\frac{\pi t}{45}\right)$$

b When $t = 15$,

$$H = 15 - 5\pi \cos\left(\frac{\pi}{3}\right) = 7.146 \text{ kilojoules}$$

$$14 \quad \int e^x \sin(x) dx = \int e^x \cos(x) dx$$

Solve using CAS:

$$x = \frac{\pi}{2}, \frac{3\pi}{2}$$

$$15 \quad x(t) = 20 + \cos\left(\frac{\pi t}{4}\right)$$

$$\frac{dy}{dt} = \frac{\pi}{20} x(t) - \pi$$

$$\frac{dy}{dt} = \frac{\pi}{20} \left(20 + \cos\left(\frac{\pi t}{4}\right)\right) - \pi$$

$$\frac{dy}{dt} = \pi + \frac{\pi}{20} \cos\left(\frac{\pi t}{4}\right) - \pi$$

$$\frac{dy}{dt} = \frac{\pi}{20} \cos\left(\frac{\pi t}{4}\right)$$

$$y = \frac{4}{\pi} \times \frac{\pi}{20} \sin\left(\frac{\pi t}{4}\right) + c$$

$$y = \frac{1}{5} \sin\left(\frac{\pi t}{4}\right) + c$$

$$16 \quad y = e^{\cos^2(x)} = e^{(\cos(x))^2}$$

$$\frac{dy}{dx} = -2 \sin(x) \cos(x) e^{\cos^2(x)}$$

Therefore,

$$\begin{aligned} \int \sin(x) \cos(x) e^{\cos^2(x)} dx &= -\frac{1}{2} \int -2 \sin(x) \cos(x) e^{\cos^2(x)} dx \\ &= -\frac{1}{2} e^{\cos^2(x)} \end{aligned}$$

$$17 \quad y = e^{(x+1)^3}$$

$$\frac{dy}{dx} = 3(1)(x+1)^2 e^{(x+1)^3}$$

$$\frac{dy}{dx} = 3(x+1)^2 e^{(x+1)^3}$$

Therefore,

$$\int 3(x+1)^2 e^{(x+1)^3} dx = e^{(x+1)^3}$$

$$\int 9(x+1)^2 e^{(x+1)^3} dx = 3e^{(x+1)^3} + c$$

$$18 \quad y = 2xe^{3x}$$

$$\frac{dy}{dx} = 2e^{3x} + 6xe^{3x}$$

$$\int (2e^{3x} + 6xe^{3x}) dx = 2xe^{3x}$$

$$\int 2e^{3x} dx + 6 \int xe^{3x} dx = 2xe^{3x}$$

$$6 \int xe^{3x} dx = 2xe^{3x} - \int 2e^{3x} dx$$

$$6 \int xe^{3x} dx = 2xe^{3x} - \frac{2}{3}e^{3x}$$

$$3 \int xe^{3x} dx = xe^{3x} - \frac{1}{3}e^{3x}$$

$$\int xe^{3x} dx = \frac{1}{3}xe^{3x} - \frac{1}{9}e^{3x}$$

The correct answer is **A**.

$$19 \quad y = e^{2x^2+3x-1}$$

$$\frac{dy}{dx} = (4x+3)e^{2x^2+3x-1}$$

$$\begin{aligned} \int 2(4x+3)e^{2x^2+3x-1} dx &= 2 \int (4x+3)e^{2x^2+3x-1} dx \\ &= 2e^{2x^2+3x-1} \end{aligned}$$

$$20 \quad y = x \cos(x)$$

$$\frac{dy}{dx} = \cos(x) - x \sin(x)$$

$$\int (\cos(x) - x \sin(x)) dx = x \cos(x)$$

$$\int \cos(x) dx - \int x \sin(x) dx = x \cos(x)$$

$$\int \cos(x) dx - x \cos(x) = \int x \sin(x) dx$$

$$\int x \sin(x) dx = \sin(x) - x \cos(x)$$

7.3 Exam questions

$$1 \quad \frac{d}{dx} (xe^{kx}) = (kx+1)e^{kx}$$

$$\int (kx+1)e^{kx} dx = xe^{kx}$$

$$k \int xe^{kx} dx + \int e^{kx} dx = xe^{kx}$$

$$k \int xe^{kx} dx = xe^{kx} - \int e^{kx} dx$$

$$\int xe^{kx} dx = \frac{1}{k} \left(xe^{kx} - \int e^{kx} dx \right) + c$$

The correct answer is **D**.

$$2 \quad \frac{dy}{dx} = 2 \sin(2x) - 4e^{-2x}$$

$$\begin{aligned} y &= \int (2 \sin(2x) - 4e^{-2x}) dx \\ &= -\cos(2x) + 2e^{-2x} + c \end{aligned}$$

When $x = 0$ and $y = 0$,

$$0 = -1 + 2 + C \Rightarrow C = -1$$

$$y = -\cos(2x) + 2e^{-2x} - 1$$

The correct answer is **A**.

$$3 \quad \mathbf{a} \quad \int e^{bx} dx = \frac{a}{b} e^{bx} + c$$

$$-2e^{2x} = \frac{a}{b} e^{bx}$$

Equating coefficients:

$$e^{2x} = e^{bx}$$

$$b = 2$$

$$-2 = \frac{a}{b}$$

$$-2 = \frac{a}{2}$$

$$a = -4$$

The correct answer is **D**.

7.4 The anti-derivative of $f(x) = \frac{1}{x}$

7.4 Exercise

1 a $\int \frac{2}{5x} dx = \frac{2}{5} \int \frac{1}{x} dx = \frac{2}{5} \log_e(x) + c, x > 0$

b $\int \frac{3}{4x-1} dx = \frac{3}{4} \int \frac{4}{4x-1} dx$
 $= \frac{3}{4} \log_e(4x-1) + c$

2 a $\int -\frac{4}{x} dx = -4 \log_e(x) + c, x > 0$

b $\int \frac{3}{4x+7} dx = \frac{3}{4} \int \frac{4}{4x+7} dx = \frac{3}{4} \log_e(4x+7) + c, x > -\frac{7}{4}$

c $\int \frac{x^3 + 2x^2 + 3x - 1}{x^2} dx = \int \left(x + 2 + \frac{3}{x} - x^{-2} \right) dx$
 $= \frac{1}{2}x^2 + 2x + 3 \log_e(x) + \frac{1}{x} + c, x > 0$

d $\int \left(\frac{3}{2-x} + \cos(4x) \right) dx$
 $= -3 \int \frac{-1}{(2-x)} dx + \int \cos(4x) dx$
 $= -3 \log_e(2-x) + \frac{1}{4} \sin(4x) + c, x < 2$

3 a $\int \frac{3}{1-2x} dx = 3 \int \frac{1}{1-2x} dx$
 $= 3 \times -\frac{1}{2} \log_e(1-2x) + c$
 $= -\frac{3}{2} \log_e(1-2x)$

b $\int \left(\frac{2}{x+4} \right) dx = 2 \int \left(\frac{1}{x+4} \right) dx$
 $= 2 \log_e(x+4) + c$

4 $y = 2 \log_e(\cos(2x))$

$$\frac{dy}{dx} = \frac{-4 \sin(2x)}{\cos(2x)} = -4 \tan(2x)$$

$$\int (-4 \tan(2x)) dx = 2 \log_e(\cos(2x))$$

$$-4 \int (\tan(2x)) dx = 2 \log_e(\cos(2x))$$

$$\int (\tan(2x)) dx = -\frac{1}{2} \log_e(\cos(2x))$$

5 Let $y = f(x) = 2x \log_e(mx)$.

$$\frac{dy}{dx} = 2 \log_e(mx) + 2x \times \frac{1}{x}$$

$$\frac{dy}{dx} = 2 \log_e(mx) + 2$$

$$\int (2 \log_e(mx) + 2) dx = 2x \log_e(mx)$$

$$2 \int \log_e(mx) dx + \int 2 dx = 2x \log_e(mx)$$

$$2 \int \log_e(mx) dx = 2x \log_e(mx) - 2x$$

$$2 \int \log_e(mx) dx = 2x \log_e(mx) - 2x$$

$$\int \log_e(mx) dx = x \log_e(mx) - x + c$$

6 If $y = 3x \log_e(x)$, then $\frac{dy}{dx} = 3 \log_e(x) + \frac{3x}{x} = 3 \log_e(x) + 3$.

$$\int (3 \log_e(x) + 3) dx = 3x \log_e(x)$$

$$3 \int \log_e(x) dx + \int 3 dx = 3x \log_e(x)$$

$$3 \int \log_e(x) dx = 3x \log_e(x) - \int 3 dx$$

$$3 \int \log_e(x) dx = 3x \log_e(x) - 3x$$

$$\int \log_e(x) dx = x \log_e(x) - x$$

$$2 \int \log_e(x) dx = 2x \log_e(x) - 2x$$

$$\int 2 \log_e(x) dx = 2x \log_e(x) - 2x$$

7 $\int \frac{6}{4-2x} dx = \int \frac{3}{2-x} dx$

$$= 3 \int \frac{1}{2-x} dx$$

$$= -3 \log_e(2-x) + c$$

Therefore, $a = -3$ and $b = 2$.

8 $\int \frac{2}{2x+3} + 3 \sin(4x+1) dx$

$$= 2 \int \frac{1}{2x+3} + 3 \sin(4x+1) dx$$

$$= \frac{2}{2} \log_e(2x+3) - \frac{3}{4} \cos(4x+1) + c$$

$$= \log_e(2x+3) - \frac{3}{4} \cos(4x+1) + c$$

The correct answer is **B**.

9 $\frac{d}{dx} ((\log_e(x))^2) = 2 \times \log_e(x) \times \frac{1}{x}$
 $= \frac{2 \log_e(x)}{x}$

Therefore, $\int \frac{2 \log_e(x)}{x} dx = (\log_e(x))^2$

and $\int \frac{4 \log_e(x)}{x} dx = 2(\log_e(x))^2$.

The correct answer is **D**.

10 $\int \frac{d-2x^b+x}{ax} dx = \int \frac{d}{ax} - \frac{2x^b}{ax} + \frac{x}{ax} dx$

$\frac{d}{a}$ is the factor out the front of the $\log_e(x)$ term;

therefore, $\frac{d}{a} = \frac{5}{4}$, so $d = 5$ and $a = 4$.

$$\int \frac{x^b}{x} dx = x^2; \text{ therefore, } \frac{x^b}{x} = x, \text{ so } b = 2.$$

$$a = 4, b = 2, d = 5$$

7.4 Exam questions

1 $\int \frac{x^2 + 2x - 3}{x^2} dx = \int (1 + 2x^{-1} - 3x^{-2}) dx$

$$= x + 2 \log_e(x) + 3x^{-1} + c$$

$$= x + 2 \log_e(x) + \frac{3}{x} + c, x > 0 \quad [1 \text{ mark}]$$

2 From the rule,

$$\int kf(x) dx = k \int f(x) dx.$$

The correct answer is A.

3 Let $u = x$, $v = \log_e(x)$.

$$\frac{du}{dx} = 1, \quad \frac{dv}{dx} = \frac{1}{x}$$

$$f'(x) = \frac{1}{x} \times x + 1 \times \log_e(x)$$

$$= 1 + \log_e(x) \quad [1 \text{ mark}]$$

$$x \log_e(x) = \int (\log_e(x) + 1) dx$$

$$x \log_e(x) = \int \log_e(x) dx + \int 1 dx \quad [1 \text{ mark}]$$

$$\int \log_e(x) dx = x \log_e(x) - x \quad [1 \text{ mark}]$$

7.5 Families of curves

7.5 Exercise

1 a $f'(x) = 3x^2$, so $f(x) = x^3 + c$

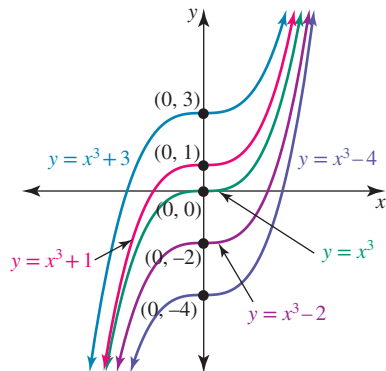

b $f(x) = x^3 + c$

$$f(2) = 16$$

$$2^3 + c = 16$$

$$8 + c = 16$$

$$c = 8$$

$$f(x) = x^3 + 8$$

2 a $f'(x) = -2 \cos(2x)$, so $f(x) = -\sin(2x) + c$

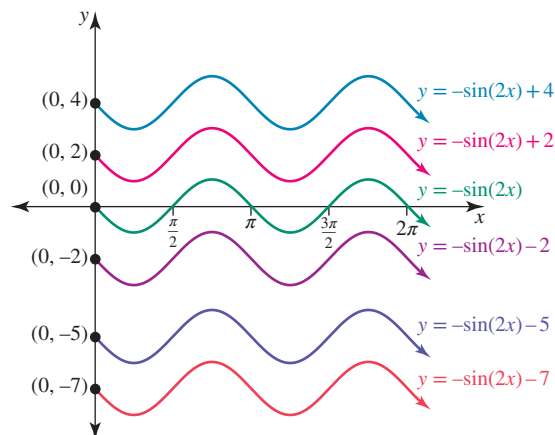

b $f(x) = -\sin(2x) + c$

$$f\left(\frac{\pi}{2}\right) = 4$$

$$4 = -\sin(\pi) + c$$

$$4 = 0 + c$$

$$c = 4$$

$$f(x) = 4 - \sin(2x)$$

3 a $f'(x) = 3e^{-3x}$

$$f(x) = -e^{-3x} + c$$

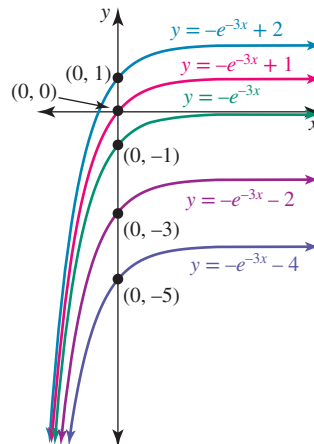

b $f(x) = -e^{-3x} + c$

When $x = 0$, $y = 1$.

$$1 = -e^0 + c$$

$$1 = -1 + c$$

$$c = 2$$

$$f(x) = 2 - e^{-3x}$$

4 $\frac{dy}{dx} = 2e^{2x} + e^{-x}$

$$y = e^{2x} - e^{-x} + c$$

When $x = 0$, $y = 3$.

$$3 = e^0 - e^0 + c$$

$$3 = 1 - 1 + c$$

$$c = 3$$

$$y = e^{2x} - e^{-x} + 3$$

5 $f'(x) = \cos(2x) - \sin(2x)$

$$f(x) = \frac{1}{2} \sin(2x) + \frac{1}{2} \cos(2x) + c$$

$$f(\pi) = 2$$

$$2 = \frac{1}{2} \sin(2\pi) + \frac{1}{2} \cos(2\pi) + c$$

$$2 = \frac{1}{2}(0) + \frac{1}{2}(1) + c$$

$$2 = \frac{1}{2} + c$$

$$c = \frac{3}{2}$$

$$f(x) = \frac{1}{2} \sin(2x) + \frac{1}{2} \cos(2x) + \frac{3}{2}$$

$$6 \quad \frac{dy}{dx} = \cos(2x) + 3e^{-3x}$$

$$y = \int (\cos(2x) + 3e^{-3x}) dx$$

$$= \frac{1}{2} \sin(2x) - e^{-3x} + c$$

$$\text{When } x = 0, y = 4.$$

$$4 = \frac{1}{2} \sin(0) - e^0 + c$$

$$4 = 0 - 1 + c$$

$$c = 5$$

$$y = \frac{1}{2} \sin(2x) - e^{-3x} + 5$$

$$7 \quad \frac{dy}{dx} = e^{\frac{x}{2}}$$

$$y = 2e^{\frac{x}{2}} + c$$

$$\text{When } x = 0, y = 5.$$

$$5 = 2e^0 + c$$

$$5 = 2 + c$$

$$c = 3$$

$$y = 2e^{\frac{x}{2}} + 3$$

$$8 \quad f'(x) = \frac{1}{(1-x)^2} = (1-x)^{-2}$$

$$f(x) = \frac{1}{(-1)(-1)}(1-x)^{-1} + c$$

$$f(x) = \frac{1}{(1-x)} + c$$

$$\text{When } f(0) = 4,$$

$$4 = \frac{1}{(1-0)} + c$$

$$4 = 1 + c$$

$$c = 3$$

$$f(x) = \frac{1}{(1-x)} + 3$$

$$9 \quad \text{a } f'(x) = 5 - 2x$$

$$f(x) = 5x - x^2 + c$$

$$\text{When } f(1) = 4,$$

$$4 = 5(1) - (1)^2 + c$$

$$4 = 4 + c$$

$$c = 0$$

$$f(x) = 5x - x^2$$

$$\text{b } f'(x) = \sin\left(\frac{x}{2}\right)$$

$$f(x) = -2 \cos\left(\frac{x}{2}\right) + c$$

$$\text{When } f(\pi) = 3,$$

$$3 = -2 \cos\left(\frac{\pi}{2}\right) + c$$

$$3 = 0 + c$$

$$c = 3$$

$$f(x) = 3 - 2 \cos\left(\frac{x}{2}\right)$$

$$10 \quad f(x) = \int \left(x^3 - \frac{1}{x}\right) dx$$

$$= \frac{x^4}{4} - \log_e(x) + c, x > 0$$

$$f(1) = \frac{1}{4}$$

$$\frac{1}{4} = \frac{1}{4} - \log_e(1) + c$$

$$c = 0$$

$$f(x) = \frac{x^4}{4} - \log_e(x), x > 0$$

$$11 \quad \text{a } \frac{dy}{dx} = \frac{5}{2x+4} \text{ is equivalent to}$$

$$\int \frac{5}{2x+4} dx = 5 \int \frac{1}{2x+4} dx$$

$$= \frac{5}{2} \log_e(2x+4) + c, x > -2$$

$$\text{Thus, } y = \frac{5}{2} \log_e(2(x+2)) + c \text{ and when } x = -\frac{3}{2}, y = 3.$$

$$3 = \frac{5}{2} \log_e\left(2\left(-\frac{3}{2}\right) + 4\right) + c$$

$$3 = \frac{5}{2} \log_e(1) + c$$

$$c = 3$$

$$y = \frac{5}{2} \log_e(2x+4) + 3$$

$$y = \frac{5}{2} \log_e(2(x+2)) + 3$$

$$\text{b } \frac{dy}{dx} = \frac{3}{2-5x} \text{ is equivalent to}$$

$$\int \frac{3}{2-5x} dx = 3 \int \frac{1}{2-5x} dx$$

$$= -\frac{3}{5} \log_e(2-5x) + c, x < \frac{2}{5}$$

$$\text{Thus, } y = -\frac{3}{5} \log_e(2-5x) + c \text{ and when } x = \frac{1}{5}, y = 1.$$

$$1 = -\frac{3}{5} \log_e\left(2-5\left(\frac{1}{5}\right)\right) + c$$

$$1 = -\frac{3}{5} \log_e(1) + c$$

$$c = 1$$

$$y = -\frac{3}{5} \log_e(2-5x) + 1$$

- 12 There is a stationary point at $x = 1$. When $x < 1$ the parabola has a positive gradient and when $x > 1$ the parabola has a negative gradient.

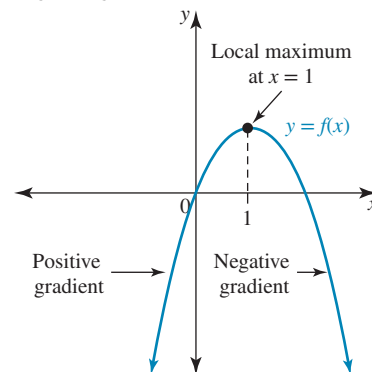

- 13 Stationary points occur at $x = -2$ and $x = 4$. When $x < -2$ and $x > 4$ the gradient is positive but when $-2 < x < 4$ the gradient is negative.

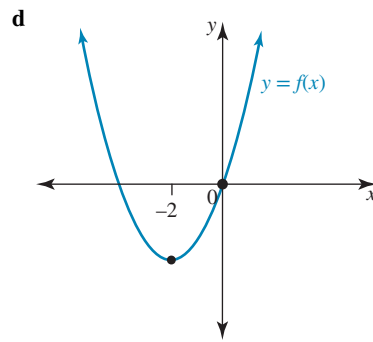
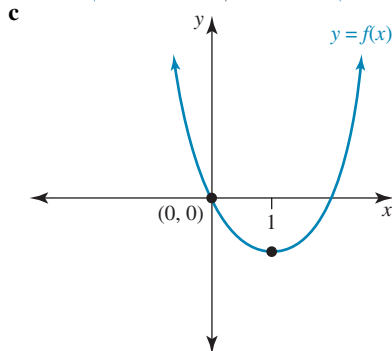
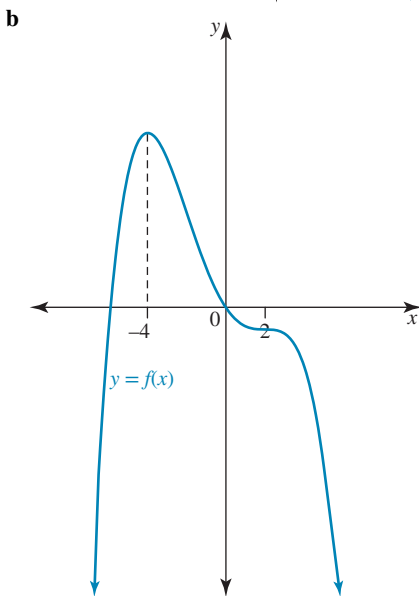
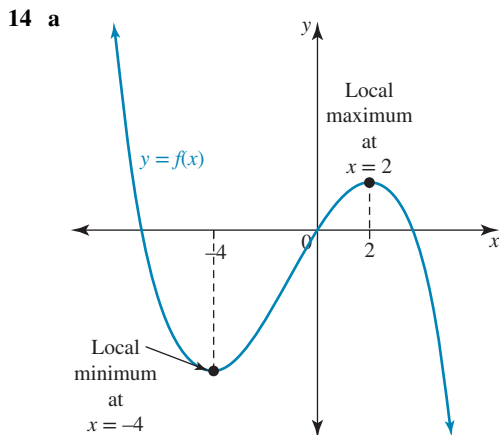
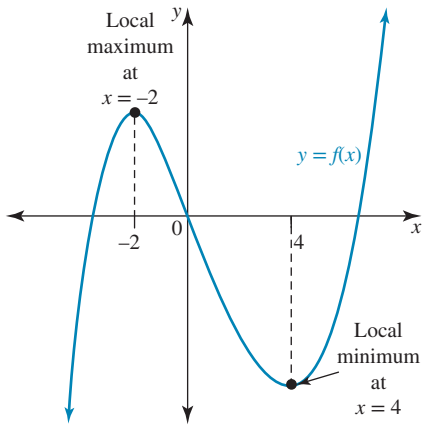

7.5 Exam questions

1 $f'(x) = \frac{2}{\sqrt{2x-3}} = 2(2x-3)^{-\frac{1}{2}}$

$$f(x) = \frac{2}{2 \times \frac{1}{2}} (2x-3)^{\frac{1}{2}} + c$$

$$f(x) = 2\sqrt{2x-3} + c$$

$$f(6) = 4 \Rightarrow 4 = 2\sqrt{9} + c, c = -2$$

$$f(x) = 2\sqrt{2x-3} - 2$$

The correct answer is C.

- 2 The gradient changes from positive to zero to negative to zero, then stays positive. The graph also has to be a quintic graph. Graph B is the only option.

The correct answer is B.

3 $f'(x) = 2 \cos(x) - \sin(2x)$

$$f(x) = \int (2 \cos(x) - \sin(2x)) dx$$

$$f(x) = 2 \sin(x) + \frac{1}{2} \cos(2x) + c$$

$$f\left(\frac{\pi}{2}\right) = \frac{1}{2}$$

$$\frac{1}{2} = 2 \sin\left(\frac{\pi}{2}\right) + \frac{1}{2} \cos(\pi) + c$$

$$\frac{1}{2} = 2 - \frac{1}{2} + c \Rightarrow c = -1$$

$$f(x) = 2 \sin(x) + \frac{1}{2} \cos(2x) - 1$$

Award 1 mark for the correct antiderivative.

Award 1 mark for attempting to find c .

Award 1 mark for the correct value of c .

7.6 Applications

7.6 Exercise

1 a $v = \frac{dx}{dt} = (3t+1)^{\frac{1}{2}}$

$$\begin{aligned} x &= \int (3t+1)^{\frac{1}{2}} dt \\ &= \frac{1}{3 \left(\frac{3}{2}\right)} (3t+1)^{\frac{3}{2}} + c \\ &= \frac{2}{9} (3t+1)^{\frac{3}{2}} + c \end{aligned}$$

When $t = 0$, $x = 0$.

$$0 = \frac{2}{9}(3(0) + 1)^{\frac{3}{2}} + c$$

$$0 = \frac{2}{9} + c$$

$$c = -\frac{2}{9}$$

$$x = \frac{2}{9}(3t + 1)^{\frac{3}{2}} - \frac{2}{9}$$

$$x = \frac{2}{9}\sqrt{(3t + 1)^3} - \frac{2}{9}$$

$$\mathbf{b} \quad v = \frac{dx}{dt} = \frac{1}{(t+2)^2} = (t+2)^{-2}$$

$$x = \int (t+2)^{-2} dt$$

$$= -\frac{1}{1}(t+2)^{-1} + c$$

$$= -\frac{1}{(t+2)} + c$$

When $t = 0$, $x = 0$.

$$0 = -\frac{1}{(0+2)} + c$$

$$0 = -\frac{1}{2} + c$$

$$c = \frac{1}{2}$$

$$x = \frac{1}{2} - \frac{1}{(t+2)}$$

$$\mathbf{c} \quad v = \frac{dx}{dt} = (2t+1)^3$$

$$x = \int (2t+1)^3 dt$$

$$= \frac{1}{2(4)}(2t+1)^4 + c$$

$$= \frac{1}{8}(2t+1)^4 + c$$

When $x = 0$, $t = 0$.

$$0 = \frac{1}{8}(2(0)+1)^4 + c$$

$$0 = \frac{1}{8} + c$$

$$c = -\frac{1}{8}$$

$$x = \frac{1}{8}(2t+1)^4 - \frac{1}{8}$$

$$\mathbf{d} \quad v = \frac{dx}{dt} = e^{(3t-1)}$$

$$x = \int e^{(3t-1)} dt$$

$$= \frac{1}{3}e^{(3t-1)} + c$$

When $t = 0$, $x = 0$.

$$0 = \frac{1}{3}e^{(3(0)-1)} + c$$

$$0 = \frac{1}{3}e^{-1} + c$$

$$c = -\frac{1}{3e}$$

$$x = \frac{1}{3}e^{(3t-1)} - \frac{1}{3e}$$

$$\mathbf{e} \quad v = \frac{dx}{dt} = -\sin(2t+3)$$

$$x = \int -\sin(2t+3) dt$$

$$= \frac{1}{2}\cos(2t+3) + c$$

When $t = 0$, $x = 0$.

$$0 = \frac{1}{2}\cos(2(0)+3) + c$$

$$0 = \frac{1}{2}\cos(3) + c$$

$$c = -\frac{1}{2}\cos(3)$$

$$x = \frac{1}{2}\cos(2t+3) - \frac{1}{2}\cos(3)$$

$$\mathbf{f} \quad v = \frac{dx}{dt} = 2\cos(3t)$$

$$x = \int 2\cos(3t) dt$$

$$= \frac{2}{3}\sin(3t) + c$$

When $t = 0$, $x = 0$.

$$0 = \frac{2}{3}\sin(0) + c$$

$$c = 0$$

$$x = \frac{2}{3}\sin(3t)$$

$$\mathbf{2} \quad v = \frac{dx}{dt} = 3t^2 + 7t$$

$$x = t^3 + \frac{7}{2}t^2 + c$$

When $t = 0$, $x = 0$.

$$0 = (0)^3 + \frac{7}{2}(0)^2 + c$$

$$c = 0$$

$$x = t^3 + \frac{7}{2}t^2$$

$$\mathbf{3} \quad \mathbf{a} \quad v = \frac{dx}{dt} = \frac{12}{(t-1)^2} + 6$$

$$v = \frac{dx}{dt} = 12(t-1)^{-2} + 6$$

$$x = -12(t-1)^{-1} + 6t + c$$

$$x = -\frac{12}{(t-1)} + 6t + c$$

When $t = 0$, $x = 0$.

$$0 = -\frac{12}{(0-1)} + 6(0) + c$$

$$c = -12$$

$$x = 6t - \frac{12}{(t-1)} - 12$$

\mathbf{b} When $t = 3$,

$$x = 6(3) - \frac{12}{(3-1)} - 12$$

$$= 18 - 6 - 12$$

$$= 0$$

After 3 seconds the particle is at the origin again.

$$\mathbf{4} \quad v = \frac{dx}{dt} = \sin(2t) + \cos(2t)$$

\mathbf{a} When $t = 0$,

$$v = \sin(0) + \cos(0)$$

$$v = 1 \text{ cm/s}$$

$$\begin{aligned} \mathbf{b} \quad x &= \int (\sin(2t) + \cos(2t)) dt \\ &= -\frac{1}{2} \cos(2t) + \frac{1}{2} \sin(2t) + c \end{aligned}$$

When $t = 0$, $x = 0$.

$$0 = -\frac{1}{2} \cos(0) + \frac{1}{2} \sin(0) + c$$

$$c = -\frac{1}{2} + c$$

$$0 = \frac{1}{2}$$

$$x = \frac{1}{2} - \frac{1}{2} \cos(2t) + \frac{1}{2} \sin(2t)$$

$$\mathbf{5} \quad \mathbf{a} \quad v = \frac{dx}{dt} = 3\pi \sin\left(\frac{\pi t}{8}\right)$$

$$x = -\frac{8}{\pi} \times 3\pi \cos\left(\frac{\pi t}{8}\right) + c$$

$$x = -24 \cos\left(\frac{\pi t}{8}\right) + c$$

When $t = 0$, $x = 0$.

$$0 = -24 \cos(0) + c$$

$$c = 24$$

$$x = 24 - 24 \cos\left(\frac{\pi t}{8}\right)$$

$$\mathbf{b} \quad x_{\max} = 24 - 24(-1) = 24 + 24 = 48$$

$$x_{\min} = 24 - 24(1) = 24 - 24 = 0$$

The maximum displacement is 48 metres.

$$\mathbf{c} \quad \text{When } t = 4, x = 24 - 24 \cos\left(\frac{\pi}{2}\right) = 24.$$

After 4 seconds the particle is 24 metres above the stationary position.

$$\mathbf{6} \quad v = 0.25t(50 - t) = 12.5t - 0.25t^2$$

\mathbf{a} The greatest velocity occurs when $\frac{dv}{dt} = 0$.

$$\frac{dv}{dt} = 12.5 - 0.5t$$

$$0 = 12.5 - 0.5t$$

$$0.5t = 12.5$$

$$t = 25$$

When $t = 25$, $v = 0.25(25)(50 - 25) = 156.25$ m/s.

$$\mathbf{b} \quad x = \int 0.25t(50 - t) dt$$

$$x = \int 12.5t - 0.25t^2$$

$$x = 6.25t^2 - \frac{1}{12}t^3 + c$$

When, $t = 0$, $x = 0$, so $c = 0$

$$x = 6.25t^2 - \frac{1}{12}t^3$$

$$\mathbf{7} \quad v = \frac{dx}{dt} = 2t \cos(t)$$

$$x = 2t \sin(t) + 2 \cos(t) + c$$

When $t = 0$, $x = 0$; $0 = 2(0) \sin(0) + 2 \cos(0) + c$, so $c = -2$.

$$x = 2t \sin(t) + 2 \cos(t) - 2$$

$$\mathbf{8} \quad \mathbf{a} \quad \frac{dV}{dr} = \pi r^2$$

$$V = \frac{1}{3} \pi r^3 + c$$

When $r = 0$, $V = 0$, so $c = 0$ and $V = \frac{1}{3} \pi r^3$.

$$\mathbf{b} \quad \text{When } r = 4, V = \frac{1}{3} \pi (4)^3 = \frac{64}{3} \pi \text{ cm}^3.$$

$$\mathbf{9} \quad \frac{dV}{dt} = 20t^2 - t^3$$

$$V = \frac{20}{3} t^3 - \frac{1}{4} t^4 + c$$

When $t = 0$, $V = 0$, so $c = 0$.

$$V = \frac{20}{3} t^3 - \frac{1}{4} t^4$$

When $t = 20$,

$$V = \frac{20}{3} (20)^3 - \frac{1}{4} (20)^4$$

$$V = 53\,333 \frac{1}{3} - 40\,000$$

$$V = 13\,333 \frac{1}{3} \text{ cm}^3$$

$$\mathbf{10} \quad \mathbf{a} \quad \frac{dP}{dt} = 30e^{0.3t}$$

$$P = \frac{30}{0.3} e^{0.3t} + c$$

$$P = 100e^{0.3t} + c$$

When $t = 0$, $P = 50$.

$$50 = 100e^0 + c$$

$$50 = 100 + c$$

$$c = -50$$

$$P = 100e^{0.3t} - 50$$

\mathbf{b} When $t = 10$, $P = 100e^3 - 50 = 1959$.

There are 1959 seals after 10 years.

$$\mathbf{11} \quad \mathbf{a} \quad \frac{dN}{dt} = 400 + 1000\sqrt{t}$$

$$\frac{dN}{dt} = 400 + 1000t^{\frac{1}{2}}$$

$$N = 400t + \frac{2000}{3} t^{\frac{3}{2}} + c$$

$$N = 400t + \frac{2000}{3} \sqrt{t^3} + c$$

When $t = 0$, $N = 40$.

$$40 = 400(0) + \frac{2000}{3} \sqrt{0^3} + c$$

$$c = 40$$

$$N = 400t + \frac{2000}{3} \sqrt{t^3} + 40$$

\mathbf{b} When $t = 5$,

$$N = 400(5) + \frac{2000}{3} \sqrt{(5)^3} + 40$$

$$N = 2000 + \frac{2000}{3} \sqrt{125} + 40$$

$$N = 9494 \text{ families}$$

$$\mathbf{12} \quad \frac{dh}{dt} = \frac{\pi}{2} \cos\left(\frac{\pi t}{4}\right)$$

$$\mathbf{a} \quad h = \frac{4}{\pi} \times \frac{\pi}{2} \sin\left(\frac{\pi t}{4}\right) + c = 2 \sin\left(\frac{\pi t}{4}\right) + c$$

When $t = 0$, $h = 3$.

$$3 = 2 \sin(0) + c$$

$$c = 3$$

$$h = 2 \sin\left(\frac{\pi t}{4}\right) + 3$$

\mathbf{b} Maximum depth = $2(1) + 3 = 5$ m

Minimum depth = $2(-1) + 3 = 1$ m

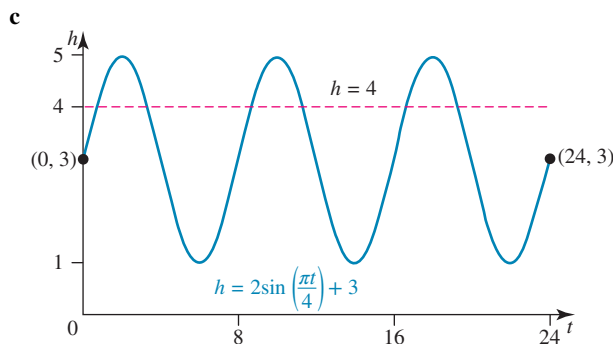

$$4 = 2 \sin\left(\frac{\pi t}{4}\right) + 3$$

$$1 = 2 \sin\left(\frac{\pi t}{4}\right)$$

$$\frac{1}{2} = \sin\left(\frac{\pi t}{4}\right)$$

$\frac{1}{2}$ indicates $\frac{\pi}{6}$. Since sin is positive, then 1st and 2nd quadrants.

$$\frac{\pi t}{4} = \frac{\pi}{6}, \pi - \frac{\pi}{6}, 2\pi + \frac{\pi}{6}, 3\pi - \frac{\pi}{6}, 4\pi + \frac{\pi}{6}, 5\pi - \frac{\pi}{6}$$

$$\frac{\pi t}{4} = \frac{\pi}{6}, \frac{5\pi}{6}, \frac{13\pi}{6}, \frac{17\pi}{6}, \frac{25\pi}{6}, \frac{29\pi}{6}$$

$$t = \frac{\pi}{6} \times \frac{4}{\pi}, \frac{5\pi}{6} \times \frac{4}{\pi}, \frac{13\pi}{6} \times \frac{4}{\pi}, \frac{17\pi}{6} \times \frac{4}{\pi}, \frac{25\pi}{6} \times \frac{4}{\pi}, \frac{29\pi}{6} \times \frac{4}{\pi}$$

$$t = \frac{2}{3}, \frac{10}{3}, \frac{26}{3}, \frac{34}{3}, \frac{50}{3}, \frac{58}{3}$$

$$h \geq 4 \text{ when } \left\{ h : \frac{2}{3} \leq t \leq \frac{10}{3} \right\} \cup \left\{ h : \frac{26}{3} \leq t \leq \frac{34}{3} \right\} \cup$$

$$\left\{ h : \frac{50}{3} \leq t \leq \frac{58}{3} \right\}$$

$$\text{This is } \frac{8}{3} + \frac{8}{3} + \frac{8}{3} = \frac{24}{3} = 8 \text{ hours/day.}$$

7.6 Exam questions

1 a $v = \frac{dx}{dt} = 2t^3 - t + 1$

$$x = \int 2t^3 - t + 1 dt$$

$$= \frac{1}{2}t^4 - \frac{1}{2}t^2 + t + c$$

When $t = 0$, $x = -1$.

$$-1 = \frac{1}{2}(0) - \frac{1}{2}(0) + 0 + c$$

$$c = -1$$

$$\text{Therefore, } x = \frac{1}{2}t^4 - \frac{1}{2}t^2 + t - 1. \quad [1 \text{ mark}]$$

b $t = 3$

$$x = \frac{1}{2}(3)^4 - \frac{1}{2}(3)^2 + 3 - 1$$

$$= \frac{81}{2} - \frac{9}{2} + 2$$

$$= 36 + 2$$

$$= 38$$

[1 mark]

$$v = 2t^3 - t + 1$$

$$= 2(3)^3 - 3 + 1$$

$$= 54 - 3 + 1$$

$$= 52$$

[1 mark]

After 3 seconds, the particle is 38 m to the right of the origin, with a velocity of 52 m/s.

2 a $a = \frac{dv}{dt} = 4 - 2t$

$$v = \int 4 - 2t dt$$

$$= 4t - t^2 + c$$

When $t = 0$, $v = 0$.

$$0 = 4(0) - (0)^2 + c$$

$$c = 0$$

Therefore, $v = 4t - t^2$.

$$v = \frac{dx}{dt} = 4t - t^2$$

$$= \int 4t - t^2 dt$$

$$= 2t^2 - \frac{1}{3}t^3 + c$$

When $t = 0$, $x = 3$.

$$3 = 2(0)^2 - \frac{1}{3}(0)^3 + c$$

$$c = 3$$

$$\text{Therefore, } x = 2t^2 - \frac{1}{3}t^3 + 3. \quad [1 \text{ mark}]$$

$$t = 2$$

$$v = 4(2) - (2)^2$$

$$= 8 - 4$$

$$= 4$$

$$x = 2(2)^2 - \frac{1}{3}(2)^3 + 3$$

$$= 8 - \frac{8}{3} + 3$$

$$= \frac{25}{3}$$

After 3 seconds, the particle is $\frac{25}{3}$ m to the right of the origin, with a velocity of 4 m/s. [1 mark]

3 a $\frac{db}{dt} = 100t^{\frac{3}{2}}$

$$b = \int 100t^{\frac{3}{2}} dt$$

$$= \frac{100t^{\frac{5}{2}}}{\frac{5}{2}} + c$$

$$= 40t^{\frac{5}{2}} + c$$

Initially, $b = 80$.

$$80 = 40(0)^{\frac{5}{2}} + c$$

$$80 = 0 + c$$

$$c = 80$$

$$\text{Therefore, } b = 40t^{\frac{5}{2}} + 80. \quad [1 \text{ mark}]$$

b $500 = 40t^{\frac{5}{2}} + 80$

$$t = 2.56$$

$$0.56139 \times 60 = 33.68 \quad [1 \text{ mark}]$$

Therefore, the bacteria will number 500 after 2 hours, 34 minutes.

7.7 Review

7.7 Exercise

Technology free: short answer

$$\begin{aligned}
 1 \text{ a } \int \frac{4x^4 - 4}{x^2} dx &= \int \frac{4x^4}{x^2} - \frac{4}{x^2} dx \\
 &= \int 4x^2 - 4x^{-2} dx \\
 &= \frac{4x^3}{3} - \frac{4x^{-1}}{-1} + c \\
 &= \frac{4x^3}{3} + \frac{4}{x} + c
 \end{aligned}$$

$$\begin{aligned}
 \text{b } \int (e^x - e^{-x})^2 dx &= \int e^{2x} - 2 \times e^x \times e^{-x} + e^{-2x} dx \\
 &= \int e^{2x} - 2 + e^{-2x} dx \\
 &= \frac{e^{2x}}{2} - \frac{e^{-2x}}{2} - 2x + c \\
 &= \frac{e^{2x}}{2} - \frac{1}{2e^{2x}} - 2x + c
 \end{aligned}$$

$$\begin{aligned}
 \text{c } \int \frac{e^{2x} + 3e^x + 2}{e^x + 1} dx &= \int \frac{(e^x + 2)(e^x + 1)}{e^x + 1} dx \\
 &= \int e^x + 2 dx \\
 &= e^x + 2x + c
 \end{aligned}$$

$$\begin{aligned}
 \text{d } \int -\frac{1}{3} \cos(4x - 3) - \sin\left(\frac{x}{2}\right) dx &= -\frac{1}{3 \times 4} \sin(4x - 3) + 2 \cos\left(\frac{x}{2}\right) + c \\
 &= 2 \cos\left(\frac{x}{2}\right) - \frac{1}{12} \sin(4x - 3) + c
 \end{aligned}$$

$$\begin{aligned}
 \text{e } \int \frac{4}{3-x} + \sin(x) dx &= \int \frac{-4}{x-3} + \sin(x) dx \\
 &= -4 \log_e(x-3) - \cos(x) + c
 \end{aligned}$$

$$\begin{aligned}
 \text{f } \int \frac{x^2 + 4x - 1}{x^2} dx &= \int \frac{x^2}{x^2} + \frac{4x}{x^2} - \frac{1}{x^2} dx \\
 &= \int 1 + \frac{4}{x} - x^{-2} dx \\
 &= x + 4 \log_e(x) - \frac{x^{-1}}{-1} + c \\
 &= 4 \log_e(x) + x + \frac{1}{x} + c
 \end{aligned}$$

$$\begin{aligned}
 2 \text{ a } \frac{dT}{dt} &= abe^{-bt} \\
 T &= \int abe^{-bt} dt
 \end{aligned}$$

$$\begin{aligned}
 &= \frac{abe^{-bt}}{-b} + c \\
 &= -ae^{-bt} + c
 \end{aligned}$$

$$\text{b } a = 100, b = 0.08 \text{ and } c = 195$$

$$T = -100e^{-0.08t} + 195$$

$$\text{At noon, } t = 0.$$

$$T = -100e^0 + 195$$

$$T = -100 + 195$$

$$T = 95^\circ\text{C}$$

$$3 \text{ a } f'(x) = (e^{2x} + 1)^2$$

$$\begin{aligned}
 f(x) &= \int (e^{2x} + 1)^2 dx \\
 &= \int e^{4x} + 2e^{2x} + 1 dx
 \end{aligned}$$

$$\begin{aligned}
 f(x) &= \frac{1}{4}e^{4x} + \frac{2e^{2x}}{2} + x + c \\
 &= \frac{1}{4}e^{4x} + e^{2x} + x + c
 \end{aligned}$$

$$f(0) = -\frac{5}{4}$$

$$-\frac{5}{4} = \frac{1}{4}e^0 + e^0 + 0 + c$$

$$-\frac{5}{4} = \frac{1}{4} + 1 + c$$

$$-\frac{5}{4} = \frac{5}{4} + c$$

$$c = -\frac{5}{4} - \frac{5}{4}$$

$$c = \frac{-10}{4}$$

$$c = \frac{-5}{2}$$

$$\text{So } f(x) = \frac{1}{4}e^{4x} + e^{2x} + x - \frac{5}{2}.$$

$$\text{b } \frac{dy}{dx} = \sqrt{3x-5}$$

$$y = \int \sqrt{3x-5} dx$$

$$= \int (3x-5)^{\frac{1}{2}} dx$$

$$y = \frac{2}{3} \times \frac{(3x-5)^{\frac{3}{2}}}{\frac{3}{2}} + c$$

$$y = \frac{2}{9} (3x-5)^{\frac{3}{2}} + c$$

$$\text{When } x = 2, y = 0.$$

$$0 = \frac{2}{9} (3(2) - 5)^{\frac{3}{2}} + c$$

$$0 = \frac{2}{9} (6 - 5)^{\frac{3}{2}} + c$$

$$0 = \frac{2}{9} (1)^{\frac{3}{2}} + c$$

$$c + \frac{2}{9} = 0$$

$$c = -\frac{2}{9}$$

$$y = \frac{2}{9} (3x-5)^{\frac{3}{2}} - \frac{2}{9}$$

$$y = \frac{2}{9} \sqrt{(3x-5)^3} - \frac{2}{9}$$

$$\begin{aligned}
 \text{c } f'(x) &= \frac{x^3 + 4x}{x^2} \\
 f(x) &= \int \frac{x^3 + 4x}{x^2} dx \\
 &= \int \frac{x^3}{x^2} + \frac{4x}{x^2} dx \\
 &= \int x + \frac{4}{x} dx \\
 &= \frac{x^2}{2} + 4 \log_e(x) + c \\
 f(1) &= \log_e(2) + \frac{1}{2} \\
 \log_e(2) + \frac{1}{2} &= \frac{1^2}{2} + 4 \log_e(1) + c \\
 \log_e(2) + \frac{1}{2} &= \frac{1}{2} + c \\
 c &= \log_e(2) \\
 \Rightarrow f(x) &= \frac{x^2}{2} + 4 \log_e(x) + \log_e(2)
 \end{aligned}$$

$$\begin{aligned}
 \text{4 a i } f'(x) &= x^2 - 2x \\
 f(x) &= \int x^2 - 2x dx \\
 &= \frac{x^3}{3} - \frac{2x^2}{2} + c \\
 &= \frac{x^3}{3} - x^2 + c
 \end{aligned}$$

We can also determine the position of the turning point by finding where the derivative is equal to zero.

$$\begin{aligned}
 f'(x) &= 0 \\
 x^2 - 2x &= 0 \\
 x(x - 2) &= 0 \\
 x &= 0, x = 2
 \end{aligned}$$

Therefore, the graphs in the family of curves will follow the shape of a positive cubic with turning points at $x = 0$ and $x = 2$.

Also, each graph in the family of curves will be translated up or down depending on its c value.

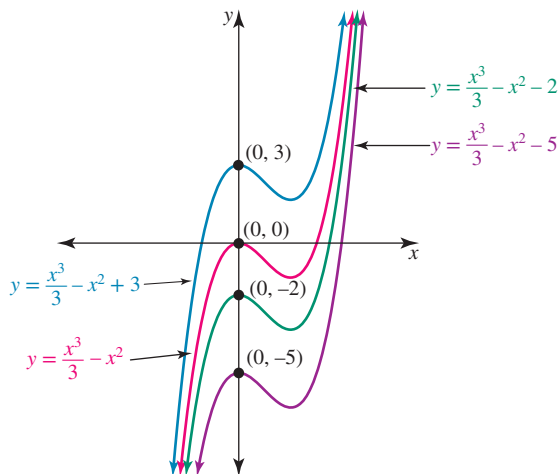

$$\begin{aligned}
 \text{ii } f'(x) &= -6e^{-3x} \\
 f(x) &= \int -6e^{-3x} dx \\
 &= \frac{-6e^{-3x}}{-3} + c \\
 &= 2e^{-3x} + c
 \end{aligned}$$

Therefore, the graphs in this family of curves are exponential graphs reflected in the y -axis and following the curve of $f(x) = 2e^{-3x}$. However each graph will be translated up or down depending on its c value, which will correspond to an asymptote of $y = c$.

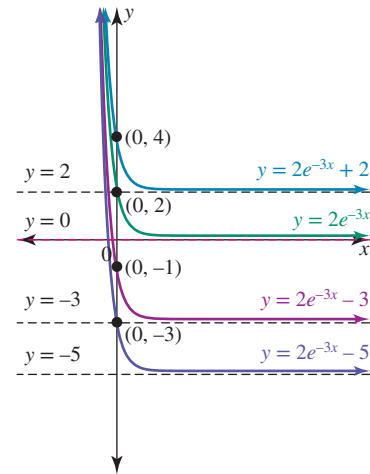

b i Since the gradient graph is a negative parabola, $f(x)$ will be a negative cubic. From the gradient graph it can be seen that the gradient is equal to zero when $x = 1$. Therefore, there is a stationary point at $x = 1$. When $x < 1$, the gradient is negative, and when $x > 1$, the gradient is also negative. Therefore, $f(x)$ is a negative cubic with a stationary point of inflection at $x = 1$.

x	$x < 1$	$x = 1$	$x > 1$
$f'(x)$	$f'(x) < 0$	$f'(x) = 0$	$f'(x) < 0$
slope			

One possible graph of $f(x)$ is shown.

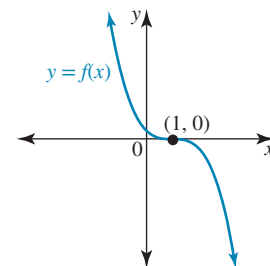

ii Since the gradient graph is a positive cubic, $f(x)$ will be a positive quartic. From the gradient graph it can be seen that the gradient is equal to zero when $x = -2$, $x = 0$ and $x = 2$. Therefore, there is a stationary point at $x = -2$, $x = 0$ and $x = 2$. When $x < -2$, the gradient is negative. When $-2 < x < 0$, the gradient is positive. Therefore, there is a local minimum at $x = -2$. When $0 < x < 2$, the gradient is negative. Therefore, there is a local maximum at $x = 0$. When $x > 2$, the gradient is positive. Therefore, there is a local minimum at $x = 2$.

See the table at the bottom of the page.*
One possible graph of $f(x)$ is shown.

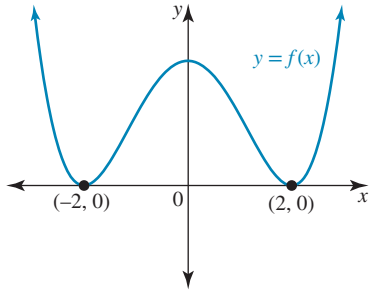

$$5 \quad \frac{dV}{dt} = 3.5 - (t - 0.5)^{-2}$$

$$V = \int 3.5 - (t - 0.5)^{-2} dt$$

$$V = 3.5t + (t - 0.5)^{-1} + c$$

$$V = 3.5t + \frac{1}{(t - 0.5)} + c$$

When $t = 0$, $V = 0$.

$$0 = 3.5(0) + \frac{1}{(0 - 0.5)} + c$$

$$0 = \frac{1}{-0.5} + c$$

$$c = \frac{1}{0.5}$$

$$c = 1 \div \frac{1}{2}$$

$$c = 2$$

The volume of oxygen inhaled after t minutes is given by

$$V = 3.5t + \frac{1}{(t - 0.5)} + 2.$$

6 a

$$y = e^{3x^2 - 2x + 1}$$

$$\frac{dy}{dx} = (6x - 2)e^{3x^2 - 2x + 1}$$

$$\frac{d}{dx} (e^{3x^2 - 2x + 1}) = (6x - 2)e^{3x^2 - 2x + 1}$$

$$\int \frac{d}{dx} (e^{3x^2 - 2x + 1}) dx = \int (6x - 2)e^{3x^2 - 2x + 1} dx$$

$$e^{3x^2 - 2x + 1} = \int 2(3x - 1)e^{3x^2 - 2x + 1} dx$$

$$2 \int (3x - 1)e^{3x^2 - 2x + 1} dx = e^{3x^2 - 2x + 1}$$

$$\int (3x - 1)e^{3x^2 - 2x + 1} dx = \frac{1}{2} e^{3x^2 - 2x + 1}$$

b

$$y = x \sin(2x)$$

$$\frac{dy}{dx} = x \times 2 \cos(2x) + 1 \times \sin(2x)$$

$$= 2x \cos(2x) + \sin(2x)$$

$$\frac{d}{dx} (x \sin(2x)) = 2x \cos(2x) + \sin(2x)$$

$$\int \frac{d}{dx} (x \sin(2x)) dx = \int 2x \cos(2x) + \sin(2x) dx$$

$$x \sin(2x) = \int 2x \cos(2x) dx + \int \sin(2x) dx$$

$$\int 2x \cos(2x) dx = x \sin(2x) - \int \sin(2x) dx$$

$$2 \int x \cos(2x) dx = x \sin(2x) + \frac{\cos(2x)}{2}$$

$$\int x \cos(2x) dx = \frac{1}{2} \left(x \sin(2x) + \frac{\cos(2x)}{2} \right)$$

$$\int x \cos(2x) dx = \frac{x \sin(2x)}{2} + \frac{\cos(2x)}{4}$$

Technology active: multiple choice

7

$$\int \frac{5x^2 - x + 2}{4\sqrt{x}} dx$$

$$= \int \frac{5x^2}{4\sqrt{x}} - \frac{x}{4\sqrt{x}} + \frac{2}{4\sqrt{x}} dx$$

$$= \int \frac{5x^{\frac{3}{2}}}{4} - \frac{x^{\frac{1}{2}}}{4} + \frac{2x^{-\frac{1}{2}}}{4} dx$$

$$= \frac{5}{4} \times \frac{2}{5} x^{\frac{5}{2}} - \frac{1}{4} \times \frac{2}{3} x^{\frac{3}{2}} + \frac{1}{2} \times 2x^{\frac{1}{2}} + c$$

$$= \frac{x^{\frac{5}{2}}}{2} - \frac{x^{\frac{3}{2}}}{6} + \sqrt{x} + c$$

The correct answer is **D**.

8

$$\int \frac{1}{(4x - 1)^{\frac{3}{2}}} dx$$

$$= \int (4x - 1)^{-\frac{3}{2}} dx$$

$$= \frac{-2 \times (4x - 1)^{-\frac{1}{2}}}{4}$$

$$= \frac{-(4x - 1)^{-\frac{1}{2}}}{2}$$

$$= -\frac{1}{2\sqrt{4x - 1}}$$

The correct answer is **E**.

9

$$\int \left(\cos\left(\frac{x}{5}\right) + 3e^{-3x} \right) dx = 5 \sin\left(\frac{x}{5}\right) + \frac{3}{-3} e^{-3x}$$

$$= 5 \sin\left(\frac{x}{5}\right) - e^{-3x}$$

The correct answer is **A**.

10

$$f'(x) = g'(x) + 2$$

$$f(x) = \int g'(x) + 2 dx$$

$$= g(x) + 2x + c$$

$$f(0) = 3$$

$$3 = g(0) + 2 \times 0 + c$$

$$3 = g(0) + c$$

*4b ii

x	$x < -2$	$x = -2$	$-2 < x < 0$	$x = 0$	$0 < x < 2$	$x = 2$	$x > 2$
$f'(x)$	$f'(x) < 0$	$f'(x) = 0$	$f'(x) > 0$	$f'(x) = 0$	$f'(x) < 0$	$f'(x) = 0$	$f'(x) > 0$
slope							

$$g(0) = 1$$

$$3 = 1 + c$$

$$2 = c$$

$$f(x) = g(x) + 2x + 2$$

The correct answer is **A**.

11 $\int ae^{bx} dx = -3e^{4x} + c$

$$\frac{a}{b}e^{bx} + c = -3e^{4x} + c$$

$$\frac{a}{b}e^{bx} = -3e^{4x}$$

So $b = 4$

and $\frac{a}{4} = -3$

$$a = -12$$

The correct answer is **D**.

12 $v = 2t + 3$

$$\frac{dx}{dt} = 2t + 3$$

$$x = \int 2t + 3 dt$$

$$= t^2 + 3t + c$$

When $t = 0$, $x = 0$, so $c = 0$.

Thus, $x = t^2 + 3t$.

The correct answer is **C**.

13 $v = -\sin(2t)$

$$\frac{dx}{dt} = -\sin(2t)$$

$$x = \int -\sin(2t) dt$$

$$= \frac{1}{2} \cos(2t) + c$$

When $t = 0$, $x = 2$.

$$2 = \frac{1}{2} \cos(0) + c$$

$$2 = \frac{1}{2} \times 1 + c$$

$$c = 2 - \frac{1}{2}$$

$$c = \frac{3}{2}$$

So $x = \frac{1}{2} \cos(2t) + \frac{3}{2}$.

The correct answer is **A**.

14 $f'(x) = \frac{4x}{\pi^2} + \sin(2x)$

$$f(x) = \int \frac{4x}{\pi^2} + \sin(2x) dx$$

$$= \frac{2x^2}{\pi^2} - \frac{1}{2} \cos(2x) + c$$

$$f\left(\frac{\pi}{4}\right) = \frac{1}{4}$$

$$\frac{1}{4} = \left(2\left(\frac{\pi}{4}\right)^2 \times \frac{1}{\pi^2}\right) - \frac{1}{2} \cos\left(\frac{\pi}{2}\right) + c$$

$$\frac{1}{4} = \frac{2}{16} + c$$

$$c = \frac{2}{8} - \frac{1}{8}$$

$$c = \frac{1}{8}$$

$$\text{So } f(x) = \frac{2x^2}{\pi^2} - \frac{1}{2} \cos(2x) + \frac{1}{8}.$$

The correct answer is **B**.

15 $\frac{dy}{dx} = 4 \cos(2x) + 2 \sin(2x)$

$$y = \int 4 \cos(2x) + 2 \sin(2x) dx$$

$$= \frac{4}{2} \sin(2x) - \frac{2}{2} \cos(2x) + c$$

$$= 2 \sin(2x) - \cos(2x) + c$$

When $x = 0$, $y = 0$.

$$0 = 2 \sin(2 \times 0) - \cos(2 \times 0) + c$$

$$0 = 2 \times 0 - 1 + c$$

$$c = 1$$

$$\text{So } y = 2 \sin(2x) - \cos(2x) + 1.$$

The correct answer is **A**.

16 $f'(x) = \cos(3x) - e^{-3x}$

$$f(x) = \frac{1}{3} \sin(3x) + \frac{1}{3} e^{-3x} + c$$

$$f(0) = \frac{2}{3}$$

$$\frac{2}{3} = \frac{1}{3} \sin(0) + \frac{1}{3} e^0 + c$$

$$\frac{2}{3} = \frac{1}{3} + c$$

$$c = \frac{2}{3} - \frac{1}{3}$$

$$c = \frac{1}{3}$$

So

$$f(x) = \frac{1}{3} \sin(3x) + \frac{1}{3} e^{-3x} + \frac{1}{3}$$

$$= \frac{1}{3} (\sin(3x) + e^{-3x} + 1)$$

The correct answer is **D**.

Technology active: extended response

17 a $v = \frac{dx}{dt}$

$$= 3 \sin(3t) + 1$$

$$x = \int (3 \sin(3t) + 1) dt$$

$$= -\cos(3t) + t + c$$

When $t = 0$, $x = 0$.

$$0 = -\cos(0) + 0 + c$$

$$0 = -1 + c$$

$$c = 1$$

$$x = -\cos(3t) + t + 1 \text{ as required}$$

b The particle comes to rest when $v = 0$.

$$3 \sin(3t) + 1 = 0$$

$$3 \sin(3t) = -1$$

$$\sin(3t) = -\frac{1}{3}$$

$$3t = \sin^{-1}\left(-\frac{1}{3}\right)$$

$$\sin^{-1}\left(\frac{1}{3}\right) = 0.3398. \text{ Since } \sin \text{ is negative, 3rd quadrant:}$$

$$3t = \pi + 0.3398$$

$$3t = 3.4814$$

$$t = \frac{3.4814}{3} = 1.160$$

The particle comes to rest after 1.160 seconds.

c Maximum velocity when $\sin(3t) = 1$

$$v = 3 \times 1 + 1$$

$$= 4 \text{ m/s}$$

Therefore, the maximum velocity is 4 m/s.

d When $t = 3$,

$$x = -\cos(3 \times 3) + 3 + 1$$

$$= 4.911$$

Therefore, the particle is 4.911 metres to the right of the origin after 3 seconds.

18 a $\frac{dT}{dt} = me^{nt}$

When $t = 0$, $\frac{dT}{dt} = -8$.

$$-8 = me^0$$

$$-8 = m \times 1$$

$$m = -8$$

b $\frac{dT}{dt} = -8e^{nt}$

When $t = 10$, $\frac{dT}{dt} = -4$.

$$-4 = -8e^{10n}$$

$$e^{10n} = \frac{-4}{-8}$$

$$e^{10n} = \frac{1}{2}$$

$$10n = \log_e\left(\frac{1}{2}\right)$$

$$10n = \log_e(2^{-1})$$

$$10n = -\log_e(2)$$

$$n = \frac{-\log_e(2)}{10}$$

c $\frac{dT}{dt} = -8e^{-\frac{\log_e(2)}{10}t}$

$$T = \left(-8 \div \frac{-\log_e(2)}{10}\right) e^{-\frac{t \log_e(2)}{10}} + c$$

$$= \left(-8 \times \frac{10}{-\log_e(2)}\right) e^{-\frac{t \log_e(2)}{10}} + c$$

$$= \frac{80e^{-\frac{t \log_e(2)}{10}}}{\log_e(2)} + c$$

When $t = 0$, $T = 98$.

$$98 = \frac{80e^{-0 \times \frac{\log_e(2)}{10}}}{\log_e(2)} + c$$

$$c = 98 - \frac{80}{\log_e(2)}$$

So,

$$T = \frac{80e^{-\frac{t \log_e(2)}{10}}}{\log_e(2)} + 98 - \frac{80}{\log_e(2)}$$

d When $t = 5$,

$$T = \frac{80e^{-\frac{5 \times \log_e(2)}{10}}}{\log_e(2)} + 98 - \frac{80}{\log_e(2)}$$

$$= 64.2$$

Therefore, the coffee will be 64 °C five minutes after it was made.

19 a If the townhouses are currently 5 years old, then after the next year the townhouses will be 6 years old.

Therefore, when $a = 6$,

$$\frac{dM}{da} = 48(6)^2 + 250$$

$$= \$1978$$

b $M = \int 48a^2 + 250 da$

$$= \frac{48}{3}a^3 + 250a + c$$

$$= 16a^3 + 250a + c$$

When $a = 1$, $M = \$350$.

$$350 = 16(1)^3 + 250(1) + c$$

$$350 = 16 + 250 + c$$

$$c = 350 - 266$$

$$c = 84$$

$$M = 16a^3 + 250a + 84$$

c Accumulated cost per townhouse now means $a = 5$.

$$M = 16(5)^3 + 250(5) + 84$$

$$= \$3334$$

Accumulated cost per townhouse in 5 years time means

$a = 10$.

$$M = 16(10)^3 + 250(10) + 84$$

$$= \$18\,584$$

Cost over the next 5 years per townhouse is:

$$18\,584 - 3\,334 = \$15\,250$$

20 a $\frac{dr}{dt} = \frac{30}{\sqrt{t+1}} dt$

$$r = \int \frac{30}{\sqrt{t+1}} dt$$

$$= \int 30(t+1)^{-\frac{1}{2}}$$

$$= 30 \times 2(t+1)^{\frac{1}{2}} + c$$

$$r = 60\sqrt{t+1} + c$$

When $t = 3$, $r = 45$.

$$45 = 60\sqrt{3+1} + c$$

$$45 = 60 \times \sqrt{4} + c$$

$$c = 45 - 60 \times 2$$

$$= 45 - 120$$

$$= -75$$

$$r = 60\sqrt{t+1} - 75$$

b When $t = 5$,

$$r = 60\sqrt{5+1} - 75$$

$$= 60\sqrt{6} - 75$$

$$= 71.969$$

Therefore, after 5 hours the oil slick has a radius of 72 metres.

$$\begin{aligned}
 \text{c When } r = 75, \\
 75 &= 60\sqrt{t+1} - 75 \\
 150 &= 60\sqrt{t+1} \\
 \sqrt{t+1} &= \frac{150}{60} \\
 \sqrt{t+1} &= \frac{5}{2} \\
 t+1 &= \left(\frac{5}{2}\right)^2 \\
 t+1 &= \frac{25}{4} \\
 t &= \frac{25}{4} - 1 \\
 t &= \frac{21}{4} \\
 t &= 5\frac{1}{4}
 \end{aligned}$$

After 5 hours and 15 minutes the hole should be plugged.

7.7 Exam questions

1 $f'(x) = 3x^2 - 2x$

$$f(x) = \int (3x^2 - 2x) dx = x^3 - x^2 + c$$

$$f(4) = 0 \Rightarrow 0 = 46 - 16 + c, \quad c = -48$$

$$f(x) = x^3 - x^2 - 48$$

The correct answer is **C**.

2 $\frac{dy}{dx} = \frac{1}{x^2}$

$$\begin{aligned}
 y &= \int \frac{1}{x^2} dx \\
 &= -\frac{1}{x} + c
 \end{aligned}$$

The correct answer is **A**.

$$\begin{aligned}
 \text{3 } \int \frac{1}{(3x-4)^{\frac{5}{2}}} dx &= \int (3x-4)^{-\frac{5}{2}} dx \\
 &= \frac{(3x-4)^{-\frac{3}{2}}}{3 \times -\frac{3}{2}} \\
 &= \frac{(3x-4)^{-\frac{3}{2}}}{-\frac{9}{2}} \\
 &= -\frac{2(3x-4)^{-\frac{3}{2}}}{9}
 \end{aligned}$$

The correct answer is **E**.

4 $\frac{dy}{dx} = 6x - 1$

$$\begin{aligned}
 y &= \int (6x - 1) dx \\
 &= 3x^2 - x + C
 \end{aligned}$$

When $x = 2$ and $y = 1$,

$$1 = 12 - 2 + C \Rightarrow C = -9$$

$$y = 3x^2 - x - 9$$

The correct answer is **B**.

5 $\frac{d}{dx}(x \sin(x)) = \sin(x) + x \cos(x)$ [1 mark]

$$\int (x \cos(x)) dx = x \sin(x) - \int \sin(x) dx$$
 [1 mark]

$$= x \sin(x) + \cos(x)$$
 [1 mark]

Topic 8 — Integral calculus

8.2 The fundamental theorem of integral calculus

8.2 Exercise

$$\begin{aligned}
 1 \quad A &= \frac{1}{2} (f(0.5) + f(1)) \times 0.5 + \frac{1}{2} (f(1) + f(1.5)) \times 0.5 \\
 &\quad + \frac{1}{2} (f(1.5) + f(2)) \times 0.5 + \frac{1}{2} (f(2) + f(2.5)) \times 0.5 \\
 &= \frac{1}{2} (2 + 1) \times 0.5 + \frac{1}{2} \left(1 + \frac{2}{3}\right) \times 0.5 + \frac{1}{2} \left(\frac{2}{3} + \frac{1}{2}\right) \\
 &\quad \times 0.5 + \frac{1}{2} \left(\frac{1}{2} + \frac{2}{5}\right) \times 0.5 \\
 &= \frac{1}{4} \left(3 + \frac{5}{3} + \frac{7}{6} + \frac{9}{10}\right) \\
 &= \frac{1}{4} \times \frac{204}{30} \\
 &= \frac{51}{30} \text{ units}^2
 \end{aligned}$$

$$\begin{aligned}
 2 \quad A &= \frac{1}{2} (f(0) + f(1)) \times 1 + \frac{1}{2} (f(1) + f(2)) \times 1 + \frac{1}{2} (f(2) + f(3)) \\
 &\quad \times 1 + \frac{1}{2} (f(3) + f(4)) \times 1 \\
 &= \frac{1}{2} (8 + 9) + \frac{1}{2} (9 + 8) + \frac{1}{2} (8 + 5) + \frac{1}{2} (5 + 0) \\
 &= \frac{1}{2} (17 + 17 + 13 + 5) \\
 &= \frac{1}{2} \times 52 \\
 &= 26 \text{ units}^2
 \end{aligned}$$

3 Area from $x = 0$ to $x = 4$:

$$\begin{aligned}
 A &= \frac{1}{2} (f(0) + f(1)) \times 1 + \frac{1}{2} (f(1) + f(2)) \times 1 + \frac{1}{2} (f(2) + f(3)) \\
 &\quad \times 1 + \frac{1}{2} (f(3) + f(4)) \times 1 \\
 &= \frac{1}{2} \left(4 + \frac{15}{4}\right) + \frac{1}{2} \left(\frac{15}{4} + 3\right) + \frac{1}{2} \left(3 + \frac{7}{4}\right) + \frac{1}{2} \left(\frac{7}{4} + 0\right) \\
 &= \frac{1}{2} \left(\frac{31}{4} + \frac{27}{4} + \frac{19}{4} + \frac{7}{4}\right) \\
 &= \frac{1}{2} \times \frac{84}{4} \\
 &= 10.5 \text{ units}^2
 \end{aligned}$$

Therefore, due to symmetry, the total area is 21 units².

$$\begin{aligned}
 4 \quad \mathbf{a} \quad &\int_0^1 (4x^3 + 3x^2 + 2x + 1) dx \\
 &= [x^4 + x^3 + x^2 + x]_0^1 \\
 &= (1^4 + 1^3 + 1^2 + 1) - 0 \\
 &= 4
 \end{aligned}$$

$$\begin{aligned}
 \mathbf{b} \quad &\int_{-\pi}^{\pi} (\cos(x) + \sin(x)) dx \\
 &= [\sin(x) - \cos(x)]_{-\pi}^{\pi} \\
 &= (\sin(\pi) - \cos(\pi)) - (\sin(-\pi) - \cos(-\pi)) \\
 &= (0 - (-1)) - (0 - (-1)) \\
 &= 1 - 1 \\
 &= 0
 \end{aligned}$$

$$5 \quad \mathbf{a} \quad (x+1)^3 = x^3 + 3x^2 + 3x + 1$$

$$\begin{aligned}
 \int_{-3}^2 (x+1)^3 dx &= \int_{-3}^2 (x^3 + x^2 + x + 1) dx \\
 &= \left[\frac{1}{4}x^4 + x^3 + \frac{3}{2}x^2 + x \right]_{-3}^2 \\
 &= \left(\frac{1}{4}(2)^4 + (2)^3 + \frac{3}{2}(2)^2 + (2) \right) \\
 &\quad - \left(\frac{1}{4}(-3)^4 + (-3)^3 + \frac{3}{2}(-3)^2 + (-3) \right) \\
 &= (4 + 8 + 6 + 2) - \left(\frac{81}{4} - 27 + \frac{27}{2} - 3 \right) \\
 &= 20 - \left(\frac{135}{4} - 30 \right) \\
 &= \frac{80}{4} - \left(\frac{135}{4} - \frac{120}{4} \right) \\
 &= \frac{80}{4} - \frac{15}{4} \\
 &= \frac{65}{4}
 \end{aligned}$$

$$\begin{aligned}
 \mathbf{b} \quad &\int_0^1 (e^x + e^{-x})^2 dx = \int_0^1 (e^{2x} + 2 + e^{-2x}) dx \\
 &= \left[\frac{1}{2}e^{2x} + 2x - \frac{1}{2}e^{-2x} \right]_0^1 \\
 &= \left(\frac{1}{2}e^{2(1)} + 2(1) - \frac{1}{2}e^{-2(1)} \right) \\
 &\quad - \left(\frac{1}{2}e^0 + 2(0) - \frac{1}{2}e^0 \right) \\
 &= \frac{1}{2}e^2 + 2 - \frac{1}{2}e^{-2} - \frac{1}{2} + \frac{1}{2} \\
 &= 2 + 0.5e^2 - 0.5e^{-2}
 \end{aligned}$$

$$\begin{aligned}
 6 \quad \mathbf{a} \quad &\int_0^3 (3x^2 - 2x + 3) dx = [x^3 - x^2 + 3x]_0^3 \\
 &= (3^3 - 3^2 + 3(3)) - 0 \\
 &= 27 - 9 + 9 \\
 &= 27
 \end{aligned}$$

$$\begin{aligned}
 \mathbf{b} \quad &\int_1^2 \left(\frac{2x^3 + 3x^2}{x} \right) dx = \int_1^2 (2x^2 + 3x) dx, \quad x \neq 0 \\
 &= \left[\frac{2}{3}x^3 + \frac{3}{2}x^2 \right]_1^2 \\
 &= \left(\frac{2}{3}(2)^3 + \frac{3}{2}(2)^2 \right) \\
 &\quad - \left(\frac{2}{3}(1)^3 + \frac{3}{2}(1)^2 \right) \\
 &= \frac{16}{3} + 6 - \frac{2}{3} - \frac{3}{2} \\
 &= \frac{28}{6} + \frac{36}{6} - \frac{9}{6} \\
 &= \frac{55}{6}
 \end{aligned}$$

$$\begin{aligned} \text{c } \int_{-1}^1 (e^{2x} - e^{-2x}) dx &= \left[\frac{1}{2}e^{2x} + \frac{1}{2}e^{-2x} \right]_{-1}^1 \\ &= \left(\frac{1}{2}e^{2(1)} + \frac{1}{2}e^{-2(1)} \right) - \left(\frac{1}{2}e^{2(-1)} + \frac{1}{2}e^{-2(-1)} \right) \\ &= \frac{1}{2}e^2 + \frac{1}{2}e^{-2} - \frac{1}{2}e^{-2} - \frac{1}{2}e^2 \\ &= 0 \end{aligned}$$

$$\begin{aligned} \text{d } \int_{2\pi}^{4\pi} \sin\left(\frac{x}{3}\right) dx &= \left[-3 \cos\left(\frac{x}{3}\right) \right]_{2\pi}^{4\pi} \\ &= -3 \cos\left(\frac{4\pi}{3}\right) + 3 \cos\left(\frac{2\pi}{3}\right) \\ &= 1.5 - 1.5 \\ &= 0 \end{aligned}$$

$$\begin{aligned} \text{e } \int_{-3}^{-1} \frac{2}{\sqrt{1-3x}} dx &= 2 \int_{-3}^{-1} (1-3x)^{-\frac{1}{2}} dx \\ &= 2 \left[2 \left(-\frac{1}{3} \right) (1-3x)^{\frac{1}{2}} \right]_{-3}^{-1} \\ &= 2 \left(-\frac{2}{3}(1+3)^{\frac{1}{2}} + \frac{2}{3}(1+9)^{\frac{1}{2}} \right) \\ &= 2 \left(-\frac{4}{3} + \frac{2\sqrt{10}}{3} \right) \\ &= \frac{4}{3}(\sqrt{10} - 2) \end{aligned}$$

$$\begin{aligned} \text{f } \int_{-\frac{\pi}{3}}^{\frac{\pi}{2}} \left(\cos(2x) - \sin\left(\frac{x}{2}\right) \right) dx &= \left[\frac{1}{2} \sin(2x) + 2 \cos\left(\frac{x}{2}\right) \right]_{-\frac{\pi}{3}}^{\frac{\pi}{2}} \\ &= \left(\frac{1}{2} \sin(\pi) + 2 \cos\left(\frac{\pi}{4}\right) \right) \\ &\quad - \left(\frac{1}{2} \sin\left(-\frac{2\pi}{3}\right) + 2 \cos\left(-\frac{\pi}{6}\right) \right) \\ &= \left(\frac{1}{2}(0) + \sqrt{2} \right) - \left(\frac{1}{2} \left(-\frac{\sqrt{3}}{2} \right) \right) \\ &\quad + 2 \left(\frac{\sqrt{3}}{2} \right) \\ &= \sqrt{2} - \frac{3\sqrt{3}}{4} \end{aligned}$$

7 If $y = \log_e(3x^3 - 4)$

$$\frac{dy}{dx} = \frac{9x^2}{3x^3 - 4}$$

$$\int_2^3 \frac{9x^2}{3x^3 - 4} dx = [\log_e(3x^3 - 4)]_2^3$$

$$9 \int_2^3 \frac{x^2}{3x^3 - 4} dx = [\log_e(3x^3 - 4)]_2^3$$

$$\int_2^3 \frac{x^2}{3x^3 - 4} dx = \frac{1}{9} [\log_e(3x^3 - 4)]_2^3$$

$$\int_2^3 \frac{x^2}{3x^3 - 4} dx = \frac{1}{9} (\log_e(3(3)^3 - 4) - \log_e(3(2)^3 - 4))$$

$$\int_2^3 \frac{x^2}{3x^3 - 4} dx = \frac{1}{9} (\log_e(77) - \log_e(20))$$

$$\int_2^3 \frac{x^2}{3x^3 - 4} dx = \frac{1}{9} \log_e\left(\frac{77}{20}\right)$$

$$\begin{aligned} \text{8 } A &= \frac{1}{2} (f(0) + f(1)) \times 1 + \frac{1}{2} (f(1) + f(2)) \times 1 + \frac{1}{2} (f(2) + f(3)) \times 1 \\ &\quad + \frac{1}{2} (f(3) + f(4)) \times 1 + \frac{1}{2} (f(4) + f(5)) \times 1 \\ &= \frac{1}{2} (0 + 0.24) + \frac{1}{2} (0.24 + 1.68) + \frac{1}{2} (1.68 + 4.32) \\ &\quad + \frac{1}{2} (4.32 + 5.76) + \frac{1}{2} (5.76 + 0) \\ &= 12 \text{ units}^2 \end{aligned}$$

The correct answer is **B**.

$$\text{9 a } f(x) = \sqrt{x}(4-x)$$

The graph intersects the x -axis where $y = 0$.

$$\sqrt{x}(4-x) = 0$$

$$x = 0 \text{ or } 4 - x = 0$$

$$4 = x$$

Thus, $a = 4$.

$$\text{b } A = \frac{1}{2} (f(0) + f(1)) \times 1 + \frac{1}{2} (f(1) + f(2)) \times 1 + \frac{1}{2} (f(2) + f(3))$$

$$\times 1 + \frac{1}{2} (f(3) + f(4)) \times 1$$

$$\begin{aligned} &= \frac{1}{2} (0 + 3) + \frac{1}{2} (3 + 2\sqrt{2}) + \frac{1}{2} (2\sqrt{2} + \sqrt{3}) + \frac{1}{2} (\sqrt{3} + 0) \\ &= 7.56 \text{ units}^2 \end{aligned}$$

$$\text{10 a } \int_2^5 m(x) dx = 7 \text{ and } \int_2^5 n(x) dx = 3$$

$$\text{i } \int_2^5 3m(x) dx = 3 \int_2^5 m(x) dx = 3(7) = 21$$

$$\begin{aligned} \text{ii } \int_2^5 (2m(x) - 1) dx &= 2 \int_2^5 m(x) dx - \int_2^5 1 dx \\ &= 2(7) - [x]_2^5 \\ &= 14 - (5 - 2) \\ &= 14 - 3 \\ &= 11 \end{aligned}$$

$$\begin{aligned} \text{iii } \int_5^2 (m(x) + 3) dx &= - \int_2^5 (m(x) + 3) dx \\ &= - \int_2^5 m(x) dx - \int_2^5 3 dx \\ &= -7 - [3x]_2^5 \\ &= -7 - (3(5) - 3(2)) \\ &= -7 - 15 + 6 \\ &= -16 \end{aligned}$$

$$\begin{aligned} \text{iv } \int_2^5 (2m(x) + n(x) - 3) dx &= 2 \int_2^5 m(x) dx + \int_2^5 n(x) dx - \int_2^5 3 dx \\ &= 2(7) + 3 - [3x]_2^5 \\ &= 14 + 3 - (3(5) - 3(2)) \\ &= 17 - 9 \\ &= 8 \end{aligned}$$

$$\begin{aligned} \mathbf{b} \quad \int_k^1 (4x^3 - 3x^2 + 1) dx &= 0 \\ [x^4 - x^3 + x]_k^1 &= 0 \\ (1^4 - 1^3 + 1) - (k^4 - k^3 + k) &= 0 \\ 1 - k + k^3 - k^4 &= 0 \end{aligned}$$

$k = \pm$ as $1 - k + k^2$ cannot be further factorised

Verification:

$$\begin{aligned} \int_{-1}^1 (4x^3 - 3x^2 + 1) dx &= [x^4 - x^3 + x]_{-1}^1 \\ &= (1^4 - 1^3 + 1) - ((-1)^4 - (-1)^3 - 1) \\ &= 1 - 1 \\ &= 0 \end{aligned}$$

$$\int_1^1 (4x^3 - 3x^2 + 1) dx = 0$$

$$\mathbf{11} \text{ Given that } \int_0^5 f(x) dx = 7.5 \text{ and } \int_0^5 g(x) dx = 12.5$$

$$\mathbf{a} \quad \int_0^5 -2f(x) dx = -2 \int_0^5 f(x) dx = -2 \times 7.5 = -15$$

$$\mathbf{b} \quad \int_5^0 g(x) dx = - \int_0^5 g(x) dx = -12.5$$

$$\begin{aligned} \mathbf{c} \quad \int_0^5 (3f(x) + 2) dx &= 3 \int_0^5 f(x) dx + \int_0^5 2 dx \\ &= 3 \times 7.5 + [2x]_0^5 \\ &= 22.5 + (2(5) - 0) \\ &= 22.5 + 10 \\ &= 32.5 \end{aligned}$$

$$\begin{aligned} \mathbf{d} \quad \int_0^5 (g(x) + f(x)) dx &= \int_0^5 g(x) dx + \int_0^5 f(x) dx \\ &= 7.5 + 12.5 = 20 \end{aligned}$$

$$\begin{aligned} \mathbf{e} \quad \int_0^5 (8g(x) - 10f(x)) dx &= 8 \int_0^5 g(x) dx - 10 \int_0^5 f(x) dx \\ &= 8(12.5) - 10(7.5) = 25 \end{aligned}$$

$$\mathbf{f} \quad \int_0^3 g(x) dx + \int_3^5 g(x) dx = \int_0^5 g(x) dx = 12.5$$

$$\mathbf{12} \quad \int_1^h \frac{3}{x^2} dx = -\frac{12}{5}$$

$$\int_1^h 3x^{-2} dx = -\frac{12}{5}$$

$$[-3x^{-1}]_1^h = -\frac{12}{5}$$

$$\left[-\frac{3}{x}\right]_1^h = -\frac{12}{5}$$

$$-\frac{3}{h} + 3 = -\frac{12}{5}$$

$$-\frac{3}{h} = -\frac{12}{5} - \frac{15}{5}$$

$$-\frac{3}{h} = \frac{-27}{5}$$

$$\frac{h}{3} = \frac{5}{27}$$

$$h = \frac{5}{27} \times 3 = \frac{5}{9}$$

The correct answer is **D**.

$$\begin{aligned} \mathbf{13} \text{ a} \quad \int_0^a e^{-2x} dx &= \frac{1}{2} \left(1 - \frac{1}{e^8}\right) \\ \left[-\frac{1}{2} e^{-2x}\right]_0^a &= \frac{1}{2} \left(1 - \frac{1}{e^8}\right) \\ \left(-\frac{1}{2} e^{-2a}\right) - \left(-\frac{1}{2} e^0\right) &= \frac{1}{2} \left(1 - \frac{1}{e^8}\right) \\ \frac{1}{2} - \frac{1}{2e^{2a}} &= \frac{1}{2} \left(1 - \frac{1}{e^8}\right) \\ \frac{1}{2} \left(1 - \frac{1}{e^{2a}}\right) &= \frac{1}{2} \left(1 - \frac{1}{e^8}\right) \\ e^{2a} &= e^8 \\ 2a &= 8 \\ a &= 4 \end{aligned}$$

$$\begin{aligned} \mathbf{b} \quad \int_1^k (2x - 3) dx &= 7 - 3\sqrt{5} \\ [x^2 - 3x]_1^k &= 7 - 3\sqrt{5} \\ k^2 - 3k - (1^2 - 3(1)) &= 7 - 3\sqrt{5} \\ k^2 - 3k + 2 &= 7 - 3\sqrt{5} \end{aligned}$$

Solve using CAS:

$$\begin{aligned} k &= 3 - \sqrt{5}, \sqrt{5} \\ &= \sqrt{5}, k > 1 \end{aligned}$$

14 a The graph cuts the x -axis when $f(x) = 0$.

$$f(x) = x^3 - 8x^2 + 21x - 14$$

$$f(1) = 1^3 - 8(1)^2 + 21(1) - 14 = 0$$

Thus, $(x - 1)$ is a factor.

$$x^3 - 8x^2 + 21x - 14 = (x - 1)(x^2 - 7x + 14)$$

As $x^2 - 7x + 14$ has a discriminant such that

$$\Delta = (-7)^2 - (4(1)14) = 49 - 56 = -7, \text{ there are no factors.}$$

$$(x - 1)(x^2 - 7x + 14) = 0$$

$$x - 1 = 0$$

$$x = 1 \text{ so } a = 1$$

$$\begin{aligned} \mathbf{b} \quad \int_1^5 (x^3 - 8x^2 + 21x - 14) dx &= \left[\frac{1}{4}x^4 - \frac{8}{3}x^3 + \frac{21}{2}x^2 - 14x\right]_1^5 \\ &= \left(\frac{1}{4}(5)^4 - \frac{8}{3}(5)^3 + \frac{21}{2}(5)^2 - 14(5)\right) \\ &\quad - \left(\frac{1}{4}(1)^4 - \frac{8}{3}(1)^3 + \frac{21}{2}(1)^2 - 14(1)\right) \\ &= \frac{625}{4} - \frac{1000}{3} + \frac{525}{2} - 70 - \frac{1}{4} + \frac{8}{3} - \frac{21}{2} + 14 \\ &= \frac{624}{4} - \frac{992}{3} + \frac{504}{2} - 56 \\ &= 156 - 330\frac{2}{3} + 252 - 56 \\ &= 408 - 386\frac{2}{3} \\ &= 21\frac{1}{3} \text{ units}^2 \end{aligned}$$

15 Solve using CAS:

$$\int_{-2}^0 \frac{1 + e^{2x} - 2xe^{2x}}{(e^{2x} + 1)^2} dx = 1.964$$

16 a $y = x \sin(x)$

Using the product rule:

$$\frac{dy}{dx} = x \cos(x) + \sin(x)$$

$$\begin{aligned} \text{b } \int_{-\pi}^{\frac{\pi}{2}} 2x \cos(x) dx &= 2 \int_{-\pi}^{\frac{\pi}{2}} x \cos(x) dx \\ &= 2 \left(x \sin(x) - \int_{-\pi}^{\frac{\pi}{2}} \sin(x) \right) \end{aligned}$$

$$\begin{aligned} &= 2 [x \sin(x) + \cos(x)]_{-\pi}^{\frac{\pi}{2}} \\ &= 2 \left(\frac{\pi}{2} \sin\left(\frac{\pi}{2}\right) + \cos\left(\frac{\pi}{2}\right) \right) \\ &\quad - 2 \left(-\pi \sin(\pi) + \cos(\pi) \right) \\ &= 2 \left(\frac{\pi}{2}(1) + 0 \right) - 2(-\pi(0) - 1) \\ &= \pi + 2 \end{aligned}$$

17 a $y = e^{x^3-3x^2} + 2$

$$\frac{dy}{dx} = (3x^2 - 6x) e^{x^3-3x^2}$$

$$\frac{dy}{dx} = 3(x^2 - 2x) e^{x^3-3x^2}$$

$$\begin{aligned} \text{b } \int_0^1 3(x^2 - 2x) e^{x^3-3x^2} dx &= [e^{x^3-3x^2}]_0^1 \\ 3 \int_0^1 (x^2 - 2x) e^{x^3-3x^2} dx &= (e^{1^3-3(1)^2} - e^0) \\ \int_0^1 (x^2 - 2x) e^{x^3-3x^2} dx &= \frac{1}{3} (e^{-2} - 1) \end{aligned}$$

18 $y = (\log_e(x))^2$

$$\text{Let } u = \log_e(x), \text{ so } \frac{du}{dx} = \frac{1}{x}$$

$$\text{Thus, } y = u^2, \text{ so } \frac{dy}{du} = 2u$$

$$\frac{dy}{dx} = \frac{du}{dx} \times \frac{dy}{du}$$

$$\frac{dy}{dx} = \frac{1}{x} \times 2u$$

$$\frac{dy}{dx} = \frac{1}{x} \times 2 \log_e(x)$$

$$\frac{dy}{dx} = \frac{2}{x} \log_e(x)$$

$$\begin{aligned} \int_1^e \left(\frac{4}{x} \log_e(x) \right) dx &= 2 \int_1^e \left(\frac{2}{x} \log_e(x) \right) dx \\ &= 2 \left[(\log_e(x))^2 \right]_1^e \\ &= 2 \left((\log_e(e))^2 - (\log_e(1))^2 \right) \\ &= 2(1 - 0) \\ &= 2 \end{aligned}$$

19 If $y = \log_e(e^x + 1)^2$

$$\text{Let } u = (e^x + 1)^2 \text{ so } \frac{du}{dx} = 2(e^x)(e^x + 1) = 2e^{2x} + 2e^x$$

$$\text{Let } y = \log_e(u) \text{ so } \frac{dy}{du} = \frac{1}{u}$$

$$\frac{dy}{dx} = \frac{du}{dx} \times \frac{dy}{du}$$

$$\frac{dy}{dx} = (2e^{2x} + 2e^x) \times \frac{1}{u}$$

$$\frac{dy}{dx} = (2e^{2x} + 2e^x) \times \frac{1}{(e^x + 1)^2}$$

$$\frac{dy}{dx} = \frac{2e^x(e^x + 1)}{(e^x + 1)^2}$$

$$\frac{dy}{dx} = \frac{2e^x}{(e^x + 1)}, e^x \neq -1$$

Thus

$$\int_1^5 \frac{2e^x}{(e^x + 1)} dx = [\log_e((e^x + 1)^2)]_1^5$$

$$2 \int_1^5 \frac{e^x}{(e^x + 1)} dx = [2 \log_e(e^x + 1)]_1^5$$

$$\int_1^5 \frac{e^x}{(e^x + 1)} dx = \frac{1}{2} [2 \log_e(e^x + 1)]_1^5$$

$$\int_1^5 \frac{e^x}{(e^x + 1)} dx = \frac{1}{2} (\log_e(e^5 + 1)^2 - \log_e(e^2 + 1)^2)$$

$$\int_1^5 \frac{e^x}{(e^x + 1)} dx = \frac{1}{2} (10.0134 - 2.6265)$$

$$\int_1^5 \frac{e^x}{(e^x + 1)} dx = 3.6935$$

8.2 Exam questions

1 $\int_4^8 f(x) dx$

$$\text{Let } u = 2(x + 2), \frac{du}{dx} = 2.$$

$$\text{Terminals: } x = 0, u = 4, x = 2, u = 8$$

$$\begin{aligned} \int_0^2 f(2(x + 2)) dx &= \int_4^8 f(u) \frac{1}{2} du \\ &= \frac{1}{2} \int_4^8 f(x) dx \\ &= \frac{5}{2} \end{aligned}$$

Alternatively:

$$y = f(x)$$

$$y = f(2(x' + 2))$$

$$x' = \frac{x}{2} - 2$$

$$x = 4, x' = 0$$

$$x = 8, x' = 2$$

A translation of 2 units to the left parallel to the x -axis does not affect the area.

A dilation by a factor of $\frac{1}{2}$ from the y -axis means the area is halved.

The correct answer is **E**.

$$\begin{aligned}
 2 \int_1^{12} g(x) dx &= 5, \int_5^1 g(x) dx = -6 \\
 \int_1^5 g(x) dx + \int_5^{12} g(x) dx &= \int_1^{12} g(x) dx \\
 \int_1^5 g(x) dx + (-6) &= -5 \\
 \int_1^5 g(x) dx &= -1
 \end{aligned}$$

The correct answer is B.

$$\begin{aligned}
 3 \int_1^4 \left(\frac{1}{\sqrt{x}} \right) dx &= \int_1^4 x^{-\frac{1}{2}} dx \\
 &= 2 \left[x^{\frac{1}{2}} \right]_1^4 \\
 &= 2 \left[\sqrt{4} - \sqrt{1} \right] \\
 &= 2(2 - 1) \\
 &= 2
 \end{aligned}$$

Award 1 mark for the correct antiderivative.

Award 1 mark for the correct final answer.

VCAA Assessment Report note:

This question was not answered well. A range of incorrect anti-derivatives were given, the majority of which involved the logarithm function.

$$\begin{aligned}
 &= \left(\frac{1}{0.5} \right) - \left(\frac{1}{2.5} \right) \\
 &= 2 - 0.4 \\
 &= 1.6 \text{ units}^2
 \end{aligned}$$

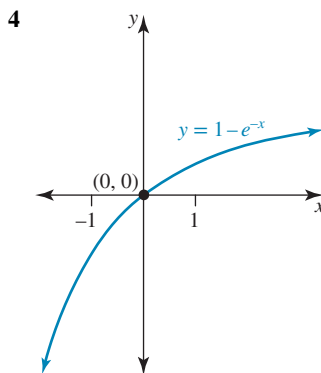

Area

$$\begin{aligned}
 &= - \int_{-1}^0 (1 - e^{-x}) dx + \int_0^1 (1 - e^{-x}) dx \\
 &= - [x + e^{-x}]_{-1}^0 + [x + e^{-x}]_0^1 \\
 &= - ((0 + e^0) - (-1 + e^1)) + ((1 + e^{-1}) - (0 + e^0)) \\
 &= -(1 + 1 - e) + (1 + e^{-1} - 1) \\
 &= -2 + e + e^{-1} \\
 &= e + e^{-1} - 2 \text{ units}^2
 \end{aligned}$$

8.3 Areas under curves

8.3 Exercise

1 Area is

$$\begin{aligned}
 \int_0^{25} 2\sqrt{x} dx &= 2 \int_0^{25} x^{\frac{1}{2}} dx \\
 &= 2 \left[\frac{2}{3} x^{\frac{3}{2}} \right]_0^{25} \\
 &= 2 \left(\frac{2}{3} (25)^{\frac{3}{2}} - \frac{2}{3} (0)^{\frac{3}{2}} \right) \\
 &= \frac{4}{3} (5^2)^{\frac{3}{2}} \\
 &= \frac{4}{3} \times 125 \\
 &= 166 \frac{2}{3} \text{ units}^2
 \end{aligned}$$

$$\begin{aligned}
 2 \int_0^{\pi} (2 \sin(2x) + 3) dx &= [-\cos(2x) + 3x]_0^{\pi} \\
 &= (-\cos(2\pi) + 3\pi) - (-\cos(0) + 3(0)) \\
 &= 3\pi \text{ units}^2
 \end{aligned}$$

$$\begin{aligned}
 3 \text{ Area} &= \int_{-2.5}^{-0.5} \frac{1}{x^2} dx \\
 &= \int_{-2.5}^{-0.5} x^{-2} dx \\
 &= [-x^{-1}]_{-2.5}^{-0.5} \\
 &= \left[-\frac{1}{x} \right]_{-2.5}^{-0.5}
 \end{aligned}$$

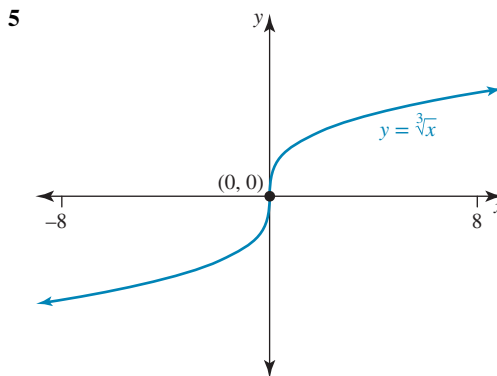

Area is

$$\begin{aligned}
 &= - \int_{-8}^0 \sqrt[3]{x} dx + \int_0^8 \sqrt[3]{x} dx \\
 &= 2 \int_0^8 \sqrt[3]{x} dx \text{ by symmetry} \\
 &= 2 \int_0^8 x^{\frac{1}{3}} dx \\
 &= 2 \left[\frac{3}{4} x^{\frac{4}{3}} \right]_0^8 \\
 &= 2 \left(\frac{3}{4} (2^3)^{\frac{4}{3}} \right) - 0 \\
 &= 2 \times \frac{3}{4} \times 16 \\
 &= 24 \text{ units}^2
 \end{aligned}$$

$$\begin{aligned}
 6 \quad A &= \int_{-2}^{-1} \left(\frac{1}{x-1} + 2 \right) dx \\
 &= \int_{-2}^{-1} \left(\frac{1}{-x-1} + 2 \right) dx \\
 &= \int_{1}^{-2} \left(-\frac{1}{x+1} + 2 \right) dx \\
 &= \left[-\log_e(x+1) + 2x \right]_{1}^{-2} \\
 &= -\log_e(3) + 4 - (-\log_e(2) + 2) \\
 &= -\log_e(3) + 4 + \log_e(2) - 2 \\
 &= \log_e \left(\frac{2}{3} \right) + 2 \text{ units}^2
 \end{aligned}$$

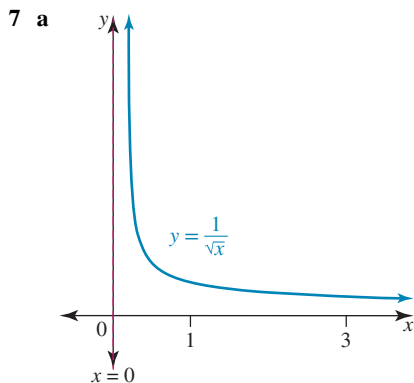

b Area = $\int_{\frac{1}{3}}^3 \frac{1}{\sqrt{x}} dx = \int_{\frac{1}{3}}^3 \left(x^{-\frac{1}{2}} \right) dx$

$$\begin{aligned}
 &= \left[2x^{\frac{1}{2}} \right]_{\frac{1}{3}}^3 \\
 &= 2\sqrt{3} - 2\sqrt{\frac{1}{3}} \\
 &= 2\sqrt{3} - 2 \text{ units}^2
 \end{aligned}$$

8 a $y = f(x) = -(x^2 - 1)(x^2 - 9)$
 The graph cuts the y-axis where $x = 0$, $y = -(-1)(-9) = -9$.
 The graph cuts the x-axis where $y = 0$.

$$\begin{aligned}
 -(x^2 - 1)(x^2 - 9) &= 0 \\
 -(x - 1)(x + 1)(x - 3)(x + 3) &= 0 \\
 x - 1 = 0 \quad x + 1 = 0 \quad x - 3 = 0 \quad x + 3 = 0 \\
 x = 1, \quad x = -1 \quad x = 3 \quad x = -3
 \end{aligned}$$

TP's occur where $\frac{dy}{dx} = 0$.

$$\frac{dy}{dx} = -2x(x^2 - 9) - 2x(x^2 - 1)$$

$$\frac{dy}{dx} = -2x^3 + 18x - 2x^3 + 2x$$

$$\frac{dy}{dx} = -4x^3 + 20x$$

$$0 = -4x(x^2 - 5)$$

$$0 = -4x(x - \sqrt{5})(x + \sqrt{5})$$

$$\begin{aligned}
 x = 0 : \quad x - \sqrt{5} = 0 \quad x + \sqrt{5} = 0 \\
 x = \sqrt{5} \quad x = -\sqrt{5}
 \end{aligned}$$

When $x = 0$, $y = -9$.

When $x = \pm\sqrt{5}$,

$$y = -\left((\pm\sqrt{5})^2 - 1 \right) \left((\pm\sqrt{5})^2 - 9 \right) = -4 \times -4 = 16.$$

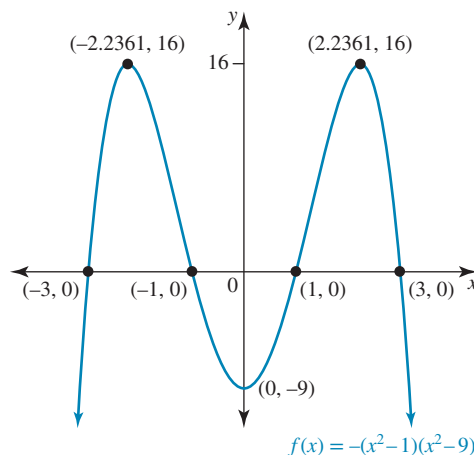

b By symmetry, the area is:

$$\begin{aligned}
 &2 \left(-\int_0^1 (-(x^2 - 1)(x^2 - 9)) dx + \int_1^3 (-(x^2 - 1)(x^2 - 9)) dx \right) \\
 &= 2 \left(-\int_0^1 (-x^4 - 10x^2 - 9) dx + \int_1^3 (-x^4 + 10x^2 - 9) dx \right) \\
 &= 2 \left(-\left[-\frac{1}{5}x^5 + \frac{10}{3}x^3 - 9x \right]_0^1 + \left[-\frac{1}{5}x^5 + \frac{10}{3}x^3 - 9x \right]_1^3 \right) \\
 &= 2 \left(-\left(-\frac{1}{5}(1)^5 + \frac{10}{3}(1)^3 - 9(1) - 0 \right) \right. \\
 &\quad \left. + \left(-\frac{1}{5}(3)^5 + \frac{10}{3}(3)^3 - 9(3) \right) \right. \\
 &\quad \left. - \left(-\frac{1}{5}(1)^5 + \frac{10}{3}(1)^3 - 9(1) \right) \right) \\
 &= 52.27 \text{ units}^2
 \end{aligned}$$

9 $C = -\int_{-4}^{-2} \frac{1}{x} dx$

$$\begin{aligned}
 &= \int_{\frac{1}{2}}^{\frac{1}{4}} \frac{1}{x} dx \\
 &= \left[\log_e(x) \right]_{\frac{1}{2}}^{\frac{1}{4}} \\
 &= \log_e(4) - \log_e(2) \\
 &= \log_e(2) \text{ units}^2
 \end{aligned}$$

10 Required area

$$\begin{aligned}
 &= 4 \left(\int_0^{\pi} (2 \sin(x) + 3 \cos(x)) dx \right) \\
 &= 4 \left([-2 \cos(x) + 3 \sin(x)]_0^{\pi} \right) \\
 &= 4 \left((-2 \cos(\pi) + 3 \sin(\pi)) - (-2 \cos(0) + 3 \sin(0)) \right) \\
 &= 4(2 + 0 + 2 - 0) \\
 &= 16 \text{ units}^2
 \end{aligned}$$

11 a $y = -0.5(x + 2)(x + 1)(x - 2)(x - 3)$

The graph cuts the x-axis where $y = 0$.

$$-0.5(x + 2)(x + 1)(x - 2)(x - 3) = 0$$

$$x + 2 = 0, \quad x + 1 = 0, \quad x - 2 = 0, \quad x - 3 = 0$$

$$x = -2, \quad x = -1, \quad x = 2, \quad x = 3$$

Thus, $a = -2$, $b = -1$, $c = 2$ and $d = 3$.

b Area

$$\begin{aligned}
&= - \int_{-1}^2 (-0.5(x+2)(x+1)(x-2)(x-3)) dx \\
&\quad + 2 \int_2^3 (-0.5(x+2)(x+1)(x-2)(x-3)) dx \\
&= - \int_{-1}^2 \left(-0.5x^4 + x^3 + \frac{7}{2}x^2 - 4x - 6 \right) dx \\
&\quad + 2 \int_2^3 \left(-0.5x^4 + x^3 + \frac{7}{2}x^2 - 4x - 6 \right) dx \\
&= 13.05 + 2 \times 1.3167 \\
&= 15.68 \text{ units}^2
\end{aligned}$$

12 a The graph intersects the x -axis where $y = 0$.

$$\begin{aligned}
2 \sin(x) + \cos(x) &= 0 \\
2 \sin(x) &= -\cos(x) \\
2 \tan(x) &= -1 \\
\tan(x) &= -\frac{1}{2}
\end{aligned}$$

$\frac{1}{2}$ suggest 0.4636. Since tan is negative, 2nd quadrant as

$$0 \leq x \leq \pi.$$

$$x = \pi - 0.4636$$

$$x = 2.6779$$

Thus, $m = 2.6779$.

b Area

$$\begin{aligned}
&= \int_0^{2.6779} (2 \sin(x) + \cos(x)) dx \\
&= [-2 \cos(x) + \sin(x)]_0^{2.6779} \\
&= (-2 \cos(2.6779) + \sin(2.6779)) - (-2 \cos(0) + \sin(0)) \\
&= 1.7888 + 0.4473 + 2 \\
&= 4.2361 \text{ units}^2
\end{aligned}$$

13 Use CAS technology to obtain the following solutions:

$$\mathbf{a} \int_{-2}^2 e^{-x^2} dx = 1.7642 \text{ units}^2$$

$$\begin{aligned}
\mathbf{b} &= \int_{-2}^1 \frac{x^2 + 3x - 4}{x^2 + 1} dx + \int_1^3 \frac{x^2 + 3x - 4}{x^2 + 1} dx \\
&= 7.8371 + 2.0959 \\
&= 9.933 \text{ units}^2
\end{aligned}$$

14 a $y = e^{x^2}$

$$\frac{dy}{dx} = 2xe^{x^2}$$

$$\begin{aligned}
\mathbf{b} &= \int_{-1}^0 (2xe^{x^2}) dx \\
&\quad + \int_0^1 (2xe^{x^2}) dx = 2 \int_0^1 (2xe^{x^2}) dx \text{ by symmetry} \\
&= 2 \left[e^{x^2} \right]_0^1 \\
&= 2(e^{(1)^2} - e^0) \\
&= 2(e - 1) \text{ units}^2
\end{aligned}$$

15 a $y = ax(x-2)$

When $x = 1$, $y = 3$.

$$3 = a(1)(1-2)$$

$$3 = -a$$

$$a = -3$$

$$\text{Thus, } y = -3x(x-2) = -3x^2 + 6x.$$

b Area of glass is

$$\begin{aligned}
&\int_0^2 (-3x^2 + 6x) dx \\
&= [-x^3 + 3x^2]_0^2 \\
&= (-(2)^3 + 3(2)^2) - ((0) - (0)) \\
&= -8 + 12 - 0 \\
&= 4 \text{ m}^2
\end{aligned}$$

c Two windows = 8 m²

$$\text{Cost} = \$55 \times 8 = \$440$$

$$\mathbf{16 a} \int_0^1 3x^3 dx = \left[\frac{3}{4}x^4 \right]_0^1 = \frac{3}{4}(1)^4 - 0 = \frac{3}{4} \text{ units}^2$$

b Orange region = $3 \times 1 - \frac{3}{4} = 2\frac{1}{4}$ units²

$$\begin{aligned}
\mathbf{17 a} \int_0^{\frac{\pi}{2}} 2 \sin(x) dx &= [-2 \cos(x)]_0^{\frac{\pi}{2}} \\
&= -2 \cos\left(\frac{\pi}{2}\right) - (-2 \cos(0)) \\
&= 0 + 2 \\
&= 2
\end{aligned}$$

b The area of the shaded region is

$$2 \left(2 \times \frac{\pi}{2} - 2 \right) = 2(\pi - 2) \text{ units}^2.$$

18 a Dom = $(1, \infty)$ and ran = R **b** The graph cuts the x -axis where $y = 0$

$$\begin{aligned}
2 \log_e(x-1) &= 0 \\
\log_e(x-1) &= 0 \\
e^0 &= x-1 \\
1 &= x-1 \\
x &= 2
\end{aligned}$$

Thus, $(a, 0) \equiv (2, 0)$, $a = 2$

$$\mathbf{c} \int_2^5 2 \log_e(x-1) dx = 5.0904 \text{ units}^2$$

Solved using CAS

19 a $y = \frac{10x}{5+x^2}$

$$\text{Let } u = 10x \text{ so } \frac{du}{dx} = 10$$

$$\text{Let } v = 5 + x^2 \text{ so } \frac{dv}{dx} = 2x$$

$$\frac{dy}{dx} = \frac{v \frac{du}{dx} - u \frac{dv}{dx}}{v^2}$$

$$\frac{dy}{dx} = \frac{10(5+x^2) - 10x(2x)}{(5+x^2)^2}$$

$$\frac{dy}{dx} = \frac{50 + 10x^2 - 20x^2}{(5+x^2)^2}$$

$$\frac{dy}{dx} = \frac{50 - 10x^2}{(5+x^2)^2}$$

Maximum TP occurs when $\frac{dy}{dx} = 0$

$$\begin{aligned} \frac{50 - 10x^2}{(5 + x^2)^2} &= 0 \\ 50 - 10x^2 &= 0 \\ 50 &= 10x^2 \\ 5 &= x^2 \\ \pm\sqrt{5} &= x \end{aligned}$$

When

$$x = -\sqrt{5}, y = \frac{10(-\sqrt{5})}{5 + (-\sqrt{5})^2} = -\frac{10\sqrt{5}}{5 + 5} = -\frac{10\sqrt{5}}{10} = -\sqrt{5}$$

So $(-\sqrt{5}, -\sqrt{5})$ is a minimum TP.

$$\text{When } x = \sqrt{5}, y = \frac{10(\sqrt{5})}{5 + (\sqrt{5})^2} = \frac{10\sqrt{5}}{5 + 5} = \frac{10\sqrt{5}}{10} = \sqrt{5}$$

So $(\sqrt{5}, \sqrt{5})$ is a maximum TP.

$$\begin{aligned} \text{b } \frac{d}{dx} (\log_e(5 + x^2)) &= \frac{2x}{5 + x^2} \\ \int \frac{10x}{5 + x^2} dx &= 5 \int \frac{2x}{5 + x^2} dx = 5 \log_e(5 + x^2) \end{aligned}$$

$$\text{c } y = \log_e(5 + x^2) \text{ so } \frac{dy}{dx} = \frac{2x}{5 + x^2}$$

$$\begin{aligned} \int_{\sqrt{5}}^6 \frac{10x}{5 + x^2} dx &= 5 \int_{\sqrt{5}}^6 \frac{2x}{5 + x^2} dx \\ \int_{\sqrt{5}}^6 \frac{10x}{5 + x^2} dx &= 5 [\log_e(5 + x^2)]_{\sqrt{5}}^6 \\ \int_{\sqrt{5}}^6 \frac{10x}{5 + x^2} dx &= 5 \left\{ \log_e(5 + 6^2) - \log_e\left(5 + (\sqrt{5})^2\right) \right\} \\ \int_{\sqrt{5}}^6 \frac{10x}{5 + x^2} dx &= 5 \log_e\left(\frac{41}{10}\right) \text{ units}^2 \end{aligned}$$

$$\text{20 a } \text{The shaded region is } \int_4^6 5 \log_e(x - 3) dx = 6.4792 \text{ units}^2$$

$$\text{b } y = \log_e(x - 3)$$

For the inverse, swap x and y .

$$x = 5 \log_e(y - 3)$$

$$\frac{x}{5} = \log_e(y - 3)$$

$$e^{\frac{x}{5}} = y - 3$$

$$y = e^{\frac{x}{5}} + 3, x \in R$$

$$\text{That is, } f^{-1}(x) = e^{\frac{x}{5}} + 3.$$

c Area = Area of rectangle – area under the curve

$$\begin{aligned} &= 6 \times 5 \log_e(3) - \int_0^{5 \log_e(3)} \left(e^{\frac{x}{5}} + 3 \right) dx \\ &= 30 \log_e(3) - \left[5e^{\frac{x}{5}} + 3x \right]_0^{5 \log_e(3)} \\ &= 30 \log_e(3) - (5e^{\log_e(3)} + 3 \times 5 \log_e(3) - (5 + 0)) \\ &= 30 \log_e(3) - 15 - 15 \log_e(3) + 5 \\ &= 6.4792 \text{ units}^2 \end{aligned}$$

$$\begin{aligned} \text{21 a } \int_0^4 \left(\sqrt{x}(x - 3)^2 \right) dx \\ &= \int_0^4 \left(x^{\frac{1}{2}}(x^2 - 6x + 9) \right) dx \\ &= \int_0^4 \left(x^{\frac{5}{2}} - 6x^{\frac{3}{2}} + 9x^{\frac{1}{2}} \right) dx \\ &= \left[\frac{2}{7}x^{\frac{7}{2}} - \frac{12}{5}x^{\frac{5}{2}} + 6x^{\frac{3}{2}} \right]_0^4 \\ &= \left(\frac{2}{7}(4)^{\frac{7}{2}} - \frac{12}{5}(4)^{\frac{5}{2}} + 6(4)^{\frac{3}{2}} \right) - 0 \\ &= 36.5714 - 76.8 + 48 \\ &= 7.7714 \text{ cm}^2 \end{aligned}$$

b The area of the whole motif is

$$7.7714 \times 2 = 15.5428 \approx 15.5 \text{ cm}^2.$$

c $0.34875 \text{ m}^2 = 3487.5 \text{ cm}^2$

$$\text{The scale factor is } 3487.5 \div 15.5428 \approx 224.$$

8.3 Exam questions

$$\text{1 a i } f: R \setminus \{1\} \rightarrow R, f(x) = \frac{2}{(x - 1)^2} + 1$$

$$f(-1) = \frac{2}{(-2)^2} + 1 = \frac{3}{2}$$

[1 mark]

ii Note that the graph must pass through the points

$$\left(-1, \frac{3}{2}\right), (0, 3), (2, 3), \left(3, \frac{3}{2}\right).$$

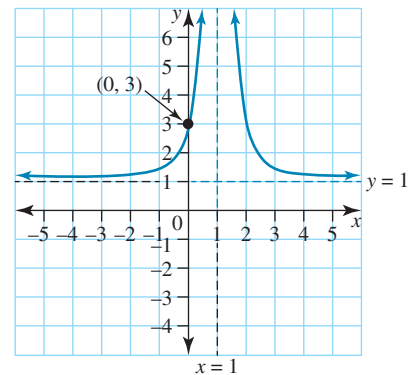

Award 1 mark for the correct asymptotes.

Award 1 mark for the correct graph.

VCAA Examination Report note:

Most students correctly recognised that a truncus shape was required and most of these students located it correctly. Again, curvature was an issue for some, with graphs 'turning away' from the asymptotes or crossing them. Students who made use of their answer to part a, and found a y-intercept were most successful in producing a correct graph. Those who did not recognise the truncus tended to draw a rectangular hyperbola with correct asymptotes.

$$\begin{aligned} \text{b } A &= \int_{-1}^0 \left(\frac{2}{(x - 1)^2} + 1 \right) dx \\ A &= \left[\frac{-2}{(x - 1)} + x \right]_{-1}^0 = (2 + 0) - (1 - 1) \\ A &= 2 \text{ units}^2 \end{aligned}$$

Award 1 mark for the correct definite integral and anti-derivative.

Award 1 mark for the correct answer.

VCAA Examination Report note:

Students were generally able to set up the correct definite integral, but often did not find the correct anti-derivative or evaluated it incorrectly. The most common errors were an anti-derivative that involved a log component or overlooking the +1 constant when anti-differentiating.

- 2 Given that $f(-x) = f(x)$, the graph is symmetrical about the y -axis.

$$\int_a^b f(x) dx = \int_c^d f(x) dx, \text{ and } -\int_b^a f(x) dx = -\int_0^c f(x) dx$$

$$\begin{aligned} A &= 2 \int_a^b f(x) dx - 2 \int_b^{b+c} f(x) dx \\ &= 2 \int_a^b f(x) dx - 2 \int_b^b f(x) dx \end{aligned}$$

Since $b + c = 0$

The correct answer is **D**.

- 3 $f: \left[0, \frac{\pi}{2}\right] \rightarrow R, f(x) = \cos(x), g: \left[0, \frac{\pi}{2}\right] \rightarrow R,$

$$g(x) = \sqrt{3} \sin(x)$$

To find the point of intersection of $f(x)$ and $g(x)$:

$$f(x) = g(x)$$

$$\Rightarrow \cos(x) = \sqrt{3} \sin(x)$$

$$\Rightarrow \tan(x) = \frac{1}{\sqrt{3}}$$

$$\Rightarrow x = \frac{\pi}{6} \quad B \left(\frac{\pi}{6}, \frac{\sqrt{3}}{2} \right)$$

$$\begin{aligned} \text{Shaded area} &= \int_0^{\frac{\pi}{6}} \sqrt{3} \sin(x) dx + \int_{\frac{\pi}{6}}^{\frac{\pi}{2}} \cos(x) dx \\ &= \sqrt{3} - \frac{3}{2} + \frac{1}{2} \\ &= \sqrt{3} - 1 \end{aligned}$$

$$\text{Area of the triangle } OAB = \frac{1}{2} \times \frac{\pi}{2} \times \frac{\sqrt{3}}{2} = \frac{\sqrt{3}\pi}{8}$$

The ratio of areas is $\sqrt{3} - 1 : \frac{\sqrt{3}\pi}{8}$.

The correct answer is **B**.

8.4 Areas between curves and average values

8.4 Exercise

1 a $y = 4$ [1]
 $y = \sqrt{x}$ [2]

$$[1] = [2]$$

$$\sqrt{x} = 4$$

$$x = 16$$

When $x = 16, y = 4$; therefore, POI = (16, 4).

- b Area of the shaded region

$$\begin{aligned} &= \int_0^{16} (4 - \sqrt{x}) dx \\ &= \int_0^{16} \left(4 - x^{\frac{1}{2}}\right) dx \\ &= \left[4x - \frac{2}{3}x^{\frac{3}{2}}\right]_0^{16} \\ &= \left(4(16) - \frac{2}{3}(4^2)^{\frac{3}{2}}\right) - 0 \\ &= 64 - \frac{2}{3} \times 4^3 \\ &= 21\frac{1}{3} \text{ units}^2 \end{aligned}$$

2 $y = (x - 3)^2$ [1]

$y = 9 - x$ [2]

[1] = [2]

$$(x - 3)^2 = 9 - x$$

$$x^2 - 6x + 9 = 9 - x$$

$$x^2 - 5x = 0$$

$$x(x - 5) = 0$$

$$x = 0 \text{ or } x - 5 = 0$$

$$x = 5$$

When $x = 0, y = 9 - 0 = 9$.

When $x = 5, y = 9 - 5 = 4$.

The graphs intersect at (0, 9) and (5, 4).

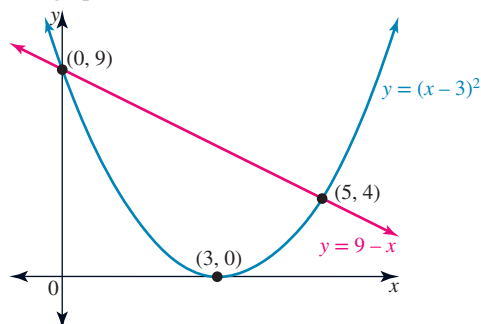

Area is

$$\begin{aligned} &= \int_0^5 (9 - x - (x - 3)^2) dx \\ &= \int_0^5 (9 - x - x^2 + 6x - 9) dx \\ &= \int_0^5 (-x^2 + 5x) dx \\ &= \left[-\frac{1}{3}x^3 + \frac{5}{2}x^2\right]_0^5 \\ &= \left(-\frac{1}{3}(5)^3 + \frac{5}{2}(5)^2\right) - 0 \\ &= -\frac{125}{3} + \frac{125}{2} \\ &= -\frac{250}{6} + \frac{375}{6} \end{aligned}$$

$$= \frac{125}{6}$$

$$= 20\frac{5}{6} \text{ units}^2$$

3 a Point of intersection between the graphs:

$$\sin(x) = -\cos(x) \quad 0 \leq x \leq \pi$$

$$\tan(x) = -1$$

Basic angle = $\frac{\pi}{4}$, tan is negative in the 2nd quadrant

$$x = \frac{3\pi}{4}$$

$$\sin\left(\frac{3\pi}{4}\right) = \frac{\sqrt{2}}{2}$$

$$\therefore \text{POI} = \left(\frac{3\pi}{4}, \frac{\sqrt{2}}{2}\right)$$

b See the image at the bottom of the page.*

The area between the curves is

$$A = \int_0^{\frac{3\pi}{4}} (\sin(x) + \cos(x)) dx + \int_{\frac{3\pi}{4}}^{\pi} (-\cos(x) - \sin(x)) dx$$

$$= [-\cos(x) + \sin(x)]_0^{\frac{3\pi}{4}} + [-\sin(x) + \cos(x)]_{\frac{3\pi}{4}}^{\pi}$$

$$= \left(-\cos\left(\frac{3\pi}{4}\right) + \sin\left(\frac{3\pi}{4}\right) - (-\cos(0) + \sin(0))\right)$$

$$+ \left(-\sin(\pi) + \cos(\pi) - \left(-\sin\left(\frac{3\pi}{4}\right) + \cos\left(\frac{3\pi}{4}\right)\right)\right)$$

$$= \frac{\sqrt{2}}{2} + \frac{\sqrt{2}}{2} + 1 - 0 + 0 - 1 + \frac{\sqrt{2}}{2} + \frac{\sqrt{2}}{2}$$

$$= 2\sqrt{2} \text{ units}^2$$

4 Average value = $\frac{1}{b-a} \int_a^b f(x) dx$

$$= \frac{1}{\left(\frac{1}{3} - 0\right)} \int_0^{\frac{1}{3}} e^{3x} dx$$

$$= 3 \left[\frac{1}{3} e^{3x} \right]_0^{\frac{1}{3}}$$

$$= 3 \left(\frac{1}{3} e^1 - \frac{1}{3} e^0 \right)$$

$$= e - 1$$

5 Average value = $\frac{1}{b-a} \int_a^b f(x) dx$

$$= \frac{1}{1-0.5} \int_{0.5}^1 (x^2 - 2x) dx$$

$$= 2 \left[\frac{1}{3} x^3 - x^2 \right]_{0.5}^1$$

$$= 2 \left(\left(\frac{1}{3} (1)^3 - (1)^2 \right) - \left(\frac{1}{3} \left(\frac{1}{2} \right)^3 - \left(\frac{1}{2} \right)^2 \right) \right)$$

$$= 2 \left(-\frac{2}{3} + \frac{5}{24} \right)$$

$$= 2 \left(-\frac{16}{24} + \frac{5}{24} \right)$$

$$= -\frac{11}{12}$$

6 Area

$$= \int_0^{3.92} (4 - x - 4e^{-x}) dx + \int_{3.92}^5 (4e^{-x} - 4 + x) dx$$

$$= \left[4x - \frac{1}{2}x^2 + 4e^{-4x} \right]_0^{3.92} + \left[-4e^{-x} - 4x + \frac{1}{2}x^2 \right]_{3.92}^5$$

$$= 4.6254 \text{ units}^2$$

7 Area

$$= \int_{-1.5}^{0.5} (\cos(x) - 0.5e^x) dx$$

$$= [\sin(x) - 0.5e^x]_{-1.5}^{0.5}$$

$$= (\sin(0.5) - 0.5e^{0.5}) - (\sin(-1.5) - 0.5e^{-1.5})$$

$$= (0.4794 - 0.8244) - (-0.9975 - 0.1116)$$

$$= 0.7641 \text{ units}^2$$

***3 b**

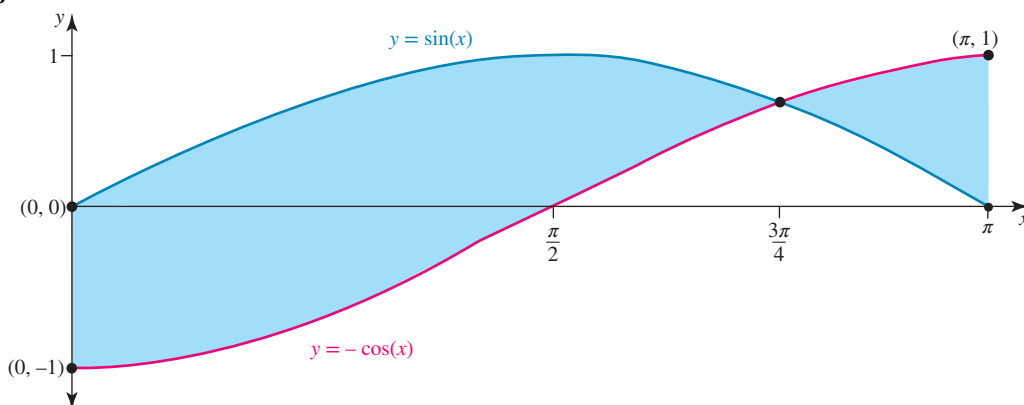

8 Area

$$\begin{aligned} &= \int_{-3}^3 (-0.5x^2(x-3)(x+3) - 0.25x^2(x-3)(x+3)) dx \\ &= \int_{-3}^3 (-0.75x^2(x-3)(x+3)) dx \\ &= \int_{-3}^3 (-0.75x^2(x^2 - 9)) dx \\ &= \int_{-3}^3 (-0.75x^4 + 6.75x^2) dx \\ &= \left[-\frac{0.75}{5}x^5 + \frac{6.75}{3}x^3 \right]_{-3}^3 \\ &= [-0.15x^5 + 2.25x^3]_{-3}^3 \\ &= (-0.15(3)^5 + 2.25(3)^3) - (-0.15(-3)^5 + 2.25(-3)^3) \\ &= -36.45 + 60.75 - 36.45 + 60.75 \\ &= 48.6 \text{ units}^2 \end{aligned}$$

The correct answer is B.

9 a

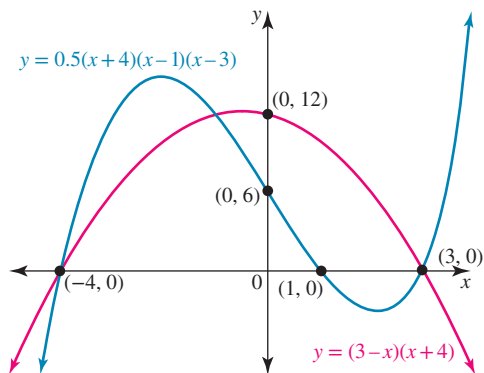

b $y = 0.5(x+4)(x-1)(x-3)$ [1]

$y = (3-x)(x+4)$ [2]

[1] = [2]

$$0.5(x+4)(x-1)(x-3) = (3-x)(x+4)$$

$$0.5(x+4)(x-1)(x-3) - (3-x)(x+4) = 0$$

$$0.5(x+4)(x-1)(x-3) + (x-3)(x+4) = 0$$

$$(x-3)(x+4)(0.5(x-1) + 1) = 0$$

$$(x-3)(x+4)(0.5x - 0.5 + 1) = 0$$

$$(x-3)(x+4)(0.5x + 0.5) = 0$$

$$x = 3 \quad x = -4 \quad x = -1$$

When $x = -4$, $y = (3+4)(-4+4) = 0$.

When $x = -1$, $y = (3+1)(-1+4) = 12$.

When $x = 3$, $y = (3-1)(3+4) = 0$.

Therefore, the coordinates are $(-4, 0)$, $(-1, 12)$ and $(3, 0)$.

c Area between the curves

$$\begin{aligned} &= \int_{-4}^{-1} (0.5(x+4)(x-1)(x-3) - (3-x)(x+4)) dx \\ &\quad + \int_{-1}^3 ((3-x)(x+4) - 0.5(x+4)(x-1)(x-3)) dx \\ &= \int_{-4}^{-1} ((x-3)(x+4)(0.5(x-1) + 1)) dx \\ &\quad + \int_{-1}^3 ((3-x)(x+4)(1 + 0.5(x-1))) dx \end{aligned}$$

$$\begin{aligned} &= \int_{-4}^{-1} ((x^2 + x - 12)(0.5x + 0.5)) dx \\ &\quad + \int_{-1}^3 ((-x^2 - x - 12)(0.5x + 0.5)) dx \\ &= \int_{-4}^{-1} (0.5x^3 + 0.5x^2 - 6x + 0.5x^2 + 0.5x - 6) dx \\ &\quad + \int_{-1}^3 (-0.5x^3 - 0.5x^2 - 0.5x^2 - 0.5x + 6x + 6) dx \\ &= \int_{-4}^{-1} \left(\frac{1}{2}x^3 + x^2 - \frac{11}{2}x - 6 \right) dx \\ &\quad + \int_{-1}^3 \left(-\frac{1}{2}x^3 - x^2 + \frac{11}{2}x + 6 \right) dx \\ &= \left[\frac{1}{8}x^4 + \frac{1}{3}x^3 - \frac{11}{4}x^2 - 6x \right]_{-4}^{-1} \\ &\quad + \left[-\frac{1}{8}x^4 - \frac{1}{3}x^3 + \frac{11}{4}x^2 + 6x \right]_{-1}^3 \\ &= 12.375 + 26.27 \\ &= 39.04 \text{ units}^2 \end{aligned}$$

10 a $f(x) = \frac{1}{x+2} - 1$ cuts the x -axis where $f(x) = 0$.

Thus,

$$\frac{1}{x+2} - 1 = 0$$

$$\frac{1}{x+2} = 1$$

$$1 = x + 2$$

$$x = -1$$

So $(a, 0) = (-1, 0)$, $a = -1$

b The area is

$$\begin{aligned} &\int_{-1}^2 \left(\frac{1}{x+2} - 1 \right) dx = [\log_e(x+2) - x]_{-1}^2 \\ &= (\log_e(4) - 2) - (\log_e(1) + 1) \\ &= \log_e(4) - 3 \end{aligned}$$

c $\frac{1}{x+2} - 1 = -\frac{1}{2}x + \frac{1}{4}$

$$\frac{1}{x+2} = -\frac{1}{2}x + \frac{5}{4}$$

$$\frac{4}{x+2} = -2x + 5$$

$$4 = (x+2)(-2x+5)$$

$$4 = -2x^2 + x + 10$$

$$0 = 2x^2 - x - 6$$

$$= (2x+3)(x-2)$$

$$x = -\frac{3}{2}, 2$$

$$x = -\frac{3}{2}, y = \frac{1}{-\frac{3}{2}+2} - 1 = 1 \quad \therefore \left(-\frac{3}{2}, 1 \right)$$

$$x = 2, y = \frac{1}{2+2} - 1 = -\frac{3}{4} \quad \therefore \left(2, -\frac{3}{4} \right)$$

$$\begin{aligned}
 \mathbf{d} \quad A &= \int_{-\frac{3}{2}}^2 \left(-\frac{1}{2}x + \frac{1}{4} - \left(\frac{1}{x+2} - 1 \right) \right) dx \\
 &= \int_{-\frac{3}{2}}^2 \left(-\frac{1}{2}x + \frac{5}{4} - \frac{1}{x+2} \right) dx \\
 &= \left[-\frac{1}{4}x^2 + \frac{5}{4}x - \log_e(x+2) \right]_{-\frac{3}{2}}^2 \\
 &= -\frac{1}{4}(2)^2 + \frac{5}{4}(2) - \log_e(4) - \left(-\frac{1}{4} \left(\frac{-3}{2} \right)^2 + \frac{5}{4} \left(\frac{-3}{2} \right) - \log_e \left(\frac{1}{2} \right) \right) \\
 &= -1 + \frac{5}{2} - \log_e(4) + \frac{9}{16} + \frac{15}{8} + \log_e \left(\frac{1}{2} \right) \\
 &= \frac{63}{16} - 3 \log_e(2)
 \end{aligned}$$

11 a Graph of $y = \frac{5x}{x^2+1}$

Tangent at $x = -\frac{1}{2}$, $y = \frac{5(-\frac{1}{2})}{(-\frac{1}{2})^2+1}$

$$y = -\frac{5}{2} \div \frac{5}{4}$$

$$y = -\frac{5}{2} \times \frac{4}{5}$$

$$y = -2$$

Gradient of tangent = $m_T = \frac{dy}{dx}$

Let $u = 5x$, so $\frac{du}{dx} = 5$

Let $v = x^2 + 1$, so $\frac{dv}{dx} = 2x$

$$\frac{dy}{dx} = \frac{v \frac{du}{dx} - u \frac{dv}{dx}}{v^2}$$

$$\frac{dy}{dx} = \frac{5(x^2+1) - 5x(2x)}{(x^2+1)^2}$$

$$\frac{dy}{dx} = \frac{5x^2 + 5 - 10x^2}{(x^2+1)^2}$$

$$\frac{dy}{dx} = \frac{5 - 5x^2}{(x^2+1)^2}$$

At $x = -\frac{1}{2}$, $\frac{dy}{dx} = \frac{5 - 5(-\frac{1}{2})^2}{\left((-\frac{1}{2})^2 + 1 \right)^2}$

$$\frac{dy}{dx} = \left(5 - \frac{5}{4} \right) \div \left(\left(\frac{1}{4} + 1 \right)^2 \right)$$

$$\frac{dy}{dx} = \left(\frac{20-5}{4} \right) \div \frac{25}{16}$$

$$\frac{dy}{dx} = \frac{15}{4} \times \frac{16}{25}$$

$$\frac{dy}{dx} = \frac{12}{5}$$

The equation of the tangent with $m_T = \frac{12}{5}$ that passes

through $(x_1, y_1) \equiv \left(-\frac{1}{2}, -2 \right)$ is given by

$$y - y_1 = m_T(x - x_1)$$

$$y + 2 = \frac{12}{5} \left(x + \frac{1}{2} \right)$$

$$y = \frac{12}{5}x + \frac{6}{5} - \frac{10}{5}$$

$$y = \frac{12}{5}x - \frac{4}{5} \text{ or } 12x - 5y = 4$$

b If $y = \log_e(x^2+1)$, then $\frac{dy}{dx} = \frac{2x}{x^2+1}$

$$\begin{aligned}
 \int \frac{5x}{x^2+1} dx &= \frac{5}{2} \int \frac{2x}{x^2+1} dx \\
 &= \frac{5}{2} \log_e(1+x^2)
 \end{aligned}$$

c $y = \frac{5x}{x^2+1}$ [1]

$$y = \frac{12}{5}x - \frac{4}{5}$$
 [2]

[1] = [2]:

$$\frac{5x}{x^2+1} = \frac{12}{5}x - \frac{4}{5}$$

$$25x = (12x-4)(x^2+1)$$

$$25x = 12x^3 - 4x^2 + 12x - 4$$

$$0 = 12x^3 - 4x^2 + 12x - 4 - 25x$$

$$0 = 12x^3 - 4x^2 - 13x - 4$$

Let $P(x) = 12x^3 - 4x^2 - 13x - 4$

$$P\left(-\frac{1}{2}\right) = 12\left(-\frac{1}{2}\right)^3 - 4\left(-\frac{1}{2}\right)^2 - 13\left(-\frac{1}{2}\right) - 4$$

$$P\left(-\frac{1}{2}\right) = -\frac{12}{8} - \frac{4}{4} + \frac{13}{2} - \frac{8}{2}$$

$$P\left(-\frac{1}{2}\right) = -\frac{3}{2} - \frac{2}{2} + \frac{13}{2} - \frac{8}{2} = 0$$

$\left(x + \frac{1}{2}\right)$ or $(2x+1)$ is a factor.

$$12x^3 - 4x^2 - 13x - 4 = (2x+1)(6x^2 - 5x - 4)$$

$$12x^3 - 4x^2 - 13x - 4 = (2x+1)(2x+1)(3x-4)$$

Thus, if

$$(2x+1)^2(3x-4) = 0$$

$$x = -\frac{1}{2} \text{ or } \frac{4}{3}$$

The shaded area is $\int_{-\frac{1}{2}}^{\frac{4}{3}} \left(\frac{5x}{x^2+1} - \frac{12}{5}x + \frac{4}{5} \right) dx$

$$= \int_{-\frac{1}{2}}^{\frac{4}{3}} \left(\frac{5x}{x^2+1} \right) dx - \frac{12}{5} \int_{-\frac{1}{2}}^{\frac{4}{3}} x dx + \int_{-\frac{1}{2}}^{\frac{4}{3}} \frac{4}{5} dx$$

$$= \frac{5}{2} \int_{-\frac{1}{2}}^{\frac{4}{3}} \left(\frac{2x}{x^2+1} \right) dx - \frac{12}{5} \int_{-\frac{1}{2}}^{\frac{4}{3}} x dx + \int_{-\frac{1}{2}}^{\frac{4}{3}} \frac{4}{5} dx$$

$$\begin{aligned}
 &= \left[\frac{5}{2} \log_e(x^2+1) - \frac{12}{10}x^2 + \frac{4}{5}x \right]_{-\frac{1}{2}}^{\frac{4}{3}} \\
 &= 2.5541 - 2.13 + 1.07 - 0.5579 + 0.3 + 0.4 \\
 &= 1.6295 \text{ units}^2
 \end{aligned}$$

12 a Curve $y = \frac{1}{x} + x^3 - 4$

Tangent at $x = 1$, $y = \frac{1}{1} + 1^3 - 4 = -2$

Gradient of tangent $= m_T = \frac{dy}{dx} = -x^{-2} + 3x^2 = \frac{1}{x^2} + 3x^2$
 $= \frac{3x^4 - 1}{x^2}$

When $x = 1$, $m_T = \frac{3(1)^4 - 1}{(1)^2} = 2$

The equation of the tangent with $m_T = 2$ that passes through $(x_1, y_1) \equiv (1, -2)$ is given by

$$y - y_1 = m_T(x - x_1)$$

$$y + 2 = 2(x - 1)$$

$$y + 2 = 2x - 2$$

$$y = 2x - 4$$

b The shaded region is $\int_1^2 \left(\frac{1}{x} + x^3 - 4 - (2x - 4) \right) dx$

$$= \int_1^2 \left(\frac{1}{x} + x^3 - 2x \right) dx$$

$$= \left[\log_e(x) + \frac{1}{4}x^4 - x^2 \right]_1^2$$

$$= \left(\log_e(2) + \frac{1}{4}(2)^4 - (2)^2 \right) - \left(\log_e(1) + \frac{1}{4}(1)^4 - (1)^2 \right)$$

$$= \log_e(2) + 4 - 4 - 0 - \frac{1}{4} + 1$$

$$= \frac{3}{4} + \log_e(2) \text{ units}^2$$

13 a $y = 3x^3 - x^4$ [1]

$y = 3 - x$ [2]

[1] = [2]:

$$3x^3 - x^4 = 3 - x$$

$$0 = x^4 - 3x^3 - x + 3$$

$$0 = x^3(x - 3) - (x - 3)$$

$$0 = (x - 3)(x^3 - 1)$$

$$0 = (x - 3)(x - 1)(x^2 + x + 1)$$

$x - 3 = 0$ or $x - 1 = 0$ as $x^2 + x + 1$ cannot be further factorised.

$$x = 3 \quad x = 1$$

When $x = 1$, $y = 3 - 1 = 2$.

When $x = 3$, $y = 3 - 3 = 0$.

Thus, $(a, b) = (1, 2)$ and $(c, 0) = (3, 0)$.

$$a = 1, b = 2, c = 3$$

b Area

$$= \int_1^3 (3x^3 - x^4 - (3 - x)) dx$$

$$= \int_1^3 (3x^3 - x^4 - 3 + x) dx$$

$$= \left[\frac{3}{4}x^4 - \frac{1}{5}x^5 - 3x + \frac{1}{2}x^2 \right]_1^3$$

$$= \left[-\frac{1}{5}x^5 + \frac{3}{4}x^4 + \frac{1}{2}x^2 - 3x \right]_1^3$$

$$\begin{aligned} &= \left(-\frac{1}{5}(3)^5 + \frac{3}{4}(3)^4 + \frac{1}{2}(3)^2 - 3(3) \right) \\ &\quad - \left(-\frac{1}{5}(1)^5 + \frac{3}{4}(1)^4 + \frac{1}{2}(1)^2 - 3(1) \right) \\ &= \left(-\frac{243}{5} + \frac{243}{4} + \frac{9}{2} - 9 \right) - \left(-\frac{1}{5} + \frac{3}{4} + \frac{1}{2} - 3 \right) \\ &= -\frac{242}{5} + \frac{240}{4} + 4 - 6 \\ &= -\frac{968}{20} + \frac{1200}{20} - \frac{40}{20} \\ &= \frac{192}{20} \\ &= 9.6 \text{ units}^2 \end{aligned}$$

c Average value $= \frac{1}{b-a} \int_a^b f(x) dx$

$$\begin{aligned} &= \frac{1}{2.5-1} \int_1^{2.5} (3x^3 - x^4) dx \\ &= \frac{1}{1.5} \left[\frac{3}{4}x^4 - \frac{1}{5}x^5 \right]_1^{2.5} \\ &= \frac{2}{3} \left(\left(\frac{3}{4} \left(\frac{5}{2} \right)^4 - \frac{1}{5} \left(\frac{5}{2} \right)^5 \right) - \left(\frac{3}{4}(1)^4 - \frac{1}{5}(1)^5 \right) \right) \\ &= \frac{2}{3} \left(\frac{1875}{64} - \frac{1250}{64} - \frac{11}{20} \right) \\ &= 6.144 \end{aligned}$$

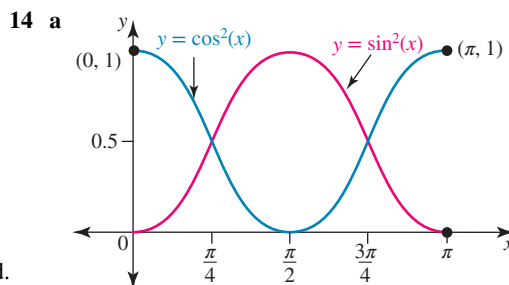

b Area between the curves

$$= \int_0^{\frac{\pi}{4}} (\cos^2(x) - \sin^2(x)) dx + \int_{\frac{\pi}{4}}^{\frac{3\pi}{4}} (\sin^2(x) - \cos^2(x)) dx$$

$$+ \int_{\frac{3\pi}{4}}^{\pi} (\cos^2(x) - \sin^2(x)) dx$$

$$= 0.5 + 1 + 0.5$$

$$= 2 \text{ units}^2$$

15 a $y^2 = 4 - x$ [1]

$y = x - 2$ [2]

Substitute [2] into [1]:

$$(x - 2)^2 = 4 - x$$

$$x^2 - 4x + 4 = 4 - x$$

$$x^2 - 3x = 0$$

$$x(x - 3) = 0$$

$$x = 0 \text{ or } x - 3 = 0$$

$$x = 3$$

When $x = 0$, $y = 0 - 2 = -2$.

When $x = 3$, $y = 3 - 2 = 1$.

The points of intersection are $(0, -2)$ and $(3, 1)$.

b Area of the blue region

$$\begin{aligned} &= \int_2^3 (x-2)dx + \int_3^4 \sqrt{4-x}dx \\ &= \left[\frac{1}{2}x^2 - 2x \right]_2^3 + \left[-\frac{2}{3}(4-x)^{\frac{3}{2}} \right]_3^4 \\ &= \left(\frac{1}{2}(3)^2 - 2(3) \right) - \left(\frac{1}{2}(2)^2 - 2(2) \right) \\ &\quad + \left(-\frac{2}{3}(4-4)^{\frac{3}{2}} \right) - \left(-\frac{2}{3}(4-3)^{\frac{3}{2}} \right) \\ &= \left(\frac{9}{2} - 6 \right) - (2 - 4) + 0 + \frac{2}{3} \\ &= -\frac{3}{2} + 2 + \frac{2}{3} \\ &= \frac{7}{6} \text{ units}^2 \end{aligned}$$

c Area of the pink region

$$\begin{aligned} &= \int_0^2 (x-2 - (-\sqrt{4-x})) dx + \int_4^2 (-\sqrt{4-x}) dx \\ &= \int_0^2 (x-2 + (4-x)^{\frac{1}{2}}) dx - \int_4^2 (4-x)^{\frac{1}{2}} dx \\ &= \left[\frac{1}{2}x^2 - 2x - \frac{2}{3}(4-x)^{\frac{3}{2}} \right]_0^2 - \left[-\frac{2}{3}(4-x)^{\frac{3}{2}} \right]_4^2 \\ &= \left(\frac{1}{2}(2)^2 - 2(2) - \frac{2}{3}(4-2)^{\frac{3}{2}} \right) \\ &\quad - \left(\frac{1}{2}(0)^2 - 2(0) - \frac{2}{3}(4-0)^{\frac{3}{2}} \right) \\ &\quad - \left(-\frac{2}{3}(4-2)^{\frac{3}{2}} + \frac{2}{3}(4-4)^{\frac{3}{2}} \right) \\ &= 2 - 4 - \frac{2}{3}(2)^{\frac{3}{2}} + \frac{2}{3}(4)^{\frac{3}{2}} + \frac{2}{3}(2)^{\frac{3}{2}} \\ &= -2 + 5\frac{1}{3} \\ &= 3\frac{1}{3} \text{ units}^2 \end{aligned}$$

d Area between graphs = blue region + pink region

$$\begin{aligned} &= 1.17 + 3.3 \\ &= 4.5 \text{ units}^2 \end{aligned}$$

8.4 Exam questions

1 Equation of left-hand graph:

$$m = \frac{-3a}{2a} = -\frac{3}{2}, c = -a$$

$$y = -\frac{3}{2}x - a$$

Equation of right-hand graph:

$$m = \frac{2a}{a} = 2, c = -a$$

$$y = 2x - a$$

$$\begin{aligned} \text{Average value} &= \frac{1}{a - (-2a)} \int_{-2a}^a f(x)dx \\ &= \frac{1}{3a} \left(\int_{-2a}^0 \left(-\frac{3}{2}x - a \right) dx + \int_0^a (2x - a) dx \right) \\ &= \frac{a}{3} \end{aligned}$$

The correct answer is **B**.

2 $f: R \rightarrow R, f(x) = \cos\left(\frac{\pi x}{2}\right)$
 $g: R \rightarrow R, f(x) = \sin(\pi x)$

$$A_1 = \int_{\frac{1}{3}}^{\frac{1}{2}} (f(x) - g(x)) dx$$

$$A_2 = \int_{\frac{1}{2}}^{\frac{1}{3}} (g(x) - f(x)) dx$$

$$A_3 = \int_{\frac{1}{3}}^{\frac{5}{3}} (f(x) - g(x)) dx$$

$$A_4 = \int_{\frac{5}{3}}^{\frac{1}{3}} (g(x) - f(x)) dx$$

$$A = A_1 + A_2 + A_3 + A_4 \text{ but } A_2 = A_3, \text{ so } A = A_1 + 2A_2 + A_4.$$

$$\begin{aligned} &= \int_0^{\frac{1}{3}} (f(x) - g(x)) dx + 2 \int_{\frac{1}{3}}^1 (g(x) - f(x)) dx + \int_{\frac{5}{3}}^3 (g(x) - f(x)) dx \\ A &= \int_0^{\frac{1}{3}} (f(x) - g(x)) dx - 2 \int_{\frac{1}{3}}^1 (f(x) - g(x)) dx - \int_{\frac{5}{3}}^3 (f(x) - g(x)) dx \end{aligned}$$

The correct answer is **C**.

3 a $f(x) = x^2 e^{kx}$

Differentiating using the product rule:

$$f'(x) = 2xe^{kx} + x^2 ke^{kx} = e^{kx}(kx^2 + 2x)$$

$$f'(x) = xe^{kx}(kx + 2)$$

Award 1 mark for correct proof.

b $f(x) = f'(x)$

$$x^2 e^{kx} = e^{kx}(kx^2 + 2x)$$

$$\text{Since } e^{kx} \neq 0, x^2 = kx^2 + 2x \quad [1 \text{ mark}]$$

$$x^2(k-1) + 2x = 0$$

$$x(x(k-1) + 2) = 0$$

When $k = 1$, there is only one solution, $x = 0$. [1 mark]

VCAA Examination Report note:

Many students found this question challenging. Most students found the correct quadratic equation to solve but solved for k , rather than the x value that satisfied the quadratic equation. Few students realised that $x = 0$ was the unique solution. Incorrect use of the null factor law and/or the incorrect discriminant of the quadratic were the main sources of error.

$$\text{c } g(x) = -\frac{2xe^{kx}}{k}$$

$$A = \int_0^2 (f(x) - g(x)) dx$$

$$A = \int_0^2 \left(x^2 e^{kx} + \frac{2xe^{kx}}{k} \right) dx = \frac{1}{k} \int_0^2 (kx^2 + 2x) e^{kx} dx$$

[1 mark]

VCAA Examination Report note:

This question was attempted well, although students commonly left out the dx , or found the sum of the integral of $f(x)$ and $g(x)$.

d From part **a**, $\frac{d}{dx} [x^2 e^{kx}] = e^{kx} (kx^2 + 2x)$ so that

$$\int (kx^2 + 2x) e^{kx} dx = x^2 e^{kx}.$$

$$A = \frac{1}{k} [x^2 e^{2k}]_0^2 = \frac{1}{k} (4e^{2k} - 0) \quad [1 \text{ mark}]$$

$$= \frac{4e^{2k}}{k}$$

$$\frac{4e^{2k}}{k} = \frac{16}{k}$$

$$e^{2k} = 4$$

$$2k = \log_e(4) \quad [1 \text{ mark}]$$

$$k = \frac{1}{2} \log_e(4)$$

$$k = \log_e(2) \quad [1 \text{ mark}]$$

VCAA Examination Report note:

While students could equate their answer to part **c**. to $\frac{16}{k}$, many students did not use their result from part **a**. Incorrect algebraic manipulation made progress difficult for some students.

8.5 Applications

8.5 Exercise

$$\text{1 a, b } \frac{dN}{dt} = 0.8t + 2$$

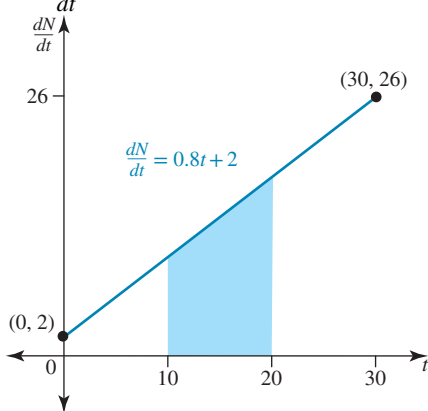
**c** Number of bricks

$$= \int_{10}^{20} (0.8t + 2) dt$$

$$= [0.4t^2 + 2t]_{10}^{20}$$

$$= (0.4(20)^2 + 2(20)) - (0.4(10)^2 + 2(10))$$

$$= 160 + 40 - 40 - 20$$

$$= 140 \text{ bricks}$$

$$\text{2 } v = 1 + 3\sqrt{t+1} = 1 + 3(t+1)^{\frac{1}{2}}$$

a Initially $t = 0$, $v = 1 + 3\sqrt{1} = 4$ m/s

$$\text{b } a = \frac{dv}{dt} = \frac{3}{2}(t+1)^{-\frac{1}{2}} = \frac{3}{2\sqrt{t+1}}$$

$$\text{i} \text{ When } t = 0, a = \frac{3}{2\sqrt{1}} = \frac{3}{2} = 1.5 \text{ m/s}^2.$$

$$\text{ii} \text{ When } t = 8, a = \frac{3}{2\sqrt{8+1}} = \frac{3}{6} = 0.5 \text{ m/s}^2.$$

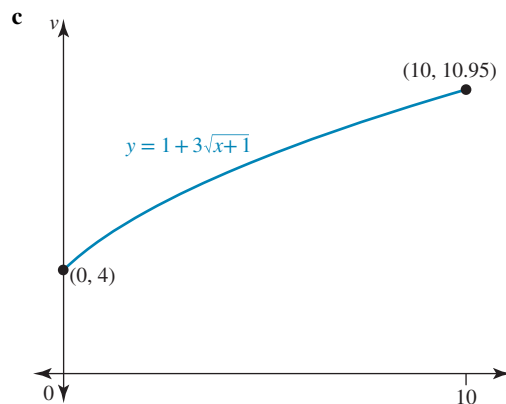
**d** Distance

$$= \int_0^8 (1 + 3(t+1)^{\frac{1}{2}}) dt$$

$$= \left[t + 2(t+1)^{\frac{3}{2}} \right]_0^8$$

$$= \left(8 + 2(8+1)^{\frac{3}{2}} \right) - \left(0 + 2(0+1)^{\frac{3}{2}} \right)$$

$$= 8 + 2(3^2)^{\frac{3}{2}} - 2$$

$$= 8 + 54 - 2$$

$$= 60 \text{ metres}$$

3 a $y = a(x-5)(x+5)$ When $x = 0$, $y = 5$.

$$5 = a(-5)(5)$$

$$5 = -25a$$

$$-\frac{1}{5} = a$$

$$a = -0.2$$

Thus, the equation of the arch is $y = 5 - 0.2x^2$.

$$\text{b } 2 \int_0^5 (5 - 0.2x^2) dx = 2 \left[5x - \frac{0.2}{3}x^3 \right]_0^5$$

$$= 2 \left\{ \left(5(5) - \frac{0.2}{3}(5)^3 \right) - 0 \right\}$$

$$= 2 \left(25 - 8\frac{1}{3} \right)$$

$$= 33\frac{1}{3} \text{ m}^2$$

$$\text{c} \text{ Stone area} = (12 \times 7) - 33\frac{1}{3} = 50\frac{2}{3} \text{ m}^2.$$

$$\text{d} \text{ The volume of the stones is } 50\frac{2}{3} \times 3 = 152 \text{ m}^3.$$

$$4 \text{ a } y = f(x) = 2 \log_e(4x), \quad x \in \left[\frac{1}{4}, \infty \right)$$

The inverse is $x = 2 \log_e(4y)$, $x \in [0, \infty)$.

$$\frac{1}{2}x = \log_e(4y)$$

$$e^{\frac{1}{2}x} = 4y$$

$$\frac{1}{4}e^{\frac{1}{2}x} = y$$

$$\text{Thus, } f^{-1}(x) = \frac{1}{4}e^{\frac{x}{2}}.$$

$$\begin{aligned} \text{b } \int_0^{2 \log_e 8} \left(\frac{1}{4}e^{\frac{1}{2}x} \right) dx &= \frac{1}{4} \int_0^{2 \log_e 8} \left(e^{\frac{1}{2}x} \right) dx \\ &= \frac{1}{4} \left[2e^{\frac{1}{2}x} \right]_0^{2 \log_e 8} \\ &= \frac{1}{4} \left\{ 2e^{\frac{1}{2}(2 \log_e 8)} - 2e^0 \right\} \\ &= \frac{1}{2}(8 - 1) \\ &= \frac{7}{2} \text{ units}^2 \end{aligned}$$

$$\text{c The required area is } 4 \log_e(8) - \frac{7}{2} \text{ units}^2.$$

5 a The graph intersects the x -axis where $y = 0$.

$$-\log_e(5x) = 0$$

$$\log_e(5x) = 0$$

$$e^0 = 5x$$

$$1 = 5x$$

$$x = \frac{1}{5}$$

The graph cuts the x -axis at $\left(\frac{1}{5}, 0 \right)$.

$$\text{b } y = -x \log_e(5x) + x$$

$$\frac{dy}{dx} = -x \times \frac{1}{x} + \log_e(5x) \times -1 + 1$$

$$\frac{dy}{dx} = -\log_e(5x)$$

$$\text{c The shaded region is } - \int_{\frac{1}{5}}^2 (-\log_e(5x)) dx = \int_{\frac{1}{5}}^2 (\log_e(5x)) dx$$

$$\begin{aligned} \int_{\frac{1}{5}}^2 (-\log_e(5x) - 1) dx &= \int_{\frac{1}{5}}^2 (-\log_e(5x)) dx - \int_{\frac{1}{5}}^2 (1) dx \\ &= [-x \log_e(5x)]_{\frac{1}{5}}^2 \end{aligned}$$

$$\int_{\frac{1}{5}}^2 (\log_e(5x)) dx + [x]_{\frac{1}{5}}^2 = -[-x \log_e(5x)]_{\frac{1}{5}}^2$$

$$\int_{\frac{1}{5}}^2 (\log_e(5x)) dx = -[-x \log_e(5x)]_{\frac{1}{5}}^2 - [x]_{\frac{1}{5}}^2$$

$$\int_{\frac{1}{5}}^2 (\log_e(5x)) dx = - \left(-2 \log_e(10) + \frac{1}{5} \log_e(1) \right) - \left(2 - \frac{1}{5} \right)$$

$$\begin{aligned} \int_{\frac{1}{5}}^2 (\log_e(5x)) dx &= 2 \log_e(10) - \frac{1}{5} \log_e(1) - 2 + \frac{1}{5} \\ \int_{\frac{1}{5}}^2 (\log_e(5x)) dx &= 2 \log_e(10) - \frac{9}{5} \text{ units}^2 \end{aligned}$$

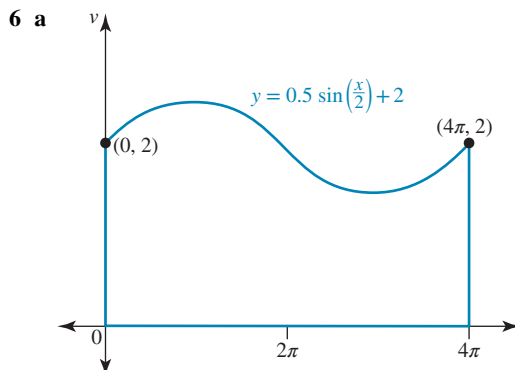

$$\begin{aligned} \text{b Area} &= \int_0^{4\pi} \left(0.5 \sin\left(\frac{x}{2}\right) + 2 \right) dx \\ &= \left[-\cos\left(\frac{x}{2}\right) + 2x \right]_0^{4\pi} \\ &= (-\cos(2\pi) + 2(4\pi)) - (-\cos(0) + 2(0)) \\ &= -1 + 8\pi + 1 \\ &= 8\pi \\ &\approx 25 \text{ m}^2 \end{aligned}$$

c The volume of soil required is $0.5 \times 25 = 12.5 \text{ m}^3$.

$$7 \frac{dL}{dt} = \frac{4}{\sqrt{t}} = 4t^{-\frac{1}{2}}$$

The average total increase in length is

$$\begin{aligned} \int_6^{36} 4t^{-\frac{1}{2}} dt &= \left[8t^{\frac{1}{2}} \right]_6^{36} \\ &= (8\sqrt{36}) - (8\sqrt{6}) \\ &= 48 - 19.6 \\ &= 28.4 \text{ cm} \end{aligned}$$

Therefore, the average total increase in length is 28.4 cm.

$$\begin{aligned} 8 \ N &= \int_0^{17} 0.853e^{0.1333t} dt \\ &= \left[6.3991e^{0.1333t} \right]_0^{17} \\ &= 6.3991e^{0.1333(17)} - 6.3991e^{0.1333(0)} \\ &= 6.3991(9.6417 - 1) \\ &= 55.3 \text{ million} \end{aligned}$$

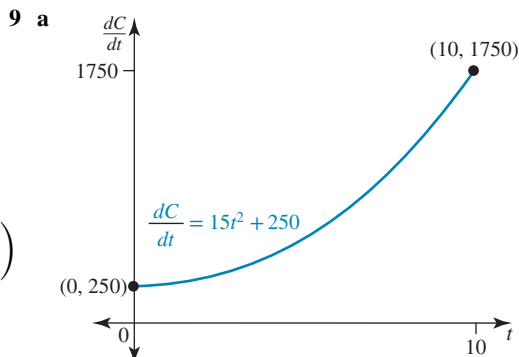

b Total cost

$$\begin{aligned}
&= \int_5^{10} (15t^2 + 250) dt \\
&= [5t^3 + 250t]_5^{10} \\
&= (5(10)^3 + 250(10)) - (5(5)^3 + 250(5)) \\
&= (5000 + 2500) - (625 + 1250) \\
&= 7500 - 1875 \\
&= \$5625
\end{aligned}$$

10 a The graph cuts the y -axis where $x = 0$, $y = 2 \log_e(5) + 1$.The graph cuts the x -axis where $y = 0$.

$$2 \log_e(x + 5) + 1 = 0$$

$$2 \log_e(x + 5) = -1$$

$$\log_e(x + 5) = -\frac{1}{2}$$

$$e^{-\frac{1}{2}} = x + 5$$

$$x = e^{-\frac{1}{2}} - 5$$

At the point $(e^{-0.5} - 5, 0)$ **b** h : dom = $(-5, \infty)$ and ran = R h^{-1} : dom = R and ran = $(-5, \infty)$ If $y = 2 \log_e(x + 5) + 1$ Inverse is $x = 2 \log_e(y + 5) + 1$

$$x - 1 = 2 \log_e(y + 5)$$

$$\frac{1}{2}(x - 1) = \log_e(y + 5)$$

$$e^{\frac{1}{2}(x-1)} = y + 5$$

$$y = e^{\frac{1}{2}(x-1)} - 5$$

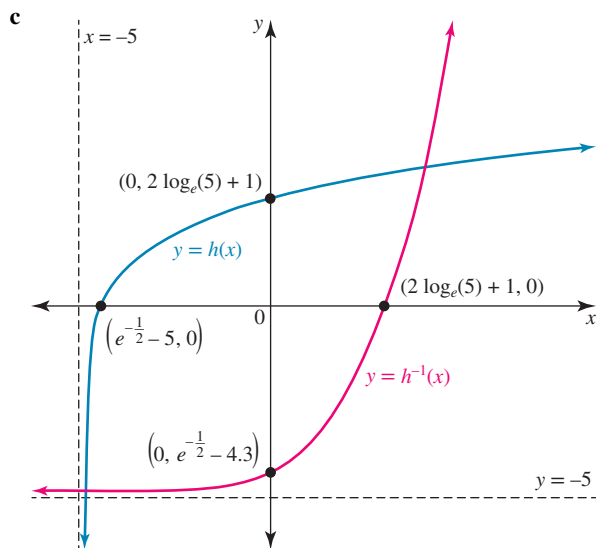
Thus, $h^{-1}(x) = e^{\frac{1}{2}(x-1)} - 5$.**d** $h(x) = h^{-1}(x)$

$$2 \log_e(x + 5) + 1 = e^{\frac{1}{2}(x-1)} - 5$$

$$x = -4.9489, 5.7498$$

e
$$\int_{-4.9489}^{5.7498} \left(2 \log_e(x + 5) + 1 - e^{\frac{1}{2}(x-1)} + 5 \right) dx$$

$$= 72.7601 \text{ units}^2$$

11 a $y = x \log_e(x)$

$$\frac{dy}{dx} = \log_e(x) + x \times \frac{1}{x}$$

$$\frac{dy}{dx} = \log_e(x) + 1$$

Thus,

$$\int_1^{e^2} (\log_e(x) + 1) dx = [x \log_e(x)]_1^{e^2}$$

$$\int_1^{e^2} \log_e(x) dx + \int_1^{e^2} 1 dx = [x \log_e(x)]_1^{e^2}$$

$$\int_1^{e^2} \log_e(x) dx = (e^2 \log_e(e^2) - (1) \log_e(1)) - \int_1^{e^2} 1 dx$$

$$\int_1^{e^2} \log_e(x) dx = 2e^2 \log_e(e) - [x]_1^{e^2}$$

$$\int_1^{e^2} \log_e(x) dx = 2e^2 - e^2 + 1$$

$$\int_1^{e^2} \log_e(x) dx = e^2 + 1$$

b $y = x (\log_e(x))^m$

$$\frac{dy}{dx} = (\log_e(x))^m + mx (\log_e(x))^{m-1} \times \frac{1}{x}$$

$$\frac{dy}{dx} = (\log_e(x))^m + m (\log_e(x))^{m-1}$$

c Thus,

$$\int_1^{e^2} ((\log(x))^m + m(\log(x))^{m-1}) dx = [x(\log_p(x))^m]_1^{e^2}$$

$$\int_1^{e^2} (\log(x))^m dx + m \int_1^{e^2} (\log(x))^{m-1} dx = [x(\log_e(x))^m]_1^{e^2}$$

$$\int_1^{e^2} (\log(x))^m dx + m \int_1^{e^2} (\log(x))^{m-1} dx = e^2 (\log(e^2))^m - (1) (\log_e(1))^m$$

$$\int_1^{e^2} (\log(x))^m dx + m \int_1^{e^2} (\log_e(x))^{m-1} dx = e^2 (2 \log_e(e))^m - 0$$

$$\int_1^{e^2} (\log_e(x))^m dx + m \int_1^{e^2} (\log(x))^{m-1} dx = 2^m e^2$$

If $I_m = \int_1^{e^2} (\log_e(x))^m dx$, then

$$I_m + mI_{m-1} = 2^m e^2 \text{ as required.}$$

d $I_3 = \int_1^{e^2} (\log_e(x))^3 dx$ if $I_m = \int_1^{e^2} (\log_e(x))^m dx$

Remembering that $I_1 = e^2 + 1$,

$$I_2 + 2I_1 = 2^2 e^2$$

$$I_2 = 2^2 e^2 - 2I_1$$

$$I_2 = 4e^2 - 2(e^2 + 1)$$

$$I_2 = 4e^2 - 2e^2 - 2$$

$$I_2 = 2e^2 - 2$$

$$I_3 + 3I_2 = 2^3 e^2$$

$$I_3 = 2^3 e^2 - 3I_2$$

$$I_3 = 8e^2 - 3(2e^2 - 2)$$

$$I_3 = 8e^2 - 6e^2 + 6$$

$$I_3 = 2e^2 + 6$$

$$\text{So } \int_1^{e^2} (\log_e(x))^3 dx = 2e^2 + 6.$$

- 12 POI between $y = -4$ and $y = \log_e\left(\frac{x}{2}\right)$ is $x = -0.03663$

$$\begin{aligned} A &= 2 \int_0^1 2e^x dx - \int_{0.03663}^1 \log_e\left(\frac{x}{2}\right) dx + 0.03663 \times 4 \\ &= 5.093 \text{ km}^2 \\ &= 5.1 \text{ km}^2 \end{aligned}$$

- 13 $A = 4.6 \log_e(t - 4)$

- a The graph intersects the t -axis where $A = 0$.

$$4.6 \log_e(t - 4) = 0$$

$$\log_e(t - 4) = 0$$

$$e^0 = t - 4$$

$$1 = t - 4$$

$$t = 5$$

Thus, $(a, 0) \equiv (5, 0)$, $a = 5$

- b When $A = 15$,

$$15 = 4.6 \log_e(t - 4)$$

$$\frac{15}{4.6} = \log_e(t - 4)$$

$$e^{3.2609} = t - 4$$

$$e^{3.2609} + 4 = t$$

$$t = 30$$

It takes the patient 30 minutes to reach level 15.

c $\frac{dA}{dt} = \frac{4.6}{t-4}$

When $t = 10$, $\frac{dA}{dt} = \frac{4.6}{10-4} = \frac{4.6}{6} = \frac{46}{60} = \frac{23}{30}$ units/min

- d The total change is given by

$$\int_5^{30} 4.6 \log_e(t - 4) dt$$

$$= 4.6 \int_5^{30} \log_e(t - 4) dt$$

$$= 4.6 \times 59.7105$$

$$= 274.6683$$

The change in alertness is 274.6683 units.

- 14 a $v = \frac{dx}{dt} = 3 \cos\left(\frac{t}{2} - \frac{\pi}{4}\right)$

$$x = \int 3 \cos\left(\frac{t}{2} - \frac{\pi}{4}\right) dt$$

$$x = 6 \sin\left(\frac{t}{2} - \frac{\pi}{4}\right) + c$$

When $t = 0$, $x = -3\sqrt{2}$.

$$-3\sqrt{2} = 6 \sin\left(-\frac{\pi}{4}\right) + c$$

$$-3\sqrt{2} = 6 \left(-\frac{\sqrt{2}}{2}\right) + c$$

$$-3\sqrt{2} = -3\sqrt{2} + c$$

$$c = 0$$

Thus, $x = 6 \sin\left(\frac{t}{2} - \frac{\pi}{4}\right)$.

- b When $t = 3\pi$,

$$x = 6 \sin\left(\frac{3\pi}{2} - \frac{\pi}{4}\right)$$

$$x = 6 \sin\left(\frac{6\pi}{4} - \frac{\pi}{4}\right)$$

$$x = 6 \sin\left(\frac{5\pi}{4}\right)$$

$$x = 6 \times -\frac{\sqrt{2}}{2} = -3\sqrt{2} \text{ m}$$

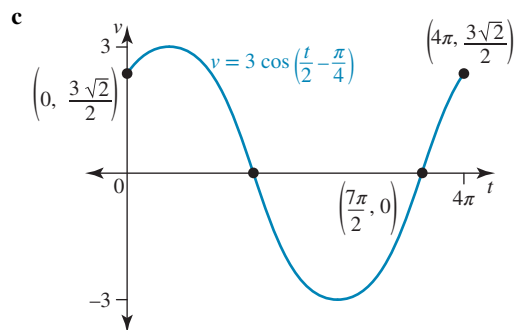

- d Distance

$$\begin{aligned} &\int_0^{\frac{3\pi}{2}} 3 \cos\left(\frac{t}{2} - \frac{\pi}{4}\right) dt - \int_{\frac{3\pi}{2}}^{3\pi} 3 \cos\left(\frac{t}{2} - \frac{\pi}{4}\right) dt \end{aligned}$$

$$= 2 \int_0^{\frac{3\pi}{2}} 3 \cos\left(\frac{t}{2} - \frac{\pi}{4}\right) dt$$

$$= 2 \left[6 \sin\left(\frac{t}{2} - \frac{\pi}{4}\right) \right]_0^{\frac{3\pi}{2}}$$

$$= 2 \left(6 \sin\left(\frac{3\pi}{4} - \frac{\pi}{4}\right) - 6 \sin\left(-\frac{\pi}{4}\right) \right)$$

$$= 2 \left(6 \sin\left(\frac{\pi}{2}\right) - 6 \sin\left(-\frac{\pi}{4}\right) \right)$$

$$= 2 \left(6 + 3\sqrt{2} \right)$$

$$= 20.49 \text{ m}$$

- e $v = 3 \cos\left(\frac{t}{2} - \frac{\pi}{4}\right)$

$$a = \frac{dv}{dt} = -\frac{3}{2} \sin\left(\frac{t}{2} - \frac{\pi}{4}\right)$$

- f When $t = 3\pi$,

$$a = -\frac{3}{2} \sin\left(\frac{3\pi}{2} - \frac{\pi}{4}\right)$$

$$a = -\frac{3}{2} \sin\left(\frac{6\pi}{4} - \frac{\pi}{4}\right)$$

$$a = -\frac{3}{2} \sin\left(\frac{5\pi}{4}\right)$$

$$a = -\frac{3}{2} \times -\frac{\sqrt{2}}{2} = \frac{3\sqrt{2}}{4} \text{ m/s}^2$$

15 $v = e^{-0.5t} - 0.5$

a $a = \frac{dv}{dt} = -0.5e^{-0.5t}$

b $x = \int (e^{-0.5t} - 0.5) dt$
 $= -2e^{-0.5t} - 0.5t + c$

When $x = 0$, $t = 0$.

$0 = -2e^{-0.5(0)} - 0.5(0) + c$

$c = 2$

$x = -2e^{-0.5t} - 0.5t + 2$

c When $t = 4$,

$x = -2e^{-0.5(4)} - 0.5(4) + 2 = -0.2707$ metres

d The fourth second occurs between $t = 3$ and $t = 4$.

Distance

$= \int_3^4 (e^{-0.5t} - 0.5) dt$

$= [-2e^{-0.5t} - 0.5t]_3^4$

$= (-2e^{-0.5(3)} - 0.5(3)) - (-2e^{-0.5(4)} - 0.5(4))$

$= -2e^{-1.5} - 1.5 + 2e^{-2} + 2$

$= 0.3244$ metres

16 Parabola of the form $y = a(x - 2)(x + 2)$

$(0, -3) \Rightarrow -3 = a(-2)(2)$

$-3 = -4a$

$a = \frac{3}{4}$

The equation of the parabola is

$y = \frac{3}{4}(x - 2)(x + 2)$

$= \frac{3}{4}(x^2 - 4)$

$= \frac{3}{4}x^2 - 3$

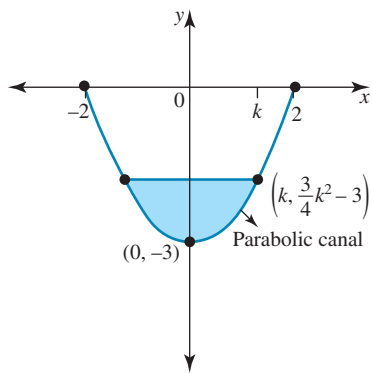

If the canal were full with water, the cross-sectional area would be

$= \int_{-2}^2 \left(\frac{3}{4}x^2 - 3 \right) dx$

$= -2 \int_0^2 \left(\frac{3}{4}x^2 - 3 \right) dx$

$= -2 \left[\frac{1}{4}x^3 - 3x \right]_0^2$

$= -2 \left(\left(\frac{1}{4}(2)^3 - 3(2) \right) - 0 \right)$

$= -2(2 - 6)$

$= 8 \text{ m}^2$

When the canal is one-third full, the cross-sectional

area is $\frac{8}{3} \text{ m}^2$.

The cross-sectional area for a canal that is one-third full is given by

$A = 2 \int_0^k \left(\frac{3}{4}x^2 - 3 \right) dx$

$\frac{8}{3} = 2 \int_0^k \left(\frac{3}{4}x^2 - 3 \right) dx$

$= 2 \left[\frac{3}{4}x^2 - 3x \right]_0^k$

$= 2 \left(\frac{3}{4}k^2 - 3k \right)$

$= 2 \left(\frac{1}{2}k^2 \right)$

$= k^2$

$k = \sqrt{\frac{8}{3}}$

$= 1.39$

$y = \frac{3}{4} \times (1.39)^2 - 3$

$= -1.58$

Therefore, the depth of water $= -1.58 - (-3) = 1.44 \text{ m}$.

17 a $y = f(x) = e^{\frac{1}{2}(x-1)} + 3$

Inverse: $x = e^{2(y-1)} + 3$

$x - 3 = e^{2(y-1)}$

$\log_e(x - 3) = \frac{1}{2}(y - 1)$

$2 \log_e(x - 3) = y - 1$

$y = 2 \log_e(x - 3) + 1$

Thus, $f^{-1}: (3, \infty) \rightarrow \mathbb{R}$, $f^{-1}(x) = 2 \log_e(x - 3) + 1$.

b The graph cuts the y-axis when $x = 0$.

$y = e^{-\frac{1}{2}} + 3$

The point is $\left(0, e^{-\frac{1}{2}} + 3 \right)$.

The graph cuts x-axis where $y = 0$.

$2 \log_e(x - 3) + 1 = 0$

$2 \log_e(x - 3) = -1$

$\log_e(x - 3) = -\frac{1}{2}$

$e^{-\frac{1}{2}} = x - 3$

$x = e^{-\frac{1}{2}} + 3$

The point is $\left(e^{-\frac{1}{2}} + 3, 0 \right)$.

c $\int_0^5 \left(e^{\frac{1}{2}(x-1)} + 3 \right) dx - \int_{e^{-0.5}+3}^5 (2 \log_e(x - 3) + 1) dx$

$= 28.5651 - 1.9857$

$= 26.58 \text{ m}^2$

d Solve $(-5 = 2 \log_e(x - 3) + 1)$ for x

$x = 3 + e^{-3}$

$$A = 5 \times 3 + e^{-3} - \int_{3+e^{-3}}^{e^{-0.5}+3} (2 \log_e(x-3) + 1) dx$$

$$= 16.11 \text{ m}^2$$

- e The total area of the Australian native garden is $26.5794 + 16.11 = 42.69 \text{ m}^2$.

8.5 Exam questions

1 a $f_1(x) : [0, 200] \rightarrow R, f_1(x) = 20 \cos\left(\frac{\pi x}{100}\right) + 40$

$f_2(x) : [0, 200] \rightarrow R, f_2(x) = 20 \cos\left(\frac{\pi x}{100}\right) + 30$

$P(50, 30), f_1(50) = 40$

The swimmer needs to swim north 10 metres.

Award 1 mark for the correct answer.

b Solving $f_1(x) = 30 \Rightarrow x = \frac{200}{3}, \frac{400}{3}$

So the distance is $\frac{200}{3} - 50 = \frac{50}{3}$ metres.

Award 1 mark for solving for x values.

Award 1 mark for the correct distance.

c Distance from P to a point on $f_1(x)$:

$$s(x) = \sqrt{(x-50)^2 + (f_1(x) - 30)^2}$$

Solving $\frac{ds}{dx} = 0 \Rightarrow x = 54.477, f_1(54.477) = 8.47$

The minimum distance is 8.5 metres (to 1 d.p.).

Award 1 mark for solving the distance derivative to zero.

Award 1 mark for the correct minimum distance.

d $A = \int_0^{200} (f_1(x) - f_2(x)) dx = 2000 \text{ m}^2$

Award 1 mark for the correct area.

e The required area is

$$N = 30 \times (150 - 50) - \int_{\frac{200}{3}}^{\frac{400}{3}} (30 - f_1(x)) dx - \int_{50}^{150} f_2(x) dx$$

$$= 837 \text{ m}^2$$

Award 1 mark for each correct definite integral.

Award 1 mark for the correct area.

f $s(x) = kf_1(x) - f_2(x) < 20$

$$s(x) = 20(k-1) \cos\left(\frac{\pi x}{100}\right) + 40k - 30$$

The maximum separation occurs when

$$\cos\left(\frac{\pi x}{100}\right) = 1 \text{ or } x = 0, 200.$$

This gives $60k = 70$.

Given that $k \geq 1, k \in \left[1, \frac{7}{6}\right)$.

Award 1 mark for solving.

Award 1 mark for the correct interval.

2 a $f(t) = \sin\left(\frac{\pi t}{3}\right) + \sin\left(\frac{\pi t}{6}\right), t \geq 0$

The period is 12, since $f(t+12) = f(t)$ [1 mark]

VCAA Examination Report note:

This question was answered well. Common incorrect answers were 6, 18 and $12t$.

b $f(t) = 0, t \in [0, 6] \Rightarrow t = 0, 4, 6$ [1 mark]

VCAA Examination Report note:

This question was answered well. Some students only gave two values, either 0, 4 or 4, 6.

c Solving $f'(t) = \frac{\pi}{3} \cos\left(\frac{\pi t}{3}\right) + \frac{\pi}{6} \cos\left(\frac{\pi t}{6}\right) = 0, t \in (0, 4)$
 $t = 1.8875, f(1.8875) = 1.76$ [1 mark]

VCAA Examination Report note:

This question was answered well. Common incorrect answers were 1.73 and 1.79.

d $A = \int_0^4 f(t) dt - \int_6^4 f(t) dt = \frac{15}{\pi}$

Award 1 mark for correct integrals.

Award 1 mark for the correct equation.

VCAA Examination Report note:

The most common incorrect answer was

$$\int_0^4 f(t) dt + \int_4^6 f(t) dt = \frac{12}{\pi} \text{ or } \int_0^6 f(t) dt = \frac{12}{\pi}$$

e $12k = 2 \times \frac{15}{\pi}$

$$12k = \frac{30}{\pi}, k = \frac{5}{2\pi}$$

Award 1 mark for correct working.

Award 1 mark for the correct value of k .

VCAA Examination Report note:

Many students did not double their answer from Question

3d., giving $12k = \frac{15}{\pi}, k = \frac{5}{4\pi}$.

Other students had the correct method but wrote their final answer as $k = \frac{5\pi}{2}$.

3 a $y = f(x) = 60 - \frac{3}{80}x^2$

$$\frac{dy}{dx} = \frac{6}{80}x$$

$$\left.\frac{dy}{dx}\right|_{x=-40} = -\frac{6}{80} \times -40$$

$$= 3$$

$$= \tan(\theta)$$

$$\theta = \tan^{-1}(3)$$

$$= 71.56^\circ$$

$$= 72^\circ$$

Award 1 mark for the gradient at the point.

Award 1 mark for the correct angle.

VCAA Assessment Report note:

This question was not answered well. A common incorrect

response was 71° . Some students did not convert their

answer to degrees. Others gave the answer as 56° , using $\tan(\theta) = \frac{ON}{OA} = \frac{60}{40}$. Some found $m = 3$ but were unable to find the angle.

b $y = g(x) = \frac{x^3}{25600} - \frac{3x}{16} + 35$

$$p(x) = \frac{dy}{dx} = \frac{3x^2}{25600} - \frac{3}{16}$$

$$\frac{dp}{dx} = \frac{6x}{25600} = 0 \Rightarrow x = 0$$

$$p(0) = -\frac{3}{16}$$

The maximum slope is $-\frac{3}{16}$. That is, $\frac{3}{16}$ downwards.

Award 1 mark for the correct derivative.

Award 1 mark for the correct maximum slope.

VCAA Assessment Report note:

Some students did not interpret the question correctly and found the gradient of the straight line passing through X and Y . Some solved $h'(x) = 0$ for x .

$$\begin{aligned} \text{c } s(x) &= f(x) - g(x) \\ &= \left(60 - \frac{3}{80}x^2\right) - \left(\frac{x^3}{25\,600} - \frac{3x}{16} + 35\right) \end{aligned}$$

$$\frac{ds}{dx} = 0 \Rightarrow x = u = 2.490\,31$$

$$g(u) = 34.5337$$

$$M(2.49, 34.53)$$

Award 1 mark for setting up the difference of functions.

Award 1 mark for solving the derivative equal to zero and obtaining the correct value of u .

Award 1 mark for the correct coordinates.

VCAA Assessment Report note:

Some students did not give their answers correct to two decimal places. Some worked to one decimal place and others rounded their answers incorrectly. Others did not set up the distance formula correctly or did not use brackets correctly in the distance formula. Some substituted u into g instead of h . A common incorrect response was $v = 24.53$.

$$\text{d } w = g(-u) = 35.4663 = 35.47 \quad [1 \text{ mark}]$$

$$\begin{aligned} d(MN) &= f(u) - g(u) \\ &= 25.23 \quad [1 \text{ mark}] \end{aligned}$$

$$\begin{aligned} d(PQ) &= f(-u) - g(-u) \\ &= 24.30 \quad [1 \text{ mark}] \end{aligned}$$

VCAA Assessment Report note:

Some students did not work to the required number of decimal places or rounded incorrectly. Others had

$$PQ = 25.23 \text{ and } MN = 24.30.$$

$$\begin{aligned} \text{e } f(x) &= 60 - \frac{3}{80}x^2 \\ g(x) &= \frac{x^3}{25\,600} - \frac{3x}{16} + 35 \end{aligned}$$

Solving $f(x) = g(x)$

$$60 - \frac{3}{80}x^2 = \frac{x^3}{25\,600} - \frac{3x}{16} + 35 \quad [1 \text{ mark}]$$

$$x_e = -23.71 \quad [1 \text{ mark}]$$

$$x_f = 28.00 \quad [1 \text{ mark}]$$

VCAA Assessment Report note:

Some students did not work to the required number of decimal places. Others rounded to 27.00 instead of 28.00. Some students gave answers without showing any working.

$$\begin{aligned} \text{f } A &= \int_{x_e}^{x_f} (f(x) - g(x)) dx \\ &= \int_{-23.7}^{28} \left(60 - \frac{3}{80}x^2\right) - \left(\frac{x^3}{25\,600} - \frac{3x}{16} + 35\right) dx \\ &= 869.62 \\ &= 870 \text{ m}^2 \quad [1 \text{ mark}] \end{aligned}$$

VCAA Assessment Report note:

Some students rounded incorrectly to 869 or did not work to the required number of decimal places. Some gave their answers in exact form.

8.6 Review**8.6 Exercise****Technology free: short answer**

$$\begin{aligned} \text{1 a i } \int_{-\frac{\pi}{6}}^{\frac{\pi}{2}} (4 \sin(2x) + \cos(3x)) dx &= \left[-\frac{4}{2} \cos(2x) + \frac{1}{3} \cos(3x)\right]_{-\frac{\pi}{6}}^{\frac{\pi}{2}} \\ &= \left[-2 \cos(2x) + \frac{1}{3} \cos(3x)\right]_{-\frac{\pi}{6}}^{\frac{\pi}{2}} \\ &= -2 \cos\left(2 \times \frac{\pi}{2}\right) + \frac{1}{3} \cos\left(3 \times \frac{\pi}{2}\right) \\ &\quad - \left(-2 \cos\left(2 \times \frac{-\pi}{6}\right) + \frac{1}{3} \cos\left(3 \times \frac{-\pi}{6}\right)\right) \\ &= -2 \cos(\pi) + \frac{1}{3} \cos\left(\frac{3\pi}{2}\right) \\ &\quad - \left(-2 \cos\left(\frac{-\pi}{3}\right) + \frac{1}{3} \cos\left(\frac{-\pi}{2}\right)\right) \\ &= -2 \times -1 + \frac{1}{3} \times 0 - \left(-2 \times \frac{1}{2} + \frac{1}{3} \times 0\right) \\ &= 2 + 1 \\ &= 3 \end{aligned}$$

$$\begin{aligned} \text{ii } \int_0^2 (3x + 6\sqrt{x} + 1) dx &= \int_0^2 (3x + 6x^{\frac{1}{2}} + 1) dx \\ &= \left[\frac{3x^2}{2} + \frac{2}{3} \times 6x^{\frac{3}{2}} + x\right]_0^2 \\ &= \left[\frac{3x^2}{2} + 4x^{\frac{3}{2}} + x\right]_0^2 \\ &= \frac{3(2)^2}{2} + 4(2)^{\frac{3}{2}} + (2) - (0) \\ &= 6 + 4\sqrt{8} + 2 \\ &= 8 + 4\sqrt{4 \times 2} \\ &= 8 + 4 \times 2\sqrt{2} \\ &= 8 + 8\sqrt{2} \\ &= 8(\sqrt{2} + 1) \end{aligned}$$

$$\begin{aligned} \text{iii } \int_0^{\frac{1}{2}} (e^x + 1)(e^x - 1) dx &= \int_0^{\frac{1}{2}} (e^{2x} - 1) dx \\ &= \left[\frac{e^{2x}}{2} - x\right]_0^{\frac{1}{2}} \\ &= \frac{e^{2 \times \frac{1}{2}}}{2} - \frac{1}{2} - \left(\frac{e^0}{2} - 0\right) \end{aligned}$$

$$= \frac{e}{2} - \frac{1}{2} - \frac{1}{2}$$

$$= \frac{e}{2} - 1$$

b i $\int_1^5 (4f(x) + 1) dx$

$$= \int_1^5 (4f(x)) dx + \int_1^5 1 dx$$

$$= 4 \int_1^5 (f(x)) dx + \int_1^5 1 dx$$

$$= 4 \times 4 + [x]_1^5$$

$$= 16 + 5 - 1$$

$$= 20$$

ii $\int_1^5 (2f(x) - g(x)) dx$

$$= \int_1^5 (2f(x)) dx - \int_1^5 (g(x)) dx$$

$$= 2 \int_1^5 (f(x)) dx - \int_1^5 (g(x)) dx$$

$$= 2 \times 4 - 3$$

$$= 8 - 3$$

$$= 5$$

iii $\int_1^5 (3f(x) + 2g(x) - 5) dx$

$$= \int_1^5 (3f(x)) dx + \int_1^5 (2g(x)) dx - \int_1^5 (5) dx$$

$$= 3 \int_1^5 (f(x)) dx + 2 \int_1^5 (2g(x)) dx - [5x]_1^5$$

$$= 3 \times 4 + 2 \times 3 - (5 \times 5 - 5 \times 1)$$

$$= 12 + 6 - (25 - 5)$$

$$= 18 - 20$$

$$= -2$$

2 a i Express $x + 2$ in terms of $x + 1$:

$$x + 2 = (x + 1) + 1$$

Therefore,

$$\int_0^2 \frac{x+2}{x+1} dx$$

$$= \int_0^2 \frac{(x+1)+1}{x+1} dx$$

$$= \int_0^2 \frac{x+1}{x+1} + \frac{1}{x+1} dx$$

$$= \int_0^2 \left(1 + \frac{1}{x+1} \right) dx$$

$$= [x + \log_e(x+1)]_0^2$$

$$= 2 + \log_e(2+1) - (0 + \log_e(0+1))$$

$$= 2 + \log_e(3)$$

ii $\int_{-2}^{-1} \frac{3}{2x+1} dx$

$$= 3 \left[\frac{1}{2} \log_e(2x+1) \right]_{-2}^{-1}$$

Negative values cannot be evaluated, so symmetry is needed. The definite integral should be negative as the region lies under the curve.

$$\int_{-2}^{-1} \frac{3}{2x+1} dx$$

$$= -3 \left[\frac{1}{2} \log_e(2x+1) \right]_0^1$$

$$= -\frac{3}{2} (\log_e(3) - \log_e(1))$$

$$= -\frac{3}{2} \log_e(3)$$

b $\int_3^a \frac{1}{3(x-1)} dx = 1$

$$\frac{1}{3} \int_3^a \frac{1}{(x-1)} dx = 1$$

$$\int_3^a \frac{1}{(x-1)} dx = 3$$

$$[\log_e(x-1)]_3^a = 3$$

$$\log_e(a-1) - \log_e(3-1) = 3$$

$$\log_e \left(\frac{a-1}{2} \right) = 3$$

$$\frac{a-1}{2} = e^3$$

$$a-1 = 2e^3$$

$$a = 2e^3 + 1$$

3 a $\int_1^m 6(2x-1)^2 dx = 1$

$$\frac{1}{2} \left[\frac{6(2x-1)^3}{2 \times 3} \right]_{\frac{1}{2}}^m = 1$$

$$[(2x-1)^3]_{\frac{1}{2}}^m = 1$$

$$(2m-1)^3 - \left(2 \times \frac{1}{2} - 1 \right) = 1$$

$$(2m-1)^3 - (1-1) = 1$$

$$(2m-1)^3 = 1$$

$$2m-1 = \sqrt[3]{1}$$

$$2m-1 = 1$$

$$2m = 2$$

$$m = 1$$

b $\int_0^{\frac{3\pi}{2}} (2 \sin(x) + k - k \cos(x)) dx = 4 + 3\pi$

$$4 + 3\pi = [-2 \cos(x) + kx - k \sin(x)]_0^{\frac{3\pi}{2}}$$

$$4 + 3\pi = \left(-2 \cos \left(\frac{3\pi}{2} \right) + k \left(\frac{3\pi}{2} \right) - k \sin \left(\frac{3\pi}{2} \right) \right) - (-2 \cos(0) + k(0) - k \sin(0))$$

$$4 + 3\pi = 0 + \frac{3\pi k}{2} + k + 2$$

$$k\left(\frac{3\pi}{2} + 1\right) = 3\pi + 2$$

$$\frac{1}{2}k(3\pi + 2) = 3\pi + 2$$

$$\frac{1}{2}k = 1$$

$$k = 2$$

$$4 \text{ a } f_{\text{avg}} = \frac{1}{b-a} \int_a^b f(x) dx$$

$$= \frac{1}{2-0} \int_0^2 \sqrt{x} dx$$

$$= \frac{1}{2} \int_0^2 x^{\frac{1}{2}} dx$$

$$= \frac{1}{2} \left[\frac{2x^{\frac{3}{2}}}{\frac{3}{2}} \right]_0^2$$

$$= \frac{1}{2} \left(\frac{2(2)^{\frac{3}{2}}}{3} - \frac{2(0)^{\frac{3}{2}}}{3} \right)$$

$$= \frac{1}{2} \times \frac{2\sqrt{8}}{3}$$

$$= \frac{\sqrt{8}}{3}$$

$$= \frac{2\sqrt{2}}{3}$$

$$b \quad \begin{aligned} \sqrt{x} &= 2 - x \\ x &= (2 - x)^2 \\ x &= 4 - 4x + x^2 \end{aligned}$$

$$x^2 - 5x + 4 = 0$$

$$(x - 4)(x - 1) = 0$$

$$x - 4 = 0 \text{ or } x - 1 = 0$$

$$x = 4 \quad x = 1$$

But $x = 1$ as $x \in [0, 2]$.

c Area of the blue region:

$$A_1 = \int_0^1 x^{\frac{1}{2}} dx + \int_1^2 (2 - x) dx$$

$$= \left[\frac{2}{3} x^{\frac{3}{2}} \right]_0^1 + \left[2x - \frac{1}{2} x^2 \right]_1^2$$

$$= \left(\frac{2}{3} (1)^{\frac{3}{2}} \right) - 0 + \left(2(2) - \frac{1}{2} (2)^2 \right) - \left(2(1) - \frac{1}{2} (1)^2 \right)$$

$$= \frac{2}{3} + 4 - 2 - 2 + \frac{1}{2}$$

$$= \frac{4}{6} + \frac{3}{6}$$

$$= \frac{7}{6}$$

$$= 1\frac{1}{6} \text{ units}^2$$

d Pink region = area of triangle – area of blue region

The rule for the area of a triangle is $A = \frac{b \times h}{2}$.

$$A_2 = \frac{2 \times 2}{2} - 1\frac{1}{6}$$

$$= 2 - 1\frac{1}{6}$$

$$= \frac{5}{6} \text{ unit}^2$$

$$5 \text{ a } y = 4x^2 \quad [1]$$

$$y = \frac{1}{4x^2} \quad [2]$$

$$[1] = [2]$$

$$4x^2 = \frac{1}{4x^2}$$

$$16x^4 = 1$$

$$x^4 = \frac{1}{16}$$

$$x = \pm \frac{1}{2}$$

When

$$x = \frac{1}{2}, \quad y = 4 \left(\frac{1}{2} \right)^2 = 1$$

$$x = -\frac{1}{2}, \quad y = 4 \left(-\frac{1}{2} \right)^2 = 1$$

Therefore, the points of intersection are $\left(\frac{1}{2}, 1 \right)$ and

$$\left(-\frac{1}{2}, 1 \right).$$

b The area of the pink region is

$$\int_0^{\frac{1}{2}} 4x^2 dx + \int_{\frac{1}{2}}^2 \frac{1}{4} x^{-2} dx$$

$$= \left[\frac{4}{3} x^3 \right]_0^{\frac{1}{2}} + \left[-\frac{1}{4} x^{-1} \right]_{\frac{1}{2}}^2$$

$$= \left[\frac{4}{3} x^3 \right]_0^{\frac{1}{2}} - \left[\frac{1}{4x} \right]_{\frac{1}{2}}^2$$

$$= \left(\frac{4}{3} \left(\frac{1}{2} \right)^3 - 0 \right) - \left(\frac{1}{4(2)} - \frac{1}{4\left(\frac{1}{2}\right)} \right)$$

$$= \frac{4}{3} \times \frac{1}{8} - \frac{1}{8} + \frac{1}{2}$$

$$= \frac{1}{6} - \frac{1}{8} + \frac{1}{2}$$

$$= \frac{4}{24} - \frac{3}{24} + \frac{12}{24}$$

$$= \frac{13}{24} \text{ units}^2$$

c The area of the blue region is

$$\begin{aligned} & \int_{-1}^{-\frac{1}{2}} \left(4x^2 - \frac{1}{4x^2} \right) dx \\ &= \int_{-1}^{-\frac{1}{2}} \left(4x^2 - \frac{x^{-2}}{4} \right) dx \\ &= \left[\frac{4}{3}x^3 + \frac{1}{4x} \right]_{-1}^{-\frac{1}{2}} \\ &= \left(\frac{4}{3} \left(-\frac{1}{2} \right)^3 + \frac{1}{4 \left(-\frac{1}{2} \right)} \right) - \left(\frac{4}{3}(-1)^3 + \frac{1}{4(-1)} \right) \\ &= \frac{4}{3} \times \frac{-1}{8} - \frac{1}{2} + \frac{4}{3} + \frac{1}{4} \\ &= \frac{-1}{6} - \frac{1}{2} + \frac{4}{3} + \frac{1}{4} \\ &= \frac{-2}{12} - \frac{6}{12} + \frac{16}{12} + \frac{3}{12} \\ &= \frac{11}{12} \text{ units}^2 \end{aligned}$$

6 a To find the point(s) of intersection, let $f(x) = g(x)$.

$$\begin{aligned} x^3 - 3x + 2 &= x + 2 \\ x^3 - 4x &= 0 \\ x(x^2 - 4) &= 0 \\ x(x+2)(x-2) &= 0 \\ x &= -2, 0, 2 \end{aligned}$$

$$\begin{aligned} g(0) &= 0 + 2 \\ &= 2 \\ &\Rightarrow (0, 2) \end{aligned}$$

$$\begin{aligned} g(-2) &= -2 + 2 \\ &= 0 \\ &\Rightarrow (-2, 0) \end{aligned}$$

$$\begin{aligned} g(2) &= 2 + 2 \\ &= 4 \\ &\Rightarrow (2, 4) \end{aligned}$$

b $f(x) = x^3 - 3x + 2$
 $f(1) = 1 - 3(1) + 2$
 $= 3 - 3$
 $= 0$

Therefore, $x - 1$ is a factor.

$$\begin{aligned} x^3 - 3x + 2 &= x^3 - x^2 + x^2 - x - 2x + 2 \\ &= x^2(x-1) + x(x-1) - 2(x-1) \\ &= (x-1)(x^2 + x - 2) \\ &= (x-1)(x+2)(x-1) \\ &= (x-1)^2(x+2) \end{aligned}$$

$$\begin{aligned} f(x) &= x^3 - 3x + 2 \\ &= (x-1)^2(x+2) \end{aligned}$$

x int \Rightarrow
 $0 = (x-1)^2(x+2)$
 $x = -2, x = 1$
 $\Rightarrow (-2, 0), (1, 0)$

y int \Rightarrow
 $y = 0 - 3(0) + 2$

$$\begin{aligned} &= 2 \\ &\Rightarrow (0, 2) \\ g(x) &= x + 2 \\ \text{x int } &\Rightarrow \\ 0 &= x + 2 \\ x &= -2 \\ &\Rightarrow (-2, 0) \\ \text{y int } &\Rightarrow \\ y &= 2 \\ &\Rightarrow (0, 2) \end{aligned}$$

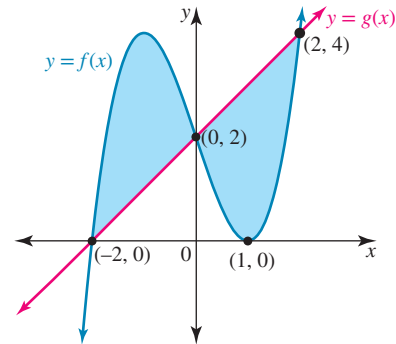

c

$$\begin{aligned} A &= \int_{-2}^0 (x^3 - 3x + 2 - (x + 2)) dx + \int_0^2 (x + 2) - (x^3 - 3x + 2) dx \\ &= \int_{-2}^0 (x^3 - 4x) dx + \int_0^2 (4x - x^3) dx \\ &= \int_{-2}^0 (x^3 - 4x) dx + \int_0^2 (4x - x^3) dx \\ &= \left[\frac{x^4}{4} - \frac{4x^2}{2} \right]_{-2}^0 + \left[\frac{4x^2}{2} - \frac{x^4}{4} \right]_0^2 \\ &= \left[\frac{x^4}{4} - 2x^2 \right]_{-2}^0 + \left[2x^2 - \frac{x^4}{4} \right]_0^2 \\ &= \frac{(0)^2}{4} - 2(0)^2 - \left(\frac{(-2)^4}{4} - 2(-2)^2 \right) \\ &\quad + \left(2(2)^2 - \frac{2^4}{4} - \left(2(0)^2 - \frac{(0)^4}{4} \right) \right) \\ &= -(4 - 8) + (8 - 4) \\ &= 4 + 4 \\ &= 8 \text{ units}^2 \end{aligned}$$

Technology active: multiple choice

7 $A = \frac{1}{2} (f(-3) + f(-2)) \times 1 + \frac{1}{2} (f(-2) + f(-1)) \times 1$
 $+ \frac{1}{2} (f(-1) + f(0)) \times 1$
 $= \frac{1}{2} (e^3 + e^2) + \frac{1}{2} (e^2 + e^1) + \frac{1}{2} (e^1 + 1)$
 $= \frac{1}{2} e^3 + \frac{1}{2} e^2 + \frac{1}{2} e^2 + \frac{1}{2} e^1 + \frac{1}{2} e^1 + \frac{1}{2}$
 $= \frac{1}{2} e^3 + e^2 + e^1 + \frac{1}{2} \text{ units}^2$

The correct answer is B.

$$\begin{aligned}
 8 \quad A &= \frac{1}{2} (f(0) + f(1)) \times 1 + \frac{1}{2} (f(1) + f(2)) \times 1 \\
 &\quad + \frac{1}{2} (f(2) + f(3)) \times 1 + \frac{1}{2} (f(3) + f(4)) \times 1 \\
 &= \frac{1}{2} (4 + 3) + \frac{1}{2} (3 + 6) + \frac{1}{2} (6 + 7) + \frac{1}{2} (7 + 0) \\
 &= 3.5 + 4.5 + 6.5 + 3.5 \\
 &= 18 \text{ units}^2
 \end{aligned}$$

The correct answer is **D**.

$$\begin{aligned}
 9 \quad &\int_{-\frac{\pi}{2}}^{\frac{\pi}{3}} \left(\cos\left(\frac{x}{2}\right) - \sin(2x) \right) dx \\
 &= \left[2 \sin\left(\frac{x}{2}\right) + \frac{1}{2} \cos(2x) \right]_{-\frac{\pi}{2}}^{\frac{\pi}{3}} \\
 &= 2 \sin\left(\frac{1}{2} \times \frac{\pi}{3}\right) + \frac{1}{2} \cos\left(2 \times \frac{\pi}{3}\right) \\
 &\quad - \left(2 \sin\left(\frac{1}{2} \times \frac{-\pi}{2}\right) + \frac{1}{2} \cos\left(2 \times \frac{-\pi}{2}\right) \right) \\
 &= 2 \sin\left(\frac{\pi}{6}\right) + \frac{1}{2} \cos\left(\frac{2\pi}{3}\right) \\
 &\quad - \left(2 \sin\left(\frac{-\pi}{4}\right) + \frac{1}{2} \cos(-\pi) \right) \\
 &= 2 \times \frac{1}{2} + \frac{1}{2} \times -\frac{1}{2} - \left(2 \times -\frac{\sqrt{2}}{2} + \frac{1}{2} \times -1 \right) \\
 &= 1 - \frac{1}{4} - \left(-\sqrt{2} - \frac{1}{2} \right) \\
 &= \frac{3}{4} + \sqrt{2} + \frac{1}{2} \\
 &= \sqrt{2} + \frac{5}{4}
 \end{aligned}$$

The correct answer is **A**.

$$\begin{aligned}
 10 \quad A &= \frac{1}{2} (f(0.5) + f(1.5)) \times 1 + \frac{1}{2} (f(1.5) + f(2.5)) \times 1 \\
 &\quad + \frac{1}{2} (f(2.5) + f(3.5)) \times 1 \\
 &= \frac{1}{2} (0 + 1) + \frac{1}{2} (1 + \sqrt{2}) + \frac{1}{2} (\sqrt{2} + \sqrt{3}) \\
 &= 3.3 \text{ units}^2
 \end{aligned}$$

The correct answer is **C**.

11 Since $y = f(x)$ is always above $y = g(x)$ over the domain of the shaded region:

$$\text{Area of shaded region} = \int_a^n (f(x) - g(x)) dx$$

The correct answer is **B**.

$$\begin{aligned}
 12 \quad &\int_0^3 k(x^2 + 2) dx = 5 \\
 &k \int_0^3 (x^2 + 2) dx = 5 \\
 &k \left[\frac{x^3}{3} + 2x \right]_0^3 = 5
 \end{aligned}$$

$$\begin{aligned}
 k \left(\left(\frac{(3)^3}{3} + 2(3) \right) - 0 \right) &= 5 \\
 k(9 + 6) &= 5 \\
 15k &= 5 \\
 k &= \frac{5}{15} \\
 k &= \frac{1}{3}
 \end{aligned}$$

The correct answer is **D**.

$$\begin{aligned}
 13 \quad V &= \int_0^2 3e^{-0.2t} dt \\
 &= \left[-15e^{-0.2t} \right]_0^2 \\
 &= (-15e^{-0.2(2)}) - (-15e^0) \\
 &= -15e^{-0.4} + 15 \\
 &= 4.95 \text{ L}
 \end{aligned}$$

The correct answer is **E**.

$$\begin{aligned}
 14 \quad v &= t^2 - t - 2 \\
 x &= \int t^2 - t - 2 dt \\
 x &= \frac{t^3}{3} - \frac{t^2}{2} - 2t + c \\
 \text{When } t = 0, x = 0, \text{ so } c &= 0 \\
 x &= \frac{t^3}{3} - \frac{t^2}{2} - 2t \\
 \text{After 3 seconds, } t = 3. \\
 x &= \frac{(3)^3}{3} - \frac{(3)^2}{2} - 2(3) \\
 &= 9 - \frac{9}{2} - 6 \\
 &= -1.5 \text{ metres}
 \end{aligned}$$

The correct answer is **E**.

$$15 \quad v = t^2 - t - 2 = (t - 2)(t + 1) \quad t \geq 0$$

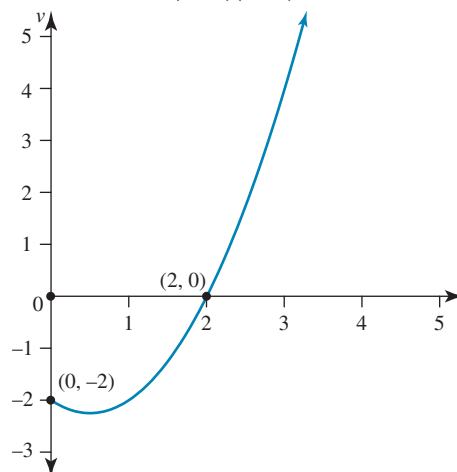

$$\begin{aligned}
 \text{Distance} &= -\int_0^2 (t^2 - t - 2) dt \\
 &= -\left[\frac{1}{3}t^3 - \frac{1}{2}t^2 - 2t\right]_0^2 \\
 &= -\left(\frac{1}{3}(2)^3 - \frac{1}{2}(2)^2 - 2(2) - 0\right) \\
 &= -\left(\frac{8}{3} - 2 - 4\right) \\
 &= 3\frac{1}{3} \text{ m}
 \end{aligned}$$

The correct answer is **D**.

$$\begin{aligned}
 16 \quad k &= \int_1^3 \frac{1}{x} dx \\
 k &= [\log_e(x)]_1^3 \\
 k &= \log_e(3) - \log_e(1) \\
 k &= \log_e(3)
 \end{aligned}$$

$$\text{So } e^k = e^{\log_e(3)} = 3.$$

The correct answer is **C**.

Technology active: extended response

$$\begin{aligned}
 17 \quad a \quad A &= \frac{1}{2}(f(0) + f(0.5)) \times 0.5 + \frac{1}{2}(f(0.5) + f(1)) \times 0.5 \\
 &\quad + \frac{1}{2}(f(1) + f(1.5)) \times 0.5 + \frac{1}{2}(f(1.5) + f(2)) \times 0.5 \\
 &= \frac{1}{2}(3 + 3.25) \times 0.5 + \frac{1}{2}(3.25 + 4) \times 0.5 \\
 &\quad + \frac{1}{2}(4 + 5.25) \times 0.5 + \frac{1}{2}(5.25 + 7) \times 0.5 \\
 &= 8.75 \text{ units}^2
 \end{aligned}$$

$$\begin{aligned}
 b \quad A &= \int_0^2 (x^2 + 3) dx \\
 &= \left[\frac{x^3}{3} + 3x\right]_0^2 \\
 &= \frac{(2)^3}{3} + 3(2) - 0 \\
 &= \frac{8}{3} + 6 \\
 &= \frac{8}{3} + \frac{18}{3} \\
 &= \frac{26}{3} \text{ units}^2
 \end{aligned}$$

18 a Parabola:

$$y = ax^2$$

$$\text{When } x = 25, y = 25.$$

$$25 = a(25)^2$$

$$625a = 25$$

$$a = \frac{25}{625}$$

$$a = \frac{1}{25}$$

$$y = \frac{1}{25}x^2$$

$$\begin{aligned}
 b \quad A &= 2 \int_0^{25} \frac{1}{25}x^2 dx \\
 &= \frac{2}{25} \int_0^{25} x^2 dx \\
 &= \frac{2}{25} \left[\frac{x^3}{3}\right]_0^{25} \\
 &= \frac{2}{25} \left(\frac{25^3}{3} - 0\right) \\
 &= \frac{2 \times 25 \times 25^2}{25 \times 3} \\
 &= \frac{2 \times 25^2}{3} \\
 &= \frac{2 \times 625}{3} \\
 &= \frac{1250}{3} \text{ cm}^2
 \end{aligned}$$

$$\begin{aligned}
 c \quad V &= \frac{1250}{3} \times 120 \\
 &= 1250 \times 40 \\
 &= 50\,000 \text{ cm}^3
 \end{aligned}$$

$$19 \quad a \quad y = m \log_e(n(x+p))$$

The graph asymptotes to $x = -2$, so $p = 2$.

$$y = m \log_e(n(x+2))$$

$$\text{When } x = 0, y = 0.$$

$$0 = m \log_e(n(0+2))$$

$$0 = m \log_e(2n)$$

$$0 = \log_e(2n)$$

$$2n = e^0$$

$$2n = 1$$

$$n = \frac{1}{2}$$

$$y = m \log_e\left(\frac{1}{2}(x+2)\right)$$

$$\text{When } x = -1, y = 2 \log_e(2).$$

$$2 \log_e(2) = m \log_e\left(\frac{1}{2}(-1+2)\right)$$

$$2 \log_e(2) = m \log_e\left(\frac{1}{2}\right)$$

$$m \log_e(2^{-1}) = 2 \log_e(2)$$

$$-m \log_e(2) = 2 \log_e(2)$$

$$-m = 2$$

$$m = 2$$

$$\therefore m = -2, n = \frac{1}{2} \text{ and } p = 2$$

$$b \quad y = \log_e(x) \rightarrow y = -\log_e(x)$$

Reflected in the x -axis

$$y = -\log_e(x) \rightarrow y = -2 \log_e(x)$$

Dilated by a factor of 2 parallel to the y -axis

$$y = -2 \log_e(x) \rightarrow y = -2 \log_e\left(\frac{1}{2}x\right)$$

Dilated by a factor of 2 parallel to the x -axis

$$y = -2 \log_e\left(\frac{1}{2}x\right) \rightarrow y = -2 \log_e\left(\frac{1}{2}(x+2)\right)$$

Translated 2 units to the left

c $f: y = -2 \log_e \left(\frac{1}{2}(x+2) \right)$ where $\text{dom} = (-2, \infty)$ and $\text{ran} = R$

To find $f^{-1}(x)$, swap x and y and rearrange for y .

$$x = -2 \log_e \left(\frac{1}{2}(y+2) \right)$$

$$-\frac{x}{2} = \log_e \left(\frac{1}{2}(y+2) \right)$$

$$\frac{1}{2}(y+2) = e^{-\frac{x}{2}}$$

$$y+2 = 2e^{-\frac{x}{2}}$$

$$y = 2e^{-\frac{x}{2}} - 2$$

$f^{-1}: y = 2e^{-\frac{x}{2}} - 2$ where $\text{dom} = R$ and $\text{ran} = (-2, \infty)$

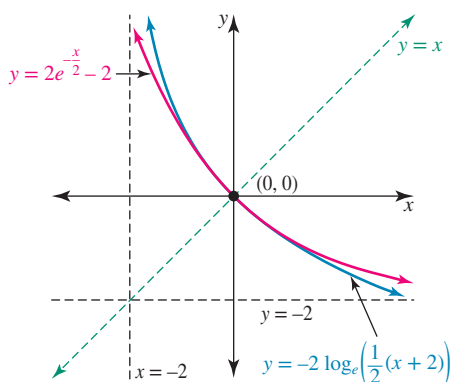

d Using CAS technology:

$$f(x) = x$$

$$-2 \log_e \left(\frac{1}{2}(x+2) \right) = x$$

$$x = 0$$

Therefore, there is a point of intersection at $(0, 0)$.

$$\begin{aligned} \text{e } A &= \int_{-1.5}^0 \left(-2 \log_e \left(\frac{1}{2}(x+2) \right) - 2e^{-\frac{x}{2}} + 2 \right) dx \\ &= 0.1457 \text{ units}^2 \end{aligned}$$

$$20 \text{ a } f(x) = e^{-\frac{x}{3}} (m \cos(x) + n \sin(x))$$

$$f'(x) = -\frac{1}{3} e^{-\frac{x}{3}} (m \cos(x) + n \sin(x))$$

$$+ e^{-\frac{x}{3}} (-m \sin(x) + n \cos(x))$$

$$f'(x) = -\frac{1}{3} e^{-\frac{x}{3}} m \cos(x) - \frac{1}{3} e^{-\frac{x}{3}} n \sin(x)$$

$$- e^{-\frac{x}{3}} m \sin(x) + e^{-\frac{x}{3}} n \cos(x)$$

$$f'(x) = \left(n - \frac{1}{3} m \right) e^{-\frac{x}{3}} \cos(x) + \left(-\frac{1}{3} n - m \right) e^{-\frac{x}{3}} \sin(x)$$

Given that $f'(x) = e^{-\frac{x}{3}} \sin(x)$, equating coefficients, we have:

$$n - \frac{1}{3} m = 0 \quad [1]$$

$$-\frac{1}{3} n - m = 1 \quad [2]$$

From [1]:

$$n = \frac{1}{3} m \quad [3]$$

From [2]:

$$\begin{aligned} -n - 3m &= 3 \\ n + 3m &= -3 \quad [4] \end{aligned}$$

Substitute [3] into [4]:

$$\frac{1}{3} m + 3m = -3$$

$$m + 9m = -9$$

$$10m = -9$$

$$m = -\frac{9}{10}$$

So

$$n = -\frac{9}{10} \times \frac{1}{3}$$

$$= -\frac{3}{10}$$

Thus, $f(x) = e^{-\frac{x}{3}} \left(-\frac{9}{10} \cos(x) - \frac{3}{10} \sin(x) \right)$.

$$\begin{aligned} \text{b } \int_0^{2\pi} \left(e^{-\frac{x}{3}} \sin(x) \right) dx &= \left[e^{-\frac{x}{3}} \left(-\frac{9}{10} \cos(x) - \frac{3}{10} \sin(x) \right) \right]_0^{2\pi} \\ &= \left(e^{-\frac{2\pi}{3}} \left(-\frac{9}{10} \cos(2\pi) - \frac{3}{10} \sin(2\pi) \right) \right) \\ &\quad - \left(e^0 \left(-\frac{9}{10} \cos(0) - \frac{3}{10} \sin(0) \right) \right) \\ &= e^{-\frac{2\pi}{3}} \left(-\frac{9}{10} - 0 \right) + \frac{9}{10} \\ &= -\frac{9}{10} e^{-\frac{2\pi}{3}} + \frac{9}{10} \\ &= \frac{9}{10} \left(1 - e^{-\frac{2\pi}{3}} \right) \end{aligned}$$

c First find the x -intercepts:

$$0 = e^{-\frac{x}{3}} \sin(x)$$

$$\sin(x) = 0, \quad e^{-\frac{x}{3}} > 0$$

The first three x -intercepts are $x = 0, \pi, 2\pi$.

Area of the shaded region

$$\begin{aligned} &= \int_0^{\pi} \left(e^{-\frac{x}{3}} \sin(x) \right) dx - \int_{\pi}^{2\pi} \left(e^{-\frac{x}{3}} \sin(x) \right) dx \\ &= \left[e^{-\frac{x}{3}} \left(-\frac{9}{10} \cos(x) - \frac{3}{10} \sin(x) \right) \right]_0^{\pi} \\ &\quad - \left[e^{-\frac{x}{3}} \left(-\frac{9}{10} \cos(x) - \frac{3}{10} \sin(x) \right) \right]_{\pi}^{2\pi} \\ &= \left(e^{-\frac{\pi}{3}} \left(-\frac{9}{10} \cos(\pi) - \frac{3}{10} \sin(\pi) \right) \right) \\ &\quad - \left(e^0 \left(-\frac{9}{10} \cos(0) - \frac{3}{10} \sin(0) \right) \right) \\ &\quad - \left[\left(e^{-\frac{x}{3}} \left(-\frac{9}{10} \cos(2\pi) - \frac{3}{10} \sin(2\pi) \right) \right) \right. \\ &\quad \left. - \left(e^{-\frac{2\pi}{3}} \left(-\frac{9}{10} \cos(\pi) - \frac{3}{10} \sin(\pi) \right) \right) \right] \\ &= 1.6425 \text{ units}^2 \end{aligned}$$

8.6 Exam questions

$$1 \quad 3 \int_0^a f(x) dx + \int_0^a 2 dx = 3k + 2a$$

The correct answer is A.

$$2 \quad a \quad y = x \log_e(3x) \text{ using product rule}$$

$$\frac{dy}{dx} = \log_e(3x) \frac{d}{dx}(x) + x \frac{d}{dx}(\log_e(3x))$$

$$\frac{dy}{dx} = \log_e(3x) + x \times \frac{1}{x}$$

$$\frac{dy}{dx} = \log_e(3x) + 1$$

Award 1 mark for using the product rule.

Award 1 mark for the correct result.

VCAA Examination Report note:

Most students used the product rule; however, many erred with the derivative of $\log_e(3x)$

Common incorrect answers were

$$\log_e(3x) + 3 \text{ and } \log_e(3x) + \frac{1}{3}.$$

$$b \quad \int_1^{-2} (\log_e(3x) + 1) dx$$

$$= [x \log_e(3x)]_1^{-2}$$

$$= (2 \log_e(6) - \log_e(3))$$

$$= \log_e(36) - \log_e(3)$$

$$= \log_e(12)$$

Award 1 mark for the correct integration by recognition.

Award 1 mark for the correct result.

VCAA Examination Report note:

Students generally were not able to form an integral from their previous answer, ignoring the 'hence' instruction.

Some students attempted to integrate the given expression.

Some poor application of log laws and/or log notation was observed.

$$3 \quad a \quad f: \mathbb{R} \setminus \{1\} \rightarrow \mathbb{R}, f(x) = 2 + \frac{3}{x-1}$$

$$\text{Crosses the } x\text{-axis at } y = 0 \Rightarrow f(0) = 2 - 3 = -1 \quad (0, -1)$$

Crosses the y-axis at

$$y = 0 \Rightarrow x - 1 = -\frac{3}{2} \Rightarrow x = -\frac{1}{2} \quad \left(-\frac{1}{2}, 0\right)$$

$x = 1$ is the vertical asymptote; $y = 2$ is a horizontal asymptote.

Award 1 mark for the correct shape.

Award 1 mark for the correct axial intercepts.

Award 1 mark for both correct asymptotes.

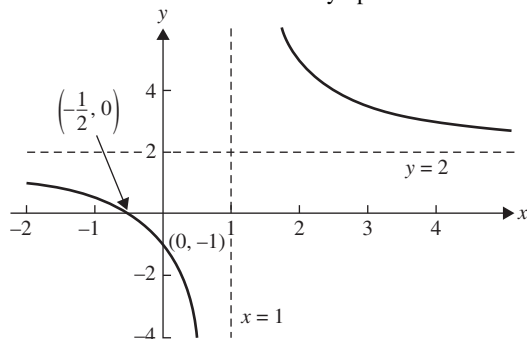

VCAA Assessment Report note:

Some well-constructed graphs were presented by students.

The highest-scoring graphs were clearly labelled with the correct points/equations, as specified by the question, and with care taken in showing the asymptotic behaviour nature of the curve as it approached an asymptote. Using a dashed line to represent an asymptote indicated that the curve was distinct from its asymptote.

$$b \quad A = \int_2^4 \left(2 + \frac{3}{x-1}\right)$$

$$A = [2x + 3 \log_e(x-1)]_2^4$$

$$= (8 + 3 \log_e(3)) - (4 + \log_e(1))$$

$$= 4 + 3 \log_e(3) = 4 + \log_e(27)$$

Award 1 mark for correct integration.

Award 1 mark for the correct area value.

VCAA Assessment Report note:

Students were able to identify the required integral;

however, many then erred in the evaluation of the terminals. A common error occurring as a result of incorrectly applying logarithmic laws was a final answer of $4 + \log_e(9)$. Many students were unable to recognise that the antiderivative of the reciprocal of $(x-1)$ involved a logarithmic function. The 'dx' was often omitted.

$$4 \quad \int_1^2 (f(x) + x) dx = \int_1^2 f(x) dx + \left[\frac{1}{2}x^2\right]_1^2$$

$$= \int_1^4 f(x) dx - \int_2^4 f(x) dx + \left(2 - \frac{1}{2}\right)$$

$$= \int_1^4 f(x) dx - \int_2^4 f(x) dx + \frac{3}{2}$$

$$= 4 + 2 + \frac{3}{2} = \frac{15}{2}$$

The correct answer is E.

5 Graph C is the only graph that has an average value of 2 over $[0, 6]$; that is, if a line $y = 2$ is drawn, the area bound by the graph and the line is equal above and below the line.

$$\text{That is, } \frac{1}{6-0} \int_0^6 h(x) dx = 2.$$

The correct answer is C.

Topic 9 — Discrete random variables

9.2 Probability review

9.2 Exercise

1 B = blue disc, R = red disc, G = green disc

a $\Pr(B) = \frac{4}{22} = \frac{2}{11}$

b $\Pr(R') = \frac{14}{22} = \frac{7}{11}$

c $\Pr(G \text{ or } R) = \frac{18}{22} = \frac{9}{11}$

2 a $\Pr(\text{multiple of } 4) = \frac{5}{20} = \frac{1}{4}$

b $\Pr(\text{less than } 16) = \frac{15}{20} = \frac{3}{4}$

c $\Pr(\text{greater than } 5, \text{ no more than } 12) = \frac{7}{20}$

3 B = blue counters, R = red counters, G = green counters

a $\Pr(3B) = \frac{4}{20} \times \frac{4}{20} \times \frac{4}{20}$
 $= \frac{1}{5} \times \frac{1}{5} \times \frac{1}{5}$
 $= \frac{1}{125}$

b $\Pr(B \text{ then } G \text{ then } R) = \frac{4}{20} \times \frac{6}{20} \times \frac{10}{20}$
 $= \frac{1}{5} \times \frac{3}{10} \times \frac{1}{2}$
 $= \frac{3}{100}$

c $\Pr(B, G, R) = \left(\frac{4}{20} \times \frac{6}{20} \times \frac{10}{20}\right) \times 6$
 $= \frac{1}{5} \times \frac{3}{10} \times \frac{1}{2} \times 6$
 $= \frac{9}{50}$

4 a ξ

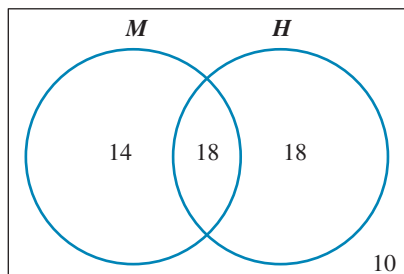

First add 18 to the overlapping region, then place 10 outside the circles. The remaining number in the Maths circle is obtained by subtracting 18 from 32 (the total who study Maths) to give 14. The number of people who just study History is obtained by $60 - 14 - 18 - 10 = 18$.

Always check the total of the numbers added to give you the overall total, which in this case is 60 students.

b i $\Pr(H) = \frac{36}{60} = \frac{3}{5}$

ii $\Pr(H \cap M) = \frac{18}{60} = \frac{3}{10}$

iii $\Pr(M|H) = \frac{n(M \cap H)}{n(H)}$
 $= \frac{18}{36}$
 $= \frac{1}{2}$

5 a $\Pr(A \cup B) = \Pr(A) + \Pr(B) - \Pr(A \cap B)$
 $= 0.35 + 0.48 - 0.15$
 $= 0.68$

b $\Pr(A|B) = \frac{\Pr(A \cap B)}{\Pr(B)}$
 $= \frac{0.15}{0.48}$
 $= \frac{15}{48}$
 $= \frac{5}{16}$

c $\Pr(A'|B) = \frac{\Pr(A' \cap B)}{\Pr(B)}$

ξ

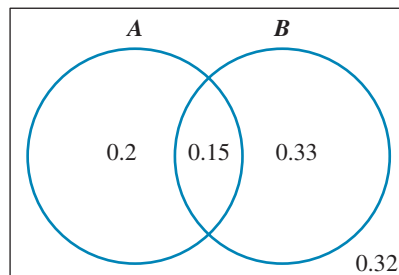

Therefore, $\Pr(A' \cap B) = 0.33$.

$$\Pr(A'|B) = \frac{\Pr(A' \cap B)}{\Pr(B)}$$

$$= \frac{0.33}{0.48}$$

$$= \frac{33}{48}$$

$$= \frac{11}{16}$$

6 a $\Pr(A|B) = \frac{\Pr(A \cap B)}{\Pr(B)}$
 $0.64 = \frac{\Pr(A \cap B)}{0.5}$

$$\Pr(A \cap B) = 0.64 \times 0.5$$

$$= 0.32$$

b $\Pr(A \cup B) = \Pr(A) + \Pr(B) - \Pr(A \cap B)$
 $= 0.7 + 0.5 - 0.32$
 $= 0.88$

c $\Pr(B|A) = \frac{\Pr(A \cap B)}{\Pr(A)}$
 $= \frac{0.32}{0.7}$
 $= \frac{32}{70}$
 $= \frac{16}{35}$

7 a $\Pr(RR) = 0.7 \times 0.7$
 $= 0.49$

$$\begin{aligned} \text{b } \Pr(R \text{ tomorrow} | S \text{ in 2 days}) &= \frac{\Pr(R \text{ tomorrow} \cap S \text{ in 2 days})}{\Pr(S \text{ in 2 days})} \\ &= \frac{\Pr(RS)}{\Pr(RS) + \Pr(SS)} \\ &= \frac{0.7 \times 0.3}{0.7 \times 0.3 + 0.3 \times 0.5} \\ &= \frac{0.21}{0.21 + 0.15} \\ &= \frac{0.21}{0.36} \\ &= \frac{21}{36} \\ &= \frac{7}{12} \end{aligned}$$

$$\begin{aligned} \text{8 a } \Pr(2B) &= \frac{4}{10} \times \frac{3}{9} \\ &= \frac{2}{15} \end{aligned}$$

$$\begin{aligned} \text{b } \Pr(B, W) &= \Pr(BW) + \Pr(WB) \\ &= \frac{4}{10} \times \frac{6}{9} + \frac{6}{10} \times \frac{4}{9} \\ &= \frac{4}{15} + \frac{4}{15} \\ &= \frac{8}{15} \end{aligned}$$

$$\begin{aligned} \text{9 a } \Pr(A \cup B) &= \Pr(A) + \Pr(B) - \Pr(A \cap B) \\ 0.75 &= 0.5 + 0.36 - \Pr(A \cap B) \\ \Pr(A \cap B) &= 0.11 \end{aligned}$$

As $\Pr(A \cap B) \neq 0$, the events A and B are not mutually exclusive.

$$\begin{aligned} \text{b } \text{If } A \text{ and } B \text{ are independent, then } \Pr(A \cap B) &= \Pr(A) \times \Pr(B) \\ \Pr(A) \times \Pr(B) &= 0.5 \times 0.36 \\ &= 0.18 \end{aligned}$$

$$\Pr(A \cap B) = 0.11 \neq \Pr(A) \times \Pr(B)$$

Therefore, events A and B are not independent.

$$\text{10 } \Pr(M) = \frac{2}{6} = \frac{1}{3}, \Pr(N) = \frac{1}{6}$$

A table can be used to find $\Pr(M \cap N)$.

Event M = blue shading

Event N = yellow shading

Therefore, $M \cap N$ = green shading.

		First die					
		1	2	3	4	5	6
Second die	1	(1, 1)	(2, 1)	(3, 1)	(4, 1)	(5, 1)	(6, 1)
	2	(1, 2)	(2, 2)	(3, 2)	(4, 2)	(5, 2)	(6, 2)
	3	(1, 3)	(2, 3)	(3, 3)	(4, 3)	(5, 3)	(6, 3)
	4	(1, 4)	(2, 4)	(3, 4)	(4, 4)	(5, 4)	(6, 4)
	5	(1, 5)	(2, 5)	(3, 5)	(4, 5)	(5, 5)	(6, 5)
	6	(1, 6)	(2, 6)	(3, 6)	(4, 6)	(5, 6)	(6, 6)

$$\text{a } \Pr(M \cap N) = \frac{2}{36} = \frac{1}{18}$$

As $\Pr(M \cap N) \neq 0$, the events M and N are not mutually exclusive.

$$\begin{aligned} \text{b } \text{If } M \text{ and } N \text{ are independent, then} \\ \Pr(M \cap N) &= \Pr(M) \times \Pr(N). \end{aligned}$$

$$\begin{aligned} \Pr(M) \times \Pr(N) &= \frac{1}{3} \times \frac{1}{6} \\ &= \frac{1}{18} \\ &= \Pr(M \cap N) \end{aligned}$$

Therefore, events M and N are independent.

$$\text{11 a } \text{If } A \text{ and } B \text{ are mutually exclusive, then } \Pr(A \cap B) = 0.$$

$$\begin{aligned} \Pr(A|B) &= \frac{\Pr(A \cap B)}{\Pr(B)} \\ &= \frac{0}{0.6} \\ &= 0 \end{aligned}$$

$$\text{b } \text{If } A \text{ and } B \text{ are independent, then } \Pr(A \cap B) = \Pr(A) \times \Pr(B).$$

$$\begin{aligned} \Pr(A|B) &= \frac{\Pr(A) \times \Pr(B)}{\Pr(B)} \\ &= \Pr(A) \\ &= 0.44 \end{aligned}$$

$$\text{12 } \Pr(M \cap N) = 0.18, \Pr(N) = k, \Pr(M') = 0.7 - k$$

$$\begin{aligned} \Pr(M) &= 1 - (0.7 - k) \\ &= 0.3 + k \end{aligned}$$

As M and N are independent events,

$$\Pr(M \cap N) = \Pr(M) \times \Pr(N).$$

$$\Pr(M \cap N) = \Pr(M) \times \Pr(N)$$

$$0.18 = (0.3 + k) \times k$$

$$0.18 = 0.3k + k^2$$

$$0 = k^2 + 0.3k - 0.18$$

$$0 = (k + 0.6)(k - 0.3)$$

$$k = -0.6, 0.3$$

$$\therefore k = 0.3 (0 \leq k \leq 1)$$

9.2 Exam questions

$$\text{1 a } \text{Model X, } O = \text{oil change, } F = \text{filter change}$$

$$\Pr(O) = \frac{17}{20}, \Pr(F) = \frac{3}{20} \text{ and } \Pr(F \cap O) = \frac{1}{20}$$

	O	O'	
F	$\frac{1}{20}$	$\frac{2}{20}$	$\frac{3}{20}$
F'	$\frac{16}{20}$	$\frac{1}{20}$	$\frac{17}{20}$
	$\frac{17}{20}$	$\frac{3}{20}$	

$$\Pr(F \cap O') = \frac{1}{10} \text{ [1 mark]}$$

$$\text{b } \text{Model Y, } \Pr(O) = \frac{m}{m+n}, \Pr(F) = \frac{n}{m+n} \text{ and}$$

$$\Pr(F \cap O) = \frac{1}{m+n}$$

	O	O'	
F	$\frac{1}{m+n}$	$\frac{n-1}{m+n}$	$\frac{n}{m+n}$
F'	$\frac{m-1}{m+n}$		
	$\frac{m}{m+n}$		

$$\Pr(F \cap O') = \frac{n-1}{m+n} = 0.05 = \frac{1}{20}$$

$$20(n-1) = 20n - 20 = m + n$$

$$m = 19n - 20$$

Award 1 mark for the correct Karnaugh map (table).

Award 1 mark for the correct answer.

- 2 There are k red marbles, $n - k$ green marbles, a total of n

$$\begin{aligned} \Pr(RR) + \Pr(GG) &= \frac{k}{n} \times \frac{k-1}{n-1} + \frac{n-k}{n} \times \frac{n-k-1}{n-1} \\ &= \frac{k(k-1) + (n-k)(n-k-1)}{n(n-1)} \end{aligned}$$

The correct answer is **D**.

- 3 $\Pr(A) = a = ?$ and $\Pr(B) = 2\Pr(A)$; $\Pr(A \cup B) = 0.52$

$$\Pr(A \cup B) = \Pr(A) + \Pr(B) - \Pr(A \cap B)$$

A and B are independent, so $\Pr(A \cap B) = \Pr(A)\Pr(B)$.

$$\Pr(A \cup B) = \Pr(A) + \Pr(B) - \Pr(A)\Pr(B)$$

$$0.52 = \Pr(A) + 2\Pr(A) - 2(\Pr(A))^2$$

$$0.52 = 3a - 2a^2$$

$$2a^2 - 3a + 0.52 = 0$$

$$a = \Pr(A) = 0.2 \quad 0 < a < 1$$

The correct answer is **B**.

9.3 Discrete random variables

9.3 Exercise

1 a

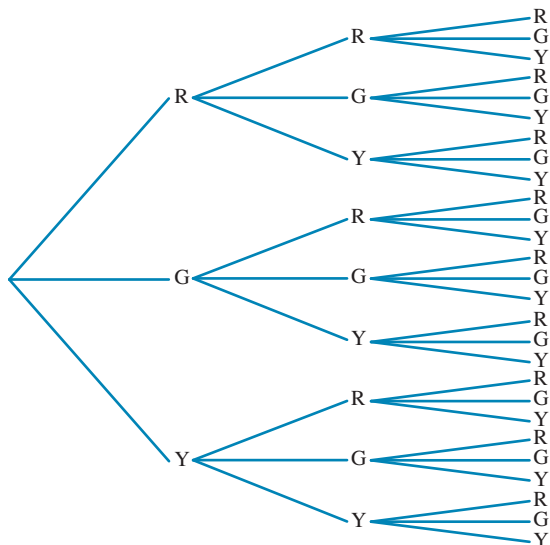

$$\begin{aligned} \xi = \{ &RRR, RRG, RRY, RGR, RGG, RGY, RYR, RYG, \\ & RYY, GRR, GRG, GRY, GGR, GGG, GGY, GYR, \\ & GYG, GYY, YRR, YRG, YRY, YGR, YGG, \\ & YGY, YYR, YYG, YYY \} \end{aligned}$$

- b Y is the number of green balls obtained.

$$Y = \{0, 1, 2, 3\}$$

$$\Pr(Y = 3) = \Pr(GGG) = \frac{3}{10} \times \frac{3}{10} \times \frac{3}{10} = \frac{27}{1000}$$

$$\begin{aligned} \Pr(Y = 2) &= \Pr(RGG) + \Pr(GRG) + \Pr(GGR) \\ &\quad + \Pr(GGY) + \Pr(GYG) + \Pr(YGG) \end{aligned}$$

$$\begin{aligned} \Pr(Y = 2) &= \frac{3}{10} \times \frac{3}{10} \times \frac{3}{10} + \frac{3}{10} \times \frac{3}{10} \times \frac{3}{10} + \frac{3}{10} \times \frac{3}{10} \\ &\quad \times \frac{3}{10} + \frac{3}{10} \times \frac{3}{10} \times \frac{4}{10} + \frac{3}{10} \times \frac{3}{10} \times \frac{3}{10} + \frac{4}{10} \\ &\quad \times \frac{3}{10} \times \frac{3}{10} \end{aligned}$$

$$\Pr(Y = 2) = \frac{27}{1000} \times 3 + \frac{36}{1000} \times 3 = \frac{189}{1000}$$

$$\begin{aligned} \Pr(Y = 1) &= \Pr(RRG) + \Pr(RGR) + \Pr(RYG) + \Pr(GRR) \\ &\quad + \Pr(GRY) + \Pr(GYR) + \Pr(GYY) + \Pr(YRG) \\ &\quad + \Pr(YGR) + \Pr(YGY) + \Pr(YYG) \end{aligned}$$

$$\begin{aligned} \Pr(Y = 1) &= \frac{3}{10} \times \frac{3}{10} \times \frac{3}{10} + \frac{3}{10} \times \frac{3}{10} \times \frac{4}{10} + \frac{3}{10} \times \frac{4}{10} \\ &\quad + \frac{3}{10} \times \frac{4}{10} \times \frac{3}{10} + \frac{3}{10} \times \frac{3}{10} \times \frac{3}{10} + \frac{3}{10} \times \frac{3}{10} \\ &\quad \times \frac{4}{10} + \frac{3}{10} \times \frac{4}{10} \times \frac{3}{10} + \frac{3}{10} \times \frac{4}{10} \times \frac{4}{10} \\ &\quad + \frac{4}{10} \times \frac{3}{10} \times \frac{3}{10} + \frac{4}{10} \times \frac{3}{10} \times \frac{3}{10} + \frac{4}{10} \times \frac{3}{10} \\ &\quad \times \frac{4}{10} + \frac{4}{10} \times \frac{4}{10} \times \frac{3}{10} \end{aligned}$$

$$\Pr(Y = 1) = \frac{27}{1000} \times 3 + \frac{36}{1000} \times 6 + \frac{48}{1000} \times 3$$

$$\Pr(Y = 1) = \frac{441}{1000}$$

$$\Pr(Y = 0) = 1 - (\Pr(Y = 1) + \Pr(Y = 2) + \Pr(Y = 3))$$

$$\Pr(Y = 0) = 1 - \left(\frac{441}{1000} + \frac{189}{1000} + \frac{27}{1000} \right)$$

$$\Pr(Y = 0) = \frac{1000}{1000} - \frac{657}{10000} = \frac{343}{1000}$$

c

y	0	1	2	3
$\Pr(Y = y)$	$\frac{343}{1000}$	$\frac{441}{1000}$	$\frac{189}{1000}$	$\frac{27}{1000}$

- 2 Let X be the number of sixes obtained.

$$\xi = \{11, 12, 13, 14, 15, 16$$

$$21, 22, 23, 24, 25, 26$$

$$31, 32, 33, 34, 35, 36$$

$$41, 42, 43, 44, 45, 46$$

$$51, 52, 53, 54, 55, 56$$

$$61, 62, 63, 64, 65, 66\}$$

$$X = 0, 1, 2$$

$$\Pr(X = 2) = \Pr(66) = \frac{1}{6} \times \frac{1}{6} = \frac{1}{36}$$

$$\Pr(X = 1) = \Pr(61, 62, 63, 64, 65, 16, 26, 36, 46, 56)$$

$$\Pr(X = 1) = 10 \times \frac{1}{6} \times \frac{1}{6} = \frac{10}{36}$$

$$\Pr(X = 0) = 1 - (\Pr(X = 1) + \Pr(X = 2))$$

$$\Pr(X = 0) = 1 - \left(\frac{1}{36} + \frac{10}{36} \right) = \frac{36}{36} - \frac{11}{36} = \frac{25}{36}$$

x	0	1	2
$\Pr(X = x)$	$\frac{25}{36}$	$\frac{10}{36} = \frac{5}{18}$	$\frac{1}{36}$

- 3 a** $0 \leq \Pr(Y = y) \leq 1$ for all y and the sum of the probabilities is 1.

This is a discrete probability density function.

- b** $0 \leq \Pr(Y = y) \leq 1$ for all y and the sum of the probabilities is 1.

This is a discrete probability density function.

- 4 a** $0 \leq \Pr(Y = y) \leq 1$ for all y and the sum of the probabilities is 0.9.

This is not a discrete probability density function.

- b** Negative probabilities, so this is not a discrete probability density function.

- 5 a** $0 \leq \Pr(X = x) \leq 1$ for all x and

$$\sum_{\text{all } x} \Pr(X = x) = 0.1 + 0.5 + 0.5 + 0.1 = 1.2 \neq 1$$

This is not a discrete probability density function.

- b** Negative probabilities, so this is not a discrete probability density function.

- c** $0 \leq \Pr(Z = z) \leq 1$ for all z and $\sum_{\text{all } z} \Pr(Z = z)$
 $= 0.25 + 0.15 + 0.45 + 0.35 = 1.1$ so $\sum_{\text{all } z} \Pr(Z = z) \neq 1$.

This is not a discrete probability density function.

- d** $0 \leq \Pr(X = x) \leq 1$ for all x and $\sum_{\text{all } x} \Pr(X = x)$
 $= 0.1 + 0.25 + 0.3 + 0.25 + 0.1 = 1$

This is a discrete probability density function.

- 6 a** $p(x) = \frac{1}{7}(5 - x)$, $p(1) = \frac{1}{7}(5 - 1) = \frac{4}{7}$,

$$p(3) = \frac{1}{7}(5 - 3) = \frac{2}{7}, p(4) = \frac{1}{7}(5 - 4) = \frac{1}{7}$$

Each probability lies between 0 and 1. The sum of probabilities is 1, so this is a discrete probability function.

- b** $p(x) = \frac{x^2 - x}{40}$

$$p(-1) = \frac{(-1)^2 + 1}{40} = \frac{2}{40}, p(1) = \frac{1^2 - 1}{40} = 0$$

$$p(2) = \frac{2^2 - 2}{40} = \frac{2}{40}, p(3) = \frac{3^2 - 3}{40} = \frac{6}{40}$$

$$p(4) = \frac{4^2 - 4}{40} = \frac{12}{40}, p(5) = \frac{5^2 - 5}{40} = \frac{20}{40}$$

Each probability lies between 0 and 1. The sum of probabilities is greater than 1, so this is not a discrete probability function.

- c** $p(x) = \frac{1}{15}\sqrt{x}$

$$p(1) = \frac{1}{15}\sqrt{1} = \frac{1}{15}, p(4) = \frac{1}{15}\sqrt{4} = \frac{2}{15},$$

$$p(9) = \frac{1}{15}\sqrt{9} = \frac{3}{15}, p(16) = \frac{1}{15}\sqrt{16} = \frac{4}{15},$$

$$p(25) = \frac{1}{15}\sqrt{25} = \frac{5}{15}$$

Each probability lies between 0 and 1. The sum of probabilities is 1, so this is a discrete probability function.

- 7 a** $\sum_{\text{all } x} \Pr(X = x) = 1$

$$5k + 3k - 0.1 + 2k + k + 0.6 - 3k = 1$$

$$8k + 0.5 = 1$$

$$8k = 0.5$$

$$k = \frac{0.5}{8} = \frac{1}{16}$$

- b** $\sum_{\text{all } x} \Pr(X = x) = 1$

$$0.5k^2 + 0.5k + 0.25(k + 1) + 0.5 + 0.5k^2 = 1$$

$$k^2 + 0.75k + 0.75 = 1$$

$$k^2 + 0.75k + 0.25 = 0$$

$$100k^2 + 75k + 25 = 0$$

$$4k^2 + 3k - 1 = 0$$

$$(4k - 1)(k + 1) = 0$$

$$k = \frac{1}{4}, -1$$

$$k = \frac{1}{4}, \text{ as } k \geq 0$$

- 8 a** $\sum_{\text{all } x} \Pr(X = x) = 1$

$$3d + 0.5 - 3d + 2d + 0.4 - 2d + d - 0.05 = 1$$

$$d + 0.85 = 1$$

$$d = 0.15$$

- b** $\sum_{\text{all } y} \Pr(Y = y) = 1$

$$0.5k + 1.5k + 2k + 1.5k + 0.5k = 1$$

$$6k = 1$$

$$k = \frac{1}{6}$$

- c** $\sum_{\text{all } z} \Pr(Z = z) = 1$

$$\frac{1}{3} - a^2 + \frac{1}{3} - a^2 + \frac{1}{3} - a^2 + a = 1$$

$$1 + a - 3a^2 = 1$$

$$a - 3a^2 = 0$$

$$a(1 - 3a) = 0$$

$$1 - 3a = 0 \text{ as } a > 0$$

$$1 = 3a \text{ or } a = \frac{1}{3}$$

- 9** $p(x) = \frac{1}{a}(15 - 3x)$

$$p(1) = \frac{1}{a}(15 - 3 \cdot 1) = \frac{12}{a},$$

$$p(2) = \frac{1}{a}(15 - 3 \cdot 2) = \frac{9}{a},$$

$$p(3) = \frac{1}{a}(15 - 3 \cdot 3) = \frac{6}{a}$$

$$p(4) = \frac{1}{a}(15 - 3 \cdot 4) = \frac{3}{a},$$

$$p(5) = \frac{1}{a}(15 - 3 \cdot 5) = 0$$

$$\frac{12}{a} + \frac{9}{a} + \frac{6}{a} + \frac{3}{a} + 0 = 1$$

$$\frac{30}{a} = 1$$

$$a = 30$$

The correct answer is **E**.

- 10 a** $\xi = \{11, 12, 13, 14, 15, 16$

$21, 22, 23, 24, 25, 26$

$31, 32, 33, 34, 35, 36$

$41, 42, 43, 44, 45, 46$

$51, 52, 53, 54, 55, 56$

$61, 62, 63, 64, 65, 66\}$

- b** $Z =$ number of even numbers, so $Z = \{0, 1, 2\}$.

$$\Pr(Z = 0) = \Pr(11) + \Pr(13) + \Pr(15) + \Pr(31) + \Pr(33) \\ + \Pr(35) + \Pr(51) + \Pr(53) + \Pr(55)$$

$$\Pr(Z = 0) = (0.1 \times 0.1) \times 9$$

$$\Pr(Z = 0) = 0.09$$

$$\Pr(Z = 2) = \Pr(22) + \Pr(24) + \Pr(26) + \Pr(42) + \Pr(44) + \Pr(46) + \Pr(62) + \Pr(64) + \Pr(66)$$

$$\Pr(Z = 2) = (0.2 \times 0.2) + (0.2 \times 0.25) + (0.2 \times 0.25) + (0.25 \times 0.2) + (0.25 \times 0.25) + (0.25 \times 0.25) + (0.25 \times 0.2) + (0.25 \times 0.25) + (0.25 \times 0.25)$$

$$\Pr(Z = 2) = 0.49$$

$$\Pr(Z = 1) = \Pr(12) + \Pr(14) + \Pr(16) + \Pr(21) + \Pr(23) + \Pr(25) + \Pr(32) + \Pr(34) + \Pr(36) + \Pr(41) + \Pr(43) + \Pr(45) + \Pr(52) + \Pr(54) + \Pr(56) + \Pr(61) + \Pr(63) + \Pr(65)$$

$$\Pr(Z = 1) = 1 - (\Pr(Z = 2) + \Pr(Z = 0)) = 1 - (0.49 + 0.09) = 0.42$$

z	0	1	2
$\Pr(Z = z)$	0.09	0.42	0.42

c $\Pr(Z = 1) = 0.42$

11 a $\xi = \{SSS, SSA, SAS, SAA, ASS, ASA, AAS, AAA\}$ where S means Simon won and A means Samara won.

b $X =$ number of sets Simon wins

$$\Pr(X = 0) = \Pr(AAA) = 0.6^3 = 0.216$$

$$\Pr(X = 1) = \Pr(AAS) + \Pr(ASA) + \Pr(SAA) = (0.6)^2 \times 0.4 \times 3 = 0.432$$

$$\Pr(X = 2) = \Pr(SSA) + \Pr(SAS) + \Pr(ASS) = (0.6)^2 \times 0.4 \times 3 = 0.288$$

$$\Pr(X = 3) = \Pr(SSS) = 0.4^3 = 0.064$$

x	0	1	2	3
$\Pr(X = x)$	0.216	0.432	0.288	0.064

c $\Pr(X \leq 2) = 1 - \Pr(X = 3) = 1 - 0.064 = 0.936$

12 a F = female and M = male

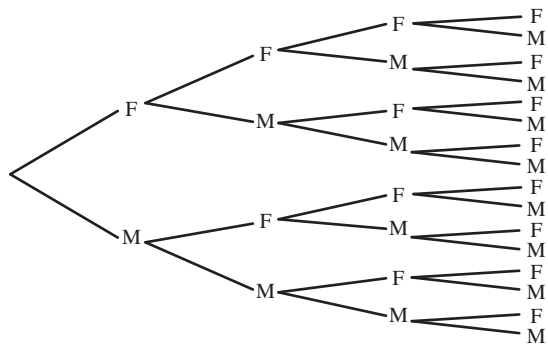

$$\xi = \left\{ \begin{array}{l} \text{FFFF, FFFM, FFMF, FFMM, FMFF, FMFM,} \\ \text{FMMF, FMFM, MFFF, MFFM, MFMF, MFMM,} \\ \text{MMFF, MMFM, MMMF, MMMM} \end{array} \right\}$$

b X is the number of females in the litter.

$$X = \{0, 1, 2, 3, 4\}$$

$$\Pr(X = 0) = \left(\frac{1}{2}\right)^4 = \frac{1}{16}, \Pr(X = 1) = 4 \left(\frac{1}{2}\right)^4 = \frac{4}{16}, \Pr(X = 2) = 6 \left(\frac{1}{2}\right)^4 = \frac{6}{16}$$

$$\Pr(X = 3) = 4 \left(\frac{1}{2}\right)^4 = \frac{4}{16}, \Pr(X = 4) = \left(\frac{1}{2}\right)^4 = \frac{1}{16}$$

x	0	1	2	3	4
$\Pr(X = x)$	$\frac{1}{16}$	$\frac{4}{16} = \frac{1}{4}$	$\frac{6}{16} = \frac{3}{8}$	$\frac{4}{16} = \frac{1}{4}$	$\frac{1}{16}$

c $\Pr(X = 4) = \frac{1}{16}$

d $\Pr(X \geq 1) = 1 - \Pr(X = 0) = 1 - \frac{1}{16} = \frac{15}{16}$

e $\Pr(X \leq 2) = \Pr(X = 0) + \Pr(X = 1) + \Pr(X = 2) = \frac{1}{16} + \frac{4}{16} + \frac{6}{16} = \frac{11}{16}$

- 13 a $\xi = \{11, 12, 13, 14, 15, 16, 17, 18, 19, 110, 111, 112, 21, 22, 23, 24, 25, 26, 27, 28, 29, 210, 211, 212, 31, 32, 33, 34, 35, 36, 37, 38, 39, 310, 311, 312, 41, 42, 43, 44, 45, 46, 47, 48, 49, 410, 411, 412, 51, 52, 53, 54, 55, 56, 57, 58, 59, 510, 511, 512, 61, 62, 63, 64, 65, 66, 67, 68, 69, 610, 611, 612, 71, 72, 73, 74, 75, 76, 77, 78, 79, 710, 711, 712, 81, 82, 83, 84, 85, 86, 87, 88, 89, 810, 811, 812\}$

b X is the number of primes obtained as a result of a toss.

$$\begin{aligned} \Pr(X = 0) &= \Pr(11, 14, 16, 18, 19, 110, 112, 41, 44, 46, 48, 49, 410, 412, \\ &\quad 61, 64, 66, 68, 69, 610, 612, 81, 84, 86, 88, 89, 810, 812) \\ &= 28 \times \left(\frac{1}{8} \times \frac{1}{12}\right) \\ &= \frac{28}{96} \end{aligned}$$

$$\begin{aligned} \Pr(X = 1) &= \Pr(12, 13, 15, 17, 111, 21, 24, 26, 28, 29, 210, 212, \\ &\quad 31, 34, 36, 38, 39, 310, 312, 42, 43, 45, 47, 411, \\ &\quad 51, 54, 56, 58, 59, 510, 512, 62, 63, 65, 67, 6, 11, \\ &\quad 71, 74, 76, 78, 79, 7, 10, 7, 12, 82, 83, 85, 87, 811) \\ &= 48 \times \left(\frac{1}{8} \times \frac{1}{12}\right) \\ &= \frac{48}{96} \end{aligned}$$

$$\begin{aligned} \Pr(X = 2) &= \Pr(22, 23, 25, 27, 211, 32, 33, 35, 37, 311, \\ &\quad 52, 53, 55, 57, 511, 72, 73, 75, 77, 711) \\ &= 20 \times \left(\frac{1}{8} \times \frac{1}{12}\right) \\ &= \frac{20}{96} \end{aligned}$$

c $\Pr(\text{Win}) = \Pr(X = 2) \times \Pr(X = 2) \times \Pr(X = 2)$

$$= \left(\frac{5}{24}\right)^3 = 0.009$$

14 a Possible scores are:

PP = 20 points, PJ or JP = 15 points, PS or SP = 12 points, JJ = 10 points
JS or SJ = 7 points, SS = 4 points.

b $\Pr(20) = \frac{3}{13} \times \frac{3}{13} = \frac{9}{169}$, $\Pr(15) = 2 \left(\frac{3}{13} \times \frac{1}{13}\right) = \frac{6}{169}$,
 $\Pr(12) = 2 \left(\frac{3}{13} \times \frac{9}{13}\right) = \frac{54}{169}$, $\Pr(10) = \frac{1}{13} \times \frac{1}{13} = \frac{1}{169}$,
 $\Pr(7) = 2 \left(\frac{1}{13} \times \frac{9}{13}\right) = \frac{18}{169}$, $\Pr(4) = \frac{9}{13} \times \frac{9}{13} = \frac{81}{169}$

x	4	7	10	12	15	20
$\Pr(X = x)$	$\frac{81}{169}$	$\frac{18}{169}$	$\frac{1}{169}$	$\frac{54}{169}$	$\frac{6}{169}$	$\frac{9}{169}$

c i $\Pr(X = 15) = \frac{6}{169}$

ii $\Pr(X \geq 12) = \frac{54}{169} + \frac{6}{169} + \frac{9}{169} = \frac{69}{169}$

iii $\Pr(X = 15 | X \geq 12) = \frac{\Pr(X = 15 \cap X \geq 12)}{\Pr(X \geq 12)} = \frac{6}{169} \times \frac{169}{69} = \frac{6}{69} = \frac{2}{23}$

15 a S = Success F = Failure

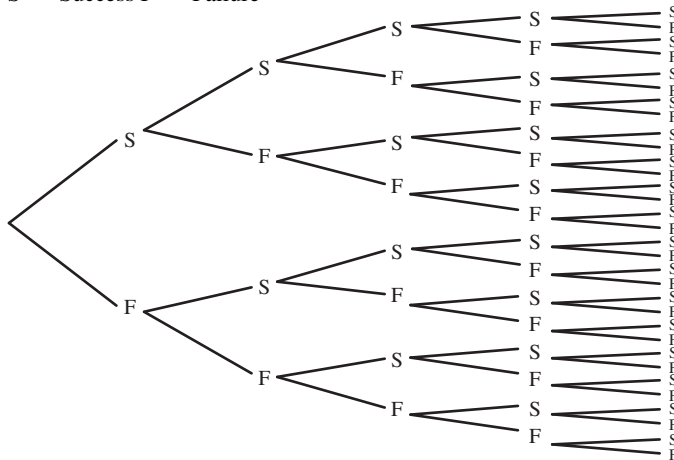

$E = \{SSSSS, SSSSF, SSSFS, SSSFF, SSFSS, SSFSF, SSFFS, SSFFF, SFSSS, SFSSF, SFSSS, SFSFF, SFFSS, SFFSF, SFFFS, SFFFF, FSSSS, FSSSF, FSSFS, FSSFF, FSFSS, FSFSF, FSFFS, FSFFF, FFSSS, FFSSF, FFSFS, FFSFF, FFFSS, FFFSF, FFFFS, FFFFF\}$

$$X = \{0, 1, 2, 3, 4, 5\}$$

$$\Pr(X = 0) = \Pr(5 \text{ failures}) = 0.4^5 = 0.01024$$

$$\Pr(X = 1) = \Pr(4 \text{ failures}) = 5 \times 0.4^4 \times 0.6 = 0.0768$$

$$\Pr(X = 2) = \Pr(3 \text{ failures}) = 10 \times 0.4^3 \times 0.6^2 = 0.2304$$

$$\Pr(X = 3) = \Pr(2 \text{ failures}) = 10 \times 0.4^2 \times 0.6^3 = 0.3456$$

$$\Pr(X = 4) = \Pr(1 \text{ failure}) = 5 \times 0.4 \times 0.6^4 = 0.2592$$

$$\Pr(X = 5) = \Pr(0 \text{ failures}) = 0.6^5 = 0.07776$$

x	0	1	2	3	4	5
$\Pr(X = x)$	0.0102	0.0768	0.2304	0.3456	0.2592	0.0778

b $\Pr(X = 3) + \Pr(X = 4) + \Pr(X = 5) = 0.3456 + 0.2592 + 0.0778 = 0.6826$

It is a success, helping 3 or more patients.

16 a $\Pr(H) = \frac{2}{3}$ and $\Pr(T) = \frac{1}{3}$ and X = the number of Heads obtained.

$$\Pr(X = 0) = \left(\frac{1}{3}\right)^6 = 0.0014$$

$$\Pr(X = 1) = {}^6C_1 \left(\frac{1}{3}\right)^5 \left(\frac{2}{3}\right) = 0.0165$$

$$\Pr(X = 2) = {}^6C_2 \left(\frac{1}{3}\right)^4 \left(\frac{2}{3}\right)^2 = 0.0823$$

$$\Pr(X = 3) = {}^6C_3 \left(\frac{1}{3}\right)^3 \left(\frac{2}{3}\right)^3 = 0.2195$$

$$\Pr(X = 4) = {}^6C_4 \left(\frac{1}{3}\right)^2 \left(\frac{2}{3}\right)^4 = 0.3292$$

$$\Pr(X = 5) = {}^6C_5 \left(\frac{1}{3}\right) \left(\frac{2}{3}\right)^5 = 0.2634$$

$$\Pr(X = 6) = \left(\frac{2}{3}\right)^6 = 0.0878$$

x	0	1	2	3	4	5	6
$\Pr(X = x)$	0.0014	0.0165	0.0823	0.2195	0.3292	0.2634	0.0878

b i $\Pr(X > 2) = \Pr(X = 3) + \Pr(X = 4) + \Pr(X = 5) + \Pr(X = 6)$
 $= 0.2195 + 0.3292 + 0.2634 + 0.0878$
 $= 0.8999$

$$\begin{aligned} \text{ii } \Pr(X > 2 \mid X < 5) &= \frac{\Pr(X = 3) + \Pr(X = 4)}{1 - (\Pr(X = 5) + \Pr(X = 6))} \\ &= \frac{0.2195 + 0.3292}{1 - (0.2634 + 0.0878)} \\ &= 0.8457 \end{aligned}$$

17 a $\sum_{\text{all } x} \Pr(X = x) = 1$

$$3m + 2n = 1 \quad [1]$$

$$3\Pr(X = 0) = \Pr(X = 5)$$

$$3m = n \quad [2]$$

Substitute [2] into [1]:

$$n + 2n = 1$$

$$3n = 1$$

$$n = \frac{1}{3}$$

Substitute $n = \frac{1}{3}$ into [2]:

$$3m = \frac{1}{3} \quad m = \frac{1}{9}$$

b i $\Pr(X \geq 0) = \Pr(X = 0) + \Pr(X = 1) + \Pr(X = 5)$

$$\Pr(X \geq 0) = \frac{1}{9} + \frac{1}{9} + \frac{1}{3} = \frac{5}{9}$$

ii $\Pr(X = 1 \mid X \geq 0) = \frac{\Pr(X = 1) \cap \Pr(X \geq 0)}{\Pr(X \geq 0)}$

$$= \frac{1}{9} \div \frac{5}{9} = \frac{1}{5}$$

18 $\sum_{\text{all } y} \Pr(Y = y) = 1$

$$0.5k^2 + 0.3 - 0.2k + 0.1 + 0.5k^2 + 0.3 = 1$$

$$k^2 - 0.2k + 0.7 = 1$$

$$k^2 - 0.2k - 0.3 = 0$$

$$k = -0.4568 \text{ or } k = 0.6568$$

k can be positive or negative due to the two places of k : $0.5k^2$ and $0.3 - 0.2k$

For both values of k , $0 < 0.5k^2 < 1$ and $0 < 0.3 - 0.2k < 1$

9.3 Exam questions

1 $\Pr(\text{same}) = [\Pr(X = 0)]^2 + [\Pr(X = 1)]^2 + [\Pr(X = 2)]^2 + [\Pr(X = 3)]^2$

$$= 0.5^2 + 0.25^2 + 0.2^2 + 0.05^2$$

$$= 0.355$$

The correct answer is C.

2 $\sum \Pr(X = x) = 1$

$$1 = 0.2 + 0.6p^2 + 0.1 + 1 - p + 0.1$$

$$0.6p^2 - p + 0.4 = 0$$

$$6p^2 - 10p + 4 = 0$$

$$3p^2 - 5p + 2 = 0$$

$$(3p - 2)(p - 1) = 0$$

$$p = 1 \quad \text{or} \quad p = \frac{2}{3}$$

The correct answer is D.

3 a

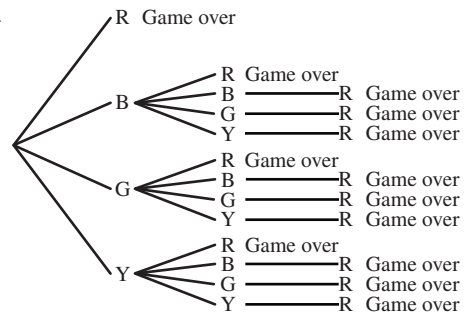

[1 mark]

b Wins \$10 with BBB, GGG or YYY

[1 mark]

c $X = \{0, 1, 10\}$

$$\begin{aligned} \Pr(X = 0) &= \frac{2}{5} + 3 \left(\frac{1}{5} \times \frac{2}{5} \right) + 9 \left(\frac{1}{5} \times \frac{1}{5} \times \frac{1}{5} \right) \\ &= \frac{2}{5} + \frac{6}{25} + \frac{9}{125} \end{aligned}$$

$$= \frac{50}{125} + \frac{30}{125} + \frac{9}{125} = \frac{98}{125}$$

[1 mark]

$$\Pr(X = 10) = 3 \left(\frac{1}{5} \right)^3 = \frac{3}{125}$$

[1 mark]

$$\begin{aligned} \Pr(X = 1) &= 1 - (\Pr(X = 0) + \Pr(X = 10)) \\ &= \frac{125}{125} - \left(\frac{98}{125} + \frac{3}{125} \right) = \frac{24}{125} \end{aligned}$$

x	\$0	\$1	\$10
$\Pr(X = x)$	$\frac{98}{125}$	$\frac{24}{125}$	$\frac{3}{125}$

[1 mark]

9.4 Measures of centre and spread

9.4 Exercise

1 a $\sum_{\text{all } x} \Pr(X = x) = 1$

$$\begin{aligned} E(X) &= -3 \left(\frac{1}{9} \right) + (-2) \left(\frac{1}{9} \right) + (-1) \left(\frac{1}{9} \right) + 0 \left(\frac{2}{9} \right) \\ &\quad + 1 \left(\frac{2}{9} \right) + 2 \left(\frac{1}{9} \right) + 3 \left(\frac{1}{9} \right) \end{aligned}$$

$$E(X) = -\frac{3}{9} - \frac{2}{9} - \frac{1}{9} + 0 + \frac{2}{9} + \frac{2}{9} + \frac{3}{9} = \frac{1}{9}$$

b $\sum_{\text{all } z} \Pr(Z = z) = 1$

i $E(Z) = 1 \left(\frac{1}{12} \right) + 2 \left(\frac{1}{4} \right) + 3 \left(\frac{1}{3} \right) + 4 \left(\frac{1}{6} \right)$

$$+ 5 \left(\frac{1}{12} \right) + 6 \left(\frac{1}{12} \right)$$

$$E(Z) = \frac{1}{12} + \frac{6}{12} + \frac{12}{12} + \frac{8}{12} + \frac{5}{12} + \frac{6}{12}$$

$$E(Z) = \left(\frac{38}{12} \right) = \frac{19}{6}$$

$$2 \text{ a } p(x) = \frac{1}{16}(2x - 1), x \in \{1, 2, 3, 4\}$$

$$p(1) = \frac{1}{16}(2(1) - 1) = \frac{1}{16}$$

$$p(2) = \frac{1}{16}(2(2) - 1) = \frac{3}{16}$$

$$p(3) = \frac{1}{16}(2(3) - 1) = \frac{5}{16}$$

$$p(4) = \frac{1}{16}(2(4) - 1) = \frac{7}{16}$$

y	1	2	3	4
Pr(X = x)	$\frac{1}{16}$	$\frac{3}{16}$	$\frac{5}{16}$	$\frac{7}{16}$

$$b \ E(X) = 1 \left(\frac{1}{16} \right) + 2 \left(\frac{3}{16} \right) + 3 \left(\frac{5}{16} \right) + 4 \left(\frac{7}{16} \right)$$

$$E(X) = \frac{1}{16} + \frac{6}{16} + \frac{15}{16} + \frac{28}{16} = \frac{50}{16} = 3.125 \text{ or } 3\frac{1}{8}$$

$$3 \text{ a } E(X) = 1(0.3) + 2(0.15) + 3(0.4) + 4(0.1) + 5(0.05)$$

$$E(X) = \$2.45$$

$$b \ E(X^2) = 1^2(0.3) + 2^2(0.15) + 3^2(0.4) + 4^2(0.1) + 5^2(0.05)$$

$$E(X^2) = 7.35$$

$$\text{Var}(X) = E(X^2) - [E(X)]^2$$

$$\text{Var}(X) = 7.35 - 2.45^2 = \$1.35$$

$$\text{SD}(X) = \sqrt{1.35} = \$1.16$$

$$4 \text{ a } \Pr(Y) = \Pr(-\$2) = \frac{1}{4}, \Pr(G) = \Pr(\$3) = \frac{1}{4},$$

$$\Pr(R) = \Pr(\$6) = \frac{1}{4}, \Pr(P) = \Pr(\$8) = \frac{1}{4}$$

x	-\$2	\$3	\$6	\$8
Pr(X = x)	$\frac{1}{4}$	$\frac{1}{4}$	$\frac{1}{4}$	$\frac{1}{4}$

$$b \ E(X) = -2 \left(\frac{1}{4} \right) + 3 \left(\frac{1}{4} \right) + 6 \left(\frac{1}{4} \right) + 8 \left(\frac{1}{4} \right)$$

$$E(X) = -\frac{2}{4} + \frac{3}{4} + \frac{6}{4} + \frac{8}{4} = \frac{15}{4} = \$3.75$$

$$5 \text{ a } k + k + 2k + 3k + 3k = 1$$

$$10k = 1$$

$$k = \frac{1}{10}$$

$$b \ E(X) = -2 \left(\frac{1}{10} \right) + 0 \left(\frac{1}{10} \right) + 2 \left(\frac{2}{10} \right) + 4 \left(\frac{3}{10} \right) + 6 \left(\frac{3}{10} \right)$$

$$E(X) = -\frac{2}{10} + 0 + \frac{4}{10} + \frac{12}{10} + \frac{18}{10} = \frac{32}{10} = 3.2$$

$$6 \text{ a } E(Y) = -5 \left(\frac{1}{10} \right) + 0 \left(\frac{3}{10} \right) + 5 \left(\frac{2}{10} \right) + d \left(\frac{3}{10} \right) + 25 \left(\frac{1}{10} \right) = \frac{15}{2}$$

$$-\frac{5}{10} + 0 + \frac{10}{10} + \frac{3d}{10} + \frac{25}{10} = \frac{15}{2}$$

$$\frac{3d + 30}{10} = \frac{15}{2}$$

$$3d + 30 = 75$$

$$3d = 45$$

$$d = 15$$

- b i** $E(2Y + 3) = 2E(Y) + 3 = 2(7.5) + 3 = 18$
ii $E(5 - Y) = 5 - E(Y) = 5 - 7.5 = -2.5$
iii $E(-2Y) = -2E(Y) = -2(7.5) = -15$

7 a $E(2X - 1) = 2E(X) - 1$
 $E(2X - 1) = 2(4.5) - 1 = 8$

b $E(5 - X) = 5 - E(X)$
 $E(5 - X) = 5 - 4.5 = 0.5$

c $E(3X + 1) = 3E(X) + 1$
 $E(3X + 1) = 3(4.5) + 1 = 14.5$

8 $p(z) = \frac{1}{38}(z^2 - 4), 2 \leq z \leq 5$
 $p(2) = \frac{1}{38}(2^2 - 4) = 0, p(3) = \frac{1}{38}(3^2 - 4) = \frac{5}{38},$
 $p(4) = \frac{1}{38}(4^2 - 4) = \frac{12}{38}, p(5) = \frac{1}{38}(5^2 - 4) = \frac{21}{38}$

$$E(Z) = 2(0) + 3\left(\frac{5}{38}\right) + 4\left(\frac{12}{38}\right) + 5\left(\frac{21}{38}\right)$$

$$E(Z) = 0 + \frac{15}{38} + \frac{48}{38} + \frac{105}{38}$$

$$E(Z) = \frac{168}{38} = 4.42$$

The correct answer is **B**.

9 $\sum_{\text{all } y} \Pr(Y = y) = 1$

a $E(Y) = 1(0.15) + 4(0.2) + 7(0.3) + 10(0.2) + 13(0.15)$
 $E(Y) = 0.15 + 0.8 + 2.1 + 2 + 1.95 = 7$

b $E(Y^2) = 1^2(0.15) + 4^2(0.2) + 7^2(0.3) + 10^2(0.2) + 13^2(0.15)$
 $E(Y^2) = 0.15 + 3.2 + 14.7 + 20 + 25.35$
 $E(Y^2) = 63.4$
 $\text{Var}(Y) = E(Y^2) - [E(Y)]^2$
 $\text{Var}(Y) = 63.4 - 7^2$
 $\text{Var}(Y) = 63.4 - 49 = 14.4$

c $SD(Y) = \sqrt{14.4} = 3.7947$

10 a $p(x) = \frac{x^2}{30}, x = 1, 2, 3, 4$

$$p(1) = \frac{1^2}{30} = \frac{1}{30}, p(2) = \frac{2^2}{30} = \frac{4}{30},$$

$$p(3) = \frac{3^2}{30} = \frac{9}{30}, p(4) = \frac{4^2}{30} = \frac{16}{30}$$

x	1	2	3	4
Pr(X = x)	$\frac{1}{30}$	$\frac{4}{30} = \frac{2}{15}$	$\frac{9}{30} = \frac{3}{10}$	$\frac{16}{30} = \frac{8}{15}$

$$\sum_{\text{all } x} \Pr(X = x) = \frac{1}{30} + \frac{4}{30} + \frac{9}{30} + \frac{16}{30} = 1$$

b i $E(X) = 1\left(\frac{1}{30}\right) + 2\left(\frac{4}{30}\right) + 3\left(\frac{9}{30}\right) + 4\left(\frac{16}{30}\right)$
 $E(X) = \frac{1}{30} + \frac{8}{30} + \frac{27}{30} + \frac{64}{30} = \frac{100}{30} = \frac{10}{3}$

ii $E(X^2) = 1^2\left(\frac{1}{30}\right) + 2^2\left(\frac{4}{30}\right) + 3^2\left(\frac{9}{30}\right) + 4^2\left(\frac{16}{30}\right)$

$$E(X^2) = \frac{1}{30} + \frac{16}{30} + \frac{81}{30} + \frac{256}{30}$$

$$E(X^2) = \frac{354}{30} = \frac{118}{10}$$

$$\text{Var}(X) = E(X^2) - [E(X)]^2$$

$$\text{Var}(X) = \frac{118}{10} - \left(\frac{10}{3}\right)^2$$

$$\text{Var}(X) = \frac{1062}{90} - \frac{1000}{90} = \frac{62}{90} = \frac{31}{45} = 0.69$$

c i $\text{Var}(4X + 3) = 4^2\text{Var}(X) = 16(0.69) = 11.02$

ii $\text{Var}(2 - 3X) = (-3)^2\text{Var}(X) = 9(0.689) = 6.2$

11 a $E(Z) = -7(0.21) + m(0.34) + 23(0.33) + 31(0.12) = 14.94$
 $-1.47 + 0.34m + 7.59 + 3.72 = 14.94$
 $0.34m + 9.84 = 14.94$

$$0.34m = 5.1$$

$$m = \frac{5.1}{0.34}$$

$$m = 15$$

b $E(Z^2) = (-7)^2(0.21) + 15^2(0.34) + 23^2(0.33) + 31^2(0.12)$

$$E(Z^2) = 10.29 + 76.5 + 174.57 + 115.32$$

$$E(Z^2) = 376.68$$

$$\text{Var}(Z) = E(Z^2) - [E(Z)]^2$$

$$\text{Var}(Z) = 376.68 - 14.94^2$$

$$\text{Var}(Z) = 153.48$$

$$\text{Var}(2(Z - 1)) = \text{Var}(2Z - 2)$$

$$\text{Var}(2(Z - 1)) = 2^2\text{Var}(Z)$$

$$\text{Var}(2(Z - 1)) = 4 \times 153.48$$

$$\text{Var}(2(Z - 1)) = 613.91$$

$$\text{Var}(3 - Z) = (-1)^2\text{Var}(Z)$$

$$\text{Var}(3 - Z) = 153.48$$

12 $SD(X) = 2.5$, so $\text{Var}(X) = 2.5^2 = 6.25$.

$$\text{Var}(2X + 3) = 2^2\text{Var}(X) = 4 \times 6.25 = 25$$

The correct answer is **C**.

13 a $p(x) = h(3 - x)(x + 1)$

$$p(0) = h(3)(1) = 3h$$

$$p(1) = h(3 - 1)(1 + 1) = 4h$$

$$p(2) = h(3 - 2)(2 + 1) = 3h$$

$$3h + 4h + 3h = 1$$

$$10h = 1$$

$$h = \frac{1}{10}$$

b

x	0	1	2
Pr(X = x)	$\frac{3}{10}$	$\frac{4}{10}$	$\frac{3}{10}$

$$E(X) = 0\left(\frac{3}{10}\right) + 1\left(\frac{4}{10}\right) + 2\left(\frac{3}{10}\right)$$

$$E(X) = 0 + \frac{4}{10} + \frac{6}{10} = \frac{10}{10} = 1$$

$$E(X^2) = 0^2\left(\frac{3}{10}\right) + 1^2\left(\frac{4}{10}\right) + 2^2\left(\frac{3}{10}\right)$$

$$E(X^2) = 0 + \frac{4}{10} + \frac{12}{10} = \frac{16}{10} = 1.6$$

$$\text{Var}(X) = E(X^2) - [E(X)]^2$$

$$\text{Var}(X) = \frac{16}{10} - (1)^2$$

$$\text{Var}(X) = \frac{16}{10} - \frac{10}{10} = \frac{6}{10} = 0.6$$

$$SD(X) = \sqrt{\frac{6}{10}} = 0.7746$$

14 a $E = \{11, 12, 13, 14, 15, 16, 17, 18, 21, 22, 23, 24, 25, 26, 27, 28, 31, 32, 33, 34, 35, 36, 37, 38, 41, 42, 43, 44, 45, 46, 47, 48, 51, 52, 53, 54, 55, 56, 57, 58, 61, 62, 63, 64, 65, 66, 67, 68, 71, 72, 73, 74, 75, 76, 77, 78, 81, 82, 83, 84, 85, 86, 87, 88\}$

$$\text{b } \Pr(Z = 1) = \Pr(11) = \left(\frac{1}{8}\right)^2 = \frac{1}{64}$$

$$\Pr(Z = 2) = \Pr(12, 21, 22) = 3\left(\frac{1}{8}\right)^2 = \frac{3}{64}$$

$$\Pr(Z = 3) = \Pr(13, 23, 31, 32, 33) = 5\left(\frac{1}{8}\right)^2 = \frac{5}{64}$$

$$\Pr(Z = 4) = \Pr(14, 24, 34, 41, 42, 43, 44) = 7\left(\frac{1}{8}\right)^2 = \frac{7}{64}$$

$$\Pr(Z = 5) = \Pr(15, 25, 35, 45, 51, 52, 53, 54, 55) = 9\left(\frac{1}{8}\right)^2 = \frac{9}{64}$$

$$\Pr(Z = 6) = \Pr(16, 26, 36, 46, 56, 61, 62, 63, 64, 65, 66)$$

$$\Pr(Z = 6) = 11\left(\frac{1}{8}\right)^2 = \frac{11}{64}$$

$$\Pr(Z = 7) = \Pr(17, 27, 37, 47, 57, 67, 71, 72, 73, 74, 75, 76, 77)$$

$$\Pr(Z = 7) = 13\left(\frac{1}{8}\right)^2 = \frac{13}{64}$$

$$\Pr(Z = 8) = \Pr(18, 28, 38, 48, 58, 68, 78, 81, 82, 83, 84, 85, 86, 87, 88)$$

$$\Pr(Z = 8) = 15\left(\frac{1}{8}\right)^2 = \frac{15}{64}$$

z	1	2	3	4	5	6	7	8
$\Pr(Z = z)$	$\frac{1}{64}$	$\frac{3}{64}$	$\frac{5}{64}$	$\frac{7}{64}$	$\frac{9}{64}$	$\frac{11}{64}$	$\frac{13}{64}$	$\frac{15}{64}$

$$\text{c } E(Z) = 1\left(\frac{1}{64}\right) + 2\left(\frac{3}{64}\right) + 3\left(\frac{5}{64}\right) + 4\left(\frac{7}{64}\right) + 5\left(\frac{9}{64}\right) + 6\left(\frac{11}{64}\right) + 7\left(\frac{13}{64}\right) + 8\left(\frac{15}{64}\right)$$

$$E(Z) = \frac{1}{64} + \frac{6}{64} + \frac{15}{64} + \frac{28}{64} + \frac{45}{64} + \frac{66}{64} + \frac{91}{64} + \frac{120}{64}$$

$$E(Z) = \frac{372}{64} = 5.8125$$

$$E(Z^2) = 1^2\left(\frac{1}{64}\right) + 2^2\left(\frac{3}{64}\right) + 3^2\left(\frac{5}{64}\right) + 4^2\left(\frac{7}{64}\right) + 5^2\left(\frac{9}{64}\right) + 6^2\left(\frac{11}{64}\right) + 7^2\left(\frac{13}{64}\right) + 8^2\left(\frac{15}{64}\right)$$

$$E(Z^2) = \frac{1}{64} + \frac{12}{64} + \frac{45}{64} + \frac{112}{64} + \frac{225}{64} + \frac{396}{64} + \frac{637}{64} + \frac{960}{64} = \frac{2388}{64} = 37.3125$$

$$\text{Var}(Z) = E(Z^2) - [E(Z)]^2$$

$$\text{Var}(Z) = \frac{2388}{64} - \left(\frac{372}{64}\right)^2$$

$$\text{Var}(Z) = \frac{152\,832}{4096} - \frac{138\,384}{4096} = \frac{14\,448}{4096} = 3.5273$$

$$SD(Z) = \sqrt{\frac{14\,448}{4096}} = 1.8781$$

15 a Possible scores:

$$E = \left\{ \begin{array}{l} \overbrace{1-1}^2, \overbrace{1-3}^4, \overbrace{1-5}^6, \overbrace{1-7}^8, \overbrace{1-10}^{11} \\ \overbrace{3-1}^4, \overbrace{3-3}^6, \overbrace{3-5}^8, \overbrace{3-7}^{10}, \overbrace{3-10}^{13} \\ \overbrace{5-1}^6, \overbrace{5-3}^8, \overbrace{5-5}^{10}, \overbrace{5-7}^{12}, \overbrace{5-10}^{15} \\ \overbrace{7-1}^8, \overbrace{7-3}^{10}, \overbrace{7-5}^{12}, \overbrace{7-7}^{14}, \overbrace{7-10}^{17} \\ \overbrace{10-1}^{11}, \overbrace{10-3}^{13}, \overbrace{10-5}^{15}, \overbrace{10-7}^{17}, \overbrace{10-10}^{20} \end{array} \right\}$$

Therefore, the possible scores are 2, 4, 6, 8, 10, 11, 12, 13, 14, 15, 17, 20.

- b $\Pr(2) = \Pr(1\ 1) = 0.2 \times 0.2 = 0.04$
 $\Pr(4) = \Pr(1\ 3, 3\ 1) = (0.2 \times 0.2)^2 = 0.08$
 $\Pr(6) = \Pr(1\ 5, 3\ 3, 5\ 1) = (0.2 \times 0.3) + (0.2 \times 0.2) + (0.3 \times 0.2) = 0.16$
 $\Pr(8) = \Pr(1\ 7, 3\ 5, 5\ 3, 7\ 1) = (0.2 \times 0.2) + (0.2 \times 0.3) + (0.3 \times 0.2) + (0.2 \times 0.2) = 0.20$
 $\Pr(10) = \Pr(3\ 7, 5\ 5, 7\ 3) = (0.2 \times 0.2) + (0.3 \times 0.3) + (0.2 \times 0.2) = 0.17$
 $\Pr(11) = \Pr(1\ 10, 10\ 1) = (0.2 \times 0.1) + (0.1 \times 0.2) = 0.04$
 $\Pr(12) = \Pr(5\ 7, 7\ 5) = (0.3 \times 0.2) + (0.2 \times 0.3) = 0.12$
 $\Pr(13) = \Pr(1\ 10, 10\ 1) = (0.2 \times 0.1) + (0.1 \times 0.2) = 0.04$
 $\Pr(14) = \Pr(7\ 7) = 0.2 \times 0.2 = 0.04$
 $\Pr(15) = \Pr(5\ 10, 10\ 5) = (0.3 \times 0.1) + (0.1 \times 0.3) = 0.06$
 $\Pr(17) = \Pr(7\ 10, 10\ 7) = (0.2 \times 0.1) + (0.1 \times 0.2) = 0.04$
 $\Pr(20) = \Pr(10\ 10) = 0.1 \times 0.1 = 0.01$

x	2	4	6	8	10	11	12	13	14	15	17	20
$\Pr(X = x)$	0.04	0.08	0.16	0.2	0.17	0.04	0.12	0.04	0.04	0.06	0.04	0.01

 c $E(X) = 9.4$ and $SD(X) = 3.7974$

 16 a $\sum_{\text{all } y} \Pr(Y = y) = 1$

$$\begin{aligned}
 1 - 2c + 3c^2 + 1 - 2c &= 1 \\
 3c^2 - 4c + 1 &= 0 \\
 (3c - 1)(c - 1) &= 0
 \end{aligned}$$

$$\begin{aligned}
 3c - 1 &= 0 \\
 3c &= 1 \quad \text{or} \quad c - 1 = 0 \\
 c &= \frac{1}{3} \quad \text{or} \quad c = 1
 \end{aligned}$$

$$\therefore c = \frac{1}{3} \text{ as } 0 < c < 1$$

b

y	-1	1	3	5	7
$\Pr(Y = y)$	$\frac{1}{3}$	$\frac{1}{9}$	$\frac{1}{9}$	$\frac{1}{9}$	$\frac{1}{3}$

$$E(Y) = -1 \left(\frac{1}{3} \right) + 1 \left(\frac{1}{9} \right) + 3 \left(\frac{1}{9} \right) + 5 \left(\frac{1}{9} \right) + 7 \left(\frac{1}{3} \right)$$

$$E(Y) = -\frac{1}{3} + \frac{1}{9} + \frac{3}{9} + \frac{5}{9} + \frac{7}{3}$$

$$E(Y) = -\frac{3}{9} + \frac{1}{9} + \frac{3}{9} + \frac{5}{9} + \frac{21}{9}$$

$$E(Y) = \frac{27}{9} = 3$$

$$\begin{aligned} \text{c } E(Y^2) &= (-1)^2 \left(\frac{1}{3}\right) + 1^2 \left(\frac{1}{9}\right) + 3^2 \left(\frac{1}{9}\right) + 5^2 \left(\frac{1}{9}\right) + 7^2 \left(\frac{1}{3}\right) \\ E(Y^2) &= (-1)^2 \left(\frac{1}{3}\right) + 1^2 \left(\frac{1}{9}\right) + 3^2 \left(\frac{1}{9}\right) + 5^2 \left(\frac{1}{9}\right) + 7^2 \left(\frac{1}{3}\right) \\ E(Y^2) &= \frac{3}{9} + \frac{1}{9} + \frac{9}{9} + \frac{25}{9} + \frac{147}{9} \\ E(Y^2) &= \frac{185}{9} \\ \text{Var}(Y) &= E(Y^2) - [E(Y)]^2 \\ \text{Var}(Y) &= \frac{185}{9} - 3^2 \\ \text{Var}(Y) &= \frac{185}{9} - \frac{81}{9} \\ \text{Var}(Y) &= \frac{104}{9} \\ \text{Var}(Y) &= 11.56 \\ \text{SD}(Y) &= \sqrt{11.56} = 3.40 \end{aligned}$$

$$17 \text{ a } \sum_{\text{all } x} \Pr(X = x) = 1$$

$$\begin{aligned} 0.5k^2 + 0.5k^2 + k + k^2 + 4k + 2k + 2k + k^2 + 7k^2 &= 1 \\ 10k^2 + 9k - 1 &= 0 \end{aligned}$$

$$\begin{aligned} k &= -1 \text{ or } k = 0.1 \\ \therefore k &= 0.1, k > 0 \end{aligned}$$

$$\text{b } E(X) = 1.695$$

$$\text{c } \text{SD}(X) = 1.1670$$

$$18 \text{ a } \sum_{\text{all } x} \Pr(X = x) = 1$$

$$\begin{aligned} a + 0.2 + 0.3 + b + 0.1 &= 1 \\ a + b + 0.6 &= 1 \\ a + b &= 0.4 \quad [1] \end{aligned}$$

$$\begin{aligned} E(X) &= 2.5 \\ 1(a) + 2(0.2) + 3(0.3) + 4(b) + 5(0.1) &= 2.5 \\ a + 0.4 + 0.9 + 4b + 0.5 &= 2.5 \\ a + 4b + 1.8 &= 2.5 \\ a + 4b &= 0.7 \quad [2] \end{aligned}$$

$$[2] = [1]:$$

$$3b = 0.3$$

$$b = 0.1$$

Substitute $b = 0.1$ into [1]:

$$a + 0.1 = 0.4$$

$$a = 0.3$$

$$\text{b } E(X^2) = 1^2(0.3) + 2^2(0.2) + 3^2(0.3) + 4^2(0.1) + 5^2(0.1)$$

$$E(X^2) = 0.3 + 0.8 + 2.7 + 1.6 + 2.5$$

$$E(X^2) = 7.9$$

$$\text{Var}(X) = E(X^2) - [E(X)]^2$$

$$\text{Var}(X) = 7.9 - 2.5^2$$

$$\text{Var}(X) = 7.9 - 6.25$$

$$\text{Var}(X) = 1.65$$

$$\text{SD}(X) = \sqrt{1.65} = 1.2845$$

$$19 \text{ a } \text{Var}(X) = 2a - 2 \text{ and } E(X) = a$$

$$\text{Var}(X) = E(X^2) - [E(X)]^2$$

$$2a - 2 = E(X^2) - a^2$$

$$a^2 + 2a - 2 = E(X^2)$$

$$\mathbf{b} \ E(X^2) = 6$$

$$a^2 + 2a - 2 = 6$$

$$a^2 + 2a - 8 = 0$$

$$(a + 4)(a - 2) = 0$$

$$a + 4 = 0 \quad \text{or} \quad a - 2 = 0$$

$$a = -4 \qquad a = 2$$

$$\therefore a = 2, \quad a > 0$$

$$\text{Thus, } E(X) = a = 2 \text{ and } \text{Var}(X) = 2a - 2 = 2(2) - 2 = 2.$$

$$\mathbf{20} \ \mathbf{a} \ p(n) = \begin{cases} ny & y = 1, 2, 3, 4 \\ n(7 - y) & y = 5, 6 \end{cases}$$

$$p(1) = n, \ p(2) = 2n, \ p(3) = 3n, \ p(4) = 4n,$$

$$p(5) = 2n, \ p(6) = n$$

$$\sum_{\text{all } x} \Pr(X = x) = 1$$

$$n + 2n + 3n + 4n + 2n + n = 1$$

$$13n - 1 = 0$$

$$n = \frac{1}{13}$$

$$\mathbf{b}$$

y	1	2	3	4	5	6
$\Pr(Y = y)$	$\frac{1}{13}$	$\frac{2}{13}$	$\frac{3}{13}$	$\frac{4}{13}$	$\frac{2}{13}$	$\frac{1}{13}$

$$E(Y) = 1 \left(\frac{1}{13} \right) + 2 \left(\frac{2}{13} \right) + 3 \left(\frac{3}{13} \right) + 4 \left(\frac{4}{13} \right) + 5 \left(\frac{2}{13} \right) + 6 \left(\frac{1}{13} \right)$$

$$E(Y) = \frac{1}{13} + \frac{4}{13} + \frac{9}{13} + \frac{16}{13} + \frac{10}{13} + \frac{6}{13} = \frac{46}{13} = 3.5385$$

$$E(Y^2) = 1^2 \left(\frac{1}{13} \right) + 2^2 \left(\frac{2}{13} \right) + 3^2 \left(\frac{3}{13} \right) + 4^2 \left(\frac{4}{13} \right) + 5^2 \left(\frac{2}{13} \right) + 6^2 \left(\frac{1}{13} \right)$$

$$E(Y^2) = \frac{1}{13} + \frac{8}{13} + \frac{27}{13} + \frac{64}{13} + \frac{50}{13} + \frac{36}{13} = \frac{186}{13}$$

$$\text{Var}(Y) = E(Y^2) - [E(Y)]^2$$

$$\text{Var}(Y) = \frac{186}{13} - \left(\frac{46}{13} \right)^2$$

$$\text{Var}(Y) = \frac{2418}{169} - \frac{2116}{169} = \frac{302}{169} = 1.7870$$

$$\text{SD}(Y) = \sqrt{1.7870} = 1.3368$$

9.4 Exam questions

$$\mathbf{1} \quad \mu = E(X) = \sum x \Pr(X = x)$$

$$\mu = 0 \times \frac{1}{4} + 1 \times \frac{9}{20} + 2 \times \frac{1}{10} + 3 \times \frac{1}{20} + 6 \times \frac{3}{20} = \frac{17}{10}$$

$$\Pr(X < \mu) = \Pr(X < 1.7)$$

$$= \Pr(X = 0) + \Pr(X = 1)$$

$$= \frac{1}{4} + \frac{9}{20}$$

$$= \frac{7}{10}$$

The correct answer is **E**.

$$\mathbf{2} \quad E(X) = \sum x \Pr(X = x) = -p + 1 - 3p = 1 - 4p$$

$$E(X^2) = \sum x^2 \Pr(X = x) = p + 1 - 3p = 1 - 2p$$

$$\text{Var}(X) = E(X^2) - (E(X))^2$$

$$= (1 - 2p) - (1 - 4p)^2$$

$$= 1 - 2p - (1 - 8p + 16p^2)$$

$$= 6p - 16p^2$$

The correct answer is **D**.

3 a Area of the whole board is $\pi(4 \times 5)^2 = 400\pi$.

Band A = $\pi(4)^2 = 16\pi$ and

$$\Pr(\text{Band A}) = \frac{16\pi}{400\pi} = \frac{1}{25} \quad [1 \text{ mark}]$$

Band B = $\pi(8)^2 - 16\pi = 64\pi - 16\pi = 48\pi$ and

$$\Pr(\text{Band B}) = \frac{48\pi}{400\pi} = \frac{3}{25} \quad [1 \text{ mark}]$$

Band C = $\pi(12)^2 - 64\pi = 144\pi - 64\pi = 80\pi$ and

$$\Pr(\text{Band C}) = \frac{80\pi}{400\pi} = \frac{5}{25} \quad [1 \text{ mark}]$$

Band D = $\pi(16)^2 - 144\pi = 256\pi - 144\pi = 112\pi$ and

$$\Pr(\text{Band D}) = \frac{112\pi}{400\pi} = \frac{7}{25} \quad [1 \text{ mark}]$$

Band E = $\pi(20)^2 - 256\pi = 400\pi - 256\pi = 144\pi$ and

$$\Pr(\text{Band E}) = \frac{144\pi}{400\pi} = \frac{9}{25} \quad [1 \text{ mark}]$$

b X is the gain in dollars.

$\Pr(E) = -\$1$, $\Pr(D) = \$0$, $\Pr(C) = \$1$, $\Pr(B) = \$4$,

$\Pr(A) = \$9$

x	-\$1	\$0	\$1	\$4	\$9
$\Pr(X = x)$	$\frac{9}{25}$	$\frac{7}{25}$	$\frac{5}{25} = \frac{1}{5}$	$\frac{3}{25}$	$\frac{1}{25}$

[1 mark]

$$\begin{aligned} \text{c i } E(X) &= -1 \left(\frac{9}{25} \right) + 0 \left(\frac{7}{25} \right) + 1 \left(\frac{5}{25} \right) + 4 \left(\frac{3}{25} \right) \\ &\quad + 9 \left(\frac{1}{25} \right) \end{aligned} \quad [1 \text{ mark}]$$

$$E(X) = -\frac{9}{25} + 0 + \frac{5}{25} + \frac{12}{25} + \frac{9}{25}$$

$$E(X) = \frac{17}{25} = 0.68 \text{ cents} \quad [1 \text{ mark}]$$

$$\begin{aligned} \text{ii } E(X^2) &= (-1)^2 \left(\frac{9}{25} \right) + 0^2 \left(\frac{7}{25} \right) + 1^2 \left(\frac{5}{25} \right) \\ &\quad + 4^2 \left(\frac{3}{25} \right) + 9^2 \left(\frac{1}{25} \right) \end{aligned}$$

$$E(X^2) = \frac{9}{25} + 0 + \frac{5}{25} + \frac{48}{25} + \frac{81}{25}$$

$$E(X^2) = \frac{143}{25} \quad [1 \text{ mark}]$$

$$\text{Var}(X) = E(X^2) - [E(X)]^2$$

$$\text{Var}(X) = \frac{143}{25} - \left(\frac{17}{25} \right)^2$$

$$\text{Var}(X) = \frac{3575}{625} - \frac{289}{625} = \frac{3286}{625} = \$5.26$$

$$\text{SD}(X) = \sqrt{\frac{3286}{625}} = \$2.29 \quad [1 \text{ mark}]$$

9.5 Applications

9.5 Exercise

$$\begin{aligned} \text{1 a } E(X) &= 0 \times 0.2 + 1 \times 0.1 + 2 \times 0.3 + 3 \times 0.3 + 4 \times 0.1 \\ &= 0.1 + 0.6 + 0.9 + 0.4 \\ &= 2.0 \end{aligned}$$

$$\begin{aligned} \text{b } \Pr(\mu - 2\sigma > X < \mu + 2\sigma) &= \Pr(2 - 2 \times 1.3 \leq X \leq 2 + 2 \times 1.3) \\ &= \Pr(-0.6 \leq X \leq 4.6) \\ &= \Pr(0 \leq X \leq 4) \\ &= 1 \end{aligned}$$

2 a $E(Y) = 3.5$

$$1(0.3) + 2(0.2) + d(0.4) + 8(0.1) = 3.5$$

$$0.3 + 0.4 + 0.4d + 0.8 = 3.5$$

$$0.4d + 1.5 = 3.5$$

$$0.4d = 2$$

$$d = \frac{2}{0.4}$$

$$d = 5$$

$$\text{b } \Pr(Y \geq 2 | Y \leq 5) = \frac{\Pr(Y \geq 2) \cap \Pr(Y \leq 5)}{\Pr(Y \leq 5)}$$

$$\Pr(Y \geq 2 | Y \leq 5) = \frac{\Pr(Y = 2) + \Pr(Y = 5)}{1 - \Pr(Y = 8)}$$

$$\Pr(Y \geq 2 | Y \leq 5) = \frac{0.2 + 0.4}{1 - 0.1}$$

$$\Pr(Y \geq 2 | Y \leq 5) = \frac{0.6}{0.9} = \frac{2}{3}$$

3

x	\$100	\$250	\$500	\$750	\$1000
$\Pr(X = x)$	0.1	0.2	0.3	0.3	0.1

where X is hundreds of thousands of dollars.

$$\text{a } \Pr(X \leq \$500) = \Pr(X = \$100) + \Pr(X = \$250) + \Pr(X = \$500)$$

$$\Pr(X \leq \$500) = 0.1 + 0.2 + 0.3 = 0.6$$

$$\text{b } \Pr(X \geq \$250 | X \leq \$750) = \frac{\Pr(X \geq \$250) \cap \Pr(X \leq \$750)}{\Pr(X \leq \$750)}$$

$$\begin{aligned} &\Pr(X \geq \$250 | X \leq \$750) \\ &= \frac{\Pr(X = \$250) + \Pr(X = \$500) + \Pr(X = \$750)}{1 - \Pr(X = \$1000)} \end{aligned}$$

$$\Pr(X \geq \$250 | X \leq \$750) = \frac{0.2 + 0.3 + 0.3}{1 - 0.1}$$

$$\Pr(X \geq \$250 | X \leq \$750) = \frac{0.8}{0.9} = \frac{8}{9}$$

$$\text{c } E(X) = 100(0.1) + 250(0.2) + 500(0.3) + 750(0.3) + 1000(0.1)$$

$$E(X) = 10 + 50 + 150 + 225 + 100 = \$535$$

Therefore, the expected profit is \$535 000.

$$\text{4 } \sum_{\text{all } z} \Pr(Z = z) = 1$$

$$0.2 + 0.15 + a + b + 0.05 = 1$$

$$a + b + 0.4 = 1$$

$$a + b = 0.6 \quad [1]$$

$$E(Z) = 4.6$$

$$1(0.2) + 3(0.15) + 5a + 7b + 9(0.05) = 4.6$$

$$0.2 + 0.45 + 5a + 7b + 0.45 = 4.6$$

$$5a + 7b + 1.1 = 4.6$$

$$5a + 7b = 3.5 \quad [2]$$

From [1]:

$$a = 0.6 - b \quad [3]$$

Substitute [3] into [2]:

$$5(0.6 - b) + 7b = 3.5$$

$$3 - 5b + 7b = 3.5$$

$$2b = 0.5$$

$$b = 0.25$$

Substitute $b = 0.25$ into [3]:

$$a = 0.6 - 0.25 = 0.35$$

$$\text{5 a } E(X) = 5(0.05) + 10(0.25) + 15(0.4) + 20(0.25) + 25(0.05)$$

$$E(X) = 0.25 + 2.5 + 6 + 5 + 1.25$$

$$E(X) = 15$$

- b** $E(X^2) = 5^2(0.05) + 10^2(0.25) + 15^2(0.4) + 20^2(0.25) + 25^2(0.05)$
 $E(X^2) = 1.25 + 25 + 90 + 100 + 31.25$
 $E(X^2) = 247.5$
 $\text{Var}(X) = E(X^2) - [E(X)]^2$
 $\text{Var}(X) = 247.5 - 15^2$
 $\text{Var}(X) = 22.5$
 $\text{SD}(X) = \sqrt{22.5} = 4.7434$
- c** $\mu - 2\sigma = 15 - 2(4.7434) = 5.5132$
 $\mu + 2\sigma = 15 + 2(4.7434) = 24.4947$
 $\Pr(\mu - 2\sigma \leq X \leq \mu + 2\sigma) = \Pr(5.5132 \leq X \leq 24.4947)$
 $\Pr(\mu - 2\sigma \leq X \leq \mu + 2\sigma) = \Pr(X = 10) + \Pr(X = 15) + \Pr(X = 20)$
 $\Pr(\mu - 2\sigma \leq X \leq \mu + 2\sigma) = 1 - (\Pr(X = 5) + \Pr(X = 25))$
 $\Pr(\mu - 2\sigma \leq X \leq \mu + 2\sigma) = 1 - 0.1 = 0.9$
- 6** $E(X) = 0(0.012) + 1(0.093) + 2(0.243) + 3(0.315) + 4(0.214)$
 $+ 5(0.1) + 6(0.023)$
 $E(X) = 0 + 0.093 + 0.486 + 0.945 + 0.856 + 0.5 + 0.138$
 $E(X) = 3.018$
 $E(X^2) = 0^2(0.012) + 1^2(0.093) + 2^2(0.243) + 3^2(0.315)$
 $+ 4^2(0.214) + 5^2(0.1) + 6^2(0.023)$
 $E(X^2) = 0 + 0.093 + 0.972 + 2.835 + 3.424 + 2.5 + 0.828$
 $E(X^2) = 10.652$
 $\text{Var}(X) = E(X^2) - [E(X)]^2$
 $\text{Var}(X) = 10.652 - 3.018^2$
 $\text{Var}(X) = 1.5437$
 $\text{SD}(X) = \sqrt{1.5437} = 1.2424$
 $\mu - 2\sigma = 3.018 - 2(1.2424) = 0.5332$
 $\mu + 2\sigma = 3.018 + 2(1.2424) = 5.5028$
 $\Pr(\mu - 2\sigma \leq X \leq \mu + 2\sigma) = \Pr(0.5332 \leq X \leq 5.5028)$
 $\Pr(\mu - 2\sigma \leq X \leq \mu + 2\sigma) = \Pr(X = 1) + \Pr(X = 2)$
 $+ \Pr(X = 3) + \Pr(X = 4)$
 $+ \Pr(X = 5)$
 $\Pr(\mu - 2\sigma \leq X \leq \mu + 2\sigma) = 1 - (\Pr(X = 0) + \Pr(X = 1))$
 $\Pr(\mu - 2\sigma \leq X \leq \mu + 2\sigma) = 1 - (0.012 + 0.023)$
 $\Pr(\mu - 2\sigma \leq X \leq \mu + 2\sigma) = 0.965$
- 7 a** If $p(x) = \frac{1}{9}(4 - x)$, where $x = \{0, 1, 2\}$,
 $p(0) = \frac{4}{9}$, $p(1) = \frac{3}{9} = \frac{1}{3}$, $p(2) = \frac{2}{9}$.
- b** $\sum_{x=1}^{\infty} p(x) = 1$, so this is a probability density function.
- i** $E(X) = \mu = \sum_{x=1}^{\infty} xp(x)$
 $= 0\left(\frac{4}{9}\right) + 1\left(\frac{3}{9}\right) + 2\left(\frac{2}{9}\right) = \frac{7}{9}$
- ii** $\text{Var}(X) = \sigma^2 = \sum_{x=1}^{\infty} (x - 2)^2 p(x) = \frac{11}{9} - \left(\frac{7}{9}\right)^2$
 $= \frac{99}{81} - \frac{49}{81} = \frac{50}{81}$
- iii** $\text{SD}(X) = \sqrt{\frac{50}{81}} = 0.7857$
- c** $\mu - 2\sigma = 2 - 2(1.03) = -0.06$
 $\mu + 2\sigma = 2 + 2(1.03) = 4.06$
 $\Pr(\mu - 2\sigma \leq X \leq \mu + 2\sigma) = \Pr(-0.06 \leq X \leq 4.06)$
 $\Pr(\mu - 2\sigma \leq X \leq \mu + 2\sigma) = \Pr(0) + \Pr(1) + \Pr(2)$
 $\Pr(\mu - 2\sigma \leq X \leq \mu + 2\sigma) = 1$
- 8 a** $\sum_{\text{all } z} \Pr(Z = z) = 1$
 $\frac{k^2}{7} + \frac{5 - 2k}{7} + \frac{8 - 3k}{7} = 1$
 $k = 2 \text{ or } 3$
 But if $k = 3$, $\frac{8 - 3(3)}{7} = -\frac{1}{7}$, so this is not applicable.
 $\therefore k = 2$
- | | | | |
|------------------|-------------------------------|------------------------------------|------------------------------------|
| z | 1 | 3 | 5 |
| Pr(Z = z) | $\frac{2^2}{7} = \frac{4}{7}$ | $\frac{5 - 2(2)}{7} = \frac{1}{7}$ | $\frac{8 - 3(2)}{7} = \frac{2}{7}$ |
- i** $E(Z) = 2.4286$
ii $\text{Var}(Z) = E(Z^2) - [E(Z)]^2 = 9 - 2.4286^2 = 3.1019$
iii $\text{SD}(Z) = \sqrt{3.1019} = 1.7613$
- c** $\mu - 2\sigma = 2.4286 - 2(1.7613) = -1.094$
 $\mu + 2\sigma = 2.4286 + 2(1.7613) = 5.9512$
 $\Pr(\mu - 2\sigma \leq Z \leq \mu + 2\sigma) = \Pr(-1.094 \leq Z \leq 5.9512) = 1$
- 9 a** $\sum_{\text{all } z} \Pr(Z = z) = 1$
 $3m + 3n = 1$ [1]
 $\Pr(Z < 2) = 3 \Pr(Z > 4)$
 $\Pr(Z = 0) + \Pr(Z = 1) = 3 \Pr(Z = 5)$
 $2m = 3n$ [2]
- Substitute [2] into [1]:
 $3m + 2m = 1$
 $5m = 1$
 $m = \frac{1}{5}$
 Substitute $m = \frac{1}{5}$ into [2]:
 $2\left(\frac{1}{5}\right) = 3n$
 $n = \frac{2}{15}$
- b** $E(Z) = 0\left(\frac{3}{15}\right) + 1\left(\frac{3}{15}\right) + 2\left(\frac{3}{15}\right) + 3\left(\frac{2}{15}\right)$
 $+ 4\left(\frac{2}{15}\right) + 5\left(\frac{2}{15}\right)$
 $E(Z) = 0 + \frac{3}{15} + \frac{6}{15} + \frac{6}{15} + \frac{8}{15} + \frac{10}{15}$
 $E(Z) = \frac{33}{15} = \frac{11}{5}$ as required
 $E(Z^2) = 0^2\left(\frac{3}{15}\right) + 1^2\left(\frac{3}{15}\right) + 2^2\left(\frac{3}{15}\right) + 3^2\left(\frac{2}{15}\right)$
 $+ 4^2\left(\frac{2}{15}\right) + 5^2\left(\frac{2}{15}\right)$
 $E(Z^2) = 0 + \frac{3}{15} + \frac{12}{15} + \frac{18}{15} + \frac{32}{15} + \frac{50}{15}$
 $E(Z^2) = \frac{115}{15} = \frac{23}{3}$

$$\text{Var}(Z) = E(Z^2) - [E(Z)]^2$$

$$\text{Var}(Z) = \frac{23}{3} - \left(\frac{11}{5}\right)^2$$

$$\text{Var}(Z) = \frac{23}{3} - \frac{121}{25}$$

$$\text{Var}(Z) = \frac{575}{75} - \frac{363}{75}$$

$$\text{Var}(Z) = \frac{212}{75} = 2.8267$$

$$\text{SD}(Z) = \sqrt{\frac{212}{75}} \approx 1.6813$$

$$\text{c } \mu - 2\sigma = \frac{11}{5} - 2(1.6813) = -1.1626$$

$$\mu + 2\sigma = \frac{11}{5} + 2(1.6813) = 5.5626$$

$$\Pr(\mu - 2\sigma \leq Z \leq \mu + 2\sigma) = \Pr(-1.1626 \leq Z \leq 5.5626) = 1$$

10 a

z	0	1	2	3	4	5
$\Pr(Z = z)$	m	m	m	m	n	n

$$\sum_{\text{all } z} \Pr(Z = z) = 1$$

$$4m + 2n = 1 \quad [1]$$

$$\Pr(Z \leq 3) = \Pr(Z \geq 4)$$

$$4m = 2n$$

$$2m = n \quad [2]$$

Substitute [2] into [1]:

$$4m + 2(2m) = 1$$

$$4m + 4m = 1$$

$$8m = 1$$

$$m = \frac{1}{8}$$

Substitute $m = \frac{1}{8}$ into [2]:

$$2\left(\frac{1}{8}\right) = n$$

$$n = \frac{1}{4}$$

$$\text{b i } E(Z) = 0\left(\frac{1}{8}\right) + 1\left(\frac{1}{8}\right) + 2\left(\frac{1}{8}\right) + 3\left(\frac{1}{8}\right) + 4\left(\frac{1}{4}\right) + 5\left(\frac{1}{4}\right)$$

$$E(Z) = 0 + \frac{1}{8} + \frac{2}{8} + \frac{3}{8} + \frac{8}{8} + \frac{10}{8}$$

$$E(Z) = \frac{24}{8} = 3$$

$$\text{ii } E(Z^2) = 0^2\left(\frac{1}{8}\right) + 1^2\left(\frac{1}{8}\right) + 2^2\left(\frac{1}{8}\right) + 3^2\left(\frac{1}{8}\right) + 4^2\left(\frac{1}{4}\right) + 5^2\left(\frac{1}{4}\right)$$

$$E(Z^2) = 0 + \frac{1}{8} + \frac{4}{8} + \frac{9}{8} + \frac{32}{8} + \frac{50}{8}$$

$$E(Z^2) = \frac{96}{8} = 12$$

$$\text{Var}(Z) = E(Z^2) - [E(Z)]^2$$

$$\text{Var}(Z) = 12 - 3^2 = 3$$

$$\text{c } \text{SD}(Z) = \sqrt{3} = 1.732$$

$$\mu - 2\sigma = 3 - 2(1.732) = -0.464$$

$$\mu + 2\sigma = 3 + 2(1.732) = 6.464$$

$$\Pr(\mu - 2\sigma \leq Z \leq \mu + 2\sigma) = \Pr(-0.464 \leq Z \leq 6.464) = 1$$

$$11 \text{ a } \sum_{\text{all } x} \Pr(X = x) = 1$$

$$\begin{aligned} \frac{k^2}{4} + \frac{5k-1}{12} + \frac{3k-1}{12} + \frac{4k-1}{12} &= 1 \\ 3k^2 + 5k - 1 + 3k - 1 + 4k - 1 &= 12 \\ 3k^2 + 12k - 3 &= 12 \\ 3k^2 + 12k - 15 &= 0 \\ k^2 + 4k - 5 &= 0 \\ (k+5)(k-1) &= 0 \end{aligned}$$

$$k = -5, k = 1$$

$k = -5$ is not applicable.

$$\therefore k = 1$$

x	0	1	2	3
$\Pr(X = x)$	$\frac{3}{12} = \frac{1}{4}$	$\frac{4}{12} = \frac{1}{3}$	$\frac{2}{12} = \frac{1}{6}$	$\frac{3}{12}$

$$\begin{aligned} \text{b } E(X) &= 0 \left(\frac{3}{12} \right) + 1 \left(\frac{4}{12} \right) + 2 \left(\frac{2}{12} \right) + 3 \left(\frac{3}{12} \right) \\ &= 0 + \frac{4}{12} + \frac{4}{12} + \frac{9}{12} = \frac{17}{12} = 1.4 \end{aligned}$$

$$\text{c } \Pr(X < 1.4) = \Pr(X = 0) + \Pr(X = 1) = \frac{3}{12} + \frac{4}{12} = \frac{7}{12}$$

12 a

Money	\$1000	\$15 000	\$50 000	\$100 000	\$200 000
Probability	$\frac{1}{5}$	$\frac{1}{5}$	$\frac{1}{5}$	$\frac{1}{5}$	$\frac{1}{5}$

E(Bank offer) is

$$\begin{aligned} &= 1000 \left(\frac{1}{5} \right) + 15\,000 \left(\frac{1}{5} \right) + 50\,000 \left(\frac{1}{5} \right) + 100\,000 \left(\frac{1}{5} \right) + 200\,000 \left(\frac{1}{5} \right) \\ &= \$73\,200 \end{aligned}$$

b

Money	\$1000	\$15 000	\$50 000	\$200 000
Probability	$\frac{1}{4}$	$\frac{1}{4}$	$\frac{1}{4}$	$\frac{1}{4}$

E(Bank offer) is

$$\begin{aligned} &= 1000 \left(\frac{1}{4} \right) + 15\,000 \left(\frac{1}{4} \right) + 50\,000 \left(\frac{1}{4} \right) + 200\,000 \left(\frac{1}{4} \right) \\ &= \$66\,500 \end{aligned}$$

13 a

Autobiography	Cost	Probability	Cookbook	Cost	Probability
New	\$65	0.40	New	\$54	0.40
Good used	\$30	0.30	Good used	\$25	0.25
Worn used	\$12	0.30	Worn used	\$15	0.35

$$\text{New autobiography} + \text{new cookbook } \$65 + \$54 = \$119 \quad 0.4 \times 0.40 = 0.16$$

$$\text{New autobiography} + \text{good cookbook } \$65 + \$25 = \$90 \quad 0.4 \times 0.25 = 0.10$$

$$\text{New autobiography} + \text{worn cookbook } \$65 + \$15 = \$80 \quad 0.4 \times 0.35 = 0.14$$

$$\text{Good autobiography} + \text{new cookbook } \$30 + \$54 = \$84 \quad 0.3 \times 0.40 = 0.12$$

$$\text{Good autobiography} + \text{good cookbook } \$30 + \$25 = \$55 \quad 0.3 \times 0.25 = 0.075$$

$$\text{Good autobiography} + \text{worn cookbook } \$30 + \$15 = \$45 \quad 0.3 \times 0.35 = 0.105$$

$$\text{Worn autobiography} + \text{new cookbook } \$12 + \$54 = \$66 \quad 0.3 \times 0.40 = 0.12$$

$$\text{Worn autobiography} + \text{good cookbook } \$12 + \$25 = \$37 \quad 0.3 \times 0.25 = 0.075$$

$$\text{Worn autobiography} + \text{worn cookbook } \$12 + \$15 = \$27 \quad 0.3 \times 0.35 = 0.105$$

X = cost of two books

x	\$119	\$90	\$84	\$80	\$66	\$55	\$45	\$37	\$27
$\Pr(X = x)$	0.16	0.10	0.12	0.14	0.12	0.075	0.105	0.075	0.105

b $E(X) = 119(0.16) + 90(0.1) + 84(0.12) + 80(0.14) + 66(0.12) + 55(0.075) + 45(0.105) + 37(0.075) + 27(0.105) = \71.70

14 a Let Y be the net profit per day.

y	-\$120	\$230	\$580	\$930
$\Pr(Y = y)$	0.3	0.4	0.2	0.1

b $E(Y) = -120(0.3) + 230(0.4) + 580(0.2) + 930(0.1)$

$E(Y) = \$265$

c $E(Y^2) = (-120)^2(0.3) + 230^2(0.4) + 580^2(0.2) + 930^2(0.1)$

$E(Y^2) = 179\,250$

$\text{Var}(Y) = E(Y^2) - [E(Y)]^2$

$\text{Var}(Y) = 179\,250 - 265^2$

$\text{Var}(Y) = 109\,025$

$\text{SD}(Y) = \sqrt{109\,025} = \330

$\mu - 2\sigma = 265 - 2(330) = -\395

$\mu + 2\sigma = 265 + 2(330) = \925

$\Pr(\mu - 2\sigma \leq Y \leq \mu + 2\sigma) = \Pr(-\$395 \leq Y \leq \$925)$

$\Pr(\mu - 2\sigma \leq Y \leq \mu + 2\sigma) = 1 - \Pr(Y = \$930)$

$\Pr(\mu - 2\sigma \leq Y \leq \mu + 2\sigma) = 1 - 0.1 = 0.9$

15 a Coin: $\Pr(H) = \frac{3}{4}$ and $\Pr(T) = \frac{1}{4}$

Die: $\Pr(1) = \frac{1}{12}$, $\Pr(2) = \frac{1}{12}$, $\Pr(3) = \frac{1}{4}$, $\Pr(4) = \frac{1}{4}$, $\Pr(5) = \frac{1}{12}$, $\Pr(6) = \frac{1}{4}$

$E = \left\{ \overbrace{1H}^5, \overbrace{2H}^5, \overbrace{3H}^1, \overbrace{4H}^1, \overbrace{5H}^5, \overbrace{6H}^1, \overbrace{1T}^{10}, \overbrace{2T}^{10}, \overbrace{3T}^1, \overbrace{4T}^1, \overbrace{5T}^{10}, \overbrace{6T}^1 \right\}$

$\Pr(10) = \Pr(1T, 2T, 5T) = \left(\frac{1}{12} \times \frac{1}{4}\right) + \left(\frac{1}{12} \times \frac{1}{4}\right) + \left(\frac{1}{12} \times \frac{1}{4}\right) = \frac{3}{48} = \frac{1}{16}$

$\Pr(5) = \Pr(1H, 2H, 5H) = \left(\frac{1}{12} \times \frac{3}{4}\right) + \left(\frac{1}{12} \times \frac{3}{4}\right) + \left(\frac{1}{12} \times \frac{3}{4}\right) = \frac{9}{48} = \frac{3}{16}$

$\Pr(1) = \Pr(3H, 3T, 4H, 4T, 6H, 6T)$

$= \left(\frac{1}{4} \times \frac{3}{4}\right) + \left(\frac{1}{4} \times \frac{1}{4}\right) + \left(\frac{1}{4} \times \frac{3}{4}\right) + \left(\frac{1}{4} \times \frac{1}{4}\right) + \left(\frac{1}{4} \times \frac{3}{4}\right) + \left(\frac{1}{4} \times \frac{1}{4}\right)$

$= 3 \left(\frac{3}{16}\right) + 3 \left(\frac{1}{16}\right)$

$= \frac{12}{16}$

x	1	5	10
$\Pr(X = x)$	$\frac{12}{16} = \frac{3}{4}$	$\frac{3}{16}$	$\frac{1}{16}$

b $E(X) = 1 \left(\frac{12}{16}\right) + 5 \left(\frac{3}{16}\right) + 10 \left(\frac{1}{16}\right) = \frac{12}{16} + \frac{15}{16} + \frac{10}{16} = \frac{37}{16} = 2.3$

c $E(25 \text{ tosses}) = 25 \times 2.3125 = 57.8$

d Let n be the number of tosses.

$2.3125n = 100$

$n = \frac{100}{2.3125} = 43.243$

The minimum number of tosses required is 44.

16

	<i>M</i>	<i>M'</i>	
<i>N</i>	0.216	0.264	0.480
<i>N'</i>	0.234	0.286	0.520
	0.450	0.550	1.000

- a As *M* and *N* are independent,
 $\Pr(M \cap N) = \Pr(M) \Pr(N) = 0.45 \times 0.48 = 0.216$
- b $\Pr(M' \cap N') = 0.286$
- c *Y* is the number of times *M* and *N* occur. $Y = \{0, 1, 2\}$
 $\Pr(Y = 0) = 0.286$
 $\Pr(Y = 1) = 0.264 + 0.234 = 0.498$
 $\Pr(Y = 2) = 0.216$

<i>y</i>	0	1	2
$\Pr(Y = y)$	0.286	0.498	0.216

- d i $E(Y) = 0(0.286) + 1(0.498) + 2(0.216)$
 $= 0 + 0.498 + 0.432 = 0.93$
- ii $E(Y^2) = 0^2(0.286) + 1(0.498) + 2^2(0.216)$
 $= 0 + 0.498 + 0.864 = 1.362$
 $\text{Var}(Y) = E(Y^2) - [E(Y)]^2$
 $\text{Var}(Y) = 1.362 - 0.93^2$
 $\text{Var}(Y) = 0.4971$
- iii $\text{SD}(Y) = \sqrt{0.4971} = 0.7050$

9.5 Exam questions

- 1 $\text{Var}(X) = E(X^2) - [E(X)]^2$
 $= 250 - 15^2$
 $= 25$
 $\text{SD}(X) = \sqrt{\text{Var}(X)}$
 $= \sqrt{25}$
 $= 5$ [1 mark]
- $\Pr(\mu - 2\sigma \leq X \leq \mu + 2\sigma) \approx 0.95$
 $\mu - 2\sigma = 15 - 2 \times 5$
 $= 5$
 $\mu + 2\sigma = 15 + 2 \times 5$
 $= 25$ [1 mark]
- $\therefore x_1 = 5, x_2 = 25$
- 2 $E(X) = 1 \times \frac{3}{20} + 2 \times \frac{4}{20} + 3 \times \frac{6}{20} + 4 \times \frac{2}{20}$
 $= \frac{37}{20}$
 $= 1.85$

The correct answer is A.

- 3 a $\Pr(V \cup W) = 0.7725$ and $\Pr(V \cap W) = 0.2275$.
 $\Pr(V \cup W) = \Pr(W) + \Pr(V) - \Pr(W \cap V)$
 $0.7725 = \Pr(W) + \Pr(V) - 0.2275$
 $1.0000 = \Pr(W) + \Pr(V)$ [1] [1 mark]
- V* and *W* are independent events.
 $\Pr(W \cap V) = \Pr(W) \Pr(V)$
 $0.2275 = \Pr(W) \Pr(V)$
 $\frac{0.2275}{\Pr(W)} = \Pr(V)$ [2] [1 mark]
- Substitute [2] into [1]:

$$1 = \frac{0.2275}{\Pr(W)} + \Pr(W)$$

$$\Pr(W) = 0.2275 + [\Pr(W)]^2$$

$$0 = [\Pr(W)]^2 - \Pr(W) + 0.2275$$

$$\Pr(W) = 0.65 \text{ or } 0.35$$

But $\Pr(V) < \Pr(W)$, so $\Pr(W) = 0.65$ and $\Pr(V) = 0.35$.
 [1 mark]

b

	<i>W</i>	<i>M'</i>	
<i>V</i>	0.2275	0.1225	0.35
<i>V'</i>	0.4225	0.2275	0.65
	0.35	0.65	1.000

[1 mark]

Note: $\Pr(V' \cap W') = 0.2275$

c

<i>x</i>	0	1	2
$\Pr(X = x)$	0.2275	0.5450	0.2275

[1 mark]

- d i $E(X) = 0(0.2275) + 1(0.545) + 2(0.2275) = 1$ [1 mark]
- ii $E(X^2) = 0^2(0.2275) + 1^2(0.545) + 2^2(0.2275)$
 $= 0 + 0.545 + 0.91 = 1.455$
 $\text{Var}(X) = E(X^2) - [E(X)]^2$
 $\text{Var}(X) = 1.455 - 1^2$
 $\text{Var}(X) = 0.455$ [1 mark]
- iii $\text{SD}(X) = \sqrt{0.455} = 0.6745$ [1 mark]

9.6 Review

9.6 Exercise

Technology free: short answer

- 1 a $\Pr(X \geq 2 | X \leq 3) = \frac{\Pr(X \geq 2) \cap \Pr(X \leq 3)}{\Pr(X \leq 3)}$
 $= \frac{\Pr(X = 2) + \Pr(X = 3)}{\Pr(X \leq 3)}$
 $= \frac{0.4 + 0.1}{1 - \Pr(X = 4)}$
 $= \frac{0.5}{1 - 0.1}$
 $= \frac{5}{9}$
- b $E(X) = 0(0.1) + 1(0.3) + 2(0.4) + 3(0.1) + 4(0.1)$
 $= 0 + 0.3 + 0.8 + 0.3 + 0.4$
 $= 1.8$
- 2 a $E(Y) = 0(0.05) + 2(0.4) + 4(0.2) + 6(0.15) + 8(0.15) + 10(0.05)$
 $E(Y) = 0 + 0.8 + 0.8 + 0.9 + 1.2 + 0.5$
 $E(Y) = 4.2$
- b Probability that Garish receives no texts on four consecutive days
 $= (0.05)^4 = 0.000\,006\,25$ or $\left(\frac{1}{20}\right)^4 = \frac{1}{160\,000}$
- c We need to find the combinations for when text messages are sent a total of 10 times in the two days.
 Ten text messages are received as
 (0, 10), (10, 0), (2, 8), (8, 2), (4, 6), (6, 4).

$$\begin{aligned} \Pr(10 \text{ text messages}) &= \Pr(0, 10) + \Pr(10, 0) + \Pr(2, 8) \\ &\quad + \Pr(8, 2) + \Pr(4, 6) + \Pr(6, 4) \\ &= (0.05 \times 0.05) + (0.05 \times 0.05) \\ &\quad + (0.4 \times 0.15) + (0.15 \times 0.4) \\ &\quad + (0.2 \times 0.15) + (0.15 \times 0.2) \\ &= 0.0025 + 0.0025 + 0.06 + 0.06 \\ &\quad + 0.03 + 0.03 \\ &= 0.185 \end{aligned}$$

$$3 \text{ a } \Pr(H) = a \Pr(T) = 1 - a$$

$$\text{i } \Pr(TTTT) = (1 - a)^4$$

$$\begin{aligned} \text{ii } \Pr(HTTT) + \Pr(THTT) + \Pr(TTHT) + \Pr(TTTH) \\ &= a(1 - a)^3 + a(1 - a)^3 + a(1 - a)^3 + a(1 - a)^3 \\ &= 4a(1 - a)^3 \end{aligned}$$

$$\text{b } \Pr(\text{Four Tails}) = \Pr(\text{Three Tails})$$

$$(1 - a)^4 = 4a(1 - a)^3$$

$$(1 - a)^4 - 4a(1 - a)^3 = 0$$

$$(1 - a)^3(1 - a - 4a) = 0$$

$$(1 - a)^3(1 - 5a) = 0$$

$$(1 - a)(1 + a + a^2)(1 - 5a) = 0$$

$$1 - a = 0 \quad \text{or} \quad 1 - 5a = 0 \quad \text{as} \quad 1 + a + a^2 \neq 0$$

$$\text{for } 0 < a < 1$$

$$a = 1 \quad \quad \quad 1 = 5a$$

$$a = \frac{1}{5}$$

$$\therefore a = \frac{1}{5}, \text{ as } 0 < a < 1$$

$$\begin{aligned} 4 \text{ a } E(X) &= 1 \left(\frac{1}{5}\right) + 3 \left(\frac{1}{5}\right) + 5 \left(\frac{1}{5}\right) + 7 \left(\frac{1}{5}\right) + 9 \left(\frac{1}{5}\right) \\ &= \frac{1}{5} + \frac{3}{5} + \frac{5}{5} + \frac{7}{5} + \frac{9}{5} \\ &= \frac{25}{5} \\ &= 5 \end{aligned}$$

$$\begin{aligned} \text{b } E(X^2) &= 1^2 \left(\frac{1}{5}\right) + 3^2 \left(\frac{1}{5}\right) + 5^2 \left(\frac{1}{5}\right) + 7^2 \left(\frac{1}{5}\right) + 9^2 \left(\frac{1}{5}\right) \\ &= \frac{1}{5} + \frac{9}{5} + \frac{25}{5} + \frac{49}{5} + \frac{81}{5} \\ &= \frac{165}{5} \\ &= 33 \end{aligned}$$

$$\begin{aligned} \text{Var}(X) &= E(X^2) - [E(X)]^2 \\ &= 33 - 5^2 \\ &= 8 \end{aligned}$$

$$\begin{aligned} \text{c } E(3X + 1) &= 3E(X) + 1 \\ &= 3(5) + 1 \\ &= 16 \end{aligned}$$

$$\begin{aligned} \text{d } \text{Var}(5X + 2) &= 5^2 \text{Var}(X) \\ &= 25(8) \\ &= 200 \end{aligned}$$

$$5 \text{ a } \text{Let } X \text{ be how much money is won.}$$

There are only 3 options: $X = 0, X = 2, X = 5$.

Firstly,

$$\begin{aligned} \Pr(X = 0) &= \Pr(\text{yellow}) \\ &= 1 - \Pr(\text{red}) - \Pr(\text{blue}) - \Pr(\text{green}) \\ &= 1 - \frac{1}{20} - \frac{2}{20} - \frac{2}{20} \\ &= \frac{3}{4} \end{aligned}$$

Secondly,

$$\begin{aligned} \Pr(X = 2) &= \Pr(\text{blue}) + \Pr(\text{green}) \\ &= \frac{2}{20} + \frac{2}{20} \\ &= \frac{4}{20} \\ &= \frac{1}{5} \end{aligned}$$

Lastly,

$$\begin{aligned} \Pr(X = 5) &= \Pr(\text{red}) \\ &= \frac{1}{20} \end{aligned}$$

$$\begin{aligned} \text{b } E(X) &= \frac{3}{4} \times 0 + \frac{1}{5} \times 2 + \frac{1}{20} \times 5 \\ &= 0.65 \end{aligned}$$

Therefore, the expected amount is \$0.65.

$$\begin{aligned} 6 \text{ a } \text{Var}(X) &= 1.1^2 \\ &= 1.21 \end{aligned}$$

$$\begin{aligned} \text{b } \text{Var}(X) &= E(X^2) - [E(X)]^2 \\ 1.21 &= 2.02 - [E(X)]^2 \\ [E(X)]^2 &= 2.02 - 1.21 \\ &= 0.81 \\ E(X) &= 0.9 \end{aligned}$$

$$\begin{aligned} \text{c } E(2X - 4) &= 2 \times E(X) - 4 \\ &= 2 \times 0.9 - 4 \\ &= -2.2 \end{aligned}$$

$$\begin{aligned} \text{d } \text{Var}(2X - 4) &= 2^2 \times \text{Var}(X) \\ &= 4 \times 1.21 \\ &= 4.84 \end{aligned}$$

Technology active: multiple choice

$$\begin{aligned} 7 \quad \sum_{\text{all } x} \Pr(X = x) &= 1 \\ 2a + 3a + 4a + 5a + 6a &= 1 \\ 20a &= 1 \\ a &= \frac{1}{20} \end{aligned}$$

The correct answer is **B**.

8 The volume of soft drink consumed by a family over the period of a week. (This is the only option where data can take infinitely many values.)

The correct answer is **C**.

9 $E(Z) = 1(0.1) + 2(0.25) + 3(0.35) + 4(0.24) + 5(0.05) = 2.9$
The correct answer is **A**.

$$\begin{aligned} 10 \quad E(Z^2) &= 1^2(0.1) + 2^2(0.25) + 3^2(0.35) + 4^2(0.25) + 5^2(0.05) \\ &= 0.1 + 1 + 3.15 + 4 + 1.25 \\ &= 9.5 \end{aligned}$$

$$\begin{aligned}\text{Var}(Z) &= E(Z^2) - [E(Z)]^2 \\ \text{Var}(Z) &= 9.5 - 2.9^2 \\ &= 1.09\end{aligned}$$

The correct answer is **C**.

11 $\text{SD}(Z) = \sqrt{1.09} = 1.044$
The correct answer is **D**.

12 $\sum_{\text{all } x} \text{Pr}(X = x) = 1$

$$\begin{aligned}m + n + 0.7 &= 1 \\ m + n &= 0.3 & [1] \\ E(X) &= 3.2 \\ 0(m) + 2(n) + 4(0.7) &= 3.2 \\ 2n + 2.8 &= 3.2 \\ 2n &= 0.4 \\ n &= 0.2 & [2]\end{aligned}$$

Substitute [2] into [1]:

$$\begin{aligned}m + 0.2 &= 0.3 \\ m &= 0.1\end{aligned}$$

The correct answer is **C**.

13 Mean = $1(0.1) + 2(0.3) + 3(0.3) + 4(0.2) + 5(0.1)$
 $= 2.9$

$$\begin{aligned}E(\text{number}^2) &= 1^2(0.1) + 2^2(0.3) + 3^2(0.3) + 4^2(0.2) + 5^2(0.1) \\ &= 0.1 + 1.2 + 2.7 + 3.2 + 2.5 \\ &= 9.7\end{aligned}$$

$$\begin{aligned}\text{Var}(\text{number}^2) &= E(\text{number}^2) - [E(\text{number}^2)]^2 \\ &= 9.7 - 2.9^2 \\ &= 1.29\end{aligned}$$

$$\begin{aligned}\text{SD} &= \sqrt{1.29} \\ &= 1.14\end{aligned}$$

The correct answer is **E**.

14 $E(X) = 2.1$ and $\text{Var}(X) = 1.3$

$$\begin{aligned}E(2X + 1) &= 2E(X) + 1 \\ &= 2(2.1) + 1 \\ &= 5.2\end{aligned}$$

$$\begin{aligned}\text{Var}(2X + 1) &= 2^2 \text{Var}(X) \\ &= 4(1.3) \\ &= 5.2\end{aligned}$$

The correct answer is **C**.

15 $E(Y) = -2(2p) + 0(3p) + 2(1 - 5p)$

$$E(Y) = -4p + 0 + 2 - 10p$$

$$E(Y) = 2 - 14p$$

The correct answer is **B**.

16 $\sum_{\text{all } x} \text{Pr}(X = x) = 1$

$$\begin{aligned}m + m + n + 3m + m - n &= 1 \\ 6m &= 1 \\ m &= \frac{1}{6}\end{aligned}$$

$$E(X) = 0.4$$

$$-1(m) + 0(m + n) + 1(3m) + 2(m - n) = 0.4$$

$$-m + 0 + 3m + 2m - 2n = 0$$

$$4m - 2n = 0.4$$

$$2m - n = 0.2$$

Substitute $m = \frac{1}{6}$ into the equation.

$$\begin{aligned}2\left(\frac{1}{6}\right) - n &= 0.2 \\ \frac{1}{3} - n &= \frac{1}{5} \\ \frac{5}{15} - \frac{3}{15} &= n \\ n &= \frac{2}{15}\end{aligned}$$

The correct answer is **C**.

Technology active: extended response

17 a $\text{Pr}(\text{total of } 11) = \text{Pr}(5, 6) + \text{Pr}(6, 5)$

$$\begin{aligned}\text{Pr}(\text{total of } 11) &= \frac{2m}{5} \times \frac{1}{10}(5 - 6m) + \frac{1}{10}(5 - 6m) \times \frac{2m}{5} \\ &= \frac{2m}{25}(5 - 6m) \\ &= \frac{10m - 12m^2}{25} \text{ as required}\end{aligned}$$

b The chance is a maximum when $\frac{d\text{Pr}(\text{total of } 11)}{dm} = 0$.

$$\frac{d\text{Pr}(\text{total of } 11)}{dm} = \frac{10}{25} - \frac{24}{25}m$$

$$\frac{10}{25} - \frac{24}{25}m = 0$$

$$10 - 24m = 0$$

$$10 = 24m$$

$$\frac{10}{24} = m$$

$$m = \frac{5}{12}$$

$$\text{Pr}(\text{total of } 11) = \frac{10\left(\frac{5}{12}\right) - 12\left(\frac{5}{12}\right)^2}{25}$$

$$= \left(\frac{25}{6} - \frac{25}{12}\right) \times \frac{1}{25}$$

$$= \frac{1}{6} - \frac{1}{12}$$

$$= \frac{1}{12}$$

z	1	2	3	4	5	6
$\text{Pr}(Z = z)$	$\frac{1}{12}$	$\frac{1}{6}$	$\frac{1}{6}$	$\frac{1}{6}$	$\frac{1}{6}$	$\frac{1}{4}$

c i $E(Z) = 1\left(\frac{1}{12}\right) + 2\left(\frac{1}{6}\right) + 3\left(\frac{1}{6}\right) + 4\left(\frac{1}{6}\right)$

$$+ 5\left(\frac{1}{6}\right) + 6\left(\frac{1}{4}\right)$$

$$= \frac{1}{12} + \frac{2}{6} + \frac{3}{6} + \frac{4}{6} + \frac{5}{6} + \frac{6}{4}$$

$$= \frac{47}{12}$$

$$= 3.9167$$

$$E(Z^2) = 1^2\left(\frac{1}{12}\right) + 2^2\left(\frac{1}{6}\right) + 3^2\left(\frac{1}{6}\right) + 4^2\left(\frac{1}{6}\right)$$

$$+ 5^2\left(\frac{1}{6}\right) + 6^2\left(\frac{1}{4}\right)$$

$$= \frac{217}{12}$$

$$\begin{aligned} \text{Var}(Z) &= E(Z^2) - [E(Z)]^2 \\ &= \frac{217}{12} - \left(\frac{47}{12}\right)^2 \\ &= 2.7431 \\ \text{SD}(Z) &= \sqrt{2.7431} \\ &= 1.6562 \end{aligned}$$

ii $\mu - 2\sigma = 3.9167 - 2(1.6562) = 0.6043$
 $\mu + 2\sigma = 3.9167 + 2(1.6562) = 7.2291$
 $\Pr(\mu - 2\sigma \leq Z \leq \mu + 2\sigma) = \Pr(0.6043 \leq Z \leq 7.2291)$
 $= \Pr(1 \leq Z \leq 7)$
 $= 1$

18 a $E(X) = 10(0.07) + 11(0.12) + 12(0.12) + 13(0.1)$
 $+ 14(0.1) + 15(0.1) + 16(0.1) + 17(0.08)$
 $+ 18(0.08) + 19(0.08) + 20(0.05)$
 $= 14.58$

b $E(X^2) = 10^2(0.07) + 11^2(0.12) + 12^2(0.12) + 13^2(0.1)$
 $+ 14^2(0.1) + 15^2(0.1) + 16^2(0.1) + 17^2(0.08)$
 $+ 18^2(0.08) + 19^2(0.08) + 20^2(0.05)$
 $= 221.32$
 $\text{Var}(X) = E(X^2) - [E(X)]^2$
 $= 221.32 - 14.58^2$
 $= 8.7436$
 $\text{SD}(X) = \sqrt{8.7436}$
 $= 2.9570$

c $\Pr(B = 0) = 0.07 + 0.12 + 0.12$
 $\Pr(B = 0) = 0.31$
 $\Pr(B = 120) = 0.1 + 0.1 + 0.1 + 0.1$
 $\Pr(B = 120) = 0.4$
 $\Pr(B = 250) = 0.08 + 0.08 + 0.08 + 0.05$
 $\Pr(B = 250) = 0.29$

Bonus b	\$0	\$120	\$250
$\Pr(B = b)$	0.31	0.40	0.29

d $E(B) = 0(0.31) + 120(0.40) + 250(0.29)$
 $= \$120.50$

19 a $E(X) = 0(0.37) + 1(0.22) + 2(0.21) + 3(0.1) + 4(0.05)$
 $+ 5(0.05)$
 $= 0 + 0.22 + 0.42 + 0.3 + 0.2 + 0.25$
 $= 1.39$

b $E(X^2) = 0^2(0.37) + 1^2(0.22) + 2^2(0.21) + 3^2(0.1)$
 $+ 4^2(0.05) + 5^2(0.05)$
 $= 0 + 0.22 + 0.84 + 0.9 + 0.8 + 1.25$
 $= 4.01$
 $\text{Var}(X) = E(X^2) - [E(X)]^2$
 $= 4.01 - 1.39^2$
 $= 2.0779$
 $\text{SD}(X) = \sqrt{2.0779}$
 $= 1.4415$

c $\mu - 2\sigma = 1.39 - 2(1.4415) = -1.493$
 $\mu + 2\sigma = 1.39 + 2(1.4415) = 4.273$
 $\Pr(\mu - 2\sigma \leq X \leq \mu + 2\sigma) = \Pr(-1.493 \leq X \leq 4.273)$
 $= \Pr(0 \leq X \leq 4)$
 $= 1 - \Pr(X = 5)$
 $= 1 - 0.05$
 $= 0.95$

d $\Pr(T = 0) = \Pr(X = 3) + \Pr(X = 4) + \Pr(X = 5)$
 $\Pr(T = 0) = 0.1 + 0.05 + 0.05$
 $\Pr(T = 0) = 0.2$
 $\Pr(T = 1) = \Pr(X = 1) + \Pr(X = 2)$
 $= 0.22 + 0.21$
 $= 0.43$
 $\Pr(T = 2.50) = \Pr(X = 0)$
 $= 0.37$

t	\$0	\$1	\$2.50
$\Pr(T = t)$	0.2	0.43	0.37

e $E(T) = 0(0.2) + 1(0.43) + 2.5(0.37)$
 $= 0 + 0.43 + 0.925$
 $= 1.355$
 $= \$1.36$

f $E(T^2) = 0^2(0.2) + 1^2(0.43) + (2.5)^2(0.37)$
 $= 0 + 0.43 + 2.3125$
 $= 2.7425$

$\text{Var}(T) = E(T^2) - [E(T)]^2$
 $= 2.7425 - 1.355^2$
 $= 0.9065$

$\text{SD}(X) = \sqrt{0.9065}$
 $= 0.9521$

$\mu - 2\sigma = 1.355 - 2(0.9521) = -0.5492$
 $\mu + 2\sigma = 1.355 + 2(0.9521) = 3.2592$

$\Pr(\mu - 2\sigma \leq X \leq \mu + 2\sigma) = \Pr(-0.5492 \leq X \leq 3.2592)$
 $= \Pr(T = 0) + \Pr(T = 1) + \Pr(T = 2.5)$
 $= 0.2 + 0.43 + 0.37$
 $= 1$

20 a $\sum_{\text{all } Z} \Pr(Z = z) = 1$

$4m + 3n = 1$ [1]

$2\Pr(0 < Z < 2) = \Pr(3 < Z < 6)$

$2\Pr(Z = 1) = \Pr(Z = 4) + \Pr(Z = 5) + \Pr(Z = 6)$

$2n = 2m + n$

$n = 2m$ [2]

Substitute [2] into [1]:

$4m + 3(2m) = 1$

$10m = 1$

$m = \frac{1}{10}$

Substitute $m = \frac{1}{10}$ into [2]:

$n = 2\left(\frac{1}{10}\right) = \frac{1}{5}$

b	z	0	1	2	3	4	5	6
	$\Pr(Z = z)$	$m = \frac{1}{10}$	$n = \frac{1}{5}$	$\frac{1}{10}$	$\frac{1}{5}$	$\frac{1}{10}$	$\frac{1}{5}$	$\frac{1}{10}$

$$\begin{aligned}
 E(Z) &= 0 \left(\frac{1}{10} \right) + 1 \left(\frac{1}{5} \right) + 2 \left(\frac{1}{10} \right) + 3 \left(\frac{1}{5} \right) + 4 \left(\frac{1}{10} \right) + 5 \left(\frac{1}{5} \right) + 6 \left(\frac{1}{10} \right) \\
 &= 0 + \frac{2}{10} + \frac{2}{10} + \frac{6}{10} + \frac{4}{10} + \frac{10}{10} + \frac{6}{10} \\
 &= \frac{30}{10} \\
 &= 3
 \end{aligned}$$

$$\begin{aligned}
 \text{c } E(Z^2) &= 0^2 \left(\frac{1}{10} \right) + 1^2 \left(\frac{1}{5} \right) + 2^2 \left(\frac{1}{10} \right) + 3^2 \left(\frac{1}{5} \right) + 4^2 \left(\frac{1}{10} \right) + 5^2 \left(\frac{1}{5} \right) + 6^2 \left(\frac{1}{10} \right) \\
 &= 0 + \frac{2}{10} + \frac{4}{10} + \frac{18}{10} + \frac{16}{10} + \frac{50}{10} + \frac{36}{10} = \frac{126}{10} \\
 &= 12.6 \\
 \text{Var}(Z) &= E(Z^2) - [E(Z)]^2 \\
 &= 12.6 - 3^2 \\
 &= 3.6 \\
 \text{SD}(Z) &= \sqrt{3.6} \\
 &= 1.8974
 \end{aligned}$$

$$\begin{aligned}
 \text{d i } E(2 - 3Z) &= 2 - 3E(Z) \\
 &= 2 - 3(3) \\
 &= -7
 \end{aligned}$$

$$\begin{aligned}
 \text{ii } \text{Var}(2Z - 3) &= 2^2 \text{Var}(Z) \\
 &= 4(3.6) \\
 &= 14.4
 \end{aligned}$$

$$\begin{aligned}
 \text{e } \mu - 2\sigma &= 3 - 2(1.8974) = -0.7948 \\
 \mu + 2\sigma &= 3 + 2(1.8974) = 6.7948 \\
 \Pr(\mu - 2\sigma \leq X \leq \mu + 2\sigma) &= \Pr(-0.7948 \leq X \leq 6.7948) \\
 &= \Pr(0 \leq X \leq 6) \\
 &= 1
 \end{aligned}$$

9.6 Exam questions

1

	A	A'	
B	p^3	$p^2 - p^3$	p^2
B'			$1 - p^2$
	p	$1 - p$	

$$\begin{aligned}
 \Pr(A) &= p, \Pr(B) = p^2 \\
 \Pr(A \cap B) &= \Pr(A) \Pr(B) = p^3 \\
 \Pr(A' \cup B) &= \Pr(A') + \Pr(B) - \Pr(A' \cap B) \\
 &= (1 - p) + p^2 - (p^2 - p^3) \\
 &= 1 - p + p^3
 \end{aligned}$$

The correct answer is **D**.

$$\begin{aligned}
 \text{2 a } \Pr(H) &= \Pr(H \cap B) + \Pr(H \cap B') \\
 &= \Pr(H \cap B') + \Pr(H \cap B) \\
 \Pr(H) &= \frac{1}{2} \times \frac{2}{3} + \frac{1}{3} \times \frac{1}{3} \\
 &= \frac{1}{3} + \frac{1}{9} = \frac{4}{9}
 \end{aligned}$$

Award 1 mark for the setup of probabilities.

Award 1 mark for the correct answers.

VCAA Examination Report note:

As this question was worth two marks, appropriate working was required to be shown. This could include computations or a probability tree diagram with relevant branches clearly identified. In some instances, it was not clear which fractions were being manipulated or how they were manipulated.

$$\mathbf{b} \Pr(\text{unbiased}|\text{H}) = \frac{\Pr(\text{unbiased} \cap \text{H})}{\Pr(\text{H})} = \frac{\frac{1}{2} \times \frac{2}{3}}{\frac{4}{9}} = \frac{\frac{1}{3}}{\frac{4}{9}} = \frac{3}{4}$$

Award 1 mark for the correct probability.

VCAA Examination Report note:

Most students correctly identified the conditional nature of this probability problem. It was noted that many students who did not simplify their answer to part **a** did not carry out the subsequent calculation successfully.

$$\mathbf{3} \sum \Pr(X = x) = a + 4b + 0.2 = 1 \quad [1]$$

$$a + 4b = 0.8 \Rightarrow a = 0.8 - 4b$$

$$\begin{aligned} E(X) &= \sum x \Pr(X = x) \\ &= -a + 5b^2 + 0.8 \\ &= -(0.8 - 4b) + 5b^2 + 0.8 \end{aligned}$$

$$E(X) = 5b^2 + 4b$$

$$\frac{d}{db}(E(X)) = 10b + 4 = 0 \Rightarrow b = -\frac{2}{5}$$

but $0 \leq b \leq 0.2$, $0 \leq a \leq 0.8$ from [1].

Examine end points:

$b = 0$, $a = 0.8$, $E(X) = 0$, smallest

$b = 0.2$, $a = 0$, $E(X) = 1$, largest

The correct answer is **E**.

$$\begin{aligned} \mathbf{4} \quad \sum \Pr(X = x) &= 1 \\ p + 2p + 3p + 4p + 5p &= 15p \\ &= 1 \\ \Rightarrow p &= \frac{1}{15} \end{aligned}$$

$$\begin{aligned} E(X) &= \sum x \Pr(X = x) \\ &= p + 4p + 9p + 16p + 25p \\ &= 55p \\ &= \frac{55}{15} \\ &= \frac{11}{3} \end{aligned}$$

The correct answer is **D**.

$$\begin{aligned} \mathbf{5} \Pr(X < 5 | X < 8) &= \frac{\Pr(X < 5)}{\Pr(X < 8)} \\ &= \frac{1 - \Pr(X > 5)}{1 - \Pr(X > 8)} \\ &= \frac{1 - a}{1 - b} \\ &= \frac{a - 1}{b - 1} \end{aligned}$$

The correct answer is **E**.

Topic 10 — The binomial distribution

10.2 Bernoulli trials

10.2 Exercise

- 1 a This is not a Bernoulli distribution as a successful outcome is not specified.
 b This is a Bernoulli distribution as a success is getting a hole in one and a failure is not getting a hole in one.
 c This is a Bernoulli distribution as a success is withdrawing an ace and a failure is withdrawing any other card.
 d This is a Bernoulli distribution as the arthritis drug is either successful or not.
 e This is a Bernoulli distribution as the child is either a girl or not.
 f This is not a Bernoulli distribution as the probability of success is unknown.
- 2 a The friend does not replace the ball before I choose a ball, so this cannot be a Bernoulli distribution.
 b There are 6 outcomes not 2, so this is not a Bernoulli distribution.
 c The probability of success is unknown, so this is not a Bernoulli distribution.

3 a $E(Z) = p = 0.6$

b $\text{Var}(Z) = pq = 0.6 \times 0.4 = 0.24$

4 a

x	0	1
$\text{Pr}(X = x)$	$\frac{4}{5}$	$\frac{1}{5}$

b $E(X) = p = \frac{1}{5}$

c $\text{Pr}(X = 5) = \left(\frac{1}{5}\right)^5 = 0.00032$

5 a

x	0	1
$\text{Pr}(X = x)$	0.58	0.42

b $E(X) = 0.42$

c $\text{Var}(X) = 0.58 \times 0.42 = 0.2436$
 $\text{SD}(X) = \sqrt{0.2436} = 0.4936$

6

y	0	1
$\text{Pr}(Y = y)$	0.32	0.68

$\text{Var}(Y) = pq = 0.68 \times 0.32 = 0.2176$
 The correct answer is **B**.

7 a

x	0	1
$\text{Pr}(X = x)$	0.11	0.89

b i $E(X) = p = 0.89$

ii $\text{Var}(X) = pq = 0.89 \times 0.11 = 0.0979$

iii $\text{SD}(X) = \sqrt{0.0979} = 0.3129$

c $\mu - 2\sigma = 0.89 - 2(0.3129) = 0.2642$

$\mu + 2\sigma = 0.89 + 2(0.3129) = 1.5158$

$\text{Pr}(\mu - 2\sigma \leq X \leq \mu + 2\sigma) = \text{Pr}(0.2642 \leq X \leq 1.5158)$
 $= \text{Pr}(X = 1)$
 $= 0.89$

8 a

y	0	1
$\text{Pr}(Y = y)$	0.67	0.33

b $\mu = E(Y) = p = 0.33$

c $\text{Var}(Y) = pq = 0.33 \times 0.67 = 0.2211$

$\sigma = \text{SD}(Y) = \sqrt{0.2211} = 0.4702$

$\mu - 2\sigma = 0.33 - 2(0.4702) = -0.6104$

$\mu + 2\sigma = 0.33 + 2(0.4702) = 1.2704$

$\text{Pr}(\mu - 2\sigma \leq Y \leq \mu + 2\sigma) = \text{Pr}(-0.6104 \leq Y \leq 1.2704)$
 $= \text{Pr}(Y = 0) + \text{Pr}(Y = 1)$
 $= 1$

9 a $\text{Var}(X) = p(1 - p) = 0.21$

$p - p^2 = 0.21$

$0 = p^2 - p + 0.21$

Therefore, $p = \frac{1 \pm \sqrt{(-1)^2 - 4(1)(0.21)}}{2(1)}$

$p = \frac{1 \pm \sqrt{1 - 0.84}}{2}$

$p = \frac{1 \pm 0.4}{2}$

$p = 0.3$ or 0.7

But $p > 1 - p$, so $p = 0.7$

b $E(X) = p = 0.7$

10 a $\text{Var}(Z) = p(1 - p) = 0.1075$

$p - p^2 = 0.1075$

$0 = p^2 - p + 0.1075$

$p = 0.1225$ or 0.8775

Since $p > 1 - p$, $p = 0.8775$.

b

z	0	1
$\text{Pr}(Z = z)$	0.1225	0.8775

c $E(Z) = p = 0.8775$

10.2 Exam questions

1 a $\text{Pr}(\text{breast cancer}) = 0.0072$ [1 mark]

b

z	0	1
$\text{Pr}(Z = z)$	0.9928	0.0072

[1 mark]

c $\mu = E(Z) = 0.0072$

$\text{Var}(Z) = pq = 0.0072 \times 0.9928 = 0.0071$

$\sigma = \text{SD}(Z) = \sqrt{0.0071} = 0.0845$ [1 mark]

$\mu - 2\sigma = 0.0072 - 2(0.0845) = -0.1618$

$\mu + 2\sigma = 0.0072 + 2(0.0845) = 0.1762$

$\text{Pr}(\mu - 2\sigma \leq Z \leq \mu + 2\sigma) = \text{Pr}(-0.1618 \leq Z \leq 0.1762)$
 $= \text{Pr}(Z = 0)$
 $= 0.9928$ [1 mark]

2 a $\text{SD}(Y) = 0.4936$

$\text{Var}(Y) = 0.4936^2 = 0.2436$ [1 mark]

b $\text{Var}(Y) = p(1 - p) = 0.2436$

$p - p^2 = 0.2436$

$0 = p^2 - p + 0.2436$

$$\begin{aligned} \text{Therefore, } p &= \frac{1 \pm \sqrt{(-1)^2 - 4(1)(0.21)436}}{2(1)} \\ p &= \frac{1 \pm \sqrt{1 - 0.9744}}{2} \\ p &= \frac{1 \pm 0.16}{2} \\ p &= \frac{0.84}{2} \text{ or } \frac{1.16}{2} \\ p &= 0.42 \text{ or } 0.58 \end{aligned}$$

But $p > 1 - p$ so $p = 0.58$ [1 mark]

c $E(Y) = p = 0.58$ [1 mark]

3 a $SD(Y) = 0.3316$

$$\text{Var}(Y) = 0.3316^2 = 0.11 \quad [1 \text{ mark}]$$

b $\text{Var}(Y) = p(1 - p) = 0.11$

$$p - p^2 = 0.11$$

$$0 = p^2 - p + 0.11$$

$$p = 0.1258 \text{ or } 0.8742 \quad [1 \text{ mark}]$$

Since $p > 1 - p$, $p = 0.8742$. [1 mark]

10.3 The binomial distribution

10.3 Exercise

1 a $X \sim \text{Bi}\left(5, \frac{1}{2}\right)$

$$\begin{aligned} \Pr(X = 3) &= {}^5C_3 \left(\frac{1}{2}\right)^3 \left(\frac{1}{2}\right)^2 \\ &= 10 \times \frac{1}{8} \times \frac{1}{4} \\ &= \frac{10}{32} \\ &= \frac{5}{16} \end{aligned}$$

b $X \sim \text{Bi}\left(5, \frac{1}{2}\right)$

$$\begin{aligned} \Pr(X < 2) &= \Pr(X = 1) + \Pr(X = 0) \\ &= {}^5C_1 \left(\frac{1}{2}\right)^1 \left(\frac{1}{2}\right)^4 + {}^5C_0 \left(\frac{1}{2}\right)^0 \left(\frac{1}{2}\right)^5 \\ &= 5 \times \frac{1}{2} \times \frac{1}{16} + 1 \times 1 \times \frac{1}{32} \\ &= \frac{5}{32} + \frac{1}{32} \\ &= \frac{6}{32} \\ &= \frac{3}{16} \end{aligned}$$

$$\begin{aligned} \text{c } \Pr(\text{LateLateOnOnOn}) &= \frac{1}{2} \times \frac{1}{2} \times \frac{1}{2} \times \frac{1}{2} \times \frac{1}{2} \\ &= \frac{1}{32} \end{aligned}$$

2 $X \sim \text{Bi}\left(4, \frac{1}{4}\right)$

$$\begin{aligned} \text{a } \Pr(X = 4) &= {}^4C_4 \left(\frac{1}{4}\right)^4 \left(\frac{3}{4}\right)^0 \\ &= 1 \times \frac{1}{256} \times 1 \\ &= \frac{1}{256} \end{aligned}$$

$$\begin{aligned} \text{b } \Pr(X \geq 1) &= 1 - \Pr(X = 0) \\ &= 1 - {}^4C_0 \left(\frac{1}{4}\right)^0 \left(\frac{3}{4}\right)^4 \\ &= 1 - 1 \times 1 \times \frac{81}{256} \\ &= \frac{175}{256} \end{aligned}$$

$$\begin{aligned} \text{c } \Pr(X = 2 | X \geq 1) &= \frac{\Pr(X = 2 \cap X \geq 1)}{\Pr(X \geq 1)} \\ &= \frac{\Pr(X = 2)}{\Pr(X \geq 1)} \\ &= \frac{{}^4C_2 \left(\frac{1}{4}\right)^2 \left(\frac{3}{4}\right)^2}{\frac{175}{256}} \\ &= \frac{6 \times \frac{1}{16} \times \frac{9}{16}}{\frac{175}{256}} \\ &= \frac{\frac{54}{256}}{\frac{175}{256}} \\ &= \frac{54}{175} \end{aligned}$$

3 Let Z be the number of offspring with genotype XY.

$$Z \sim \text{Bi}\left(7, \frac{1}{2}\right)$$

$$\Pr(Z = 6) = {}^7C_6 \left(\frac{1}{2}\right) \left(\frac{1}{2}\right)^6 = \frac{7}{128}$$

4 $X \sim \text{Bi}\left(60, \frac{1}{4}\right)$

$$\begin{aligned} \text{a } E(X) &= np \\ &= 60 \times \frac{1}{4} \\ &= 15 \end{aligned}$$

$$\begin{aligned} \text{b } \text{Var}(X) &= np(1 - p) \\ &= 60 \times \frac{1}{4} \times \frac{3}{4} \\ &= \frac{45}{4} \\ &= 11.25 \end{aligned}$$

5 a $E(X) = 16 = np$

$$\begin{aligned} \text{Var}(X) &= np(1 - p) \\ 4 &= np(1 - p) \\ \therefore 4 &= 16(1 - p) \\ 1 - p &= \frac{1}{4} \\ p &= \frac{3}{4} \end{aligned}$$

b $E(X) = np = 16$

$$\begin{aligned} \therefore 16 &= n \times \frac{3}{4} \\ 48 &= 3n \\ n &= 16 \end{aligned}$$

$$6 \text{ a } Y \sim \text{Bi}\left(5, \frac{3}{7}\right)$$

$$\Pr(Y = 0) = \left(\frac{4}{7}\right)^5 = \frac{1024}{16807} = 0.0609$$

$$\Pr(Y = 1) = 5\left(\frac{4}{7}\right)^4\left(\frac{3}{7}\right) = \frac{3840}{16807} = 0.2285$$

$$\Pr(Y = 2) = 10\left(\frac{4}{7}\right)^3\left(\frac{3}{7}\right)^2 = \frac{5760}{16807} = 0.3427$$

$$\Pr(Y = 3) = 10\left(\frac{4}{7}\right)^2\left(\frac{3}{7}\right)^3 = \frac{4320}{16807} = 0.2570$$

$$\Pr(Y = 4) = 5\left(\frac{4}{7}\right)\left(\frac{3}{7}\right)^4 = \frac{1620}{16807} = 0.0964$$

$$\Pr(Y = 5) = \left(\frac{3}{7}\right)^5 = \frac{243}{16807} = 0.0145$$

y	0	1	2	3	4	5
$\Pr(Y = y)$	0.0609	0.2285	0.3427	0.2570	0.0964	0.0145

$$b \Pr(Y \leq 3) = \Pr(Y = 0) + \Pr(Y = 1) + \Pr(Y = 2) + \Pr(Y = 3)$$

$$= \text{binomcdf}\left(5, \frac{3}{7}, 0, 3\right)$$

$$= 0.8892$$

$$c \Pr(Y \geq 1 | Y \leq 3) = \frac{\Pr(Y \geq 1) \cap \Pr(Y \leq 3)}{\Pr(Y \leq 3)}$$

$$= \frac{\Pr(Y = 1) + \Pr(Y = 2) + \Pr(Y = 3)}{0.8891}$$

$$= \frac{0.2285 + 0.3427 + 0.2570}{0.8891}$$

$$= \frac{0.8282}{0.8891}$$

$$= 0.9315$$

$$d \Pr(\text{Miss, Bulls-eye, Miss, Miss}) = \frac{4}{7} \times \frac{3}{7} \times \frac{4}{7} \times \frac{4}{7}$$

$$= 0.0800$$

$$7 \text{ a } Y \sim \text{Bi}(10, 0.42)$$

$$\Pr(Z = 0) = (0.58)^{10} = 0.0043$$

$$\Pr(Z = 1) = 10(0.58)^9(0.42) = 0.0312,$$

$$\Pr(Z = 2) = 45(0.58)^8(0.42)^2 = 0.1017,$$

$$\Pr(Z = 3) = 120(0.58)^7(0.42)^3 = 0.1963$$

$$\Pr(Z = 4) = 210(0.58)^6(0.42)^4 = 0.2488$$

$$\Pr(Z = 5) = 252(0.58)^5(0.42)^5 = 0.2162$$

$$\Pr(Z = 6) = 210(0.58)^4(0.42)^6 = 0.1304$$

$$\Pr(Z = 7) = 120(0.58)^3(0.42)^7 = 0.0540$$

$$\Pr(Z = 8) = 45(0.58)^2(0.42)^8 = 0.0147$$

$$\Pr(Z = 9) = 10(0.58)(0.42)^9 = 0.0024$$

$$\Pr(Z = 10) = (0.42)^{10} = 0.0002$$

$$b$$

z	0	1	2	3	4	5	6	7	8	9	10
$\Pr(Z = z)$	0.0043	0.0312	0.1017	0.1963	0.2488	0.2162	0.1304	0.0540	0.0147	0.0024	0.0002

$$c \Pr(Z \geq 5 | Z \leq 8) = \frac{\Pr(Z \geq 5) \cap \Pr(Z \leq 8)}{\Pr(Z \leq 8)}$$

$$= \frac{\Pr(Z = 5) + \Pr(Z = 6) + \Pr(Z = 7) + \Pr(Z = 8)}{1 - (\Pr(Z = 9) + \Pr(Z = 10))}$$

$$= \frac{0.2162 + 0.1304 + 0.0540 + 0.0147}{1 - (0.0024 + 0.0002)}$$

$$= \frac{0.4153}{1 - 0.0026}$$

$$= 0.4164$$

8 $X \sim \text{Bi}(8, 0.63)$

x	0	1	2	3	4	5	6	7	8
$\Pr(X = x)$	0.0004	0.0048	0.0285	0.0971	0.2067	0.2815	0.2397	0.1166	0.0248

b $\Pr(X \leq 7) = 1 - \Pr(X = 8) = 1 - 0.0248 = 0.9752$

$$\begin{aligned} \text{c } \Pr(X \geq 3 \mid X \leq 7) &= \frac{\Pr(X \geq 3) \cap \Pr(X \leq 7)}{\Pr(X \leq 7)} \\ &= \frac{\Pr(3 \leq X \leq 7)}{0.9752} \\ &= \frac{0.9416}{0.9752} \\ &= 0.9655 \end{aligned}$$

d $\Pr(B', B, B, B, B, B) = 0.37 \times 0.63^5 = 0.0367$

9 $X \sim \text{Bi}(15, 0.62)$

a $\Pr(X = 10) = {}^{10}C_{10}(0.62)^{10}(0.38)^0 = 0.1997$

b $\Pr(X \geq 10) = 0.4665$

$$\begin{aligned} \text{c } \Pr(X < 4 \mid X \leq 8) &= \frac{\Pr(X < 4)}{\Pr(X \leq 8)} \\ &= \frac{0.0011}{0.3295} \\ &= 0.0034 \end{aligned}$$

10 $X \sim \text{Bi}(15, 0.45)$

a $E(X) = np = 15 \times 0.45 = 6.75$

b $\Pr(X = 4) = 0.0780$

c $\Pr(X \leq 8) = 0.8182$

d If T = buys a ticket and N = does not buy a ticket,
 $\Pr(T, T, N, N) = (0.45)^2 \times (0.55)^2 = 0.0613$

11 a Let X be the number of females on the executive.

$$X \sim \text{Bi}\left(12, \frac{1}{2}\right)$$

$$\Pr(X \geq 8) = 0.1938$$

b Let Y be the number of females on the executive.

$$Y \sim \text{Bi}(12, 0.58)$$

$$\Pr(Y \geq 8) = 0.3825$$

12 a $X \sim \text{Bi}(45, 0.72)$

i $E(X) = np = 45 \times 0.72 = 32.4$

ii $\text{Var}(Z) = np(1-p) = 45 \times 0.72 \times 0.28 = 9.072$

b $Y \sim \text{Bi}\left(100, \frac{1}{5}\right)$

i $E(Y) = np = 100 \times \frac{1}{5} = 20$

ii $\text{Var}(Y) = np(1-p) = 100 \times \frac{1}{5} \times \frac{4}{5} = 16$

c $Z \sim \text{Bi}\left(72, \frac{2}{9}\right)$

i $E(Z) = np = 72 \times \frac{2}{9} = 16$

ii $\text{Var}(Z) = np(1-p) = 72 \times \frac{2}{9} \times \frac{7}{9} = 12\frac{4}{9} \approx 12.4$

13 a $X \sim \text{Bi}\left(25, \frac{1}{6}\right)$

$$E(X) = np = 25 \times \frac{1}{6} = 4\frac{1}{6} \approx 4.1667$$

b $\text{Var}(X) = npq = 25 \times \frac{1}{6} \times \frac{5}{6} = 3\frac{17}{36} \approx 3.472$

$$\text{SD}(X) = \sqrt{3.472} = 1.8634$$

14 $Z \sim \text{Bi}(7, 0.32)$

a

z	0	1	2	3	4	5	6	7
$\Pr(Z = z)$	0.0672	0.2215	0.3127	0.2452	0.1154	0.0326	0.0051	0.0003

b $E(Z) = np = 7 \times 0.32 = 2.24$

$$\text{Var}(Z) = np(1-p) = 7 \times 0.32 \times 0.68 = 1.5232$$

c $\text{SD}(Z) = \sqrt{1.5232} = 1.2342$

$$\mu - 2\sigma = 2.24 - 2(1.2342) = -0.2284$$

$$\mu + 2\sigma = 2.24 + 2(1.2342) = 4.7084$$

$$\begin{aligned} \Pr(\mu - 2\sigma \leq Z \leq \mu + 2\sigma) &= \Pr(-0.2284 \leq Y \leq 4.7084) \\ &= 1 - (\Pr(X = 5) + \Pr(X = 6) + \Pr(X = 7)) \\ &= 1 - (0.0326 + 0.0051 + 0.0003) \\ &= 0.9620 \end{aligned}$$

 15 $X \sim \text{Bi}\left(10, \frac{1}{7}\right)$

a $E(X) = np = 10 \times \frac{1}{7} = 1.4286$

$$\text{Var}(X) = np(1-p) = 10 \times \frac{1}{7} \times \frac{6}{7} = 1.2245$$

b $\text{SD}(X) = \sqrt{1.2245} = 1.1066$

$$\mu - 2\sigma = 1.4286 - 2(1.1066) = -0.7846$$

$$\mu + 2\sigma = 1.4286 + 2(1.1066) = 3.6410$$

$$\begin{aligned} \Pr(\mu - 2\sigma \leq X \leq \mu + 2\sigma) &= \Pr(-0.7846 \leq Y \leq 3.6410) \\ &= \Pr(0 \leq Y \leq 3) \\ &= 0.9574 \end{aligned}$$

 16 a $E(Z) = np = 32.535$

$$\text{Var}(Z) = npq = np(1-p) = 9.02195$$

Re-iterating, we have

$$np = 32.535 \quad [1]$$

$$np(1-p) = 9.02195 \quad [2]$$

$$[2] \div [1]$$

$$\frac{np(1-p)}{np} = \frac{9.02195}{32.535}$$

$$1-p = 0.2773$$

$$1 - 0.2773 = p$$

$$0.7227 = p$$

b Substitute $p = 0.7227$ into [1]:

$$0.7227n = 32.535$$

$$n = \frac{32.535}{0.7227} = 45$$

 17 a Let $X \sim \text{Bi}(n, p)$.

$$E(X) = np = 9.12 \quad [1]$$

$$\text{Var}(X) = np(1-p) = 5.6544 \quad [2]$$

$$[2] \div [1]$$

$$\frac{np(1-p)}{np} = \frac{5.6544}{9.12}$$

$$1-p = 0.62$$

$$1 - 0.62 = p$$

$$0.38 = p$$

b Substitute $p = 0.38$ into [1]:

$$n \times 0.38 = 9.12$$

$$n = \frac{9.12}{0.38} = 24$$

18 Let $X \sim \text{Bi}(n, p)$.
 $E(X) = np = 3.8325$ [1]
 $\text{Var}(X) = np(1-p) = 3.4128$ [2]
 $[2] \div [1]$
 $\frac{np(1-p)}{np} = \frac{3.4128}{3.8325}$
 $1-p = 0.8905$
 $1 - 0.8905 = p$
 $p = 0.1095$

The correct answer is E.

19 Let $X \sim \text{Bi}(16, p)$.
 $E(X) = np = 10.16$
 $E(X) = 16p = 10.16$
 $p = \frac{10.16}{16} = 0.635$

$\text{Var}(X) = np(1-p)$
 $\text{Var}(X) = 16(0.635)(0.365)$
 $\text{Var}(X) = 3.7084$
 $\text{SD}(X) = \sqrt{3.7084} = 1.9257$

The correct answer is C.

20 a $X \sim \text{Bi}(12, 0.2)$
 $\Pr(x = 3) = 0.2362$
 b $Y \sim \text{Bi}(14, 0.2362)$
 $\Pr(Y \geq 6) = 0.0890$

21 $X \sim \text{Bi}(n, 0.2)$
 $\Pr(X \geq 1) \geq 0.85$
 $1 - \Pr(X = 0) \geq 0.85$
 $1 - 0.8^n \geq 0.85$
 $1 - 0.85 \geq 0.8^n$
 $n \geq 8.50$

Thus, 9 tickets would be required.

22 $X \sim \text{Bi}(n, 0.33)$
 $\Pr(X \geq 1) > 0.9$
 $1 - \Pr(X = 0) > 0.9$
 $1 - 0.67^n > 0.9$
 $1 - 0.9 > 0.67^n$
 $n > 5.75$

They need to play 6 games.

10.3 Exam questions

1 $X \stackrel{d}{=} \text{Bi}(n = ?, p = 0.1)$
 $\Pr(X \geq 2) \geq 0.5$
 $1 - [\Pr(X = 0) + \Pr(X = 1)] \geq 0.5$
 $0.9^n + n \times 0.1 \times 0.9^{n-1} = 0.5, n = 16.44$
 $n = 17$

The correct answer is C.

2 $X \sim \text{Bi}(n, p)$
 $E(X) = np, \text{SD}(X) = \sqrt{np(1-p)}$
 $E(X) = \text{SD}(X)$
 $np = \sqrt{np(1-p)}$
 $n^2 p^2 = np(1-p)$
 $n^2 p^2 - np(1-p) = 0$
 $np(np - (1-p)) = 0$ since $0 < p < 1, n > 0$
 $n = \frac{1-p}{p}, p = 0.01 \Rightarrow n = 99$

The correct answer is D.

3 $\text{Var}(X) = npq = \frac{4}{3}, E(X) = np = 2$

$\frac{\text{Var}(X)}{E(X)} = \frac{npq}{np}$
 $= q$
 $\therefore q = \frac{4}{2}$
 $= \frac{2}{3}$
 $\Rightarrow p = \frac{1}{3}$ and $n = 6$

$\Pr(X = 1) = \binom{6}{1} \times \frac{1}{3} \times \left(\frac{2}{3}\right)^5$

The correct answer is D.

10.4 Applications

10.4 Exercise

- 1 $Y \sim \text{Bi}(10, 0.3)$
 a $\Pr(Y \geq 7) = 0.0106$
 b $E(Y) = np = 10 \times 0.3 = 3$
 $\text{Var}(Y) = np(1-p) = 10 \times 0.3 \times 0.7 = 2.1$
 $\text{SD}(Y) = \sqrt{2.1} = 1.4491$
- 2 $Z \sim \text{Bi}(5, 0.01)$
 a $\Pr(Z \leq 3) = 0.951 + 0.0480 + 0.0010 + 0 \times 3 = 1$
 b i $E(Z) = np = 5 \times 0.01 = 0.05$
 ii $\text{Var}(Z) = np(1-p) = 5 \times 0.01 \times 0.99 = 0.0495$
 $\text{SD}(Z) = \sqrt{0.0495} = 0.2225$
 c $\mu - 2\sigma = 0.05 - 2(0.0495) = -0.049$
 $\mu + 2\sigma = 0.05 + 2(0.0495) = 0.149$
 $\Pr(\mu - 2\sigma \leq Z \leq \mu + 2\sigma) = \Pr(-0.049 \leq Z \leq 0.149)$
 $= \Pr(Z = 0)$
 $= 0.9510$
- 3 $X \sim \text{Bi}(15, 0.3)$
 a $\Pr(X \leq 5) = 0.7216$
 b i $E(X) = np = 15 \times 0.3 = 4.5$
 ii $\text{Var}(X) = np(1-p) = 15 \times 0.3 \times 0.7 = 3.15$
 $\text{SD}(X) = \sqrt{3.15} = 1.7748$
- 4 $Y \sim \text{Bi}(6, 0.08)$
 a i $E(Y) = np = 6 \times 0.08 = 0.48$
 ii $\text{Var}(Y) = np(1-p) = 6 \times 0.08 \times 0.92 = 0.4416$
 $\text{SD}(Y) = \sqrt{0.4416} = 0.6645$
 iii $\mu - 2\sigma = 0.48 - 2(0.6645) = -0.849$
 $\mu + 2\sigma = 0.48 + 2(0.6645) = 1.809$
 $\Pr(\mu - 2\sigma \leq Y \leq \mu + 2\sigma) = \Pr(-0.849 \leq Y \leq 1.809)$
 $= \Pr(Y = 0) + P(Y = 1)$
 $= 0.6064 + 0.3164$
 $= 0.9227$
 iv $Z \sim \text{Bi}(6, 0.01)$
 $E(Z) = np = 6 \times 0.01 = 0.06$
 v $\text{Var}(Z) = np(1-p) = 6 \times 0.01 \times 0.99 = 0.0594$
 $\text{SD}(Z) = \sqrt{0.0594} = 0.2437$

$$\begin{aligned} \text{vi } \mu - 2\sigma &= 0.06 - 2(0.2437) = -0.4274 \\ \mu + 2\sigma &= 0.06 + 2(0.2437) = 0.5474 \\ \Pr(\mu - 2\sigma \leq Z \leq \mu + 2\sigma) &= \Pr(-0.4274 \leq Z \leq 0.5474) \\ &= \Pr(Z = 0) \\ &= 0.9415 \end{aligned}$$

b There is a probability of 0.9228 that a maximum of 1 male will be colour blind, whereas there is a probability of 0.9415 that no females will be colourblind.

5 $Z \sim \text{Bi}(12, 0.85)$

a $\Pr(Z \leq 8) = 0.0922$

b $\Pr(Z \geq 5 | Z \leq 8) = \frac{\Pr(Z \geq 5) \cap \Pr(Z \leq 8)}{\Pr(Z \leq 8)}$
 $= \frac{\Pr(5 \leq Z \leq 8)}{0.0922}$
 $= \frac{0.092213}{0.0922}$
 $= 0.9992$

c i $E(Z) = np = 12 \times 0.85 = 10.2$

ii $\text{Var}(Z) = np(1-p) = 12 \times 0.85 \times 0.15 = 1.53$

$\text{SD}(Z) = \sqrt{1.53} = 1.2369$

6 Let Z be the number of chips that fail the test.

$Z \sim \text{Bi}(250, 0.02)$

$\Pr(Z = 7) = {}^{250}C_7(0.98)^{243}(0.02)^7 = 0.1051$

7 a Let X be the number of people who suffer from anaemia.

$X \sim \text{Bi}(100, 0.013)$

$\Pr(X \geq 5) = 0.0101$

b $\Pr(X = 4 | X < 10) = \frac{\Pr(X = 4)}{\Pr(X < 10)}$

$\Pr(X = 4) = 0.0319$

$\Pr(X < 10) = 0.9999$

$\Pr(X = 4 | X < 10) = \frac{\Pr(X = 4)}{\Pr(X < 10)} = \frac{0.0319}{0.9999} = 0.0319$

c $\mu = np = 100 \times 0.013 = 1.3$

$\text{Var}(X) = np(1-p) = 100 \times 0.013 \times 0.987 = 1.2831$

$\sigma = \text{SD}(X) = \sqrt{1.2831} = 1.1327$

$\mu - 2\sigma = 1.3 - 2(1.1327) = -0.9654$

$\mu + 2\sigma = 1.3 + 2(1.1327) = 3.5654$

$\Pr(\mu - 2\sigma \leq X \leq \mu + 2\sigma) = \Pr(-0.9654 \leq X \leq 3.5654)$
 $= \Pr(0 \leq X \leq 3)$
 $= 0.9580$

This means there is a 96% chance that a maximum of 3 people per 100 will suffer from anaemia.

8 $X \sim \text{Bi}(20, 0.2)$

a $\Pr(X \geq 10) = 0.0026$

b $\Pr(X \geq 10) = 1 \times 1 \times 1 \times 1 \times \Pr(X \geq 6)$
 $= 0.0812$

9 $X \sim \text{Bi}(6, 0.7)$ X = kicking 50

a i $\Pr(\text{YYYYNN}) = (0.7)^3(0.3)^3$
 $= 0.0093$

ii $\Pr(X = 3) = {}^6C_3(0.7)^3(0.3)^3$
 $= 0.1852$

iii $\Pr(X \geq 3 | \text{1st kick} > 50 \text{ m}) = \frac{0.7 \times \Pr(X \geq 2)}{0.7}$
 $= \frac{0.678454}{0.7}$
 $= 0.9692$

b $X \sim \text{Bi}(n, 0.95)$

$\Pr(X \geq 1) \geq 0.95$

$1 - \Pr(X = 0) \geq 0.95$

$1 - 0.3^n \geq 0.95$

$1 - 0.95 \geq 0.3^n$

$n \geq 2.48$

Therefore, 3 footballers are needed.

10 a $X \sim \text{Bi}(3, p)$

$\Pr(X = 0) = (1-p)^3$ $\Pr(X = 1) = 3(1-p)^2p$,

$\Pr(X = 2) = 3(1-p)p^2$, $\Pr(X = 3) = p^3$

x	0	1	2	3
$\Pr(X = x)$	$(1-p)^3$	$3(1-p)^2p$	$3(1-p)p^2$	p^3

b $\Pr(X = 0) = \Pr(X = 1)$

$(1-p)^3 = 3(1-p)^2p$

$\Pr(X = 0) = \Pr(X = 1)$

$(1-p)^3 = 3(1-p)^2p$

$(1-p)^3 - 3(1-p)^2p = 0$

$(1-p)^2(1-p-3p) = 0$

$(1-p)^2(1-4p) = 0$

$(1-p)(1+p)(1-4p) = 0$

$1-p = 0$, $1+p = 0$ or $1-4p = 0$

$p = 1$ $p = -1$ $1 = 4p$

$p = \frac{1}{4}$

$\therefore p = \frac{1}{4}$ because $0 < p < 1$

c i $\mu = E(X) = np = 3 \times \frac{1}{4} = \frac{3}{4}$

ii $\text{Var}(X) = np(1-p) = 3 \times \frac{1}{4} \times \frac{3}{4} = \frac{9}{16}$

$\sigma = \text{SD}(X) = \sqrt{\frac{9}{16}} = \frac{3}{4}$

11 $X \sim \text{Bi}(12, 0.85)$

a $\Pr(X \geq 9) = 0.7358$

b $\Pr(3M, 9G) = (0.15)^3(0.85)^9 = 0.0008$

c $\Pr(X = 10 | \text{last 9 are goals}) = \frac{\Pr(X = 1) \times \text{last 9 are goals}}{\Pr(\text{last 9 are goals})}$
 $= \frac{0.057375 \times (0.85)^9}{(0.85)^9}$
 $= 0.0574$

12 $X \sim \text{Bi}(n, 0.08)$

$\Pr(X \geq 2) > 0.8$

$1 - (\Pr(X = 0) + \Pr(X = 1)) > 0.8$

$1 - 0.8 > \Pr(X = 0) + \Pr(X = 1)$

$0.2 > (0.92)^n + n(0.92)^{n-1}(0.08)$

$n = 36.4179$, so at least 37 tickets must be bought.

10.4 Exam questions

1 $X \stackrel{d}{=} \text{Bi}(n = 10, p = 0.25)$

$\Pr(X = 4) = 0.1460$

The correct answer is **A**.

$$2 \quad A \sim \text{Bi}(80, 0.9)$$

$$\begin{aligned} \Pr(A = 74 \mid A \geq 70) &= \frac{\Pr(A = 74)}{\Pr(A \geq 70)} \\ &= \frac{0.1235}{0.8266} = 0.1494 \end{aligned}$$

The correct answer is C.

$$3 \quad X \sim \text{Bi}(20, 0.7)$$

$$\begin{aligned} \Pr(X = 15 \mid X \geq 12) &= \frac{\Pr(X = 15)}{\Pr(X \geq 12)} = \frac{0.178863}{0.88669} \\ &= 0.2017 \end{aligned}$$

The correct answer is E.

10.5 Review

10.5 Exercise

Technology free: short answer

$$1 \quad \Pr(X = 3) = {}^5C_3 \left(\frac{2}{3}\right)^2 \left(\frac{1}{3}\right)^3$$

$$\Pr(X = 3) = 10 \times \frac{4}{9} \times \frac{1}{27}$$

$$\Pr(X = 3) = \frac{40}{243}$$

$$2 \quad \text{a Let } S \text{ be the outcome of a success.}$$

$$p = 0.8$$

$$\begin{aligned} \Pr(SSSS) &= (0.8)^4 \\ &= \frac{256}{625} \end{aligned}$$

$$\text{b } \Pr(X = 3) = {}^4C_3(0.2)(0.8)^3$$

$$\Pr(X = 3) = \frac{256}{625}$$

$$\text{c Let the outcome of a goal be } G \text{ and the outcome of a miss be } M.$$

$$\begin{aligned} \Pr(GMMG) &= 0.8 \times 0.2 \times 0.2 \times 0.8 \\ &= \frac{16}{625} \end{aligned}$$

$$3 \quad \text{a } \Pr(X > 1) = 1 - \Pr(X = 0) - \Pr(X = 1)$$

$$= 1 - {}^4C_0(0.5)^4(0.5)^0 - {}^4C_1(0.5)^3(0.5)^1$$

$$= 1 - \frac{1}{16} - \frac{4}{16}$$

$$= \frac{11}{16}$$

$$\text{b } E(X) = 12 \times 0.5$$

$$= 6$$

The expected number of customers who will order a coffee is 6.

$$4 \quad E(X) = 24$$

$$\text{Var}(X) = 6$$

$$np = 24 \quad [1]$$

$$np(1-p) = 6 \quad [2]$$

$$[1] \quad n = \frac{24}{p}$$

Substitute [1] into [2]:

$$\frac{24}{p} \times p \times (1-p) = 6$$

$$24(1-p) = 6$$

$$1-p = \frac{1}{4}$$

$$-p = \frac{-3}{4}$$

$$p = \frac{3}{4}$$

Substitute p into [1]:

$$\frac{3}{4} \times n = 24$$

$$3n = 96$$

$$n = 32$$

$$5 \quad \text{a } X \sim \text{Bi}(20, p)$$

$$\Pr(X > 18) = \Pr(X = 19) + \Pr(X = 20)$$

$$= {}^{20}C_{19}(1-p)p^{19} + p^{20}$$

$$= 20(1-p)p^{19} + p^{20}$$

$$\Pr(X = 20) = p^{20}$$

$$\Pr(X = 20) = 6 \Pr(X > 18)$$

$$20(1-p)p^{19} + p^{20} = 6p^{20}$$

$$0 = 6p^{20} - p^{20} - 20(1-p)p^{19}$$

$$0 = 5p^{20} - 20p^{19} + 20p^{20}$$

$$0 = 25p^{20} - 20p^{19}$$

$$0 = 5p^{19}(5p - 4)$$

$$p = 0 \text{ or } 5p - 4 = 0$$

$$5p = 4$$

$$p = \frac{4}{5}$$

$$\text{As } p > 0, \quad \therefore p = \frac{4}{5}.$$

$$\text{b } E(X) = n \times p$$

$$= \frac{4}{5} \times 20$$

$$= 16$$

$$\text{Var}(X) = n \times p \times (1-p)$$

$$= 20 \times \frac{4}{5} \times \frac{1}{5}$$

$$= 16 \times \frac{1}{5}$$

$$= \frac{16}{5}$$

$$= 3.2$$

$$6 \quad \text{a Let } X \text{ be the number of zebra-patterned balls.}$$

$$X \sim \text{Bi}(5, p)$$

$$\Pr(X = 1) = {}^5C_1(1-p)^4p$$

$$= 5(1-p)^4p$$

$$= 5p(1-p)^4$$

$$\text{b } \frac{d}{dx} (\Pr(X = 1)) = \frac{d}{dx} (5p(1-p)^4)$$

$$= 5(1-p)^4 + 5p \times 4(-1)(1-p)^3$$

$$= 5(1-p)^4 - 20p(1-p)^3$$

$$= 5(1-p)^3(1-p-4p)$$

$$= 5(1-p)^3(1-5p)$$

Max/min values occur when the derivative is zero.

$$\begin{aligned} \frac{d}{dx} (\Pr(X = 1)) &= 0 \\ 5(1-p)^3(1-5p) &= 0 \\ 1-p &= 0 \text{ or } 1-5p = 0 \\ p &= 1 \quad \quad \quad 1 = 5p \\ & \quad \quad \quad p &= \frac{1}{5} \\ \therefore p &= \frac{1}{5} \text{ as } 0 < p < 1 \end{aligned}$$

Technology active: multiple choice

7

x	0	1
$\Pr(X = x)$	0.35	0.65

$$\begin{aligned} E(X) &= p = 0.65 \\ \text{Var}(X) &= pq \\ &= 0.65 \times 0.35 \\ &= 0.2275 \end{aligned}$$

The correct answer is **C**.

- 8 Let X be the number of times the lights are red.
 $X \sim \text{Bi}(14, 0.8)$

$$\Pr(X = 13) = {}^{14}C_{13}(0.2)(0.8)^{13}$$

The correct answer is **A**.

- 9 Late on four occasions = ${}^{10}C_4(0.7)^6(0.3)^4$, so $n = 10$ and $p = 0.3$

$$\begin{aligned} \text{Mean is } np &= 10 \times 0.3 = 3 \text{ and variance} \\ &= np(1-p) = 10 \times 0.3 \times 0.7 = 2.1 \end{aligned}$$

The correct answer is **E**.

- 10 Let Y be the number of full fares sighted.
 $Y \sim \text{Bi}(25, 0.65)$

$$\Pr(Y = 14) = {}^{25}C_{14}(0.35)^{11}(0.65)^{14}$$

The correct answer is **B**.

- 11 Let X be the number of goals scored.

$$X \sim \text{Bi}\left(8, \frac{4}{7}\right)$$

$$\begin{aligned} \Pr(X < 4) &= \Pr(X \leq 3) \\ &= 0.221 \end{aligned}$$

The correct answer is **E**.

- 12 Let X be the number of Heads.

$$X \sim \text{Bi}\left(7, \frac{1}{2}\right)$$

$$\Pr(X \leq 3) = 0.5$$

The correct answer is **D**.

- 13 $X \sim \text{Bi}(n, p)$ and $E(X) = 3.5$ and $\text{Var}(X) = 1.05$

$$np = 3.5 \quad [1]$$

$$np(1-p) = 1.05 \quad [2]$$

$$[2] \div [1]$$

$$\frac{np(1-p)}{np} = \frac{1.05}{3.5}$$

$$1-p = 0.3$$

$$1-0.3 = p$$

$$0.7 = p$$

Substitute $p = 0.7$ into [1]:

$$0.7n = 3.5$$

$$n = \frac{3.5}{0.7} = 5$$

The correct answer is **E**.

- 14 Let X be the number of games Jay wins. Also,
 $X \sim \text{Bi}(n, 0.45)$.

$$\begin{aligned} \Pr(X = 0) &= (0.55)^n = 0.0152 \\ n &= 7 \end{aligned}$$

The correct answer is **D**.

- 15 $\text{Var}(Z) = p(1-p)$ and $\text{SD}(X) = \sqrt{p(1-p)}$
 The correct answer is **B**.

- 16 $X \sim \text{Bi}(n, p)$ as well as $E(X) = 12$ and $\text{Var}(X) = 4$

$$E(X) = np = 12 \quad [1]$$

$$\text{Var}(X) = np(1-p) = 4 \quad [2]$$

$$[2] \div [1]$$

$$\frac{np(1-p)}{np} = \frac{4}{12}$$

$$1-p = \frac{1}{3} \text{ so } \frac{2}{3} = p$$

The correct answer is **E**.

Technology active: extended response

- 17 Let X be the number of defective computers.
 $X \sim \text{Bi}(12, 0.08)$

$$\begin{aligned} \text{a } \Pr(X \geq 2) &= 1 - (\Pr(X = 0) + \Pr(X = 1)) \\ &= 1 - ((0.92)^{12} + 12(0.92)^{11}(0.08)) \\ &= 1 - (0.36767 + 0.38365) \\ &= 1 - 0.75132 \\ &= 0.2487 \end{aligned}$$

24.87% of the cases have at least 2 defectives.

$$\begin{aligned} \text{b } E(X) &= np \\ &= 12 \times 0.08 \\ &= 0.96 \end{aligned}$$

$$\begin{aligned} \text{Var}(X) &= np(1-p) \\ &= 12 \times 0.08 \times 0.92 \\ &= 0.8832 \end{aligned}$$

$$\begin{aligned} \text{SD}(X) &= \sqrt{0.8832} \\ &= 0.9398 \end{aligned}$$

$$\mu - 2\sigma = 0.96 - 2(0.9398) = -0.9196$$

$$\mu + 2\sigma = 0.96 + 2(0.9398) = 2.8396$$

- c Three defectives lies outside the $\mu \pm 2\sigma$ or 95% spread, so there would be concerns about the production process.

- 18 a Let Y be the number of people with a birthday in August.

$$Y \sim \text{Bi}\left(8, \frac{1}{12}\right)$$

$$\Pr(Y = 3) = {}^8C_3 \left(\frac{11}{12}\right)^5 \left(\frac{1}{12}\right)^3 = 0.0210$$

- b Let Z be the number of people with a birthday in November.

$$Z \sim \text{Bi}\left(8, \frac{1}{12}\right)$$

$$\begin{aligned} \Pr(Z \geq 1) &= 1 - \Pr(Z = 0) \\ &= 1 - \left(\frac{11}{12}\right)^8 \\ &= 0.5015 \end{aligned}$$

- c Let X be the number of people with a birthday in March.

$$X \sim \text{Bi}\left(N, \frac{1}{12}\right)$$

$$\begin{aligned} \Pr(Z \geq 1) &= 1 - \Pr(Z = 0) \\ &= 1 - \left(\frac{11}{12}\right)^N \end{aligned}$$

If $\Pr(Z \geq 1) > 0.9$, then

$$1 - \left(\frac{11}{12}\right)^N = 0.9$$

$$1 - 0.9 = \left(\frac{11}{12}\right)^N$$

$$0.1 = \left(\frac{11}{12}\right)^N$$

$$N = 26.463$$

If $\Pr(Z \geq 1) > 0.9$, then the least value of N would be 27.

19 a $X \sim \text{Bi}\left(50, \frac{1}{14}\right)$

$$\begin{aligned} E(X) &= np \\ &= 50 \times \frac{1}{14} \\ &= \frac{25}{7} \end{aligned}$$

b i $\Pr(X \leq 5) = 0.8554$

$$\begin{aligned} \text{ii } \Pr(X \geq 3 | X \leq 5) &= \frac{\Pr(X \geq 3) \cap \Pr(X \leq 5)}{\Pr(X \leq 5)} \\ &= \frac{\Pr(X = 3) + \Pr(X = 4) + \Pr(X = 5)}{0.8554} \\ &= \frac{0.5578}{0.8554} \\ &= 0.6523 \end{aligned}$$

$$\begin{aligned} \text{iii } \text{Var}(X) &= np(1-p) \\ &= 50 \times \frac{1}{14} \times \frac{13}{14} \\ &= 3.3163 \\ \text{SD}(X) &= \sqrt{3.3163} \\ &= 1.8211 \end{aligned}$$

20 a

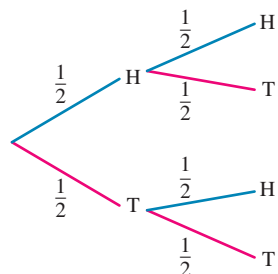

$$\Pr(\text{HH}) = \frac{1}{2} \times \frac{1}{2} = \frac{1}{4}, \quad \Pr(\text{HT}) = \frac{1}{2} \times \frac{1}{2} = \frac{1}{4},$$

$$\Pr(\text{TH}) = \frac{1}{2} \times \frac{1}{2} = \frac{1}{4}, \quad \Pr(\text{TT}) = \frac{1}{2} \times \frac{1}{2} = \frac{1}{4}$$

b Let X be the number of spins when two Heads result.

$$X \sim \text{Bi}\left(5, \frac{1}{4}\right)$$

Therefore, $n = 5$ and $p = \frac{1}{4}$.

c $\Pr(X = 0) = \left(\frac{3}{4}\right)^5 = 0.2373$

$$\Pr(X = 1) = 5 \left(\frac{3}{4}\right)^4 \left(\frac{1}{4}\right) = 0.3955$$

$$\Pr(X = 2) = 10 \left(\frac{3}{4}\right)^3 \left(\frac{1}{4}\right)^2 = 0.2637$$

$$\Pr(X = 3) = 10 \left(\frac{3}{4}\right)^2 \left(\frac{1}{4}\right)^3 = 0.0879$$

$$\Pr(X = 4) = 5 \left(\frac{3}{4}\right) \left(\frac{1}{4}\right)^4 = 0.0146$$

$$\Pr(X = 5) = \left(\frac{1}{4}\right)^5 = 0.0001$$

x	0	1	2	3	4	5
$\Pr(X = x)$	0.2373	0.3955	0.2637	0.0879	0.0146	0.0010

d $E(X) = np = 5 \times \frac{1}{4} = 1.25$

$$\text{Var}(X) = np(1-p) = 5 \times \frac{1}{4} \times \frac{3}{4} = \frac{15}{16} = 0.9375$$

$$\text{SD}(X) = \sqrt{0.9375} = 0.9682$$

$$\mu - 2\sigma = 1.25 - 2(0.9682) = -0.6864$$

$$\mu + 2\sigma = 1.25 + 2(0.9682) = 3.1864$$

$$\begin{aligned} \Pr(\mu - 2\sigma \leq X \leq \mu + 2\sigma) &= \Pr(-0.6864 \leq X \leq 3.1864) \\ &= \Pr(0 \leq X \leq 3) \\ &= 0.9844 \end{aligned}$$

10.5 Exam questions

1 a $T \sim \text{Bi}\left(4, \frac{1}{3}\right)$

$$\begin{aligned} \Pr(T = 0) &= \left(\frac{2}{3}\right)^4 \\ &= \frac{16}{81} \end{aligned}$$

Award 1 mark for the correct probability.

VCAA Assessment Report note:

Incorrect responses overlooked the stipulation ‘four times each day’, thus not identifying a binomial distribution. Some students considered untagged sheep rather than tagged sheep.

b $\Pr(T \geq 1) = 1 - \Pr(T = 0)$

$$\begin{aligned} &= 1 - \frac{16}{81} \\ &= \frac{65}{81} \end{aligned}$$

Award 1 mark for the correct probability.

VCAA Assessment Report note:

Students identified that the answer to this part of the question was simply the complement of their previous answer. However, some students wasted time in finding the sum of four probabilities, and others made arithmetic errors.

c $\Pr(\text{no tagged sheep}) = \left(\frac{16}{81}\right)^6$

Award 1 mark for the correct probability.

VCAA Assessment Report note:

The majority of students made the correct connection to part a and the exponent 6. The most common incorrect answer was $\left(\frac{2}{3}\right)^6$.

$$2 \text{ a } G \stackrel{d}{=} \text{Bi} \left(n = 4, p = \frac{3}{5} \right)$$

$$\begin{aligned} \Pr(G \geq 3) &= \Pr(G = 3) + \Pr(G = 4) \\ &= \binom{4}{3} \left(\frac{3}{5}\right)^3 \left(\frac{2}{5}\right)^1 + \binom{4}{4} \left(\frac{3}{5}\right)^4 \left(\frac{2}{5}\right)^0 \\ &= 4 \times \left(\frac{3}{5}\right)^3 \times \frac{2}{5} + \left(\frac{3}{5}\right)^4 \\ &= \left(\frac{3}{5}\right)^3 \left(\frac{8}{5} + \frac{3}{5}\right) \\ &= \frac{11 \times 3^3}{5 \times 5^3} \\ &= \frac{297}{625} \end{aligned}$$

Award 1 mark for using binomial probabilities.

Award 1 mark for the final correct answer.

$$\begin{aligned} 2 \text{ b } \Pr(G = 2 \mid G \geq 1) &= \frac{\Pr(G = 2)}{\Pr(G \geq 1)} \\ &= \frac{\Pr(G = 2)}{1 - \Pr(G = 0)} \\ &= \frac{\binom{4}{2} \left(\frac{3}{5}\right)^2 \left(\frac{2}{5}\right)^2}{1 - \left(\frac{2}{5}\right)^4} \\ &= \frac{\frac{6 \times 9 \times 4}{5^4}}{1 - \frac{2^4}{5^4}} \\ &= \frac{\frac{216}{5^4}}{\frac{5^4 - 2^4}{5^4}} \\ &= \frac{6^3}{5^4 - 2^4}, a = 6, b = 5, c = 2 \end{aligned}$$

Award 1 mark for using binomial conditional probabilities.

Award 1 mark for the final correct answer.

$$3 \text{ p } \stackrel{d}{=} \text{Bi} \left(n = 20, p = \frac{1}{6} \right)$$

$$p(x) = \binom{20}{x} \left(\frac{1}{6}\right)^x \left(\frac{5}{6}\right)^{20-x}$$

$$q \stackrel{d}{=} \text{Bi} \left(n = 20, p = \frac{5}{6} \right)$$

$$q(w) = \binom{20}{w} \left(\frac{5}{6}\right)^w \left(\frac{1}{6}\right)^{20-w}$$

$$p(20-w) = \binom{20}{20-w} \left(\frac{1}{6}\right)^{20-w} \left(\frac{5}{6}\right)^{20-(20-w)}$$

$$= \binom{20}{w} \left(\frac{5}{6}\right)^w \left(\frac{1}{6}\right)^{20-w}$$

$$= q(w)$$

The correct answer is A.

$$4 \quad np = 1.4$$

$$25p = 1.4$$

$$\therefore p = \frac{7}{125}$$

$$\therefore B \stackrel{d}{=} \text{Bi} \left(n = 25, p = \frac{7}{125} \right)$$

$$\Pr(B > 3) = \Pr(B \geq 4) = 0.048$$

The correct answer is B.

$$5 \text{ X } \stackrel{d}{=} \text{Bi} (n = 30, p = 0.08)$$

$$\text{Var}(X) = npq$$

$$= 30 \times 0.08 \times 0.92$$

$$= 2.21$$

$$\text{SD}(X) = \sqrt{2.21}$$

$$= 1.486$$

The correct answer is E.

Topic 11 — Continuous probability distributions

11.2 Continuous random variables and probability functions

11.2 Exercise

$$1 \text{ a i } \Pr(X \leq 2) = \frac{10 + 26}{100} = \frac{36}{100} = \frac{9}{25}$$

$$\text{ii } \Pr(X > 4) = \frac{16}{100} = \frac{4}{25}$$

$$\text{b i } \Pr(1 < X \leq 4) = \frac{26 + 28 + 20}{100} = \frac{74}{100} = \frac{37}{50}$$

$$\begin{aligned} \text{ii } \Pr(X > 1 | X \leq 4) &= \frac{\Pr(X > 1 \cap X \leq 4)}{\Pr(X \leq 4)} \\ &= \frac{\Pr(1 < X \leq 4)}{\Pr(X \leq 4)} \\ &= \frac{37}{50} \div \frac{84}{100} \\ &= \frac{37}{50} \times \frac{100}{84} \\ &= \frac{37}{42} \end{aligned}$$

2 a The number of batteries is 100.

$$\text{b } \Pr(X > 45) = \frac{29}{100}$$

$$\text{c } \Pr(15 < X \leq 60) = \frac{82}{100} = \frac{41}{50}$$

$$\text{d } \Pr(X > 60) = \frac{3}{100}$$

3 a 200 shot-put throws were measured.

$$\text{b i } \Pr(X > 0.5) = \frac{200 - 75}{200} = \frac{125}{200} = \frac{5}{8}$$

$$\text{ii } \Pr(1 < X \leq 2) = \frac{62}{200} = \frac{31}{100}$$

$$\begin{aligned} \text{c } \Pr(X < 0.5 | X < 1) &= \frac{\Pr(0.5 < X < 1)}{\Pr(X < 1)} \\ &= \frac{63}{200} \div \frac{138}{200} \\ &= \frac{63}{200} \times \frac{200}{138} \\ &= \frac{63}{138} \\ &= \frac{21}{46} \end{aligned}$$

$$4 \text{ a } f(x) = \begin{cases} \frac{1}{4}e^{2x}, & 0 \leq x \leq \log_e 3 \\ 0, & \text{elsewhere} \end{cases}$$

$$\begin{aligned} A &= \int_0^{\log_e 3} \frac{1}{4}e^{2x} dx \\ &= \left[\frac{1}{4} \times \frac{1}{2} e^{2x} \right]_0^{\log_e 3} \\ &= \left[\frac{1}{8} e^{2x} \right]_0^{\log_e 3} \end{aligned}$$

$$\begin{aligned} &= \frac{1}{8} e^{2 \log_e 3} - \frac{1}{8} e^0 \\ &= \frac{1}{8} e^{\log_e 9} - \left(\frac{1}{8} \times 1 \right) \\ &= \frac{1}{8} (e^{\log_e 9} - 1) \\ &= \frac{1}{8} (9 - 1) \\ &= 1 \end{aligned}$$

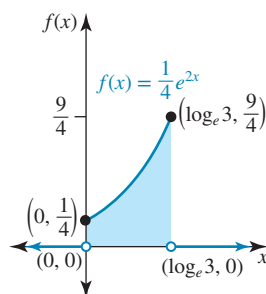

This is a probability density function as the area is 1 unit².

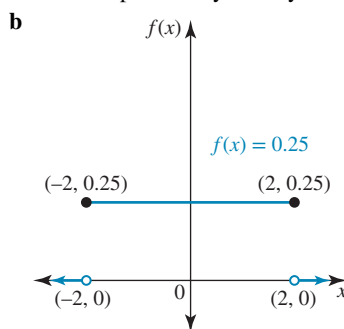

$$\begin{aligned} \int_{-2}^2 0.25 dx &= [0.25x]_{-2}^2 \\ \int_{-2}^2 0.25 dx &= 0.25(2) - 0.25(-2) \\ \int_{-2}^2 0.25 dx &= 0.5 + 0.5 = 1 \end{aligned}$$

This is a probability density function.

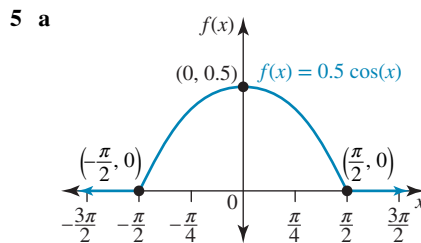

$$\int_{-\frac{\pi}{2}}^{\frac{\pi}{2}} \frac{1}{2} \cos(x) dx = \left[\frac{1}{2} \sin(x) \right]_{-\frac{\pi}{2}}^{\frac{\pi}{2}}$$

$$\int_{-\frac{\pi}{2}}^{\frac{\pi}{2}} \frac{1}{2} \cos(x) dx = \frac{1}{2} \sin\left(\frac{\pi}{2}\right) - \frac{1}{2} \sin\left(-\frac{\pi}{2}\right)$$

$$\int_{-\frac{\pi}{2}}^{\frac{\pi}{2}} \frac{1}{2} \cos(x) dx = \frac{1}{2} + \frac{1}{2}$$

$$\int_{-\frac{\pi}{2}}^{\frac{\pi}{2}} \frac{1}{2} \cos(x) dx = 1$$

This is a probability density function.

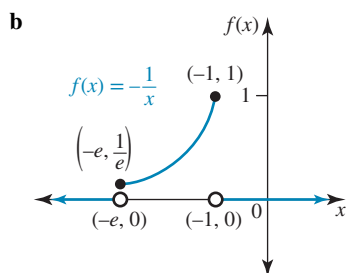

$$\int_1^2 -\frac{1}{x} dx = 1 \text{ unit}^2$$

$$= \left[-\log_e(x)^{-1} \right]_{-e}^{-1}$$

$$= \left[\log_e\left(\frac{1}{x}\right) \right]_{-e}^{-1}$$

$$= 1 \text{ unit}^2$$

This is a probability density function.

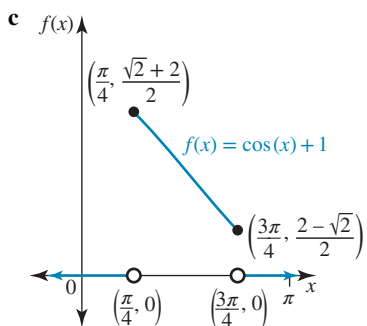

$$\int_{\frac{\pi}{4}}^{\frac{3\pi}{4}} (\cos(x) + 1) dx$$

$$= \left[\sin(x) + x \right]_{\frac{\pi}{4}}^{\frac{3\pi}{4}}$$

$$= \left(\sin\left(\frac{3\pi}{4}\right) + \frac{3\pi}{4} \right) - \left(\sin\left(\frac{\pi}{4}\right) + \frac{\pi}{4} \right)$$

$$= \frac{\sqrt{2}}{2} + \frac{3\pi}{4} - \frac{\sqrt{2}}{2} - \frac{\pi}{4}$$

$$= \frac{\pi}{2} \text{ units}^2$$

This is not a probability density function.

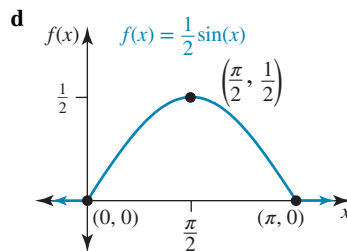

$$\int_0^{\pi} \frac{1}{2} \sin(x) dx$$

$$= \left[-\frac{1}{2} \cos(x) \right]_0^{\pi}$$

$$= \left(-\frac{1}{2} \cos(\pi) \right) - \left(-\frac{1}{2} \cos(0) \right)$$

$$= \frac{1}{2} + \frac{1}{2}$$

$$= 1 \text{ units}^2$$

This is a probability density function.

6

$$\int_1^3 n(x^3 - 1) dx = 1$$

$$n \left[\frac{1}{4} x^4 - x \right]_1^3 = 1$$

$$n \left(\left(\frac{1}{4} (3)^4 - 3 \right) - \left(\frac{1}{4} (1)^4 - 1 \right) \right) = 1$$

$$n \left(\frac{81}{4} - 3 - \frac{1}{4} + 1 \right) = 1$$

$$18n = 1$$

$$n = \frac{1}{18}$$

7

$$\int_{-2}^0 (-ax) dx + \int_0^3 (2ax) dx = 1$$

$$\left[-\frac{1}{2} ax^2 \right]_{-2}^0 + \left[ax^2 \right]_0^3 = 1$$

$$\left(0 - \left(-\frac{1}{2} a(-2)^2 \right) \right) + (a(3)^2 - 0) = 1$$

$$2a + 9a = 1$$

$$11a = 1$$

$$a = \frac{1}{11}$$

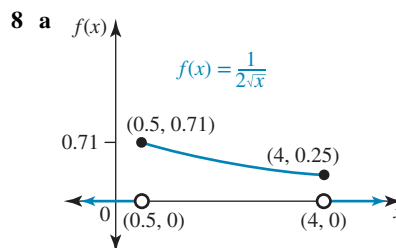

$$\int_{0.25}^4 0.5x^{-0.5} dx = [x^{0.5}]_{0.25}^4$$

$$\int_{0.25}^4 0.5x^{-0.5} dx = \sqrt{4} - \sqrt{0.25}$$

$$\int_{0.25}^4 0.5x^{-0.5} dx = 2 - 0.7071$$

$$\int_{0.25}^4 0.5x^{-0.5} dx = 1.2929$$

This is not a probability density function.

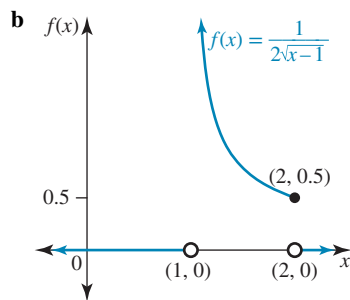

$$\int_1^2 \frac{1}{2\sqrt{x-1}} dx = 1 \text{ unit}^2$$

This is a probability density function.

9

$$\int_{0.25}^{1.65} c dx = 1$$

$$[cx]_{0.25}^{1.65} = 1$$

$$1.65c - 0.25c = 1$$

$$1.4c = 1$$

$$c = \frac{1}{1.4}$$

$$c = \frac{5}{7}$$

The correct answer is E.

10

$$\int_{-1}^5 f(z) dz = 1$$

$$A_{\text{triangle}} = 1$$

$$\frac{1}{2} \times 6 \times z = 1$$

$$3z = 1$$

$$z = \frac{1}{3}$$

11 a

$$\int_0^2 m(6 - 2x) dx = 1$$

$$m \int_0^2 (6 - 2x) dx = 1$$

$$m [6x - x^2]_0^2 = 1$$

$$m(6(2) - (2)^2 - 6(0) + 0^2) = 1$$

$$8m = 1$$

$$m = \frac{1}{8}$$

b

$$\int_0^{\infty} m e^{-2x} dx = 1$$

$$m \int_0^{\infty} e^{-2x} dx = 1$$

$$m \left[-\frac{1}{2e^{2x}} \right]_0^{\infty} = 1$$

$$m \left(0 + \frac{1}{2} \right) = 1$$

$$\frac{1}{2} m = 1$$

$$m = 2$$

c

$$\int_0^{\log_e(3)} m e^{2x} dx = 1$$

$$m \int_0^{\log_e(3)} e^{2x} dx = 1$$

$$m \left[\frac{1}{2} e^{2x} \right]_0^{\log_e(3)} = 1$$

$$m \left(\frac{1}{2} e^{2 \log_e(3)} - \frac{1}{2} e^0 \right) = 1$$

$$m \left(\frac{1}{2} e^{\log_e(9)} - \frac{1}{2} \right) = 1$$

$$m \left(\frac{9}{2} - \frac{1}{2} \right) = 1$$

$$4m = 1$$

$$m = \frac{1}{4}$$

12

$$\int_0^3 (x^2 + 2kx + 1) dx = 1$$

$$\left[\frac{1}{3} x^3 + kx^2 + x \right]_0^3 = 1$$

$$\left(\frac{1}{3} (3)^3 + k(3)^2 + 3 \right) - 0 = 1$$

$$9 + 9k + 3 = 1$$

$$9k = -11$$

$$k = -\frac{11}{9}$$

13

$$\int_0^{\frac{\pi}{12}} n \sin(3x) \cos(3x) dx = 1$$

$$n \int_0^{\frac{\pi}{12}} \sin(3x) \cos(3x) dx = 1$$

Solve using CAS.

$$n = 12$$

The correct answer is A.

14 a

$$\int_1^a \log_e(x) dx = 1$$

Solve using CAS.

$$\therefore a = e$$

b As $f(x) \geq 0$ and $\int_1^e f(x) dx = 1$, this is a probability density function.

$$15 \quad \int_2^a f(x) dx = 1$$

$$\int_2^a \frac{1}{2} \log_e \left(\frac{x}{2} \right) dx = 1$$

Solve using CAS.

$$\therefore a = 2e$$

16 a

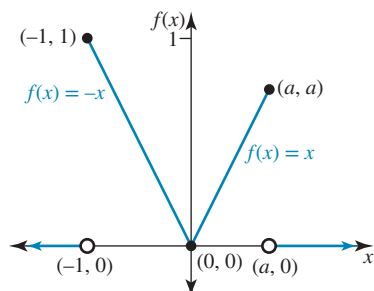

$$\begin{aligned} \int_{-1}^a f(x) dx &= \int_{-1}^0 -x dx + \int_0^a x dx \\ &= \left[-\frac{1}{2}x^2 \right]_{-1}^0 + \left[\frac{1}{2}x^2 \right]_0^a \\ &= -\frac{1}{2}(0)^2 + \frac{1}{2}(-1)^2 + \frac{1}{2}a^2 - \frac{1}{2}(0)^2 \\ &= \frac{a^2 + 1}{2} \end{aligned}$$

b

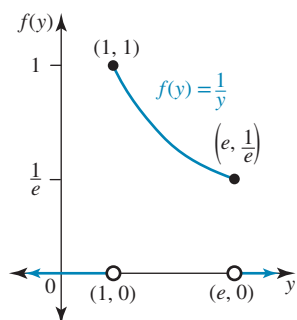

$$\begin{aligned} \int_1^e f(y) dy &= \int_1^e \frac{1}{y} dy \\ &= \left[\log_e(y) \right]_1^e \\ &= \log_e(e) - \log_e(1) \\ &= 1 \end{aligned}$$

$$\begin{aligned} \text{c} \quad \int_{-1}^a f(x) dx &= \int_1^e f(y) dy \\ \frac{a^2 + 1}{2} &= 1 \\ a^2 + 1 &= 2 \\ a^2 &= 1 \\ a &= \pm 1 \\ a &= 1 \text{ since } a > 0 \end{aligned}$$

11.2 Exam questions

$$1 \quad f(x) = \begin{cases} \cos(x) + 1, & k < x < k + 1 \\ 0, & \text{elsewhere} \end{cases}$$

$$\int_k^{k+1} f(x) dx = 1$$

To solve this using CAS, complete the entry line as:

$$\text{Solve} \left(\int_k^{k+1} (\cos(x) + 1) dx = 1, k \right) | 0 < k < 2$$

$$\Rightarrow k = \frac{\pi - 1}{2}$$

The correct answer is **D**.

$$2 \quad f(x) = \begin{cases} ae^x, & 0 \leq x \leq 1 \\ ae, & 1 \leq x \leq 2 \\ 0, & \text{otherwise} \end{cases}$$

Since the total area under the curve is 1:

$$\begin{aligned} \int_0^1 ae^x dx + \int_1^2 ae dx &= 1 \\ [ae^x]_0^1 + [aex]_1^2 &= 1 \\ ae - a + 2ae - ae &= 1 \\ 2ae - a &= 1 \\ a(2e - 1) &= 1 \\ a &= \frac{1}{2e - 1} \end{aligned}$$

The correct answer is **E**.

$$3 \quad \int_0^3 cx^2 dx = 1$$

$$1 = c \left[\frac{x^3}{3} \right]_0^3$$

$$1 = c \left(\frac{27}{3} - 0 \right)$$

$$1 = 9c$$

$$c = \frac{1}{9}$$

The correct answer is **D**.

11.3 The continuous probability density function

11.3 Exercise

1 a

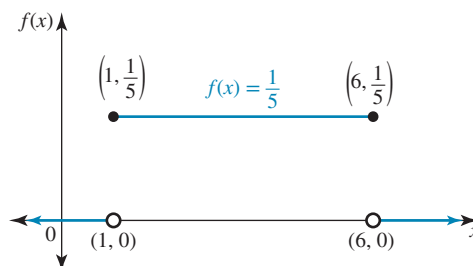

$$\begin{aligned} \text{b } \Pr(2 \leq X \leq 5) &= \int_2^5 \frac{1}{5} dx \\ \Pr(2 \leq X \leq 5) &= \left[\frac{1}{5}x \right]_2^5 \\ \Pr(2 \leq X \leq 5) &= \frac{1}{5}(5) - \frac{1}{5}(2) \\ \Pr(2 \leq X \leq 5) &= \frac{3}{5} \end{aligned}$$

$$\begin{aligned} \text{2 a } \int_0^a 4x^3 dx &= 1 \\ [x^4]_0^a &= 1 \\ a^4 - 0 &= 1 \\ a^4 &= 1 \\ a &= \pm 1 \\ a &= 1 \text{ since } a > 0 \end{aligned}$$

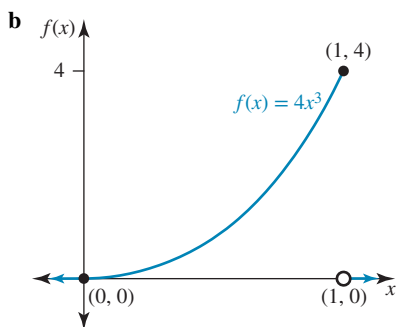

$$\begin{aligned} \text{c } \Pr(0.5 \leq X \leq 1) &= \int_{0.5}^1 4x^3 dx \\ \Pr(0.5 \leq X \leq 1) &= [x^4]_{0.5}^1 \\ \Pr(0.5 \leq X \leq 1) &= 1^4 - \frac{1}{2} \\ \Pr(0.5 \leq X \leq 1) &= 1 - \frac{1}{16} \\ \Pr(0.5 \leq X \leq 1) &= \frac{15}{16} \end{aligned}$$

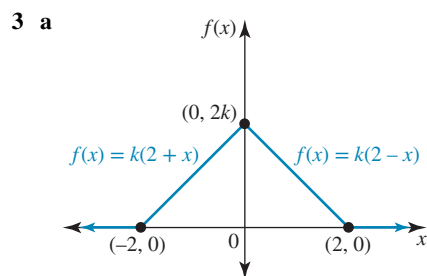

$$\begin{aligned} \text{b } A &= \frac{1}{2}bh \\ 1 &= \frac{1}{2} \times 4 \times 2 \times k \\ 1 &= 4k \\ k &= \frac{1}{4} \end{aligned}$$

$$\begin{aligned} \text{c } \Pr(-1 \leq X \leq 1) &= \int_{-1}^0 \frac{1}{4}(2+x) dx + \int_0^1 \frac{1}{4}(2-x) dx \\ \Pr(-1 \leq X \leq 1) &= \int_{-1}^0 \left(\frac{1}{2} + \frac{1}{4}x \right) dx + \int_0^1 \left(\frac{1}{2} - \frac{1}{4}x \right) dx \\ \Pr(-1 \leq X \leq 1) &= \left[\frac{1}{2}x + \frac{1}{8}x^2 \right]_{-1}^0 + \left[\frac{1}{2}x - \frac{1}{8}x^2 \right]_0^1 \\ \Pr(-1 \leq X \leq 1) &= 0 - \left(\frac{1}{2}(-1) + \frac{1}{8}(-1)^2 \right) \\ &\quad + \left(\frac{1}{2}(1) - \frac{1}{8}(1)^2 \right) - 0 \\ \Pr(-1 \leq X \leq 1) &= \left(\frac{1}{2} - \frac{1}{8} \right) + \left(\frac{1}{2} - \frac{1}{8} \right) \\ \Pr(-1 \leq X \leq 1) &= \frac{3}{8} + \frac{3}{8} \\ \Pr(-1 \leq X \leq 1) &= \frac{3}{4} \end{aligned}$$

$$\begin{aligned} \text{d } \Pr(x \geq 1 | x \leq 1) &= \frac{\Pr(-1 \leq X \leq 1)}{\Pr(x \leq 1)} \\ \Pr(X \leq 1) &= \int_{-2}^0 \frac{1}{4}(2+x) dx + \int_0^1 \frac{1}{4}(2-x) dx \\ \Pr(X \leq 1) &= \left[\frac{1}{2}x + \frac{1}{8}x^2 \right]_{-2}^0 + \frac{3}{8} \\ \Pr(X \leq 1) &= 0 - \left(\frac{1}{2}(-2) + \frac{1}{8}(-2)^2 \right) + \frac{3}{8} \\ \Pr(X \leq 1) &= 1 - \frac{1}{2} + \frac{3}{8} \\ \Pr(X \leq 1) &= \frac{1}{2} + \frac{3}{8} \\ \Pr(x \leq 1) &= \frac{7}{8} \\ \Pr(X \geq -1 | X \leq 1) &= \frac{3}{4} + \frac{7}{8} = \frac{3}{4} \div \frac{7}{8} = \frac{6}{7} \end{aligned}$$

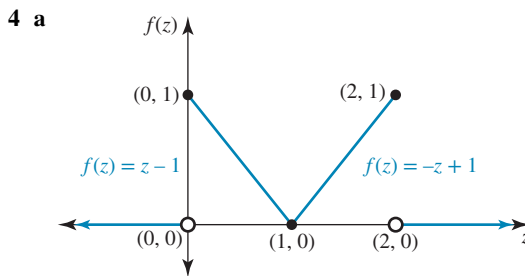

$$\begin{aligned} \text{b } \Pr(Z < 0.75) &= \int_0^{0.75} (-z + 1) dz \\ \Pr(Z < 0.75) &= \left[-\frac{1}{2}z^2 + z \right]_0^{0.75} \\ \Pr(Z < 0.75) &= \left(-\frac{1}{2} \left(\frac{3}{4} \right)^2 + \frac{3}{4} \right) - 0 \\ \Pr(Z < 0.75) &= \frac{15}{32} \end{aligned}$$

$$\begin{aligned}
 \text{c } \Pr(Z > 0.5) &= \int_{0.5}^2 f(z) dz \\
 \Pr(Z > 0.5) &= \int_{0.5}^1 (1-z) dz + \int_1^2 (z-1) dz \\
 \Pr(Z > 0.5) &= \left[z - \frac{1}{2}z^2 \right]_{0.5}^1 + \frac{1}{2} \\
 \Pr(Z > 0.5) &= \left(1 - \frac{1}{2}(1)^2 \right) - \left(\frac{1}{2} - \frac{1}{2} \left(\frac{1}{2} \right)^2 \right) + \frac{1}{2} \\
 \Pr(Z > 0.5) &= \frac{1}{2} - \left(\frac{1}{2} - \frac{1}{8} \right) + \frac{1}{2} \\
 \Pr(Z > 0.5) &= 1 - \frac{3}{8} \\
 \Pr(Z > 0.5) &= \frac{5}{8}
 \end{aligned}$$

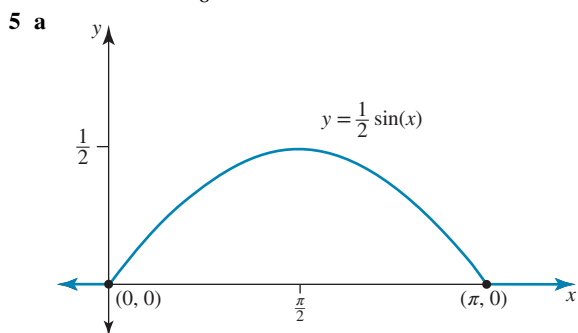

$$\begin{aligned}
 \text{b } \Pr\left(\frac{\pi}{4} < X < \frac{3\pi}{4}\right) &= \frac{1}{2} \int_{\frac{\pi}{4}}^{\frac{3\pi}{4}} \sin(x) dx \\
 &= \frac{1}{2} [-\cos(x)]_{\frac{\pi}{4}}^{\frac{3\pi}{4}} \\
 &= \frac{1}{2} \left(-\cos\left(\frac{3\pi}{4}\right) + \cos\left(\frac{\pi}{4}\right) \right) \\
 &= \frac{1}{2} \left(\frac{\sqrt{2}}{2} + \frac{\sqrt{2}}{2} \right) \\
 &= \frac{\sqrt{2}}{2}
 \end{aligned}$$

$$\begin{aligned}
 \text{c } \Pr\left(X > \frac{\pi}{4} \mid X < \frac{3\pi}{4}\right) &= \frac{\Pr\left(\frac{\pi}{4} < X < \frac{3\pi}{4}\right)}{\Pr\left(X < \frac{3\pi}{4}\right)} \\
 \Pr\left(X < \frac{3\pi}{4}\right) &= \frac{1}{2} \int_0^{\frac{3\pi}{4}} \sin(x) dx \\
 &= \frac{1}{2} [-\cos(x)]_0^{\frac{3\pi}{4}} \\
 &= \frac{1}{2} \left(-\cos\left(\frac{3\pi}{4}\right) + \cos(0) \right) \\
 &= \frac{1}{2} \left(\frac{\sqrt{2}}{2} + 1 \right) \\
 &= \frac{\sqrt{2}}{4} + \frac{1}{2}
 \end{aligned}$$

$$\begin{aligned}
 \Pr\left(X > \frac{\pi}{4} \mid X < \frac{3\pi}{4}\right) &= \frac{\Pr\left(\frac{\pi}{4} < X < \frac{3\pi}{4}\right)}{\Pr\left(X < \frac{3\pi}{4}\right)} \\
 &= \frac{\frac{\sqrt{2}}{2}}{\frac{\sqrt{2}+2}{4}} \\
 &= \frac{2\sqrt{2}}{\sqrt{2}+2} \\
 &= 2\sqrt{2}-2
 \end{aligned}$$

6 a

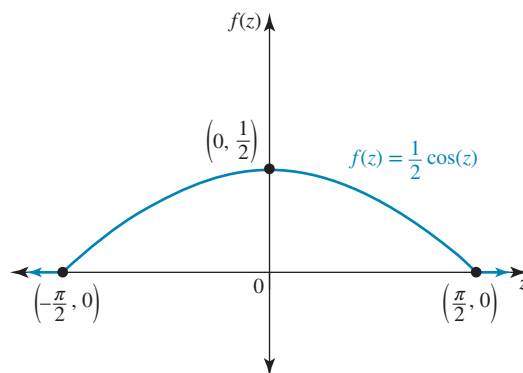

$$\begin{aligned}
 &\int_{-\frac{\pi}{2}}^{\frac{\pi}{2}} \frac{1}{2} \cos(z) dz \\
 &= \left[\frac{1}{2} \sin(z) \right]_{-\frac{\pi}{2}}^{\frac{\pi}{2}} \\
 &= \frac{1}{2} \sin\left(\frac{\pi}{2}\right) - \frac{1}{2} \sin\left(-\frac{\pi}{2}\right) \\
 &= \frac{1}{2} + \frac{1}{2} \\
 &= 1
 \end{aligned}$$

This is a probability density function.

$$\begin{aligned}
 \text{b } \Pr\left(-\frac{\pi}{6} \leq Z \leq \frac{\pi}{4}\right) &= \frac{1}{2} \int_{-\frac{\pi}{6}}^{\frac{\pi}{4}} \cos(z) dz \\
 &= \frac{1}{2} [\sin(z)]_{-\frac{\pi}{6}}^{\frac{\pi}{4}} \\
 &= \frac{1}{2} \left[\sin\left(\frac{\pi}{4}\right) - \sin\left(-\frac{\pi}{6}\right) \right] \\
 &= \frac{1}{2} \left(\frac{\sqrt{2}}{2} + \frac{1}{2} \right) \\
 &= \frac{\sqrt{2}+1}{4}
 \end{aligned}$$

 7 Let X be the amount of petrol sold in thousands of litres.

$$\begin{aligned}
 \text{a } \int_{18}^{30} k dx &= 1 \\
 [kx]_{18}^{30} &= 1 \\
 (30k) - (18k) &= 1 \\
 12k &= 1 \\
 k &= \frac{1}{12}
 \end{aligned}$$

$$\mathbf{b} \Pr(20 < X < 25) = \int_{20}^{25} \frac{1}{12} dx$$

$$\Pr(20 < X < 25) = \left[\frac{1}{12}x \right]_{20}^{25}$$

$$\Pr(20 < X < 25) = \left(\frac{1}{12}(25) \right) - \left(\frac{1}{12}(20) \right)$$

$$\Pr(20 < X < 25) = \frac{5}{12}$$

$$\mathbf{c} \Pr(X \geq 26 | X \geq 22) = \frac{\Pr(X \geq 26 \cap X \geq 22)}{\Pr(X \geq 22)}$$

$$\Pr(X \geq 26 | X \geq 22) = \frac{\Pr(X \geq 26)}{\Pr(X \geq 22)}$$

$$\Pr(X \geq 22) = \int_{22}^{30} \frac{1}{12} dx$$

$$\Pr(X \geq 22) = \left[\frac{1}{12}x \right]_{22}^{30}$$

$$\Pr(X \geq 22) = \frac{1}{12}(30) - \frac{1}{12}(22)$$

$$\Pr(X \geq 22) = \frac{8}{12}$$

$$\Pr(X \geq 22) = \frac{2}{3}$$

$$\Pr(X \geq 26) = \int_{26}^{30} \frac{1}{12} dx$$

$$\Pr(X \geq 26) = \left[\frac{1}{12}x \right]_{26}^{30}$$

$$\Pr(X \geq 26) = \frac{1}{12}(30) - \frac{1}{12}(26)$$

$$\Pr(X \geq 26) = \frac{4}{12}$$

$$\Pr(X \geq 26) = \frac{1}{3}$$

$$\frac{\Pr(X \geq 26)}{\Pr(X \geq 22)} = \frac{1}{3} \div \frac{2}{3}$$

$$\frac{\Pr(X \geq 26)}{\Pr(X \geq 22)} = \frac{1}{3} \times \frac{3}{2}$$

$$\frac{\Pr(X \geq 26)}{\Pr(X \geq 22)} = \frac{1}{2}$$

$$\mathbf{8} \mathbf{a} \quad \int_0^a f(u) du = 1$$

$$\int_0^a \left(1 - \frac{1}{4}(2u - 3u^2) \right) du = 1$$

$$\int_0^a \left(1 - \frac{1}{2}u + \frac{3}{4}u^2 \right) du = 1$$

$$\left[u - \frac{1}{4}u^2 + \frac{1}{4}u^3 \right]_0^a = 1$$

$$\left(a - \frac{1}{4}a^2 + \frac{1}{4}a^3 \right) - 0 = 1$$

$$\frac{1}{4}a^3 - \frac{1}{4}a^2 + a - 1 = 0$$

$$\frac{1}{4}a^2(a - 1) + (a - 1) = 0$$

$$(a - 1) \left(\frac{1}{4}a^2 + 1 \right) = 0$$

$$a = 1$$

$$\mathbf{b} \Pr(U < 0.75) = \int_0^{0.75} \left(1 - \frac{1}{4}(2u - 3u^2) \right) du$$

$$\Pr(U < 0.75) = \int_0^{0.75} \left(1 - \frac{1}{2}u + \frac{3}{4}u^2 \right) du$$

$$\Pr(U < 0.75) = \left[u - \frac{1}{4}u^2 + \frac{1}{4}u^3 \right]_0^{0.75}$$

$$\Pr(U < 0.75) = \left(0.75 - \frac{1}{4}(0.75)^2 + \frac{1}{4}(0.75)^3 \right) - 0$$

$$\Pr(U < 0.75) = \frac{183}{256}$$

$$\mathbf{c} \Pr(0.1 < U < 0.5) = \int_{0.1}^{0.5} \left(1 - \frac{1}{4}(2u - 3u^2) \right) du$$

$$\Pr(0.1 < U < 0.5) = \int_{0.1}^{0.5} \left(1 - \frac{1}{2}u + \frac{3}{4}u^2 \right) du$$

$$\Pr(0.1 < U < 0.5) = \left[u - \frac{1}{4}u^2 + \frac{1}{4}u^3 \right]_{0.1}^{0.5}$$

$$\Pr(0.1 < U < 0.5) = \left(0.5 - \frac{1}{4}(0.5)^2 + \frac{1}{4}(0.5)^3 \right) - \left(0.1 - \frac{1}{4}(0.1)^2 + \frac{1}{4}(0.1)^3 \right)$$

$$\Pr(0.1 < U < 0.5) = 0.371$$

$$\mathbf{d} \Pr(U = 0.8) = 0$$

$$\mathbf{9} \Pr(0 \leq X \leq 1) = \int_0^1 f(x) dx$$

$$\Pr(0 \leq X \leq 1) = \int_0^1 3e^{-3x} dx$$

$$\Pr(0 \leq X \leq 1) = \left[-e^{-3x} \right]_0^1$$

$$\Pr(0 \leq X \leq 1) = 0.9502$$

The correct answer is **B**.

$$\mathbf{10} \Pr(X > 2) = \int_2^{\infty} 3e^{-3x} dx$$

$$\Pr(X > 2) = 0.0025$$

The correct answer is **C**.

$$\mathbf{11} \mathbf{a} \int_1^a \log_e(x^2) dx = 1$$

Using CAS,

$$a = 2.1555$$

$$\mathbf{b} \Pr(1.25 \leq X \leq 2) = \int_{1.25}^2 \log_e(x^2) dx$$

$$\Pr(1.25 \leq X \leq 2) = 0.7147$$

$$\begin{aligned}
 \mathbf{12\ a} \quad \Pr(X > 1.2) &= \int_{1.2}^2 \left(\frac{3}{8}x^2\right) dx \\
 &= \frac{3}{8} \left[\frac{1}{3}x^3\right]_{1.2}^2 \\
 &= \frac{3}{8} \left(\frac{1}{3}(2)^3 - \frac{1}{3}\left(\frac{6}{5}\right)^3\right) \\
 &= \frac{3}{8} \left(\frac{8}{3} - \frac{72}{125}\right) \\
 &= \frac{98}{125}
 \end{aligned}$$

$$\begin{aligned}
 \mathbf{b} \quad \Pr(X > 1 | X > 0.5) &= \frac{\Pr(X > 1)}{\Pr(X > 0.5)} \\
 &= \frac{\int_1^2 \left(\frac{3}{8}x^2\right) dx}{\int_{0.5}^2 \left(\frac{3}{8}x^2\right) dx} \\
 &= \frac{\frac{7}{63}}{\frac{8}{64}} \\
 &= \frac{8}{9}
 \end{aligned}$$

$$\begin{aligned}
 \mathbf{c} \quad \Pr(X \leq n) &= \int_0^n \left(\frac{3}{8}x^2\right) dx \\
 \frac{3}{4} &= \frac{3}{8} \left[\frac{1}{3}x^3\right]_0^n \\
 \frac{3}{4} &= \frac{3}{8} \left(\frac{1}{3}n^3\right) \\
 \frac{3}{4} &= \frac{1}{8}n^3 \\
 n^3 &= 6 \\
 n &= 6^{\frac{1}{3}}
 \end{aligned}$$

$$\begin{aligned}
 \mathbf{13\ a} \quad \Pr(-0.25 < Z < 0.25) &= \int_{-0.25}^{0.25} \frac{1}{\pi(z^2 + 1)} dz \\
 \Pr(-0.25 < Z < 0.25) &= 0.1560
 \end{aligned}$$

$$\begin{aligned}
 \mathbf{b} \quad \int_0^a \frac{1}{x^2 + 1} dx &= 0.5 \\
 \text{Using CAS} \\
 a &= 0.55
 \end{aligned}$$

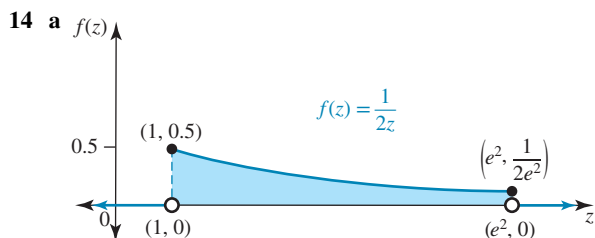

$$\begin{aligned}
 \mathbf{b} \quad \int_1^{e^2} f(z) dz &= \int_1^{e^2} \frac{1}{2z} dz \\
 &= \frac{1}{2} \int_1^{e^2} \frac{1}{z} dz \\
 &= \frac{1}{2} [\log_e(z)]_1^{e^2} \\
 &= \frac{1}{2} (\log_e(e^2) - \log_e(1^2)) \\
 &= \frac{1}{2} \times 2 \log_e(e) \\
 &= 1
 \end{aligned}$$

As $f(z) \geq 0$ and $\int_1^{e^2} f(z) dz = 1$, this is a probability density function.

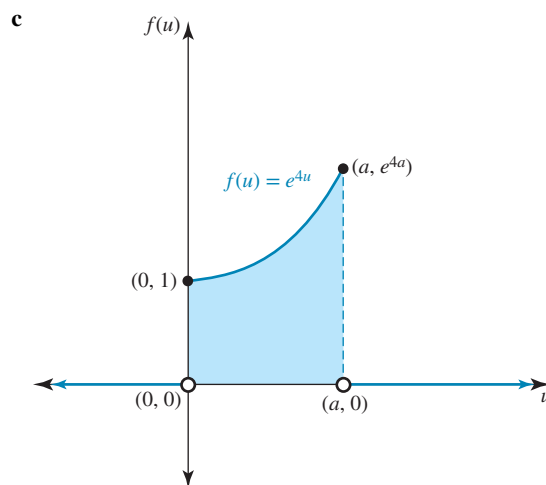

$$\begin{aligned}
 \mathbf{d} \quad \int_0^a f(u) du &= \int_0^a e^{4u} du \\
 &= \left[\frac{1}{4}e^{4u}\right]_0^a \\
 &= \frac{1}{4}e^{4a} - \frac{1}{4}e^0 \\
 &= \frac{1}{4}e^{4a} - \frac{1}{4} \\
 \int_1^{e^2} f(z) dz &= \int_0^a f(u) du \\
 1 &= \frac{1}{4}e^{4a} - \frac{1}{4} \\
 \frac{5}{4} &= \frac{1}{4}e^{4a} \\
 5 &= e^{4a} \\
 \log_e(5) &= 4a \\
 \frac{1}{4} \log_e(5) &= a
 \end{aligned}$$

11.3 Exam questions

$$1 \quad f(x) = \begin{cases} \frac{1}{4} \cos\left(\frac{x}{2}\right) & 3\pi \leq x \leq 5\pi, \\ 0 & \text{elsewhere} \end{cases}$$

$$\Pr(Z < a) = \frac{\sqrt{3} + 2}{4}$$

$$\int_{3\pi}^a \frac{1}{4} \cos\left(\frac{x}{2}\right) dx = \frac{\sqrt{3} + 2}{4}$$

$$\text{LHS} = \left[\frac{1}{2} \sin\left(\frac{x}{2}\right) \right]_{3\pi}^a = \frac{1}{2} \sin\left(\frac{a}{2}\right) - \frac{1}{2} \sin\left(\frac{3\pi}{2}\right)$$

$$\frac{1}{2} \sin\left(\frac{a}{2}\right) + \frac{1}{2} = \frac{\sqrt{3}}{4} + \frac{1}{2}$$

$$\sin\left(\frac{a}{2}\right) = \frac{\sqrt{3}}{2}$$

$$a = \frac{14\pi}{3} \text{ since } 3\pi < a < 5\pi$$

The correct answer is **B**.

$$2 \quad \text{a Show that } \int x^{k-1} \log_e(x) dx = \frac{x^k}{k^2} (k \log_e(x) - 1).$$

Using the product rule in the first term,

$$\frac{d}{dx} \left[\frac{x^k}{k^2} (k \log_e(x) - 1) \right]$$

$$= \frac{d}{dx} \left[\frac{1}{k} x^k \log_e(x) - \frac{x^k}{k^2} \right]$$

$$= \frac{1}{k} \times kx^{k-1} \log_e(x) + \frac{1}{k} \times x^k \times \frac{1}{x} - \frac{k \times x^{k-1}}{k^2}$$

$$= x^{k-1} \log_e(x) + \frac{x^{k-1}}{k} - \frac{x^{k-1}}{k}$$

$$= x^{k-1} \log_e(x)$$

$$\text{It follows that } \int x^{k-1} \log_e(x) dx = \frac{x^k}{k^2} (k \log_e(x) - 1).$$

Award 1 mark for using the product rule.

Award 1 mark for correct integration by recognition.

VCAA Assessment Report note:

This question was attempted well. Most students applied the product rule but struggled with the algebraic manipulation, often confusing k (a constant) with the variable x , which gave them an incorrect result. Students who expanded the expression before differentiating or those who made fewer manipulations tended to score more highly. Some students differentiated the wrong expression.

$$\begin{aligned} \text{b } \Pr\left(X > \frac{1}{e}\right) &= \int_{\frac{1}{e}}^1 -4x \log_e(x) dx \\ &= \left[-x^2 (2 \log_e(x) - 1) \right]_{\frac{1}{e}}^1 \\ &= (- (2 \log_e(1) - 1)) + \left(\frac{1}{e^2} \left(2 \log_e\left(\frac{1}{e}\right) - 1 \right) \right) \\ &= 1 + \frac{1}{e^2} (-2 \log_e(e) - 1) \\ &= 1 - \frac{3}{e^2} \end{aligned}$$

Award 1 mark for correctly applying the result from part **a**.

Award 1 mark for the correct final probability.

VCAA Assessment Report note:

Students made the connection to part **a**. and determined $k = 2$. However, few managed to find the correct antiderivative.

Evaluation after substituting terminals was problematic. Some used incorrect terminals.

$$\begin{aligned} \text{3 a } \int_0^a f(z) dz &= 1 \\ \int_0^a e^{-\frac{z}{3}} dz &= 1 \\ \left[-3e^{-\frac{z}{3}} \right]_0^a &= 1 \\ -3e^{-\frac{a}{3}} + 3e^0 &= 1 && [1 \text{ mark}] \\ -3e^{-\frac{a}{3}} + 3 &= 1 \\ -3e^{-\frac{a}{3}} &= -2 \\ e^{-\frac{a}{3}} &= \frac{2}{3} \\ \log_e\left(\frac{2}{3}\right) &= -\frac{a}{3} \\ -3 \log_e\left(\frac{2}{3}\right) &= a \\ -\log_e\left(\frac{3}{2}\right)^{-1} &= a \\ a &= 3 \log_e\left(\frac{3}{2}\right) && [1 \text{ mark}] \end{aligned}$$

$$\begin{aligned} \text{b } \Pr(0 < Z < 0.7) &= \int_0^{0.7} e^{-\frac{z}{3}} dz \\ \Pr(0 < Z < 0.7) &= \left[-3e^{-\frac{z}{3}} \right]_0^{0.7} \\ \Pr(0 < Z < 0.7) &= 0.6243 && [1 \text{ mark}] \end{aligned}$$

$$\begin{aligned} \text{c } \Pr(Z < 0.7 | Z > 0.2) &= \frac{\Pr(0.2 < Z < 0.7)}{\Pr(Z > 0.2)} \\ \Pr(0.2 < Z < 0.7) &= \int_{0.2}^{0.7} e^{-\frac{z}{3}} dz \\ &= \left[-3e^{-\frac{z}{3}} \right]_{0.2}^{0.7} \\ &= 0.4308 && [1 \text{ mark}] \end{aligned}$$

$$\begin{aligned} \Pr(Z > 0.2) &= \int_{0.2}^{3 \log_e\left(\frac{3}{2}\right)} e^{-\frac{z}{3}} dz \\ &= \left[-3e^{-\frac{z}{3}} \right]_{0.2}^{3 \log_e\left(\frac{3}{2}\right)} \\ &= 0.8065 \\ \frac{\Pr(0.2 < Z < 0.7)}{\Pr(Z > 0.2)} &= \frac{0.43085}{0.8065} = 0.5342 && [1 \text{ mark}] \end{aligned}$$

$$\begin{aligned} \text{d } \Pr(Z \leq b) &= 0.54 \\ \int_0^b e^{-\frac{z}{3}} dz &= 0.54 \\ \left[-3e^{-\frac{z}{3}} \right]_0^b &= 0.54 && [1 \text{ mark}] \\ \text{Using CAS,} \\ b &= 0.60 && [1 \text{ mark}] \end{aligned}$$

11.4 Measures of centre and spread

11.4 Exercise

1 a Mean:

$$\begin{aligned} E(X) &= \int_0^2 x \left(-\frac{1}{2}x + 1 \right) dx \\ &= \int_0^2 \left(-\frac{1}{2}x^2 + x \right) dx \\ &= \left[-\frac{x^3}{6} + \frac{x^2}{2} \right]_0^2 \\ &= \left(-\frac{8}{6} + \frac{4}{2} - (0) \right) \\ &= -\frac{4}{3} + 2 \\ &= \frac{2}{3} \end{aligned}$$

b Mean:

$$\begin{aligned} E(X) &= \int_0^{0.5} x \times 2 dx \\ &= 2 \int_0^{0.5} x dx \\ &= 2 \left[\frac{x^2}{2} \right]_0^{0.5} \\ &= 2 \left(\frac{\left(\frac{1}{2}\right)^2}{2} - 0 \right) \\ &= 2 \left(\frac{1}{8} \right) \\ &= \frac{1}{4} \end{aligned}$$

This can also be found by symmetry. As the graph is symmetrical, the mean is halfway between the lower and upper bounds of 0 and 0.5, respectively.

$$\begin{aligned} 2 \text{ a } E(X) &= \int_0^{0.5} x \times 4x dx \\ &= 4 \int_0^{0.5} x^2 dx \\ &= 4 \left[\frac{x^3}{3} \right]_0^{0.5} \\ &= 4 \left(\frac{\left(\frac{1}{2}\right)^3}{3} - 0 \right) \\ &= 4 \left(\frac{1}{24} \right) \\ &= \frac{1}{6} \end{aligned}$$

$$\begin{aligned} E(X^2) &= \int_0^{0.5} x^2 \times 4x dx \\ &= 4 \int_0^{0.5} x^3 dx \\ &= 4 \left[\frac{x^4}{4} \right]_0^{0.5} \\ &= 4 \left(\frac{\left(\frac{1}{2}\right)^4}{4} - 0 \right) \\ &= 4 \left(\frac{1}{64} \right) \\ &= \frac{1}{16} \end{aligned}$$

$$\begin{aligned} \text{Var}(X) &= E(X^2) - [E(X)]^2 \\ &= \frac{1}{16} - \left(\frac{1}{6} \right)^2 \\ &= \frac{1}{16} - \frac{1}{36} \\ &= \frac{9}{144} - \frac{4}{144} \\ &= \frac{5}{144} \end{aligned}$$

$$\begin{aligned} \text{b } E(X) &= \int_1^3 x \times 0.5 dx \\ &= 0.5 \int_1^3 x dx \\ &= 0.5 \left[\frac{x^2}{2} \right]_1^3 \\ &= 0.5 \left(\frac{9}{2} - \frac{1}{2} \right) \\ &= 0.5 \times 4 \\ &= 2 \end{aligned}$$

$$\begin{aligned} E(X^2) &= \int_1^3 x^2 \times 0.5 dx \\ &= 0.5 \int_1^3 x^2 dx \\ &= 0.5 \left[\frac{x^3}{3} \right]_1^3 \\ &= 0.5 \left(\frac{27}{3} - \frac{1}{3} \right) \\ &= \frac{1}{2} \left(\frac{26}{3} \right) \\ &= \frac{13}{3} \end{aligned}$$

$$\begin{aligned} \text{Var}(X) &= E(X^2) - [E(X)]^2 \\ &= \frac{13}{3} - (2)^2 \\ &= \frac{13}{3} - 4 \\ &= \frac{1}{3} \end{aligned}$$

$$\begin{aligned}
 3 \text{ a } \quad \int_1^a \frac{1}{\sqrt{z}} dz &= 1 \\
 \int_1^a \left[z^{-\frac{1}{2}} \right] dz &= 1 \\
 \left[2z^{\frac{1}{2}} \right]_1^a &= 1 \\
 2\sqrt{a} - 2\sqrt{1} &= 1 \\
 2\sqrt{a} &= 3 \\
 \sqrt{a} &= \frac{3}{2} \\
 a &= \frac{9}{4}
 \end{aligned}$$

$$\begin{aligned}
 \text{b. } E(Z) &= \int_1^{\frac{9}{4}} z f(z) dz \\
 E(Z) &= \int_1^{\frac{9}{4}} \sqrt{z} dz \\
 E(Z) &= \left[\frac{2}{3} \sqrt{z^3} \right]_1^{\frac{9}{4}} \\
 E(Z) &= \frac{2}{3} \sqrt{\left(\frac{9}{4}\right)^3} - \frac{2}{3} \sqrt{1^3} \\
 E(Z) &= \frac{2}{3} \left(\left(\frac{3}{2}\right)^2\right)^{\frac{3}{2}} - \frac{2}{3} \\
 E(Z) &= \frac{2}{3} \times \frac{27}{8} - \frac{2}{3} \\
 E(Z) &= \frac{9}{4} - \frac{2}{3} \\
 E(Z) &= \frac{27}{12} - \frac{8}{12} \\
 E(Z) &= \frac{19}{12}
 \end{aligned}$$

$$\begin{aligned}
 4 \text{ a } \quad \int_1^a \frac{3}{z^2} dz &= 1 \\
 \int_1^a 3z^{-2} dz &= 1 \\
 \left[-3z^{-1} \right]_1^a &= 1 \\
 \left[-\frac{3}{z} \right]_1^a &= 1 \\
 -\frac{3}{a} + \frac{3}{1} &= 1 \\
 3a - 3 &= a \\
 2a &= 3 \\
 a &= \frac{3}{2}
 \end{aligned}$$

$$\begin{aligned}
 \text{b } E(Z) &= \int_1^{\frac{3}{2}} z f(z) dz \\
 E(Z) &= \int_1^{\frac{3}{2}} \left(z \times \frac{3}{z^2} \right) dz
 \end{aligned}$$

$$\begin{aligned}
 E(Z) &= \int_1^{\frac{3}{2}} \frac{3}{z} dz \\
 E(Z) &= \left[3 \log_e(z) \right]_1^{\frac{3}{2}} \\
 E(Z) &= 3 \log_e\left(\frac{3}{2}\right) - 3 \log_e(1) \\
 E(Z) &= 3 \log_e\left(\frac{3}{2}\right)
 \end{aligned}$$

$$\begin{aligned}
 \text{c } \int_1^p f(z) dz &= 0.5 \\
 \int_1^p \frac{3}{z^2} dz &= 0.5 \\
 \left[-\frac{3}{z} \right]_1^p &= \frac{1}{2} \\
 -\frac{3}{p} + \frac{3}{1} &= \frac{1}{2} \\
 -6 + 6p &= p \\
 5p &= 6 \\
 p &= \frac{6}{5}
 \end{aligned}$$

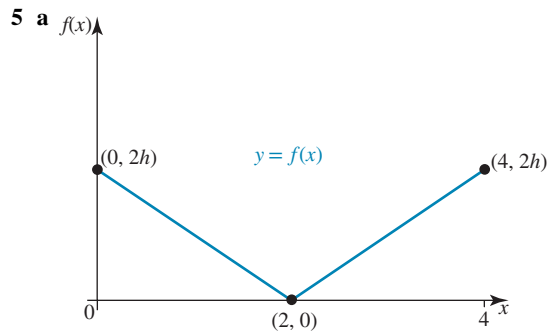

$$\begin{aligned}
 \int_0^4 f(x) dx &= 1 \\
 \left(\frac{1}{2} \times 2 \times 2h\right) + \left(\frac{1}{2} \times 2 \times 2h\right) &= 1 \\
 2h + 2h &= 1 \\
 4h &= 1 \\
 h &= \frac{1}{4}
 \end{aligned}$$

$$\begin{aligned}
 \text{b } E(X) &= \int_0^4 x f(x) dx \\
 E(X) &= \int_0^2 \left(-\frac{1}{4}x^2 + \frac{1}{2}x\right) dx + \int_2^4 \left(\frac{1}{4}x^2 - \frac{1}{2}x\right) dx \\
 E(X) &= \left[-\frac{1}{12}x^3 + \frac{1}{4}x^2\right]_0^2 + \left[\frac{1}{12}x^3 - \frac{1}{4}x^2\right]_2^4 \\
 E(X) &= \left(-\frac{1}{12}(2)^3 + \frac{1}{4}(2)^2\right) - 0 + \left(\frac{1}{12}(4)^3 - \frac{1}{4}(4)^2\right) \\
 &\quad - \left(\frac{1}{12}(2)^3 - \frac{1}{4}(2)^2\right) \\
 E(X) &= -\frac{2}{3} + 1 + \frac{16}{3} - 4 - \frac{2}{3} + 1 \\
 E(X) &= 4 - 4 + 2 \\
 E(X) &= 2
 \end{aligned}$$

$$\begin{aligned} \text{c } E(X^2) &= \int_0^4 x^2 f(x) dx \\ E(X^2) &= \int_0^2 \left(-\frac{1}{4}x^3 + \frac{1}{2}x^2\right) dx + \int_2^4 \left(\frac{1}{4}x^3 - \frac{1}{2}x^2\right) dx \\ E(X^2) &= \left[-\frac{1}{16}x^4 + \frac{1}{6}x^3\right]_0^2 + \left[\frac{1}{16}x^4 - \frac{1}{6}x^3\right]_2^4 \\ E(X^2) &= \left(-\frac{1}{16}(2)^4 + \frac{1}{6}(2)^3\right) - 0 + \left(\frac{1}{16}(4)^4 - \frac{1}{6}(4)^3\right) \\ &\quad - \left(\frac{1}{16}(2)^4 - \frac{1}{6}(2)^3\right) \end{aligned}$$

$$E(X^2) = -1 + \frac{4}{3} + 16 - \frac{32}{3} - 1 + \frac{4}{3}$$

$$E(X^2) = 14 - 8$$

$$E(X^2) = 6$$

$$\text{Var}(X) = E(X^2) - [E(X)]^2$$

$$\text{Var}(X) = 6 - 2^2$$

$$\text{Var}(X) = 2$$

$$\text{6 a } \int_0^1 \frac{1}{2\sqrt{x}} dx = \int_0^1 \frac{1}{2} x^{-\frac{1}{2}} dx$$

$$\int_0^1 \frac{1}{2\sqrt{x}} dx = \frac{1}{2} \int_0^1 x^{-\frac{1}{2}} dx$$

$$\int_0^1 \frac{1}{2\sqrt{x}} dx = \frac{1}{2} \left[2x^{\frac{1}{2}}\right]_0^1$$

$$\int_0^1 \frac{1}{2\sqrt{x}} dx = \frac{1}{2} (2\sqrt{1} - 2\sqrt{0})$$

$$\int_0^1 \frac{1}{2\sqrt{x}} dx = \frac{1}{2} \times 2$$

$$\int_0^1 \frac{1}{2\sqrt{x}} dx = 1$$

As $f(x) \geq 0$ for all x -values, and the area under the curve = 1, $f(x)$ is a probability density function.

$$\text{b } E(X) = \int_0^1 xf(x) dx$$

$$E(X) = \int_0^1 \frac{x}{2\sqrt{x}} dx$$

$$E(X) = \frac{1}{2} \int_0^1 \sqrt{x} dx$$

$$E(X) = \frac{1}{2} \left[\frac{2}{3}x^{\frac{3}{2}}\right]_0^1$$

$$E(X) = \frac{1}{2} \left(\frac{2}{3}\sqrt{1^3} - \frac{2}{3}\sqrt{0^3}\right)$$

$$E(X) = \frac{1}{2} \times \frac{2}{3}$$

$$E(X) = \frac{1}{3}$$

$$\text{7 a } \int_0^a y^{\frac{1}{2}} dy = 1$$

$$\left[\frac{2}{3}y^{\frac{3}{2}}\right]_0^a = 1$$

$$\frac{2}{3}a^{\frac{3}{2}} - \frac{2}{3}0^{\frac{3}{2}} = 1$$

$$a^{\frac{3}{2}} = \frac{3}{2}$$

$$a = 1.3104$$

$$\text{b } E(Y) = \int_0^{1.3104} y\sqrt{y} dy$$

$$E(Y) = \int_0^{1.3104} y^{\frac{3}{2}} dy$$

$$E(Y) = \left[\frac{2}{5}y^{\frac{5}{2}}\right]_0^{1.3104}$$

$$E(Y) = 0.7863$$

$$\text{c } \int_0^k \sqrt{y} dy = 0.6$$

$$\left[\frac{2}{3}y^{\frac{3}{2}}\right]_0^k = 0.6$$

$$k = 0.9322$$

$$\text{8 } E(Z) = \int_{\frac{1}{2}}^{\frac{e}{2}} 2z \log_e(2z) dz$$

$$E(Z) = 1.0486$$

$$\text{Var}(Z) = E(Z^2) - [E(Z)]^2$$

$$E(Z^2) = \int_{\frac{1}{2}}^{\frac{e}{2}} 2z^2 \log_e(2z) dz$$

$$E(Z^2) = 1.1436$$

$$\text{Var}(Z) = 1.1436 - (1.0486)^2$$

$$\text{Var}(Z) = 0.0440$$

$$\text{SD}(Z) = \sqrt{0.0440}$$

$$\text{SD}(Z) = 0.2098$$

$$\text{9 } E(X) = \int_0^{\infty} 3xe^{-3xdx}$$

$$E(X) = \frac{1}{3}$$

$$\text{Var}(X) = E(X^2) - [E(X)]^2$$

$$E(X^2) = \int_0^{\infty} 3x^2 e^{-3x} dx$$

$$E(X^2) = \frac{2}{9}$$

$$\text{Var}(X) = \frac{2}{9} - \left(\frac{1}{3}\right)^2$$

$$\text{Var}(X) = \frac{2}{9} - \frac{1}{9} = \frac{1}{9}$$

$$SD(X) = \sqrt{\frac{1}{9}}$$

$$SD(X) = \frac{1}{3}$$

$$10 \text{ a } E(T) = \int_0^{\infty} tf(t)dt$$

$$E(T) = \int_0^{\infty} 2te^{-2t} dt$$

$$E(T) = 0.5 \text{ min}$$

$$b \ E(T^2) = \int_0^{\infty} t^2 f(t)dt$$

$$E(T^2) = \int_0^{\infty} 2t^2 e^{-2t} dt$$

$$E(T^2) = 0.5$$

$$\text{Var}(T) = E(T^2) - [E(T)]^2$$

$$\text{Var}(T) = 0.5 - 0.5^2$$

$$\text{Var}(T) = 0.5 - 0.25$$

$$\text{Var}(T) = 0.25$$

$$SD(T) = \sqrt{0.25} = 0.5 \text{ min}$$

$$11 \text{ a } \int_0^{Q_1} f(y)dy = 0.25$$

$$\int_0^{Q_1} \frac{y^2}{3} dy = 0.25$$

$$\left[\frac{y^3}{9} \right]_0^{Q_1} = 0.25$$

$$\frac{Q_1^3}{9} - \frac{0^3}{9} = 0.25$$

$$Q_1^3 = 2.25$$

$$Q_1 = \sqrt[3]{2.25}$$

$$Q_1 = 1.3104$$

$$\int_0^{Q_3} f(y)dy = 0.75$$

$$\int_0^{Q_3} \frac{y^2}{3} dy = 0.75$$

$$\left[\frac{y^3}{9} \right]_0^{Q_3} = 0.75$$

$$\frac{Q_3^3}{9} - \frac{0^3}{9} = 0.75$$

$$Q_3^3 = 6.75$$

$$Q_3 = \sqrt[3]{6.75}$$

$$Q_3 = 1.8899$$

b The interquartile range is $Q_3 - Q_1 = 1.8899 - 1.3104 = 0.5795$

$$12 \text{ a } \int_1^8 \frac{a}{z} dz = 1$$

$$a \int_1^8 \frac{1}{z} dz = 1$$

$$a [\log_e(z)]_1^8 = 1$$

$$a (\log_e(8) - \log_e(1)) = 1$$

$$a \log_e(8) = 1$$

$$a = \frac{1}{\log_e(8)}$$

$$a = 0.4809$$

$$b \ E(Z) = \int_1^8 \left(z \times \frac{0.4809}{z} \right) dz$$

$$E(Z) = \int_1^8 0.4809 dz$$

$$E(Z) = [0.4809z]_1^8$$

$$E(Z) = 0.4809(8) - 0.4809(1)$$

$$E(Z) = 3.3663$$

$$c \ E(Z^2) = \int_1^8 \left(z^2 \times \frac{0.4809}{z} \right) dz$$

$$E(Z^2) = \int_1^8 0.4809z dz$$

$$E(Z^2) = [0.2405z^2]_1^8$$

$$E(Z^2) = 0.2405(8)^2 - 0.2405(1)^2$$

$$E(Z^2) = 15.1515$$

$$\text{Var}(Z) = E(Z^2) - [E(Z)]^2$$

$$\text{Var}(Z) = 15.1515 - 3.3663^2$$

$$\text{Var}(Z) = 3.8195$$

$$SD(Z) = \sqrt{3.8195} = 1.9571$$

$$d \quad \int_1^{Q_1} \frac{0.4809}{z} dz = 0.25 \quad \int_1^{Q_3} \frac{0.4809}{z} dz = 0.75$$

$$0.4809 [\log_e(z)]_1^{Q_1} = 0.25 \quad 0.4809 [\log_e(z)]_1^{Q_3} = 0.75$$

$$Q_1 = 1.6817$$

$$Q_3 = 4.7568$$

The interquartile range is

$$Q_3 - Q_1 = 4.7568 - 1.6817$$

$$= 3.0751$$

$$e \text{ Range} = 8 - 1 = 7$$

$$13 \text{ a } \int_0^{\pi} \frac{1}{\pi} (\sin(2x) + 1) dx$$

$$= \frac{1}{\pi} \int_0^{\pi} (\sin(2x) + 1) dx$$

$$= \frac{1}{\pi} \left[-\frac{1}{2} \cos(2x) + x \right]_0^{\pi}$$

$$= \frac{1}{\pi} \left(\left(-\frac{1}{2} \cos(2\pi) + \pi \right) - \left(-\frac{1}{2} \cos(0) + 0 \right) \right)$$

$$= \frac{1}{\pi} \left(-\frac{1}{2} + \pi + \frac{1}{2} \right)$$

$$= 1$$

As $f(x) \geq 0$ for all values of x and the area under the curve is 1, $f(x)$ is a probability density function.

$$b \ E(X) = \int_0^{\pi} \frac{x}{\pi} (\sin(2x) + 1) dx$$

$$E(X) = 1.0708$$

c i $E(X^2) = \int_0^{\pi} \frac{x^2}{\pi} (\sin(2x) + 1) dx$
 $E(X^2) = 1.7191$
 $\text{Var}(X) = E(X^2) - [E(X)]^2$
 $\text{Var}(X) = 1.7191 - 1.0708^2$
 $\text{Var}(X) = 0.5725$

ii $\text{SD}(X) = \sqrt{0.5725} = 0.7566$

14 a $\int_2^{7.9344} f(y) dy = \int_2^{7.9344} 0.2 \log_e \left(\frac{y}{2} \right) dy = 1$

b $E(Y) = \int_2^{7.9344} 0.2y \log_e \left(\frac{y}{2} \right) dy = 5.7278$

c $E(Y^2) = \int_2^{7.9344} 0.2y^2 \log_e \left(\frac{y}{2} \right) dy = 34.9677$
 $\text{Var}(Y) = E(Y^2) - [E(Y)]^2$
 $\text{Var}(Y) = 34.9677 - 5.7278^2$
 $\text{Var}(Y) = 2.1600$
 $\text{SD}(Y) = \sqrt{2.1600} = 1.4697$

d The range is $7.9344 - 2 = 5.9344$.

15 a $\int_1^a \sqrt{z-1} dz = 1$
 $\int_1^a (z-1)^{\frac{1}{2}} dz = 1$
 $\left[\frac{2}{3} (z-1)^{\frac{3}{2}} \right]_1^a = 1$
 $\left[\frac{2}{3} (z-1)^{\frac{3}{2}} \right]_1^a = 1$
 $\left[\frac{2}{3} \sqrt{(z-1)^3} \right]_1^a = 1$
 $\frac{2}{3} \sqrt{(a-1)^3} - \frac{2}{3} \sqrt{(1-1)^3} = 1$
 $\sqrt{(a-1)^3} = \frac{3}{2}$
 $(a-1)^3 = \frac{9}{4}$
 $a = 2.3104$

b i $E(Z) = \int_1^{2.3104} z \sqrt{z-1} dz = 1.7863$

ii $E(Z^2) = \int_1^{2.3104} z^2 \sqrt{z-1} dz = 3.3085$

iii $\text{Var}(Z) = E(Z^2) - [E(Z)]^2$
 $\text{Var}(Z) = 3.3085 - 1.7863^2$
 $\text{Var}(Z) = 0.1176$

iv $\text{SD}(Z) = \sqrt{0.1176} = 0.3430$

16 $E(X) = \int_0^2 xf(x) dx = 1$
 $\int_0^2 x(ax - bx^2) dx = 1$
 $\int_0^2 (ax^2 - bx^3) dx = 1$
 $\left[\frac{a}{3}x^3 - \frac{b}{4}x^4 \right]_0^2 = 1$
 $\left(\frac{a}{3}(2)^3 - \frac{b}{4}(2)^4 \right) - 0 = 1$
 $\left[\frac{a}{3}x^3 - \frac{b}{4}x^4 \right]_0^2 = 1$
 $\left(\frac{a}{3}(2)^3 - \frac{b}{4}(2)^4 \right) - 0 = 1$
 $\frac{8a}{3} - 4b = 1$
 $8a - 12b = 3$ [1]

$\int_0^2 f(x) dx = 1$
 $\int_0^2 (ax - bx^2) dx = 1$
 $\left[\frac{a}{2}x^2 - \frac{b}{3}x^3 \right]_0^2 = 1$
 $\left(\frac{a}{2}(2)^2 - \frac{b}{3}(2)^3 \right) - 0 = 1$
 $2a - \frac{8}{3}b = 1$
 $6a - 8b = 3$ [2]

$8a - 12b = 3$ [1]
 $6a - 8b = 3$ [2]
 $[1] \times 3:$
 $24a - 36b = 9$ [3]
 $[2] \times 4:$
 $24a - 32b = 12$ [4]
 $[4] - [3]:$
 $4b = 3$
 $b = \frac{3}{4}$

Substitute $b = \frac{3}{4}$ into [1]:
 $8a - 12 \left(\frac{3}{4} \right) = 3$
 $8a - 9 = 3$
 $8a = 12$
 $a = \frac{3}{2}$

17 a $y = \sqrt{4-x^2}$
 $y = (4-x^2)^{\frac{1}{2}}$
 $\frac{dy}{dx} = \frac{1}{2}(-2x)(4-x^2)^{-\frac{1}{2}}$
 $\frac{dy}{dx} = -\frac{x}{\sqrt{4-x^2}}$

$$\mathbf{b} \ E(X) = \int_0^{\sqrt{3}} xf(x) dx$$

$$E(X) = \int_0^{\sqrt{3}} \frac{3x}{\pi\sqrt{4-x^2}} dx$$

$$E(X) = -\frac{3}{\pi} \int_0^{\sqrt{3}} \left(-\frac{x}{\sqrt{4-x^2}} \right) dx$$

$$E(X) = -\frac{3}{\pi} \left[\sqrt{4-x^2} \right]_0^{\sqrt{3}}$$

$$E(X) = -\frac{3}{\pi} \left(\sqrt{4 - (\sqrt{3})^2} - \sqrt{4 - 0^2} \right)$$

$$E(X) = -\frac{3}{\pi} (\sqrt{1} - \sqrt{4})$$

$$E(X) = -\frac{3}{\pi} \times -1$$

$$E(X) = \frac{3}{\pi}$$

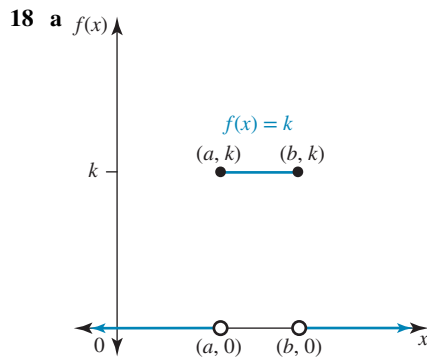

$$\mathbf{b} \ \int_a^b k dx = 1$$

$$[kx]_a^b = 1$$

$$kb - ka = 1$$

$$k(b-a) = 1$$

$$k = \frac{1}{b-a}$$

$$\mathbf{c} \ E(X) = \int_a^b xf(x) dx$$

$$E(X) = \int_a^b kx dx$$

$$E(X) = \left[\frac{k}{2} x^2 \right]_a^b$$

$$E(X) = \frac{k}{2} b^2 - \frac{k}{2} a^2$$

$$E(X) = \frac{k}{2} (b^2 - a^2)$$

$$E(X) = \frac{1}{2(b-a)} \times \frac{(b-a)(b+a)}{1}$$

$$E(X) = \frac{b+a}{2}$$

$$\mathbf{d} \ E(X^2) = \int_a^b x^2 f(x) dx$$

$$E(X^2) = \int_a^b kx^2 dx$$

$$E(X^2) = \left[\frac{k}{3} x^3 \right]_a^b$$

$$E(X^2) = \frac{k}{3} b^3 - \frac{k}{3} a^3$$

$$E(X^2) = \frac{k}{3} (b^3 - a^3)$$

$$E(X^2) = \frac{1}{3(b-a)} \times \frac{(b-a)(b^2 + ba + a^2)}{1}$$

$$E(X^2) = \frac{b^2 + ba + a^2}{3}$$

$$\text{Var}(X) = E(X^2) - [E(X)]^2$$

$$\text{Var}(X) = \frac{b^2 + ba + a^2}{3} - \left(\frac{b+a}{2} \right)^2$$

$$\text{Var}(X) = \frac{b^2 + ba + a^2}{3} - \frac{b^2 + 2ba + a^2}{4}$$

$$\text{Var}(X) = \frac{4b^2 + 4ba + 4a^2 - 3b^2 - 6ba - 3a^2}{12}$$

$$\text{Var}(X) = \frac{4b^2 + 4ba + 4a^2 - 3b^2 - 6ba - 3a^2}{12}$$

$$\text{Var}(X) = \frac{b^2 - 2ba + a^2}{12}$$

$$\text{Var}(X) = \frac{(b-a)^2}{12} = \frac{(a-b)^2}{12}$$

11.4 Exam questions

$$\mathbf{1} \ \mathbf{a} \quad f(x) = \begin{cases} \frac{k}{x^2}, & 1 \leq x \leq 2 \\ 0, & \text{elsewhere} \end{cases}$$

$$\int_1^2 \frac{k}{x^2} dx = 1$$

$$k \int_1^2 x^{-2} dx = k \left[-\frac{1}{x} \right]_1^2 = k \left(-\frac{1}{2} + 1 \right) = \frac{k}{2} = 1$$

Award 1 mark for the correct proof.

$$\mathbf{b} \ E(X) = \int_a^b xf(x) dx = \int_1^2 \frac{2}{x} dx$$

$$E(X) = \left[2 \log_e(x) \right]_1^2 = 2 (\log_e(2) - \log_e(1))$$

$$E(X) = 2 \log_e(2) = \log_e(4)$$

Award 1 mark for solving for expectation.

Award 1 mark for the correct expectation.

$$\mathbf{2} \ \text{Since the total area is } 1, \frac{1}{6} (a-2) = 1 \Rightarrow a = 8.$$

$$f(x) = \begin{cases} \frac{1}{6}, & 2 \leq x \leq 8 \\ 0, & \text{otherwise} \end{cases}$$

$$\begin{aligned} E(X) &= \int_2^8 \frac{x}{6} dx \\ &= \left[\frac{1}{12} x^2 \right]_2^8 \\ &= \frac{1}{12} (8^2 - 2^2) \\ &= 5 \end{aligned}$$

The correct answer is **B**.

$$\begin{aligned} 3 \quad \frac{d}{dx} \left(x \sin \left(\frac{\pi x}{4} \right) \right) &= \frac{\pi x}{4} \cos \left(\frac{\pi x}{4} \right) + \sin \left(\frac{\pi x}{4} \right) \\ \text{So, } \int \frac{\pi x}{4} \cos \left(\frac{\pi x}{4} \right) + \sin \left(\frac{\pi x}{4} \right) dx &= x \sin \left(\frac{\pi x}{4} \right) \\ \int \frac{\pi x}{4} \cos \left(\frac{\pi x}{4} \right) dx &= x \sin \left(\frac{\pi x}{4} \right) - \int \sin \left(\frac{\pi x}{4} \right) dx \\ \int \frac{\pi x}{4} \cos \left(\frac{\pi x}{4} \right) dx &= x \sin \left(\frac{\pi x}{4} \right) + \frac{4}{\pi} \cos \left(\frac{\pi x}{4} \right) \\ E(X) &= \int_0^2 x \times \frac{\pi}{4} \cos \left(\frac{\pi}{4} \right) dx \\ &= \left[x \sin \left(\frac{\pi x}{4} \right) + \frac{4}{\pi} \cos \left(\frac{\pi x}{4} \right) \right]_0^2 \\ &= 2 \sin \left(\frac{2}{\pi} \right) + \frac{4}{\pi} \cos \left(\frac{2\pi}{4} \right) - \left(0 + \frac{4}{\pi} \cos(0) \right) \\ &= 2 - \frac{4}{\pi} \end{aligned}$$

Award 1 mark for the setup of the integral and using integration by recognition.

Award 1 mark for the evaluation of $E(X)$.

11.5 Linear transformations

11.5 Exercise

1 $E(Y) = 4$ and $\text{Var}(Y) = 3$

a $E(2Y - 3) = 2E(Y) - 3 = 2(4) - 3 = 8 - 3 = 5$

b $\text{Var}(2Y - 3) = 2^2 \text{Var}(Y) = 4 \times 3 = 12$

c $\text{Var}(Y) = E(Y^2) - [E(Y)]^2$

$$3 = E(Y^2) - (4)^2$$

$$3 = E(Y^2) - 16$$

$$E(Y^2) = 19$$

d $E(Y(Y - 1)) = E(Y^2 - Y) = E(Y^2) - E(Y) = 19 - 4 = 15$

2 $E(Z) = 5$ and $\text{Var}(Z) = 2$

a $E(3Z - 2) = 3E(Z) - 2 = 3(5) - 2 = 13$

b $\text{Var}(3Z - 2) = 3^2 \text{Var}(Z) = 9(2) = 18$

c $\text{Var}(Z) = E(Z^2) - [E(Z)]^2$

$$2 = E(Z^2) - 5^2$$

$$2 = E(Z^2) - 25$$

$$E(Z^2) = 27$$

d $E\left(\frac{1}{3}Z^2 - 1\right) = \frac{1}{3}E(Z^2) - 1 = \frac{27}{3} - 1 = 8$

3 a $\int_{-2}^2 f(x) dx = 1$

$$\int_{-2}^0 (-kx) dx + \int_0^2 (kx) dx = 1$$

$$\left[-\frac{k}{2} x^2 \right]_{-2}^0 + \left[\frac{k}{2} x^2 \right]_0^2 = 1$$

$$\left(-\frac{k}{2}(0)^2 + \frac{k}{2}(-2)^2 \right) + \left(\frac{k}{2}(2)^2 - \frac{k}{2}(0)^2 \right) = 1$$

$$2k + 2k = 1$$

$$4k = 1$$

$$k = \frac{1}{4}$$

b $E(X) = \int_{-2}^2 xf(x) dx$

$$E(X) = \int_{-2}^0 \left(x \times -\frac{x}{4} \right) dx + \int_0^2 \left(x \times \frac{x}{4} \right) dx$$

$$E(X) = \int_{-2}^0 -\frac{x^2}{4} dx + \int_0^2 \frac{x^2}{4} dx$$

$$E(X) = \left[-\frac{x^3}{12} \right]_{-2}^0 + \left[\frac{x^3}{12} \right]_0^2$$

$$E(X) = \left(-\frac{0^3}{12} + \frac{(-2)^3}{12} \right) + \left(\frac{2^3}{12} - \frac{0^3}{12} \right)$$

$$E(X) = -\frac{3}{4} + \frac{3}{4}$$

$$E(X) = 0$$

$$\text{Var}(X) = E(X^2) - [E(X)]^2$$

$$E(X^2) = \int_{-2}^2 x^2 f(x) dx$$

$$E(X^2) = \int_{-2}^0 \left(x^2 \times -\frac{x}{4} \right) dx + \int_0^2 \left(x^2 \times \frac{x}{4} \right) dx$$

$$E(X^2) = \int_{-2}^0 \left(-\frac{x^3}{4} \right) dx + \int_0^2 \left(\frac{x^3}{4} \right) dx$$

$$E(X^2) = \left[-\frac{x^4}{16} \right]_{-2}^0 + \left[\frac{x^4}{12} \right]_0^2$$

$$E(X^2) = \left(-\frac{0^4}{16} + \frac{(-2)^4}{16} \right) + \left(\frac{2^4}{16} - \frac{0^4}{16} \right)$$

$$E(X^2) = -1 + 1$$

$$E(X^2) = 2$$

$$\text{Var}(X) = 2 - 0^2 = 2$$

c $E(5X + 3) = 5E(X) + 3 = 5(0) + 3 = 3$

$$\text{Var}(5X + 3) = 5^2 \text{Var}(X) = 25 \times 2 = 50$$

d $E((3X - 2)^2) = E(9X^2 - 12X + 4)$

$$= 9E(X^2) - 12E(X) + 4$$

$$= 9(2) - 12(0) + 4$$

$$= 22$$

4 a $\int_0^2 mx(2 - x) dx = 1$

$$\int_0^2 (2mx - mx^2) dx = 1$$

$$\left[mx^2 - \frac{m}{3} x^3 \right]_0^2 = 1$$

$$\left(m(2)^2 - \frac{m}{3}(2)^3 \right) - 0 = 1$$

$$4m - \frac{8}{3}m = 1$$

$$\frac{12m - 8m}{3} = 1$$

$$4m = 3$$

$$m = \frac{3}{4}$$

$$\mathbf{b} \quad E(X) = \int_0^2 xf(x)dx$$

$$E(X) = \int_0^2 \frac{3}{4}x^2(2-x)dx$$

$$E(X) = \int_0^2 \left(\frac{3}{2}x^2 - \frac{3}{4}x^3 \right) dx$$

$$E(X) = \left[\frac{1}{2}x^3 - \frac{3}{16}x^4 \right]_0^2$$

$$E(X) = \left(\frac{1}{2}(2)^3 - \frac{3}{16}(2)^4 \right) - 0$$

$$E(X) = 4 - 3$$

$$E(X) = 1$$

$$E(X^2) = \int_0^2 x^2 f(x)dx$$

$$E(X^2) = \int_0^2 \frac{3}{4}x^3(2-x)dx$$

$$E(X^2) = \int_0^2 \left(\frac{3}{2}x^3 - \frac{3}{4}x^4 \right) dx$$

$$E(X^2) = \left[\frac{3}{8}x^4 - \frac{3}{20}x^5 \right]_0^2$$

$$E(X^2) = \left(\frac{3}{8}(2)^4 - \frac{3}{20}(2)^5 \right) - 0$$

$$E(X^2) = 6 - 4.8$$

$$E(X^2) = 1.2$$

$$\text{Var}(X) = E(X^2) - [E(X)]^2$$

$$\text{Var}(X) = 1.2 - 1^2$$

$$\text{Var}(X) = 0.2$$

$$\mathbf{c} \quad E(5 - 2X) = 5 - 2E(X) = 5 - 2(1) = 3$$

$$\text{Var}(5 - 2X) = (-2)^2 \text{Var}(X) = 4 \times 0.2 = 0.8$$

$$\mathbf{5} \quad \mathbf{a} \quad \int_0^a \frac{2}{z+1} dz = 1$$

Solve using CAS.

$$a = 0.6487$$

$$\mathbf{b} \quad E(Z) = \int_0^{0.6487} \frac{2z}{z+1} dz = 0.2974$$

$$E(Z^2) = \int_0^{0.6487} \frac{2z^2}{z+1} dz = 0.1234$$

$$\text{Var}(Z) = E(Z^2) - [E(Z)]^2$$

$$\text{Var}(Z) = 0.1234 - 0.2974^2$$

$$\text{Var}(Z) = 0.0349$$

$$\mathbf{c} \quad \mathbf{i} \quad E(3Z + 1) = 3E(Z) + 1 = 3(0.2974) + 1 = 1.8922$$

$$\mathbf{ii} \quad \text{Var}(3Z + 1) = 3^2 \text{Var}(Z) = 9(0.0349) = 0.3141$$

$$\mathbf{iii} \quad E(Z^2 + 2) = E(Z^2) + 2 = 0.1234 + 2 = 2.1234$$

$$\mathbf{6} \quad \mathbf{a} \quad E(Z) = \int_1^{1.7755} zf(z)dz$$

$$E(Z) = \int_1^{1.7755} 5\sqrt{z} \log_e(z) dz$$

$$E(Z) = 1.4921$$

$$E(Z^2) = \int_1^{1.7755} z^2 f(z) dz$$

$$E(Z^2) = \int_1^{1.7755} 5z^{\frac{3}{2}} \log_e(z) dz$$

$$E(Z^2) = 2.2625$$

$$\text{Var}(Z) = E(Z^2) - [E(Z)]^2$$

$$\text{Var}(Z) = 2.2625 - 1.4921^2$$

$$\text{Var}(Z) = 0.0361$$

$$\mathbf{b} \quad E(3 - 2Z) = 3 - 2E(Z) = 3 - 2(1.4921) = 0.0158$$

$$\text{Var}(3 - 2Z) = (-2)^2 \text{Var}(Z) = 4 \times 0.0361 = 0.1444$$

$$\mathbf{7} \quad \mathbf{a} \quad \int_1^a f(z) dz = 1$$

$$\int_1^a 3z^{-\frac{1}{2}} dz = 1$$

$$\left[6z^{\frac{1}{2}} \right]_1^a = 1$$

$$[6\sqrt{z}]_1^a = 1$$

$$6\sqrt{a} - 6\sqrt{1} = 1$$

$$6\sqrt{a} - 6 = 1$$

$$6\sqrt{a} = 7$$

$$\sqrt{a} = \frac{7}{6}$$

$$a = \frac{49}{36}$$

$$\mathbf{b} \quad E(Z) = \int_1^{\frac{49}{36}} zf(z) dz$$

$$E(Z) = \int_1^{\frac{49}{36}} 6z^{\frac{1}{2}} dz$$

$$E(Z) = \left[2z^{\frac{3}{2}} \right]_1^{\frac{49}{36}}$$

$$E(Z) = 2 \left(\frac{49}{36} \right)^{\frac{3}{2}} - 2(1)^{\frac{3}{2}}$$

$$E(Z) = 2 \left(\left(\frac{7}{6} \right)^2 \right)^{\frac{3}{2}} - 2$$

$$E(Z) = 2 \left(\frac{7}{6} \right)^3 - 2$$

$$E(Z) = 1.1759$$

$$E(Z^2) = \int_1^{\frac{49}{36}} z^2 f(z) dz$$

$$E(Z^2) = \int_1^{\frac{49}{36}} 3z^{\frac{3}{2}} dz$$

$$E(Z^2) = \left[\frac{6}{5} z^{\frac{5}{2}} \right]_1^{\frac{49}{36}}$$

$$E(Z^2) = \frac{6}{5} \left(\frac{49}{36} \right)^{\frac{5}{2}} - \frac{6}{5} (1)^{\frac{5}{2}}$$

$$E(Z^2) = \frac{6}{5} \left(\left(\frac{7}{6} \right)^2 \right)^{\frac{5}{2}} - \frac{6}{5}$$

$$E(Z^2) = \frac{6}{5} \left(\frac{7}{6} \right)^5 - \frac{6}{5}$$

$$E(Z^2) = 1.3937$$

$$\text{Var}(Z) = E(Z^2) - [E(Z)]^2$$

$$\text{Var}(Z) = 1.3937 - 1.1759^2$$

$$\text{Var}(Z) = 0.0109$$

c i $E(4 - 3Z) = 4 - 3E(Z) = 4 - 3(1.1759) = 0.4722$

ii $\text{Var}(4 - 3Z) = (-3)^2 \text{Var}(Z) = 9 \times 0.011 = 0.0978$

8 Let T be the time for the kettle to boil.

$E(T) = 1.5$ and $\text{SD}(T) = 1.1$, so $\text{Var}(T) = 1.21$.

$\text{Var}(5T) = 5^2 \text{Var}(T) = 25 \times 1.21 = 30.25$

$\text{SD}(5T) = \sqrt{30.25} = 5.5$ minutes

The correct answer is **D**.

9 $E(X) = 9$ and $\text{Var}(X) = 2$

a $Y = aX + 5$

$E(Y) = E(aX + 5)$

$E(Y) = aE(X) + 5$

$E(Y) = 9a + 5$

$\text{Var}(Y) = \text{Var}(aX + 5) = a^2 \text{Var}(X) = 2a^2$

$E(Y) = \text{Var}(Y)$

$9a + 5 = 2a^2$

$0 = 2a^2 - 9a - 5$

$0 = (2a + 1)(a - 5)$

$a = 5$ since a is a positive integer

b $E(Y) = 9a + 5 = 9(5) + 5 = 50$

$\text{Var}(Y) = 2a^2 = 2(5)^2 = 50$

10 $Y = aX + 3$ and $E(X) = 5$ as well as $\text{Var}(X) = 2$

$E(Y) = \text{Var}(Y)$

$E(aX + 3) = \text{Var}(aX + 3)$

$aE(X) + 3 = a^2 \text{Var}(X)$

$5a + 3 = 2a^2$

$0 = 2a^2 - 5a - 3$

$0 = (2a + 1)(a - 3)$

$a = -\frac{1}{2}, 3$

$\therefore a = 3$ since a is a positive integer

Thus, $E(Y) = E(3X + 3) = 3E(X) + 3 = 3(5) + 3 = 18$

and $\text{Var}(Y) = \text{Var}(3X + 3) = 3^2 \text{Var}(X) = 9(2) = 18$.

11 $Y = aX + 1$ and $E(X) = 2$ as well as $\text{Var}(X) = 7$

$E(Y) = \text{Var}(Y)$

$E(aX + 1) = \text{Var}(aX + 1)$

$aE(X) + 1 = a^2 \text{Var}(X)$

$2a + 1 = a^2$

$0 = a^2 - 2a - 1$

$a = 0.5469$

$E(Y) = E(0.5469X + 1) = 0.5469E(X) + 1 = 0.5469(2) + 1 = 2.0938$

$\text{Var}(Y) = \text{Var}(0.5469X + 1) = 0.5469^2 \text{Var}(X) = 0.5469^2(7) = 2.0938$

12 a

$$\int_{0.9}^{1.25} k(2y + 1) dy = 1$$

$$k \int_{0.9}^{1.25} (2y + 1) dy = 1$$

$$k [y^2 + y]_{0.9}^{1.25} = 1$$

$$k((1.25^2 + 1.25) - (0.9^2 + 0.9)) = 1$$

$$k(2.8125 - 1.71) = 1$$

$$1.1025k = 1$$

$$k = \frac{400}{441}$$

b $E(Y) = \int_{0.9}^{1.25} yf(y) dy$

$$E(Y) = \int_{0.9}^{1.25} (0.907y(2y + 1)) dy$$

$$E(Y) = \int_{0.9}^{1.25} (1.814y^2 + 0.907y) dy$$

$$E(Y) = 1.081 \text{ kg}$$

c $Z = 0.75Y + 0.45$

$E(Z) = E(0.75Y + 0.45)$

$E(Z) = 0.75E(Y) + 0.45$

$E(Z) = 0.75(1.0814) + 0.45$

$E(Z) = 1.261 \text{ kg}$

11.5 Exam questions

1 $E(Y) = 3.5$ and $\text{SD}(Y) = 1.2$

a $E(2 - Y) = 2 - E(Y) = 2 - 3.5 = -1.5$ [1 mark]

b $E\left(\frac{Y}{2}\right) = \frac{1}{2}E(Y) = \frac{1}{2} \times 3.5 = 1.75$ [1 mark]

c $\text{Var}(Y) = [\text{SD}(Y)]^2 = (1.2)^2 = 1.44$ [1 mark]

d $\text{Var}(2 - Y) = (-1)^2 \text{Var}(Y) = 1.44$ [1 mark]

e $\text{Var}\left(\frac{Y}{2}\right) = \left(\frac{1}{2}\right)^2 \text{Var}(Y) = \frac{1}{4} \times 1.44 = 0.36$ [1 mark]

2 a

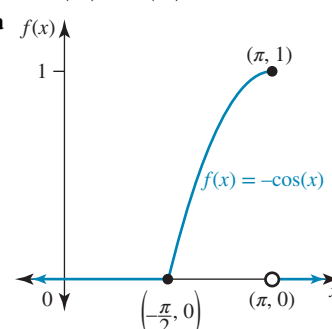

[1 mark]

$$\int_{\frac{\pi}{2}}^{\pi} (-\cos(x)) dx$$

$$= [-\sin(x)]_{\frac{\pi}{2}}^{\pi}$$

$$= -\sin(\pi) + \sin\left(\frac{\pi}{2}\right)$$

$$= 0 + 1$$

$$= 1$$

This is a probability density function.

[1 mark]

b $E(X) = \int_{\frac{\pi}{2}}^{\pi} xf(x) dx$

$$E(X) = \int_{\frac{\pi}{2}}^{\pi} -x \cos(x) dx$$

$$E(X) = 2.5708$$

$$\text{Var}(X) = E(X^2) - [E(X)]^2$$

$$E(X^2) = \int_{\frac{\pi}{2}}^{\pi} x^2 f(x) dx$$

$$E(X^2) = \int_{\frac{\pi}{2}}^{\pi} -x^2 \cos(x) dx$$

$$E(X^2) = 6.7506$$

[1 mark]

$$\text{Var}(X) = E(X^2) - [E(X)]^2$$

$$\text{Var}(X) = 6.7506 - (2.5708)^2$$

$$\text{Var}(X) = 0.1416$$

[1 mark]

c $E(3X + 1) = 3E(X) + 1$

$$E(3X + 1) = 3(2.5708) + 1$$

$$E(3X + 1) = 8.7124$$

$$\text{Var}(3X + 1) = 3^2 \text{Var}(X)$$

$$\text{Var}(3X + 1) = 9(0.1416)$$

$$\text{Var}(3X + 1) = 1.2743$$

[1 mark]

d $E((2X - 1)(3X - 2)) = E(6X^2 - 7X + 2)$

$$E((2X - 1)(3X - 2)) = 6E(X^2) - 7E(X) + 2$$

$$E((2X - 1)(3X - 2)) = 6(6.7506) - 7(2.5708) + 2$$

$$E((2X - 1)(3X - 2)) = 24.5079$$

[1 mark]

3 a $\int_0^{3\pi} \frac{x}{k\pi} \sin\left(\frac{x}{3}\right) dx = 1$

$$\frac{1}{k\pi} \int_0^{3\pi} x \sin\left(\frac{x}{3}\right) dx = 1$$

$$\frac{1}{k\pi} \left[-3x \cos\left(\frac{x}{3}\right) + 9 \sin\left(\frac{x}{3}\right) \right]_0^{3\pi} = 1$$

[1 mark]

$$(-3(3\pi) \cos(\pi) + 9 \sin(\pi)) -$$

$$(-3(0) \cos(0) + 9 \sin(0)) = k\pi$$

$$9\pi = k\pi$$

$$k = 9$$

[1 mark]

b $E(X) = \int_0^{3\pi} xf(x) dx$

[1 mark]

$$E(X) = \int_0^{3\pi} \frac{x^2}{9\pi} \sin\left(\frac{x}{3}\right) dx$$

$$E(X) = 5.61 \text{ mm}$$

[1 mark]

c $W = 2X - 1$

$$E(W) = E(2X - 1)$$

$$E(W) = 2E(X) - 1$$

$$E(W) = 2(5.6051) - 1$$

$$E(W) = 10.21 \text{ mm}$$

[1 mark]

11.6 Review

11.6 Exercise

Technology free: short answer

1 a

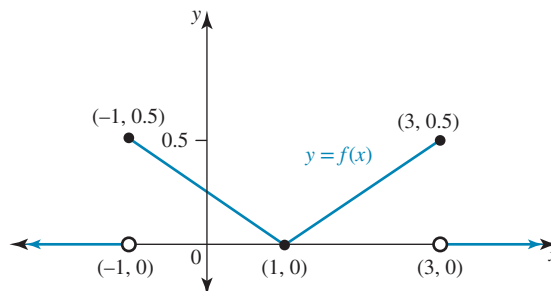

b Using the triangle method:

$$A = \frac{1}{2} \times 2 \times \frac{1}{2} + \frac{1}{2} \times 2 \times \frac{1}{2}$$

$$= \frac{1}{2} + \frac{1}{2}$$

$$= 1$$

$f(x) \geq 0$; therefore, $f(x)$ is a probability density function.

c $E(X) = \int_{-1}^3 xf(x) dx$

$$= \int_{-1}^1 -\frac{x}{4}(x-1) dx + \int_1^3 \frac{x}{4}(x-1) dx$$

$$= -\frac{1}{4} \int_{-1}^1 (x^2 - x) dx + \frac{1}{4} \int_1^3 (x^2 - x) dx$$

$$= -\frac{1}{4} \left[\frac{x^3}{3} - \frac{x^2}{2} \right]_{-1}^1 + \frac{1}{4} \left[\frac{x^3}{3} - \frac{x^2}{2} \right]_1^3$$

$$= -\frac{1}{4} \left[\left(\frac{1}{3} - \frac{1}{2} \right) - \left(\frac{-1}{3} - \frac{1}{2} \right) \right]$$

$$+ \frac{1}{4} \left[\left(\frac{27}{3} - \frac{9}{2} \right) - \left(\frac{1}{3} - \frac{1}{2} \right) \right]$$

$$= -\frac{1}{4} \left(\frac{2}{3} \right) + \frac{1}{4} \left(\frac{26}{3} - 4 \right)$$

$$= -\frac{1}{6} + \frac{13}{6} - 1$$

$$= 1$$

2 $E(Z) = 3$ and $\text{SD}(Z) = 1.2$, so $\text{Var}(Z) = 1.44$.

a $\text{Var}(Z) = E(Z^2) - [E(Z)]^2$

$$1.44 = E(Z^2) - 3^2$$

$$1.44 + 9 = E(Z^2)$$

$$E(Z^2) = 10.44$$

b $E(3Z - 2) = 3E(Z) - 2$

$$= 3(3) - 2$$

$$= 7$$

c $\text{Var}(3Z - 2) = 3^2 \text{Var}(Z)$

$$= 9 \times 1.44$$

$$= 12.96$$

$$\begin{aligned} \text{d } E(Z(Z+2)) &= E(Z^2 + 2Z) \\ &= E(Z^2) + 2E(Z) \\ &= 10.44 + 2(3) \\ &= 16.44 \end{aligned}$$

$$\begin{aligned} \text{e } E((Z-2)(Z+1)) &= E(Z^2 - Z - 2) \\ &= E(Z^2) - E(Z) - 2 \\ &= 10.44 - 3 - 2 \\ &= 5.44 \end{aligned}$$

$$\begin{aligned} \text{3 a } \Pr(X < \frac{\pi}{6}) &= \int_0^{\frac{\pi}{6}} 2 \sin(4x) \cdot dx \\ &= \left[-\frac{1}{2} \cos(4x) \right]_0^{\frac{\pi}{6}} \\ &= -\frac{1}{2} \cos\left(4 \times \frac{\pi}{6}\right) - \left[-\frac{1}{2} \cos\left(4 \times \frac{0}{6}\right) \right] \\ &= -\frac{1}{2} \times -\frac{1}{2} - \left[-\frac{1}{2} \right] \\ &= \frac{1}{4} + \frac{1}{2} \\ &= \frac{3}{4} \end{aligned}$$

b As the graph is symmetrical,

$$E(X) = \frac{\pi}{8}$$

$$\text{c } \Pr\left(X < \frac{\pi}{8} \mid X < \frac{\pi}{6}\right) = \frac{\Pr\left(X < \frac{\pi}{8}\right)}{\Pr\left(X < \frac{\pi}{6}\right)}$$

$$\begin{aligned} &= \frac{\int_0^{\frac{\pi}{8}} 2 \sin(4x) dx}{\int_0^{\frac{\pi}{6}} 2 \sin(4x) dx} \\ &= \left[-\frac{1}{2} \cos(4x) \right]_0^{\frac{\pi}{8}} \div \frac{3}{4} \\ &= \left(-\frac{1}{2} \cos\left(4 \times \frac{\pi}{8}\right) - \left[-\frac{1}{2} \cos\left(4 \times \frac{0}{8}\right) \right] \right) \div \frac{3}{4} \\ &= 0 + \frac{1}{2} \div \frac{3}{4} \\ &= \frac{2}{3} \end{aligned}$$

$$\begin{aligned} \text{4 a } \int_0^h g \times y^2 dy &= 1 \\ \left[\frac{g \times y^3}{3} \right]_0^h &= 1 \\ \frac{g \times h^3}{3} - \frac{g \times 0^3}{3} &= 1 \\ \frac{g \times h^3}{3} &= 3 \\ gh^3 &= 3 \\ g &= \frac{3}{h^3} \end{aligned} \quad [1]$$

$$\begin{aligned} \int_0^h y \times g \times y^2 dy &= \frac{3}{2} \\ \int_0^h gy^3 dy &= \frac{3}{2} \\ \left[\frac{g \times y^4}{4} \right]_0^h &= \frac{3}{2} \\ \frac{g \times h^4}{4} - \frac{g \times 0^4}{4} &= \frac{3}{2} \\ \frac{g \times h^4}{4} &= \frac{3}{2} \\ gh^4 &= 6 \\ g &= \frac{6}{h^4} \end{aligned} \quad [2]$$

Substitute [1] into [2]:

$$\begin{aligned} \frac{6}{h^4} &= \frac{3}{h^3} \\ 6 &= 3h \\ h &= 2 \\ \therefore g &= \frac{3}{(2)^3} \\ &= \frac{3}{8} \end{aligned}$$

$$\text{b } \text{Var}(Y) = E(Y^2) - [E(Y)]^2$$

$$\begin{aligned} E(Y^2) &= \int_0^2 y^2 \times \frac{3y^2}{8} dy \\ &= \left[\frac{3y^5}{40} \right]_0^2 \\ &= \frac{3 \times 2^5}{40} - 0 \\ &= \frac{12}{5} \end{aligned}$$

$$\begin{aligned} E(Y) &= \int_0^2 y \times \frac{3y^2}{8} dy \\ &= \int_0^2 \frac{3y^3}{8} dy \\ &= \left[\frac{3y^4}{32} \right]_0^2 \\ &= \frac{3(2)^4}{32} - 0 \\ &= \frac{3}{2} \end{aligned}$$

$$\begin{aligned} \text{Var}(Y) &= E(Y^2) - [E(Y)]^2 \\ &= \frac{12}{5} - \left(\frac{3}{2}\right)^2 \\ &= \frac{3}{20} \end{aligned}$$

$$\begin{aligned} \text{c i } E(2Y+1) &= 2E(Y) + 1 \\ &= 2\left(\frac{3}{2}\right) + 1 \\ &= 4 \end{aligned}$$

$$\begin{aligned} \text{ii } \text{Var}(2Y + 1) &= 2^2 \text{Var}(Y) \\ &= 4 \left(\frac{3}{20} \right) \\ &= \frac{3}{5} \end{aligned}$$

$$\begin{aligned} \text{iii } E(Y^2 - 5) &= E(Y^2) - 5 \\ &= \frac{12}{5} - 1 \\ &= \frac{7}{5} \end{aligned}$$

$$\begin{aligned} \text{iv } E(Y(Y + 4)) &= E(Y^2 + 4Y) \\ &= E(Y^2) + 4E(Y) \\ &= \frac{12}{5} + 4 \left(\frac{3}{2} \right) \\ &= 2\frac{2}{5} + 6 \\ &= 8\frac{2}{5} \end{aligned}$$

$$\begin{aligned} 5 \quad \int_{-3}^0 (mx - nx^2) dx &= 1 \\ \left[\frac{m}{2}x^2 - \frac{n}{3}x^3 \right]_{-3}^0 &= 1 \\ \left(\frac{m}{2}(0)^2 - \frac{n}{3}(0)^3 \right) - \left(\frac{m}{2}(-3)^2 - \frac{n}{3}(-3)^3 \right) &= 1 \\ - \left(\frac{9m}{2} + 9n \right) &= 1 \\ -9m - 18n &= 2 \\ 9m + 18n &= -2 \quad [1] \end{aligned}$$

$$\begin{aligned} \int_{-3}^0 x(mx - nx^2) dx &= -\frac{3}{2} \\ \int_{-3}^0 (mx^2 - nx^3) dx &= -\frac{3}{2} \\ \left[\frac{m}{3}x^3 - \frac{n}{4}x^4 \right]_{-3}^0 &= -\frac{3}{2} \\ \left(\frac{m}{3}(0)^3 - \frac{n}{4}(0)^4 \right) - \left(\frac{m}{3}(-3)^3 - \frac{n}{4}(-3)^4 \right) &= -\frac{3}{2} \\ 9m + \frac{81n}{4} &= -\frac{3}{2} \\ 36m + 81n &= -6 \quad [2] \end{aligned}$$

[1] × [4]:

$$36m + 72n = -8 \quad [3]$$

[2] - [3]:

$$9n = 2$$

$$n = \frac{2}{9}$$

Substitute $n = \frac{2}{9}$ into [1]:

$$9m + 18 \times \frac{2}{9} = -2$$

$$9m + 4 = -2$$

$$9m = -6$$

$$m = -\frac{2}{3}$$

6 a Let $y = 3x \cos(\pi x)$.

$$\frac{dy}{dx} = 3 \cos(\pi x) - 3\pi x \sin(\pi x)$$

$$\text{b } \frac{dy}{dx} = 3 \cos(\pi x) - 3\pi x \sin(\pi x)$$

$$E(X) = \int_0^{\frac{1}{2}} xf(x) dx$$

$$E(X) = \int_0^{\frac{1}{2}} \pi x \sin(\pi x) dx$$

$$\begin{aligned} \int (3 \cos(\pi x) - 3\pi x \sin(\pi x)) dx &= 3x \cos(\pi x) \\ \int 3 \cos(\pi x) dx - 3 \int (\pi x \sin(\pi x)) dx &= 3x \cos(\pi x) \\ \frac{3}{\pi} \sin(\pi x) - 3x \cos(\pi x) &= 3 \int (\pi x \sin(\pi x)) dx \\ \frac{1}{\pi} \sin(\pi x) - x \cos(\pi x) &= \int (\pi x \sin(\pi x)) dx \end{aligned}$$

$$\text{So } E(X) = \int_0^{\frac{1}{2}} \pi x \sin(\pi x) dx$$

$$E(X) = \left[\frac{1}{\pi} \sin(\pi x) - x \cos(\pi x) \right]_0^{\frac{1}{2}}$$

$$E(X) = \left(\frac{1}{\pi} \sin\left(\frac{\pi}{2}\right) - x \cos\left(\frac{\pi}{2}\right) \right) - \left(\frac{1}{\pi} \sin(0) - x \cos(0) \right)$$

$$E(X) = \frac{1}{\pi} - 0$$

$$E(X) = \frac{1}{\pi}$$

Technology active: multiple choice

7 The number of teenagers is 150.

The correct answer is **B**.

$$\begin{aligned} 8 \quad \Pr(X \leq 3) &= \frac{60 + 50 + 20}{150} \\ &= \frac{130}{150} \\ &= \frac{13}{15} \end{aligned}$$

The correct answer is **A**.

$$\begin{aligned} 9 \quad \int_0^m \frac{1}{2} e^x dx &= 1 \\ \left[\frac{1}{2} e^x \right]_0^m &= 1 \end{aligned}$$

$$\frac{1}{2} e^m - \frac{1}{2} e^0 = 1$$

$$\frac{1}{2} e^m = \frac{3}{2}$$

$$e^m = 3$$

$$m = \log_e(3)$$

The correct answer is **D**.

$$10 \quad 0.2(a - 1) = 1$$

$$a - 1 = 5$$

$$a = 6$$

The correct answer is **C**.

$$\begin{aligned}
 11 \quad E(X) &= \int_0^1 2x^2 dx \\
 &= \left[\frac{2}{3}x^3 \right]_0^1 \\
 &= \frac{2}{3}(1)^3 - 0 \\
 &= \frac{2}{3}
 \end{aligned}$$

$$\begin{aligned}
 E(X^2) &= \int_0^1 2x^3 dx \\
 &= \left[\frac{1}{2}x^4 \right]_0^1 \\
 &= \frac{1}{2}(1)^3 - 0 \\
 &= \frac{1}{2}
 \end{aligned}$$

$$\begin{aligned}
 \text{Var}(X) &= E(X^2) - [E(X)]^2 \\
 &= \frac{1}{2} - \left(\frac{2}{3}\right)^2 \\
 &= \frac{1}{2} - \frac{4}{9} \\
 &= \frac{9}{18} - \frac{8}{18} \\
 &= \frac{1}{18}
 \end{aligned}$$

The correct answer is **D**.

$$\begin{aligned}
 12 \quad \Pr(0.2 < Y < 0.7) &= \int_{0.2}^{0.7} 3y^2 dy \\
 &= [y^3]_{0.2}^{0.7} \\
 &= (0.7)^3 - (0.2)^3 \\
 &= 0.335
 \end{aligned}$$

The correct answer is **D**.

13 Use CAS to solve.

$$\begin{aligned}
 E(z) &= \int_{-\frac{\pi}{3}}^{\frac{\pi}{3}} (z \times \cos(z)) dz \\
 &= 0
 \end{aligned}$$

The correct answer is **A**.

$$\begin{aligned}
 14 \quad \Pr\left(Z < \frac{\pi}{6}\right) &= F\left(\frac{\pi}{6}\right) - F\left(-\frac{\pi}{3}\right) \\
 &= \left(\frac{1}{\sqrt{3}} \sin\left(\frac{\pi}{6}\right) + \frac{1}{2}\right) - \left(\frac{1}{\sqrt{3}} \sin\left(-\frac{\pi}{3}\right) + \frac{1}{2}\right) \\
 &= \left(\frac{1}{\sqrt{3}} \left(\frac{1}{2}\right) + \frac{1}{2}\right) - \left(\frac{1}{2} - \frac{1}{2}\right) \\
 &= \frac{1}{2\sqrt{3}} + \frac{1}{2} \\
 &= \frac{1 + \sqrt{3}}{2\sqrt{3}}
 \end{aligned}$$

The correct answer is **C**.

15 $Y = 2X - 1$ and $E(X) = 3$ as well as $\text{Var}(X) = 1.5$

$$\begin{aligned}
 E(Y) &= E(2X - 1) - 2E(X) - 1 \\
 &= 2(3) - 1 \\
 &= 5
 \end{aligned}$$

$$\begin{aligned}
 \text{Var}(Y) &= \text{Var}(2X - 1) \\
 &= 2^2 \text{Var}(X) \\
 &= 4(1.5) \\
 &= 6
 \end{aligned}$$

The correct answer is **A**.

$$\begin{aligned}
 16 \quad \text{Var}(X) &= E(X^2) - [E(X)]^2 \\
 1.5 &= E(X^2) - 3^2 \\
 1.5 + 9 &= E(X^2) \\
 10.5 &= E(X^2) \\
 E(X^2 - 1) &= E(X^2) - 1 \\
 &= 10.5 - 1 \\
 &= 9.5
 \end{aligned}$$

The correct answer is **E**.

Technology active: extended response

$$\begin{aligned}
 17 \quad \mathbf{a} \quad \int_{0.5}^a \left(4 - \frac{1}{y^2}\right) dy &= 1 \\
 \int_{0.5}^a (4 - y^{-2}) dy &= 1 \\
 \left[4y + \frac{1}{y}\right]_{0.5}^a &= 1 \\
 \left(4a + \frac{1}{a}\right) - \left(4(0.5) + \frac{1}{0.5}\right) &= 1 \\
 4a + \frac{1}{a} - 2 - 2 &= 1 \\
 4a + \frac{1}{a} &= 5 \\
 4a^2 + 1 &= 5a \\
 4a^2 - 5a + 1 &= 0 \\
 (4a - 1)(a - 1) &= 0 \\
 a &= \frac{1}{4}, 1
 \end{aligned}$$

$$\begin{aligned}
 4a + \frac{1}{a} &= 5 \\
 4a^2 + 1 &= 5a \\
 4a^2 - 5a + 1 &= 0 \\
 (4a - 1)(a - 1) &= 0 \\
 a &= \frac{1}{4}, 1
 \end{aligned}$$

But $a = \frac{1}{4}$ is not appropriate as $a > 0.5$, $\therefore a = 1$.

$$\begin{aligned}
 \mathbf{b} \quad \mathbf{i} \quad E(Y) &= \int_{0.5}^1 yf(y) dy \\
 &= \int_{0.5}^1 \left(4y - \frac{1}{y}\right) dy \\
 &= [2y^2 - \log_e(y)]_{0.5}^1 \\
 &= (2(1)^2 - \log_e(1)) - (2(0.5)^2 - \log_e(0.5)) \\
 &= 2 - 0 - 0.5 - 0.6931 \\
 &= 0.8069
 \end{aligned}$$

$$\begin{aligned}
 \text{ii } E(Y^2) &= \int_{0.5}^1 y^2 f(y) dy \\
 &= \int_{0.5}^1 (4y^2 - 1) dy \\
 &= \left[\frac{4}{3}y^3 - y \right]_{0.5}^1 \\
 &= \left(\frac{4}{3}(1)^3 - 1 \right) - \left(\frac{4}{3}(0.5)^3 - 0.5 \right) \\
 &= \frac{4}{3} - 1 - \frac{1}{6} + \frac{1}{2} \\
 &= \frac{8 - 6 - 1 + 3}{6} \\
 &= \frac{2}{3}
 \end{aligned}$$

$$\begin{aligned}
 \text{Var}(Y) &= E(Y^2) - [E(Y)]^2 \\
 &= \frac{2}{3} - 0.8069^2 \\
 &= 0.0156
 \end{aligned}$$

$$\text{iii } SD(Y) = \sqrt{0.0156} = 0.1248$$

$$\begin{aligned}
 \text{c } \int_{0.5}^p \left[4 - \frac{1}{y^2} \right] dy &= 0.5 \\
 \left[4y + \frac{1}{y} \right]_{0.5}^p &= 0.5 \\
 \left(4p + \frac{1}{p} \right) - \left(4(0.5) + \frac{1}{0.5} \right) &= 0.5 \\
 4p + \frac{1}{p} - 2 - 2 &= 0.5 \\
 4p + \frac{1}{p} - \frac{9}{2} &= 0 \\
 8p^2 - 9p + 2 &= 0
 \end{aligned}$$

$$p = 0.8202 \text{ as } 0.5 < p < 1$$

$$\begin{aligned}
 \text{18 a } \int_0^k \frac{1}{2} \sin\left(\frac{z}{4}\right) dz &= 1 \\
 \left[-2 \cos\left(\frac{z}{4}\right) \right]_0^k &= 1 \\
 -2 \cos\left(\frac{k}{4}\right) - (-2 \cos(0)) &= 1 \\
 -2 \cos\left(\frac{k}{4}\right) - (-2) &= 1 \\
 -2 \cos\left(\frac{k}{4}\right) &= -1 \\
 \cos\left(\frac{k}{4}\right) &= \frac{1}{2} \\
 \frac{k}{4} &= \frac{\pi}{3} \\
 k &= \frac{4\pi}{3}
 \end{aligned}$$

$$\begin{aligned}
 \text{b } E(Z) &= \int_0^{\frac{4\pi}{3}} z \times \frac{1}{2} \sin\left(\frac{z}{4}\right) dz \\
 &= 2.7394 \\
 E(Z^2) &= \int_0^{\frac{4\pi}{3}} z^2 \times \frac{1}{2} \sin\left(\frac{z}{4}\right) dz \\
 &= 8.4956
 \end{aligned}$$

$$\begin{aligned}
 \text{Var}(Z) &= E(Z^2) - [E(Z)]^2 \\
 &= 8.4956 - 2.7394^2 \\
 &= 0.9912
 \end{aligned}$$

$$\begin{aligned}
 \text{c } \int_0^{Q_1} \frac{1}{2} \sin\left(\frac{z}{4}\right) dz &= 0.25 \\
 \left[-2 \cos\left(\frac{z}{4}\right) \right]_0^{Q_1} &= 0.25 \\
 -2 \cos\left(\frac{Q_1}{4}\right) - (-2 \cos(0)) &= 0.25 \\
 -2 \cos\left(\frac{Q_1}{4}\right) - (-2) &= 0.25 \\
 -2 \cos\left(\frac{Q_1}{4}\right) &= 1.75 \\
 \cos\left(\frac{Q_1}{4}\right) &= 0.875 \\
 \frac{Q_1}{4} &= 0.505 \\
 Q_1 &= 2.02
 \end{aligned}$$

$$\begin{aligned}
 \int_0^{Q_3} \frac{1}{2} \sin\left(\frac{z}{4}\right) dz &= 0.75 \\
 \left[-2 \cos\left(\frac{z}{4}\right) \right]_0^{Q_3} &= 0.75 \\
 -2 \cos\left(\frac{Q_3}{4}\right) - (-2 \cos(0)) &= 0.75 \\
 -2 \cos\left(\frac{Q_3}{4}\right) - (-2) &= 0.75 \\
 -2 \cos\left(\frac{Q_3}{4}\right) &= -1.25 \\
 \cos\left(\frac{Q_3}{4}\right) &= 0.625 \\
 \frac{Q_3}{4} &= 0.896 \\
 Q_3 &= 3.58
 \end{aligned}$$

$$\begin{aligned}
 \text{IQR} &= Q_3 - Q_1 \\
 &= 3.58 - 2.01 \\
 &= 1.56
 \end{aligned}$$

$$\begin{aligned}
 \text{19 a } \int_0^a \frac{4y}{1+y^2} dy &= 1 \\
 2 \int_0^a \frac{2y}{1+y^2} dy &= 1 \\
 2 [\log_e(1+y^2)]_0^a &= 1 \\
 2 (\log_e(1+a^2) - \log_e(1+0^2)) &= 1
 \end{aligned}$$

$$\log_e(1+a^2) = 0.5$$

$$e^{0.5} = 1 + a^2$$

$$e^{0.5} - 1 = a^2$$

$$\sqrt{e^{0.5} - 1} = a$$

$$a = 0.8054 \text{ since } a > 0$$

$$\begin{aligned}
 \text{b } \int_0^p \frac{4y}{1+y^2} dy &= 0.3 \\
 2 \int_0^p \frac{2y}{1+y^2} dy &= 0.3 \\
 P &= 0.4023 \text{ since } p > 0
 \end{aligned}$$

$$20 \text{ a } \int_0^{\infty} k e^{-0.15t} dt = 1$$

$$k \int_0^{\infty} e^{-0.15t} dt = 1$$

$$6.6k = 1$$

$$k = 0.15$$

$$\text{b } E(T) = \int_0^{\infty} 0.15t e^{-0.15t} dt$$

$$= 6.7$$

$$= 7 \text{ days}$$

$$\text{c } E(T^2) = \int_0^{\infty} 0.15t^2 e^{-0.15t} dt$$

$$= 88.89$$

$$\text{Var}(T) = E(T^2) - [E(T)]^2$$

$$= 88.89 - 6.67^2$$

$$= 44.4$$

$$\text{SD}(T) = \sqrt{44.4} = 6.67$$

$$\text{d } \Pr(T > 7 | T < 10) = \frac{\Pr(T > 7 \cap T < 10)}{\Pr(T < 10)}$$

$$= \frac{\Pr(7 < T < 10)}{\Pr(T < 10)}$$

$$(T < 10) = \int_0^{10} 0.15e^{-0.15t} dt$$

$$= 0.7769$$

$$\Pr(7 < T < 10) = \int_7^{10} 0.15e^{-0.15t} dt$$

$$= 0.1268$$

$$\Pr(T > 7 | T < 10) = \frac{0.1268}{0.7769}$$

$$= 0.1632$$

Others had an open circle over a closed circle at (45, 0.04). Many students did not use rulers to draw the line segments. Some graphs looked like parabolas.

$$\text{b } \Pr(25 \leq T \leq 55)$$

$$= \frac{1}{625} \int_{25}^{45} (t - 20) dt + \frac{1}{625} \int_{45}^{55} (70 - t) dt$$

$$= \frac{12}{25} + \frac{8}{25}$$

$$= \frac{4}{5}$$

Alternatively, solve using areas of triangles.

Award 1 mark for setting up the correct definite integrals.

Award 1 mark for the correct probability.

VCAA Examination Report note:

This question was answered well. Some students had the incorrect terminals. 44 instead of 45 was occasionally

given, for example, $\int_{25}^{44} (f(t)) dt + \int_{44}^{55} (f(t)) dt$. Others used 20 as the lower limit instead of 25.

$$\text{c } \Pr(T \leq 25 | T \leq 55) = \frac{\Pr(T \leq 25)}{\Pr(T \leq 55)}$$

$$= \frac{\frac{1}{625} \int_{20}^{25} (t - 20) dt}{\frac{1}{625} \int_{20}^{45} (t - 20) dt + \frac{1}{625} \int_{45}^{55} (70 - t) dt}$$

$$= \frac{\frac{1}{50}}{\frac{1}{2} + \frac{8}{25}}$$

$$= \frac{1}{41}$$

Alternatively, solve using areas of triangles.

Award 1 mark for setting up the conditional probability.

Award 1 mark for the correct probability.

VCAA Examination Report note:

Many students were able to use the conditional probability formula. A common incorrect answer was $\frac{1}{40}$.

$$\text{d } \Pr(T \geq a) = 0.7 \Rightarrow \Pr(T \geq a) = 0.3$$

$$\frac{1}{625} \int_{20}^a (t - 20) dt = 0.3$$

$$\frac{a^2 - 40a + 400}{1250} = 0.3$$

$$\text{then } a = 39.3649$$

Award 1 mark for setting up the equation.

Award 1 mark for the correct value of a .

VCAA Examination Report note:

A number of correct approaches were used. $\int_{20}^a f(t) dt = 0.7$, $a = 50.6351$ was a common incorrect answer.

$\int_a^{75} \frac{1}{625} (70 - t) dt = 0.7$ was occasionally given. Some

students attempted to use the inverse normal as a method.

$$\text{e i } \Pr(T \geq 50) = \frac{1}{625} \int_{50}^{70} (70 - t) dt = \frac{8}{25}$$

$$J \sim \text{Bi}\left(7, \frac{8}{25}\right)$$

11.6 Exam questions

$$1 \text{ a } f(t) = \begin{cases} \frac{1}{625}(t - 20), & 20 \leq t < 45 \\ \frac{1}{625}(70 - t), & 45 \leq t \leq 70 \end{cases} \quad f(45) = \frac{1}{25}$$

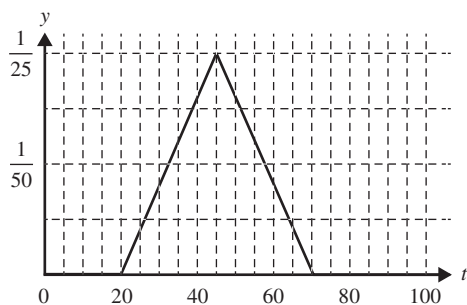

Award 1 mark for the correct shape.

Award 1 mark for the correct coordinate $\left(45, \frac{1}{25}\right)$.

Award 1 mark for clearly showing zero elsewhere.

VCAA Examination Report note:

Many students did not draw their graphs along the t -axis, ignoring $f(t) = 0$. Some had an open circle at (45, 0.04).

To solve for $\Pr(J > 3) = \Pr(J \geq 4)$ using CAS, complete the entry line as:

$$\text{binomCdf}\left(7, \frac{8}{25}, 4, 7\right)$$

$$\Pr(J > 3) = \Pr(J \geq 4) = 0.1534$$

Award 1 mark for using binomial probability.

Award 1 mark for the correct probability.

VCAA Examination Report note:

Many students recognised that the distribution was binomial and gave the correct n and p values. Some used $\Pr(X \geq 3)$.

$$\begin{aligned} \text{ii } \Pr(J \geq 2 | J \geq 1) &= \frac{\Pr(J \geq 2)}{\Pr(J \geq 1)} \\ &= \frac{0.711307}{0.93277} \\ &= 0.7626 \end{aligned}$$

Award 1 mark for setting up the conditional binomial probability.

Award 1 mark for the correct probability.

VCAA Examination Report note:

Many students were able to set up the conditional probability. Some wrote $\Pr(X \geq 2 | X \geq 1) = \frac{\Pr(X \geq 2)}{\Pr(X \geq 1)}$.

Others rounded

incorrectly, giving 0.7625 as the answer.

$$\text{f } J \sim \text{Bi}(n = 7, p), q = \Pr(J = 2) + \Pr(J = 3)$$

$$q = \binom{7}{2} p^2 (1-p)^5 + \binom{7}{3} p^3 (1-p)^4$$

$$q = 21p^2 (p-1)^4 + 35p^3 (1-p)^4$$

$$q = 7p^2 (p-1)^4 (2p+3)$$

$$q(P) = 14p^7 - 35p^6 + 70p^4 - 70p^3 + 21p^2$$

Award 1 mark for setting up the sum of binomial terms in terms of p .

Award 1 mark for the correct polynomial (does not need to be expanded).

VCAA Examination Report note:

Of those who attempted this question, some students did not realise that the binomial distribution was required.

$$\text{g i } \text{Solving } \frac{dq}{dp} = 0 \text{ for } p, \text{ since } 0 < p < 1:$$

$$\begin{aligned} \frac{dq}{dp} &= 98p^6 - 210p^5 + 280p^3 - 210p^2 \\ &\quad + 42p = 0 \end{aligned} \quad [1 \text{ mark}]$$

$$\text{gives } p = 0.3539$$

$$\text{and } q_{\max} = q(0.3539) = 0.5665. \quad [1 \text{ mark}]$$

VCAA Examination Report note:

Some students knew to solve $q'(p) = 0$ if they had an equation in Question 3f. Others found only p . Some gave exact values for their answers.

$$\text{ii } p = \Pr(T > d) = \frac{1}{625} \int_d^{70} (70-t) dt = 0.3539 \quad [1 \text{ mark}]$$

$$d = 49 \text{ minutes} \quad [1 \text{ mark}]$$

VCAA Examination Report note:

Some students used q instead of p in their equation,

solving $\int_d^{70} f(t) dt = 0.56646\dots$ for d . Others solved

$$\int_{20}^d f(t) dt = 0.35388\dots \text{ obtaining } d = 41 \text{ minutes.}$$

$$\begin{aligned} \text{2 } \int_0^8 k \sin\left(\frac{\pi x}{8}\right) dx &= 1 \\ k \left[-\frac{8}{\pi} \cos\left(\frac{\pi x}{8}\right) \right]_0^8 &= 1 \\ k \left(-\frac{8}{\pi} (\cos(\pi) - \cos(0)) \right) &= 1 \\ \frac{16k}{\pi} &= 1 \\ k &= \frac{\pi}{16} \end{aligned}$$

The correct answer is **B**.

$$\begin{aligned} \text{3 } E(x) &= \int_1^2 12x(x-1)(x-2)^2 dx \\ &= \frac{7}{5} \end{aligned}$$

The correct answer is **B**.

$$\begin{aligned} \text{4 } \int_{-a}^a (k(a^2 - x^2)) dx &= 1 \\ \frac{4a^3 k}{3} &= 1 \\ a^3 k &= 0.75 \quad (\text{equation 1}) \end{aligned} \quad [1 \text{ mark}]$$

$$\text{Var}(X) = E(X^2) - [E(X)]^2 \quad [1 \text{ mark}]$$

$$2^2 = \int_{-a}^a (x^2 f(x)) dx - \left[\int_{-a}^a (x f(x)) dx \right]^2$$

$$4 = \frac{4a^5 k}{15}$$

$$15 = a^5 k \quad (\text{equation 2}) \quad [1 \text{ mark}]$$

Substitute equation 1 into equation 2:

$$15 = a^2 \times 0.75$$

$$a^2 = 20$$

$$a = 2\sqrt{5} \quad [1 \text{ mark}]$$

$$\begin{aligned} \text{5 } E(T) &= \int_a^b t f(t) dt \\ &= \int_0^{\infty} 2te^{-2t} dt \\ &= \frac{1}{2} \quad (\text{using CAS}) \end{aligned}$$

$$\begin{aligned} E(T^2) &= \int_a^b t^2 f(t) dt \\ &= \int_0^{\infty} 2t^2 e^{-2t} dt \\ &= \frac{1}{2} \end{aligned}$$

$$\begin{aligned} \text{Var}(T) &= E(T^2) - (E(T))^2 \\ &= \frac{1}{2} - \left(\frac{1}{2}\right)^2 \\ &= \frac{1}{4} \end{aligned}$$

The correct answer is **C**.

Topic 12 — The normal distribution

12.2 The normal distribution

12.2 Exercise

1 a $f(x) = \frac{10}{3\sqrt{2\pi}} e^{-\frac{1}{2}\left(\frac{10(x-1)}{3}\right)^2} = \frac{1}{\sigma\sqrt{2\pi}} e^{-\frac{1}{2}\left(\frac{x-\mu}{\sigma}\right)^2}$

$\frac{1}{\sigma} = \frac{10}{3}$, so $\sigma = \frac{3}{10} = 0.3$ and $\mu = 1$.

b Dilation by a factor of $\frac{10}{3}$ parallel to the y-axis or from the x-axis; dilation by a factor of $\frac{3}{10}$ parallel to the x-axis or from the y-axis and a translation 1 unit in the positive x-direction.

2 $f(x) = \frac{1}{3\sqrt{2\pi}} e^{-\frac{1}{2}\left(\frac{x-2}{3}\right)^2} = \frac{1}{\sigma\sqrt{2\pi}} e^{-\frac{1}{2}\left(\frac{x-\mu}{\sigma}\right)^2}$

a $\mu = 2$ and $\sigma = 3$

b

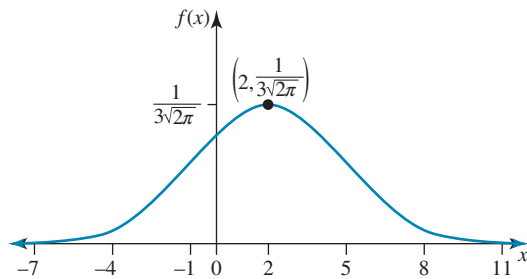

3 a Let X = the scores on an IQ test.
 $X \sim N(120, 20^2)$

i $\mu - \sigma = 120 - 20 = 100$
 $\mu + \sigma = 120 + 20 = 140$

ii $\mu - 2\sigma = 120 - 2(20) = 80$
 $\mu + 2\sigma = 120 + 2(20) = 160$

iii $\mu - 3\sigma = 120 - 3(20) = 60$
 $\mu + 3\sigma = 120 + 3(20) = 180$

b i $\Pr(X < 80) = 0.5 - 0.475 = 0.025$
ii $\Pr(X > 180) = 0.003 \div 2 = 0.0015$

4 a Let X = the results on the Mathematical Methods test.

$X \sim N(72, 8^2)$

$\mu + \sigma = 72 + 8 = 80$

$\mu - \sigma = 72 - 8 = 64$

$\mu + 2\sigma = 72 + 2(8) = 88$

$\mu - 2\sigma = 72 - 2(8) = 56$

So $\Pr(56 < X < 88) = 0.95$

and $\Pr(X < 56) \cup \Pr(X > 88) = 0.05$.

Thus, $\Pr(X < 56) = \Pr(X > 88) = 0.05 \div 2 = 0.025$.

So $\Pr(X > 88) = 0.025$.

b $\mu + 3\sigma = 88 + 8 = 96$

$\mu - 3\sigma = 58 - 8 = 50$

$\Pr(48 < X < 96) = 0.997$

$\Pr(X < 48) \cup \Pr(X > 96) = 0.003$

$\Pr(X < 48) = \Pr(X > 96) = 0.003 \div 2 = 0.0015$

c $\Pr(64 < X < 80) = 0.68$

$\Pr(X < 64) \cup \Pr(X > 80) = 0.32$

$\Pr(X < 64) = \Pr(X > 80) = 0.32 \div 2 = 0.16$

$\Pr(X < 80) = 1 - \Pr(X > 80) = 1 - 0.16 = 0.84$

5 $X \sim N(15, 5^2)$

a 68% of values lie between $15 - 5 = 10$ and $15 + 5 = 20$.

b 95% of values lie between $15 - 2(5) = 5$ and $15 + 2(5) = 25$.

c 99.7% of values lie between $15 - 3(5) = 0$ and $15 + 3(5) = 30$.

6 $X \sim N(24, 7^2)$

a $\Pr(X < 31) = 0.16 + 0.68 = 0.84$

b $\Pr(10 < X < 31) = 1 - (0.025 + 0.16) = 1 - 0.105 = 0.815$

c $\Pr(X > 10 | X < 31) = \frac{\Pr(10 < X < 31)}{\Pr(X < 31)} = \frac{0.815}{0.84} = 0.9702$

7 Let X = the number of pears per tree.

$X \sim N(230, 25^2)$

a $\Pr(X < 280) = 1 - \Pr(X > 280) = 1 - 0.025 = 0.975$

b $\Pr(180 < X < 280) = \Pr(\mu - 2\sigma < X < \mu + 2\sigma) = 0.95$

c $\Pr(X > 180 | X < 280) = \frac{\Pr(180 < X < 280)}{\Pr(X < 280)}$
 $= \frac{0.95}{0.975} = 0.9744$

8 Let X = the length of pregnancy for a human.

$X \sim N(275, 14^2)$

$\mu + 3\sigma = 275 + 3(14) = 317$

$\mu - 3\sigma = 275 - 3(14) = 233$

$\Pr(233 < X < 317) = 0.997$

$\Pr(X < 233) \cup \Pr(X > 317) = 0.003$

$\Pr(X < 233) = \Pr(X > 317) = 0.003 \div 2 = 0.0015$

So $\Pr(X < 233) = 0.0015$.

The correct answer is **A**.

9 Let X = the results on a biology exam.

$X \sim N(70, 6^2)$

$\mu + 3\sigma = 70 + 3(6) = 88$

$\Pr(X > 88) = \frac{1 - 0.997}{2} = 0.0015 = 0.15\%$ get a mark that is greater than 88.

The correct answer is **D**.

10 Let X = the rainfall in millimetres.

$X \sim N(305, 50^2)$

a $\Pr(205 < X < 355) = 1 - (0.025 + 0.16)$
 $= 1 - 0.185 = 0.815$

b 0.025 signifies 2σ .

$\Pr(X < k) = 0.025$

$\Pr(X < 205) = 0.025$

So $k = 205$.

c $\mu - 3\sigma = 155$

$\Pr(X < 155) = \frac{1 - 0.997}{2} = 0.0015$

0.0015 signifies 3σ .

$\Pr(X < h) = 0.0015$

$\Pr(X < 155) = 0.05$

So $h = 155$.

11 $X \sim N(72.5, 8.4^2)$

a $\Pr(64.1 < X < 89.3) = 1 - (0.16 + 0.025)$
 $= 1 - 0.185 = 0.8150$

b $\Pr(X < 55.7) = 0.025$

c $\Pr(X < 55.7) = \frac{1 - 0.95}{2} = \frac{0.05}{2} = 0.025$
 $\Pr(X < 47.3) = \frac{1 - 0.997}{2} = \frac{0.003}{2} = 0.0015$

$\Pr(47.3 < X < 55.7) = 0.025 - 0.0015 = 0.0235$

$\Pr(X > 47.3 | X < 55.7) = \frac{\Pr(47.3 < X < 55.7)}{\Pr(X < 55.7)}$
 $\Pr(X > 47.3 | X < 55.7) = \frac{0.025 - 0.0015}{0.025}$

$\Pr(X > 47.3 | X < 55.7) = 0.94$

d $\Pr(X > m) = 0.16$

$\Pr(X > \mu + \sigma) = \frac{1 - 0.68}{2} = \frac{0.32}{2} = 0.16$

So $m = 80.9$.

12 a Input $\int_{-\infty}^{\infty} \frac{1}{\sqrt{2\pi}} e^{-\frac{1}{2}(x-3)^2} dx \approx 1$ on CAS.

b $f(x) = \int_{-\infty}^{\infty} \frac{1}{\sqrt{2\pi}} e^{-\frac{1}{2}(x-3)^2} = \frac{1}{\sigma\sqrt{2\pi}} e^{-\frac{1}{2}\left(\frac{x-\mu}{\sigma}\right)^2}$

$\mu = 3$ and $\sigma = 1$

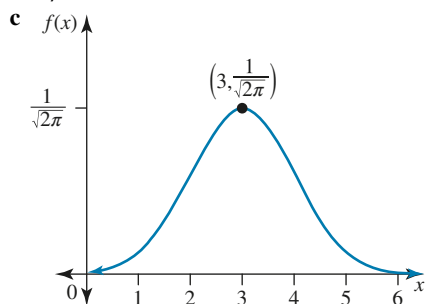

13 a Input $\int_{-\infty}^{\infty} \frac{1}{4\sqrt{2\pi}} e^{-\frac{1}{2}\left(\frac{x+2}{4}\right)^2} dx = 0.9999 \approx 1$ using CAS

b $f(x) = \frac{1}{4\sqrt{2\pi}} e^{-\frac{1}{2}\left(\frac{x+2}{4}\right)^2} = \frac{1}{\sigma\sqrt{2\pi}} e^{-\frac{1}{2}\left(\frac{x-\mu}{\sigma}\right)^2}$
 $\mu = -2$

14 a $f(x) = \frac{1}{10\sqrt{2\pi}} e^{-\frac{1}{2}\left(\frac{x+4}{10}\right)^2} = \frac{1}{\sigma\sqrt{2\pi}} e^{-\frac{1}{2}\left(\frac{x-\mu}{\sigma}\right)^2}$
 $\mu = -4, \sigma = 10$

b Dilation factor $\frac{1}{10}$ from the x -axis, dilation factor 10 from the y -axis, translation 4 units in the negative x -direction

c i $\sigma = \text{SD}(X) = 10$

$\text{Var}(X) = \sigma^2 = 10^2 = 100$

ii $\text{Var}(X) = E(X^2) - [E(X)]^2$

$100 = E(X^2) - (-4)^2$

$100 = E(X^2) - 16$

$116 = E(X^2)$

d $\int_{-\infty}^{\infty} \frac{1}{10\sqrt{2\pi}} e^{-\frac{1}{2}\left(\frac{x+4}{10}\right)^2} dx = 0.9999 \approx 1$ $f(x) \geq 0$ for all

values of x and the area under the curve is 1, so this is a probability density function.

15 a $f(x) = \frac{5}{2\sqrt{2\pi}} e^{-\frac{1}{2}\left(\frac{5(x-1)}{2}\right)^2} = \frac{1}{\sigma\sqrt{2\pi}} e^{-\frac{1}{2}\left(\frac{x-\mu}{\sigma}\right)^2}$

$\frac{1}{\sigma} = \frac{5}{2}$ so $\sigma = \frac{2}{5}$ and $\mu = 1$

b $\text{Var}(X) = \sigma^2 = \left(\frac{2}{5}\right)^2 = \frac{4}{25}$

$\text{Var}(X) = E(X^2) - [E(X)]^2$

$\frac{4}{25} = E(X^2) - 2^2$

$\frac{4}{25} = E(X^2) - 4$

$\frac{4}{25} + \frac{100}{25} = E(X^2)$

$\frac{104}{25} = E(X^2)$

$4.16 = E(X^2)$

12.2 Exam questions

1

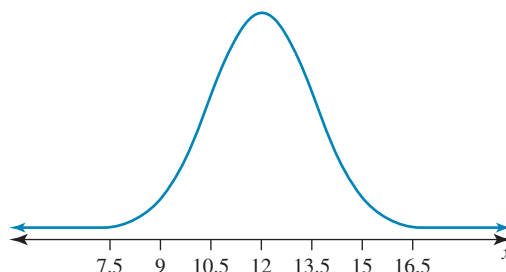

Award 1 mark for the correct values on the x -axis.

Award 1 mark for the shape.

2 The mean of X_2 is greater than the mean of X_1 . The spread of graph 2 is greater than the spread of graph 1, so

$\mu_1 < \mu_2$ and $\sigma_1 < \sigma_2$

The correct answer is E.

3 a $\Pr(23 < X < 37) = \Pr(-1 < Z < 1)$
 $= 0.68$

$\therefore 68\%$ [1 mark]

b $\Pr(X > 44) = \Pr\left(Z > \frac{44 - 30}{7}\right)$

$= \Pr(Z > 2)$

$= \frac{1 - 0.95}{2}$

$= 0.025$

$= 2.5\%$ [1 mark]

12.3 Calculating probabilities and the standard normal distribution

12.3 Exercise

1 $X \sim N(50, 15^2)$

$\Pr(50 < X < 70) = 0.4088$

2 a $\Pr(Z \leq 2) = 0.9772$

b $\Pr(Z \leq -2) = 0.0228$

c $\Pr(-2 \leq Z \leq 2) = 0.9545$

d $\Pr(Z < -1.95) \cup \Pr(Z > 1.95)$

By symmetry,

- $$= 2 \Pr(Z < -1.95)$$
- $$= 2 \times 0.0256$$
- $$= 0.0512$$
- 3 a $\Pr(X < 61) = \Pr\left(Z < \frac{61 - 65}{3}\right)$
- $$\Pr(X < 61) = \Pr\left(Z < -\frac{4}{3}\right)$$
- $$\Pr(X < 61) = 0.0912$$
- b $\Pr(X \geq 110) = \Pr\left(Z \geq \frac{110 - 98}{15}\right)$
- $$\Pr(X \geq 110) = \Pr\left(Z \geq \frac{12}{15}\right)$$
- $$\Pr(X \geq 110) = \Pr\left(Z \geq \frac{4}{5}\right)$$
- $$\Pr(X \geq 110) = 0.2119$$
- c $\Pr(-2 < X \leq 5) = \Pr\left(\frac{-2 - 2}{3} < Z \leq \frac{5 - 2}{3}\right)$
- $$\Pr(-2 < X \leq 5) = \Pr\left(-\frac{4}{3} < Z \leq 1\right)$$
- $$\Pr(-2 < X \leq 5) = 0.7501$$
- 4 a i $\Pr(Z < 1.2) = 0.8849$
- ii $\Pr(-2.1 < Z < 0.8) = 0.7703$
- b $X \sim N(45, 6^2)$
- i $\Pr(X > 37) = 0.9088$
- ii $z = \frac{37 - 45}{6}$
- $$= -\frac{4}{3}$$
- 5 a $\Pr(X < a) = 0.35$ and $\Pr(X < b) = 0.62$
- i $\Pr(X > a) = 1 - 0.35 = 0.65$
- ii $\Pr(a < X < b) = \Pr(X < b) - \Pr(X < a)$
- $$= 0.62 - 0.35 = 0.27$$
- b $\Pr(X < c) = 0.27$ and $\Pr(X < d) = 0.56$
- i $\Pr(c < X < d) = \Pr(X < d) - \Pr(X < c)$
- $$= 0.56 - 0.27 = 0.29$$
- ii $\Pr(X > c | X < d) = \frac{\Pr(c < X < d)}{\Pr(X < d)} = \frac{0.29}{0.56} = \frac{29}{56}$
- 6 a $\Pr(X > 32) = \Pr(Z > k)$
- $$k = \frac{x - \mu}{\sigma} = \frac{32 - 20}{5} = 2.4$$
- b $\Pr(X > 32) = \Pr(Z > k) = \Pr(Z < -k)$
- $$-k = \frac{x - \mu}{\sigma} = \frac{12 - 20}{5} = -1.6, \text{ so } k = 1.6.$$
- 7 Let X = the speed of cars.
 $X \sim N(98, 6^2)$
- a $\Pr(X > 110) = 0.0228$
- b $\Pr(X < 90) = 0.0912$
- c $\Pr(90 < X < 110) = 0.8860$
- 8 Let X = the score on a Physics test.
 $X \sim N(72, 12^2)$
- a $\Pr(X > 95) = 0.0276 = 2.76\% \therefore \text{E}$
 The correct answer is **E**.
- b $\Pr(X \geq 55) = 0.9217 = 92.17\% \therefore \text{B}$
 The correct answer is **B**.
- 9 Let X = the length of Tasmanian salmon.
 $X \sim N(38, 2.4^2)$
 $\Pr(X > 39.5) = 0.2659$
 This is not in the top 15%, so it is not a gourmet fish.

- 10 Let X = the weight of a bag of sugar.
 $X \sim N(1.025, 0.01^2)$
- a $\Pr(X > 1.04) = 0.0668 = 6.68\%$
- b $\Pr(X < 0.996) = 0.0019 = 0.19\%$
- 11 Let X = the pulse rate in beats per minute.
 $X \sim N(80, 5^2)$
- a $\Pr(X > 85) = 0.1587$
- b $\Pr(X \leq 75) = 0.1587$
- c $\Pr(78 \leq X < 82 | X > 75) = \frac{0.1587 - 0.03108}{1 - 0.1587} = 0.3695$
- 12 Let X = the score for Jingjing and Y = the score for Rani.
 $X \sim N(72, 9^2)$ $Y \sim N(15, 4^2)$
- $$z = \frac{x - \mu}{\sigma} \qquad z = \frac{y - \mu}{\sigma}$$
- $$z = \frac{85 - 72}{9} \qquad z = \frac{18 - 15}{4}$$
- $$z = \frac{13}{9} \qquad z = \frac{3}{4}$$
- $$z = 1.4 \qquad z = 0.75$$
- Jingjing did better.
- 13 Chemistry $X \sim N(68, 5^2)$
- $$z = \frac{x - \mu}{\sigma} = \frac{72 - 68}{5} = \frac{4}{5} = 0.8$$
- Mathematical Methods $X \sim N(69, 7^2)$
- $$z = \frac{x - \mu}{\sigma} = \frac{77 - 69}{7} = \frac{6}{7} = 0.86$$
- Physics $X \sim N(61, 8^2)$
- $$z = \frac{x - \mu}{\sigma} = \frac{68 - 61}{8} = \frac{7}{8} = 0.875$$
- Juan did best in Physics compared to his peers.
- 14 Solve using CAS technology to obtain:
 $k = 25.24$

12.3 Exam questions

- 1 a $X = N(6, 4)$, $Z = N(0, 1)$
- $$\Pr(X > 6) = \Pr(Z > 0) = 0.5 \quad [1 \text{ mark}]$$
- VCAA Examination Report note:**
 This question was well answered, with students recognising and applying symmetry of the normal distribution about the mean.
- b $\Pr(X > 7) = \Pr\left(Z > \frac{7 - 6}{2}\right)$
- $$= \Pr\left(z > \frac{1}{2}\right)$$
- $$= \Pr\left(Z < -\frac{1}{2}\right)$$
- $$= \Pr(Z < b)$$
- $$b = -\frac{1}{2} \qquad [1 \text{ mark}]$$
- VCAA Examination Report note:**
 Most students understood what was required as evident by the sketch graphs of the normal distribution and relevant areas. Some students did not standardise and left their answer as 5 or mistook the variance to be the standard deviation, resulting in an answer of $-\frac{1}{4}$.
- 2 $X = N(12, 0.25^2)$, $Z = N(0, 1)$
- $$\Pr(X > 12.5) = \Pr\left(Z > \frac{12.5 - 12}{0.25}\right)$$
- $$= \Pr(Z > 2)$$
- The correct answer is **E**.

3 By symmetry all options A, B, C and E are true; therefore, D is false.

The correct answer is **D**.

12.4 The inverse normal distribution

12.4 Exercise

1 a $\Pr(X \leq a) = 0.16$, $\mu = 41$ and $\sigma = 6.7$

$$a = 34.34$$

b $\Pr(X \leq a) = 0.21$, $\mu = 12.5$ and $\sigma = 7.7$

$$a = 14.68$$

c $\Pr(15 - a < X < 15 + a) = 0.32$, $\mu = 15$ and $\sigma = 4$

By symmetry,

$$\Pr(X < 15 - a) = \frac{0.68}{2} = 0.34$$

$$15 - a = 13.35$$

$$a = 1.65$$

2 $\Pr(m \leq X \leq n) = 0.92$, $\mu = 27.3$ and $\sigma = 8.2$

$$\Pr(X < m) = \frac{0.08}{2}$$

$$\Pr(X < m) = 0.04$$

$$m = 12.94$$

$$\Pr(X < n) = 0.96$$

$$n = 41.66$$

3 a $\Pr(Z < z) = 0.39$

$$\text{So } z = -0.2793.$$

b $\Pr(Z \geq z) = 0.15$ or $\Pr(Z < z) = 0.85$

$$\text{So } z = 1.0364.$$

c $\Pr(-z < Z < z) = 0.28$

$$\Pr(Z < -z) = 0.36$$

$$\text{So } -z = -0.3585.$$

Therefore, $z = 0.3585$.

4 $X \sim N(37.5, 8.62^2)$

a $\Pr(X < a) = 0.72$

$$\text{So } a = 42.52.$$

b $\Pr(X < a) = 0.68$

$$\text{So } a = 41.53.$$

c $\Pr(37.5 - a \leq X < 37.5 + a) = 0.88$

$$\Pr(X < 37.5 - a) = \frac{0.12}{2} = 0.06$$

$$37.5 - a = 24.10$$

$$a = 13.40$$

5 $Z \sim N(0, 1^2)$

a $\Pr(Z < z) = 0.57$

$$z = 0.1764$$

b $\Pr(Z < z) = 0.63$

$$z = 0.3319$$

6 $X \sim N(43.5, 9.7^2)$

a $\Pr(X < a) = 0.73$

$$a = 49.4443$$

b $\Pr(X < a) = 0.24$

$$a = 36.6489$$

7 $X \sim N(112, \sigma^2)$

$$\Pr(X < 108.87) = 0.42$$

$$\Pr\left(Z < \frac{108.87 - 112}{\sigma}\right) = 0.42$$

$$\frac{108.87 - 112}{\sigma} = -0.2019$$

$$3.13 = -0.2019\sigma$$

$$\sigma = 15.5$$

8 $X \sim N(\mu, 4.45^2)$

$$\Pr(X < 32.142) = 0.11$$

$$\Pr\left(Z < \frac{32.142 - \mu}{4.45}\right) = 0.11$$

$$\frac{32.142 - \mu}{4.45} = -1.2265$$

$$32.142 - \mu = -1.2265 \times 4.45$$

$$32.142 - \mu = -5.4579$$

$$32.142 + 5.4579 = \mu$$

$$\mu = 37.6$$

9 $X \sim N(\mu, 5.67^2)$

$$\Pr(X > 20.952) = 0.09$$

$$\Pr\left(Z > \frac{20.952 - \mu}{5.67}\right) = 0.09$$

$$\frac{20.952 - \mu}{5.67} = 1.3408$$

$$20.952 - \mu = 1.3408 \times 5.67$$

$$20.952 - \mu = 7.6023$$

$$20.952 - 7.6023 = \mu$$

$$13.3497 = \mu$$

$$\mu = 13.35$$

10 a $X \sim N(\mu, 3.5^2)$

$$\Pr(X < 23.96) = 0.28$$

$$\Pr\left(Z < \frac{23.96 - \mu}{3.5}\right) = 0.28$$

$$\frac{23.96 - \mu}{3.5} = -0.5828$$

$$23.96 - \mu = -0.5828 \times 3.5$$

$$23.96 - \mu = -2.038$$

$$23.96 + 2.038 = \mu$$

$$\mu = 26$$

The correct answer is **A**.

11 $X \sim N(115, \sigma^2)$

$$\Pr(X < 122.42) = 0.76$$

$$\Pr\left(Z < \frac{122.42 - 115}{\sigma}\right) = 0.76$$

$$\frac{122.42 - 115}{\sigma} = 0.7063$$

$$7.42 = 0.7063\sigma$$

$$\frac{7.42}{0.7063} = \sigma$$

$$\sigma = 10.5$$

12 $X \sim N(41, \sigma^2)$

$$\Pr(X > 55.9636) = 0.11$$

$$\Pr\left(Z > \frac{55.9636 - 41}{\sigma}\right) = 0.11$$

$$\frac{55.9636 - 41}{\sigma} = 1.2265$$

$$14.9636 = 1.2265\sigma$$

$$\frac{14.9636}{1.2265} = \sigma$$

$$\sigma = 12.2$$

The correct answer is **D**.

13 $X \sim N(\mu, \sigma^2)$

$$\Pr(X < 33.711) = 0.36$$

$$\Pr\left(Z < \frac{33.711 - \mu}{\sigma}\right) = 0.36$$

$$\frac{33.711 - \mu}{\sigma} = -0.3585$$

$$33.711 - \mu = -0.3585\sigma$$

$$33.711 = \mu - 0.3585\sigma \quad [1]$$

$$\Pr(X < 34.10) = 0.42$$

$$\Pr\left(Z < \frac{34.10 - \mu}{\sigma}\right) = 0.42$$

$$\frac{34.10 - \mu}{\sigma} = -0.2019$$

$$34.10 - \mu = -0.2019\sigma$$

$$34.10 = \mu - 0.2019\sigma \quad [2]$$

$$33.711 = \mu - 0.3585\sigma \quad [1]$$

[1] - [2]:

$$33.711 - 34.10 = -0.3585\sigma + 0.2019\sigma$$

$$-0.389 = -0.1566\sigma$$

$$\frac{-0.389}{-0.1566} = \sigma$$

$$\sigma = 2.5$$

Substitute $\sigma = 2.5$ into [1]:

$$33.711 = \mu - 0.3585(2.5)$$

$$33.711 = \mu - 0.8963$$

$$\mu = 34.6$$

14 $X \sim N(\mu, \sigma^2)$

$$\Pr(X < 18.35) = 0.31$$

$$\Pr\left(Z < \frac{18.35 - \mu}{\sigma}\right) = 0.31$$

$$\frac{18.35 - \mu}{\sigma} = -0.4959$$

$$18.35 - \mu = -0.4959\sigma$$

$$18.35 = \mu - 0.4959\sigma \quad [1]$$

$$\Pr(X < 15.9) = 0.45$$

$$\Pr\left(Z < \frac{15.9 - \mu}{\sigma}\right) = 0.45$$

$$\frac{15.9 - \mu}{\sigma} = -0.1257$$

$$15.9 - \mu = -0.1257\sigma$$

$$15.9 = \mu - 0.1257\sigma \quad [2]$$

$$18.35 = \mu - 0.4959\sigma \quad [1]$$

[1] - [2]:

$$18.35 - 15.9 = -0.4959\sigma + 0.1257\sigma$$

$$3.26 = 0.6216\sigma$$

$$\frac{3.26}{0.6216} = \sigma$$

$$\sigma = 5.2$$

Substitute $\sigma = 5.2$ into [1]:

$$18.35 = \mu + 0.4959(5.2)$$

$$18.35 = \mu + 2.5787$$

$$18.35 - 2.5787 = \mu$$

$$\mu = 15.8$$

15 $X \sim N(\mu, \sigma^2)$

$$\Pr(X < 39.9161) = 0.5789$$

$$\Pr\left(Z < \frac{39.9161 - \mu}{\sigma}\right) = 0.5789$$

$$\frac{39.9161 - \mu}{\sigma} = 0.1991$$

$$39.9161 - \mu = 0.1991\sigma$$

$$39.9161 = \mu + 0.1991\sigma \quad [1]$$

$$\Pr(X > 38.2491) = 0.4799$$

$$\Pr\left(Z > \frac{38.2491 - \mu}{\sigma}\right) = 0.4799$$

$$\frac{38.2491 - \mu}{\sigma} = 0.0504$$

$$38.2491 - \mu = 0.0504\sigma$$

$$38.2491 = \mu + 0.0504\sigma \quad [2]$$

$$39.9161 = \mu + 0.1991\sigma \quad [1]$$

[1] - [2]:

$$39.9161 - 38.2491 = 0.1991\sigma - 0.0504\sigma$$

$$1.667 = 0.1487\sigma$$

$$\frac{1.667}{0.1487} = \sigma$$

$$\sigma = 11.21$$

Substitute $\sigma = 11.21$ into [1]:

$$39.9161 = \mu + 0.1991(11.21)$$

$$39.9161 = \mu + 2.2319$$

$$39.9161 - 2.2319 = \mu$$

$$\mu = 37.68$$

16 $\Pr(a < X < b) = 0.52$ and $X \sim N(42.5, 10.3^2)$

$$\Pr(X < a) = 0.24 \text{ and } \Pr(X > b) = 0.24$$

$$a = 35.2251 \text{ } b = 49.7749$$

$$\text{So } \Pr(35.2251 < X < 49.7749) = 0.52.$$

$$\Pr(X > a | X < b) = \frac{\Pr(a < X < b)}{\Pr(X < b)}$$

$$\Pr(X < b) = 0.24 + 0.52 = 0.76$$

$$\Pr(X > a | X < b) = \frac{0.52}{0.76}$$

$$\Pr(X > a | X < b) = 0.6842$$

12.4 Exam questions

1 $X \stackrel{d}{=} N(\mu = 250, \sigma^2 = ?)$

$$\Pr(X < 259) = 1 - \Pr(X > 259) = 1 - \Pr(Z > 1.5)$$

$$1.5 = \frac{259 - 250}{\sigma} = \frac{9}{\sigma}$$

$$\sigma = \frac{9}{1.5} = 6$$

The correct answer is **C**.

2 $E(X) = 2SD(X)$, $X \stackrel{d}{=} N(2\sigma, \sigma^2)$

$$\Pr(X > 5.2) = 0.9$$

$$\Pr(Z < z) = 0.9$$

$$z = -1.28$$

$$\frac{5.2 - 2\sigma}{\sigma} = -1.28$$

$$\sigma = 7.238$$

The correct answer is **A**.

3 $W \stackrel{d}{=} N(200, \sigma^2 = ?)$

$$\Pr(W > 190) = 0.97$$

$$\Pr(W < 190) = 0.03$$

$$\Pr(Z < z) = 0.03$$

$$z = -1.88$$

$$-1.88 = \frac{190 - 200}{\sigma} = -\frac{10}{\sigma}$$

$$\sigma = 5.3$$

The correct answer is B.

12.5 Mixed probability applications

12.5 Exercise

1 a i $W \sim N(508, 3^2)$

$$\Pr(W < 500) = 0.0038$$

ii $\Pr(W < w) = 0.01$

$$w = 501.0210$$

b $\Pr(W < 500) \leq 0.01$

$$\Pr\left(Z < \frac{500 - 508}{\sigma}\right) \leq 0.01$$

$$\frac{500 - 508}{\sigma} \leq -2.3263$$

$$-8 \leq -2.3263\sigma$$

$$\frac{-8}{-2.3263} \geq \sigma$$

$$3.4389 \geq \sigma$$

Or $\sigma \leq 3.4389$ grams

Therefore, the maximum standard deviation is 3.4389.

2 a $\sum \Pr(X = x) = 1$

$$3k^2 + 2k + 6k^2 + 2k + k^2 + 2k + 3k = 1$$

$$10k^2 + 9k - 1 = 0 \text{ as required}$$

b $10k^2 + 9k - 1 = 0$

$$(10k - 1)(k + 1) = 0$$

$$k = \frac{1}{10} \text{ as } k \neq -1$$

c Let X = the chocolate surprises containing a ring.

$$X \sim \text{Bi}(8, 0.25)$$

$$E(X) = 8 \times 0.25 = 2$$

d $\Pr(X = 2) = 0.3115$

e $\Pr(X = 0) \leq 0.09$

$${}^nC_0(0.75)^n(0.25)^0 \leq 0.09$$

$$(0.75)^n \leq 0.09$$

$$n \log_e(0.75) \leq \log_e(0.09)$$

$$n \geq \frac{\log_e(0.09)}{\log_e(0.75)}$$

$$n \geq 8.3701$$

The sample size has to be 9.

f Let W = the weight of the defective chocolate surprises.

$$W \sim N(125, \sigma^2)$$

$$\Pr(W < 100) = 0.082$$

$$\Pr\left(Z < \frac{100 - 125}{\sigma}\right) = 0.082$$

$$\frac{100 - 125}{\sigma} = -1.3917$$

$$-25 = -1.3917\sigma$$

$$\frac{-25}{-1.3917} = \sigma$$

$$17.9636 = \sigma$$

$$\sigma = 18$$

3 Let X = the error in a speedometer.

$$X \sim N(0, 0.76^2)$$

$$\Pr(\text{Unacceptable}) = \Pr(X < -1.5) \cup \Pr(X > 1.5)$$

$$\Pr(\text{Unacceptable}) = 2 \Pr(X < -1.5) \text{ by symmetry}$$

$$\Pr(\text{Unacceptable}) = 2 \times 0.0242$$

$$\Pr(\text{Unacceptable}) = 0.0484$$

4 Let X = the height of Perth adult males.

$$X \sim N(174, 8^2)$$

a $\Pr(X \geq 180) = 0.2266$ or 22.66%

b $\Pr(X \geq x) = 0.25$

$$x = 179.396 = 179 \text{ cm}$$

5 a Let X = average weight of David's avocados.

$$X \sim N(410, 20^2)$$

i $\Pr(X < 360) = 0.0062$

ii $\Pr(X < 340 | X < 360) = \frac{\Pr(340 < X < 360)}{\Pr(X < 360)}$

$$\Pr(X < 340 | X < 360) = \frac{0.005977}{0.0062}$$

$$\Pr(X < 340 | X < 360) = 0.9625$$

b Let Y = average weight of Jane's avocados.

$$Y \sim N(\mu, \sigma^2)$$

$$\Pr(Y < 400) = 0.4207$$

$$\Pr\left(Z < \frac{400 - \mu}{\sigma}\right) = 0.4207$$

$$\frac{400 - \mu}{\sigma} = -0.2001$$

$$400 - \mu = -0.2001\sigma$$

$$400 = \mu - 0.2001\sigma$$

[1]

$$\Pr(Y > 415) = 0.3446$$

$$\Pr\left(Z > \frac{415 - \mu}{\sigma}\right) = 0.3446$$

$$\frac{415 - \mu}{\sigma} = 0.3999$$

$$415 = \mu + 0.3999\sigma$$

[2]

$$400 = \mu - 0.2001\sigma$$

[1]

$$[2] - [1]:$$

$$415 - 400 = 0.3999\sigma + 0.2001\sigma$$

$$15 = 0.6\sigma$$

$$\frac{15}{0.6} = \sigma$$

$$25 = \sigma$$

Substitute $\sigma = 25$ into [1]:

$$400 = \mu - 0.2001(25)$$

$$400 = \mu - 3.0015$$

$$\mu = 405$$

6 Let X = the length of metal rods.

$$X \sim N(145, 1.4^2)$$

a $\Pr(X > 146.5) = 0.1420$

b $\Pr(X < \mu - d) = \frac{0.15}{2}$

$$\Pr(X < 145 - d) = 0.075$$

$$145 - d = 142.9847$$

$$145 - 142.9847 = d$$

$$2.0153 = d$$

$$d = 2.0$$

c Let Y = the number of rods with a size fault.

$$Y \sim \text{Bi}(12, 0.15)$$

$$\Pr(Y = 2) = 0.2924$$

- d i** $a + 0.15 + 0.17 = 1$
 $a + 0.32 = 1$
 $a = 1 - 0.32$
 $a = 0.68$
- ii** $E(Y) = 0.68(x - 5) + 0.15(0) + 0.17(x - 8)$
 $E(Y) = 0.68x - 3.4 + 0.17x - 1.36$
 $E(Y) = 0.85x - 4.76$
- iii** If $E(Y) = 0$ then
 $0.85x - 4.76 = 0$
 $0.85x = 4.76$
 $x = 5.6$
- The selling price of good rods will be \$5.60.
- iv** Production of good rods = $\frac{0.68}{0.68 + 0.17}$
 $= 0.8$
- i.e. 80%

7 $X \sim N(2500, 700^2)$ and $Y \sim N(3000, 550^2)$

- a** $\Pr(X < 1250) = 0.0371$
b $\Pr(Y < 1500) = 0.0032$
c $\Pr(\text{Both 'special'}) = \Pr(X \cap Y)$
 $\Pr(\text{Both 'special'}) = \Pr(X) \times \Pr(Y)$ as they are independent events
 $\Pr(\text{Both 'special'}) = 0.0371 \times 0.0032$
 $\Pr(\text{Both 'special'}) = 0.0001$
- d i** $\Pr(\text{One 'special'}) = 0.4 \times 0.0371 + 0.6 \times 0.0032$
 $\Pr(\text{One 'special'}) = 0.0167$
- ii** $\Pr(X^{\text{'special'}} | \text{One 'special'}) = \frac{\Pr(X \cap \text{One 'special'})}{\Pr(\text{One 'special'})}$
 $\Pr(X^{\text{'special'}} | \text{One 'special'}) = \frac{0.4 \times 0.0371}{0.0167}$
 $\Pr(X^{\text{'special'}} | \text{One 'special'}) = \frac{0.00744}{0.0167}$
 $\Pr(X^{\text{'special'}} | \text{One 'special'}) = 0.8856$

8 a Let X = the height of plants.

$X \sim N(18, 5^2)$
 $\Pr(X < 10) = 0.0548$
 $\Pr(10 < X < 25) = 0.8644$
 $\Pr(X > 25) = 0.0808$

Plant	Size	Probability
Small	$X < 10$	0.0548
Medium	$10 < X < 25$	0.8644
Large	$X > 25$	0.0808

- b** $E(\text{Cost of one plant}) = 2(0.0548) + 3.5(0.8644)$
 $+ 5(0.0808) = \$3.54$
 $E(\text{Cost of 150 plants}) = 150 \times \$3.54 = \$531$
- 9** Let W = the weight of perch.
 $W \sim N(185, 20^2)$
- a** $\Pr(W > 205) = 0.1587 = 15.87\%$ (Cannery, 60 cents)
b $\Pr(165 < W < 205) = 0.6827$
 $= 68.27\%$ (Market, 45 cents)
c $\Pr(W < 165) = 0.1587 = 15.87\%$ (Jam, 30 cents)
 $E(\text{Profit}) = 60(0.1587) + 45(0.6827) + 30(0.1587)$
 $= 45.0045 = 45$ cents

10 Let X = the diameter of the tennis ball.

$X \sim N(70, 1.5^2)$

a $\Pr(X < 71.5) = 0.8413$
b $\Pr(68.6 < X < 71.4) = 0.6494$
c Let Y = the tennis balls in the range.
 $Y \sim \text{Bi}(5, 0.3506)$
 $\Pr(Y \geq 1) = 1 - \Pr(Y = 0)$
 $\Pr(Y \geq 1) = 1 - (0.64935)^5$
 $\Pr(Y \geq 1) = 0.8845$

d $\Pr\left(\frac{68.6 - 70}{\sigma} < Z < \frac{71.4 - 70}{\sigma}\right) = 0.995$
 $\Pr\left(\frac{-1.4}{\sigma} < Z < \frac{1.4}{\sigma}\right) = 0.995$
 $\Pr\left(Z > \frac{1.4}{\sigma}\right) = 0.0025$
 $\frac{1.4}{\sigma} = 2.807$
 $\frac{1.4}{2.807} = \sigma$
 $0.4987 = \sigma$

11 Let X = the diameter of a Fuji apple.

$X \sim N(71, 12^2)$

a $\mu + 2\sigma$ will be the largest possible diameter. $(71 + 24)$ mm will be the largest possible diameter. Therefore, 95 mm will be the largest possible diameter.
b $\Pr(X < 85) = 0.8783$
c $\Pr(X < 60) = 0.1797 = 18\%$
d $\Pr(X \leq x) = 0.85$
 $x = 83.4372$ mm
83 mm is the minimum diameter.
e $\Pr(x > 100) = 0.0078$
f $E(\text{Cost of one apple}) = 0.1797(0.12) + 0.6703(0.15)$
 $+ 0.15(0.25)$
 $= 0.1596$ or 16 cents
 $E(\text{Cost of 2500 apples}) = 2500 \times 0.1596 = \399

g Let Y = Jumbo apples in a bag.

$Y \sim \text{Bi}(6, 0.15)$
 $\Pr(Y \geq 2) = 1 - (\Pr(Y = 0) + \Pr(Y = 1))$
 $\Pr(Y \geq 2) = 1 - (0.3771 + 0.3993)$
 $\Pr(Y \geq 2) = 1 - 0.7764$
 $\Pr(Y \geq 2) = 0.2236$

12 Let X_S = the amount of disinfectant in a standard bottle.

$X_S \sim N(0.765, 0.007^2)$
Let X_L = the amount of disinfectant in a large bottle.
 $X_L \sim N(1.015, 0.009^2)$

a $\Pr(X_S < 0.75) = 0.0161$
b $\Pr(X_L < 1.00) = 0.0478$

Let Y = the large bottles with less than 0.95 litres in them.
 $Y \sim \text{Bi}(12, 0.0478)$
 $\Pr(Y \geq 4) = 1 - \Pr(Y < 4)$
 $\Pr(Y \geq 4) = 1 - (\Pr(Y = 0) + \Pr(Y = 1) + \Pr(Y = 2) + \Pr(Y = 3))$
 $\Pr(Y \geq 4) = 1 - (0.5556 + 0.3347 + 0.0924 + 0.0155)$
 $\Pr(Y \geq 4) = 1 - 0.9982$
 $\Pr(Y \geq 4) = 0.0019$

- 13 Let L = the length of antenna of a lemon emigrant butterfly.

$$L \sim N(22, 1.5^2)$$

a $\Pr(L < 18) = 0.0038$

- b Let Y = the length of antenna of a yellow emigrant butterfly.

$$\Pr(Y < 15.5) = 0.08$$

$$\Pr\left(Z < \frac{15.5 - \mu}{\sigma}\right) = 0.08$$

$$\frac{15.5 - \mu}{\sigma} = -1.4051$$

$$15.5 - \mu = -1.4051\sigma$$

$$15.5 = \mu - 1.4051\sigma \quad [1]$$

$$\Pr(Y > 22.5) = 0.08$$

$$\Pr\left(Z > \frac{22.5 - \mu}{\sigma}\right) = 0.08$$

$$\frac{22.5 - \mu}{\sigma} = 1.4051$$

$$22.5 - \mu = 1.4051\sigma$$

$$22.5 = \mu + 1.4051\sigma \quad [2]$$

$$15.5 = \mu - 1.4051\sigma \quad [1]$$

$$[2] - [1]:$$

$$22.5 - 15.5 = 1.4051\sigma + 1.4051\sigma$$

$$2 = 2.8102\sigma$$

$$\frac{2}{2.8102} = \sigma$$

$$\sigma = 2.5 \text{ mm}$$

Substitute $\sigma = 2.5$ into [1]:

$$15.5 = \mu - 1.4051(2.5)$$

$$15.5 = \mu - 3.5128$$

$$15.5 + 3.5128 = \mu$$

$$\mu = 19.0 \text{ mm}$$

- c $\Pr(\text{Yellow}) = 0.45$ and $\Pr(\text{Lemon}) = 0.55$

Let B = the number of yellow emigrants.

$$B \sim \text{Bi}(12, 0.45)$$

$$\Pr(B = 5) = 0.2225$$

- 14 a Let X = the error in seconds of a clock.

$$X \sim N(\mu, \sigma^2)$$

The clock can be up to 3 seconds fast or 3 seconds slow.

$$\mu = 0 \text{ due to symmetry}$$

$$\Pr(X > 3) = 0.025$$

$$\Pr\left(Z > \frac{3 - 0}{\sigma}\right) = 0.025$$

$$\frac{3}{\sigma} = 1.95996$$

$$3 = 1.95996\sigma$$

$$\frac{3}{1.95996} = \sigma$$

$$\sigma = 1.5306$$

- b Let Y = the number of rejected clocks.

$$Y \sim \text{Bi}(12, 0.05)$$

$$\Pr(Y < 2) = \Pr(Y \leq 1)$$

$$\Pr(Y < 2) = 0.8816$$

$$\Pr(Z < z) = 0.075$$

$$z = -1.44$$

$$1.44 = \frac{90 - 120}{\sigma}$$

$$\sigma \approx 20.8$$

$$\sigma = 21$$

The correct answer is **D**.

- 2 a $S \sim N(\mu = 14, \sigma^2 = 4^2)$

$$\Pr(S < T) = 0.9$$

$$T = 19.1 \text{ cm}$$

Award 1 mark for the correct height.

VCAA Assessment Report note:

Many students thought $100 \text{ mm} = 1 \text{ cm}$, giving their final answer as 1913 mm . Others had incorrect units, such as 19.1 mm . Some entered the incorrect probability into their technology.

- b $\Pr(S < 9) = 0.1057$

$$E(S) = 0.1057 \times 2000$$

$$= 211$$

Award 1 mark for the correct probability.

Award 1 mark for the correct number.

VCAA Assessment Report note:

Some students had incorrect working, such as $\Pr(X < 9) = 0.10565... = 0.10565... \times 2000 = 211$ basil plants. Some students used $\Pr(X < 8.9)$ or $\Pr(X < 8)$. Some rounded incorrectly. Some used technology syntax in their working. Correct mathematical notation was required. Other students complicated the question by using z values. Many of these attempts were unsuccessful.

$$c \quad h(x) = \begin{cases} \frac{\pi}{100} \sin\left(\frac{\pi x}{50}\right) & 0 < x < 50 \\ 0 & \text{otherwise} \end{cases}$$

$$E(H) = \int_0^{50} xh(x)dx = 25$$

Award 1 mark for the correct mean height.

VCAA Assessment Report note:

This question was answered well. Some students used the median formula. Others used their technology in degrees rather than radians.

$$d \quad \int_0^d h(x)dx = 0.15 \Rightarrow d = 12.7$$

$$d = 12.7 \text{ cm}$$

Award 1 mark for writing a definite integral for the height.

Award 1 mark for solving using CAS for the correct height.

VCAA Assessment Report note:

Some students attempted to use the normal distribution to answer this question. Some had incorrect units or conversions.

- e $J \sim \text{Bi}(n = ?, p = 0.2)$

$$\Pr(J \geq 1)$$

$$= 1 - \Pr(J = 0)$$

$$= 1 - 0.8^n > 0.95$$

$$1 - 0.8^n > 0.95$$

$$\Rightarrow 0.8^n < 0.05$$

$$\Rightarrow n > 13.85$$

$$\text{so } n = 14$$

Award 1 mark for using at least one binomial expression.

12.5 Exam questions

- 1 $T \sim N(\mu = 120, \sigma^2 = 9^2)$

$$\Pr(T < 90) = \frac{150}{2000} = 0.075$$

Award 1 mark for the correct value of n .

VCAA Assessment Report note:

Many students did not know to use the binomial distribution and others used the inequality sign incorrectly. Many different approaches could have been used. Many different approaches were used, including trial and error.

$$3 \text{ a i } f(x) = \begin{cases} \frac{3}{4}(x-6)^2(8-x) & 6 \leq x \leq 8 \\ 0 & \text{otherwise} \end{cases}$$

$$\Pr(X > 7) = \int_7^8 f(x) dx \quad [1 \text{ mark}]$$

$$= \int_7^8 \frac{3}{4}(x-6)^2(8-x) dx$$

$$= \frac{11}{16} \quad [1 \text{ mark}]$$

VCAA Assessment Report note:

Some students omitted the dx . Some had incorrect terminals such as

$\int_6^7 f(x) dx$, $\int_{7.0001}^8 f(x) dx$ or $\int_{6.9999}^8 f(x) dx$. Others gave the answer without showing any working.

$$\text{ii } Y \sim \text{Bi} \left(n = 3, p = \frac{11}{16} \right) \quad [1 \text{ mark}]$$

$$\Pr(Y = 1) = \binom{3}{1} \times \left(\frac{11}{16} \right) \times \left(\frac{5}{16} \right)^2$$

$$= \frac{825}{4096} \quad [1 \text{ mark}]$$

VCAA Assessment Report note:

Many students were able to identify the binomial distribution with the correct n and p values. A common

incorrect answer was $\frac{11}{16} \times \left(\frac{5}{16} \right)^2 = \frac{275}{4096}$.

$$\text{b } E(X) = \int_6^8 xf(x) dx$$

$$= \int_6^8 \frac{3x}{4}(x-6)^2(8-x) dx$$

$$= \left[-\frac{3x^5}{20} + \frac{15x^4}{4} - 33x^3 + 108x^2 \right]_6^8$$

$$= -\frac{3(8^5 - 6^5)}{20} + \frac{15(8^4 - 6^4)}{4} - 33(8^3 - 6^3)$$

$$+ 108(8^2 - 6^2)$$

$$= \frac{36}{5}$$

$$= 7.2 \quad [1 \text{ mark}]$$

VCAA Assessment Report note:

Some students worked out the median, solving

$\int_6^8 f(x) dx = 0.5$ for x , instead of the mean. Others evaluated

$\int_6^8 (f(x)) dx$, leaving out x .

$$\text{c } X \sim N(\mu = 74, \sigma^2 = 9^2)$$

$$\Pr(X < 85 | X > 74) = \frac{\Pr(74 < X < 85)}{\Pr(X > 74)} \quad [1 \text{ mark}]$$

$$= \frac{0.3892}{0.5}$$

$$= 0.778 \quad [1 \text{ mark}]$$

VCAA Assessment Report note:

Many students were able to recognise that the problem involved conditional probability. Some students evaluated

$$\frac{0.38918...}{0.49999} \text{ or } \frac{0.889188...}{0.5}$$

$$\text{d i } L \sim \text{Bi} \left(n = 4, p = \frac{3}{100} \right)$$

$$\Pr(L \geq 1) = 1 - \Pr(L = 0) \quad [1 \text{ mark}]$$

$$= 1 - \left(\frac{97}{100} \right)^4$$

$$= 0.1147 \quad [1 \text{ mark}]$$

VCAA Assessment Report note:

Some students wrote 3% as 0.3. Others had the incorrect value for n , using $Lemons \sim \text{Bi}(3, 0.03)$. Some gave the answer without showing any working, while others attempted to use the normal distribution.

$$\text{ii } L \sim \text{Bi} \left(n = ?, p = \frac{3}{100} \right)$$

$$\Pr(L \geq 1) = 1 - \Pr(L = 0) > 0.5 \quad [1 \text{ mark}]$$

$$\Pr(L = 0) = \left(\frac{97}{100} \right)^n < 0.5$$

$$n = 23 \quad [1 \text{ mark}]$$

VCAA Assessment Report note:

Some students rounded their answer to 22. Others did not state the minimum value, leaving their answer as $n > 22.7566$. Some students used the trial and error methods and this was acceptable. Some students did not show any working.

12.6 Review

12.6 Exercise

Technology free: short answer

$$1 \text{ } X \sim N(76, 6^2)$$

$$\text{a } \Pr(X > 82) = 1 - \Pr(Z < 1)$$

$$= 1 - 0.84$$

$$= 0.16$$

$$\text{b } \Pr(70 < X < 76) = 1 - 0.5 - \Pr(Z < 70)$$

$$= 1 - 0.5 - 0.16$$

$$= 0.34$$

$$\text{c } \Pr(X > 70 | X < 76) = \frac{\Pr(70 < X < 76)}{\Pr(X < 76)}$$

$$= \frac{0.34}{0.5}$$

$$= \frac{34}{50}$$

$$= \frac{17}{25}$$

$$2 \text{ } X \sim N(31, 6^2)$$

a Dilation factor 6 from the x -axis, dilation factor $\frac{1}{6}$ from the y -axis, translation 31 units in the positive x -direction.

3 Let X = the time spent swimming.

$$X \sim N(35, 4^2)$$

a $\Pr(31 < X < 39) \approx 68\%$

b $\Pr(X < 43) \approx 1 - \left(\frac{0.5}{2}\right)$
 $\approx 1 - 0.025$
 ≈ 0.975
 $\approx 97.5\%$

c $\Pr(27 < X < 39) \approx 1 - \left(\frac{0.32}{2}\right) - \left(\frac{0.05}{2}\right)$
 $\approx 1 - 0.16 - 0.025$
 ≈ 0.815
 $\approx 81.5\%$

4 a $\Pr(X < m) = 1 - \Pr(X > m)$

$$= 1 - 0.65$$

$$= 0.35$$

b $\Pr(X > -m) = 1 - \Pr(X > m)$

$$= 1 - 0.65$$

$$= 0.35$$

5 a $X \sim N(15, 2^2)$

$$z = \frac{x - \mu}{\sigma}$$

$$= \frac{22 - 15}{2}$$

$$= 3.5$$

b $X \sim N(180, 5^2)$

$$z = \frac{x - \mu}{\sigma}$$

$$= \frac{192 - 180}{5}$$

$$= 2.4$$

6 a $\Pr(X < m) = \Pr(X < n) - \Pr(m < X < n)$

$$= 0.72 - 0.54$$

$$= 0.18$$

b $\Pr(X < m) = 1 - \Pr(X > n) - \Pr(m < X < n)$

$$= 1 - 0.18 - 0.75$$

$$= 0.07$$

Technology active: multiple choice

7 $\mu_1 < \mu_2$ and $\sigma_1 < \sigma_2$

The correct answer is **A**.

8 Let X = the amount of orange juice in the carton.

$$X \sim N(1.05, 0.05^2)$$

$$\Pr(X > 1) = 0.8413$$

$$= 0.84$$

The correct answer is **B**.

9 $\Pr(Z < -1)$

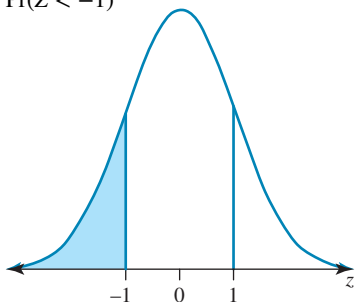

$$1 - \Pr(Z > 1)$$

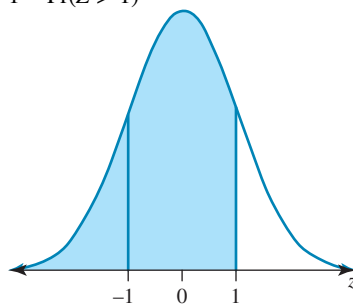

The correct answer is **C**.

10 $\Pr(a < X < b)$

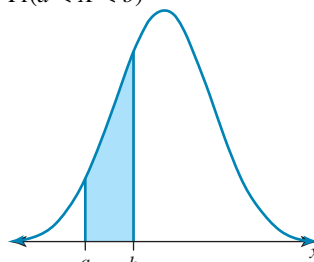

$$\Pr(a < X < b) = \Pr(X < b) - \Pr(X < a)$$

$$\neq \Pr(X < b) - \Pr(X > a)$$

The correct answer is **E**.

11 $X \sim N(4.9, 1.4^2)$

$$\Pr(X < 3.5) = \Pr\left(Z < \frac{3.5 - 4.9}{1.4}\right)$$

$$= \Pr\left(Z < \frac{-1.4}{1.4}\right)$$

$$= \Pr(Z < -1)$$

$$= \Pr(Z > 1)$$

The correct answer is **B**.

12 Let X = the mass of eggs.

$$X \sim N(63, 2.7^2)$$

$$\Pr(60 < X < 65) = 0.6373$$

The correct answer is **C**.

13 $X \sim N(32, 7^2)$

$$\Pr(X > a) = 0.2$$

$$a = 37.89$$

The correct answer is **D**.

14 Let H = the height of trees.

$$H \sim N(\mu, 0.3^2)$$

$$\Pr(H > 2.9) = \frac{2570}{3000}$$

$$\Pr(H > 2.9) = 0.8567$$

$$\Pr\left(Z > \frac{2.9 - \mu}{0.3}\right) = 0.8567$$

$$\frac{2.9 - \mu}{0.3} = -1.0655$$

$$2.9 - \mu = -1.0655(0.3)$$

$$2.9 - \mu = -0.3197$$

$$2.9 + 0.3197 = \mu$$

$$3.2197 = \mu$$

$$\mu = 3.220$$

The correct answer is **A**.

15 Let X = the weight of flour in bags.

$$X \sim N(255, 14^2)$$

$$\Pr(X > x) = 0.45$$

$$X = 256.8$$

The correct answer is **E**.

16 $Z \sim N(0, 1^2)$

$$\Pr(Z < z) = 0.85$$

$$z = 1.0364$$

The correct answer is **D**.

Technology active: extended response

17 a $X \sim N(\mu, \sigma^2)$

$$\Pr(X < 47) = 0.3694$$

$$\Pr\left(Z < \frac{47 - \mu}{\sigma}\right) = 0.3694$$

$$\frac{47 - \mu}{\sigma} = -0.3334$$

$$47 - \mu = -0.3334\sigma$$

$$47 = \mu - 0.3334\sigma \quad [1]$$

$$\Pr(X > 56) = 0.3385$$

$$\Pr\left(Z > \frac{56 - \mu}{\sigma}\right) = 0.3385$$

$$\frac{56 - \mu}{\sigma} = 0.4166$$

$$56 - \mu = 0.4166\sigma$$

$$56 = \mu + 0.4166\sigma \quad [2]$$

$$47 = \mu - 0.3334\sigma \quad [1]$$

$$[2] - [1]:$$

$$56 - 47 = 0.4166\sigma + 0.3334\sigma$$

$$9 = 0.750\sigma$$

$$\frac{9}{0.750} = \sigma$$

$$\sigma = 12$$

Substitute $\sigma = 12$ into [1]:

$$47 = \mu - 0.3334(12)$$

$$47 = \mu - 4$$

$$\mu = 51$$

b $\Pr(51 - a < X < 51 + a) = 0.7566$

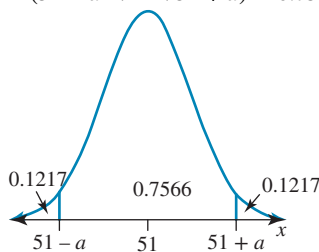

$$\Pr(X < x) = 0.1217$$

$$x = 37.0$$

So

$$51 - a = 37$$

$$51 - 37 = a$$

$$14 = a$$

Thus, $51 + 14 = 65$.

$$\Pr(X > 37 | X < 65) = \frac{\Pr(37 < X < 65)}{\Pr(X < 65)}$$

$$= \frac{0.7567}{0.8783}$$

$$= 0.8615$$

$$\begin{aligned} \text{c i } \text{Var}(X) &= \sigma^2 \\ &= 12^2 \\ &= 144 \end{aligned}$$

$$\text{ii } \text{Var}(X) = E(X^2) - [E(X)]^2$$

$$144 = E(X^2) - 51^2$$

$$144 = E(X^2) - 2601$$

$$E(X^2) = 2745$$

18 Machine A: $X \sim N(2.5, 0.7^2)$

$$\text{Machine B: } f(y) = \begin{cases} 0, & y < 0 \\ \frac{y}{12}, & 0 \leq y \leq 3 \\ \frac{1}{3}e^{-0.5(y-3)}, & y > 3 \end{cases}$$

$$\text{a i } \Pr(2 \leq X \leq 5) = 0.7623$$

$$\begin{aligned} \text{ii } \Pr(2 \leq Y \leq 5) &= \int_2^3 \frac{y}{12} dy + \int_3^5 \frac{1}{3} e^{-0.5(y-3)} dy \\ &= 0.2083 + 0.4214 \\ &= 0.6297 \end{aligned}$$

$$\begin{aligned} \text{b } E(Y) &= \int_0^3 \frac{y^2}{12} dy + \int_3^{\infty} \frac{1}{3} y e^{-0.5(y-3)} dy \\ &= 0.75 + 3.3 \\ &= 4.083 \end{aligned}$$

c Let C_B = the number of chocolates that took less than 2 seconds.

$$C_B \sim \text{Bi}\left(10, \frac{1}{6}\right)$$

$$\Pr(C_B = 4) = 0.0543$$

d i $\Pr(X \leq 2) = 0.2375$

ii Let C_A = the number of chocolates that took less than 2 seconds.

$$C_A \sim \text{Bi}(10, 0.2375)$$

$$\Pr(C_A = 4) = 0.1313$$

19 Let X = the length of strawberries at Pieter's farm.

$$X \sim N(3.5, 0.8^2)$$

$$X > 4.5 \quad \$6.50/\text{kg} \quad \text{Restaurants}$$

$$2.2 < X < 4.5 \quad \$4.50/\text{kg} \quad \text{Markets}$$

$$X < 2.5 \quad \$1.75/\text{kg} \quad \text{Jam}$$

$$\text{a i } \Pr(X > 4.5) = 0.1056 \text{ or } 10.56\%$$

$$\text{ii } \Pr(X < 2.5) = 0.1056 \text{ or } 10.56\%$$

iii The mean profit for 1 kg of strawberries is

$$6.5(0.1056) + 4.5(0.7887) + 1.75(0.1056) = \$4.42/\text{kg}.$$

b Let Y = the length of strawberries at Marta's farm.

$$Y \sim N(\mu, \sigma^2)$$

$$\Pr(Y > 4.5) = 0.0316$$

$$\Pr\left(Z > \frac{4.5 - \mu}{\sigma}\right) = 0.0316$$

$$\frac{4.5 - \mu}{\sigma} = 1.8579$$

$$4.5 - \mu = 1.8579\sigma$$

$$4.5 = \mu + 1.8579\sigma \quad [1]$$

$$\Pr(Y < 2.5) = 0.1587$$

$$\Pr\left(Z < \frac{2.5 - \mu}{\sigma}\right) = 0.1587$$

$$\frac{2.5 - \mu}{\sigma} = -0.9998$$

$$2.5 - \mu = -0.9998\sigma$$

$$2.5 = \mu - 0.9998\sigma \quad [2]$$

$$4.5 = \mu + 1.8579\sigma \quad [1]$$

$$[1] - [2]:$$

$$4.5 - 2.5 = 1.8579\sigma + 0.9998\sigma$$

$$2 = 2.8577\sigma$$

$$\frac{2}{2.8577} = \sigma$$

$$\sigma = 0.7$$

Substitute $\sigma = 0.7$ into [1]:

$$4.5 = \mu + 1.8579(0.7)$$

$$4.5 = \mu + 1.30053$$

$$4.5 - 1.30053 = \mu$$

$$\mu = 3.2$$

- 20 The 'A standard' is 65 metres.

The Olympic record is 72.28 metres.

Let X = the distance thrown by Merilyn.

$$X \sim N(64.5, 3.5^2)$$

a $\Pr(X < 65) = 0.5568$

$$\Pr(65 < X < 72.28) = 0.4301$$

$$\Pr(X > 72.28) = 0.0131$$

b $\Pr(X < m) = 0.9$

$$m = 60.01 \text{ metres}$$

c $\Pr(X > 65 | X < 72.38) = \frac{\Pr(65 < X < 72.38)}{\Pr(X < 72.38)}$

$$= \frac{0.4301}{0.9869}$$

$$= 0.4359$$

d Expected reward = $500(0.5568) + 1000(0.4301) + 5000(0.0131) = \774

e i Expected reward for 5 throws = $5 \times 774 = \$3870$

ii Let T = the number of throws over the A standard throw.

$$T \sim \text{Bi}(5, p = 1 - 0.5568)$$

$$T \sim \text{Bi}(5, 0.4432)$$

$$\Pr(T \geq 3) = 0.3944$$

iii $E(T) = np$

$$= 5 \times 0.3944$$

$$= 1.97$$

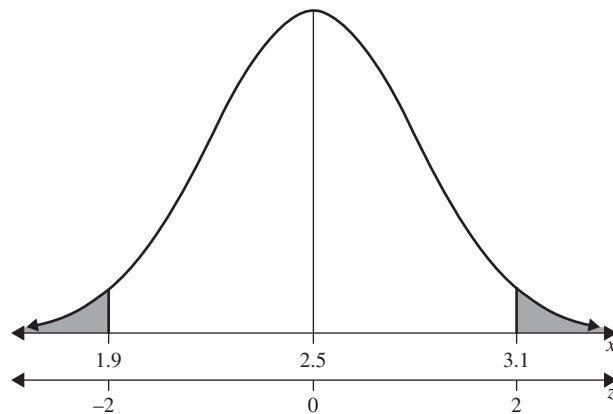

VCAA Assessment Report note:

Those students who drew a diagram of a 'normal' curve with relevant areas shaded found this helpful. An answer of +2 was common. The answer of 1.9 was also common, and was two standard deviations below the mean of X . This question required a conversion to the standard normal curve.

b $\Pr(X < 2.8 | X > 2.5)$

$$\frac{\Pr(2.5 < X < 2.8)}{\Pr(X < 2.5)} = \frac{\Pr(0 < Z < 1)}{\Pr(Z < 0)}$$

$$= \frac{0.5 - \Pr(Z > 1)}{\Pr(Z < 0)}$$

$$= \frac{0.5 - \Pr(Z < -1)}{\Pr(Z < 0)}$$

$$= \frac{0.5 - 0.16}{0.5}$$

$$= \frac{0.34}{0.5}$$

$$= 0.68$$

Award 1 mark for the correct use of conditional probability.

Award 1 mark for the final correct probability.

VCAA Assessment Report note:

Most students could state the relevant rule and obtained the correct denominator of $\frac{1}{2}$ but then failed to recognise that

$$\Pr(X < 2.8 | X > 2.5) = \frac{\Pr(2.5 < X < 2.8)}{\Pr(X > 2.5)}$$

Probabilities greater than 1 or errors in handling decimals and/or fraction simplifications were common.

2 $X \sim N(\mu = 12, \sigma^2 = 4^2)$

$$z = \frac{11.5 - 12}{0.5}$$

$$= -1$$

$$\Pr(X < 11.5) = \Pr(Z < -1)$$

$$= \Pr(Z > 1) \text{ by symmetry}$$

The correct answer is C.

3 a $T \stackrel{d}{=} N(\mu = 0, \sigma^2 = 16)$

$$\Pr(T \leq a) = 0.6$$

$$\therefore a = 1 \text{ minute}$$

Award 1 mark for the correct answer.

b $\Pr(T \leq 3 | T > 0)$

$$= \frac{\Pr(0 < T \leq 3)}{\Pr(T > 0)}$$

$$= \frac{0.27337}{0.5}$$

$$= 0.547$$

12.6 Exam questions

1 a $X \sim N(\mu = 2.5, \sigma^2 = 0.3^2)$ $Z \sim N(0, 1)$ $Z = \frac{x - \mu}{\sigma}$

$$\Pr(X > 3.1) = \Pr\left(Z > \frac{3.1 - 2.5}{0.3}\right)$$

$$= \Pr(Z > 2)$$

$$= \Pr(Z < -2)$$

$$b = -2$$

[1 mark]

Award 1 mark for considering conditional probabilities.

Award 1 mark for the correct probability.

c $\Pr(-3 \leq T \leq 2) = 0.4648$

$$D \stackrel{d}{=} N(\mu = k, \sigma^2 = 16)$$

$$\Pr(-4.5 \leq D \leq 0.5) = 0.4648, k = -1.5$$

Using symmetry,

$$\Pr(-0.5 \leq D \leq 4.5) = 0.4648, k = -2.5$$

Award 1 mark for considering symmetry.

Award 1 mark each for the two values of k .

d $R \stackrel{d}{=} \text{Bi}(n = 8, p = 0.85)$

$$\Pr(R < 4) = \Pr(R \leq 3) = 0.003$$

Award 1 mark for considering binomial probabilities.

Award 1 mark for the correct probability.

e i $R \stackrel{d}{=} \text{Bi}(n = ?, p = 0.85)$

$$\Pr(R \geq 1) = 1 - \Pr(R = 0) = 1 - 0.85^n$$

Award 1 mark for the correct expression.

ii Solving $1 - 0.85^n > 0.95$

$$n = 19$$

Award 1 mark for the correct value of n .

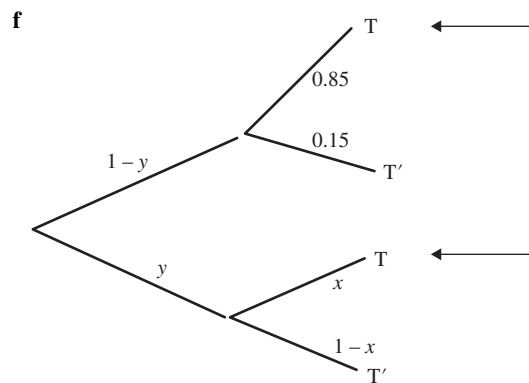

$$\Pr(\text{on time}) = (1 - y) \times 0.85 + xy = 0.75, x \in [0.3, 0.7]$$

When $x = 0.3$, solving $(1 - y) \times 0.85 + 0.3y = 0.75$ gives

$$\text{the minimum } y\text{-value: } y = \frac{2}{11}$$

When $x = 0.7$, solving $(1 - y) \times 0.85 + 0.7y = 0.75$ gives

$$\text{the maximum } y\text{-value: } y = \frac{2}{3}$$

Award 1 mark for the correct maximum y -value and 1 mark for the correct minimum y -value.

4 $\Pr(-a < Z < a) = 1 - 2\Pr(Z \leq -a)$

The correct answer is **D**.

5 Sketch the normal curve to assist in visualising the problem.

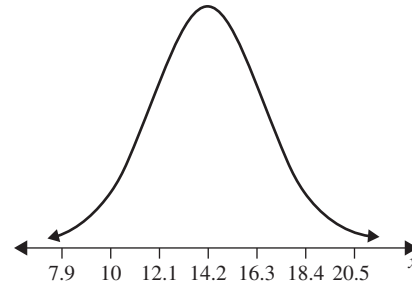

$$\Pr(X > a_1) = 0.9$$

$$= 1 - \Pr(X < a_1)$$

$$\Pr(X < a_1) = 0.1$$

$$\Pr(Z < z) = 0.1$$

$$z = -1.282$$

$$-1.282 = \frac{a_1 - 14.2}{2.1}$$

$$a_1 = 11.5087 \quad [1 \text{ mark}]$$

$$14.2 - 11.5087 = 2.691$$

$$a_2 = 14.2 + 2.691$$

$$a_2 = 16.8913 \quad [1 \text{ mark}]$$

Topic 13 — Statistical inference

13.2 Population parameters and sample statistics

13.2 Exercise

- Mr Banner tests his joke on this year's class (15 students).
This is the sample size. $n = 15$
We don't know how many students Mr Banner will teach.
The population size is unknown.
- Lois is able to hem 100 shirts per day. This is the population size. $N = 100$
Each day she checks 5 to make sure that they are suitable.
This is the sample size. $n = 5$
- Mr Parker teaches on average 120 students per day. This is the population size. $N = 120$
He asks one class of 30 about the amount of homework they have that night. This is the sample size. $n = 30$
- Lee-Yin asks 9 friends what they think. This is the sample size. $n = 9$
We don't know how many people will eventually eat Lee-Yin's cake pops. The population size is unknown.
- We don't know how many people will eventually eat the pudding. The population size is unknown.
 - 40 volunteers to taste test your recipe. This is the sample size. $n = 40$
- We don't know how many people will eventually receive the vaccine. The population size is unknown.
 - 247 suitable people test the vaccine. This is the sample size. $n = 247$
- Population parameter
 - Sample statistic
- Population parameter
 - Sample statistic
- Sample statistic
- Population parameter
- Sample statistics
- Population parameter
- Use the random number generator on your calculator to produce numbers from 1 to 100. Keep generating numbers until you have 10 different numbers. Answers will vary.
- First assign every person in your class a number, e.g. 1–25. Decide how many students will be in your sample, e.g. 5. Then use the random number generator on your calculator to produce numbers from 1 to 25. Keep generating numbers until you have 5 different numbers. The students that were assigned these numbers are the 5 students in your random sample. Answers will vary.
- Number of juniors: $\frac{523}{523 + 621} \times 75 = 34.29$. Therefore, there are 34 juniors.
Number of seniors: $\frac{621}{523 + 621} \times 75 = 40.71$. Therefore, there are 41 seniors.
- Number of boarders: $23\% \text{ of } 90 = 20.7$. Therefore, there are 21 boarders.
The rest of the sample will be day students. $90 - 21 = 69$ day students.
- Systematic sample with $k = 10$
 - Yes, assuming that the order of patients is random.
- The sample is not random; therefore, the results are not likely to be random
- It is probably not random. Tony is likely to ask people that he knows or people who approach him.
- Number of staff under 50: $60\% \text{ of } 1500 = 900$
Number of full-time staff under 50: $95\% \text{ of } 900 = 855$
Number to sample: $\frac{855}{1500} \times 80 = 45.6$
Number of part-time staff under 50: $900 - 855 = 45$
Number to sample: $\frac{45}{1500} \times 80 = 2.4$
Number of staff over 50: $1500 - 900 = 600$
Number of full-time staff over 50: $78\% \text{ of } 600 = 460$
Number to sample: $\frac{460}{1500} \times 80 = 24.96$
Number of part-time staff over 50: $600 - 460 = 140$
Number to sample: $\frac{140}{1500} \times 80 = 7.47$
The sample consists of:
Full-time staff under 50: 46
Part-time staff under 50: 2
Full-time staff over 50: 25
Part-time staff over 50: 7

13.2 Exam questions

- The 12% is a statistic from a population; therefore, it represents a population parameter.
The correct answer is **E**.
- The sample statistic of the tennis group lesson is used to predict the population.
The correct answer is **B**.
- Sample statistics are used to estimate population parameters.
The correct answer is **B**.

13.3 The distribution of the sample proportion

13.3 Exercise

- $$\hat{p} = \frac{6}{15}$$

$$= \frac{2}{5}$$
- $$\hat{p} = \frac{6}{20}$$

$$= \frac{3}{10}$$
- $$\hat{p} = \frac{27}{30}$$

$$= \frac{9}{10}$$
- $$\hat{p} = \frac{147}{537}$$
- $$N = 1000$$

$$n = 50$$

$$p = 0.85$$

Is $10n \leq N$? $10n = 500$; therefore, $10n \leq N$.

Is $np \geq 10$? $np = 50 \times 0.9$; therefore, $np \geq 10$.
 $= 45$

Is $nq \geq 10$? $nq = 50 \times 0.1$; therefore, $nq \not\geq 10$.
 $= 5$

The sample is not large.

For the sample to be large,

$$nq = 10$$

$$0.1n = 10$$

$$n = 100$$

$n = 100$ is the smallest sample size that can be considered large.

- 6 $np = 10$ As $p < q$, if $np \leq 10$, then $nq \leq 10$.

$$0.05n = 10$$

$$n = 200$$

Is $10n \leq N$? $10n = 2000$; therefore, $n = 200$ is a large sample.

7

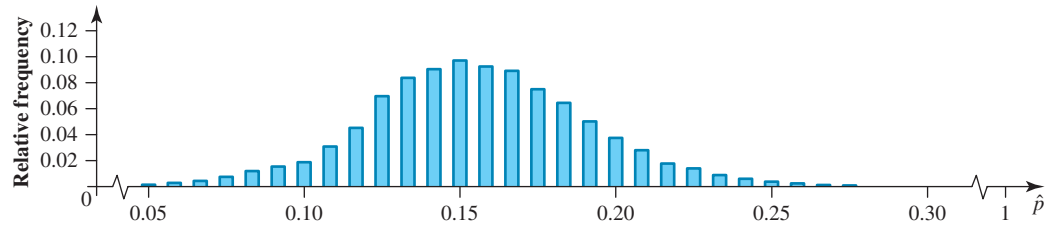

8 a $p = \frac{12}{21} = \frac{4}{7}$

- b 0 females chosen out of 4, 1 chosen out of 4, 2 chosen out of 4, 3 chosen out of 4 or 4 chosen out of 4.

Therefore, the possible values for \hat{p} are $0, \frac{1}{4}, \frac{2}{4}, \frac{3}{4}, 1$.

c

x	\hat{p}	Number of samples	Relative frequency
0	0	${}^{12}C_0 {}^9C_4 = 126$	0.021
1	$\frac{1}{4}$	${}^{12}C_1 {}^9C_3 = 1008$	0.168
2	$\frac{2}{4}$	${}^{12}C_2 {}^9C_2 = 2376$	0.397
3	$\frac{3}{4}$	${}^{12}C_3 {}^9C_1 = 1980$	0.331
4	1	${}^{12}C_4 {}^9C_0 = 495$	0.083
Total samples		5985	

Probability distribution table:

\hat{p}	0	$\frac{1}{4}$	$\frac{2}{4}$	$\frac{3}{4}$	1
$\Pr(\hat{P} = \hat{p})$	0.021	0.168	0.397	0.331	0.083

d $\Pr(\hat{P} > 0.6) = \Pr\left(\hat{P} = \frac{3}{4}\right) + \Pr(\hat{P} = 1)$
 $= 0.331 + 0.083$
 $= 0.414$

e $\Pr(\hat{P} > 0.5 | \hat{P} > 0.3) = \frac{\Pr(\hat{P} > 0.5)}{\Pr(\hat{P} > 0.3)}$
 $= \frac{0.414}{0.414 + 0.397}$
 $= 0.510$

9 a $0, \frac{1}{5}, \frac{2}{5}, \frac{3}{5}, \frac{4}{5}, 1$

b

x	\hat{p}	$\Pr(\hat{P} = \hat{p})$
0	0	${}^5C_0 (0.62)^0 (0.38)^5 = 0.008$
1	$\frac{1}{5}$	${}^5C_1 (0.62)^1 (0.38)^4 = 0.064$
2	$\frac{2}{5}$	${}^5C_2 (0.62)^2 (0.38)^3 = 0.211$
3	$\frac{3}{5}$	${}^5C_3 (0.62)^3 (0.38)^2 = 0.344$
4	$\frac{4}{5}$	${}^5C_4 (0.62)^4 (0.38)^1 = 0.281$
5	1	${}^5C_5 (0.62)^5 (0.38)^0 = 0.092$
	Total samples	5985

c Probability distribution table:

\hat{p}	0	$\frac{1}{5}$	$\frac{2}{5}$	$\frac{3}{5}$	$\frac{4}{5}$	1
$\Pr(\hat{P} = \hat{p})$	0.008	0.064	0.211	0.344	0.281	0.092

d $\Pr(\hat{P} > 0.5) = \Pr\left(\hat{P} = \frac{3}{5}\right) + \Pr\left(\hat{P} = \frac{4}{5}\right) + \Pr(\hat{P} = 1)$
 $= 0.344 + 0.281 + 0.092$
 $= 0.717$

10 $n = 24, p = 0.25$

$X \sim \text{Bi}(24, 0.25)$

$\Pr\left(\hat{P} \geq \frac{5}{24}\right) = \Pr(X \geq 5)$
 $= 0.7534$

11 $n = 25, p = 0.4$

$X \sim \text{Bi}(25, 0.4)$

$\Pr\left(\hat{P} \geq \frac{8}{25} \mid \hat{P} \geq \frac{5}{25}\right) = \Pr(X \geq 8 \mid X \geq 5)$
 $= \frac{\Pr(X \geq 8 \cap X \geq 5)}{\Pr(X \geq 5)}$
 $= \frac{\Pr(X \geq 8)}{\Pr(X \geq 5)}$
 $= 0.8545$

12 $X \sim \text{Bi}(4, p)$

$\Pr(X = 4) = \binom{4}{4} p^4 (1-p)^0 = \frac{1}{625}$
 $p = 0.25$

$\Pr(\hat{P} < 0.5) = \Pr(X < 2)$
 $= \Pr(X \leq 1)$
 $= 0.7383$

The correct answer is C.

13 a $E(\hat{P}) = p$
 $= 0.5$

b $SD(\hat{P}) = \sqrt{\frac{p(1-p)}{n}}$
 $= \sqrt{\frac{0.5 \times 0.5}{50}}$
 $= 0.07$

14 If $N = 1000$, $n = 100$ and $p = 0.8$.

$$\begin{aligned} \text{a } E(\hat{p}) &= p \\ &= 0.8 \end{aligned}$$

$$\begin{aligned} \text{b } \text{SD}(\hat{p}) &= \sqrt{\frac{p(1-p)}{n}} \\ &= \sqrt{\frac{0.8 \times 0.2}{100}} \\ &= 0.04 \end{aligned}$$

$$\begin{aligned} \text{15 } E(\hat{p}) &= p \\ &= 0.15 \end{aligned}$$

$$\begin{aligned} \text{SD}(\hat{p}) &= \sqrt{\frac{p(1-p)}{n}} \\ &= \sqrt{\frac{0.15 \times 0.85}{150}} \\ &= 0.029 \end{aligned}$$

$$\begin{aligned} \text{16 } E(\hat{p}) &= p \\ &= 0.75 \end{aligned}$$

$$\begin{aligned} \text{SD}(\hat{p}) &= \sqrt{\frac{p(1-p)}{n}} \\ &= \sqrt{\frac{0.75 \times 0.25}{100}} \\ &= 0.043 \end{aligned}$$

The correct answer is **A**.

$$\begin{aligned} \text{17 } E(\hat{p}) &= p \\ p &= 0.12 \end{aligned}$$

$$\begin{aligned} \text{SD}(\hat{p}) &= \sqrt{\frac{p(1-p)}{n}} \\ 0.0285 &= \sqrt{\frac{0.12 \times 0.88}{n}} \end{aligned}$$

$$\begin{aligned} 8.1225 \times 10^{-4} &= \frac{0.1056}{n} \\ n &= \frac{0.1056}{8.1225 \times 10^{-4}} \\ &= 130 \end{aligned}$$

$$\begin{aligned} \text{18 } E(\hat{p}) &= p \\ p &= 0.81 \end{aligned}$$

$$\begin{aligned} \text{SD}(\hat{p}) &= \sqrt{\frac{p(1-p)}{n}} \\ 0.0253 &= \sqrt{\frac{0.81 \times 0.19}{n}} \end{aligned}$$

$$\begin{aligned} 6.4009 \times 10^{-4} &= \frac{0.1539}{n} \\ n &= \frac{0.1539}{6.4009 \times 10^{-4}} \\ &= 240.4 \end{aligned}$$

Therefore, $n = 240$.

$$\text{19 } \text{SD}(\hat{p}) = \sqrt{\frac{p(1-p)}{n}}$$

$$0.015 = \sqrt{\frac{p(1-p)}{510}}$$

$$2.25 \times 10^{-4} = \frac{p(1-p)}{510}$$

$$\begin{aligned} 0.11475 &= p(1-p) \\ &= p - p^2 \end{aligned}$$

The quadratic $p^2 - p + 0.11475 = 0$ can be solved using the quadratic formula.

$$\begin{aligned} p &= \frac{-b \pm \sqrt{b^2 - 4ac}}{2a} \\ &= \frac{1 \pm \sqrt{1 - 4 \times 1 \times 0.11475}}{2} \\ &= \frac{1 \pm \sqrt{0.541}}{2} \end{aligned}$$

$$p = 0.87 \text{ or } p = 0.13$$

As $p > 0.5$, the population proportion is $p = 0.87$.

$$\text{20 } \text{SD}(\hat{p}) = \sqrt{\frac{p(1-p)}{n}}$$

$$0.0255 = \sqrt{\frac{p(1-p)}{350}}$$

$$6.5025 \times 10^{-4} = \frac{p(1-p)}{350}$$

$$\begin{aligned} 0.2275875 &= p(1-p) \\ &= p - p^2 \end{aligned}$$

The quadratic $p^2 - p + 0.2275875 = 0$ can be solved using the quadratic formula.

$$\begin{aligned} p &= \frac{-b \pm \sqrt{b^2 - 4ac}}{2a} \\ &= \frac{1 \pm \sqrt{1 - 4 \times 1 \times 0.2275875}}{2} \end{aligned}$$

$$= \frac{1 \pm \sqrt{0.08965}}{2}$$

$$p = 0.65 \text{ or } p = 0.35$$

13.3 Exam questions

$$\text{1 } p = \frac{1}{4} \quad \text{SD}(\hat{p}) = \sqrt{\frac{p(1-p)}{n}}$$

$$\sqrt{\frac{\frac{1}{4} \times \frac{3}{4}}{n}} \leq \frac{1}{100}$$

$$\frac{\sqrt{3}}{4\sqrt{n}} \leq \frac{1}{100}$$

$$\frac{100\sqrt{3}}{4} \leq \sqrt{n}$$

$$\sqrt{n} \geq 25\sqrt{3}$$

$$n \geq 625 \times 3$$

$$n \geq 1875$$

Hence, the smallest value of n is 1875.

Award 1 mark for the correct method.

Award 1 mark for the correct value of n .

VCAA Examination Report note:

Most students identified the correct formula; however, many were unable to correctly transpose the inequality to solve for n or to correctly manipulate the arithmetic involving rational numbers. Some students had poor use of notation work, in that they did not extend the square root sign to include n .

$$\text{2 } n = 16, p = 0.2, X = \text{Bi}(n = 16, p = 0.2)$$

$$\hat{p} = \frac{X}{n}$$

$$\Pr\left(\hat{p} \geq \frac{3}{16}\right) = \Pr(X \geq 3) = 0.6482$$

The correct answer is **A**.

$$3 \quad X = \text{Bi}(5, p), \hat{p} = \frac{X}{5}$$

$$\begin{aligned} \Pr(\hat{p} = 0) &= \Pr(X = 0) \\ &= q^5 \\ &= \frac{1}{243} \end{aligned}$$

$$\Rightarrow q = \frac{1}{3}, p = \frac{2}{3}, X = \text{Bi}\left(5, \frac{2}{3}\right)$$

$$\begin{aligned} \Pr(\hat{p} > 0.6) &= \Pr(X > 3) \\ &= \Pr(X \geq 4) \\ &= 0.4609 \end{aligned}$$

The correct answer is C.

13.4 Confidence intervals

13.4 Exercise

$$1 \quad n = 30$$

$$\hat{p} = 0.80$$

$$z = 1.96$$

The 95% confidence interval is

$$\hat{p} \pm z \sqrt{\frac{\hat{p}(1-\hat{p})}{n}} = 0.80 \pm 1.96 \sqrt{\frac{0.80 \times 0.20}{30}}$$

$$\therefore \text{CI} = (0.66, 0.94)$$

$$2 \quad n = 60$$

$$\hat{p} = 0.85$$

$$z = 1.96$$

The 95% confidence interval is

$$\hat{p} \pm z \sqrt{\frac{\hat{p}(1-\hat{p})}{n}} = 0.85 \pm 1.96 \sqrt{\frac{0.85 \times 0.15}{53}}$$

$$\therefore \text{CI} = (0.76, 0.94)$$

$$3 \quad n = 116$$

$$\hat{p} = \frac{86}{116}$$

$$z = 2.58 \quad (\Pr(Z < -z) = 0.005)$$

The 99% confidence interval is

$$\hat{p} \pm z \sqrt{\frac{\hat{p}(1-\hat{p})}{n}} = \frac{86}{116} \pm 2.58 \sqrt{\frac{\frac{86}{116} \times \frac{30}{116}}{116}}$$

$$\therefore \text{CI} = (0.64, 0.85)$$

$$4 \quad n = 95$$

$$\hat{p} = \frac{35}{95}$$

$$z = 1.64 \quad (\Pr(Z < -z) = 0.05)$$

The 90% confidence interval is

$$\hat{p} \pm z \sqrt{\frac{\hat{p}(1-\hat{p})}{n}} = \frac{35}{95} \pm 1.64 \sqrt{\frac{\frac{35}{95} \times \frac{60}{95}}{95}}$$

$$\therefore \text{CI} = (0.29, 0.45)$$

$$5 \quad \text{D}$$

$$n = 250$$

$$\hat{p} = \frac{20}{250}$$

$$= 0.08$$

$$z = 1.96$$

The 95% confidence interval is

$$\hat{p} \pm z \sqrt{\frac{\hat{p}(1-\hat{p})}{n}} = 0.08 \pm 1.96 \sqrt{\frac{0.08 \times 0.92}{250}}$$

$$\therefore \text{CI} = (0.05, 0.11)$$

The correct answer is D.

$$6 \quad n = 250$$

$$\hat{p} = \frac{230}{250}$$

$$= 0.92$$

$$z = 2.58$$

$$0.92 \pm 2.58 \sqrt{\frac{0.08 \times 0.92}{250}}$$

$$\therefore \text{CI} = (0.876, 0.964)$$

$$7 \quad n = 250$$

$$\hat{p} = \frac{92}{250}$$

$$= 0.368$$

$$z = 1.64$$

The 90% confidence interval is

$$0.368 \pm 1.64 \sqrt{\frac{0.368 \times 0.632}{250}}$$

$$\therefore \text{CI} = (0.318, 0.418)$$

$$8 \quad n = 250, p = 0.65$$

Since n is large, we can approximate the distribution of \hat{P} to that of a normal curve.

$$\text{Therefore, } \mu = p = 0.65 \text{ and } \sigma = \sqrt{\frac{0.65 \times 0.35}{250}} = 0.030.$$

$$\Pr(\hat{P} < 0.6) = 0.0487$$

$$9 \quad n = 200, p = 0.8$$

Since n is large, we can approximate the distribution of \hat{P} to that of a normal curve.

$$\text{Therefore, } \mu = p = 0.8 \text{ and } \sigma = \sqrt{\frac{0.8 \times 0.2}{200}} = 0.0283$$

$$\Pr(0.8 < \hat{P} < 0.9 | \hat{P} > 0.65) = \frac{\Pr(0.8 < \hat{P} < 0.9)}{\Pr(\hat{P} > 0.65)}$$

$$= \frac{0.4998}{0.9999}$$

$$= 0.4998$$

$$10 \quad 90\% \text{ confidence interval, } z = 1.64$$

\hat{p} will be at the centre of the interval, $\hat{p} = 0.8$

$$\text{The confidence interval is } \hat{p} \pm z \sqrt{\frac{\hat{p}(1-\hat{p})}{n}}$$

$$\text{This means that } z \sqrt{\frac{\hat{p}(1-\hat{p})}{n}} = 0.05.$$

$$z \sqrt{\frac{\hat{p}(1-\hat{p})}{n}} = 0.05$$

$$1.64 \sqrt{\frac{0.8 \times 0.2}{n}} = 0.05$$

$$\sqrt{\frac{0.16}{n}} = 0.0305$$

$$\frac{0.16}{n} = 9.285 \times 10^{-4}$$

$$n = \frac{0.16}{9.285 \times 10^{-4}}$$

$$= 172.1$$

A sample of size 173 is needed.

- 11 95% confidence interval, $z = 1.96$
 \hat{p} will be at the centre of the interval, $\hat{p} = 0.4$

The confidence interval is $\hat{p} \pm z\sqrt{\frac{\hat{p}(1-\hat{p})}{n}}$.

This means that $z\sqrt{\frac{\hat{p}(1-\hat{p})}{n}} = 0.05$.

$$z\sqrt{\frac{\hat{p}(1-\hat{p})}{n}} = 0.05$$

$$1.96\sqrt{\frac{0.4 \times 0.6}{n}} = 0.05$$

$$\sqrt{\frac{0.24}{n}} = 0.0255$$

$$\frac{0.24}{n} = 6.5077 \times 10^{-4}$$

$$n = \frac{0.24}{6.5077 \times 10^{-4}} = 368.8$$

A sample of size 369 is needed.
 The correct answer is C.

- 12 $z = 1.96$
 \hat{p} will be at the centre of the interval, $\hat{p} = 0.3$

The confidence interval is $\hat{p} \pm z\sqrt{\frac{\hat{p}(1-\hat{p})}{n}}$.

This means that $z\sqrt{\frac{\hat{p}(1-\hat{p})}{n}} = 0.05$.

$$z\sqrt{\frac{\hat{p}(1-\hat{p})}{n}} = 0.05$$

$$1.96\sqrt{\frac{0.3 \times 0.7}{n}} = 0.05$$

$$\sqrt{\frac{0.21}{n}} = 0.0255$$

$$\frac{0.21}{n} = 6.5077 \times 10^{-4}$$

$$n = \frac{0.21}{6.5077 \times 10^{-4}} = 322.7$$

A sample of size 323 is needed.

- 13 $z = 2.58$
 \hat{p} will be at the centre of the interval, $\hat{p} = 0.25$

The confidence interval is $\hat{p} \pm z\sqrt{\frac{\hat{p}(1-\hat{p})}{n}}$.

This means that $z\sqrt{\frac{\hat{p}(1-\hat{p})}{n}} = 0.05$.

$$z\sqrt{\frac{\hat{p}(1-\hat{p})}{n}} = 0.05$$

$$2.58\sqrt{\frac{0.25 \times 0.75}{n}} = 0.05$$

$$\sqrt{\frac{0.1875}{n}} = 0.0194$$

$$\frac{0.1875}{n} = 3.756 \times 10^{-4}$$

$$n = \frac{0.1875}{3.756 \times 10^{-4}} = 497.62$$

A sample of size 498 is needed.

- 14 95% confidence interval means that $z = 1.96$
 The interval is $(0, 0.05)$.

\hat{p} will be at the centre of the interval, $\hat{p} = 0.025$ (2.5%)

The confidence interval is $\hat{p} \pm z\sqrt{\frac{\hat{p}(1-\hat{p})}{n}}$.

This means that $z\sqrt{\frac{\hat{p}(1-\hat{p})}{n}} = 0.025$.

$$z\sqrt{\frac{\hat{p}(1-\hat{p})}{n}} = 0.025$$

$$1.96\sqrt{\frac{0.025 \times 0.975}{n}} = 0.025$$

$$\sqrt{\frac{0.024375}{n}} = 0.012755$$

$$\frac{0.024375}{n} = 1.6269 \times 10^{-4}$$

$$n = \frac{0.024375}{1.6269 \times 10^{-4}} = 149.8$$

A sample of size 150 is needed.

- 15 99% confidence interval means that $z = 2.58$.
 \hat{p} will be at the centre of the interval, $\hat{p} = 0.94$ (94%).

The confidence interval is $\hat{p} \pm z\sqrt{\frac{\hat{p}(1-\hat{p})}{n}}$.

This means that $z\sqrt{\frac{\hat{p}(1-\hat{p})}{n}} = 0.04$.

$$z\sqrt{\frac{\hat{p}(1-\hat{p})}{n}} = 0.04$$

$$2.58\sqrt{\frac{0.94 \times 0.06}{n}} = 0.04$$

$$\sqrt{\frac{0.0564}{n}} = 0.0155$$

$$\frac{0.0564}{n} = 2.404 \times 10^{-4}$$

$$n = \frac{0.0564}{2.404 \times 10^{-4}} = 234.6$$

A sample of size 235 is needed.

$$16 \quad M = 1.96\sqrt{\frac{\hat{p}(1-\hat{p})}{n}}$$

$$0.03 = 1.96\sqrt{\frac{0.15 \times 0.85}{n}}$$

$$n = 544$$

The sample size needed is 544 people.

- 17 \hat{p} will be at the centre of the interval, $\hat{p} = 0.90$.

The confidence interval is $\hat{p} \pm z\sqrt{\frac{\hat{p}(1-\hat{p})}{n}}$.

This means that $z\sqrt{\frac{\hat{p}(1-\hat{p})}{n}} = 0.05$.

$$z\sqrt{\frac{\hat{p}(1-\hat{p})}{n}} = 0.05$$

$$z\sqrt{\frac{0.9 \times 0.1}{100}} = 0.05$$

$$0.03z = 0.05$$

$$z = 1.67$$

$$\Pr(-1.67 < z < 1.67) = 0.9$$

Benton's is 90% sure of their claim.

18 \hat{p} will be at the centre of the interval, $\hat{p} = 0.775$

The confidence interval is $\hat{p} \pm z\sqrt{\frac{\hat{p}(1-\hat{p})}{n}}$.

This means that $z\sqrt{\frac{\hat{p}(1-\hat{p})}{n}} = 0.025$.

$$z\sqrt{\frac{\hat{p}(1-\hat{p})}{n}} = 0.025$$

$$z\sqrt{\frac{0.775 \times 0.225}{250}} = 0.025$$

$$0.026z = 0.025$$

$$z = 0.947$$

$$\Pr(-0.947 < z < 0.947) = 0.66$$

Benton's is 66% sure of their claim.

13.4 Exam questions

1 $n = 48$, $\hat{p} = 0.125$, 95% $z = 1.96$

$$SD(\hat{p}) = \sqrt{\frac{0.125 \times (1 - 0.125)}{48}} = 0.0477$$

$$\hat{p} \pm zSD(\hat{p}) = 0.125 \pm 1.96 \times 0.0477$$

$$\therefore \text{CI} = (0.0314, 0.2186)$$

The correct answer is **A**.

$$2 \quad p = \frac{0.039 + 0.121}{2}$$

$$p = 0.08$$

The correct answer is **A**.

3 A 99% confidence interval implies:

$$0.64 \pm 2.58 \times 0.014$$

$$\Rightarrow (0.603, 0.676)$$

Alternatively, use the inbuilt functions in CAS.

The correct answer is **E**.

13.5 Review

13.5 Exercise

Technology free: short answer

1 One in 10 is a population parameter, that is $p = 0.1$. His survey method asks every 10th person. The sample that he collects should reflect the population; that is, about 10% will have been to Alice Springs.

2 **a** Population = 1100, sample size = 100

$$\text{b } \hat{p} = \frac{70}{100} = 0.7$$

$$\text{c } p = \frac{600}{1100}$$

$$= \frac{6}{11}$$

3 **a** $n = 10\,000$

b The population size is unknown (how many times in total the coin will be tossed).

$$\text{c } \hat{p} = \frac{5100}{10\,000} = 0.51$$

d The 95% confidence interval is

$$\hat{p} \pm 1.96\sqrt{\frac{\hat{p}(1-\hat{p})}{n}} = 0.51 \pm 1.96\sqrt{\frac{0.51 \times 0.49}{10\,000}}$$

4 **a** $N = 52\,000$

$$\text{b } n = \frac{52\,000}{25} = 2080$$

$$\text{c } \hat{p} = \frac{1600}{2080} = \frac{10}{13}$$

$$5 \text{ a } \hat{p} = \frac{12}{120} = \frac{1}{10}$$

b The 95% confidence interval is $\hat{p} \pm 1.96\sqrt{\frac{\hat{p}(1-\hat{p})}{n}}$

$$= 0.1 \pm 1.96\sqrt{\frac{0.1 \times 0.9}{120}}$$

$$= 0.1 \pm 1.96\sqrt{\frac{0.09}{120}}$$

$$\text{c } M = 1.96\sqrt{\frac{\hat{p}(1-\hat{p})}{n}}$$

$$= 1.96\sqrt{\frac{0.09}{120}}$$

$$\text{d } M = 1.96\sqrt{\frac{0.09}{60}}$$

$$= 1.96\sqrt{\frac{0.09}{120 \times 0.5}}$$

$$= 1.96\sqrt{\frac{0.09 \times 2}{120}}$$

$$= 1.96\sqrt{\frac{0.09}{120}} \times \sqrt{2}$$

The margin of error would increase by a factor of $\sqrt{2}$.

$$6 \text{ a } \hat{p} = \frac{0.62 + 0.78}{2}$$

$$= \frac{1.4}{2}$$

$$= 0.7$$

$$\text{b } M = 0.78 - 0.7$$

$$= 0.08$$

Technology active: multiple choice

7 Johansen Enterprises operates for 15 hours per day. It is capable of producing 3000 items per hour. The sample is taken from the 3000 items produced in the hour. This is the population size.

From each hour's output, 10 items are chosen for inspection so that the machinery can be adjusted if necessary. This is the sample size.

The correct answer is **A**.

8 According to the Australian Bureau of Statistics, the unemployment rate is 6.4%. It doesn't say that this information comes from a census. As it is an exact value, it is most likely a sample statistic.

According to the 2011 census, on average there are 1.7 motor vehicles per dwelling. As this is from a census, it is a population parameter.

The correct answer is **B**.

9 This is a random sample.

The correct answer is **E**.

10 The distribution should be symmetric.

The correct answer is **B**.

$$\begin{aligned} 11 \text{ SD}(\hat{p}) &= \sqrt{\frac{p(1-p)}{n}} \\ &= \sqrt{\frac{0.37 \times 0.63}{120}} \\ &= 0.044 \end{aligned}$$

The correct answer is **D**.

$$12 \quad X \sim \text{Bi}(5, p)$$

$$\begin{aligned} \Pr(X = 0) &= \binom{5}{0} p^0 (1-p)^5 = \frac{1}{1024} \\ p &= 0.75 \end{aligned}$$

$$\begin{aligned} \Pr(\hat{p} \geq 0.8) &= \Pr(X \geq 4) \\ &= 0.6328 \end{aligned}$$

The correct answer is **D**.

13 In 95% of samples, the population parameter lies in the interval.

The correct answer is **C**.

$$14 \quad n = 150$$

$$\hat{p} = 0.36$$

$$z = 2.58 \quad (\Pr(Z < z) = 0.005)$$

The 99% confidence interval is

$$\hat{p} \pm z \sqrt{\frac{\hat{p}(1-\hat{p})}{n}} = 0.36 \pm 2.58 \sqrt{\frac{0.36 \times 0.64}{150}}$$

$$\therefore \text{CI} = (0.26, 0.46)$$

The correct answer is **D**.

15 \hat{p} will be at the centre of the interval, $\hat{p} = 0.65$

The confidence interval is $\hat{p} \pm z \sqrt{\frac{\hat{p}(1-\hat{p})}{n}}$. This means that

$$z \sqrt{\frac{\hat{p}(1-\hat{p})}{n}} = 0.05.$$

$$z \sqrt{\frac{\hat{p}(1-\hat{p})}{n}} = 0.05$$

$$z \sqrt{\frac{0.65 \times 0.35}{200}} = 0.05$$

$$z = 1.4825$$

$$\Pr(-1.4825 < z < 1.4825) = 0.8618$$

The Melbourne Vixens are 86% sure of their claim.

The correct answer is **E**.

$$16 \quad z = 1.96$$

\hat{p} will be at the centre of the interval, $\hat{p} = 0.7$

The confidence interval is $\hat{p} \pm z \sqrt{\frac{\hat{p}(1-\hat{p})}{n}}$. This means that

$$z \sqrt{\frac{\hat{p}(1-\hat{p})}{n}} = 0.05.$$

$$z \sqrt{\frac{\hat{p}(1-\hat{p})}{n}} = 0.05$$

$$1.96 \sqrt{\frac{0.7 \times 0.3}{n}} = 0.05$$

$$\sqrt{\frac{0.21}{n}} = 0.0255$$

$$\frac{0.21}{n} = 6.508 \times 10^{-4}$$

$$n = \frac{0.21}{6.508 \times 10^{-4}}$$

$$= 322.69$$

A sample of size 323 is needed.

The correct answer is **A**.

Technology active: extended response

$$17 \quad \hat{p} = 0.86, n = 50$$

For a 90% confidence interval, $z = 1.645$.

$$\begin{aligned} \hat{p} \pm z \sqrt{\frac{\hat{p}(1-\hat{p})}{n}} &= 0.86 \pm 1.645 \sqrt{\frac{0.86 \times 0.14}{50}} \\ &= 0.78, 0.94 \end{aligned}$$

Therefore, the 90% confidence interval is (0.78, 0.94).

$$18 \quad n = 12, p = 0.3$$

$$X \sim \text{Bi}(12, 0.3)$$

$$\Pr\left(\hat{p} \geq \frac{5}{12} \mid \hat{p} \geq \frac{3}{12}\right) = \Pr(X \geq 5 \mid X \geq 3)$$

$$= \frac{\Pr(X \geq 5 \cap X \geq 3)}{\Pr(X \geq 3)}$$

$$= \frac{\Pr(X \geq 5)}{\Pr(X \geq 3)}$$

$$= 0.3698$$

$$19 \quad z = 1.96, n = 100$$

$$0.13 = \hat{p} - z \sqrt{\frac{\hat{p}(1-\hat{p})}{n}}$$

$$0.13 = \hat{p} - 1.96 \sqrt{\frac{\hat{p}(1-\hat{p})}{100}}$$

$$0.13 = \hat{p} - 0.196 \sqrt{\hat{p}(1-\hat{p})}$$

$$\hat{p} - 0.13 = 0.196 \sqrt{\hat{p}(1-\hat{p})}$$

$$(\hat{p} - 0.13)^2 = 0.196^2 \hat{p}(1-\hat{p})$$

$$\hat{p}^2 - 0.26\hat{p} + 0.0169 = 0.038416(\hat{p} - \hat{p}^2)$$

$$0 = 1.038416\hat{p}^2 - 0.298416\hat{p} + 0.0169$$

Solving on CAS, $\hat{p} = 0.0776$ or $\hat{p} = 0.2098$.

As the lower limit is 13%, the sample proportion must be larger than this. To 2 decimal places, the sample proportion is 0.21.

20 If each sample is considered separately (Breanna's method),

$$n = 100, z = 1.96$$

$$\text{Breanna's sample: } \hat{p} = 0.23$$

$$\begin{aligned} 1.96 \sqrt{\frac{\hat{p}(1-\hat{p})}{n}} &= 1.96 \sqrt{\frac{0.23 \times 0.77}{100}} \\ &= 0.0824 \end{aligned}$$

The confidence interval is 0.23 ± 0.0824 .

$$\therefore \text{CI} = (0.1475, 0.3125)$$

Kayley's sample: $\hat{p} = 0.2$

$$\begin{aligned} 1.96 \sqrt{\frac{\hat{p}(1-\hat{p})}{n}} &= 1.96 \sqrt{\frac{0.2 \times 0.8}{100}} \\ &= 0.0784 \end{aligned}$$

The confidence interval is 0.2 ± 0.0784 .

$$\therefore \text{CI} = (0.1216, 0.2784)$$

Teagan's sample: $\hat{p} = 0.19$

$$\begin{aligned} 1.96 \sqrt{\frac{\hat{p}(1-\hat{p})}{n}} &= 1.96 \sqrt{\frac{0.19 \times 0.81}{100}} \\ &= 0.0769 \end{aligned}$$

The confidence interval is 0.19 ± 0.0769 .

$$\therefore \text{CI} = (0.1131, 0.2669)$$

Average: (0.1274, 0.2859)

Combining the samples (Kayley's method) means that $n = 300$.

The number of yes votes in Breanna's sample is 23% of 100 = 23.

The number of yes votes in Kayley's sample is 20% of 100 = 20.

The number of yes votes in Teagan's sample is 19% of 100 = 19.

The total number of yes votes is $23 + 20 + 19 = 62$

The sample proportion is $\hat{p} = \frac{62}{300}$.

$$1.96 \sqrt{\frac{\hat{p}(1-\hat{p})}{n}} = 1.96 \sqrt{\frac{\frac{62}{300} \times \frac{238}{300}}{300}}$$

$$= 0.0458$$

The confidence interval is $\frac{62}{300} \pm 0.0458$.

CI = (0.1608, 0.2525)

As the results differ, the method does matter (Teagan is incorrect).

Kayley's method is better. Because they actually sampled 300 people, this should be the sample size. As a larger sample size is more likely to have similar proportions to the population, the confidence interval can be smaller.

$$3 \text{ a } L = \text{Bi}(n = 22, p = 0.1)$$

$$\Pr(L \geq 1) = 1 - \Pr(L = 0)$$

$$= 1 - 0.9^{22}$$

$$= 0.9015$$

Award 1 mark for using the binomial.

Award 1 mark for the correct probability.

VCAA Assessment Report note:

This question was answered well. Most students recognised that it was binomial and gave the correct n and p values. Some used $\Pr(X > 1)$ instead of $\Pr(X \geq 1)$.

$$b \Pr(L < 5 | L \geq 1)$$

$$= \frac{\Pr(1 \leq L < 5)}{\Pr(L \geq 1)}$$

$$= \frac{0.839389}{0.9015}$$

$$= 0.9311$$

Award 1 mark for using conditional probability and the binomial.

Award 1 mark for the correct probability.

VCAA Assessment Report note:

Many students recognised that this was a conditional probability question but had the incorrect numerator or denominator. Some included 5 in their calculations, getting 0.9798. Others rounded too soon and gave 0.9312 as the answer.

$$c \ X = N(\mu = 190, \sigma^2 = 36)$$

$$\Pr(X < 180) = 0.0478$$

Award 1 mark for using normal cdf.

Award 1 mark for the correct probability.

VCAA Assessment Report note:

Some students thought 3 hours and 10 minutes was 3.1 hours and 6 minutes was 0.6 hours. Others had the standard deviation as 10 minutes. Some gave the answer without showing any working. Students are reminded that some working must be shown for questions worth more than one mark. $\Pr(Y > 180) = 0.9522$ was a common incorrect response.

$$d \ S = \text{Bi}(n = 100, p = 0.0478)$$

$$\Pr(\hat{P} \geq 0.06 | \hat{P} \geq 0.05)$$

$$= \frac{\Pr(\hat{P} \geq 0.06)}{\Pr(\hat{P} \geq 0.05)}$$

$$= \frac{\Pr(S \geq 6)}{\Pr(S \geq 5)}$$

$$= \frac{0.344511}{0.523588}$$

$$= 0.658$$

Award 1 mark for using conditional probability.

Award 1 mark for converting to the binomial.

Award 1 mark for the correct probability.

VCAA Assessment Report note:

Most students used the conditional probability formula but tried to use the normal distribution rather than the binomial distribution.

$$e \ Y = N(\mu = 180, \sigma^2 = ?)$$

$$\Pr(Y > 190) = 0.12$$

$$\Rightarrow \Pr(Y < 190) = 0.88$$

$$\Pr(Z < z) = 0.88$$

$$z = 1.17499$$

13.5 Exam questions

$$1 \text{ a } \text{The proportion of faulty pegs} = \frac{8}{41} \text{ [1 mark]}$$

$$b \ \hat{p} = \frac{X}{12} \quad X \stackrel{d}{=} \text{Bi}\left(n = 12, p = \frac{1}{6}\right)$$

$$\Pr\left(\hat{p} < \frac{1}{6}\right) = \Pr(X < 2)$$

$$= \Pr(X = 0) + \Pr(X = 1)$$

$$\Pr\left(\hat{p} < \frac{1}{6}\right) = \left(\frac{5}{6}\right)^{12} + 12 \times \left(\frac{1}{6}\right) \left(\frac{5}{6}\right)^{11}$$

$$= \left(\frac{5}{6}\right)^{11} \left(\frac{5}{6} + 2\right)$$

$$= \frac{17}{6} \left(\frac{5}{6}\right)^{11}$$

Award 1 mark for the correct method.

Award 1 mark for the correct answer.

VCAA Examination Report note:

Most students recognised this as a binomial distribution; however, few managed to correctly find the two component expressions. Even fewer successfully managed to manipulate these expressions to the format specified by the question. Another common error was to apply the standard deviation formula.

$$2 \ n = ?, \quad \hat{p} = \frac{3}{5}$$

$$SD(\hat{P}) = \sqrt{\frac{0.6 \times (1 - 0.6)}{n}} < 0.08$$

$$\sqrt{n} > \frac{\sqrt{0.24}}{0.08}$$

$$n > \frac{0.24}{0.08^2} = 37.5$$

$$n = 38$$

The correct answer is **D**.

$$1.17499 = \frac{190 - 180}{\sigma} = \frac{10}{\sigma}$$

$$\sigma = 8.5107$$

Award 1 mark for using the inverse normal distribution.

Award 1 mark for the correct standard deviation.

f Since n is large, use the binomial approximation.

$$\Pr(\text{third}) = \frac{1}{2} \times \frac{1}{2} \times \frac{1}{2} = \frac{1}{8}$$

Award 1 mark for the correct probability.

$$\mathbf{g} \hat{p} = \frac{6}{100} = 0.06, n = 100, 95\% \Rightarrow z = 1.96$$

Confidence interval for p :

$$\hat{p} \pm z \sqrt{\frac{\hat{p}(1-\hat{p})}{n}}$$

$$= 0.06 \pm 1.96 \sqrt{\frac{0.06(1-0.06)}{100}}$$

$$= (0.01, 0.11)$$

Alternatively, use inbuilt CAS functions.

Award 1 mark for the correct confidence interval.

VCAA Assessment Report note:

Students were not expected to write out the formula; the relevant computation could be done directly using technology. There were some rounding errors. A common incorrect interval was (0.01, 0.12).

$$\mathbf{h} E(X) = \int_0^{210} \frac{x(210-x)e^{-\frac{x-210}{20}}}{400} dx$$

$$= 170.01 \text{ (solved using CAS)}$$

Award 1 mark for the correct expectation.

$$\mathbf{4} \mathbf{a} f(x) = \begin{cases} \frac{4}{625} (5x^3 - x^4) & 0 \leq x \leq 5 \\ 0 & \text{elsewhere} \end{cases}$$

$$E(X) = \int_0^5 xf(x) dx = \int_0^5 \frac{4}{625} (5x^4 - x^5) dx = \frac{10}{3}$$

The mean life span = $3\frac{1}{3}$ weeks

Award 1 mark for the correct method.

Award 1 mark for the correct answer.

VCAA Examination Report note:

This question was done well. Some students worked out the median instead of the mean or evaluated

$$\int_0^5 \left(\frac{4}{625} (5x^3 - x^4) \right) dx. \text{ Other students gave an}$$

approximate answer. Some students tried to treat f as a discrete random variable.

$$\mathbf{b} \Pr(X > 2) = \int_2^5 f(x) dx$$

$$\Pr(X > 2) = \int_2^5 \frac{4}{625} (5x^3 - x^4) dx = \frac{2853}{3125}$$

$$80 \Pr(X > 2) = 73$$

Award 1 mark for the correct method.

Award 1 mark for the correct answer.

VCAA Examination Report note:

Some students found the probability but did not multiply by 80. Other students used a discrete random variable or the normal distribution. Some students evaluated

$$80 \int_0^2 \left(\frac{4}{625} (5x^3 - x^4) \right) dx \text{ or } 80 \int_3^5 \left(\frac{4}{625} (5x^3 - x^4) \right) dx.$$

Other students rounded to 74.

$$\mathbf{c} \Pr(X \geq 4 | X \geq 2) = \frac{\Pr(X \geq 4)}{\Pr(X \geq 2)}$$

$$= \frac{\int_4^5 f(x) dx}{\int_2^5 f(x) dx} = \frac{4}{5} = 0.2878$$

Award 1 mark for the correct method.

Award 1 mark for the correct answer.

VCAA Examination Report note:

Many students used conditional probability. Some students used $\Pr(X \leq 4 | X \leq 2)$. Other students rounded answers too early.

$$\mathbf{d} A \stackrel{d}{=} N(14.1, 2.1^2)$$

$$\Pr(16 \leq A \leq 18) = 0.1512$$

Award 1 mark for the correct probability.

VCAA Examination Report note:

This question was answered well. Some students rounded incorrectly, giving their answer as 0.1511 or 0.1516.

$$\mathbf{e} \Pr(A < v) = 0.05$$

$$v = 10.6$$

Award 1 mark for the correct answer.

VCAA Examination Report note:

This question was answered reasonably well. A common incorrect answer was 9.9.

$$\mathbf{f} \mathbf{i} V \stackrel{d}{=} \text{Bi}(n = 36, p = 0.0527)$$

$$\Pr(V \geq 3) = 0.2947$$

Award 1 mark for the correct probability.

$$\mathbf{ii} \Pr(V \geq n) \leq 0.01$$

$$\Pr(V \geq 6) = 0.0107 > 0.010$$

$$\Pr(V \geq 7) = 0.0024 < 0.01, n = 7$$

Award 1 mark for the correct method.

Award 1 mark for the correct answer.

VCAA Examination Report note:

A common incorrect answer was $n = 6$. Some students gave an answer without any working. Trial and error is an acceptable method.

$$\mathbf{iii} E(\hat{P}) = 0.0527$$

$$SD(\hat{P}) = \sqrt{\frac{p(1-p)}{n}} = \sqrt{\frac{0.0527(1-0.0527)}{36}} = 0.0372$$

Award 1 mark for the correct method.

Award 1 mark for the correct answer.

VCAA Examination Report note:

Some students found $E(X) = 36 \times 0.0527 = 1.8972$.

Many students were able to find the standard deviation.

$$\mathbf{iv} \Pr(p - SD < \hat{P} < p + SD) = \Pr(0.0527 - 0.0372 < \hat{P} < 0.0527 + 0.0372)$$

$$= \Pr(0.0155 < \hat{P} < 0.0899) \times 36$$

$$= \Pr(0.55 < V < 3.2)$$

$$= \Pr(1 \leq V \leq 3)$$

$$= 0.7380$$

Award 1 mark for the correct method.

Award 1 mark for the correct answer.

VCAA Examination Report note:

Many students were able to find the first interval. Some students used the normal distribution. Others rounded their answer to 0.738.

$$g \left(\hat{p} - z\sqrt{\frac{\hat{p}(1-\hat{p})}{n}}, \left(\hat{p} + z\sqrt{\frac{\hat{p}(1-\hat{p})}{n}} \right) \right) = (0.0234, 0.0866)$$

$$\hat{p} = \frac{0.0234 + 0.0866}{2} = 0.055, 95\% \quad z = 1.96$$

$$1.96\sqrt{\frac{0.055(1-0.055)}{n}} = \frac{0.0866 - 0.0234}{2} = 0.0316$$

$$n = 199.95$$

Sample size $n = 200$

Award 1 mark for the correct method.

Award 1 mark for the correct answer.

VCAA Examination Report note:

Many students had the proportion as 0.0527 or 0.55 instead of 0.055. Others did not include the 1.96.

- 5 a Mathsland (M) $\sim N(68, 64)$

$$\Pr(60 < M < 90) = 0.838 \quad [1 \text{ mark}]$$

$$b \text{ i } \Pr(H|S) = \frac{\Pr(H \cap S)}{\Pr(S)} = \frac{0.09}{0.29} = 0.310 \quad [1 \text{ mark}]$$

VCAA Examination Report note:

This question was answered reasonably well. Some students gave their answer as 0.31. A common mistake

was $\frac{\Pr(H)}{\Pr(S)} = \frac{0.1587}{0.29} = 0.547$ or $\frac{\Pr(H \cap S)}{\Pr(S)} = \frac{0.9}{0.1857}$, giving an answer greater than 1.

$$ii \Pr(H) = 0.1587, \Pr(S) = 0.29$$

$$\Pr(H \cap S) = 0.09$$

$$\Pr(H) \times \Pr(S) = 0.1587 \times 0.29$$

$$= 0.0460$$

$$\neq \Pr(H \cap S)$$

$$= 0.09$$

[1 mark]

Events H and S are not independent.

VCAA Examination Report note:

A mathematical explanation was required. Some students confused mutually exclusive events with independent events. A common mistake was

$$\Pr(H|S) = \Pr(S).$$

- c i $X \sim \text{Bi}(n = 16, p = 0.1587)$

$$\Pr(X = 1) = \binom{16}{1} 0.1587 \times (1 - 0.1587)^{15} \quad [1 \text{ mark}]$$

$$= 0.190 \quad [1 \text{ mark}]$$

VCAA Examination Report note:

This question was reasonably well done. A method was required to get full marks. Stating the correct n and p value was sufficient. Some students gave their answer as 0.19.

$$ii \ n = 16, \hat{p} = \frac{X}{16}$$

$$\Pr(\hat{p} > 0.1) = \Pr(X > 1.6) \quad [1 \text{ mark}]$$

$$= \Pr(X \geq 2) = 0.747 \quad [1 \text{ mark}]$$

VCAA Examination Report note:

Some students used the normal approximation to the binomial distribution. There was poor use of variables, for example, $\Pr(\hat{p} > 0.1) = \Pr(\hat{p} > 1.6) = \Pr(\hat{p} \geq 2)$.

$$iii \ X \sim \text{Bi}(n = ?, p = 0.1587), \hat{p} = \frac{X}{n}$$

$$\Pr\left(\hat{p} > \frac{1}{n}\right) = \Pr\left(\frac{X}{n} > \frac{1}{n}\right)$$

$$= \Pr(X > 1) = \Pr(X \geq 2)$$

$$\Pr(X \geq 2) > 0.99 \quad [1 \text{ mark}]$$

$$\Pr(X \leq 1) = \Pr(X = 0) + \Pr(X = 1) \leq 0.01$$

$$\text{Solving } 0.8413^n + n \times 0.8413^{n-1} \times 0.1587 = 0.01$$

$$\text{gives } n = 38.93$$

$$\text{so } n \text{ must be at least } 39. \quad [1 \text{ mark}]$$

VCAA Examination Report note:

This question was not answered well. Many students appeared to be confused by the terminology

$$\Pr\left(\hat{p}_n > \frac{1}{n}\right) \cdot 1 - \Pr(X = 0) < 0.01 \text{ was often}$$

evaluated, giving $n = 27$. Trial and error was an acceptable method.

$$d \text{ i } \hat{p} = \frac{0.145 + 0.102}{2} = 0.1235 \quad [1 \text{ mark}]$$

VCAA Examination Report note:

Many students tried to find the sample size rather than the proportion. $n = 900$ was often given.

- ii p (Mathsland) = 0.1587 is not contained within the confidence interval for Statsville, which suggests that the proportions between the two towns differ. [1 mark]

VCAA Examination Report note:

The confidence interval needed to be referred to in the answer.

$$e \ M(t) = \begin{cases} \frac{3}{50} \left(\frac{t}{50}\right)^2 e^{-\left(\frac{t}{50}\right)^3} & t \geq 0 \\ 0 & t < 0 \end{cases}$$

$$E(T) = \int_0^{\infty} \frac{3t}{50} \left(\frac{t}{50}\right)^2 e^{-\left(\frac{t}{50}\right)^3} dt \quad [1 \text{ mark}]$$

$$= 44.6 \text{ min} \quad [1 \text{ mark}]$$

VCAA Examination Report note:

Some students found the median or the mode. Others found the area under the curve. Some had one of the terminals

incorrect, for example, $\int_0^{437} (t \times M(t)) dt$. There were

rounding errors; 44.7 was occasionally given.

$$f \Pr(T < 15) = \int_0^{15} \left(\frac{3}{50} \left(\frac{t}{50}\right)^2 e^{-\left(\frac{t}{50}\right)^3}\right) dt$$

$$= 0.0266 \quad [1 \text{ mark}]$$

VCAA Examination Report note:

This question was answered reasonably well.

$\int_0^{15} (t \times M(t)) dt = 0.2991$ was a common incorrect answer.

- g Let x be the probability that a non-Year-12 student is elite.

$$0.05 \times \frac{1}{7} + x \times \frac{6}{7} = 0.0266 \quad [1 \text{ mark}]$$

$$x = 0.0227 \quad [1 \text{ mark}]$$

VCAA Examination Report note:

This question was not answered well. There were a number of other approaches to this question, for example, Karnaugh maps, tree diagrams or a conditional probability statement.

A common incorrect answer was $\frac{6}{7} \times 0.0266 = 0.0228$.