



8

# ESSENTIAL MATHEMATICS

FOR THE VICTORIAN CURRICULUM  
THIRD EDITION

**DAVID GREENWOOD  
BRYN HUMBERSTONE  
JUSTIN ROBINSON  
JENNY GOODMAN  
JENNIFER VAUGHAN  
STUART PALMER**



**CAMBRIDGE**



Shaftesbury Road, Cambridge CB2 8BS, United Kingdom  
One Liberty Plaza, 20th Floor, New York, NY 10006, USA  
477 Williamstown Road, Port Melbourne, VIC 3207, Australia  
314–321, 3rd Floor, Plot 3, Splendor Forum, Jasola District Centre, New Delhi – 110025, India  
103 Penang Road, #05–06/07, Visioncrest Commercial, Singapore 238467

Cambridge University Press is part of Cambridge University Press & Assessment, a department of the University of Cambridge.

We share the University’s mission to contribute to society through the pursuit of education, learning and research at the highest international levels of excellence.

[www.cambridge.org](http://www.cambridge.org)

© David Greenwood, Bryn Humberstone, Justin Robinson, Jenny Goodman and Jennifer Vaughan 2016, 2020, 2024

This publication is in copyright. Subject to statutory exception and to the provisions of relevant collective licensing agreements, no reproduction of any part may take place without the written permission of Cambridge University Press & Assessment.

First published 2016

Second Edition 2020

Third Edition 2024

20 19 18 17 16 15 14 13 12 11 10 9 8 7 6 5 4 3 2 1

Cover designed by Denise Lane (Sardine)

Typeset by diacriTech

Printed in Singapore by C & C Offset Printing Co., Ltd.

A catalogue record for this book is available from the National Library of Australia at [www.nla.gov.au](http://www.nla.gov.au)

ISBN 978-1-009-48075-8

Additional resources for this publication at [www.cambridge.edu.au/GO](http://www.cambridge.edu.au/GO)

#### **Reproduction and Communication for educational purposes**

The Australian *Copyright Act 1968* (the Act) allows a maximum of one chapter or 10% of the pages of this publication, whichever is the greater, to be reproduced and/or communicated by any educational institution for its educational purposes provided that the educational institution (or the body that administers it) has given a remuneration notice to Copyright Agency Limited (CAL) under the Act.

For details of the CAL licence for educational institutions contact:

Copyright Agency Limited  
Level 12, 66 Goulburn Street  
Sydney NSW 2000  
Telephone: (02) 9394 7600  
Facsimile: (02) 9394 7601  
Email: [memberservices@copyright.com.au](mailto:memberservices@copyright.com.au)

#### **Reproduction and Communication for other purposes**

Except as permitted under the Act (for example a fair dealing for the purposes of study, research, criticism or review) no part of this publication may be reproduced, stored in a retrieval system, communicated or transmitted in any form or by any means without prior written permission. All inquiries should be made to the publisher at the address above.

Cambridge University Press & Assessment has no responsibility for the persistence or accuracy of URLs for external or third-party internet websites referred to in this publication, and does not guarantee that any content on such websites is, or will remain, accurate or appropriate. Information regarding prices, travel timetables and other factual information given in this work is correct at the time of first printing but Cambridge University Press & Assessment does not guarantee the accuracy of such information thereafter.

*Cambridge University Press & Assessment acknowledges the Aboriginal and Torres Strait Islander peoples of this nation. We acknowledge the traditional custodians of the lands on which our company is located and where we conduct our business. We pay our respects to ancestors and Elders, past and present. Cambridge University Press & Assessment is committed to honouring Aboriginal and Torres Strait Islander peoples’ unique cultural and spiritual relationships to the land, waters and seas and their rich contribution to society.*

# Contents

<i>About the authors</i>	ix
<i>Acknowledgements</i>	x
<i>Introduction</i>	xii
<i>Guide to the working programs in exercises</i>	xiii
<i>Guide to this resource</i>	xiv
<i>Working with unfamiliar problems: Part 1</i>	xviii
<i>Working with unfamiliar problems: Part 2</i>	xx

## 1 Computation with integers

2

<b>1A</b> Adding and subtracting positive integers	CONSOLIDATING	4
<b>1B</b> Multiplying and dividing positive integers	CONSOLIDATING	9
<b>1C</b> Number properties	CONSOLIDATING	14
<b>1D</b> Divisibility and prime factorisation	CONSOLIDATING	20
<b>1E</b> Negative integers	CONSOLIDATING	26
<b>Progress quiz</b>		31
<b>1F</b> Adding and subtracting negative integers		32
<b>CONSOLIDATING</b>		37
<b>Applications and problem-solving</b>		39
<b>1G</b> Multiplying and dividing negative integers		44
<b>1H</b> Order of operations and substitution		49
<b>Modelling</b>		51
<b>Technology and computational thinking</b>		54
<b>Investigation</b>		56
<b>Problems and challenges</b>		57
<b>Chapter summary</b>		58
<b>Chapter checklist with success criteria</b>		59
<b>Chapter review</b>		

## Strands: Number Algebra

## 2 Angle relationships and properties of geometrical figures

62

<b>2A</b> Reviewing angles	CONSOLIDATING	64
<b>2B</b> Transversal lines and parallel lines	CONSOLIDATING	70
<b>2C</b> Triangles	CONSOLIDATING	77
<b>2D</b> Quadrilaterals		85
<b>Progress quiz</b>		92
<b>2E</b> Polygons	EXTENDING	94
<b>Applications and problem-solving</b>		100
<b>2F</b> Three-dimensional solids and Euler's formula		102
<b>EXTENDING</b>		108
<b>2G</b> Three-dimensional coordinate systems		118
<b>Modelling</b>		

## Strand: Space

Technology and computational thinking	120
Investigation	122
Problems and challenges	124
Chapter summary	125
Chapter checklist with success criteria	126
Chapter review	129

### 3 Fractions, decimals and percentages 134

Strand: Number

<b>3A</b> Equivalent fractions <b>CONSOLIDATING</b>	136
<b>3B</b> Operations with fractions <b>CONSOLIDATING</b>	142
<b>3C</b> Operations with negative fractions	151
<b>3D</b> Understanding decimals <b>CONSOLIDATING</b>	157
<b>3E</b> Operations with decimals <b>CONSOLIDATING</b>	164
<b>3F</b> Terminating decimals, recurring decimals and rounding	171
<b>Progress quiz</b>	177
<b>3G</b> Converting fractions, decimals and percentages <b>CONSOLIDATING</b>	178
<b>3H</b> Finding a percentage and expressing as a percentage	186
<b>3I</b> Decreasing and increasing by a percentage	192
<b>Applications and problem-solving</b>	198
<b>3J</b> Calculating percentage change, profit and loss	200
<b>3K</b> Solving percentage problems using the unitary method <b>EXTENDING</b>	206
<b>Modelling</b>	210
<b>Technology and computational thinking</b>	212
<b>Investigation</b>	214
<b>Problems and challenges</b>	216
<b>Chapter summary</b>	217
<b>Chapter checklist with success criteria</b>	219
<b>Chapter review</b>	221

### 4 Measurement and Pythagoras' theorem 224

Strands: Measurement  
Number

<b>4A</b> Length and perimeter <b>CONSOLIDATING</b>	226
<b>4B</b> Circumference of circles <b>CONSOLIDATING</b>	234
<b>4C</b> Area <b>CONSOLIDATING</b>	240
<b>4D</b> Area of special quadrilaterals	249
<b>4E</b> Area of circles	255
<b>4F</b> Area of sectors and composite shapes <b>EXTENDING</b>	262
<b>4G</b> Surface area of prisms <b>EXTENDING</b>	269
<b>Progress quiz</b>	275
<b>4H</b> Volume and capacity	277
<b>4I</b> Volume of prisms and cylinders	283

	<b>Applications and problem-solving</b>	290
4J	Units of time and time zones	292
4K	Introducing Pythagoras' theorem	301
4L	Using Pythagoras' theorem	307
4M	Calculating the length of a shorter side	313
	<b>Modelling</b>	319
	<b>Technology and computational thinking</b>	320
	<b>Investigation</b>	322
	<b>Problems and challenges</b>	324
	<b>Chapter summary</b>	325
	<b>Chapter checklist with success criteria</b>	326
	<b>Chapter review</b>	330

## 5 Algebraic techniques and index laws 334

5A	The language of algebra	CONSOLIDATING	336
5B	Substitution and equivalence	CONSOLIDATING	342
5C	Adding and subtracting terms		347
5D	Multiplying and dividing terms		351
5E	Adding and subtracting algebraic fractions	EXTENDING	355
5F	Multiplying and dividing algebraic fractions	EXTENDING	360
	<b>Progress quiz</b>		365
5G	Expanding brackets		366
5H	Factorising expressions		372
5I	Applying algebra		376
	<b>Applications and problem-solving</b>		380
5J	Index laws for multiplication and division		383
5K	The zero index and power of a power		388
	<b>Modelling</b>		392
	<b>Technology and computational thinking</b>		394
	<b>Investigation</b>		396
	<b>Problems and challenges</b>		398
	<b>Chapter summary</b>		399
	<b>Chapter checklist with success criteria</b>		400
	<b>Chapter review</b>		402

## Semester review 1 406

## 6 Ratios and rates 416

6A	Simplifying ratios	418
6B	Solving ratio problems	425
6C	Scale drawings	431

### Strands: Algebra Number

### Strands: Measurement Algebra

6D	Introducing rates	438
	<b>Progress quiz</b>	443
6E	Solving rate problems	444
6F	Speed	449
	<b>Applications and problem-solving</b>	455
6G	Ratios and rates and the unitary method <b>EXTENDING</b>	458
	<b>Modelling</b>	464
	<b>Technology and computational thinking</b>	465
	<b>Investigation</b>	467
	<b>Problems and challenges</b>	468
	<b>Chapter summary</b>	469
	<b>Chapter checklist with success criteria</b>	470
	<b>Chapter review</b>	472

## 7 Equations and inequalities **476**

7A	Reviewing equations <b>CONSOLIDATING</b>	478
7B	Equivalent equations <b>CONSOLIDATING</b>	484
7C	Equations with fractions	491
7D	Equations with the pronumeral on both sides	496
7E	Equations with brackets	501
	<b>Progress quiz</b>	506
7F	Solving simple quadratic equations <b>EXTENDING</b>	507
7G	Formulas and relationships	511
	<b>Applications and problem-solving</b>	516
7H	Applications of equations	518
7I	Inequalities	523
7J	Solving inequalities	528
	<b>Modelling</b>	533
	<b>Technology and computational thinking</b>	534
	<b>Investigation</b>	536
	<b>Problems and challenges</b>	537
	<b>Chapter summary</b>	538
	<b>Chapter checklist with success criteria</b>	539
	<b>Chapter review</b>	540

## 8 Probability and statistics **544**

8A	Interpreting graphs and tables <b>CONSOLIDATING</b>	546
8B	Frequency tables and tallies <b>CONSOLIDATING</b>	554
8C	Graphs of frequency tables	560
8D	Measures of centre	569
8E	Measures of spread <b>EXTENDING</b>	575
8F	Surveying and sampling	581
	<b>Progress quiz</b>	588

### Strand: Algebra

### Strands: Statistics Probability Algebra

<b>8G</b>	Probability	590
<b>8H</b>	Two-step experiments	597
	<b>Applications and problem-solving</b>	603
<b>8I</b>	Tree diagrams	606
<b>8J</b>	Venn diagrams and two-way tables	611
<b>8K</b>	Experimental probability	619
	<b>Modelling</b>	625
	<b>Technology and computational thinking</b>	626
	<b>Investigation</b>	628
	<b>Problems and challenges</b>	629
	<b>Chapter summary</b>	630
	<b>Chapter checklist with success criteria</b>	631
	<b>Chapter review</b>	633

## 9 Linear relationships 638

### Strand: Algebra

<b>9A</b>	The Cartesian plane <b>CONSOLIDATING</b>	640
<b>9B</b>	Using rules, tables and graphs to explore linear relationships	644
<b>9C</b>	Finding the rule using a table of values	649
<b>9D</b>	Using graphs to solve linear equations	657
<b>9E</b>	Using graphs to solve linear inequalities	667
<b>9F</b>	The $x$ - and $y$ -intercepts	681
	<b>Progress quiz</b>	686
<b>9G</b>	Gradient <b>EXTENDING</b>	688
<b>9H</b>	Gradient–intercept form <b>EXTENDING</b>	696
	<b>Applications and problem-solving</b>	703
<b>9I</b>	Applications of straight line graphs	705
<b>9J</b>	Non-linear graphs <b>EXTENDING</b>	711
	<b>Modelling</b>	717
	<b>Technology and computational thinking</b>	719
	<b>Investigation</b>	721
	<b>Problems and challenges</b>	723
	<b>Chapter summary</b>	724
	<b>Chapter checklist with success criteria</b>	725
	<b>Chapter review</b>	728

## 10 Transformations and congruence 734

### Strand: Space

<b>10A</b>	Reflection	736
<b>10B</b>	Translation	744
<b>10C</b>	Rotation	749
<b>10D</b>	Congruent figures	756
<b>10E</b>	Congruent triangles	762

	<b>Progress quiz</b>	770
<b>10F</b>	Tessellations <b>EXTENDING</b>	772
<b>10G</b>	Congruence and quadrilaterals <b>EXTENDING</b>	780
	<b>Applications and problem-solving</b>	785
<b>10H</b>	Similar figures	787
<b>10I</b>	Similar triangles	794
	<b>Modelling</b>	802
	<b>Technology and computational thinking</b>	803
	<b>Investigation</b>	807
	<b>Problems and challenges</b>	808
	<b>Chapter summary</b>	809
	<b>Chapter checklist with success criteria</b>	810
	<b>Chapter review</b>	813

## 11 Algorithmic thinking (online only)

Introduction  
 Activity 1: Divisibility tests  
 Activity 2: Working with lists of data  
 Activity 3: Minimising and maximising in rectangles

## Semester review 2 819

<i>Index</i>	<i>827</i>
<i>Answers</i>	<i>830</i>



## About the authors



**David Greenwood** is the Head of Mathematics at Trinity Grammar School in Melbourne and has 30+ years' experience teaching mathematics from Year 7 to 12. He is the lead author for the Cambridge Essential series and has authored more than 80 titles for the Australian Curriculum and for the syllabuses of the states and territories. He specialises in analysing curriculum and the sequencing of course content for school mathematics courses. He also has an interest in the use of technology for the teaching of mathematics.



**Bryn Humberstone** graduated from the University of Melbourne with an Honours degree in Pure Mathematics, and has 20+ years' experience teaching secondary school mathematics. He has been a Head of Mathematics since 2014 at two independent schools in Victoria. Bryn is passionate about applying the science of learning to teaching and curriculum design, to maximise the chances of student success.



**Justin Robinson** is co-founder of *The Wellbeing Distillery*, an organisation committed to energising, equipping and empowering teachers. He consults with schools globally on the fields of student and educator wellbeing. Prior to this, Justin spent 25 years teaching mathematics, covering all levels of secondary education including teaching VCE, IB and A-Levels. His driving passion was engaging and challenging students within a safe learning environment. Justin is an Honorary Fellow of the University of Melbourne's Graduate School of Education.



**Jenny Goodman** has taught in schools for over 28 years and is currently teaching at a selective high school in Sydney. Jenny has an interest in the importance of literacy in mathematics education, and in teaching students of differing ability levels. She was awarded the Jones Medal for education at Sydney University and the Bourke Prize for Mathematics. She has written for CambridgeMATHS NSW and was involved in the Spectrum and Spectrum Gold series.



**Jennifer Vaughan** has taught secondary mathematics for over 30 years in New South Wales, Western Australia, Queensland and New Zealand and has tutored and lectured in mathematics at Queensland University of Technology. She is passionate about providing students of all ability levels with opportunities to understand and to have success in using mathematics. She has had extensive experience in developing resources that make mathematical concepts more accessible, hence facilitating student confidence, achievement and an enjoyment of maths.



**Stuart Palmer** was born and educated in NSW. He is a fully qualified high school mathematics teacher with more than 25 years' experience teaching students from all walks of life in a variety of schools. He has been Head of Mathematics in two schools. He is very well known by teachers throughout the state for the professional learning workshops he delivers. Stuart also assists thousands of Year 12 students every year as they prepare for their HSC Examinations. At the University of Sydney, Stuart spent more than a decade running tutorials for pre-service mathematics teachers.

## Acknowledgements

The author and publisher wish to thank the following sources for permission to reproduce material:

**Cover:** © Getty Images / Vlad\_Zukerman

**Images:** © Getty Images / Rolf Bruderer, Chapter 1 Opener / Maica, p.4 / Daniel Milchev, p.7 / Brais Seara/GI, p.9 / Peter Dazeley, p.12 / Michael Dunning, p.13 / Slavica, p.14 / Chris Ryan, p.18 / ROBERT BROOK/SCIENCE PHOTO LIBRARY, p.19 / ThePalmer, p.20 / Vanni Archive, p.24 / Cheryl Chan, p.25 / guvendemir, p.26 / Westend61, p.29 / Streeter Lecka, p.32 / Science Photo Library, p.35 / d3sign, p.36 / Alexander Spatari, p.37 / praetorianphoto, p.39 / RyersonClark, p.42 / Westend61, p.43 / Matt Meadows, p.44 / Rachel Dulson, p.48 / biglanphoto, p.50 / Martin Barraud, p.53 / Inventori, Chapter 2 Opener / NilsBV, p.64 / Alan Schein, p.66 / Joseph Sohm, p.71 / skyNext, p.77 / akurtz, p.85 / Allan Baxter, p.91 / Digital Vision, p.94 / lubilub, p.95 / Waitforlight, p.99 / Jonathan Herbert I JH Images, p.102(1) / Artur Debat, p.115 / Dieter Spannknebel, p.117 / yogysic, p.118 / LueratSaticohb, p.119 / Bim, p.123 / deliormanli, p.133 / Amanda Hall / Robert Harding, Chapter 3 Opener / svetikd, p.136 / Thomas Barwick, p.140 / d3sign, p.141 / Monty Rakusen, p.142 / Juj Winn, p.147 / Simon Bottomley, p.153 / Ladislav Kubeš, p.157 / moodboard, p.161 / SimonSkafar, p.162 / Mario Gutiérrez, p.164 / andresr, p.164 / Don Mason, p.170 / minemero, p.171 / Tom Merton, p.175 / Hero Creative, p.178 / Grace Cary, p.183 / GMVozd, p.184 / FatCamera, p.186 / Bob Sacha, p.190 / philpell, p.192 / Mikael Vaisanen, p.194 / EXTREME-PHOTOGRAPHER, p.195 / Douglas Sacha, p.199 / Claudia Burlotti, p.200 / Flashpop, p.203 / Gigja Einarsdottir, p.204(1) / Archive Photos, p.204(2) / Andrew Merry, p.205 / ewg3D, p.206 / Oscar Wong, p.210 / Catherine Falls Commercial, p.211 / krisanapong detraphiphat, p.212 / Steve Allen, p.215 / jayk7, p.233 / John Lamb, p.226 / Jackyenjoyphotography, p.227, p.232 / Natapong Supalertsophon, p.234 / Richard Cummins, p.240 / ImagePatch, p.241 / fotoVoyager, p.248 / moodboard, p.249 / Science Photo Library – NASA, p.261 / SerjioLe, p.262 / Douglas Sacha, p.266 / Nenov, p.268 / Witthaya Prasongsin, p.273 / chee gin tan, p.277 / Karl Johaentges / LOOK-foto, p.283 / Mensent Photography, p.288 / Jason marz, p.289 / Chris Ryan, p.290 / chokkicx, p.292 / MARK GARLICK/SCIENCE PHOTO LIBRARY, p.299 / Thomas Barwick, p.300 / Przemyslaw Klos, p.306 / bruceman, p.307 / Cyrano db, p.312 / Andrew Aitchison, p.313 / Ippei Naoi, p.322 / Michael H, p.323 / Kinwun, Chapter 5 Opener / Matthias Kulka, p.336 / Agnieszka Olek, p.338 / Johner Images, p.341 / Ashley Cooper, p.342 / Maya Karkalicheva, p.350 / shaunl, p.351 / MarioGuti, p.355 / Anastasiia Krivenok, p.359 / Ivcandy, p.364 / AzmanJaka, p.366 / Nazar Abbas Photography, p.370 / Premal Dhruv, p.376 / Lighthouse Films, p.378 / Astrakan Images, p.380 / Dag Sundberg, p.381 / Tom Werner, p.382 / Westend61, p.387 / monkeybusinessimages, p.391 / Michael Fichtner / EyeEm, p.394 / ANDREJ ISAKOVIC, Chapter 6 Opener / James wasswa / 500px, p.423 / xavierarnau, p.424 / Colin Anderson Productions Pty Ltd, p.425 / Ollie Millington, p.436(1) / SolStock, p.437(1) / pop\_jop, p.437(2) / Australian Scenics, p.438 / Tuncmemo / 500px, p.441 / skynesher, p.444 / Jena Ardell, p.446 / Alistair Berg, p.448 / sjallenphotography, p.449 / James O'Neil, p.457 / NiCK, p.458 / JohnnyGreig, p.462 / Deeipilot, p.463 / PM Images, p.466 / Andrew Merry, p.475 / sydeen, Chapter 7 Opener / BSIP/UIG, p.478 / Maria Korneeva, p.482 / Tetra Images, p.483 / Jessie Casson, p.489 / gradyreese, p.490 / Dan Dalton, p.491 / PeopleImages, p.496 /

Sebastian Rothe, p.497 / Image Source, p.500 / Monty Rakusen, p.501 / Maskot, p.504 / A-Digit, p.505 / Anton Petrus, p.515 / Petmal, p.518 / guvendemir, p.527 / credit name unknown, p.528 / Chris Ryan, p.534 / Justin Pumfrey, p.536 / Alan Schein, p.541 / courtneyk, p.543 / Hinterhaus Productions, p.544 / funky-data, Chapter 8 Opener / Tracey Media, p.548 / Marco Bottigelli, p.554 / Ariel Skelley, p.556 / Nazar Abbas Photography, p.580(1) / secret agent mike, p.580(2) / cnythzl, p.583 / Westend61, p.591 / aapsky, p.592 / Jose Luis Pelaez Inc, p.598 / asiseeit, p.599 / oonal, p.600 / Rubberball/Mike Kemp, p.606 / Martin Dimitrov, p.608 / Stuart Kinlough, p.621 / Peter Vahlersvik, p.628 / Marcel ter Bekke, p.62 / Arno Masse, Chapter 9 Opener / jayk7, p.646 / PinkBadger, p.651 / ImageMediaGroup, p.659 / Vesnaandjic, p.660 / Monty Rakusen, p.683 / fotograf, p.690 / Razvan25, p.695 / pixonaut, p.702 / Hiroshi Watanabe, p.703 / europhoto, p.707 / Lyn Balzer and Tony Perkins, p.711 / Ascent Xmedia, p.712 / Patrick Civello, p.713 / Peter Lourenco, p.719 / Annie Otzen, p.720 / Boris Zhitkov, p.721 / hdagli, p.735 / somchajj, Chapter 10 Opener / Mlenny, p.738 / europhoto, p.751 / oxygen, p.763 / EDUARD MUZHEVSKYI/SCIENCE PHOTO LIBRARY, p.771 / Carterdayne, p.774(4) / nnorozoff, p.774(5) / Rabilbani, p.774(6) / Kellyreekolibry, p.775(1) / Rayhuephoto, p.775(2) / TED MEAD, p.781 / Ger Bosma, p.789 / Achim Thomae, p.796 / Petko Ninov, p.804 / fotostorm, p.805 / Kieran Stone, p.808 / Ignacio Palacios, p.809 / Alex Ratson, p.820 / Jekaterina Nikitina, Chapter 11 Opener; Bill Casselman, p.54; Zelenka68, p.102(2); © Melburnian / Creative Commons Attribution 3.0 Unported license, Chapter 4 Opener; NASA Kennedy / Wikimedia Commons Public Domain, p.269; © Kabelleger - David Gubler / Creative Commons Attribution-Share Alike 3.0 Unported, p.511.

Every effort has been made to trace and acknowledge copyright. The publisher apologises for any accidental infringement and welcomes information that would redress this situation.

© Extracts from the VCE F-10 study design (2023–2027) reproduced by permission; © VCAA. VCE is a registered trademark of the VCAA. The VCAA does not endorse or make any warranties regarding this study resource. Current VCE Study Designs and related content can be accessed directly at [www.vcaa.vic.edu.au](http://www.vcaa.vic.edu.au). Readers are also advised to check for updates and amendments to VCE Study Designs on the VCAA website and via the VCAA *Bulletin* and the VCAA Notices to Schools.

# Introduction

The third edition of *Essential Mathematics for the Victorian Curriculum* has been significantly revised and updated to suit the teaching and learning of Version 2.0 of the Victorian Curriculum. Many of the established features of the series have been retained, but there have been some substantial revisions, improvements and new elements introduced for this edition across the print, digital and teacher resources.

## New content and some restructuring

New topics have come in at all year levels. In **Year 7** there are new lessons on ratios, volume of triangular prisms, and measurement of circles, and all geometry topics are now contained in a single chapter (Chapter 4). In **Year 8**, there are new lessons on 3D-coordinates and techniques for collecting data. For **Year 9**, error in measurement is new in Chapter 5, and sampling and proportion is introduced in Chapter 9.

In **Year 10**, four lessons each on networks and combinatorics have been added, and there are new lessons on logarithmic scales, rates of change, two-way tables and cumulative frequency curves and percentiles. The Year 10 book also covers all the 10A topics from Version 2.0 of the curriculum. This content can be left out for students intending to study General Mathematics, or prioritised for students intending to study Mathematical Methods or Specialist Mathematics.

Version 2.0 places increased emphasis on **investigations** and **modelling**, and this is covered with revised Investigations and Modelling activities at the end of chapters. There are also many new elaborations covering **First Nations Peoples' perspectives** on mathematics, ranging across all six content strands of the curriculum. These are covered in a suite of specialised investigations provided in the Online Teaching Suite.

## Other new features

- **Technology and computational thinking** activities have been added to the end of every chapter to address the curriculum's increased focus on the use of technology and the understanding and application of algorithms.
- **Targeted Skillsheets** – downloadable and printable – have been written for every lesson in the series, with the intention of providing additional practice for students who need support at the basic skills covered in the lesson, with questions linked to worked examples in the book.
- **Editable PowerPoint lesson summaries** are also provided for each lesson in the series, with the intention of saving the time of teachers who were previously creating these themselves.

## Diagnostic Assessment tool

Also new for this edition is a flexible, comprehensive Diagnostic Assessment tool, available through the Online Teaching Suite. This tool, featuring around 10,000 new questions, allows teachers to set diagnostic tests that are closely aligned with the textbook content, view student performance and growth via a range of reports, set follow-up work with a view to helping students improve, and export data as needed.

# Guide to the working programs in exercises

The suggested working programs in the exercises in this book provide three pathways to allow differentiation for Growth, Standard and Advanced students (schools will likely have their own names for these levels).

Each exercise is structured in subsections that match the mathematical proficiencies of Fluency, Problem-solving and Reasoning, as well as Enrichment (Challenge). (Note that Understanding is covered by ‘Building understanding’ in each lesson.) In the exercises, the questions suggested for each pathway are listed in three columns at the top of each subsection:

- The left column (lightest shaded colour) is the Growth pathway
- The middle column (medium shaded colour) is the Standard pathway
- The right column (darkest shaded colour) is the Advanced pathway.

Growth	Standard	Advanced
<b>FLUENCY</b>		
1, 2, 3(½), 4	2, 3(½), 4, 5(½)	3(½), 4, 5(½)
<b>PROBLEM-SOLVING</b>		
6	6, 7	7, 8
<b>REASONING</b>		
9	9, 10	10, 11
<b>ENRICHMENT: Adjusting concentration</b>		
–	–	12

The working program for Exercise 3A in Year 7. The questions recommended for a Growth student are: 1, 2, 3(1/2), 4, 6 and 9. See note below.

## Gradients within exercises and proficiency strands

The working programs make use of the two difficulty gradients contained within exercises. A gradient runs through the overall structure of each exercise – where there is an increasing level of mathematical sophistication required from Fluency to Problem-solving to Reasoning and Enrichment – but also within each proficiency; the first few questions in Fluency, for example, are easier than the last Fluency question.

## The right mix of questions

Questions in the working programs are selected to give the most appropriate mix of *types* of questions for each learning pathway. Students going through the Growth pathway should use the left tab, which includes all but the hardest Fluency questions as well as the easiest Problem-solving and Reasoning questions. An Advanced student can use the right tab, proceed through the Fluency questions (often half of each question), and have their main focus be on the Problem-solving and Reasoning questions, as well as the Enrichment questions. A Standard student would do a mix of everything using the middle tab.

## Choosing a pathway

There are a variety of ways to determine the appropriate pathway for students through the course. Schools and individual teachers should follow the method that works for them. If required, the prior-knowledge pre-tests (now found online) can be used as a tool for helping students select a pathway. The following are recommended guidelines:

- A student who gets 40% or lower should complete the Growth questions
- A student who gets above 40% and below 85% should complete the Standard questions
- A student who gets 85% or higher should complete the Advanced questions.

**Note:** The nomenclature used to list questions is as follows:

- 3, 4: complete all parts of questions 3 and 4
- 1–4: complete all parts of questions 1, 2, 3 and 4
- 10(½): complete half of the parts from question 10 (a, c, e, ... or b, d, f, ...)
- 2–4(½): complete half of the parts of questions 2, 3 and 4
- 4(½), 5: complete half of the parts of question 4 and all parts of question 5
- —: do not complete any of the questions in this section.

# Guide to this resource

## PRINT TEXTBOOK FEATURES

- NEW New lessons:** authoritative coverage of new topics in the Victorian Curriculum 2.0 in the form of new, road-tested lessons throughout each book.
- Victorian Curriculum 2.0:** content strands and content descriptions are listed at the beginning of the chapter (see the teaching program for more detailed curriculum documents)
- In this chapter:** an overview of the chapter contents
- Working with unfamiliar problems:** a set of problem-solving questions not tied to a specific topic
- Chapter introduction:** sets context for students about how the topic connects with the real world and the history of mathematics
- Learning intentions:** sets out what a student will be expected to learn in the lesson
- Lesson starter:** an activity, which can often be done in groups, to start the lesson
- Key ideas:** summarises the knowledge and skills for the lesson
- Building understanding:** a small set of discussion questions to consolidate understanding of the Key ideas (replaces Understanding questions formerly inside the exercises)
- Worked examples:** solutions and explanations of each line of working, along with a description that clearly describes the mathematics covered by the example

170 Chapter 2 Geometry and networks
2K Introduction to networks 171

**2K Introduction to networks**

**LEARNING INTENTIONS**

- To know what is meant by a network graph
- To know the key features of a network graph
- To be able to find the degree of a vertex and the sum of degrees for a graph
- To be able to describe simple walks through a network using the vertex labels

A network is a collection of points (vertices or nodes) which can be connected by lines (edges). Networks are used to help solve a range of real-world problems including travel and distance problems, intelligence and crime problems, computer network problems and even metabolic network problems associated with the human body. In Mathematics, a network diagram can be referred to as a graph, not to be confused with the graph of a function like  $y = x^2 + 3$ .

**Lesson starter: The Königsberg bridge problem**

The seven bridges of Königsberg is a well-known historical problem solved by Leonhard Euler who laid the foundations of graph theory. It involves two islands at the centre of an old German city connected by seven bridges over a river as shown in these diagrams.



The problem states: Is it possible to start at one point and pass over every bridge exactly once and return to your starting point?

- Make a copy of this simplified map of the seven bridges of Königsberg and try tracing out a walk that crosses all bridges exactly once. Try starting at different places.

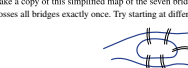

- Investigate if there might be a solution to this problem if one of the bridges is removed.
- Investigate if there might be a solution to this problem if one bridge is added.

**KEY IDEAS**

- A **network** or **graph** is a diagram connecting points using lines.
  - The points are called **vertices** (or **nodes**). Vertices is singular, vertices is plural.
  - The lines are called **edges**.
- The **degree** of a vertex is the number of edges connected to it.
  - A vertex is odd if the number of edges connected to it is odd.
  - A vertex is even if the number of edges connected to it is even.
- The sum of degrees is calculated by adding up the degrees of all the vertices in a graph.
  - It is also equal to twice the number of edges.
- A **walk** is any type of route through a network.
  - A walk can be defined using the vertex labels.
  - Example:  $A-B-C-A-D$ .

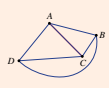

**BUILDING UNDERSTANDING**

1 Here is a graph representing roads connecting three towns A, B and C.

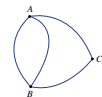

- How many different roads (edges) does this graph have?
- How many different vertices (nodes) does this graph have?
- If no road (edge) is used more than once and no town (vertex/node) is visited more than once, how many different walks are there if travelling from:
  - A to C?
  - A to B?
  - B to C?
- How many roads connect to:
  - town A?
  - town B?
  - town C?

2 This graph uses four edges to connect four vertices.



- How many edges connect to vertex A?
- What is the degree of vertex A?
- State the total number of edges on the graph.
- By finding the number of edges connected to each vertex, find the sum of degrees for the graph.
- What do you notice about the total number of edges and the sum of degrees for this graph?

- 11 **Now you try:** try-it-yourself questions provided after every worked example in exactly the same style as the worked example to give immediate practice
- 12 **Gentle start to exercises:** the exercise begins at Fluency, with the first question always linked to the first worked example in the lesson
- 13 **Working programs:** differentiated question sets for three ability levels in exercises
- 14 **Example references:** show where a question links to a relevant worked example – the first question is always linked to the first worked example in a lesson
- 15 **Problems and challenges:** in each chapter provides practice with solving problems connected with the topic
- 16 **Chapter checklist with success criteria:** a checklist of the learning intentions for the chapter, with example questions
- 17 **Applications and problem-solving:** a set of three extended-response questions across two pages that give practice at applying the mathematics of the chapter to real-life contexts
- 18 **NEW Technology and computational thinking activity** in each chapter addresses the curriculum's increased focus on the use of different forms of technology, and the understanding and implementation of algorithms
- 19 **Modelling activities:** an activity in each chapter gives students the opportunity to learn and apply the mathematical modelling process to solve realistic problems

402 Chapter 9: Quadratic expressions and equations

**Example 13** Simplifying algebraic fractions involving quadratic expressions

**Simplify**  $\frac{8x^2 - 9}{20x^2 + 12x - 9} - \frac{25x^2 - 10x + 1}{10x^2 - 15x + 5}$

**SOLUTION**

$\frac{8x^2 - 9}{20x^2 + 12x - 9} - \frac{25x^2 - 10x + 1}{10x^2 - 15x + 5}$

$\frac{(4x + 3)(2x - 3)}{(4x + 3)(5x - 3)} - \frac{(5x - 1)(5x + 1)}{(5x - 3)(2x - 1)}$

$\frac{2x - 3}{5x - 3} - \frac{(5x - 1)(5x + 1)}{(5x - 3)(2x - 1)}$

$\frac{2x - 3}{5x - 3} - \frac{25x^2 - 4}{(5x - 3)(2x - 1)}$

$\frac{(2x - 3)(2x - 1) - (25x^2 - 4)}{(5x - 3)(2x - 1)}$

$\frac{4x^2 - 5x + 3 - 25x^2 + 4}{(5x - 3)(2x - 1)}$

$\frac{-21x^2 - 5x + 7}{(5x - 3)(2x - 1)}$

**EXPLANATION**

First, use the range of factoring techniques to factorise all quadratics.

Cancel to simplify.

**Now you try**

1 Simplify  $\frac{8x^2 - 4}{12x^2 + 12x + 6} - \frac{25x^2 - 20x + 6}{12x^2 + 12x + 6}$

**Exercise 9E**

**FLUENCY**

1 Factorise the following:

a)  $2x^2 + 3x - 2$     b)  $2x^2 + 3$     c)  $3x^2 + 4x + 4$     d)  $5x^2 - 5x + 2$

2 Factorise the following:

a)  $2x^2 - 11x + 5$     b)  $8x^2 + 2x - 3$     c)  $6x^2 - 11x + 4$     d)  $3x^2 - 2x - 1$

e)  $2x^2 - 11x - 5$     f)  $2x^2 - 3x + 7$     g)  $5x^2 + 2x - 8$     h)  $2x^2 + 5x - 12$

i)  $2x^2 - 5x - 12$     j)  $11x^2 - 7x - 8$     k)  $8x^2 - 22x + 6$     l)  $6x^2 - 14x - 5$

m)  $7x^2 + 9x - 12$     n)  $10x^2 + 11x - 6$     o)  $8x^2 + 13x + 6$     p)  $4x^2 - 5x + 1$

q)  $8x^2 - 14x + 5$     r)  $8x^2 - 24x + 15$     s)  $8x^2 - 13x + 6$     t)  $6x^2 + 9x - 10$

3 Factorise the following:

a)  $10x^2 + 25x + 10$     b)  $20x^2 + 39x + 18$     c)  $21x^2 + 22x - 6$

d)  $50x^2 + 15x - 10$     e)  $40x^2 - x - 6$     f)  $20x^2 - 13x - 5$

g)  $24x^2 - 36x + 15$     h)  $45x^2 - 48x + 8$     i)  $25x^2 - 30x + 18$

**PROBLEM SOLVING**

4 Factorise by first taking out the common factor:

a)  $6x^2 + 9x + 40$     b)  $6x^2 + 15x + 36$     c)  $6x^2 + 18x + 3$

d)  $12x^2 + 9x + 60$     e)  $16x^2 - 24x + 8$     f)  $90x^2 + 90x - 100$

g)  $-36x^2 - 15x - 60$     h)  $12x^2 - 24x + 27$     i)  $20x^2 - 25x + 5$

108 Chapter 10: Measurement

**Chapter checklist and success criteria**

A printable version of this checklist is available in the Interactive Textbook.

Chapter checklist	Success criteria
10. I can find the area of squares and other rectangles.	<input type="checkbox"/>
11. I can find the area of triangles.	<input type="checkbox"/>
12. I can find the area of composite shapes.	<input type="checkbox"/>
13. I can find the volume of rectangular prisms (cuboids).	<input type="checkbox"/>
14. I can find the volume of triangular prisms.	<input type="checkbox"/>
15. I can convert between units of capacity.	<input type="checkbox"/>
16. I can convert between units of capacity.	<input type="checkbox"/>
17. I can convert between units of mass.	<input type="checkbox"/>
18. I can convert between units of mass.	<input type="checkbox"/>

18 **Technology and computational thinking**

404 Chapter 11: Planning, problem-solving and financial mathematics

**Technology and computational thinking**

**Coding task**

**Key technology: Spreadsheets**

People with access to spreadsheets can store up to thousands of rows and columns of data. They can use spreadsheets to store data, perform calculations, and create charts and graphs. Spreadsheets are a powerful tool for data analysis and visualization.

We will use the following income tax rules for this investigation.

Income bracket	Tax rate
0 - 18,000	0%
18,000 - 35,000	15%
35,000 - 50,000	25%
50,000 - 70,000	30%
70,000 - 100,000	35%
100,000 and above	40%

The Median Income is 25 of taxable income.

**1 Coding activity**

Find the amount of tax paid, not including the Medicare levy, for the following taxable incomes:

15,000    32,000    39,000    47,000    52,000

Calculate the total tax payable on the following taxable incomes, including the Medicare levy, which is 2% of your taxable income.

50,000    61,000

**2 Applying an algorithm**

Create the flowchart for the following program which asks to calculate the amount of tax payable for a given taxable income.

- Complete the flowchart by filling in the empty components.
- Explain what the formula  $T = P \times R$  means in the flowchart.
- Test the algorithm in the Exercise or write the taxable income scenarios from part 1 above.

**3 Using technology**

The following spreadsheet is an calculator which applies the algorithm outlined in the flowchart using named variables.

Variable	Value
Income	50000
Rate	0.35
Medicare Levy	0.02
Tax	17500
Total Tax	3500

**4 Estimation**

a) An online tax system requires you to fill in the following table. Find the value of  $x$  and  $y$ .

Income bracket	Tax rate
0 - 18,000	0%
18,000 - 35,000	15%
35,000 - 50,000	25%
50,000 - 70,000	30%
70,000 - 100,000	35%
100,000 and above	40%

The Medicare levy is 2% of taxable income.

b) The following table shows the tax payable for the tax system and sets a range of taxable incomes to compare it to using technology.

406 Chapter 12: Modelling

**Estimating park lake area**

A local shire wants to estimate the volume of water in its local lake. The lake's 'eye view' of the lake is shown here and each grid square represents 10 metres by 10 metres. The average depth of water in the lake is 3 metres.

**Preliminary task**

Estimate the area of the shaded region in the following grid. Each grid square represents an area of square metres.

**Modelling task**

A body of water has a surface area of 2000m<sup>2</sup>. The volume of water can be found using the formula: Volume = Surface Area × Depth.

If the average depth of the water is 3 metres, find:

- the volume of water in cubic metres
- the volume of water in litres. Use the fact that 1m<sup>3</sup> = 1000L.

**Modelling task**

The problem is to estimate the volume of water in the lake. Write down all the relevant information that will help solve the problem.

**Plan**

- Outline your method for estimating the surface area of the lake shown above.
- Estimate the volume of water in the lake. Give your answer in m<sup>3</sup> and in litres.
- Compare your results with others in your class and state the range of answers provided.

**Verify**

Review your method for estimating the surface area of the lake and refine your calculation.

**Communicate**

Explain how you improved your method to find the surface area of the lake. Summarize your results and describe any key findings. You should also describe any methods you could use to obtain a better estimate of the volume.

**Extension questions**

- Use the method to find a rough or satellite view of a lake in your local area. Then estimate its area.
- Compare how your estimates and methods would change if the lake's depth is no longer assumed to be a constant 3 metres.

- 20 **Chapter reviews:** with short-answer, multiple-choice and extended-response questions; questions that are extension are clearly signposted
- 21 **Solving unfamiliar problems poster:** at the back of the book, outlines a strategy for solving any unfamiliar problem

**INTERACTIVE TEXTBOOK FEATURES**

- 22 **NEW Targeted Skillsheets,** one for each lesson, focus on a small set of related Fluency-style skills for students who need extra support, with questions linked to worked examples
- 23 **Workspaces:** almost every textbook question – including all working-out – can be completed inside the Interactive Textbook by using either a stylus, a keyboard and symbol palette, or uploading an image of the work
- 24 **Self-assessment:** students can then self-assess their own work and send alerts to the teacher. See the Introduction on page xii for more information.
- 25 **Interactive working programs** can be clicked on so that only questions included in that working program are shown on the screen
- 26 **HOTmaths resources:** a huge catered library of widgets, HOTsheets and walkthroughs seamlessly blended with the digital textbook
- 27 A revised set of **differentiated auto-marked practice quizzes** per lesson with saved scores
- 28 **Scorcher:** the popular competitive game
- 29 **Worked example videos:** every worked example is linked to a high-quality video demonstration, supporting both in-class learning and the flipped classroom
- 30 **Desmos graphing calculator,** scientific calculator and geometry tool are always available to open within every lesson

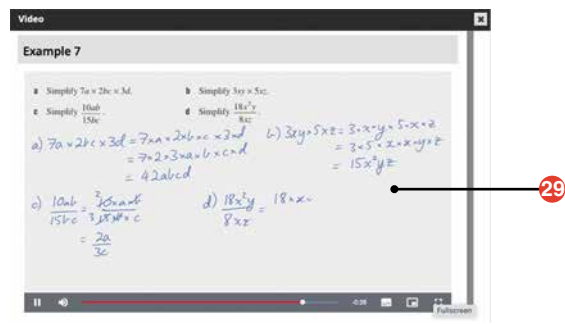
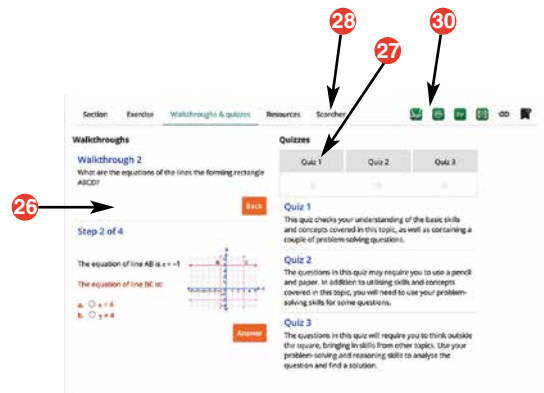



- 31 Desmos interactives:** a set of Desmos activities written by the authors allow students to explore a key mathematical concept by using the Desmos graphing calculator or geometry tool
- 32 Auto-marked prior knowledge pre-test** for testing the knowledge that students will need before starting the chapter
- 33 Auto-marked progress quizzes and chapter review multiple-choice questions** in the chapter reviews can now be completed online

## DOWNLOADABLE PDF TEXTBOOK

- 34** In addition to the Interactive Textbook, a **PDF version of the textbook** has been retained for times when users cannot go online. PDF search and commenting tools are enabled.

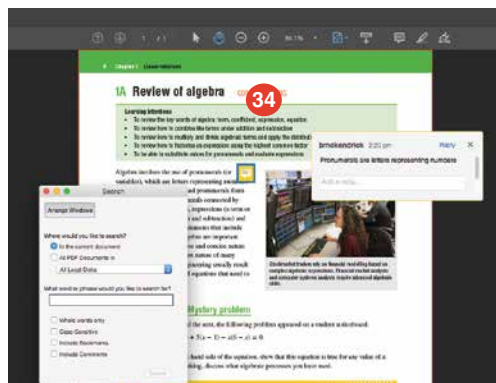

## ONLINE TEACHING SUITE

- 35 NEW Diagnostic Assessment Tool** included with the Online Teaching Suite allows for flexible diagnostic testing, reporting and recommendations for follow-up work to assist you to help your students to improve
- 36 NEW PowerPoint lesson** summaries contain the main elements of each lesson in a form that can be annotated and projected in front of class
- 37 Learning Management System** with class and student analytics, including reports and communication tools
- 38 Teacher view of student's work and self-assessment** allows the teacher to see their class's workout, how students in the class assessed their own work, and any 'red flags' that the class has submitted to the teacher
- 39 Powerful test generator** with a huge bank of levelled questions as well as ready-made tests
- 40 Revamped task manager** allows teachers to incorporate many of the activities and tools listed above into teacher-controlled learning pathways that can be built for individual students, groups of students and whole classes
- 41 Worksheets and four differentiated chapter tests in every chapter,** provided in editable Word documents
- 42 More printable resources:** all Pre-tests, Progress quizzes and Applications and problem-solving tasks are provided in printable worksheet versions

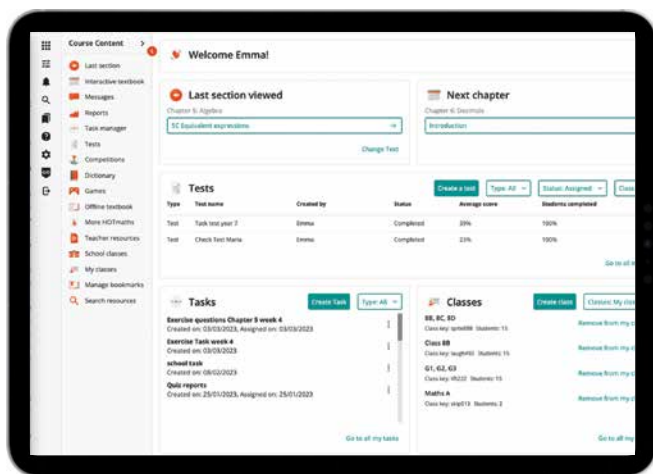

# Working with unfamiliar problems: Part 1

The questions on the next four pages are designed to provide practice in solving unfamiliar problems. Use the 'Working with unfamiliar problems' poster at the back of this book to help you if you get stuck.

In Part 1, apply the suggested strategy to solve these problems, which are in no particular order. Clearly communicate your solution and final answer.

- Find the sum of the first 100 counting numbers.
- If you start with 10 and then add half of it and then keep adding half of the previous number, what total do you achieve?
- Find the value of  $9 + 99 + 999 + 9999 + \dots + 999999999$
- In the Melbourne Cup there are 24 horses that enter the race. If you select 3 horses that you think will win, then a Box Trifecta allows your selections to finish first, second and third in any order. How many mystery Box Trifectas are possible in the Melbourne Cup?
- Arrange all the digits 1, 2, 3, 4 and 5 into the form  $\square\square\square \times \square\square$  so that the three digit number multiplied by the two digit number gives the smallest possible answer.
- Arrange the first 16 counting numbers in a four by four magic square with a magic number of 34. What do the four numbers in the middle of the magic square add to?
- A rectangle is divided into 3 rows of 8 small squares (so 24 identical squares in total). If the rectangle has perimeter 55 cm, find the perimeter and area of each small square.

For Questions 1 and 2, try starting with smaller numbers and look for a pattern. For Question 3, could you write the problem in a different way?



For Questions 4 and 5, try making a list or table.



For Questions 6 and 7, draw a labelled diagram to help you visualise the problem.



8 What is the best integer estimate for  $6756.893 \div \frac{4}{3}$ ?

For Question 8, try estimating by rounding the values in the question.



9 Estimate how many people in your school have used the canteen in the last week.

For Question 9, try working with a smaller sample first.



10 A square has a diagonal of 46 cm, what is the area of this square?

For Questions 10 and 11, try using a formula or rule to find a shortcut to the answer.



11 Find the size of the largest angle of a triangle if it is 10 degrees more than the second largest angle, which in turn is 10 degrees more than the smallest angle.

12 The sum of three consecutive even integers is 390. What is the product of the largest and smallest of the integers?

For Question 12, try using algebra as a tool: define the pronumerals, form an equation and then solve it.



13 What are the dimensions of the rectangle with the largest area if the perimeter is 96 cm?

For Questions 13 and 14, try using concrete, everyday materials to represent the problem.



14 Each student in a round robin table tennis competition must play every other student once. How many (singles) matches are played if there are 12 students in the competition?

15 Ken can wash a car in 10 minutes. Sean takes 15 minutes to wash the same size car. How long should it take them to wash 10 same size cars, if they work as a team of two, washing each car together?

For Question 15, try applying one or more mathematical procedures, such as a rule for adding fractions.



## Working with unfamiliar problems: Part 2

For the questions in Part 2, again use the ‘Working with unfamiliar problems’ poster at the back of this book, but this time choose your own strategy (or strategies) to solve each problem. Clearly communicate your solution and final answer.

- The number of bacteria in a petri dish double every 30 seconds. If 5 bacteria are present at 1 p.m., how many will be present after 10 minutes?
- If each letter represents a different digit (0 – 9), find the value of each letter so that the statement  $\text{FOUR} + \text{FIVE} = \text{NINE}$  is true.
- A red and a blue four-sided die are each numbered  $-4, -2, 0, 3$ . If these dice are rolled and the uppermost results are multiplied together, what is the probability that the result is positive?
- A four-digit number has the following properties: the second and fourth digits form a number that is a multiple of 11; the first two digits form a number divisible by 3 and less than 40; the first and third digits form the square of a whole number. Find all such four-digit numbers that are divisible by:
  - 4
  - 5
  - 6
  - 9
- In a school science competition, there were 20 boys and 30 girls who entered. Prizes were awarded to 40% of the boys and 30% of the girls. Find the total percentage of entrants who received a prize.
- Jake built a solid cube of side 9 cm with plastic  $1\text{ cm}^3$  linking blocks. Riley pulled Jake’s cube apart and built a larger cube that looked solid from the outside but was hollow on the inside. What is the side length of the largest cube that Riley could build? How many  $1\text{ cm}^3$  blocks are left over?
- In a list of five consecutive odd integers, the middle integer is shown by the expression  $2a - 3$ . Find two simplified equivalent expressions for the sum of these five integers.
- A right-angled triangle has a semicircle drawn onto each side so each side is a diameter. The largest semicircle has an arc length of  $26.5\pi\text{ cm}$  and another semicircle has an area of  $98\pi\text{ cm}^2$ . Find the radius of the third semicircle.

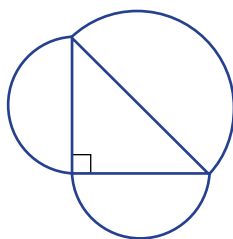

- 9 a Insert brackets into  $1 + 3 + 5 + 7 + 9 + 11 + 13 + 15 + 17 + 19$  to show how the sum of the first ten consecutive odd numbers is equal to the sum of the first four perfect cubes.
- b Show how perfect squares can be formed by the addition of consecutive odd numbers.
- c How many consecutive odd numbers add to give the sum of the first seven perfect cubes?
- d What number when squared equals the sum of the first:
- 7 perfect cubes?
  - 50 perfect cubes?
- 10 Four students stand alongside each other and start counting, each person giving the next number. This is how they start:

Amelia	Beau	Claire	Dominic
1	→ 2	→ 3	→ 4
7	← 6	← 5	← 4
	→ 8	→ 9	→ 10
13	← 12	← 11	← 10

- a List out the next 6 numbers that Claire will say.
- b List out the next 6 numbers that Amelia will say.

Complete parts **c–e** without listing out all the numbers.

- c Who will say the number 256?
- d Who will say the number 3002?
- e Dominic says the number 1234. How many numbers has Dominic said before he says 1234?

# 1

## Computations with integers

### Maths in context: The story of zero

Modern maths uses zero both as a placeholder (e.g. compare the 3 in 30 and 3000) and as a value (e.g.  $0 - 6 = -6$ ). The Egyptians, Greeks and Romans didn't use a zero. The Babylonians, Chinese, Indians and Mayans independently developed positional number systems with a zero symbol.

The Indian Bakhshali manuscript, 224 CE, has the first known use of zero as a placeholder with value. The Hindu Brahmagupta, 628 CE, first recorded the rules for positive and negative integers and used zero as an actual number. Brahmagupta's many insights were a key foundation for our modern mathematical development. His Indian manuscripts were translated into Arabic, and algebra advanced further.

Europeans continued with Roman numerals beyond 1000 CE. From the early 1200s, an Italian mathematician named Fibonacci, who was based in Pisa (pictured), helped establish Hindu-Arabic numerals throughout Europe. As a boy, Fibonacci studied the Hindu-Arabic number system in North Africa where his father was a customs officer. In 1202 CE, Fibonacci's 'Book of Calculation' explained to Europe's merchants, bankers, and accountants the power and simplicity of using nine digits and zero. By the 1600s, the Hindu-Arabic decimal system was well known and is now used worldwide.



## Chapter contents

- 1A Adding and subtracting positive integers  
(CONSOLIDATING)
- 1B Multiplying and dividing positive integers  
(CONSOLIDATING)
- 1C Number properties (CONSOLIDATING)
- 1D Divisibility and prime factorisation  
(CONSOLIDATING)
- 1E Negative integers (CONSOLIDATING)
- 1F Adding and subtracting negative integers  
(CONSOLIDATING)
- 1G Multiplying and dividing negative integers
- 1H Order of operations and substitution

## Victorian Curriculum 2.0

This chapter covers the following content descriptors in the Victorian Curriculum 2.0:

### NUMBER

VC2M8N04, VC2M8N06

### ALGEBRA

VC2M8A04

Please refer to the curriculum support documentation in the teacher resources for a full and comprehensive mapping of this chapter to the related curriculum content descriptors.

© VCAA

## Online resources

A host of additional online resources are included as part of your Interactive Textbook, including HOTmaths content, video demonstrations of all worked examples, auto-marked quizzes and much more.

# 1A Adding and subtracting positive integers CONSOLIDATING

## LEARNING INTENTIONS

- To understand the commutative and associative laws for addition
- To be able to use the mental strategies partitioning, compensating and doubling/halving to calculate a sum or difference of whole numbers mentally
- To be able to use the addition and subtraction algorithms to find the sum and difference of whole numbers

The number system that we use today is called the Hindu-Arabic or decimal system and uses the digits 0, 1, 2, 3, 4, 5, 6, 7, 8 and 9. The value of each digit depends on its place in the number, so, for example, the 4 in 3407 has a place value of 400. Whole numbers include 0 (zero) and the counting (natural) numbers 1, 2, 3, 4, ... Two numbers can be added to find a sum or subtracted to find a difference. If, for example, 22 child tickets and 13 adult tickets were purchased for fairground rides, the sum of the number of tickets (35) is found using addition, and the difference between the number of child and adult tickets (9) is found using subtraction.



An audiologist often uses basic number skills when testing patients' hearing levels. Addition and subtraction find hearing differences between the ears, and division and multiplication calculate percentages from speech recognition results.

## Lesson starter: Sum and difference

Use a guess-and-check method to try to find a pair of numbers described by these sentences.

- The sum of two numbers is 88 and their difference is 14.
- The sum of two numbers is 317 and their difference is 3.

Describe the meaning of the words 'sum' and 'difference' and discuss how you found the pair of numbers in each case.



## KEY IDEAS

- Two numbers can be added in any order. This is called the **commutative law** for addition. The commutative law does not hold for subtraction.

$$a + b = b + a$$

$$\text{For example: } 7 + 11 = 11 + 7$$

$$a - b \neq b - a \text{ (in general)}$$

$$\text{For example: } 5 - 2 \neq 2 - 5$$

- Three or more numbers can be added in any order. This uses the **associative law** for addition. The associative law does not hold for subtraction.

$$(a + b) + c = a + (b + c)$$

$$\text{For example: } (2 + 5) + 4 = 2 + (5 + 4)$$

$$a - (b - c) \neq (a - b) - c \text{ (in general)}$$

$$\text{For example: } 9 - (5 - 2) \neq (9 - 5) - 2$$

- Addition and subtraction **algorithms** can be used for larger numbers.

For example:

$$\begin{array}{r} 14 \text{ } 3 \text{ } 9 \\ + 1 \text{ } 8 \text{ } 2 \\ \hline 6 \text{ } 2 \text{ } 1 \end{array}$$

$$\begin{array}{r} 23 \text{ } 1 \text{ } 4 \\ - 1 \text{ } 4 \text{ } 2 \\ \hline 1 \text{ } 7 \text{ } 2 \end{array}$$

- Strategies for mental arithmetic include:

- Partitioning** For example:  $247 + 121 = (200 + 100) + (40 + 20) + (7 + 1) = 368$   
 $85 - 22 = (80 - 20) + (5 - 2) = 63$
  - Compensating** For example:  $134 + 29 = 134 + 30 - 1 = 163$   
 $322 - 40 = 320 - 40 + 2 = 282$
  - Doubling or halving** For example:  $35 + 37 = 2 \times 35 + 2 = 72$   
 $240 - 123 = 240 \div 2 - 3 = 117$

- Estimates for sums and differences can be made by first rounding each number to the nearest 10, 100, 1000 etc.

For example: Rounding to the nearest 10

$$348 - 121 \approx 350 - 120 \\ = 230$$

Rounding to the nearest dollar

$$\$1.95 + \$3.10 \approx \$2 + \$3 \\ = \$5$$

## BUILDING UNDERSTANDING

- 1 Give the number that is:

a 26 plus 17

b 43 take away 9

c 134 minus 23

d 451 add 50

e the sum of 111 and 236

f the difference between 59 and 43

g 36 more than 8

h 120 less than 251

- 2 State the digit missing from these sums and differences.

$$\begin{array}{r} a \quad 4 \quad 9 \\ + 3 \quad 8 \\ \hline 8 \quad \square \end{array}$$

$$\begin{array}{r} b \quad 1 \quad \square \quad 4 \\ + 3 \quad 9 \quad 2 \\ \hline 5 \quad 5 \quad 6 \end{array}$$

$$\begin{array}{r} c \quad 3 \quad 8 \\ - 1 \quad 9 \\ \hline 1 \quad \square \end{array}$$

$$\begin{array}{r} d \quad 2 \quad 5 \quad 1 \\ - 1 \quad \square \quad 4 \\ \hline 8 \quad 7 \end{array}$$

**Example 1 Using mental arithmetic**

Evaluate this difference and sum mentally.

**a**  $347 - 39$

**b**  $125 + 127$

**SOLUTION**

**a**  $347 - 39 = 308$

**b**  $125 + 127 = 252$

**EXPLANATION**

$347 - 39 = 347 - 40 + 1 = 307 + 1 = 308$

$125 + 127 = 2 \times 125 + 2 = 250 + 2 = 252$

**Now you try**

Evaluate this difference and sum mentally.

**a**  $273 - 59$

**b**  $235 + 238$

**Example 2 Using addition and subtraction algorithms**

Use an algorithm to find this sum and difference.

**a** 
$$\begin{array}{r} 938 \\ + 217 \\ \hline \end{array}$$

**b** 
$$\begin{array}{r} 141 \\ - 86 \\ \hline \end{array}$$

**SOLUTION**

**a** 
$$\begin{array}{r} 9\overset{1}{3}8 \\ + 217 \\ \hline 1155 \end{array}$$

**b** 
$$\begin{array}{r} 1\overset{3}{4}1 \\ - 86 \\ \hline 55 \end{array}$$

**EXPLANATION** $8 + 7 = 15$  (carry the 1 to the tens column)

$1 + 3 + 1 = 5$

$9 + 2 = 11$

Borrow from the tens column then subtract 6 from 11. Then borrow from the hundreds column and then subtract 8 from 13.

**Now you try**

Use an algorithm to find this sum and difference.

**a**  $518 + 395$

**b**  $273 - 97$

## Exercise 1A

### FLUENCY

1, 2-5( $\frac{1}{2}$ )2-5( $\frac{1}{2}$ )2-5( $\frac{1}{3}$ )

1 Evaluate these differences and sums mentally.

Example 1a

a i  $168 - 43$

ii  $782 - 49$

Example 1b

b i  $120 + 119$

ii  $325 + 328$

Example 1

2 Evaluate these sums and differences mentally.

a  $94 - 62$

b  $146 + 241$

c  $1494 - 351$

d  $36 + 19$

e  $138 + 25$

f  $251 - 35$

g  $99 - 20$

h  $441 - 50$

i  $350 + 351$

j  $115 + 114$

k  $80 - 41$

l  $320 - 159$

Example 2

3 Use an algorithm to find these sums and differences.

a 
$$\begin{array}{r} 128 \\ + 46 \\ \hline \end{array}$$

b 
$$\begin{array}{r} 94 \\ + 337 \\ \hline \end{array}$$

c 
$$\begin{array}{r} 9014 \\ 927 \\ + 421 \\ \hline \end{array}$$

d 
$$\begin{array}{r} 814 \\ 1439 \\ + 326 \\ \hline \end{array}$$

e 
$$\begin{array}{r} 94 \\ - 36 \\ \hline \end{array}$$

f 
$$\begin{array}{r} 421 \\ - 204 \\ \hline \end{array}$$

g 
$$\begin{array}{r} 1726 \\ - 1699 \\ \hline \end{array}$$

h 
$$\begin{array}{r} 14072 \\ - 328 \\ \hline \end{array}$$

i 
$$\begin{array}{r} 428 \\ 324 \\ 107 \\ + 29 \\ \hline \end{array}$$

j 
$$\begin{array}{r} 1004 \\ 2407 \\ 9116 \\ + 10494 \\ \hline \end{array}$$

k 
$$\begin{array}{r} 3017 \\ - 2942 \\ \hline \end{array}$$

l 
$$\begin{array}{r} 10024 \\ - 936 \\ \hline \end{array}$$

4 Estimate these sums and differences by first rounding each given amount to the nearest dollar (e.g.  $\$3.95 + \$5.02$  rounds to  $\$4 + \$5$ , so an estimate of  $\$9$  is reasonable).

a  $\$1.95 + \$3.02$

b  $\$3.05 + \$4.99$

c  $\$10.19 + \$0.95$

d  $\$8.99 - \$3.03$

e  $\$20.95 - \$2.10$

f  $\$8.69 - \$5.79$

5 By first rounding each given number as instructed, estimate the answer.

a  $79 + 32$  (nearest 10)

b  $38 - 17$  (nearest 10)

c  $916 + 1401$  (nearest 100)

d  $2993 - 1210$  (nearest 100)

e  $3.01 - 0.95$  (nearest 1)

f  $39271 + 3648$  (nearest 1000)

### PROBLEM-SOLVING

6, 7, 8( $\frac{1}{2}$ )

7-9

8-10

6 A racing bike's odometer shows 21 432 km at the start of a race and 22 110 km at the end of the race. What was the total distance of the race?

7 The sum of two numbers is 39 and their difference is 5. What is the larger number?



8 Find the missing digits in these sums and differences.

$$\begin{array}{r} \text{a} \quad 2 \quad 3 \quad \square \\ + \square \quad 9 \quad 4 \\ \hline 6 \quad \square \quad 1 \end{array}$$

$$\begin{array}{r} \text{b} \quad \square \quad 3 \quad \square \\ + \quad \square \quad 2 \\ \hline 2 \quad 1 \quad 9 \end{array}$$

$$\begin{array}{r} \text{c} \quad \square \quad 3 \quad 7 \\ + 4 \quad 9 \quad \square \\ \hline 7 \quad \square \quad 2 \end{array}$$

$$\begin{array}{r} \text{d} \quad \square \quad 3 \\ - 2 \quad 9 \\ \hline 2 \quad \square \end{array}$$

$$\begin{array}{r} \text{e} \quad 3 \quad \square \quad 2 \\ - \square \quad 3 \quad \square \\ \hline 1 \quad 0 \quad 4 \end{array}$$

$$\begin{array}{r} \text{f} \quad 2 \quad \square \quad \square \quad 5 \\ - \quad 6 \quad 8 \quad \square \\ \hline \square \quad 3 \quad 1 \quad 8 \end{array}$$

9 Wally has two more marbles than Ashan and together they have 88 marbles. How many marbles does Ashan have?

10 Evaluate the following without the use of a calculator.

a  $1 + 2 + 3 + 4 + \dots + 99 + 100 - 99 - 98 - \dots - 2 - 1$

b  $1 - 2 + 3 - 4 + 5 - 6 + \dots - 98 + 99$

### REASONING

11

11, 12

11–13

11 Explain why these number puzzles cannot be solved. (*Hint*: Try to solve them and see what goes wrong.)

$$\begin{array}{r} \text{a} \quad \square \quad 2 \quad \square \\ + 3 \quad \square \quad 6 \\ \hline 2 \quad 3 \quad 4 \quad 9 \end{array}$$

$$\begin{array}{r} \text{b} \quad 3 \quad \square \quad 6 \\ - 3 \quad 2 \quad \square \\ \hline 8 \quad 2 \end{array}$$

12 The variables  $x$ ,  $y$  and  $z$  represent any numbers. Complete these statements so these equations are always true.

a  $x + y + z = \underline{\quad} + x + y$

b  $x - y + z = z - \underline{\quad} + \underline{\quad} = x + \underline{\quad} - \underline{\quad}$

13 How many different combinations of digits make the following true? List the combinations and explain your reasoning.

$$\begin{array}{r} \text{a} \quad 1 \quad \square \quad 4 \\ + 2 \quad \square \quad \square \\ \hline 4 \quad 2 \quad 7 \end{array}$$

$$\begin{array}{r} \text{b} \quad 3 \quad \square \quad \square \\ - 1 \quad \square \quad 4 \\ \hline 1 \quad 4 \quad 3 \end{array}$$

### ENRICHMENT: Magic triangles

–

–

14

14 The sides of a magic triangle all sum to the same total.

a Show how it is possible to arrange all the digits from 1 to 9 so that each side adds to 17.

b Show how it is possible to arrange the same digits to a different total. How many different totals can you find?

c In how many different ways can you obtain each total? Switching the two middle numbers on each side does not count as a new combination.

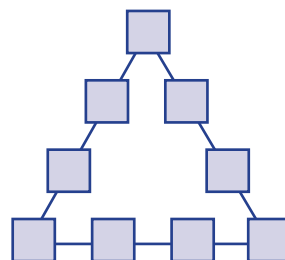

# 1B Multiplying and dividing positive integers CONSOLIDATING

## LEARNING INTENTIONS

- To understand the commutative and associative laws for multiplication
- To know the meaning of the terms product, quotient and remainder
- To be able to use mental strategies to calculate simple products and quotients mentally
- To be able to use the multiplication and division algorithms to find the product and quotient of whole numbers

It is useful to know how to multiply and divide numbers without the use of technology. Mental strategies can be used in some problems, and algorithms can be used for more difficult cases. Calculating the cost of 9 tickets at \$51 each, for example, can be done mentally, but an algorithm might be useful when calculating the cost of 238 tickets at \$51 each.

Before an algorithm is applied, it can be useful to estimate the result. For example,  $238 \times 51$  is approximately  $240 \times 50$ , which is  $120 \times 100 = 12000$  (using the doubling and halving strategy). So the value of  $238 \times 51$  is approximately \$12000.



Paramedics in helicopters and ambulances need number skills, such as for intravenous saline drips. A patient of estimated weight 70 kg requiring a dose of 15 mL/kg receives  $15 \times 70 = 1050$  mL. Infused over 5 hours, the drip rate is  $\frac{1050}{5} = 210$  mL/h.

## Lesson starter: Multiplication or division?

In solving many problems it is important to know whether multiplication or division should be used. Decide if the following situations require the use of multiplication or division. Discuss them in a group or with a partner.

- The number of cookies 4 people get if a packet of 32 cookies is shared equally between them
- The cost of paving 30 square metres of courtyard at a cost of \$41 per square metre
- The number of sheets of paper in a shipment of 4000 boxes of 5 reams each (1 ream is 500 sheets)
- The number of hours I can afford a plumber at \$75 per hour if I have a fixed budget of \$1650

Make up your own situation that requires the use of multiplication and another situation for division.

## KEY IDEAS

■ Finding a **product** is the result of using multiplication. We say the product of 11 and 9 is 99.

■ The **multiplication algorithm** can be used when products cannot be found mentally. For example:

$$\begin{array}{r}
 217 \\
 \times 26 \\
 \hline
 1302 \\
 4340 \\
 \hline
 5642
 \end{array}
 \begin{array}{l}
 \\
 \leftarrow 217 \times 6 \\
 \leftarrow 217 \times 20 \\
 \leftarrow 1302 + 4340
 \end{array}$$

- Using division results in finding a **quotient** and a **remainder**.

For example:  $38 \div 11 = 3$  and 5 remainder



- The short division algorithm can be used when quotients cannot be found mentally.

$$\begin{array}{r} 7 \ 3 \ 2 \\ 7 \overline{) 5 \ 1 \ 2 \ 1 \ 4} \end{array}$$

- The **commutative law** holds for multiplication but not division.

For example:  $7 \times 5 = 5 \times 7$  but  $21 \div 3 \neq 3 \div 21$

- The **associative law** holds for multiplication but not division.

For example:  $(5 \times 4) \times 2 = 5 \times (4 \times 2)$  but  $(5 \div 4) \div 2 \neq 5 \div (4 \div 2)$

- Mental strategies for multiplication

- Using the commutative and associative laws

For example:  $5 \times 17 \times 4 = 5 \times 4 \times 17 = 20 \times 17 = 340$

- Using the **distributive law**

For example:  $4 \times 87 = (4 \times 80) + (4 \times 7) = 320 + 28 = 348$

or  $4 \times 87 = (4 \times 90) - (4 \times 3) = 360 - 12 = 348$

- Doubling and halving

For example:  $4 \times 74 = 2 \times 148 = 296$

- Mental strategies for division

- Halving both numbers

For example:  $132 \div 4 = 66 \div 2 = 33$

- Using the distributive law

Forexample:  $96 \div 3 = (90 \div 3) + (6 \div 3) = 30 + 2 = 32$

or  $147 \div 3 = (150 \div 3) - (3 \div 3) = 50 - 1 = 49$

## BUILDING UNDERSTANDING

- Find the results for the following.

a The product of 7 and 8

b The remainder when 2 is divided into 19

c The quotient of 13 divided by 4

- Use your knowledge of the multiplication table to state the answers to the following.

a  $11 \times 9$

b  $6 \times 7$

c  $9 \times 8$

d  $12 \times 11$

e  $8 \times 4$

f  $7 \times 9$

g  $88 \div 8$

h  $121 \div 11$

i  $144 \div 12$

j  $56 \div 7$

k  $33 \div 3$

l  $78 \div 6$

- Decide if these simple equations are true or false.

a  $4 \times 13 = 13 \times 4$

b  $2 \times 7 \times 9 = 7 \times 9 \times 2$

c  $6 \div 3 = 3 \div 6$

d  $60 \div 20 = 30 \div 10$

e  $14 \div 2 \div 7 = 7 \div 2 \div 14$

f  $51 \times 7 = (50 \times 7) + (1 \times 7)$

g  $79 \times 13 = (80 \times 13) - (1 \times 13)$

h  $93 \div 3 = (90 \div 3) + (3 \div 3)$

i  $133 \div 7 = (140 \div 7) - (7 \div 7)$

j  $33 \times 4 = 66 \times 8$

**Example 3 Using mental strategies**

Use a mental strategy to evaluate the following.

**a**  $5 \times 160$

**b**  $7 \times 89$

**c**  $464 \div 8$

**SOLUTION**

**a**  $5 \times 160 = 800$

**b**  $7 \times 89 = 623$

**c**  $464 \div 8 = 58$

**EXPLANATION**Double one and halve the other so  $5 \times 160$  becomes  $10 \times 80$ Use the distributive law so  $7 \times 89$  becomes  $(7 \times 90) - (7 \times 1) = 630 - 7$ Halve both numbers repeatedly so  $464 \div 8$  becomes  $232 \div 4 = 116 \div 2$ **Now you try**

Use a mental strategy to evaluate the following.

**a**  $5 \times 240$

**b**  $8 \times 91$

**c**  $832 \div 4$

**Example 4 Using multiplication and division algorithms**

Use an algorithm to evaluate the following.

**a** 
$$\begin{array}{r} 412 \\ \times 25 \\ \hline \end{array}$$

**b**  $938 \div 6$

**SOLUTION**

**a** 
$$\begin{array}{r} 412 \\ \times 25 \\ \hline 2060 \\ 8240 \\ \hline 10300 \end{array}$$

**b** 
$$\begin{array}{r} 156 \text{ rem } 2 \\ 6 \overline{)938} \\ \underline{6} \phantom{3} \phantom{8} \\ 33 \phantom{8} \\ \underline{30} \phantom{8} \\ 38 \\ \underline{36} \\ 2 \end{array}$$

So  $938 \div 6 = 156$  and 2 remainder.**EXPLANATION**

$412 \times 5 = 2060$  and  $412 \times 20 = 8240$

Add these two products to get the final answer.

$9 \div 6 = 1$  and 3 remainder

$33 \div 6 = 5$  and 3 remainder

$38 \div 6 = 6$  and 2 remainder

**Now you try**

Use an algorithm to evaluate the following.

**a**  $415 \times 32$

**b**  $951 \div 8$

## Exercise 1B

### FLUENCY

1, 2–5( $\frac{1}{2}$ )1–5( $\frac{1}{2}$ ), 7( $\frac{1}{2}$ )4–7( $\frac{1}{2}$ )

- Example 3a** 1 Use a mental strategy to evaluate the following products.
- a  $5 \times 120$                       b  $4 \times 45$                       c  $80 \times 5$                       d  $50 \times 14$
- Example 3b** 2 Use a mental strategy to evaluate the following products.
- a  $3 \times 51$                       b  $7 \times 21$                       c  $6 \times 19$                       d  $4 \times 29$
- Example 3c** 3 Use a mental strategy to evaluate the following quotients.
- a  $140 \div 4$                       b  $160 \div 8$                       c  $486 \div 2$                       d  $639 \div 3$
- Example 4a** 4 Use the multiplication algorithm to evaluate the following.
- a 
$$\begin{array}{r} 67 \\ \times 9 \\ \hline \end{array}$$
                      b 
$$\begin{array}{r} 129 \\ \times 4 \\ \hline \end{array}$$
                      c 
$$\begin{array}{r} 294 \\ \times 13 \\ \hline \end{array}$$
                      d 
$$\begin{array}{r} 1004 \\ \times 90 \\ \hline \end{array}$$
- e 
$$\begin{array}{r} 690 \\ \times 14 \\ \hline \end{array}$$
                      f 
$$\begin{array}{r} 4090 \\ \times 101 \\ \hline \end{array}$$
                      g 
$$\begin{array}{r} 246 \\ \times 139 \\ \hline \end{array}$$
                      h 
$$\begin{array}{r} 1647 \\ \times 209 \\ \hline \end{array}$$
- Example 4b** 5 Use the short division algorithm to evaluate the following.
- a  $3 \overline{)85}$                       b  $7 \overline{)214}$                       c  $10 \overline{)4167}$                       d  $11 \overline{)143}$
- e  $15 \overline{)207}$                       f  $19 \overline{)3162}$                       g  $28 \overline{)196}$                       h  $31 \overline{)32690}$
- 6 Use a mental strategy to evaluate the following.
- a  $5 \times 13 \times 2$                       b  $2 \times 26 \times 5$                       c  $4 \times 35$                       d  $17 \times 4$
- e  $17 \times 1000$                       f  $136 \times 100$                       g  $59 \times 7$                       h  $119 \times 6$
- i  $9 \times 51$                       j  $6 \times 61$                       k  $4 \times 252$                       l  $998 \times 6$
- m  $128 \div 8$                       n  $252 \div 4$                       o  $123 \div 3$                       p  $508 \div 4$
- q  $96 \div 6$                       r  $1016 \div 8$                       s  $5 \times 12 \times 7$                       t  $570 \div 5 \div 3$
- 7 Estimate answers to the following by first rounding each dollar/cent amount to the nearest dollar. For example, 3 packets at  $\$1.95 \approx 3 \times \$2 = \$6$ .
- a 5 packets at  $\$2.95$  each                      b 7 packets at  $\$9.99$  each
- c 20 boxes at  $\$19.80$  each                      d  $\$29.90$  divided into 6 parts
- e  $\$120.35$  divided into 5 parts                      f  $\$999.80$  divided into 20 parts

### PROBLEM-SOLVING

8–10

9–11

11, 12

- 8 A university student earns  $\$550$  for 22 hours work. What is the student's pay rate per hour?
- 9 Packets of biscuits are purchased by a supermarket in boxes of 18. The supermarket orders 220 boxes and sells 89 boxes in one day. How many packets of biscuits remain in the supermarket?





10 Riley buys a fridge, which he can pay for using the following options.

- A 9 payments of \$183
- B \$1559 up-front

Which option is cheaper and by how much?



11 The shovel of a giant mechanical excavator can move 13 tonnes of rock in each load. How many loads are needed to shift 750 tonnes of rock?

12 Find the missing digits in these problems.

a

$$\begin{array}{r} 2 \square \\ \times 21 \\ \hline 23 \\ 4 \square 0 \\ \hline 48 \square \end{array}$$

b

$$\begin{array}{r} 1 \square 7 \\ \times 2 \square \\ \hline \square 4 8 \\ 2 \square 4 0 \\ \hline \square \square 8 8 \end{array}$$

c

$$\begin{array}{r} 94 \\ 7 \overline{) 6 \square 4} \end{array} \text{ with 6 remainder}$$

d

$$\begin{array}{r} 19 \\ 17 \overline{) \square \square 6} \end{array} \text{ with 3 remainder}$$

**REASONING** 13 13, 14 14(1/2), 15

13 If  $a$  represents any number except 0, simplify the following.

- a  $a \div a$
- b  $a \div 1$
- c  $0 \div a$
- d  $25 \times a \div a$

14 A mental strategy for division involves separately dividing a pair of factors of the divisor. For example:

$$\begin{aligned} 114 \div 6 &= (114 \div 2) \div 3 \text{ (Note: 2 and 3 are factors of 6.)} \\ &= 57 \div 3 \\ &= 19 \end{aligned}$$

Use this technique to evaluate the following.

- a  $204 \div 6$
- b  $144 \div 8$
- c  $261 \div 9$
- d  $306 \div 18$

15 Evaluate the following without using an algorithm.

- a  $(99 \times 17) + (1 \times 17)$
- b  $(82 \times 7) - (2 \times 7)$
- c  $(493 \times 12) + (507 \times 12)$
- d  $(326 \times 15) - (306 \times 15)$

**ENRICHMENT: Maximum ticket numbers** - - 16

- 16 a Gen spends exactly \$80 to buy child tickets at \$7 each and adult tickets at \$12 each. Find the maximum number of tickets that could be purchased.
- b Alfred spends exactly \$141 to buy child tickets at \$9 each and adult tickets at \$15 each. Find the maximum number of tickets that could be purchased.
- c Explain your method for solving the above two questions. Make up your own similar question and test it on a friend.

## 1C Number properties CONSOLIDATING

### LEARNING INTENTIONS

- To understand that a prime number has exactly two factors and a composite number has more than two factors
- To know the meaning of the terms square, square root, cube and cube root
- To be able to find the lowest common multiple and highest common factor of two numbers
- To be able to find the square, square root, cube and cube root of certain small whole numbers

The properties of numbers are at the foundation of mathematical problem-solving. A group of 63 students, for example, can be divided into 7 equal groups of 9, but a group of 61 cannot be divided into smaller equal groups greater than 1. This is because 61 is a prime number with no other factors apart from 1 and itself; 63 is a multiple of 9, and the numbers 9 and 7 are factors of 63.



Electronic engineers routinely use number skills, including squares and square roots; for example, when designing audio amplifiers that multiply the volume of an input musical signal, making the output signal strong enough to drive loudspeakers.

### Lesson starter: How many in 60 seconds?

In 60 seconds, write down as many numbers as you can that fit each description.

- Multiples of 7
- Factors of 144
- Prime numbers

Compare your lists with the results of the class. For each part, decide if there are any numbers less than 100 that you missed.

## KEY IDEAS

- A **multiple** of a number is obtained by multiplying the number by a **positive integer** 1, 2, 3, ...  
For example: Multiples of 9 include 9, 18, 27, 36, 45, ...
- The **lowest common multiple** (LCM) is the smallest multiple of two or more numbers that is common.  
For example: Multiples of 4 are 4, 8, 12, 16, 20, 24, ...  
Multiples of 6 are 6, 12, 18, 24, 30, ...  
The LCM of 4 and 6 is therefore 12.
- A **factor** of a number has a remainder of zero when divided into the given number.  
For example: 11 is a factor of 77 since  $77 \div 11 = 7$  with 0 remainder.
- The **highest common factor** (HCF) is the largest factor of two or more numbers that is common.  
For example: Factors of 24 are 1, 2, 3, 4, 6, 8, 12, 24.  
Factors of 36 are 1, 2, 3, 4, 6, 9, 12, 18, 36.  
The HCF of 24 and 36 is therefore 12.
- **Prime numbers** have only two factors, the number itself and 1.
  - 2, 13 and 61 are examples of prime numbers.
  - 1 is not considered to be a prime number.
- **Composite numbers** have more than two factors.
  - 6, 20 and 57 are examples of composite numbers.
- The **square** of a number  $x$  is  $x^2 = x \times x$ .
  - We say  $x^2$  as 'x squared' or 'the square of  $x$ ' or 'x to the power 2'.
  - $3^2 = 9$  and  $11^2 = 121$  ( $3^2 = 3 \times 3$  and  $11^2 = 11 \times 11$ ).
  - If  $x$  is a whole number then  $x^2$  is called a perfect square. 9 and 121 are examples of perfect squares.
- The **square root** of a number is written with the symbol  $\sqrt{\quad}$ .
  - $\sqrt{b} = a$  if  $a^2 = b$  (and  $a$  is positive or zero); for example,  $\sqrt{9} = 3$  since  $3^2 = 9$ .  
(Note:  $\sqrt{16}$  is a positive number only and is equal to 4, not  $\pm 4$ .)
- The **cube** of a number  $x$  is  $x^3 = x \times x \times x$ .
  - We say  $x^3$  as 'x cubed' or 'the cube of  $x$ ' or 'x to the power 3'.
  - $2^3 = 2 \times 2 \times 2 = 8$  and  $5^3 = 5 \times 5 \times 5 = 125$ .
- The **cube root** of a number is written with the symbol  $\sqrt[3]{\quad}$ .
  - $\sqrt[3]{b} = a$  if  $a^3 = b$ , for example,  $\sqrt[3]{8} = 2$  since  $2^3 = 8$ .

## BUILDING UNDERSTANDING

- 1** State the number in each list that is not a multiple of the first number listed.
- a** 3, 6, 9, 12, 14, 18, 21      **b** 11, 22, 33, 45, 55, 66  
**c** 21, 43, 63, 84, 105      **d** 13, 26, 40, 52, 65
- 2** State the missing factor from each list.
- a** Factors of 18: 1, 2, 3, 9, 18      **b** Factors of 24: 1, 2, 4, 6, 8, 12, 24
- 3** Classify these numbers as prime or composite.
- a** 7      **b** 12      **c** 29      **d** 69  
**e** 105      **f** 117      **g** 221      **h** 1046734
- 4** Classify the following as true or false.
- a** 15 is a multiple of 5      **b** 7 is a factor of 30  
**c**  $6^2 = 6 \times 6 \times 6$       **d**  $\sqrt{64} = 8$   
**e**  $3^3 = 3 \times 3 \times 3$       **f**  $\sqrt[3]{4} = 2$   
**g** 41 is prime      **h** 29 is a composite number



## Example 5 Finding the LCM and HCF

**a** Find the LCM of 6 and 8.

**b** Find the HCF of 36 and 48.

## SOLUTION

**a** Multiples of 6 are:  
6, 12, 18, 24, 30, ...  
Multiples of 8 are:  
8, 16, 24, 32, 40, ...  
The LCM is 24.

**b** Factors of 36 are:  
1, 2, 3, 4, 6, 9, 12, 18, 36  
Factors of 48 are:  
1, 2, 3, 4, 6, 8, 12, 16, 24, 48  
The HCF is 12.

## EXPLANATION

First, list some multiples of 6 and 8.  
Continue the lists until there is at least one in common.

Choose the smallest number that is common to both lists.

First, list factors of 36 and 48.

Choose the largest number that is common to both lists.

## Now you try

**a** Find the LCM of 8 and 10.

**b** Find the HCF of 42 and 28.



### Example 6 Finding squares, cubes, square roots and cube roots

Evaluate the following.

**a**  $6^2$

**b**  $\sqrt{81}$

**c**  $2^3$

**d**  $\sqrt[3]{64}$

#### SOLUTION

**a**  $6^2 = 6 \times 6$   
 $= 36$

**b**  $\sqrt{81} = 9$

**c**  $2^3 = 2 \times 2 \times 2$   
 $= 8$

**d**  $\sqrt[3]{64} = 4$

#### EXPLANATION

Find the product of 6 with itself.

$9^2 = 9 \times 9 = 81$  so  $\sqrt{81} = 9$

(Note:  $\sqrt{x}$  cannot be negative, so  $\sqrt{81} \neq -9$ .)

In general,  $x^3 = x \times x \times x$ .

$4^3 = 4 \times 4 \times 4 = 64$  so  $\sqrt[3]{64} = 4$

#### Now you try

Evaluate the following.

**a**  $7^2$

**b**  $\sqrt{64}$

**c**  $3^3$

**d**  $\sqrt[3]{1000}$

## Exercise 1C

### FLUENCY

1-6( $\frac{1}{2}$ )

1-7( $\frac{1}{2}$ )

1-6( $\frac{1}{3}$ ), 7( $\frac{1}{2}$ )

Example 5a

1 Find the LCM of these pairs of numbers.

**a** 2 and 3

**b** 5 and 9

**c** 8 and 12

**d** 4 and 8

**e** 25 and 50

**f** 4 and 18

Example 5b

2 Find the HCF of these pairs of numbers.

**a** 6 and 8

**b** 18 and 9

**c** 16 and 24

**d** 24 and 30

**e** 7 and 13

**f** 19 and 31

Example 6a

3 Evaluate these squares.

**a**  $4^2$

**b**  $10^2$

**c**  $13^2$

**d**  $15^2$

**e**  $100^2$

**f**  $20^2$

Example 6b

4 Evaluate these square roots.

**a**  $\sqrt{25}$

**b**  $\sqrt{49}$

**c**  $\sqrt{4}$

**d**  $\sqrt{121}$

**e**  $\sqrt{36}$

**f**  $\sqrt{100}$

Example 6c

5 Evaluate these cubes.

**a**  $2^3$

**b**  $4^3$

**c**  $7^3$

**d**  $5^3$

**e**  $6^3$

**f**  $10^3$

Example 6d

6 Evaluate these cube roots.

a  $\sqrt[3]{8}$

b  $\sqrt[3]{125}$

c  $\sqrt[3]{27}$

d  $\sqrt[3]{216}$

e  $\sqrt[3]{1}$

f  $\sqrt[3]{512}$

7 a Find the LCM of 6, 8 and 12.

b Find the LCM of 3, 5 and 7.

c Find the HCF of 10, 15 and 20.

d Find the HCF of 32, 48 and 60.

## PROBLEM-SOLVING

8, 9

9–11

10–12

8 A teacher has 64 students to divide into smaller equal groups. One way is to form two groups of 32 students. In how many other ways can this be done?

9 Cyclist A rides a lap of a circular course every 3 minutes. Cyclist B rides a lap of the same course every 5 minutes. If both cyclists start at the same place at the same time, how long will it take before they are both back together at the starting position?



10 Three sets of traffic lights (A, B and C) all turn red at 9 a.m. exactly. Light set A turns red every 2 minutes, light set B turns red every 3 minutes and light set C turns red every 5 minutes. How long does it take for all three lights to turn red again at the same time?

11 How many prime numbers less than 100 are there?

12 a How many squares of any size are there on this grid?

b What do you notice about the number of squares of each size? Do you notice a pattern?

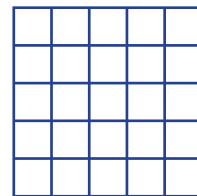

## REASONING

13

13, 14

13–15

13 Using the definitions (descriptions) in the **Key ideas**, explain why the number one (1) is not considered a prime or a composite number.

14 Explain why all square numbers (1, 4, 9, 16, ...) have an odd number of factors.

15 Decide if the following statements are always true. If they are not, give an example that shows that the statement is not always true. Assume that  $a$  and  $b$  are different numbers.a The LCM of two numbers  $a$  and  $b$  is  $a \times b$ .b The LCM of two prime numbers  $a$  and  $b$  is  $a \times b$ .c The HCF of two prime numbers  $a$  and  $b$  is 1.

## ENRICHMENT: Goldbach's conjecture and twin primes

16, 17

- 16 In 1742, Goldbach wrote a letter to Euler suggesting that every even number greater than 2 is the sum of three primes. Euler replied saying that this was equivalent to saying that every even number greater than 2 is the sum of two primes. If the number 1 is not considered to be prime (the modern convention), the idea becomes *Every even number greater than 2 is the sum of two primes*. This is known today as Goldbach's conjecture.
- a Show ways in which the following numbers can be written as a sum of two primes.
- i 28                                      ii 62                                      iii 116
- b Goldbach's conjecture does not discuss the odd numbers. Are there any odd numbers greater than 4 and less than 20 that cannot be written as a sum of two primes? If there are any, list them.

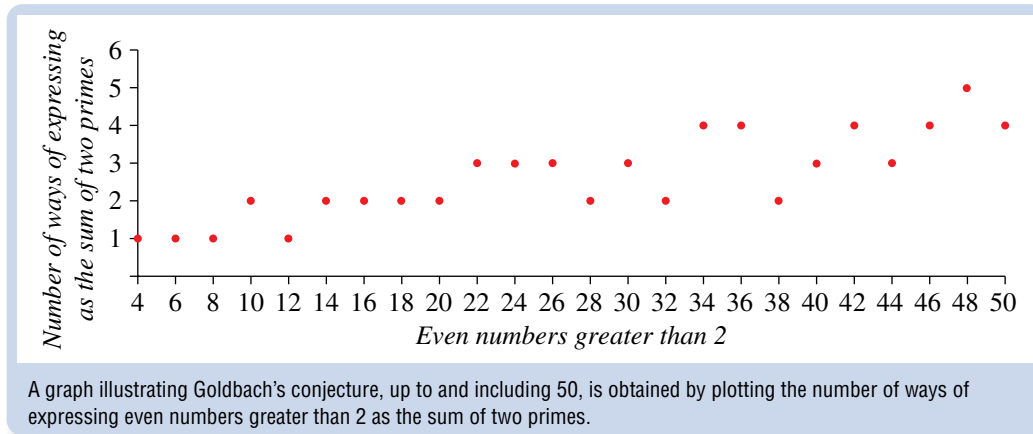

- 17 Twin primes are pairs of prime numbers that differ by 2. It has been conjectured that there are infinitely many twin primes. List the pairs of twin primes less than 100.

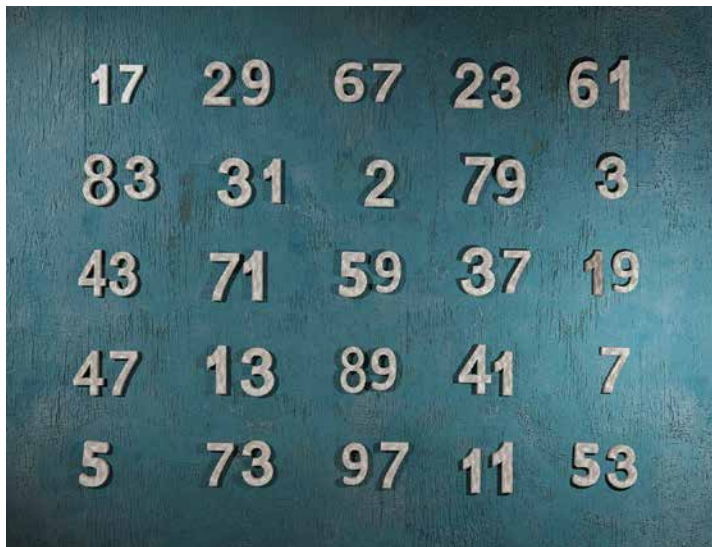

# 1D Divisibility and prime factorisation CONSOLIDATING

## LEARNING INTENTIONS

- To be able to find the prime factor form of a number
- To understand how the lowest common multiple and highest common factor of two numbers can be found using their prime factor form
- To be able to use the divisibility tests for single digit factors other than 7

The fundamental theorem of arithmetic says that every whole number greater than 1 can be written as a product of prime numbers. For example,  $6 = 2 \times 3$  and  $20 = 2 \times 2 \times 5$ . For this reason it is often said that prime numbers are the building blocks of all other whole numbers.

Writing numbers as a product of prime numbers can help to simplify expressions and determine other properties of numbers or pairs of numbers.



Mersenne prime numbers are 1 less than a power of 2, named after a 17th century French mathematician. In December 2018, the largest known prime number was  $2^{82589933} - 1$ , with almost 25 million digits. Large prime numbers are used in cryptography.

## Lesson starter: Remembering divisibility tests

To test if a number is divisible by 2, we simply need to see if the number is even or odd. All even numbers are divisible by 2. Try to remember the divisibility tests for each of the following. As a class, can you describe all the tests for the following?

- Divisible by 3
- Divisible by 4
- Divisible by 5
- Divisible by 6
- Divisible by 8
- Divisible by 9
- Divisible by 10

## KEY IDEAS

- **Prime factorisation** involves writing a number as a product of prime numbers.

For example:  $12 = 2 \times 2 \times 3$

- $2^2 \times 3$  is the **prime factor form** of 12.
- The prime numbers are usually written in ascending order.
- A factor tree can help to determine the prime factor form.

- The **lowest common multiple** (LCM) of two numbers in their prime factor form is the product of all the different primes raised to their highest power.

For example:  $12 = 2^2 \times 3$  and  $30 = 2 \times 3 \times 5$

So the LCM of 12 and 30 is  $2^2 \times 3 \times 5 = 60$ .

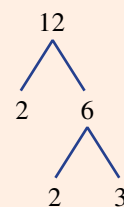

$$\therefore 12 = 2^2 \times 3$$



- The **highest common factor** (HCF) of two numbers in their prime factor form is the product of all the common primes raised to their smallest power.

For example:  $12 = 2^2 \times 3$  and  $30 = 2 \times 3 \times 5$

So the HCF of 12 and 30 is  $2 \times 3 = 6$ .

### ■ Divisibility tests

A number is divisible by:

- **2** if it ends with the digit 0, 2, 4, 6 or 8  
For example: 384 ends with a 4 and is an even number
- **3** if the sum of all the digits is divisible by 3  
For example: 162 where  $1 + 6 + 2 = 9$ , which is divisible by 3
- **4** if the number formed by the last two digits is divisible by 4  
For example: 148 where 48 is divisible by 4
- **5** if the last digit is a 0 or 5  
For example: 145 or 2090
- **6** if it is divisible by both 2 and 3  
For example: 456 where 6 is even and  $4 + 5 + 6 = 15$ , which is divisible by 3
- **8** if the number formed from the last 3 digits is divisible by 8  
For example: 2112 where 112 is divisible by 8
- **9** if the sum of all the digits is divisible by 9  
For example: 3843 where  $3 + 8 + 4 + 3 = 18$ , which is divisible by 9
- **10** if the last digit is a 0  
For example: 4230

There is no simple test for divisibility by 7.

## BUILDING UNDERSTANDING

- List all the factors of these numbers.  
a 15                      b 24                      c 40                      d 84
- List the first 10 prime numbers. Note that 1 is not a prime number.
- Classify the following as true or false.
  - The sum of the digits of 216 is 9.
  - 73 is even.
  - The product of 2, 2, 3 and 5 can be written as  $2^2 \times 3 \times 5$ .
  - $3 \times 5 \times 5 \times 5 \times 7 \times 7 = 3 \times 5^2 \times 7^3$
  - For the two numbers  $20 = 2^2 \times 5$  and  $150 = 2 \times 3 \times 5^2$ , the product of all of the different primes raised to their highest power is  $2^2 \times 3 \times 5^2$ .
  - For the two numbers  $20 = 2^2 \times 5$  and  $150 = 2 \times 3 \times 5^2$ , the product of the common primes raised to their smallest power is  $2 \times 5$ .

**Example 7 Finding prime factor form**

Use a factor tree to write 540 as a product of prime factors.

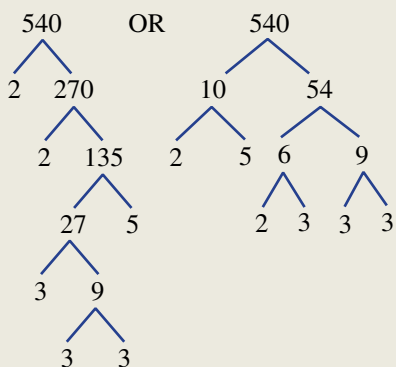
**SOLUTION**

$$540 = 2 \times 2 \times 3 \times 3 \times 3 \times 5$$

$$= 2^2 \times 3^3 \times 5$$

**EXPLANATION**

First, divide 540 into the product of any two factors. In this example the result is shown when the first two factors are  $2 \times 270$  or  $10 \times 54$ . There are other possibilities (e.g.  $5 \times 108$ ) but they will all give the same final result.

Continue dividing numbers into pairs of smaller factors until all the factors are prime numbers.

Write the prime factors in ascending order, then use powers for any repeated factors.

**Now you try**

Use a factor tree to write 140 as a product of prime factors.

**Example 8 Testing for divisibility**

Use divisibility tests to decide if the number 627 is divisible by 2, 3, 4, 5, 6, 8 or 9.

**SOLUTION**

Not divisible by 2 since 7 is odd.

Divisible by 3 since  $6 + 2 + 7 = 15$  and this is divisible by 3.

Not divisible by 4 as 27 is not divisible by 4.

Not divisible by 5 as the last digit is not a 0 or 5.

Not divisible by 6 as it is not divisible by 2.

**EXPLANATION**

The last digit needs to be even.

The sum of all the digits needs to be divisible by 3.

The number formed from the last two digits needs to be divisible by 4.

The last digit needs to be a 0 or 5.

The number needs to be divisible by both 2 and 3.

**SOLUTION**

Not divisible by 8 as the last 3 digits together are not divisible by 8.

Not divisible by 9 as  $6 + 2 + 7 = 15$  is not divisible by 9.

**EXPLANATION**

The number formed from the last three digits needs to be divisible by 8.

The sum of all the digits needs to be divisible by 9.

**Now you try**

Use divisibility tests to decide if the number 522 is divisible by 2, 3, 4, 5, 6, 8 or 9.

**Example 9 Finding the LCM and HCF using prime factorisation**

- a** Use prime factorisation to find the LCM of 105 and 90.  
**b** Use prime factorisation to find the HCF of 105 and 90.

**SOLUTION**

$$\begin{aligned} \mathbf{a} \quad 105 &= 3 \times 5 \times 7 \\ 90 &= 2 \times 3^2 \times 5 \end{aligned}$$

$$\begin{aligned} \text{LCM} &= 2 \times 3^2 \times 5 \times 7 \\ &= 630 \end{aligned}$$

$$\begin{aligned} \mathbf{b} \quad 105 &= 3 \times 5 \times 7 \\ 90 &= 2 \times 3^2 \times 5 \end{aligned}$$

$$\begin{aligned} \text{HCF} &= 3 \times 5 \\ &= 15 \end{aligned}$$

**EXPLANATION**

First, express each number in prime factor form.

For the LCM, include all the different primes, raising the common primes to their highest power.

First, express each number in prime factor form.

For the HCF, include only the common primes raised to the smallest power.

**Now you try**

- a** Use prime factorisation to find the LCM of 63 and 27.  
**b** Use prime factorisation to find the HCF of 63 and 27.

## Exercise 1D

### FLUENCY

1, 2–4(½)

2–4(½)

2–4(½)

**Example 7** 1 Copy and complete these factor trees to help write the prime factor form of the given numbers.

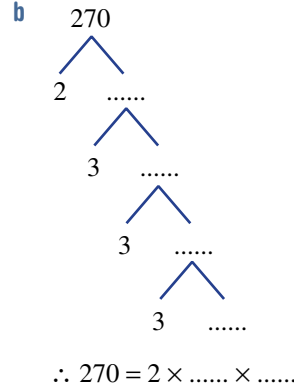
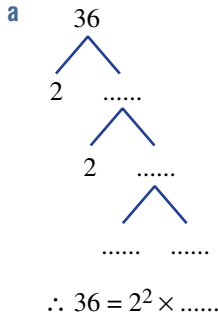

**Example 7** 2 Use a factor tree to find the prime factor form of these numbers.

- |              |              |              |              |
|--------------|--------------|--------------|--------------|
| <b>a</b> 20  | <b>b</b> 28  | <b>c</b> 40  | <b>d</b> 90  |
| <b>e</b> 280 | <b>f</b> 196 | <b>g</b> 360 | <b>h</b> 660 |

3 How many different primes make up the prime factor form of these numbers? (For example,  $90 = 2 \times 3^2 \times 5$  involves three different primes: 2, 3 and 5.)

- |             |             |              |               |
|-------------|-------------|--------------|---------------|
| <b>a</b> 30 | <b>b</b> 63 | <b>c</b> 180 | <b>d</b> 2695 |
|-------------|-------------|--------------|---------------|

**Example 8** 4 Use divisibility tests to decide if these numbers are divisible by 2, 3, 4, 5, 6, 8 or 9.

- |              |              |              |               |
|--------------|--------------|--------------|---------------|
| <b>a</b> 51  | <b>b</b> 126 | <b>c</b> 248 | <b>d</b> 387  |
| <b>e</b> 315 | <b>f</b> 517 | <b>g</b> 894 | <b>h</b> 3107 |

### PROBLEM-SOLVING

5–6(½), 7

5–6(½), 7

6(½), 7, 8

5 Find the highest common prime factor of each of these pairs of numbers.

- |                 |                 |                 |                   |
|-----------------|-----------------|-----------------|-------------------|
| <b>a</b> 10, 45 | <b>b</b> 42, 72 | <b>c</b> 24, 80 | <b>d</b> 539, 525 |
|-----------------|-----------------|-----------------|-------------------|

**Example 9** 6 Find the LCM and the HCF of these pairs of numbers, using prime factorisation.

- |                 |                 |                 |                   |
|-----------------|-----------------|-----------------|-------------------|
| <b>a</b> 10, 12 | <b>b</b> 14, 28 | <b>c</b> 15, 24 | <b>d</b> 12, 15   |
| <b>e</b> 20, 28 | <b>f</b> 13, 30 | <b>g</b> 42, 9  | <b>h</b> 126, 105 |

7 Aunt Elly’s favourite nephew visits her every 30 days. The other nephew visits her every 42 days. If both nephews visit Aunt Elly on one particular day, how long will it be before they both visit her again on the same day?

8 Two armies face each other for battle. One army has 1220 soldiers and the other has 549 soldiers. Both armies are divided into smaller groups of equal size called platoons. Find the largest possible number of soldiers in a platoon if the platoon size is equal for the two armies.



## REASONING

9

9, 10

10, 11

- 9 Decide if the following statements are true or false. If a statement is false, give an example to show this.
- All numbers divisible by 9 are divisible by 3.
  - All numbers divisible by 3 are divisible by 9.
  - All numbers divisible by 8 are divisible by 4.
  - All numbers divisible by 4 are divisible by 8.
- 10 If a number is divisible by 2 and 3, then it must be divisible by 6. Use this idea to complete these sentences.
- A number is divisible by 14 if it is divisible by \_\_\_\_\_ and \_\_\_\_\_.
  - A number is divisible by 22 if it is divisible by \_\_\_\_\_ and \_\_\_\_\_.
  - A number is divisible by 15 if it is divisible by \_\_\_\_\_ and \_\_\_\_\_.
  - A number is divisible by 77 if it is divisible by \_\_\_\_\_ and \_\_\_\_\_.
- 11 Powers higher than 3 can be used in prime factorisation.  
e.g.  $48 = 2 \times 2 \times 2 \times 2 \times 3 = 2^4 \times 3$   
Write the prime factor form of each number.
- 162
  - 96
  - 5625
  - 1792

## ENRICHMENT: Divisibility by 11

-

-

12

- 12 There is a more complex test to see if a number is divisible by 11.
- Divide each of these numbers by 11.
    - 22
    - 88
    - 121
    - 165
    - 308
    - 429
    - 1034
    - 9020
  - For the number 2035 (which is divisible by 11):
    - find the sum of the first and third digits.
    - find the sum of the second and fourth digits.
    - subtract your answer to part **ii** from your answer to part **i**. What do you notice?
  - Repeat all the tasks in part **b** for the number 8173 (which is divisible by 11).
  - Now find the sum of all the alternate digits for these numbers which are divisible by 11. Subtract the second sum from the first. What do you notice?
    - 4092
    - 913
    - 2475
    - 77
  - Can you now write down a divisibility test for dividing by 11? Test it on some numbers.



# 1E Negative integers CONSOLIDATING

## LEARNING INTENTIONS

- To understand that integers can be negative, zero or positive
- To understand how to use a number line to add or subtract positive integers
- To be able to add a positive integer to a negative integer
- To be able to subtract a positive integer from a positive or negative integer

Although the Indian mathematician Brahmagupta set out the rules for the use of negative numbers in the 7th century, the British mathematician Maseres claimed in 1758 that negative numbers ‘darken the very whole doctrines of the equations and make dark of the things which are in their nature excessively obvious and simple’. Despite this view that negative numbers were unnatural and had little meaning, they have found their way into the practical world of science, engineering and commerce. We can use negative numbers to distinguish between left and right, up and down, financial profits and losses, warm and cold temperatures, and the clockwise and anticlockwise rotation of a wheel.



Air temperature changes at a rate of  $-6.5^{\circ}\text{C}/\text{km}$ , decreasing to around  $-55^{\circ}\text{C}$  at 12 km altitude ( $\approx 40\,000$  feet). Jet fuel freezes at  $-40^{\circ}\text{C}$ , so aeronautical engineers design pumps to move and mix fuel, preventing freezing.

## Lesson starter: A negative world

Describe how to use negative numbers to describe these situations.

- $6^{\circ}\text{C}$  below zero
- A loss of \$4200
- 150m below sea level
- A turn of  $90^{\circ}$  anticlockwise
- The solution to the equation  $x + 5 = 3$

Can you describe another situation in which you might make use of negative numbers?

## KEY IDEAS

- Negative numbers are numbers less than zero.
- The integers are  $\dots, -4, -3, -2, -1, 0, 1, 2, 3, 4, \dots$   
These include positive integers (natural numbers), zero and negative integers. These are illustrated clearly on a number line.

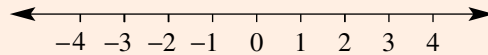

- Adding or subtracting a positive integer can result in a positive or negative number.

- Adding a positive integer

For example:

$$2 + 3 = 5$$

$$-4 + 3 = -1$$

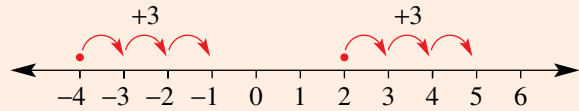

- Subtracting a positive integer

For example:

$$1 - 3 = -2$$

$$5 - 3 = 2$$

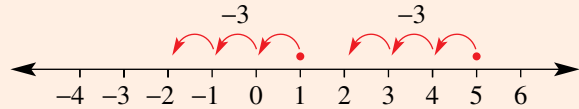

## BUILDING UNDERSTANDING

- 1 Choose the symbol  $<$  (less than) or  $>$  (greater than) to make these statements true.

a  $5 \underline{\hspace{1cm}} -1$

b  $-3 \underline{\hspace{1cm}} 4$

c  $-10 \underline{\hspace{1cm}} 3$

d  $-1 \underline{\hspace{1cm}} -2$

e  $-20 \underline{\hspace{1cm}} -24$

f  $-62 \underline{\hspace{1cm}} -51$

g  $2 \underline{\hspace{1cm}} -99$

h  $-61 \underline{\hspace{1cm}} 62$

- 2 State the missing numbers in these patterns.

a  $-3, -2, \underline{\hspace{1cm}}, 0, 1, \underline{\hspace{1cm}}, 3$

b  $1, 0, \underline{\hspace{1cm}}, -2, -3, \underline{\hspace{1cm}}, -5$

c  $-10, -8, -6, \underline{\hspace{1cm}}, \underline{\hspace{1cm}}, 0, 2$

d  $20, 10, \underline{\hspace{1cm}}, \underline{\hspace{1cm}}, -20, -40$

- 3 What is the final temperature?

a  $10^\circ\text{C}$  is reduced by  $12^\circ\text{C}$

b  $32^\circ\text{C}$  is reduced by  $33^\circ\text{C}$

c  $-11^\circ\text{C}$  is increased by  $2^\circ\text{C}$

d  $-4^\circ\text{C}$  is increased by  $7^\circ\text{C}$



### Example 10 Adding and subtracting a positive integer

Evaluate the following.

**a**  $-5 + 2$

**b**  $-1 + 4$

**c**  $3 - 7$

**d**  $-2 - 3$

#### SOLUTION

**a**  $-5 + 2 = -3$

#### EXPLANATION

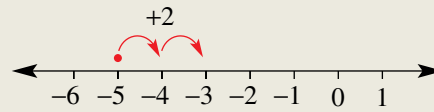

**b**  $-1 + 4 = 3$

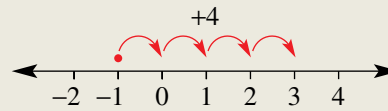

**c**  $3 - 7 = -4$

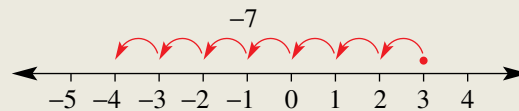

**d**  $-2 - 3 = -5$

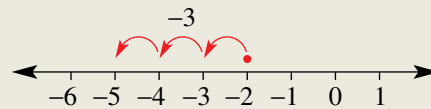

#### Now you try

Evaluate the following.

**a**  $-8 + 3$

**b**  $-2 + 9$

**c**  $4 - 10$

**d**  $-3 - 5$

## Exercise 1E

### FLUENCY

1,  $2 - 5\frac{1}{2}$

$2 - 6\frac{1}{2}$

$2 - 3\frac{1}{4}$ ,  $5 - 6\frac{1}{2}$

Example 10a,b

1 Evaluate the following.

**a**  $-6 + 2$

**b**  $-10 + 4$

**c**  $-2 + 5$

**d**  $-7 + 11$

Example 10a,b

2 Evaluate the following.

**a**  $-1 + 2$

**b**  $-3 + 7$

**c**  $-10 + 11$

**d**  $-4 + 12$

**e**  $-20 + 35$

**f**  $-100 + 202$

**g**  $-7 + 2$

**h**  $-15 + 8$

**i**  $-26 + 19$

**j**  $-38 + 24$

**k**  $-173 + 79$

**l**  $-308 + 296$

Example 10c,d

3 Evaluate the following.

**a**  $4 - 5$

**b**  $10 - 15$

**c**  $0 - 26$

**d**  $14 - 31$

**e**  $103 - 194$

**f**  $316 - 390$

**g**  $-4 - 7$

**h**  $-11 - 20$

**i**  $-14 - 15$

**j**  $-10 - 100$

**k**  $-400 - 37$

**l**  $-348 - 216$



- 4 State the sum (e.g.  $-3 + 4 = 1$ ) or difference (e.g.  $1 - 5 = -4$ ) to match these number lines.

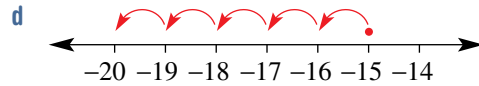
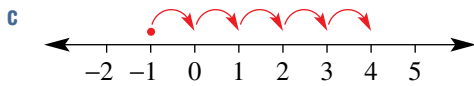
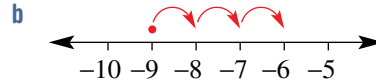
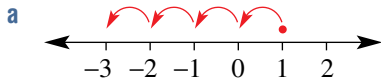

- 5 State the missing number.

a  $-1 + \underline{\quad} = 5$

b  $\underline{\quad} + 30 = 26$

c  $\underline{\quad} + 11 = -3$

d  $-32 + \underline{\quad} = -21$

e  $5 - \underline{\quad} = -10$

f  $\underline{\quad} - 17 = -12$

g  $\underline{\quad} - 4 = -7$

h  $-26 - \underline{\quad} = -38$

- 6 Evaluate the following. (Note: Addition and subtraction are at the same level, so calculations are done from left to right.)

a  $-3 + 4 - 8 + 6$

b  $0 - 10 + 19 - 1$

c  $26 - 38 + 14 - 9$

d  $9 - 18 + 61 - 53$

### PROBLEM-SOLVING

7, 8

7-9

8-10

- 7 In a high-rise building there are 25 floors above ground floor (floor 1, floor 2, ...) and 6 floors below ground floor. A lift starts at floor 3 and moves 5 floors down then 18 floors up, 4 more floors up, 26 floors down and finally 6 floors up. At which floor does the lift finish?



- 8 Insert a '+' and/or a '-' sign into these statements to make them true.
- a  $5 \underline{\quad} 7 = -2$                       b  $4 \underline{\quad} 6 \underline{\quad} 3 = 1$                       c  $-2 \underline{\quad} 5 \underline{\quad} 4 = -11$
- 9 On Monday Milly borrows \$35 from a friend. On Tuesday she pays her friend \$40. On Friday she borrows \$42 and pays back \$30 that night. How much does Milly owe her friend in the end?
- 10 The temperature in Greenland on a sunny day rises  $19^{\circ}\text{C}$  from its minimum temperature to a maximum of  $-4^{\circ}\text{C}$ . What was the minimum temperature on the day?

**REASONING**

11

11, 12

11-14

- 11 Explain with examples how the sum of a negative integer and a positive integer could be positive, negative or zero.
- 12 If  $a$  and  $b$  are positive integers, decide if the following are *always* true.
- a  $a + b$  is positive                      b  $a - b$  is negative                      c  $b - a$  is negative  
 d  $-a - b$  is negative                      e  $-a + b$  is positive                      f  $-b + a$  is negative
- 13 For what value of  $a$  is  $a = -a$ ? Try to prove that there is only one possible value of  $a$  that makes this true.
- 14 Find a method to evaluate the following without using a calculator or algorithm. Explain your method.  
 $-1 + 2 - 3 + 4 - 5 + 6 - 7 + 8 - \dots - 997 + 998 - 999 + 1000$

**ENRICHMENT: Integer pairs**

-

-

15

- 15 Find the pairs of integers  $(a, b)$  that satisfy both equations in each part.
- a  $a + b = 5$  and  $a - b = -3$                       b  $a + b = -4$  and  $a - b = -10$   
 c  $a + 2b = -1$  and  $a - 2b = -9$                       d  $a + b = -8$  and  $a - 2b = -14$

- 1A** 1 Evaluate these sums and differences mentally.
- a  $86 - 53$                       b  $28 + 14$                       c  $213 + 145$                       d  $462 - 70$
- 1A** 2 Use an algorithm to find these sums and differences.
- a 
$$\begin{array}{r} 58 \\ +265 \\ \hline \end{array}$$
                      b 
$$\begin{array}{r} 82 \\ -45 \\ \hline \end{array}$$
                      c 
$$\begin{array}{r} 378 \\ 26 \\ +139 \\ \hline \end{array}$$
                      d 
$$\begin{array}{r} 5024 \\ -2957 \\ \hline \end{array}$$
- 1B** 3 Use a mental strategy to evaluate the following.
- a  $5 \times 140$                       b  $6 \times 49$                       c  $128 \div 8$                       d  $1692 \div 4$
- 1B** 4 Use an algorithm to evaluate the following.
- a 
$$\begin{array}{r} 37 \\ \times 6 \\ \hline \end{array}$$
                      b 
$$\begin{array}{r} 307 \\ \times 219 \\ \hline \end{array}$$
                      c  $7 \overline{)427}$                       d  $15 \overline{)347}$
- 1C** 5 a Find the LCM of 8 and 12.  
b Find the HCF of 24 and 30.
- 1C** 6 Evaluate these squares and square roots.
- a  $6^2$                       b  $30^2$                       c  $\sqrt{64}$                       d  $\sqrt{2500}$
- 1C** 7 Evaluate these cubes and cube roots.
- a  $2^3$                       b  $100^3$                       c  $\sqrt[3]{27}$                       d  $\sqrt[3]{125}$
- 1D** 8 Use a factor tree to write 360 as a product of prime factors.
- 1D** 9 Use divisibility tests to decide if the number 126 is divisible by 2, 3, 4, 5, 6, 8 or 9. State a reason for each answer.
- 1D** 10 Find the HCF and LCM of these pairs of numbers, using prime factorisation.
- a 42 and 18  
b 105 and 90
- 1E** 11 Evaluate the following.
- a  $-6 + 20$   
b  $-5 - 12$   
c  $-206 + 132$   
d  $-218 - 234$   
e  $-5 + 7 - 9 - 6$   
f  $12 - 46 + 27 - 63$
- 1D** 12 Three schools are competing at a sports carnival. Each school has a different coloured sports uniform. The numbers of Year 8 students competing are: 162 with a green uniform, 108 with a red uniform and 144 with a blue uniform. All the Year 8 students are to be split up into equal-sized teams.
- a What is the largest possible team size so every Year 8 student is in a team of students all from their own school?  
b How many of these Year 8 teams will be formed from each school?

# 1F Adding and subtracting negative integers

CONSOLIDATING

## LEARNING INTENTIONS

- To understand that adding a negative number is the same as subtracting its opposite
- To understand that subtracting a negative number is the same as adding its opposite
- To be able to add or subtract negative integers

If  $\oplus$  represents  $+1$  and  $\ominus$  represents  $-1$  then  $\oplus \ominus$  added together has a value of zero.

Using these symbols,  $5 + (-2) = 3$  could be illustrated as the addition of  $2\ominus$ , leaving a balance of 3.

$$\begin{array}{ccccccc}
 \oplus & \oplus & \oplus & & \ominus & & \oplus & \oplus & \oplus & \ominus & & \oplus & \oplus \\
 \oplus & \oplus & & + & \ominus & = & \oplus & \oplus & \oplus & \ominus & = & \oplus & \oplus \\
 \oplus & \oplus & & & \ominus & & \oplus & \oplus & \oplus & \ominus & & \oplus & \\
 5 & & & & (-2) & & 0 & & & & & 3 & \\
 \end{array}$$

So  $5 + (-2)$  is the same as  $5 - 2$ .

Also  $5 - (-2) = 7$  could be illustrated first as  $7\oplus$  and  $2\ominus$  together then subtracting the  $2\ominus$ .

$$\begin{array}{ccccccc}
 \oplus & \oplus & \oplus & & \ominus & & \oplus & \oplus & \oplus & \oplus & \ominus & & \oplus & \oplus & \oplus & \oplus & \oplus & \oplus & \oplus \\
 \oplus & \oplus & & - & \ominus & = & \oplus & \oplus & \oplus & \oplus & \ominus & - & \ominus & = & \oplus & \oplus & \oplus & \oplus & \oplus \\
 \oplus & \oplus & & & \ominus & & \oplus & \oplus & \oplus & \oplus & \ominus & & \ominus & & \oplus & \oplus & \oplus & \oplus & \oplus \\
 5 & & & & (-2) & & 5 & & & & \ominus & & (-2) & & 7 & & & & \\
 \end{array}$$

So  $5 - (-2)$  is the same as  $5 + 2$ .

When adding or subtracting negative integers, we follow the rules set out by the above two illustrations.



In a stroke-play golf tournament, adding and subtracting negative integers is used to calculate a golfer's cumulative score across four rounds. A golfer who scores 3 under par in the first round, 2 over par in the second round, 1 under par in the third round, and par in the final round, has a tournament score of:  $-3 + 2 - 1 + 0 = -2$ .

## Lesson starter: Circle arithmetic

Use  $\oplus$  and  $\ominus$  as shown in the introduction to illustrate and calculate the answers to these additions and subtractions.

- $3 + (-2)$
- $-2 + (-4)$
- $-5 + (-2)$
- $3 - (-2)$
- $-3 - (-2)$
- $-1 - (-4)$

### KEY IDEAS

■ **Opposite** numbers have the same magnitude but a different sign.

- The opposite of 3 is  $-3$ .
- The opposite of  $-12$  is 12.

■ Adding a negative number is the same as subtracting its opposite.

For example:

$$2 + (-3) = 2 - 3 = -1$$

$$-4 + (-7) = -4 - 7 = -11$$

■ Subtracting a negative number is the same as adding its opposite. For example:

$$2 - (-5) = 2 + 5 = 7$$

$$-6 - (-4) = -6 + 4 = -2$$

### BUILDING UNDERSTANDING

1 State the opposites of these numbers.

a  $-6$

b  $38$

c  $88$

d  $-349$

2 Choose the word 'add' or 'subtract' to suit each sentence.

a To add a negative number, \_\_\_\_ its opposite.

b To subtract a negative number, \_\_\_\_ its opposite.

3 Decide if the following statements are true or false.

a  $5 + (-2) = 5 + 2$

b  $3 + (-4) = 3 - 4$

c  $-6 + (-4) = -6 - 4$

d  $-1 + (-3) = 1 - 3$

e  $8 - (-3) = 8 + 3$

f  $2 - (-3) = 2 - 3$

g  $-3 - (-1) = 3 + 1$

h  $-7 - (-5) = -7 + 5$

i  $-6 - (-3) = 6 + 3$



### Example 11 Adding and subtracting negative integers

Evaluate the following.

**a**  $10 + (-3)$

**b**  $-3 + (-5)$

**c**  $4 - (-2)$

**d**  $-11 - (-6)$

#### SOLUTION

**a**  $10 + (-3) = 10 - 3$   
 $= 7$

**b**  $-3 + (-5) = -3 - 5$   
 $= -8$

**c**  $4 - (-2) = 4 + 2$   
 $= 6$

**d**  $-11 - (-6) = -11 + 6$   
 $= -5$

#### EXPLANATION

Adding  $-3$  is the same as subtracting 3.

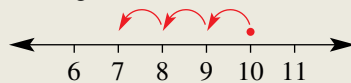

Adding  $-5$  is the same as subtracting 5.

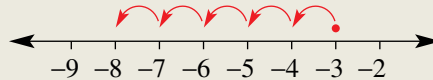

Subtracting  $-2$  is the same as adding 2.

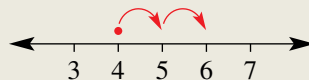

Subtracting  $-6$  is the same as adding 6.

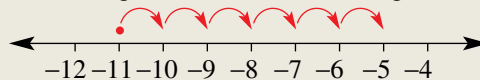

#### Now you try

Evaluate the following.

**a**  $7 + (-5)$

**b**  $-2 + (-4)$

**c**  $5 - (-3)$

**d**  $-7 - (-4)$



Liquid nitrogen freezes at  $-210^{\circ}\text{C}$ .

## Exercise 1F

## FLUENCY

1, 2(1/2), 3, 4(1/2)

1-4(1/2)

2(1/2), 4(1/2), 5(1/2)

- Example 11a 1 Evaluate the following.
- a  $5 + (-2)$       b  $7 + (-3)$       c  $4 + (-3)$       d  $9 + (-1)$

- Example 11a,b 2 Evaluate the following.
- a  $6 + (-2)$       b  $4 + (-1)$       c  $7 + (-12)$   
 d  $20 + (-5)$       e  $2 + (-4)$       f  $26 + (-40)$   
 g  $-3 + (-6)$       h  $-16 + (-5)$       i  $-18 + (-20)$   
 j  $-36 + (-50)$       k  $-83 + (-22)$       l  $-120 + (-139)$

- Example 11c 3 Evaluate the following.
- a  $5 - (-3)$       b  $10 - (-13)$       c  $8 - (-1)$       d  $7 - (-4)$

- Example 11c,d 4 Evaluate the following.
- a  $2 - (-3)$       b  $4 - (-4)$       c  $15 - (-6)$   
 d  $24 - (-14)$       e  $59 - (-13)$       f  $147 - (-320)$   
 g  $-5 - (-3)$       h  $-8 - (-10)$       i  $-13 - (-16)$   
 j  $-10 - (-42)$       k  $-88 - (-31)$       l  $-125 - (-201)$

- 5 State the missing number.
- a  $4 + \underline{\quad} = 1$       b  $6 + \underline{\quad} = 0$       c  $-2 + \underline{\quad} = -1$   
 d  $\underline{\quad} + (-8) = 2$       e  $\underline{\quad} + (-5) = -3$       f  $\underline{\quad} + (-3) = -17$   
 g  $12 - \underline{\quad} = 14$       h  $8 - \underline{\quad} = 12$       i  $-1 - \underline{\quad} = 29$   
 j  $\underline{\quad} - (-7) = 2$       k  $\underline{\quad} - (-2) = -4$       l  $\underline{\quad} - (-436) = 501$

## PROBLEM-SOLVING

6-8

6-9

7-10

- 6 Place the integers from  $-3$  to  $2$  in this magic triangle so that each side adds to the given number.
- a  $-3$       b  $0$

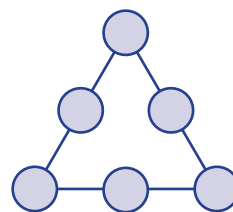

- 7 A magic square has each row, column and main diagonal adding to the same magic sum. Complete these magic squares.

a

		1
0	-2	-4

b

-12		
	-15	
	-11	-18

- 8 A bank account has an initial balance of \$150. Over a one-week period the following occurred.
- \$180 was spent on shoes.
  - \$300 of debt was added to the account as a cash advance.
  - \$250 of debt was repaid.
  - \$110 of debt was added because of a bank fee.
  - \$150 of debt was removed with a cash deposit.
- What was the balance of the account at the end of the week?



- 9 Find a pair of negative integers  $a$  and  $b$  that satisfy both equations in each part.
- a  $a + b = -8$  and  $a - b = 2$
- b  $a + b = -24$  and  $a - b = -6$
- 10 a The sum of two integers is  $-5$  and their difference is 11. What are the two numbers?
- b The sum of two integers is 11 and their difference is 19. What are the two numbers?

## REASONING

11, 12

11–13

12–14

- 11 Describe the error made in the working shown.
- a  $5 - (-2) = 5 - 2$   
 $= 3$
- b  $-2 + (-3) = 2 - 3$   
 $= -1$
- 12 An addition fact like  $2 + 3 = 5$  can be used to generate two subtraction facts:  $5 - 2 = 3$  and  $5 - 3 = 2$ .
- a Write two subtraction facts that can be generated from  $4 + 6 = 10$ .
- b Write two subtraction facts that can be generated from  $7 + (-2) = 5$ .
- c Explain why  $-4 - (-5) = 1$  by using an addition fact involving 1,  $-4$  and  $-5$ .
- 13 If  $a$  and  $b$  are both negative integers and  $a > b$ , decide if the following are always less than zero.
- a  $a + b$                       b  $b + a$                       c  $a - b$                       d  $b - a$
- 14 If  $a$  is a negative number, decide if the following are equal to zero.
- a  $a + a$                       b  $a - a$                       c  $a + (-a)$                       d  $a - (-a)$

## ENRICHMENT: Applying rules

-

-

15, 16

- 15 A rule linking two integers,  $x$  and  $y$ , is given by  $y = 5 - x$ .
- a Complete this table.
- b Find a value for  $y$  if  $x = -13$ .
- c Find a value for  $x$  if  $y = 50$ .

$x$	-2	-1	0	1	2	3
$y$						

- 16 A rule linking two integers,  $x$  and  $y$ , is given by  $x - y = -3$ .
- a Complete this table.
- b Find a value for  $y$  if  $x = 12$ .
- c Find a value for  $x$  if  $y = -6$ .

$x$	-3	-2	-1	0	1	2	3
$y$							



The following problems will investigate practical situations drawing upon knowledge and skills developed throughout the chapter. In attempting to solve these problems, aim to identify the key information, use diagrams, formulate ideas, apply strategies, make calculations, and check and communicate your solutions.

## Parking at a ski resort

- 1 A developer has proposed building a new state-of-the-art ski hotel (chalet) with the following specifications.

Type of accommodation	Number to be built	Sleeping capacity
1-bedroom apartment	170	2
2-bedroom apartment	120	5
3-bedroom apartment	40	8
6-bed bunkroom	50	6

*The local shire town planning department is interested in determining the number of car park spaces the developer will have to provide for the size of the hotel they are proposing.*

- What is the maximum number of guests the proposed hotel will be able to sleep?
- Recent data suggest that the average number of people per car visiting the snow is 3 people per car. Based on this information, how many car park spaces would the hotel require if it was full? Data provided by the developer suggests that only half of ski visitors arrive in their own car, with the other half choosing to arrive by either of the two operating bus companies.
- Based on this new information, how many car park spaces would the hotel require if it was full?
- The developer also knows, however, that there is a large public car park in the resort that clients could use on occasion. The developer proposes to provide car parking spaces only up to a 75% occupation rate, as quite often the hotel will not be at capacity. If the town planning department agree with this proposal, how many car park spaces will the hotel have to provide?

## Saving for a beach buggy wheelchair

- 2 A group of four friends want to purchase a beach buggy wheelchair for one of their close friends who is suffering from a chronic illness and is unable to walk.

The four friends have the following amounts of money:  
\$75, \$230, \$30, –\$40.

The cost of the beach buggy wheelchair is \$2960.

*The friends are interested in determining how much money they need to save and how they might be able to save the money.*



- Unfortunately, one of the four friends has no money and actually owes his parents \$40. What is the current difference in money between the friend with the most and the friend with the least amount of money?
- If the four friends decide to put in equal amounts of money for the wheelchair, how much does each friend need to contribute?
- What amount do each of the friends need to save to reach the amount required to purchase the wheelchair? Assume they put in equal amounts.

- d Instead of trying to raise funds separately, they decide to pool the amount of money they currently have and fundraise to make up the difference. How much do the friends need to fundraise to be able to buy the wheelchair? Assume that the \$40 owed to one of the friend's parents does need to be repaid.
- e The friends decide to do a wheelchair-a-thon and raise money through working as a relay team, travelling a distance of 50 km on a wheelchair during a twelve-hour period. How many friends and family members will they need to sponsor them at a rate of \$1 per kilometre?
- f If the fundraiser were unsuccessful and the friends had to resort to saving money each week, how much money would they need to save each week if they wished to buy the wheelchair in six weeks' time?
- g If each friend could only save \$20/week for the next six weeks, but they still wanted to purchase the wheelchair, how many more friends would they need to join their group and contribute a saving of \$20/week for the six weeks?

### Time to freeze

- 3 Maree has recently purchased a new chest (deep) freezer for keeping food at the very low temperature of  $-18^{\circ}\text{C}$ .

*Maree is interested in determining how long it will take some foods to freeze and how long it will take some foods to thaw.*

- a Maree understands that her new freezer can lower the temperature of food at a rate of  $6^{\circ}\text{C}$  per hour. Maree places some food, currently at a room temperature of  $24^{\circ}\text{C}$ , in her new freezer. How long will it take for the food to reach the freezer temperature of  $-18^{\circ}\text{C}$ ?
- b On a different day, Maree discovered that a loaf of bread only took four hours to freeze to the temperature of  $-18^{\circ}\text{C}$ . What was the room temperature on this day?
- c Maree wishes to determine the rate at which frozen meat can thaw and return to a temperature of  $5^{\circ}\text{C}$  ready for her to cook. She carries out the following test cases.

Size of frozen meat	Room temperature	Time to reach $5^{\circ}\text{C}$
3 kilograms	$12^{\circ}\text{C}$	4 hours
1 kilogram	$16^{\circ}\text{C}$	55 minutes
2 kilograms	$10^{\circ}\text{C}$	2 hours and 20 minutes
1 kilogram	$22^{\circ}\text{C}$	40 minutes

Based on Maree's test cases, what is an average time for how long it takes food to thaw (and reach  $5^{\circ}\text{C}$ ) per kilogram of frozen meat for a normal room temperature of  $15^{\circ}\text{C}$ ?

- d If Maree has a 4 kg frozen turkey in the freezer that she wishes to start cooking at 4:30 p.m., and she estimates the average room temperature during the day will be  $19^{\circ}\text{C}$ , what time would you suggest Maree takes the turkey out of the freezer?
- e If Maree has an  $n$  kg frozen piece of meat that she wishes to cook in  $t$  hours and the room temperature is  $15^{\circ}\text{C}$ , when should Maree take the meat out of the freezer? Your answer will be an expression in terms of  $t$  and  $n$ .

# 1G Multiplying and dividing negative integers

## LEARNING INTENTIONS

- To understand that the product or quotient of two integers will be positive if the two integers have the same sign
- To understand that the product or quotient of two integers will be negative if the two integers have opposite signs
- To be able to find the product and quotient of two or more integers

As a repeated addition,  $3 \times (-2)$  can be written as  $(-2) + (-2) + (-2) = -6$ . So  $3 \times (-2) = -6$  and, since  $a \times b = b \times a$  for all numbers  $a$  and  $b$ , then  $-2 \times 3$  is also equal to  $-6$ .

For division, we can write the product  $3 \times 2 = 6$  as a quotient  $6 \div 2 = 3$ . Similarly, if  $3 \times (-2) = -6$  then  $-6 \div (-2) = 3$ . Also, if  $-2 \times 3 = -6$  then  $-6 \div 3 = -2$ .

These observations can be used to explain why the quotient of two negative numbers results in a positive number and the product or quotient of two numbers of opposite sign is a negative number.

$6 \div (-2) = -3$  can also be rearranged to  $-3 \times (-2) = 6$ , which also can be used to explain why the product of two negative numbers is a positive number.



Car financiers multiply and divide with integers. If a loan is worth \$250 per month for 5 years, the total balance is  $60 \times (-\$250) = -\$15000$ ; if a 30-month loan has \$3600 of total interest due, the monthly interest balance is  $(-\$3600) \div 30 = -\$120$ .

## Lesson starter: Logical patterns

Complete the patterns in these tables to discover the rules for the product of integers.

□	△	□ × △
3	2	6
2	2	
1	2	
0	2	
-1	2	
-2	2	
-3	2	

□	△	□ × △
3	-2	-6
2	-2	-4
1	-2	
0	-2	
-1	-2	
-2	-2	
-3	-2	

Use the table results to complete these statements.

- $3 \times 2 = 6$  so  $6 \div \underline{\quad} = 3$
- $-3 \times 2 = \underline{\quad}$  so  $-6 \div 2 = \underline{\quad}$
- $3 \times (-2) = \underline{\quad}$  so  $\underline{\quad} \div (-2) = 3$
- $-3 \times (-2) = \underline{\quad}$  so  $6 \div (-2) = \underline{\quad}$

What do these observations tell us about multiplying and dividing positive and negative numbers?

## KEY IDEAS

- The product or quotient of two integers of the same sign is a positive integer.
  - Positive  $\times$  Positive = Positive, e.g.  $6 \times 3 = 18$
  - Positive  $\div$  Positive = Positive, e.g.  $6 \div 3 = 2$
  - Negative  $\times$  Negative = Positive, e.g.  $(-6) \times (-3) = 18$
  - Negative  $\div$  Negative = Positive, e.g.  $(-6) \div (-3) = 2$
- The product or quotient of two integers of opposite signs is a negative integer.
  - Positive  $\times$  Negative = Negative, e.g.  $6 \times (-3) = -18$
  - Positive  $\div$  Negative = Negative, e.g.  $6 \div (-3) = -2$
  - Negative  $\times$  Positive = Negative, e.g.  $(-6) \times 3 = -18$
  - Negative  $\div$  Positive = Negative, e.g.  $(-6) \div 3 = -2$

## BUILDING UNDERSTANDING

- 1 State the missing numbers in these tables. You should create a pattern in the third column.

a

$\square$	$\triangle$	$\square \times \triangle$
3	5	15
2	5	
1	5	
0	5	
-1	5	
-2	5	
-3	5	

b

$\square$	$\triangle$	$\square \times \triangle$
3	-5	-15
2	-5	-10
1	-5	
0	-5	
-1	-5	
-2	-5	
-3	-5	

- 2 State the missing numbers in these statements. Use the tables in Question 1 to help.

a  $3 \times 5 = \underline{\quad}$  so  $15 \div 5 = \underline{\quad}$

b  $-3 \times 5 = \underline{\quad}$  so  $-15 \div 5 = \underline{\quad}$

c  $3 \times (-5) = \underline{\quad}$  so  $-15 \div (-5) = \underline{\quad}$

d  $-3 \times (-5) = \underline{\quad}$  so  $15 \div (-5) = \underline{\quad}$

- 3 Decide if these statements are true or false.

- a Any integer multiplied by zero is equal to zero.
- b The product of two positive integers is negative.
- c The product of two positive integers is positive.
- d The quotient of two integers of opposite sign is negative.
- e The quotient of two integers of the same sign is negative.

**Example 12 Finding products and quotients of integers**

Evaluate the following.

**a**  $3 \times (-7)$

**c**  $-63 \div 7$

**b**  $-4 \times (-12)$

**d**  $-121 \div (-11)$

**SOLUTION**

**a**  $3 \times (-7) = -21$

**b**  $-4 \times (-12) = 48$

**c**  $-63 \div 7 = -9$

**d**  $-121 \div (-11) = 11$

**EXPLANATION**

The product of two numbers of opposite sign is negative.

 $-4$  and  $-12$  are both negative and so the product will be positive.

The two numbers are of opposite sign so the answer will be negative.

 $-121$  and  $-11$  are both negative so the quotient will be positive.**Now you try**

Evaluate the following.

**a**  $-3 \times 8$

**c**  $-24 \div 8$

**b**  $-2 \times (-5)$

**d**  $-48 \div (-12)$

**Example 13 Combining multiplication and division**Evaluate  $-2 \times 9 \div (-3) \times (-5)$ .**SOLUTION**

$$\begin{aligned} -2 \times 9 \div (-3) \times (-5) &= -18 \div (-3) \times (-5) \\ &= 6 \times (-5) \\ &= -30 \end{aligned}$$

**EXPLANATION**

Note: Both multiplication and division are at the same level, so we work from left to right.

First, evaluate  $-2 \times 9 = -18$ 

$$-18 \div (-3) = 6$$

$$6 \times (-5) = -30$$

**Now you try**Evaluate  $4 \times (-10) \div (-2) \times 5$ .

## Exercise 1G

## FLUENCY

1, 2-4(1/2)

2-5(1/2)

2-3(1/4), 4-5(1/3)

Example 12a,b

1 Evaluate the following.

a  $2 \times (-10)$

b  $5 \times (-6)$

c  $-3 \times (-7)$

d  $-7 \times (-11)$

Example 12a,b

2 Evaluate the following.

a  $4 \times (-5)$

b  $6 \times (-9)$

c  $-4 \times 10$

d  $-11 \times 9$

e  $-2 \times (-3)$

f  $-5 \times (-3)$

g  $-10 \times (-4)$

h  $-100 \times (-3)$

i  $-4 \times 7$

j  $40 \times (-3)$

k  $-20 \times (-3)$

l  $-20 \times (-20)$

Example 12c,d

3 Evaluate the following.

a  $-10 \div 2$

b  $-40 \div 10$

c  $-20 \div 10$

d  $-12 \div 4$

e  $16 \div (-8)$

f  $26 \div (-1)$

g  $90 \div (-2)$

h  $100 \div (-25)$

i  $-6 \div (-2)$

j  $-30 \div (-10)$

k  $-45 \div (-5)$

l  $-30 \div (-5)$

4 State the missing number.

a  $\underline{\hspace{2cm}} \times 3 = -9$

b  $\underline{\hspace{2cm}} \times (-7) = 35$

c  $\underline{\hspace{2cm}} \times (-4) = -28$

d  $-3 \times \underline{\hspace{2cm}} = -18$

e  $-19 \times \underline{\hspace{2cm}} = 57$

f  $-19 \times \underline{\hspace{2cm}} = 57$

g  $\underline{\hspace{2cm}} \div (-9) = 8$

h  $\underline{\hspace{2cm}} \div 6 = -42$

i  $85 \div \underline{\hspace{2cm}} = -17$

j  $-150 \div \underline{\hspace{2cm}} = 5$

Example 13

5 Evaluate the following.

a  $-4 \times 2 \div (-8)$

b  $30 \div (-15) \times (-7)$

c  $48 \div (-3) \times (-10)$

d  $-1 \times 58 \times (-2) \div (-4)$

e  $-110 \div (-11) \times 12 \div (-1)$

f  $-15 \times (-2) \div (-3) \times (-2)$

## PROBLEM-SOLVING

6, 7

6-8

8-10

6 Insert  $\times$  signs and  $/$  or  $\div$  signs to make these equations true.

a  $-2 \underline{\hspace{0.5cm}} 3 \underline{\hspace{0.5cm}} (-6) = 1$

b  $10 \underline{\hspace{0.5cm}} (-5) \underline{\hspace{0.5cm}} (-2) = 25$

c  $6 \underline{\hspace{0.5cm}} (-6) \underline{\hspace{0.5cm}} 20 = -20$

d  $-14 \underline{\hspace{0.5cm}} (-7) \underline{\hspace{0.5cm}} (-2) = -1$

e  $-32 \underline{\hspace{0.5cm}} (-3) \underline{\hspace{0.5cm}} (-2) = -48$

f  $130 \underline{\hspace{0.5cm}} (-4) \underline{\hspace{0.5cm}} (-8) = 65$

7 Find the average of the numbers  $-7$ ,  $-10$  and  $-1$ . Note that to find the average of three numbers, you must add these numbers and divide by 3.8 The average of two numbers is  $-4$ . A new number is added to the list making the average  $-3$ . What is the new number?9 The product of two numbers is  $-24$  and their sum is  $-5$ . What are the two numbers?10 The quotient of two numbers is  $-4$  and their difference is 10. What are the two numbers?

**REASONING** 11 11, 12 12-15

- 11 a** If the product of two numbers is negative, will the sum of the numbers always be negative? Explain why or why not.
- b** If the sum of two numbers is negative, will the product of the two numbers always be negative? Explain why or why not.
- c** If the product of two numbers is negative, will the quotient of the two numbers always be negative? Explain why or why not.
- 12** Remember that  $a^2 = a \times a$  and  $a^3 = a \times a \times a$ .
- a** Evaluate these expressions.
- i**  $(-2)^2$       **ii**  $(-3)^3$       **iii**  $(-4)^3$       **iv**  $(-5)^2$
- b** Will the square of a negative number always be positive? Explain why.
- c** Will the cube of a negative number always be negative? Explain why.
- 13 a** State the value of
- i**  $(-1)^2$       **ii**  $(-1)^3$       **iii**  $(-1)^4$       **iv**  $(-1)^5$       **v**  $(-1)^6$
- b** Fill in the blanks to make this a true generalisation.  
 $(-1)^n$  is equal to 1 if  $n$  is \_\_\_\_ and  $(-1)^n$  is equal to  $-1$  if  $n$  is \_\_\_\_.
- c** What is the value of  $(-1)^{999}$ ?
- 14** We know that  $3^2 = 9$  and  $(-3)^2 = 9$ . Explain why  $\sqrt{-9}$  is not a real number.
- 15** Is it possible to find the cube root of a negative number? Explain why and give some examples.

**ENRICHMENT: What's my integer rule?** - - 16

- 16** Find a rule linking  $x$  and  $y$  for these tables. Start your rules by making  $y$  the subject, e.g.  $y = -2x + 1$ .

**a**

$x$	$y$
-3	8
-2	5
-1	2
0	-1
1	-4
2	-7

**b**

$x$	$y$
-3	18
-2	11
-1	4
0	-3
1	-10
2	-17

**c**

$x$	$y$
-4	17
-2	5
0	1
2	5
4	17
6	37



The lowest land area on Earth is the shoreline of the Dead Sea at 413 m below sea level or  $-413$  m.

## 1H Order of operations and substitution

### LEARNING INTENTIONS

- To understand the rules for order of operations
- To be able to evaluate numerical expressions using the order of operations
- To be able to substitute integers for pronumerals in order to evaluate expressions

An expression such as  $a + 2b$  can be evaluated if we know the values of  $a$  and  $b$ . The expression includes the operations addition (listed first) and multiplication ( $2b$  is  $2 \times b$ ); however, by convention, we know that multiplication is done before the addition. In this section we will deal with order of operations, using both positive and negative integers.



Expansion joints prevent bridges from buckling in hot weather. Engineers apply the order of operations after substituting values for the bridge length,  $L$  m, temperatures,  $t$  °C to  $T$  °C, and a given  $a$  value into the expansion length formula:  $l = aL(T - t)$ .

### Lesson starter: Equal to 1

Maria makes up a difficult problem for which the answer is equal to 1, but forgets to bring the piece of paper she wrote it on to class. Maria remembers the numbers but not the extra sets of brackets that were involved.

$$-5 \times (-4) + 2 + (-40) \div 5 + 3 - 4 = 1$$

She remembers that there were two extra sets of brackets that should be inserted. Can you decide where they should go?

### KEY IDEAS

- The rules for order of operations are:
  - Deal with operations inside brackets first.
  - Deal with powers.
  - Do multiplication and division next, working from left to right.
  - Do addition and subtraction last, working from left to right.



For example:

$$\begin{aligned} (-2 + 4) \times 3^2 - 5 \div (-5) \\ &= 2 \times 3^2 - 5 \div (-5) \\ &= 2 \times 9 - 5 \div (-5) \\ &= 18 - (-1) \\ &= 19 \end{aligned}$$

- Expressions can be evaluated by substituting numbers for the given pronumerals.

For example: If  $a = -2$  and  $b = -3$ , then  $a + 5b = -2 + 5 \times (-3)$

$$\begin{aligned} &= -2 + (-15) \\ &= -17 \end{aligned}$$

- Remember, for example, that  $5b$  means  $5 \times b$  and  $\frac{a}{3}$  means  $a \div 3$ .

## BUILDING UNDERSTANDING

- 1 Decide if both sides of these simple statements are equal.

a  $(2 + 3) - 1 = 2 + 3 - 1$

b  $(3 + (-2)) - (-1) = 3 + (-2) - (-1)$

c  $5 \times (2 + (-3)) = 5 \times 2 + (-3)$

d  $-8 \times 2 - (-1) = -8 \times (2 - (-1))$

e  $-10 \div 2 - 4 = -10 \div (2 - 4)$

f  $-2 \times 3 + 8 \div (-2) = (-2 \times 3) + (8 \div (-2))$

- 2 State the missing numbers to complete the working for each problem.

a  $-12 \div (6 + (-2)) = -12 \div \underline{\quad}$   
 $= \underline{\quad}$

b  $(-8 + 2) \times (-3) = \underline{\quad} \times (-3)$   
 $= \underline{\quad}$

c  $(-2 + (-1)) \div (15 \div (-5))$   
 $= \underline{\quad} \div (15 \div (-5))$   
 $= \underline{\quad} \div (-3)$   
 $= \underline{\quad}$

d  $6 \times (-1 - 5) \div 9 = 6 \times \underline{\quad} \div 9$   
 $= \underline{\quad} \div 9$   
 $= \underline{\quad}$

- 3 State the missing numbers to complete the working for these substitutions.

a  $a + 2b$  ( $a = -3, b = 4$ )  
 $a + 2b = -3 + 2 \times 4$   
 $= \underline{\quad} + \underline{\quad}$   
 $= \underline{\quad}$

b  $3 \times (a - b)$  ( $a = 5, b = -1$ )  
 $3 \times (a - b) = 3 \times (5 - (-1))$   
 $= 3 \times \underline{\quad}$   
 $= \underline{\quad}$



### Example 14 Using order of operations

Evaluate the following.

a  $5 - 6 \times (-2)$

b  $-21 \div (5 - (-2))$

c  $2 \times 10^2 \div 5$

#### SOLUTION

a  $5 - 6 \times (-2) = 5 - (-12)$   
 $= 17$

b  $-21 \div (5 - (-2)) = -21 \div 7$   
 $= -3$

#### EXPLANATION

Do the multiplication before the addition and remember that  $5 - (-12) = 5 + 12$ .

Deal with brackets first and remember that  $5 - (-2) = 5 + 2$ .

*Continued on next page*

**SOLUTION**

$$\begin{aligned} \text{c } 2 \times 10^2 \div 5 &= 2 \times 100 \div 5 \\ &= 200 \div 5 \\ &= 40 \end{aligned}$$

**EXPLANATION**

Deal with powers before other operations.  
(Note:  $2 \times 10^2 \neq 20^2$ .)

**Now you try**

Evaluate the following.

$$\text{a } 12 - 15 \div (-3)$$

$$\text{b } (-3 - 5) \times (7 + (-4))$$

$$\text{c } 4 \times 3^2 \div 2$$

**Example 15 Substituting integers**

Substitute the given integers to evaluate the expressions.

$$\text{a } a - 3b \text{ with } a = -2 \text{ and } b = -4$$

$$\text{b } (a + b) \div (-5) \text{ with } a = -7 \text{ and } b = 2$$

$$\text{c } a^2 - b^3 \text{ with } a = -2 \text{ and } b = -3$$

**SOLUTION**

$$\begin{aligned} \text{a } a - 3b &= -2 - 3 \times (-4) \\ &= -2 - (-12) \\ &= -2 + 12 \\ &= 10 \end{aligned}$$

$$\begin{aligned} \text{b } (a + b) \div (-5) &= (-7 + 2) \div (-5) \\ &= -5 \div (-5) \\ &= 1 \end{aligned}$$

$$\begin{aligned} \text{c } a^2 - b^3 &= (-2)^2 - (-3)^3 \\ &= 4 - (-27) \\ &= 4 + 27 \\ &= 31 \end{aligned}$$

**EXPLANATION**

Substitute  $a = -2$  and  $b = -4$  and then evaluate, noting that  $-2 - (-12) = -2 + 12$ .

Substitute  $a = -7$  and  $b = 2$  and then deal with the brackets before the division.

Use brackets when substituting into expressions with powers.

$$(-2)^2 = -2 \times (-2) = 4$$

$$(-3)^3 = -3 \times (-3) \times (-3) = -27$$

**Now you try**

Substitute the given integers to evaluate the expressions.

$$\text{a } 4a + b \text{ with } a = -3 \text{ and } b = -4$$

$$\text{b } a + (b \div (-2)) \text{ with } a = -10 \text{ and } b = -6$$

$$\text{c } a^3 - b^2 \text{ with } a = -2 \text{ and } b = -3$$

## Exercise 1H

### FLUENCY

1, 2-7(1/2)

2-8(1/3)

3-9(1/3)

- Example 14a** 1 Evaluate the following.  
**a**  $4 + 2 \times (-1)$       **b**  $6 + 1 \times (-5)$       **c**  $8 - 2 \times (-3)$       **d**  $10 - 1 \times (-5)$
- Example 14a** 2 Evaluate the following. Remember to use the normal order of operations.  
**a**  $-2 \times 3 \times 5$       **b**  $-6 - 2 \times 3$       **c**  $4 - 8 \times (-1)$   
**d**  $-3 \div (-1) + 7 \times (-2)$       **e**  $6 \times (-2) - 10 \div (-5)$       **f**  $4 + 8 \times (-2) \div (-16)$   
**g**  $20 - 10 \div (-5) \times 2$       **h**  $0 \times (-3) + 2 \times (-30)$       **i**  $35 - 10 \div (-2) + 0$
- Example 14b** 3 Use order of operations to evaluate the following.  
**a**  $3 \times (2 - 4)$       **b**  $(7 - (-1)) \times 3$       **c**  $(-8 + (-2)) \div (-5)$   
**d**  $40 \div (8 - (-2)) + 3$       **e**  $0 \times (38 - (-4)) \times (-6)$       **f**  $-6 \times (-1 + 3) \div (-4)$   
**g**  $((-2) + 1) \times (8 - (-3))$       **h**  $(-6 - 4) \div (50 \div (-10))$       **i**  $-2 \times (8 - 7 \times (-2))$   
**j**  $(3 - (-2) \times 2) \div 7$       **k**  $-4 \times (2 - (-6) \div 6)$       **l**  $-5 \div (1 - 3 \times 2)$
- Example 14c** 4 Use order of operations to evaluate the following.  
**a**  $5 \times 2^2 \div 10$       **b**  $7 + 3^2 \times 2$   
**c**  $(6 - 4^2) \times (-2)$       **d**  $(8 + 1^3) \div (-3)$   
**e**  $2^2 - 3^2$       **f**  $3^3 \div 9 + 1$   
**g**  $15 \div (-1)^3 \times 2$       **h**  $(-2)^3 - 3 \div (-3)$
- Example 15a,b** 5 Evaluate these expressions using  $a = -2$  and  $b = 1$ .  
**a**  $a + b$       **b**  $a - b$       **c**  $2a - b$   
**d**  $b - a$       **e**  $a - 4b$       **f**  $3b - 2a$   
**g**  $b \times (2 + a)$       **h**  $a(2 - b)$       **i**  $(2b + a) - (b - 2a)$
- 6 Evaluate these expressions using  $a = -3$  and  $b = 5$ .  
**a**  $ab$       **b**  $ba$       **c**  $a + b$       **d**  $a - b$   
**e**  $b - a$       **f**  $3a + 2b$       **g**  $(a + b) \times (-2)$       **h**  $(a + b) - (a - b)$
- Example 15c** 7 Evaluate these expressions using  $a = -3$  and  $b = 5$ .  
**a**  $a + b^2$       **b**  $a^2 - b$       **c**  $b^2 - a$       **d**  $b^3 + a$   
**e**  $a^3 - b$       **f**  $a^2 - b^2$       **g**  $b^3 - a^3$       **h**  $(b - a^2)^2$
- 8 Evaluate these expressions using  $a = -4$  and  $b = -3$ .  
**a**  $3a + b$       **b**  $b - 2a$       **c**  $4b - 7a$       **d**  $-2a - 2b$   
**e**  $4 + a - 3b$       **f**  $ab - 4a$       **g**  $-2 \times (a - 2b) + 3$       **h**  $ab - ba$   
**i**  $3a + 4b + ab$       **j**  $a^2 - b$       **k**  $a^2 - b^2$       **l**  $b^3 - a^3$
- 9 Evaluate the following.  
**a**  $3 \times (-2)^2$       **b**  $-2 \times (-2)^3$       **c**  $-16 \div (-2)^3$   
**d**  $-4 + \sqrt{25}$       **e**  $7 - \sqrt{16}$       **f**  $-26 + \sqrt[3]{27}$   
**g**  $-4 + 2 \times \sqrt[3]{8}$       **h**  $-8 \div \sqrt[3]{-64} + 1$       **i**  $-3 \times (-2)^3 + 4$   
**j**  $(3 - (-4)^2) \times (-2)$       **k**  $(\sqrt[3]{-27} + 3) \div (-1)$       **l**  $\sqrt[3]{-8} \times (\sqrt[3]{1000} + 1)$

## PROBLEM-SOLVING

10

10, 11( $\frac{1}{2}$ )10, 11( $\frac{1}{2}$ )

- 10 The temperature in a mountain hut is  $15^{\circ}\text{C}$  at 9 p.m. on Monday night. It drops by  $2^{\circ}\text{C}$  per hour for 11 hours and then the next morning rises by  $1^{\circ}\text{C}$  per hour for the next 4 hours. What is the temperature at midday on Tuesday?



- 11 Insert brackets in these statements to make them true.

a  $-2 + 1 \times 3 = -3$

c  $-8 \div (-1) + 5 = -2$

e  $-4 + (-2) \div 10 + (-7) = -2$

g  $1 - (-7) \times 3 \times 2 = 44$

b  $-10 \div 3 - (-2) = -2$

d  $-1 - 4 \times 2 + (-3) = 5$

f  $20 + 2 - 8 \times (-3) = 38$

h  $4 + (-5) \div 5 \times (-2) = -6$

## REASONING

12

12, 13

12-14

- 12 If  $a$ ,  $b$  and  $c$  are integers, decide whether or not the following equations are always true.

a  $(a + b) + c = a + (b + c)$

c  $(a \times b) \times c = a \times (b \times c)$

e  $a - b = b - a$

b  $(a - b) - c = a - (b - c)$

d  $(a \div b) \div c = a \div (b \div c)$

f  $-(a - b) = b - a$

- 13 We can write  $(a + b) \div c$  without brackets in the form  $\frac{a+b}{c}$ . Evaluate these expressions if

$a = -5$ ,  $b = -3$  and  $c = -2$ .

a  $\frac{a+b}{c}$

b  $\frac{a-b}{c}$

c  $\frac{2c-5a}{b}$

d  $\frac{-c-2a}{b}$

- 14 We can use brackets within brackets for more complex expressions. The inside brackets are dealt with first. Evaluate these.

a  $(-6 \times (-2 + 1) + 3) \times (-2)$

b  $(2 - (3 - (-1))) \times (-2)$

c  $-10 \div (2 \times (3 - (-2)))$

## ENRICHMENT: Tricky brackets

-

-

15-17

- 15 Insert one or more sets of brackets to make these statements true.

a  $1 - 3 \times (-4) \div (-13) = -1$

c  $6 - 7 \div (-7) + 6 = 1$

b  $4 \div 3 + (-7) \times (-5) = 5$

d  $-1 - 5 + (-2) \times 1 - 4 = 8$

- 16 By inserting one extra set of brackets, how many different answers could be obtained from  $-4 \times 3 - (-2) + 8$ ?

- 17 Make up your own statement like that in Question 16 and then remove any brackets. Ask a friend to see if they can find where the brackets should go.

## Selling garden gnomes

Wilbur buys garden gnomes from a local supplier and sells them for profit. There are three sizes of garden gnomes:

Type	Cost price	Selling price
Small	\$5	\$8
Medium	\$7	\$11
Large	\$10	\$15

Wilbur sets up a balance sheet to keep track of his expenditure and revenue. The following incomplete example shows six transactions starting from an initial balance of \$0. Negative numbers are used to indicate money leaving his account, and positive numbers are used for money entering his account.

Transaction	Unit price	Effect on balance	Balance (initially \$0)
Purchase 20 small	\$5	−\$100	−\$100
Purchase 15 medium	\$7	−\$105	−\$205
Sell 4 medium	\$11	+\$44	−\$161
Purchase 10 large	\$10	−\$100	−\$261
Sell 2 large	\$15	+\$30	−\$231
Sell 6 small	\$8		

Present a report for the following tasks and ensure that you show clear mathematical workings and explanations where appropriate.

### Preliminary task

- Explain why the balance after the first transaction on the balance sheet is −\$100.
- Explain why the balance after the third transaction on the balance sheet is −\$161.
- The table above has two missing numbers in the bottom right corner.
  - What is the effect on Wilbur's balance when he sells 6 small garden gnomes?
  - What is the new balance after he sells these garden gnomes?
- If Wilbur purchases a further 12 medium garden gnomes from the supplier, determine the balance at the end of this transaction.

### Modelling task

#### Formulate

- The problem is to determine sales targets so that Wilbur will be in profit (with a positive balance) at the end of a month. Write down all the relevant information that will help solve this problem.
- Draw up an empty balance sheet using the same headings as the example above. Allow 11 rows for transactions but leave all the rows blank so that a fresh set of transactions can be made. You can assume his initial balance is \$0.

Solve

For part of one particular month, Wilbur makes the following garden gnome purchases and sales.

- Purchases 30 small
- Purchases 25 medium
- Sells 9 small
- Purchases 15 large
- Sells 15 medium
- Sells 6 small
- Sells 3 large
- Purchases 10 medium
- Sells 9 large
- Sells 12 small
- Sells 6 medium

- c** Enter these transactions into your balance sheet and calculate the balance after each transaction.
- d** State the final balance after the above transactions are completed.
- e** Decide how many garden gnomes of each type are remaining in Wilbur's stock at the end of the month. (You can assume that he started with no garden gnomes of any size.)
- f** If Wilbur is able to sell all the remaining stock of garden gnomes in the month without making any further purchases, determine the total profit at the end of the month.
- g** By considering the balance position from part **d** above, determine one combination of sales using any garden gnomes in the remaining stock such that Wilbur will make between \$200 and \$250 profit in the month. Justify your answer with appropriate calculations.
- h** Wilbur wants to make a profit at the end of the month as close to \$200 as possible. Choose a combination of garden gnomes that he can sell to achieve this. Justify your choice with working. Is it possible to achieve a balance equal to \$200 exactly?
- i** Summarise your results and describe any key findings.

Evaluate and verify

Communicate

### Extension questions

- a** If Wilbur could only sell garden gnomes in sets of 3 of the same type, determine how close he can get to \$200 profit for the month. Assume the position from Modelling task part **d** above.
- b** If from the beginning, Wilbur could only buy garden gnomes in multiples of 5 and sell in multiples of 3, describe a set of 10 transactions that would result in a \$200 balance at the end of the month.



## Integer tug of war

### Key technology: Programming and spreadsheets

In a game of tug of war, a rope is pulled in opposite directions by two teams. The centre of the rope is marked by a ribbon and starts at position zero. The winning team will move the ribbon a given distance in their direction. In this activity, we will use a number line to record the position of the ribbon where one team is pulling in the positive direction and the other in the negative direction. The winner is the team to move the ribbon past a particular point.

### 1 Getting started

Let's play a game of tug of war with two teams of equal ability. *Team Pos* tries to pull to the right on this number line and *Team Neg* tries to pull to the left. We will assume that either team can successfully move up to 3 units in their direction on any given 3-second interval.

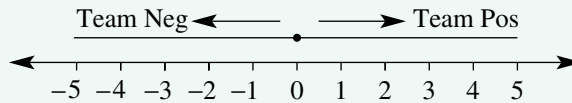

- a** Use a random number generator to generate a move up to 3 units left or right: Suggestions:
- Spreadsheet: =RANDBETWEEN (-3, 3)
  - CAS: RandInt (-3, 3)
- b** Continue to create random moves left or right with your random number generator and add your results into this table. (Your numbers inserted into row 3 onwards will be different from the sample shown here.)

Random number	Position of ribbon
Start	0
-2	-2
1	-1
2	1

- c** Assume that if the ribbon reaches  $-5$  or  $5$  then *Team Neg* or *Team Pos* wins. Continue adding to your table until the position of the ribbon is at either  $-5$  or  $5$ . Which team has won your tug of war?

### 2 Applying an algorithm

- a** Study this flow chart which describes an algorithm for playing the tug of war game outlined in part 1 above. Describe what you think the variables  $i$ ,  $a$  and  $b$  represent.
- b** Complete this table showing the values of  $i$ ,  $a$  and  $b$  through each pass of the loop using your random number generator to calculate the value of  $a$  each time. Keep going until  $b$  reaches  $-5$  or  $5$  or  $i = 10$ .

Pass	$i$	$a$	$b$
Initial	0	-	0
1			
2			
...			

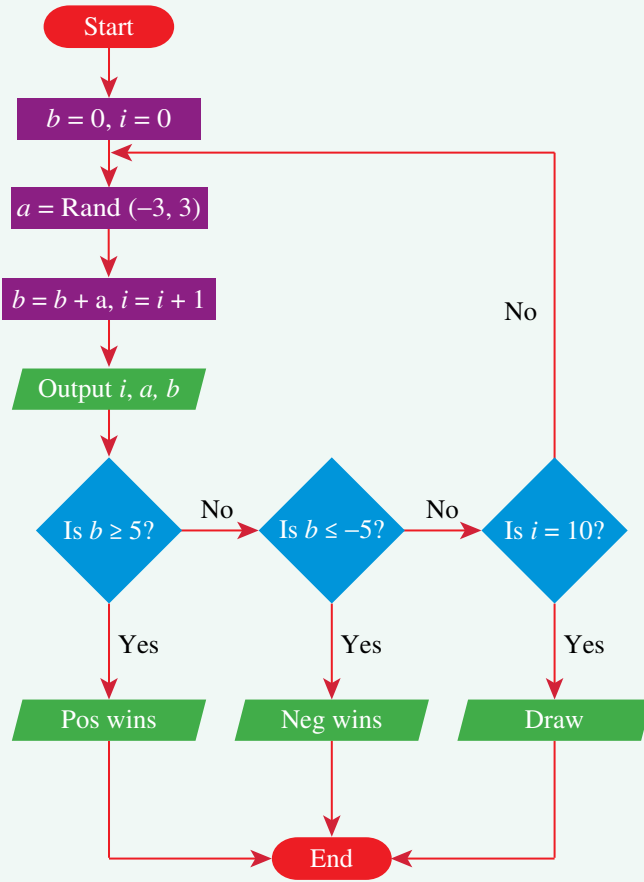

### 3 Using technology

We will use a spreadsheet to simulate the playing of the above tug of war game but this time the ribbon needs to be pulled through to  $-10$  or  $+10$  for one of the teams to win.

**a** Enter the following into a spreadsheet.

	A	B	C	D	E
1	Integer	tug of war		Result	=IF(C25="Continue","Draw","Win")
2					
3	Pass	Balance point	Status	Pos win?	Neg win?
4					
5	0	0	Start		
6	=A5+1	=B5+RANDBETWEEN(-3,3)	=IF(OR(B6>=10,B6<=-10,C5="Stop"),"Stop","Continue")	=IF(OR(B6>=10,D5="Pos wins"),"Pos wins","")	=IF(OR(B6<=-10,E5="Neg wins"),"Neg wins","")

- b** Fill down at cells A6, B6, C6, D6 and E6 up to and including row 25. This will mean that 20 passes have taken place.
- c** Enter the formula in cell E1. What do you think this formula does?
- d** Press Function F9 to run another game of tug of war. Repeat for a total of 10 games and record how many times Team Pos wins, Team Neg wins or there is a Draw.



## 4 Extension

- a The spreadsheet on the previous page simulates a game of tug of war where the ribbon could move up to 3 units in either direction at each pass. Change the information in cell B6 so that the ribbon could move up to 5 units in either direction. Fill down and use Function F9 to repeat the game. What do you notice about the number of times the game ends in a draw?
- b Adjust your spreadsheet so that it can account for a team's known strength. For example, if *Team Pos* is known to be stronger than *Team Neg*, then the random number selection could be set to range between  $-3$  and  $4$ . Experiment with these numbers and note the number of wins for each team and the number of draws. Explain how changing the range of random numbers impacts on the outcome of the game.
- c Try using a programming language like Python to code the tug of war algorithm on the previous page, then play the game with your program.



## Euclidean division algorithm

The Euclidean division algorithm is a method for finding the highest common factor (also called the greatest common divisor) of two numbers. It is a method that can be performed by hand or programmed into a computer to quickly find the result. Euclid, the famous Greek mathematician, first published the algorithm in his well-known books titled *Elements* in about 300 BCE. The algorithm is used today in many mathematical situations. It is also an important part of today's public key encryption method that is used to code and decipher electronic information in the world of commerce.

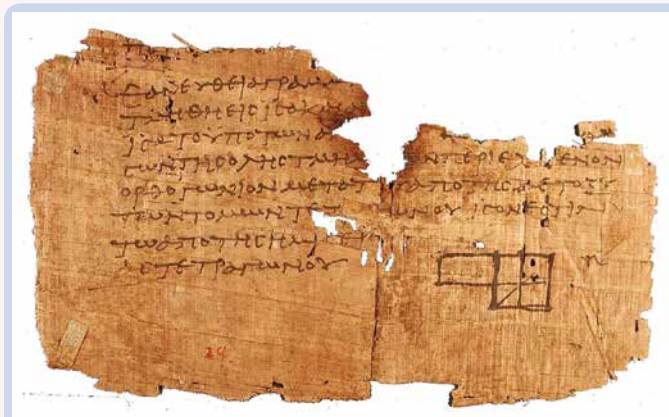

This is a fragment of an Egyptian papyrus from a nearly 2000-year-old copy of Euclid's *Elements*, written in ancient Greek. The diagram shows that the text concerns the relationship of squares and rectangles derived from a straight line divided into unequal parts.

Source: Bill Casselman

In simple terms, this is how the algorithm works.

- Let the two numbers be  $a$  and  $b$  where  $a > b$ .
- Let  $c = a - b$ .
- Let the new  $a$  and  $b$  be the smallest pair from the previous  $a$ ,  $b$  and  $c$ . Make  $a > b$ .
- Repeat the above two steps until  $a = b$ . The HCF is the value of  $a$  (or  $b$ ) at this point.
- If  $a - b = 1$ , then the HCF = 1.

The algorithm uses the fact that if two numbers  $a$  and  $b$  have a common divisor, then  $a - b$  will also have the same common divisor.

### Examples

- 1 Find the HCF of 12 and 30.

Step	$a$	$b$	$a - b = c$
1	30	12	$30 - 12 = 18$
2	18	12	$18 - 12 = 6$
3	12	6	$12 - 6 = 6$
4	6	6	0

The HCF of 12 and 30 is therefore 6.

- 2 Find the HCF of 7 and 15.

Step	$a$	$b$	$a - b = c$
1	15	7	$15 - 7 = 8$
2	8	7	$8 - 7 = 1$

The HCF of 7 and 15 is therefore 1.

### Using the algorithm

- 3 Use the Euclidean division algorithm to find the HCF of these pairs of numbers. Set your steps out in a table similar to Questions 1 and 2.

a 12 and 8

b 13 and 29

c 42 and 24

d 184 and 136

e 522 and 666

f 91 and 137

### Using a spreadsheet

- 4 a Set up a spreadsheet using the formulas shown. Leave the cells A1 and B1 empty, as this is where you will enter your two starting numbers.

	A	B	C	D
1			=A1-B1	
2	=MEDIAN(A1,B1,C1)	=MIN(A1,B1,C1)		

- b Enter the two numbers 30 and 12 into cells A1 and B1. Put the larger number into A1. Now fill down each formula until the value in column C is 0. The HCF is therefore 6.

	A	B	C
1	30	12	18
2	18	12	6
3	12	6	6
4	6	6	0

- c Enter the two numbers 15 and 7 into cells A1 and B1. Put the larger number into A1. Now fill down each formula until the value in column C is 1. The HCF is therefore 1.

	A	B	C
1	15	7	8
2	8	7	1

- d Test your spreadsheet on the pairs of numbers that you worked out by hand in Question 3 above. Here they are again.
- i 12 and 8                                      ii 13 and 29                                      iii 42 and 24
- iv 184 and 136                                      v 522 and 666                                      vi 91 and 137
- e Now choose a pair of large numbers and use your spreadsheet to find the HCF.

- List the numbers less than 50 that are the product of two prime numbers.
- Two squares have side lengths 5 cm and 12 cm. Determine the side length of a single square with an area equal to the combined area of these two squares.
  - Three cubes have side lengths 1 cm, 6 cm and 8 cm. Determine the side length of a single cube equal in volume to the combined volume of these three cubes.
- What is the smallest number divisible by all the digits 2, 3, 4, 5, 6, 7, 8 and 9?
- Evaluate the following expressions, given  $x = -2$  and  $y = -5$ .
  - $y + y^2 + y^3$
  - $10 - 2(y - x)$
  - $60 + 3(x^3 - y^2)$
- The brackets are missing from these statements. Insert brackets to make them true.
  - $-5 \times 3 \div (-3) + 2 - 4 + (-3) = 26$
  - $-100 \div 4 \times (-2) - 2 \times 3 - (-2) = 32$
- $n!$  ( $n$  factorial)  $= n \times (n - 1) \times (n - 2) \times \dots \times 3 \times 2 \times 1$ , for example,  $5! = 5 \times 4 \times 3 \times 2 \times 1 = 120$ . Evaluate these without the use of a calculator.
  - $6! \div 5!$
  - $1000! \div 999!$
  - $15! \div 13!$
  - $5! - 4!$
- Find a rule linking  $y$  and  $x$  in each table. Make  $y$  the subject of each, e.g.  $y = -2x + 3$ .

a

$x$	$y$
-7	10
-6	9
-5	8
-4	7

c

$x$	$y$
-5	-121
-3	-23
-1	3
1	5

b

$x$	$y$
-4	13
-3	6
-2	1
-1	-2

d

$x$	$y$
-27	-7
-8	-5
-1	-3
1	1

- Determine the remainder when each of the following numbers is divided by 5.
  - $4^{567} + 1$
  - $4^{678} + 1$
- Two different prime numbers,  $a$  and  $b$ , are both less than 8. Determine which values of  $a$  and  $b$  give the largest HCF of  $3a^2b$  and  $2ab^2$  and state the value of the HCF.

Up for a challenge? If you get stuck on a question, check out the 'Working with unfamiliar problems' poster at the end of the book to help you.



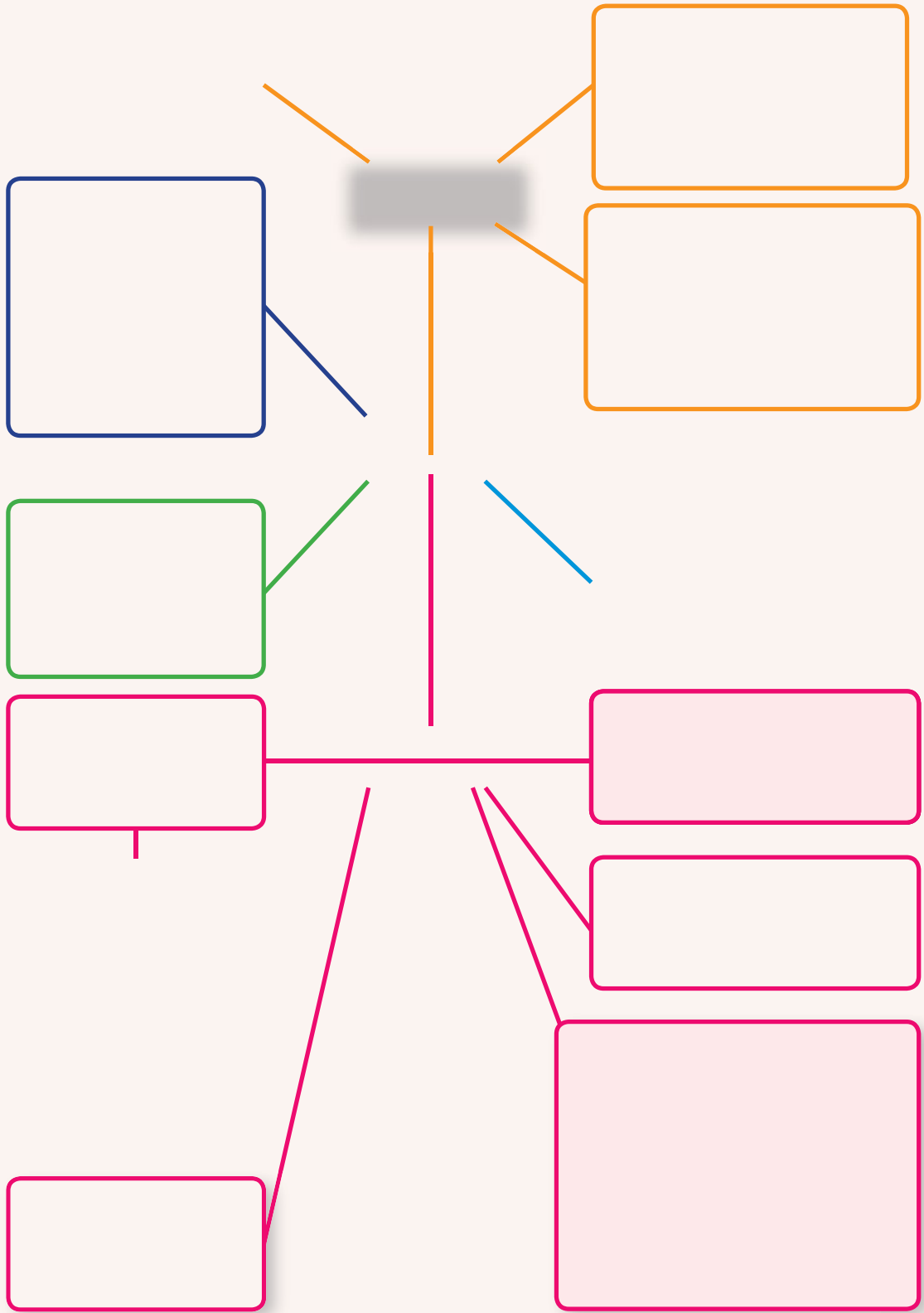

# Chapter checklist with success criteria

A printable version of this checklist is available in the Interactive Textbook



1A	<b>1. I can use mental addition and subtraction techniques effectively.</b> e.g. Evaluate $347 - 39$ and $125 + 127$ mentally.	<input type="checkbox"/>
1A	<b>2. I can use the addition and subtraction algorithms with whole numbers.</b> e.g. Find $938 + 217$ and $141 - 86$ by first aligning the digits vertically.	<input type="checkbox"/>
1B	<b>3. I can use mental multiplication and division techniques effectively.</b> e.g. Find $5 \times 160$ and $464 \div 8$ mentally.	<input type="checkbox"/>
1B	<b>4. I can use multiplication and division algorithms with whole numbers.</b> e.g. Use an algorithm to evaluate $412 \times 25$ and $938 \div 13$ .	<input type="checkbox"/>
1C	<b>5. I can find the lowest common multiple (LCM) and highest common factor (HCF) of two whole numbers.</b> e.g. Find the LCM of 6 and 8, and find the HCF of 36 and 48.	<input type="checkbox"/>
1C	<b>6. I can find the square and cube of whole numbers.</b> e.g. Find $6^2$ and $2^3$ .	<input type="checkbox"/>
1C	<b>7. I can find the square root and cube root of certain small whole numbers.</b> e.g. Find $\sqrt{81}$ and $\sqrt[3]{64}$ .	<input type="checkbox"/>
1D	<b>8. I can write a number as the product of prime factors using a factor tree.</b> e.g. Write 540 as a product of prime factors.	<input type="checkbox"/>
1D	<b>9. I can use divisibility tests to determine if a number is divisible by 2, 3, 4, 5, 6, 8 and/or 9.</b> e.g. Decide whether 627 is divisible by 2, 3, 4, 5, 6, 8 or 9.	<input type="checkbox"/>
1D	<b>10. I can find the lowest common multiple (LCM) and highest common factor (HCF) of two whole numbers using prime factorisation.</b> e.g. Find the LCM and HCF of 105 and 90, using prime factorisation.	<input type="checkbox"/>
1E	<b>11. I can add and subtract positive integers.</b> e.g. Evaluate $-5 + 2$ and $-2 - 3$ .	<input type="checkbox"/>
1F	<b>12. I can add and subtract negative integers.</b> e.g. Evaluate $-3 + (-5)$ and $-11 - (-6)$ .	<input type="checkbox"/>
1G	<b>13. I can find the product and quotient of integers.</b> e.g. Evaluate $3 \times (-7)$ and $-121 \div (-11)$ .	<input type="checkbox"/>
1G	<b>14. I can combine multiplication and division, working from left to right.</b> e.g. Evaluate $-2 \times 9 \div (-3) \times (-5)$ .	<input type="checkbox"/>
1H	<b>15. I can use order of operations to evaluate numerical expressions.</b> e.g. Evaluate $-21 \div (5 - (-2))$ .	<input type="checkbox"/>
1H	<b>16. I can substitute integers in to evaluate algebraic expressions.</b> e.g. Evaluate $a^2 - b^3$ with $a = -2$ and $b = -3$ .	<input type="checkbox"/>

## Short-answer questions

1A

1 Use a mental strategy to evaluate the following.

- a  $324 + 173$                       b  $592 - 180$                       c  $89 + 40$                       d  $135 - 68$   
 e  $55 + 57$                       f  $280 - 141$                       g  $1001 + 998$                       h  $10000 - 4325$

1A

2 Use a mental strategy to find these sums and differences.

- a  $\begin{array}{r} 392 \\ + 147 \\ \hline \end{array}$                       b  $\begin{array}{r} 1031 \\ + 999 \\ \hline \end{array}$                       c  $\begin{array}{r} 147 \\ - 86 \\ \hline \end{array}$                       d  $\begin{array}{r} 3970 \\ - 896 \\ \hline \end{array}$

1B

3 Use a mental strategy for these products and quotients.

- a  $2 \times 17 \times 5$                       b  $3 \times 99$                       c  $8 \times 42$                       d  $141 \times 3$   
 e  $164 \div 4$                       f  $357 \div 3$                       g  $618 \div 6$                       h  $1005 \div 5$

1B

4 Find these products and quotients using an algorithm.

- a  $\begin{array}{r} 139 \\ \times 12 \\ \hline \end{array}$                       b  $\begin{array}{r} 507 \\ \times 42 \\ \hline \end{array}$                       c  $3 \overline{)843}$                       d  $7 \overline{)854}$

1B

5 Find the remainder when 673 is divided by these numbers.

- a 5                      b 3                      c 7                      d 9

1C

6 Evaluate:

- a  $\sqrt{81}$                       b  $\sqrt{121}$                       c  $7^2$                       d  $20^2$   
 e  $\sqrt[3]{27}$                       f  $\sqrt[3]{64}$                       g  $5^3$                       h  $10^3$

1C

- 7 a Find all the factors of 60.  
 b Find all the multiples of 7 between 110 and 150.  
 c Find all the prime numbers between 30 and 60.  
 d Find the LCM of 8 and 6.  
 e Find the HCF of 24 and 30.

1D

8 Write these numbers in prime factor form. You may wish to use a factor tree.

- a 36                      b 84                      c 198

1D

9 Use divisibility tests to decide if these numbers are divisible by 2, 3, 4, 5, 6, 8 or 9.

- a 84                      b 155                      c 124                      d 621

1D

10 Write the numbers 20 and 38 in prime factor form and then use this to help find the following.

- a LCM of 20 and 38                      b HCF of 20 and 38

1E

11 Evaluate:

- a  $-6 + 9$                       b  $-24 + 19$                       c  $5 - 13$                       d  $-7 - 24$   
 e  $-62 - 14$                       f  $-194 - 136$                       g  $-111 + 110$                       h  $-328 + 426$

1F

12 Evaluate:

- a  $5 + (-3)$                       b  $-2 + (-6)$                       c  $-29 + (-35)$                       d  $162 + (-201)$   
 e  $10 - (-6)$                       f  $-20 - (-32)$                       g  $-39 - (-19)$                       h  $37 - (-55)$

1F/G

13  $a$  and  $b$  are both negative integers with  $a > b$ . Classify these as true or false.

- a  $b < a$                       b  $a + b > 0$                       c  $a \times b < 0$                       d  $a \div b > 0$

1G

14 Evaluate these expressions.

a  $-5 \times 2$

b  $-11 \times (-8)$

c  $9 \times (-7)$

d  $-100 \times (-2)$

e  $-10 \div (-5)$

f  $48 \div (-16)$

g  $-32 \div 8$

h  $-81 \div (-27)$

1H

15 Evaluate using the order of operations.

a  $2 + 3 \times (-2)$

b  $-3 \div (11 + (-8))$

c  $-2 \times 3 + 10 \div (-5)$

d  $-20 \div 10 - 4 \times (-7)$

e  $5 \times (-2 - (-3)) \times (-2)$

f  $0 \times (-2 + 11 \times (-3)) + (-1)$

g  $-19 \div (-18 - 1) \div (-1)$

h  $15 \div (-2 + (-3)) + (-17)$

1H

16 Let  $a = -2$ ,  $b = 3$  and  $c = -5$  and evaluate these expressions.

a  $ab + c$

b  $a^2 - b$

c  $ac - b$

d  $abc$

e  $a^3 - bc$

f  $c^3 - b$

g  $bc \div b$

h  $5b^3 - 2c$

## Multiple-choice questions

1A

1 127 - 79 is the same as:

A  $127 - 80 - 1$

B  $127 - 80 + 1$

C  $127 - 100 + 19$

D  $127 - 70 + 9$

E  $130 - 80 + 1$

1A

2 The sum and difference of 291 and 147 are:

A 448 and 154

B 428 and 156

C 438 and 144

D 338 and 144

E 438 and 154

1A/B

3 Which of these four statements is/are true?

i  $3 - 1 = 1 - 3$

ii  $15 \div 5 = 5 \div 15$

iii  $89 \times 3 = 90 \times 3 - 1 \times 3$

iv  $171 + 50 = 170 + 50 - 1$

A i and iii

B ii and iv

C i, ii and iii

D iv only

E iii only

1B

4 This division problem gives no remainder.

$$\begin{array}{r} 46 \\ 6 \overline{)2\boxed{\phantom{0}}6} \end{array}$$

The missing number is:

A 2

B 3

C 4

D 6

E 7

1C

5 The HCF and LCM (in that order) of 21 and 14 are:

A 7 and 14

B 14 and 21

C 42 and 7

D 7 and 28

E 7 and 42



- 1E** 6 The temperatures of two countries on a particular day are  $-13^{\circ}\text{C}$  and  $37^{\circ}\text{C}$ . The difference between the two temperatures is:  
**A**  $40^{\circ}\text{C}$       **B**  $36^{\circ}\text{C}$       **C**  $50^{\circ}\text{C}$       **D**  $46^{\circ}\text{C}$       **E**  $24^{\circ}\text{C}$
- 1F** 7 The missing number in the statement  $-4 - \underline{\quad} = -1$  is:  
**A**  $-3$       **B**  $3$       **C**  $5$       **D**  $-6$       **E**  $-5$
- 1G** 8 The missing number in the statement  $\underline{\quad} \div (-7) = 8$  is:  
**A**  $42$       **B**  $-42$       **C**  $-6$       **D**  $56$       **E**  $-56$
- 1H** 9  $-9 \times (-6 + (-2)) \div (-12)$  is equal to:  
**A**  $6$       **B**  $-6$       **C**  $-3$       **D**  $-3$       **E**  $-4$
- 1G** 10 Two negative numbers add to  $-5$  and their product is  $6$ . The two numbers are:  
**A**  $-3, 2$       **B**  $-4, -1$       **C**  $-5, -1$       **D**  $-3, -2$       **E**  $-7, -2$

## Extended-response questions

- 1 A monthly bank account show deposits as positive numbers and purchases and withdrawals (P + W) as negative numbers.

Details	P + W	Deposits	Balance
Opening balance	–	–	\$250
Water bill	–\$138	–	$a$
Cash withdrawal	–\$320	–	$b$
Deposit	–	$c$	\$115
Supermarket	$d$	–	–\$160
Deposit	–	–\$400	$e$

- a** Find the values of  $a$ ,  $b$ ,  $c$ ,  $d$  and  $e$ .  
**b** If the water bill amount was \$150, what would be the new value for letter  $e$ ?  
**c** What would the final deposit need to be if the value for  $e$  was \$0? Assume the original water bill amount is \$138 as in the table above.
- 2 Two teams compete at a club games night. Team A has 30 players while team B has 42 players.
- a** How many players are there in total?  
**b** Write both 30 and 42 in prime factor form.  
**c** Find the LCM and HCF of the number of players representing the two teams.  
**d** Teams are asked to divide into groups with equal numbers of players. What is the largest group size possible if team A and team B must have groups of the same size?  
**e** In a game of ‘scissors, paper, rock’, each team forms a line in single file. Player 1 from team A plays against player 1 from team B, then the second pair play against each other, and so on. Once each game is complete, the players go to the back of their line. How many games are played before the first pair plays each other again?

# 2

## Angle relationships and properties of geometrical figures

### Maths in context: Bees build dodecahedrons

Bees are skilled architects. Worker bees digest honey and secrete wax scales from glands on their abdomen. Builder bees collect these wax scales, and, using their mouth parts, they chew, soften, and plaster the wax, constructing a cylinder around their bodies. Each cylinder cell is joined to six other cylinder cells, with three cells connected at each join.

Heater bees now enter the cylindrical cells. By vibrating their powerful flight muscles, they heat the wax to  $45^{\circ}\text{C}$ . As the wax at the joins slowly cools, it contracts, pulling its three joined walls inwards, to itself. Two consecutive joins set up a tension in the wall between them from their opposing contraction

forces. Hence, stable hexagonal-shaped cells are formed, each with six walls.

Bee honeycomb cells have a hexagonal cross-section. However, the cells are not exactly a hexagonal prism. At the top and bottom there are three rhombus-shaped faces joined together, forming angles of  $120^{\circ}$  with the other sides of the honeycomb cell. Hence, each fully closed cell is actually a dodecahedron (12-faced polyhedron). The cells are a very efficient geometrical construction, having the least surface area to contain a given volume of honey.



## Chapter contents

- 2A Reviewing angles (CONSOLIDATING)
- 2B Transversal lines and parallel lines (CONSOLIDATING)
- 2C Triangles (CONSOLIDATING)
- 2D Quadrilaterals
- 2E Polygons (EXTENDING)
- 2F Three-dimensional solids and Euler's formula (EXTENDING)
- 2G Three-dimensional coordinate systems

## Victorian Curriculum 2.0

This chapter covers the following content descriptors in the Victorian Curriculum 2.0:

### SPACE

VC2M8SP02, VC2M8SP03

Please refer to the curriculum support documentation in the teacher resources for a full and comprehensive mapping of this chapter to the related curriculum content descriptors.

© VCAA

## Online resources

A host of additional online resources are included as part of your Interactive Textbook, including HOTmaths content, video demonstrations of all worked examples, auto-marked quizzes and much more.

## 2A Reviewing angles CONSOLIDATING

### LEARNING INTENTIONS

- To know the meaning of the terms: complementary, supplementary, vertically opposite and perpendicular
- To be able to classify angles as acute, right, obtuse, straight, reflex or a revolution
- To be able to relate compass bearings to angles
- To be able to determine the angles at a point using angle properties

For more than 2000 years, geometry has been based on the work of Euclid, the Greek mathematician who lived in Egypt in about 300 BCE. Before this time, the ancient civilisations had demonstrated and documented an understanding of many aspects of geometry, but Euclid was able to produce a series of 13 books called *Elements*, which contained a staggering 465 propositions. This great work is written in a well-organised and structured form, carefully building on solid mathematical foundations. The most basic of these foundations, called axioms, are fundamental geometric principles from which all other geometry can be built. There are five axioms described by Euclid:

- Any two points can be joined by a straight line.
- Any finite straight line (segment) can be extended in a straight line.
- A circle can be drawn with any centre and any radius.
- All right angles are equal to each other.
- Given a line and a point not on the line, there is only one line through the given point and in the same plane that does not intersect the given line.

These basic axioms are considered to be true without question and do not need to be proven. All other geometrical results can be derived from these axioms.

### Lesson starter: Create a sentence or definition

The five pronumerals  $a$ ,  $b$ ,  $c$ ,  $d$  and  $e$  represent the size of five angles in this diagram. Can you form a sentence using two or more of these pronumerals and one of the following words? Using simple language, what is the meaning of each of your sentences?

- Supplementary
- Adjacent
- Vertically opposite
- Revolution
- Complementary
- Right

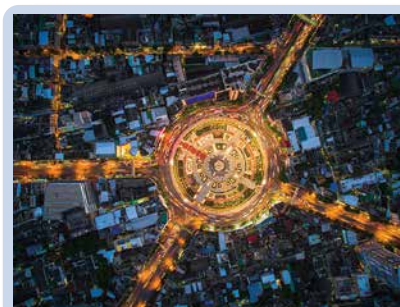
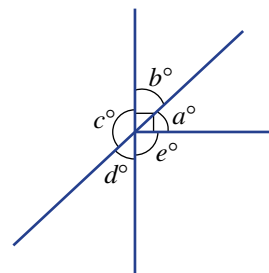

Surveyors check that the angles between the roads from a roundabout add to  $360^\circ$ . Where straight roads intersect, a surveyor can check angle measurements using the rules for vertically opposite and supplementary angles.

### KEY IDEAS

- The angle shown (to the right) could be named  $\angle ABC$ ,  $\angle CBA$ ,  $\angle B$  or  $\widehat{ABC}$ .
  - The size of the angle is  $b^\circ$ .

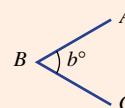

Types of angles

**Acute** ( $0-90^\circ$ )

**Straight** ( $180^\circ$ )

**Right** ( $90^\circ$ )

**Reflex** ( $180-360^\circ$ )

**Obtuse** ( $90-180^\circ$ )

**Revolution** ( $360^\circ$ )

Special pairs of angles at a point include:

- **Complementary** angles (sum to  $90^\circ$ )  $a + b = 90$

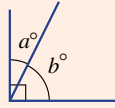

- **Supplementary** angles (sum to  $180^\circ$ )  $a + b = 180$

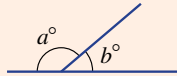

- **Vertically opposite** angles are formed when two lines intersect.

$a = b$  and  $c = d$  (two pairs of vertically opposite angles)

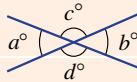

Angles in a **revolution** sum to  $360^\circ$ .

Two lines are **perpendicular** if they are at right angles ( $90^\circ$ ).

Eight point compass bearing

- Bearings are usually measured clockwise from north.

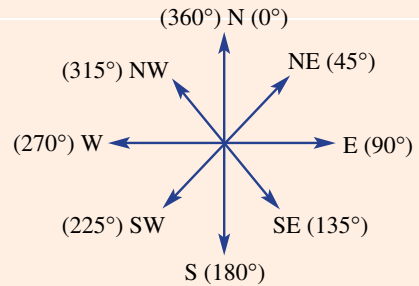

**BUILDING UNDERSTANDING**

1 State the missing word to complete these sentences for this diagram.

- a  $b^\circ$  and  $c^\circ$  \_\_\_\_\_ are angles.
- b  $a^\circ$  and  $e^\circ$  are \_\_\_\_\_ angles.
- c  $a^\circ, b^\circ, c^\circ, d^\circ$  and  $e^\circ$  form a \_\_\_\_\_.

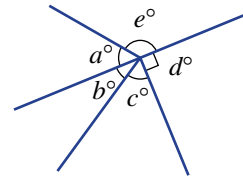

2 State the value of the pronumeral (letter) in these diagrams.

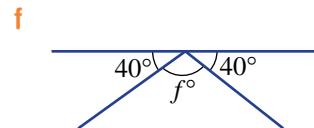
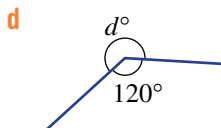
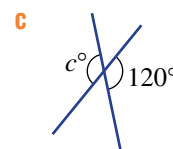
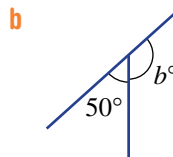
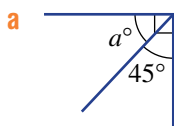

3 Estimate the size of these angles.

- a  $\angle AOB$
- b  $\angle AOC$
- c Reflex  $\angle AOE$

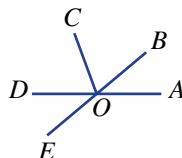



### Example 1 Finding angles at a point

Determine the value of the pronumerals in these diagrams.

**a**

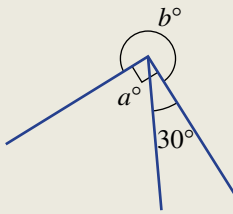

**b**

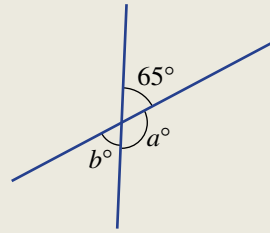

#### SOLUTION

**a**  $a + 30 = 90$  (angles in a right angle)

$$a = 60$$

$b + 90 = 360$  (angles in a revolution)

$$b = 270$$

**b**  $a + 65 = 180$  (angles on a straight line)

$$a = 115$$

$b = 65$  (vertically opposite angles)

#### EXPLANATION

$a^\circ$  and  $30^\circ$  are the sizes of two angles which make a complementary pair, adding to  $90^\circ$ .

Angles in a revolution add to  $360^\circ$ .

$a^\circ$  and  $65^\circ$  are the sizes of two angles which make a supplementary pair, adding to  $180^\circ$ .

The  $b^\circ$  and  $65^\circ$  angles are vertically opposite.

#### Now you try

Determine the value of the pronumerals in these diagrams.

**a**

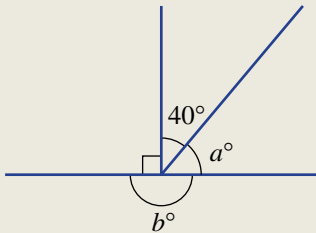

**b**

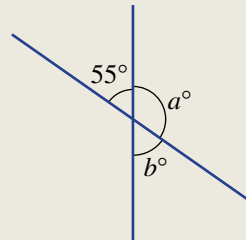

# Exercise 2A

**FLUENCY**      1, 2(1/2), 3, 4(1/2)      2(1/2), 3, 4-5(1/2)      2-5(1/2)

**Example 1a** 1 Determine the value of the pronumerals in these diagrams.

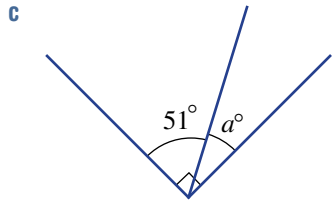
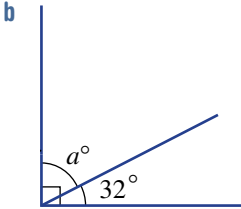
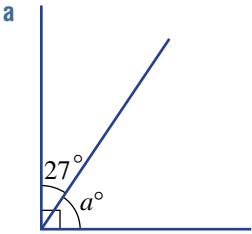

**Example 1** 2 Determine the value of the pronumerals in these diagrams.

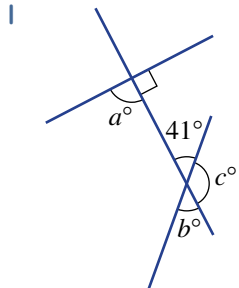
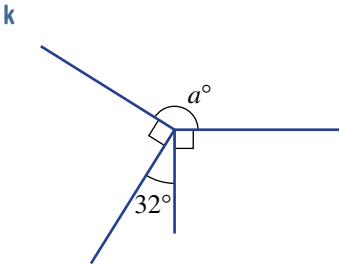
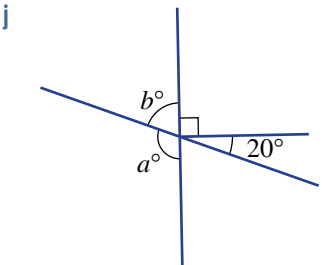
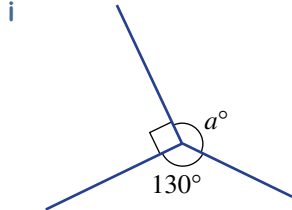
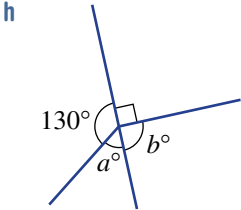
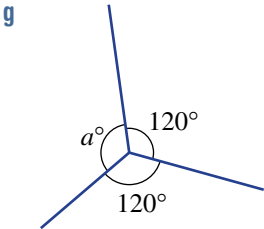
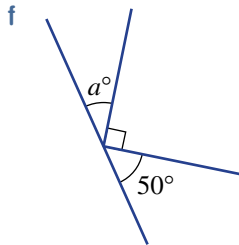
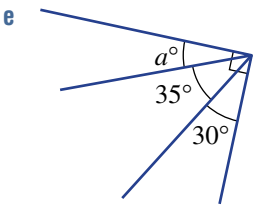
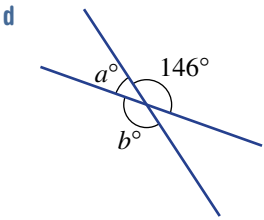
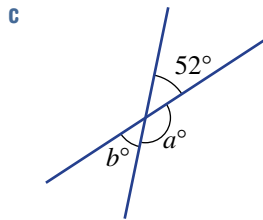
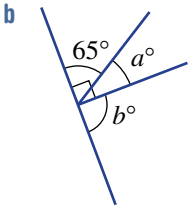
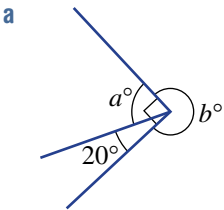

3 For the angles in this diagram, name an angle that is:

- a vertically opposite to  $\angle AOB$ .
- b complementary to  $\angle BOC$ .
- c supplementary to  $\angle AOE$ .
- d supplementary to  $\angle AOC$ .

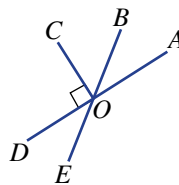

4 Give the compass bearing, in degrees, for these directions.

- a West (W)                      b East (E)                      c North (N)                      d South (S)
- e NW                              f SE                              g SW                              h NE

5 In which direction (e.g. north-east or NE) would you be walking if you were headed on these compass bearings?

- a  $180^\circ$                       b  $360^\circ$                       c  $270^\circ$                       d  $90^\circ$
- e  $45^\circ$                       f  $315^\circ$                       g  $225^\circ$                       h  $135^\circ$

### PROBLEM-SOLVING

6, 7( $\frac{1}{2}$ )6, 7–8( $\frac{1}{2}$ )7–8( $\frac{1}{2}$ )

6 A round birthday cake is cut into sectors for nine friends (including Jack) at Jack's birthday party. After the cake is cut there is no cake remaining. What will be the angle at the centre of the cake for Jack's piece if:

- a everyone receives an equal share?
- b Jack receives twice as much as everyone else? (In parts b, c and d, assume his friends have equal shares of the rest.)
- c Jack receives four times as much as everyone else?
- d Jack receives ten times as much as everyone else?

7 Find the value of  $a$  in these diagrams.

a

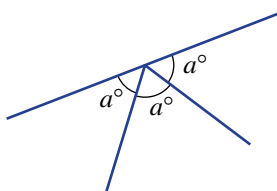

b

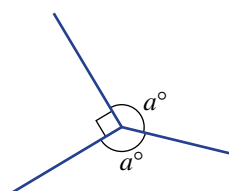

c

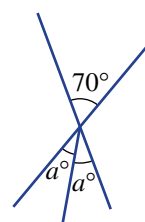

d

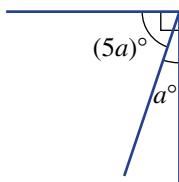

e

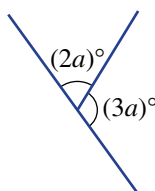

f

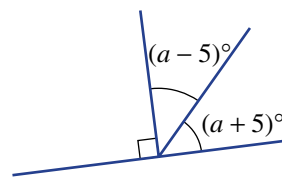

8 What is the smaller angle between the hour hand and minute hand on a clock at these times?

- a 2:30 p.m.                      b 5:45 a.m.                      c 1:40 a.m.                      d 10:20 p.m.
- e 2:35 a.m.                      f 12:05 p.m.                      g 4:48 p.m.                      h 10:27 a.m.



REASONING

9

9, 10

10, 11

9 Explain, with reasons, what is wrong with these diagrams.

a

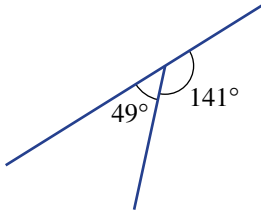

b

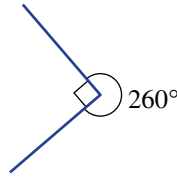

c

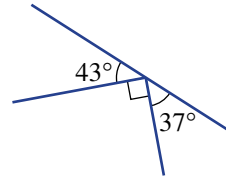

10 State an equation (e.g.  $2a + b = 90$ ) for these diagrams.

a

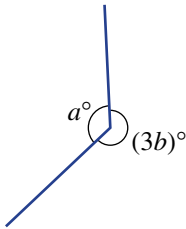

b

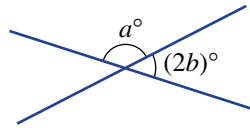

c



11 Consider this diagram (not drawn to scale).

- a Calculate the value of  $a$ .
- b Explain what is wrong with the way the diagram is drawn.

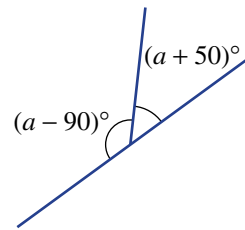

ENRICHMENT: Geometry with equations

-

-

12

12 Equations can be helpful in solving geometric problems in which more complex expressions are involved. Find the value of  $a$  in these diagrams.

a

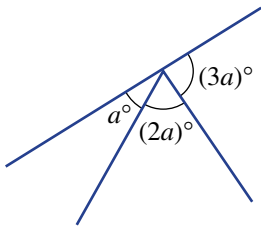

b

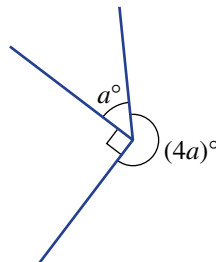

c

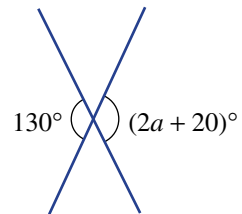

d

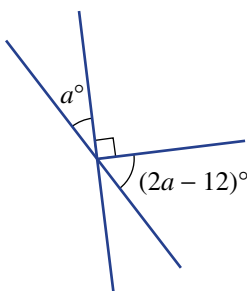

e

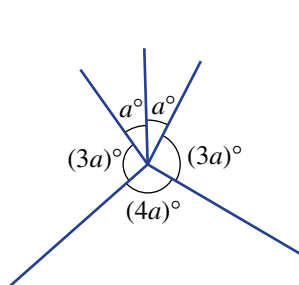

f

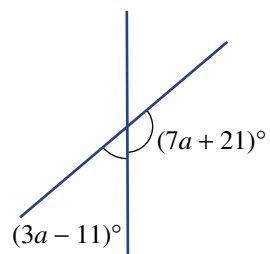

## 2B Transversal lines and parallel lines CONSOLIDATING

### LEARNING INTENTIONS

- To understand that parallel lines do not cross and that arrows are used to indicate parallel lines on a diagram
- To know the meaning of the terms transversal, corresponding, alternate and co-interior
- To be able to use properties of parallel lines to find unknown angles

Euclid's 5th axiom is: Given a line (shown in blue) and a point not on the line, there is only one line (shown in red) through the given point and in the same plane that does not intersect the given line.

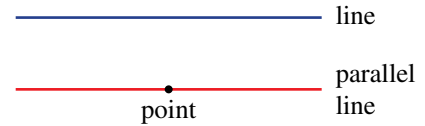

In simple language, Euclid's 5th axiom says that parallel lines do not intersect.

All sorts of shapes and solids both in the theoretical and practical worlds can be constructed using parallel lines. If two lines are parallel and are cut by a third line called a transversal, special pairs of angles are created.

### Lesson starter: Hidden transversals

This diagram can often be found as part of a shape such as a parallelogram or another more complex diagram. To see the relationship between  $a$  and  $b$  more easily, you can extend the lines to form this second diagram. In this new diagram you can now see the pair of parallel lines and the relationships between all the angles.

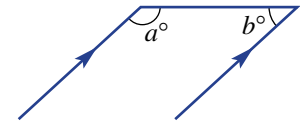

- Copy the new diagram.
- Label each of the eight angles formed with the pronumeral  $a$  or  $b$ , whichever is appropriate.
- What is the relationship between  $a$  and  $b$ ? Can you explain why?

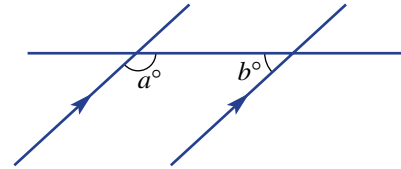

### KEY IDEAS

- A **transversal** is a line cutting at least two other lines.
- Pairs of angles formed by transversals can be:
  - **corresponding** (in corresponding positions)
  - **alternate** (on opposite sides of the transversal and inside the other two lines)
  - **co-interior** (on the same side of the transversal and inside the other two lines)
- Lines are parallel if they do not intersect.
  - Parallel lines are marked with the same number of arrows.

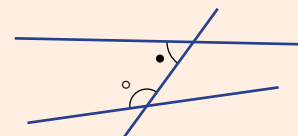
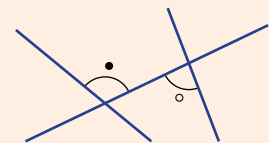
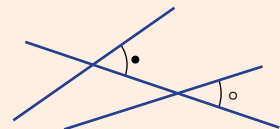

■ If two parallel lines are cut by a transversal:

- the corresponding angles are equal (4 pairs)

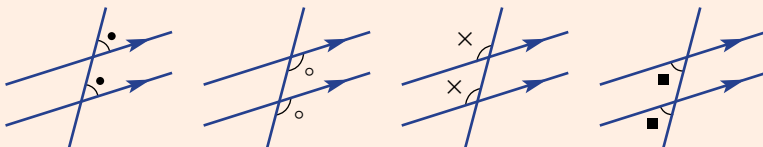

- the alternate angles are equal (2 pairs)

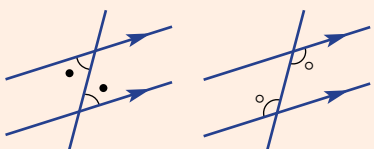

- the co-interior angles are supplementary (sum to  $180^\circ$ ) (2 pairs).

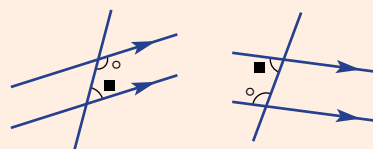

### BUILDING UNDERSTANDING

1 Two parallel lines are cut by a transversal. State the missing word (*equal* or *supplementary*).

- a Corresponding angles are \_\_\_\_\_.
- b Co-interior angles are \_\_\_\_\_.
- c Alternate angles are \_\_\_\_\_.

2 Name the angle that is:

- |                                       |                                       |
|---------------------------------------|---------------------------------------|
| a corresponding to $\angle ABF$       | b corresponding to $\angle BCG$       |
| c alternate to $\angle FBC$           | d alternate to $\angle CBE$           |
| e co-interior to $\angle HCB$         | f co-interior to $\angle EBC$         |
| g vertically opposite to $\angle ABE$ | h vertically opposite to $\angle HCB$ |

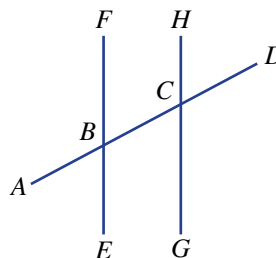

Parallel line geometry is applied in the placement of painted lines on airport runways, car parks, roads, sports courts and athletics tracks.



### Example 2 Describing related angles in parallel lines

State whether the following marked angles are corresponding, alternate or co-interior. Hence, state whether they are equal or supplementary.

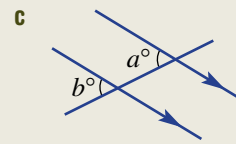
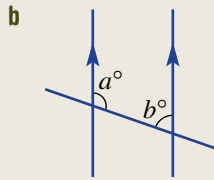
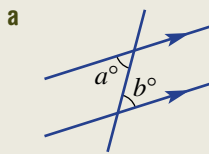

#### SOLUTION

- a** The marked angles are alternate.  
Therefore they are equal ( $a = b$ ).
- b** The marked angles are co-interior.  
Therefore they are supplementary  
( $a + b = 180$ ).
- c** The marked angles are corresponding.  
Therefore they are equal ( $a = b$ ).

#### EXPLANATION

The two angles are inside the parallel lines and on opposite sides of the transversal, so they are alternate.  
Alternate angles in parallel lines are equal.

The two angles are inside the parallel lines and on the same side of the transversal, so they are co-interior.  
Co-interior angles in parallel lines are supplementary, adding to  $180^\circ$ .

The two angles are in corresponding positions (both to the left of the intersection points).  
Corresponding angles in parallel lines are equal.

#### Now you try

State whether the following marked angles are corresponding, alternate or co-interior. Hence state whether they are equal or supplementary.

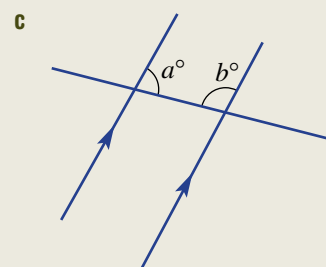
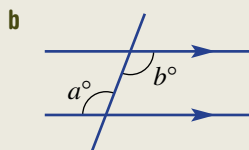
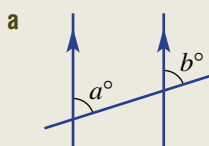



### Example 3 Finding angles involving parallel lines

Find the value of the pronumerals in these diagrams, stating reasons.

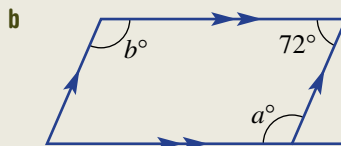
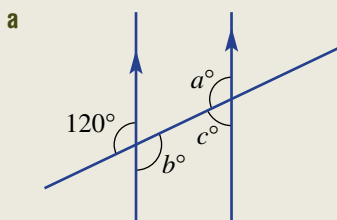

#### SOLUTION

**a**  $a = 120$

The angles labelled  $a^\circ$  and  $120^\circ$  are corresponding and lines are parallel.

$$b = 120$$

The angles labelled  $a^\circ$  and  $b^\circ$  are alternate and lines are parallel.

$$c + 120 = 180$$

$$c = 60$$

**b**  $a + 72 = 180$

$$a = 108$$

$$b + 72 = 180$$

$$b = 108$$

Co-interior angles in parallel lines are supplementary.

#### EXPLANATION

Corresponding angles on parallel lines are equal.

Alternatively, the angle labelled  $b^\circ$  is vertically opposite to the angle labelled  $120^\circ$ .

The angles labelled  $b^\circ$  and  $c^\circ$  are co-interior and sum to  $180^\circ$ . Alternatively, look at the angles labelled  $a^\circ$  and  $c^\circ$ , which are supplementary.

The pairs of angles are co-interior, which are supplementary if the lines are parallel.

It can be easier to see this by extending some edges of the parallelogram.

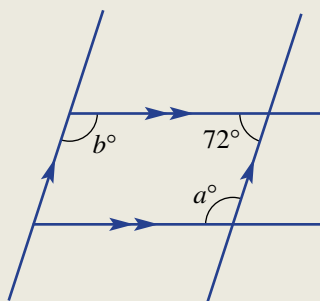

#### Now you try

Find the value of the pronumerals in these diagrams, stating reasons.

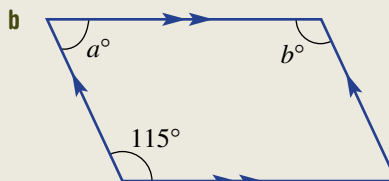
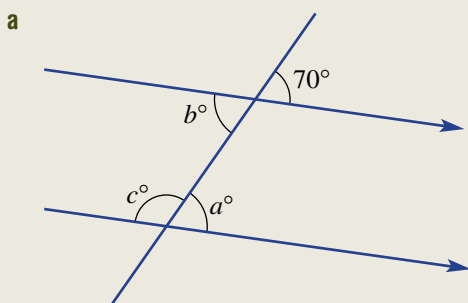

## Exercise 2B

### FLUENCY

1, 2–3(1/2)

1–3(1/2), 4, 5

2–4(1/2), 5

- Example 2** 1 State whether the following marked angles are corresponding, alternate or co-interior. Hence, state whether they are equal or supplementary.

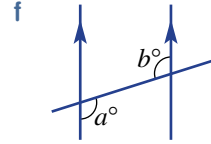
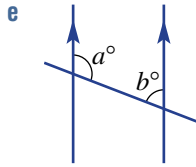
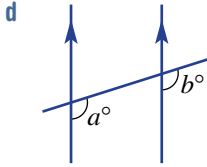
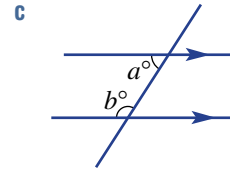
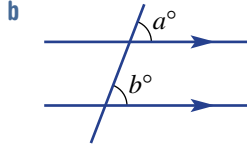
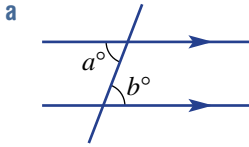

- Example 3a** 2 Find the value of the pronumerals in these diagrams, stating reasons.

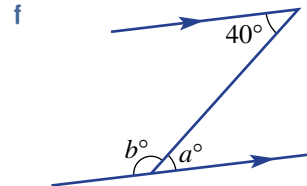
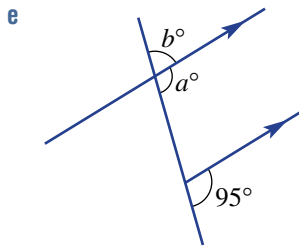
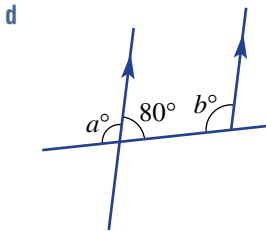
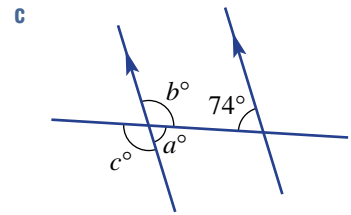
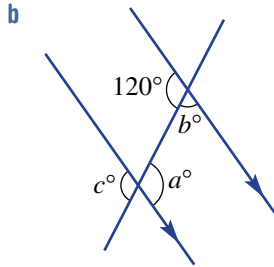
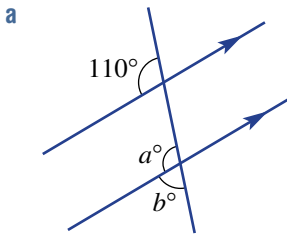

- Example 3b** 3 Find the value of the pronumerals in these diagrams, stating reasons.

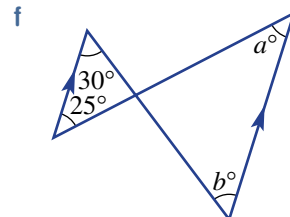
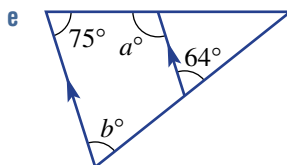
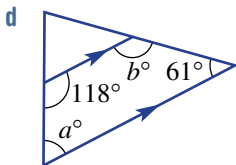
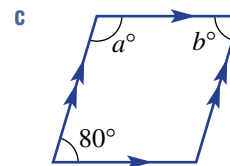
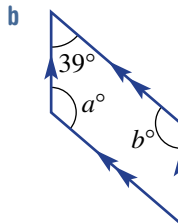
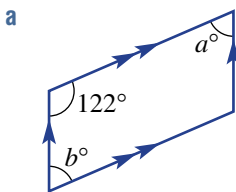

4 State whether the following marked angles are corresponding, alternate or co-interior. Note that the lines involved might not be parallel as there are no arrows on the diagrams.

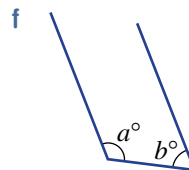
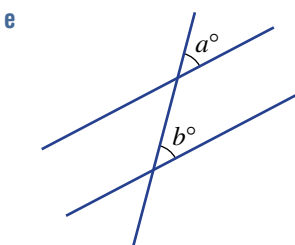
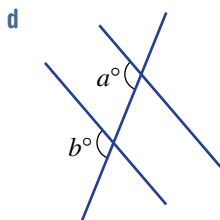
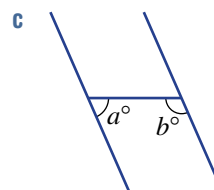
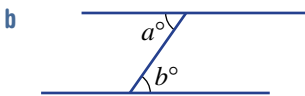
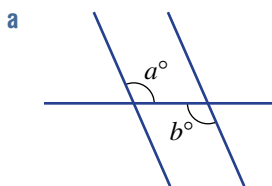

5 Decide if the following diagrams include a pair of parallel lines. Give a reason for each answer.

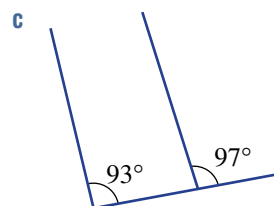
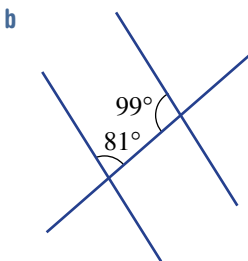
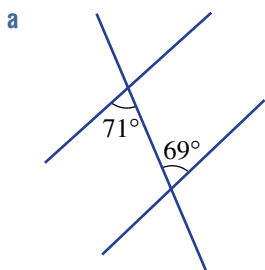

**PROBLEM-SOLVING**

6(1/2)

6(1/2)

6

6 Find the value of  $a$  in these diagrams.

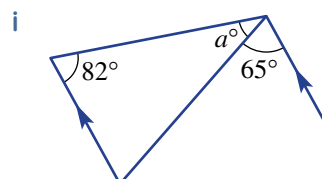
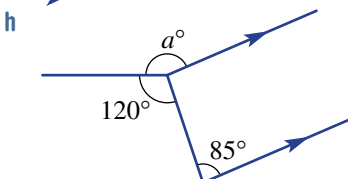
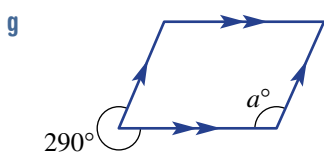
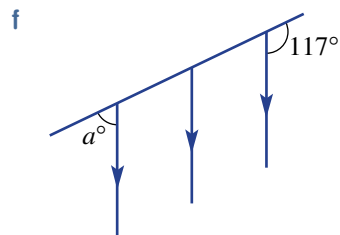
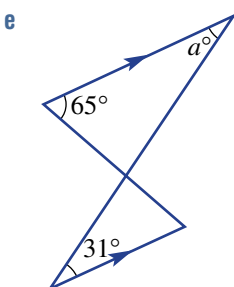
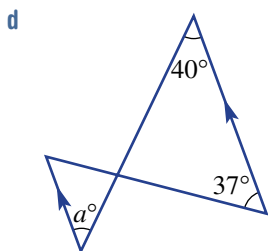
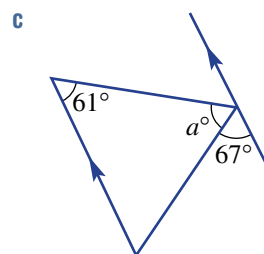
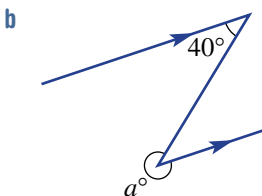
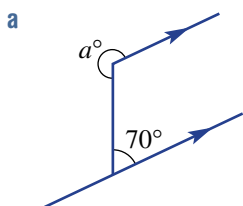

**REASONING** 7( $\frac{1}{2}$ ) 7( $\frac{1}{2}$ ), 8 7( $\frac{1}{2}$ ), 8

- 7 Sometimes parallel lines can be added to a diagram to help find an unknown angle. For example,  $\angle AOB$  can be found in this diagram by first drawing the dashed line and finding  $\angle AOC$  ( $40^\circ$ ) and  $\angle COB$   $70^\circ$ .  
So  $\angle AOB = 40^\circ + 70^\circ = 110^\circ$ .

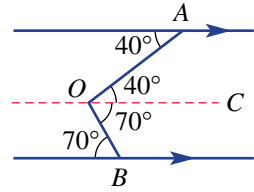

Apply a similar technique to find  $\angle AOB$  in these diagrams.

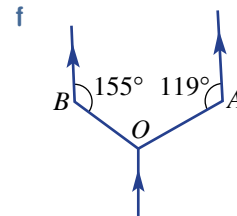
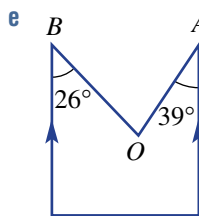
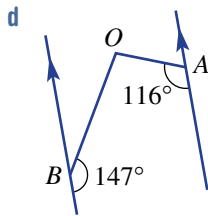
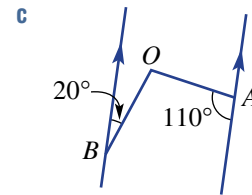
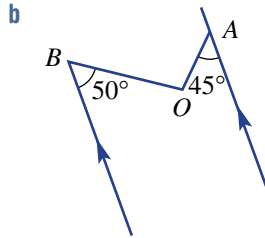
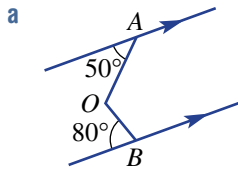

- 8 Write a rule for  $\angle AOB$  using the given pronumerals, e.g.  $\angle AOB = (90 - a^\circ)$ .

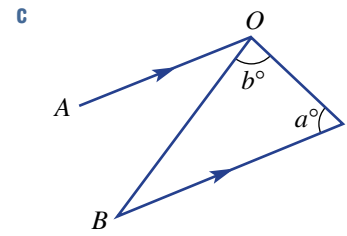
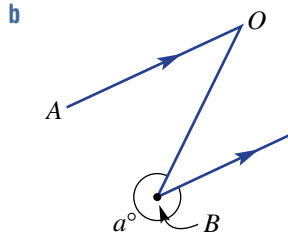
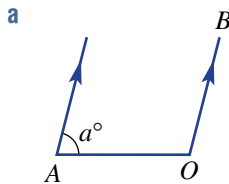

**ENRICHMENT: Pipe networks** - - 9

- 9 A plan for a natural gas plant includes many intersecting pipelines, some of which are parallel. Help the designers finish the plans by calculating the values of all the pronumerals.

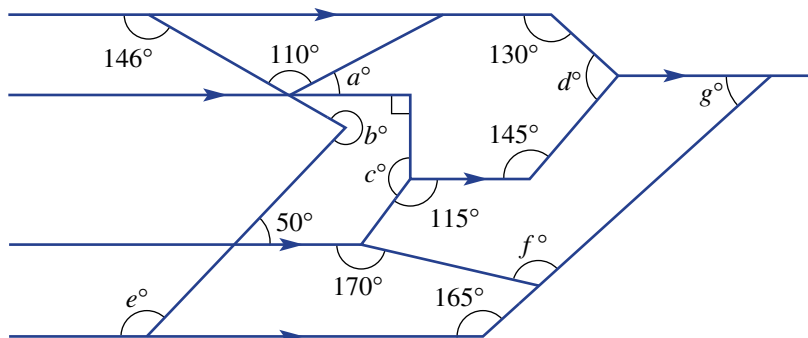



## 2C Triangles CONSOLIDATING

### LEARNING INTENTIONS

- To understand that triangles can be classified by their side lengths as scalene, isosceles or equilateral
- To understand that triangles can be classified by their interior angles as acute, right or obtuse
- To be able to use the angle sum of a triangle to find unknown angles
- To be able to use the exterior angle theorem to find unknown angles

A triangle is a shape with three straight sides. As a real-life object, the triangle is a very rigid shape and this leads to its use in the construction of houses and bridges. It is one of the most commonly used shapes in design and construction.

Knowing the properties of triangles can help to solve many geometrical problems and this knowledge can also be extended to explore other more complex shapes.



Architects use triangles for both support and design, such as on this attractive glass frontage on a building. How many different types of triangles can you name?

### Lesson starter: Illustrating the angle sum

You can complete this task using a pencil and ruler or using interactive geometry.

- Draw any triangle and measure each interior angle.
- Add all three angles to find the angle sum of your triangle.
- Compare your angle sum with the results of others. What do you notice?

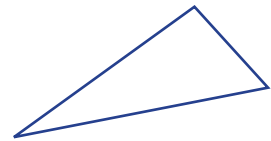

If interactive geometry is used, drag one of the vertices to alter the interior angles. Now check to see if your conclusions remain the same.

### KEY IDEAS

- A **triangle** has:
  - 3 sides
  - 3 vertices ('vertices' is the plural of vertex)
  - 3 interior angles.
- Triangles classified by side lengths
  - Sides with the same number of dashes are of equal length.

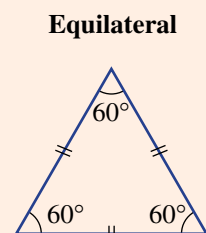
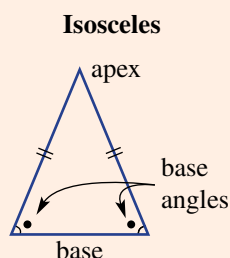
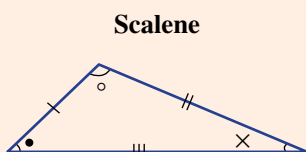
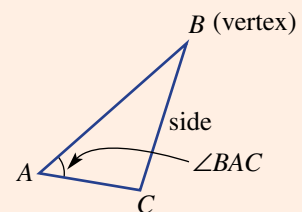

■ Triangles classified by interior angles

**Acute**  
(All angles acute)

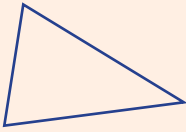

**Right**  
(1 right angle)

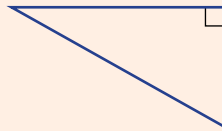

**Obtuse**  
(1 Obtuse angle)

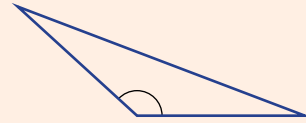

■ The angle sum of a triangle is  $180^\circ$ .

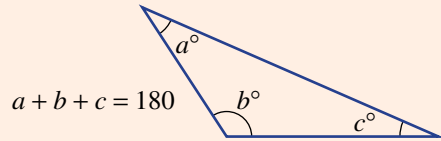

■ The **exterior angle theorem**:  
The exterior angle of a triangle is equal to the sum of the two opposite interior angles.

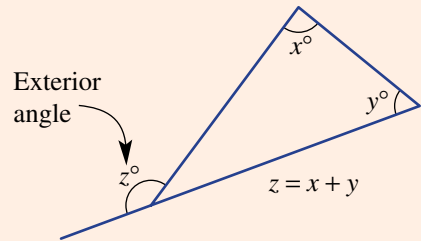

**BUILDING UNDERSTANDING**

1 Give the common name of a triangle with these properties.

- |                    |                            |
|--------------------|----------------------------|
| a One right angle  | b 2 equal side lengths     |
| c All angles acute | d All angles $60^\circ$    |
| e One obtuse angle | f 3 equal side lengths     |
| g 2 equal angles   | h 3 different side lengths |

2 Classify these triangles as scalene, isosceles or equilateral.

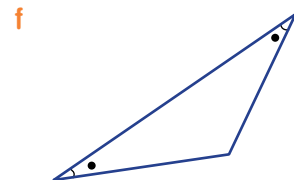
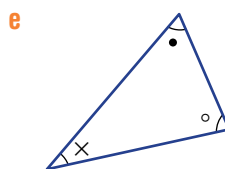
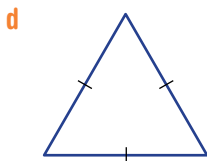
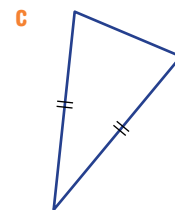
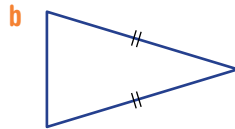
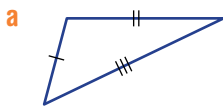

3 Classify these triangles as acute, right or obtuse.

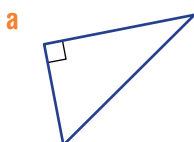



### Example 4 Using the angle sum of a triangle

Find the value of  $a$  in these triangles.

**a**

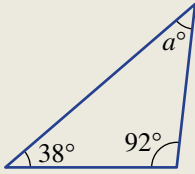

**b**

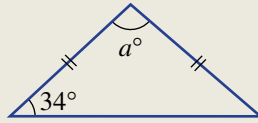

**c**

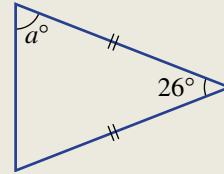

#### SOLUTION

$$\begin{aligned} \mathbf{a} \quad a + 38 + 92 &= 180 \\ a + 130 &= 180 \\ \therefore a &= 50 \end{aligned}$$

$$\begin{aligned} \mathbf{b} \quad a + 34 + 34 &= 180 \\ a + 68 &= 180 \\ \therefore a &= 112 \end{aligned}$$

$$\begin{aligned} \mathbf{c} \quad a + a + 26 &= 180 \\ 2a + 26 &= 180 \\ 2a &= 154 \\ \therefore a &= 77 \end{aligned}$$

#### EXPLANATION

The angle sum of the three interior angles of a triangle is  $180^\circ$ .

Also,  $38 + 92 = 130$  and  $180 - 130 = 50$ .

The two base angles are equal ( $34^\circ$  each).

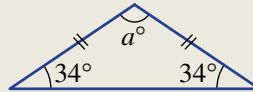

The two base angles in an isosceles triangle are equal.

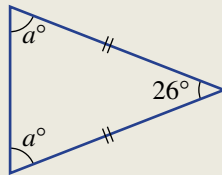

#### Now you try

Find the value of  $a$  in these triangles.

**a**

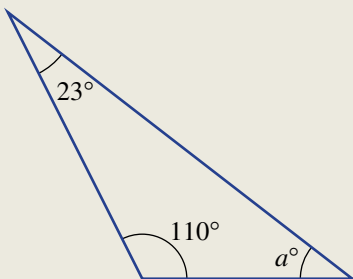

**b**

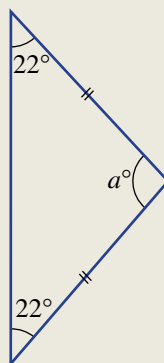

**c**

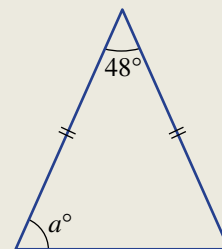



### Example 5 Using the exterior angle theorem

Find the value of  $a$  in this diagram.

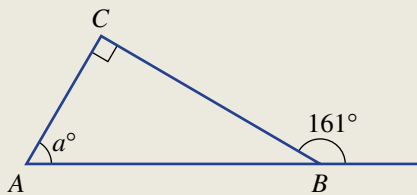

#### SOLUTION

$$a + 90 = 161$$

$$\therefore a = 71$$

or  $\angle ABC = 180^\circ - 161^\circ = 19^\circ$   
 so  $a = 180 - (19 + 90)$   
 $= 71$

#### EXPLANATION

Use the exterior angle theorem for a triangle. The exterior angle ( $161^\circ$ ) is equal to the sum of the two opposite interior angles.

Alternatively, find  $\angle ABC$  ( $19^\circ$ ), then use the triangle angle sum to find the value of  $a$ .

#### Now you try

Find the value of  $a$  in this diagram.

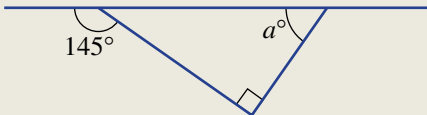

## Exercise 2C

### FLUENCY

1, 2( $\frac{1}{2}$ ), 3, 4, 5( $\frac{1}{2}$ )2( $\frac{1}{2}$ ), 3, 4, 5( $\frac{1}{2}$ )2( $\frac{1}{3}$ ), 4, 5( $\frac{1}{2}$ )

Example 4a

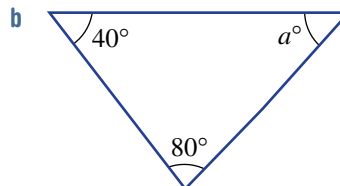
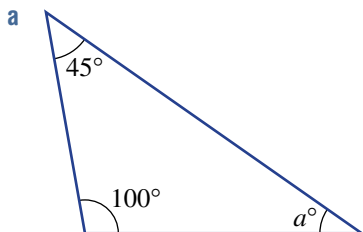
1 Find the value of  $a$  in these triangles.

**Example 4a** 2 Use the angle sum of a triangle to help find the value of  $a$  in these triangles.

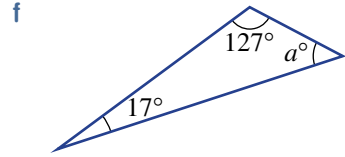
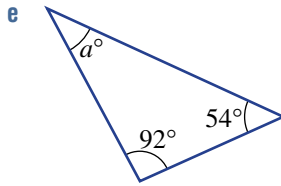
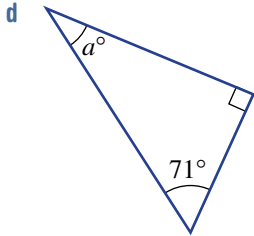
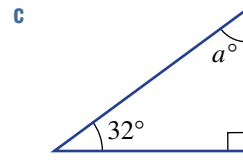
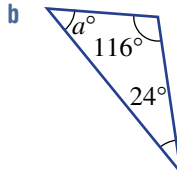
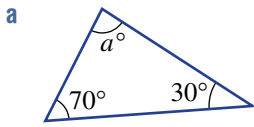

**Example 4b** 3 These triangles are isosceles. Find the value of  $a$ .

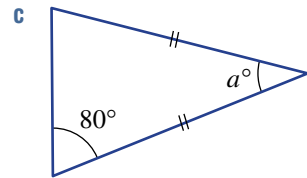
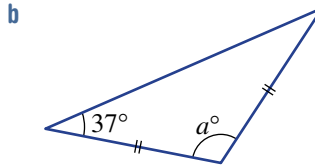
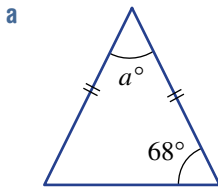

**Example 4c** 4 Find the value of  $a$  in these isosceles triangles.

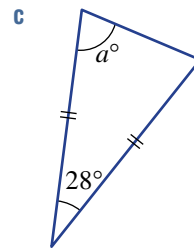
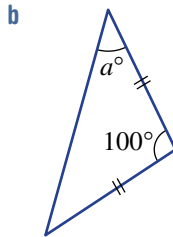
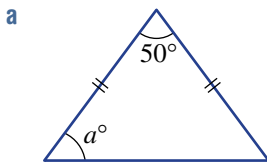

**Example 5** 5 Find the value of  $a$  in these diagrams.

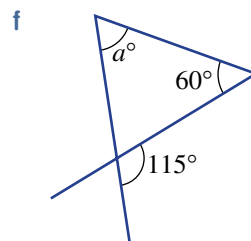
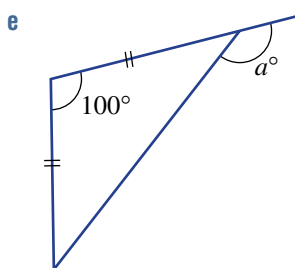
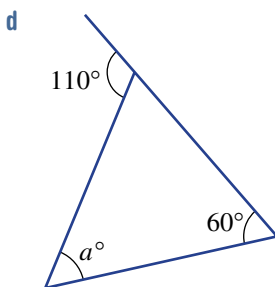
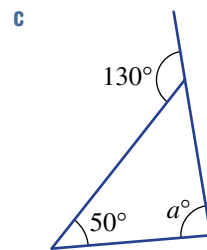
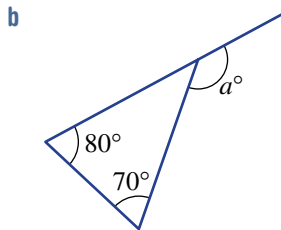
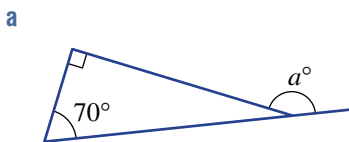

**PROBLEM-SOLVING**

6, 7

6, 7

7, 8

6 Decide if it is possible to draw a triangle with the given description. Draw a diagram to support your answer.

- a Right and scalene
- b Obtuse and equilateral
- c Right and isosceles
- d Acute and isosceles
- e Acute and equilateral
- f Obtuse and isosceles

7 Use your knowledge of parallel lines and triangles to find the unknown angle  $a$ .

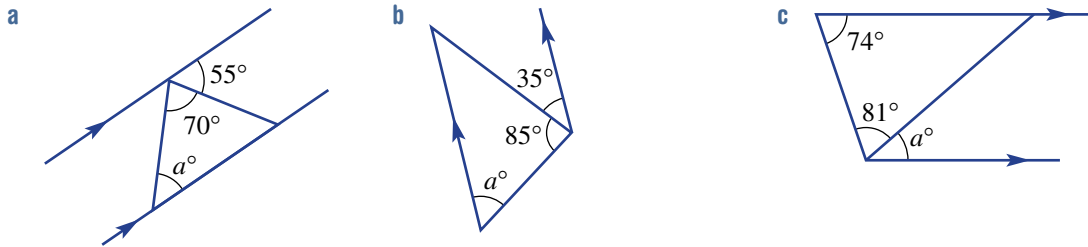

8 Find the value of  $a$  in these diagrams.

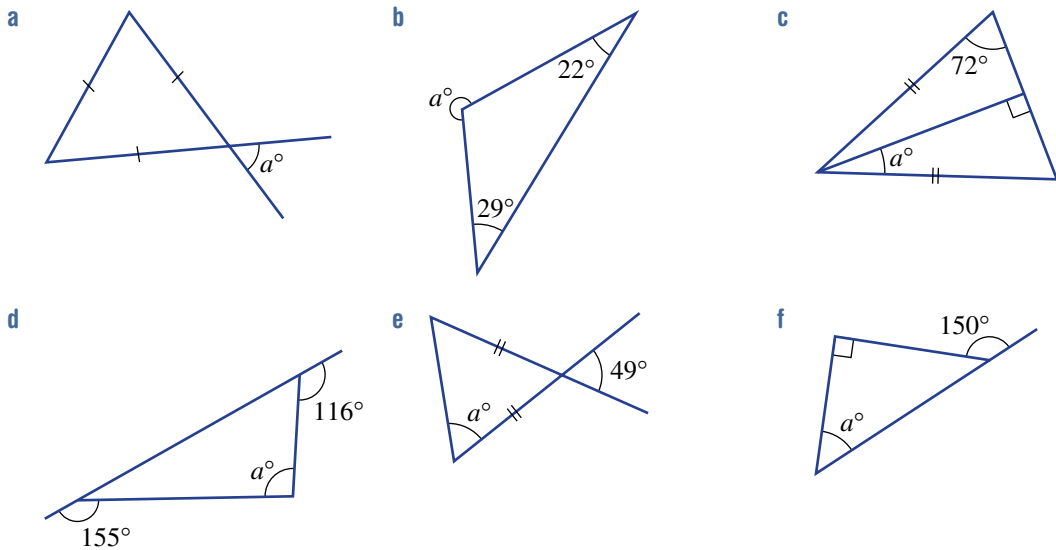

**REASONING**

9

9, 10

10-13

9 A triangle is constructed using a circle and two radius lengths.

- a What type of triangle is  $\triangle AOB$  and why?
- b Name two angles that are equal.
- c Find  $\angle ABO$  if  $\angle BAO$  is  $30^\circ$ .
- d Find  $\angle AOB$  if  $\angle OAB$  is  $36^\circ$ .
- e Find  $\angle ABO$  if  $\angle AOB$  is  $100^\circ$ .

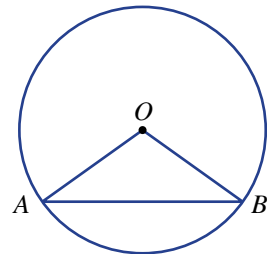

10 To prove that the angle sum of a triangle is  $180^\circ$ , work through these steps with the given diagram.

a Using the pronumerals  $a$ ,  $b$  or  $c$ , give the value of these angles and state a reason.

i  $\angle ABD$  ii  $\angle CBE$

b What is true about the three angles  $\angle ABD$ ,  $\angle ABC$  and  $\angle CBE$  and why?

c What do parts a and b above say about the pronumerals  $a$ ,  $b$  and  $c$ , and what does this say about the angle sum of the triangle  $ABC$ ?

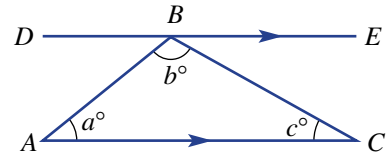

11 Prove that a triangle cannot have two right angles.

12 Prove that an equilateral triangle must have  $60^\circ$  angles.

13 A different way of proving the angle sum of a triangle is to use this diagram.

a Give a reason why  $\angle BCD = b^\circ$ .

b What do you know about the two angles  $\angle BAC$  and  $\angle ACD$  and why?

c What do parts a and b above say about the pronumerals  $a$ ,  $b$  and  $c$ , and what does this say about the triangle  $ABC$ ?

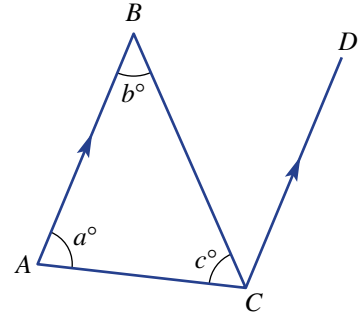

**ENRICHMENT: Angle in a semicircle**

14 The angle sum of a triangle can be used to prove other theorems, one of which relates to the angle in a semicircle. This theorem says that  $\angle ACB$  in a semicircle is always  $90^\circ$  where  $AB$  is a diameter.

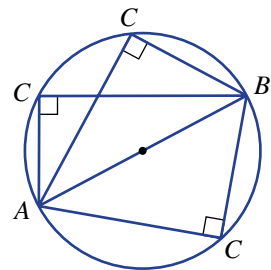

a Use your knowledge of isosceles triangles to find the value of  $a$ ,  $b$  and  $c$  in this circle.

b What do you notice about the sum of the values of  $a$  and  $c$ ?

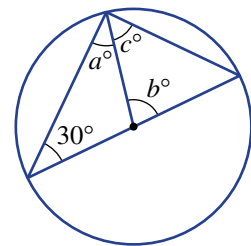

c Repeat parts a and b above for this circle.

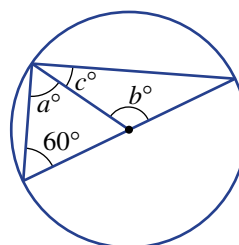

d Repeat parts a and b from the previous page for this circle.

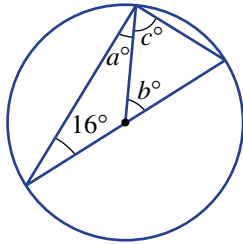

e What do you notice about the sum of the values of  $a$  and  $c$  for all the previous circles?

f Prove this result generally by finding:

- i  $a$ ,  $b$  and  $c$  in terms of  $x$
- ii the value of  $a + c$ .

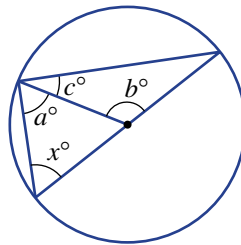

g Use the angle sum of a triangle and the diagram to give a different proof that  $a + c$  is 90.

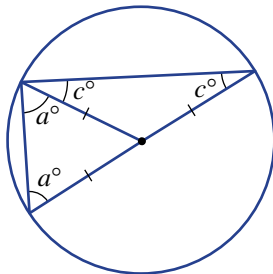



## 2D Quadrilaterals

### LEARNING INTENTIONS

- To know the meaning of the terms convex and non-convex
- To be able to classify quadrilaterals as parallelograms, rectangles, rhombuses, squares, kites and/or trapeziums
- To be able to use the angle sum of a quadrilateral to find unknown angles
- To understand that properties of angles in parallel lines can be used to find unknown angles in trapeziums and parallelograms

Quadrilaterals are four-sided shapes with four interior angles. All quadrilaterals have the same angle sum, but other properties depend on such things as pairs of sides of equal length, parallel sides and lengths of diagonals. All quadrilaterals can be drawn as two triangles and, since the six angles inside the two triangles make up the four angles of the quadrilateral, the angle sum is  $2 \times 180^\circ = 360^\circ$ .

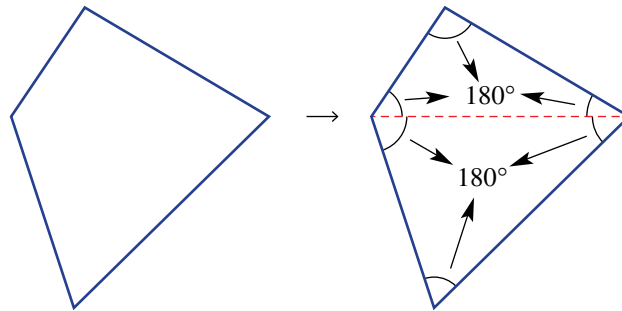

### Lesson starter: Which quadrilateral?

Name all the different quadrilaterals you can think of that have the properties listed below. There may be more than one quadrilateral for each property listed. Draw each quadrilateral to illustrate the shape and its features.

- 4 equal length sides
- 2 pairs of parallel sides
- Equal length diagonals
- 1 pair of parallel sides
- 2 pairs of equal length sides
- 2 pairs of equal opposite angles



Builders check that a wall is rectangular by measuring the wall frame's two diagonals. Any small difference in diagonal lengths means the wall is not rectangular and the building will be 'out of square'.

## KEY IDEAS

■ **Quadrilaterals** can be convex or non-convex.

- Convex quadrilaterals have all vertices pointing outwards.
  - The diagonals of a convex quadrilateral lie inside the figure.
- Non-convex (or concave) quadrilaterals have one vertex pointing inwards, and one reflex interior angle.
  - One diagonal will lie outside the figure.

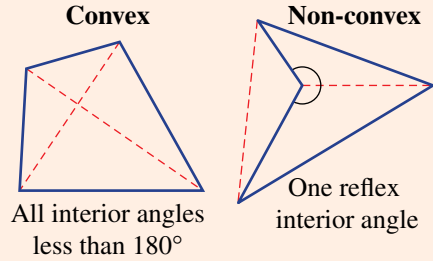

■ **Parallelograms** are quadrilaterals with two pairs of parallel sides.

- Other properties are illustrated in this diagram.

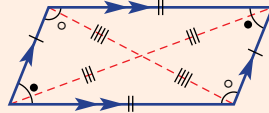

■ **Special parallelograms** include:

- **Rectangle:** Parallelogram with all angles  $90^\circ$ .
- **Rhombus:** Parallelogram with all sides equal.
- **Square:** Rhombus with all angles  $90^\circ$  or rectangle with all sides equal.

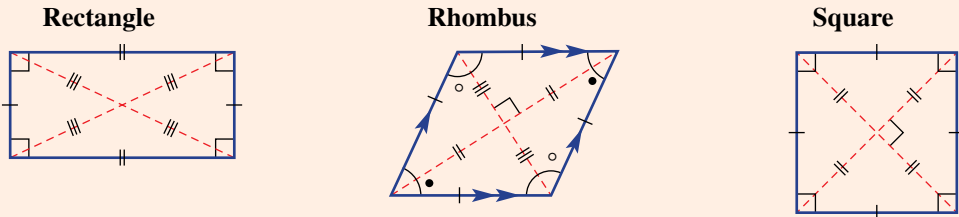

■ **Other special quadrilaterals** include:

- **Kite:** Quadrilateral with two adjacent pairs of equal sides.
- **Trapezium:** Quadrilateral with at least one pair of parallel sides.



■ **The angle sum of any quadrilateral is  $360^\circ$ .**

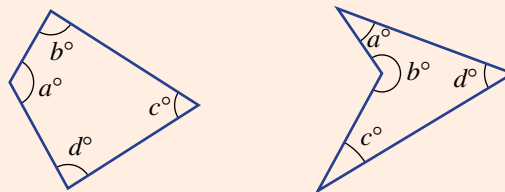

$$a + b + c + d = 360$$

- Quadrilaterals with parallel sides include two pairs of co-interior angles.

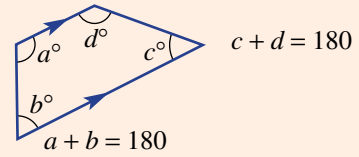

## BUILDING UNDERSTANDING

- 1 Decide if these quadrilaterals are convex or non-convex.

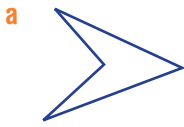

- 2 Refer to the diagrams in the **Key ideas** or accurately draw your own shapes, including the diagonals, to answer true or false to these statements.

a Square

- i All sides are of equal length.
- ii Diagonals are not equal in length.
- iii All sides are parallel to each other.
- iv Diagonals intersect at right angles.

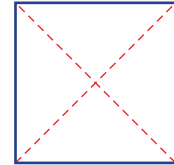

b Rectangle

- i All sides are always of equal length.
- ii All interior angles are  $90^\circ$ .
- iii Diagonals always intersect at right angles.
- iv There are two pairs of parallel sides.

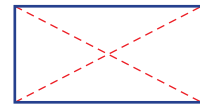

c Rhombus

- i All interior angles are always equal.
- ii All sides are of equal length.
- iii Diagonals intersect at right angles.

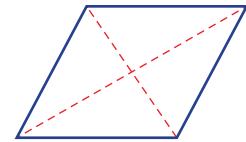

d Parallelogram

- i There are two pairs of equal length and parallel sides.
- ii Diagonals are always equal in length.
- iii Diagonals always intersect at right angles.

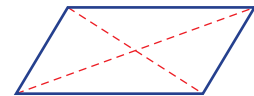

e Kite

- i There are two pairs of sides of equal length.
- ii There are always two pairs of parallel sides.
- iii Diagonals intersect at right angles.

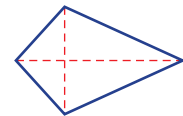

f Trapezium

- i Diagonals are always equal in length.
- ii There are always two pairs of parallel sides.

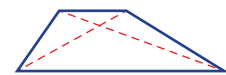



### Example 6 Finding unknown angles in quadrilaterals

Find the value of the pronumerals in these quadrilaterals.

**a**

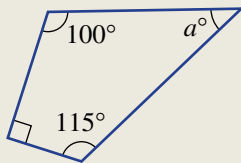

**b**

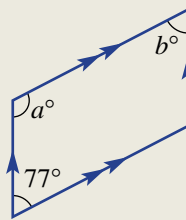

#### SOLUTION

$$\begin{aligned} \mathbf{a} \quad a + 100 + 90 + 115 &= 360 \\ a + 305 &= 360 \\ a &= 360 - 305 \\ \therefore a &= 55 \end{aligned}$$

$$\begin{aligned} \mathbf{b} \quad a + 77 &= 180 \\ \therefore a &= 103 \\ \therefore b &= 77 \end{aligned}$$

#### EXPLANATION

The sum of angles in a quadrilateral is  $360^\circ$ .  
Solve the equation to find the value of  $a$ .

Two angles inside parallel lines are co-interior and therefore sum to  $180^\circ$ .

Opposite angles in a parallelogram are equal.  
Alternatively, the angles marked  $a^\circ$  and  $b^\circ$  are co-interior within parallel lines, therefore they are supplementary.

#### Now you try

Find the value of the pronumerals in these quadrilaterals.

**a**

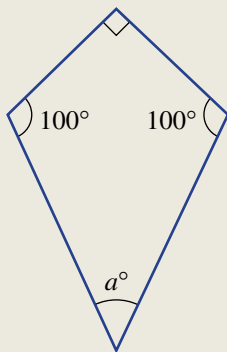

**b**

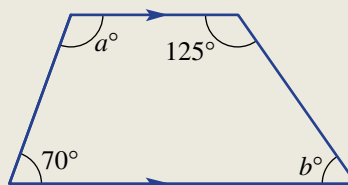

## Exercise 2D

### FLUENCY

1, 2, 3(1/2)

2, 3(1/2), 4

2, 3(1/2), 4

Example 6a

1 Find the value of the pronumerals in these quadrilaterals.

a

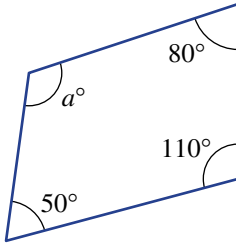

b

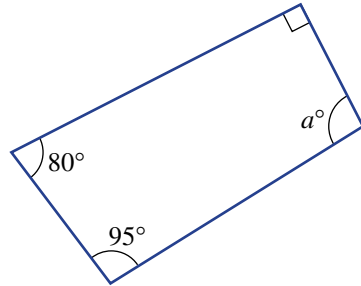

Example 6a

2 Use the quadrilateral angle sum to find the value of  $a$  in these quadrilaterals.

a

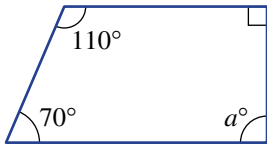

b

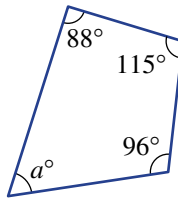

c

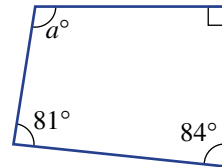

d

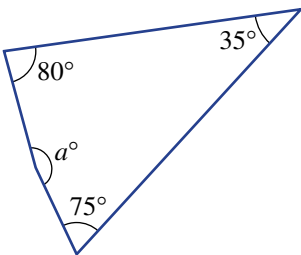

e

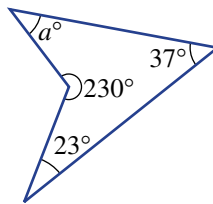

f

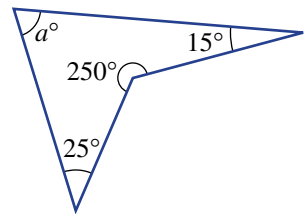

Example 6b

3 Find the value of the pronumerals in these quadrilaterals.

a

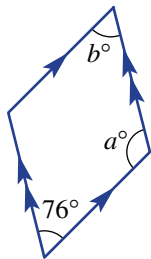

b

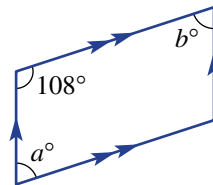

c

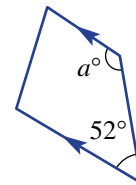

4 By considering the properties of the given quadrilaterals, give the values of the pronumerals.

a

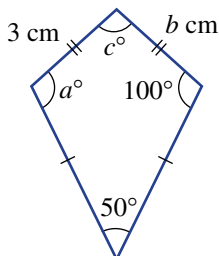

b

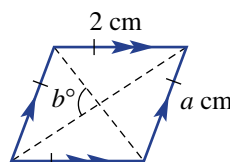

c

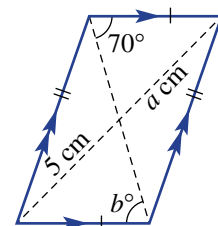

**PROBLEM-SOLVING** 5      5      5(1/2), 6

5 Use your knowledge of geometry from the previous sections to find the values of  $a$ .

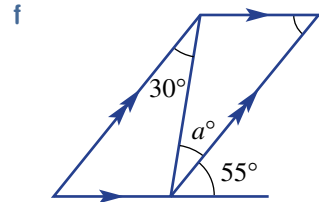
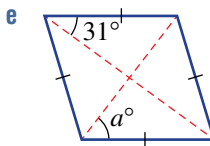
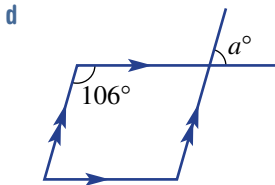
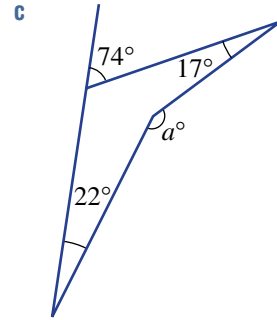
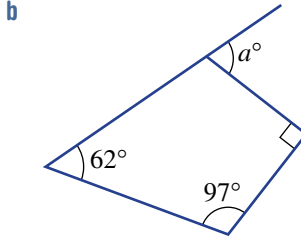
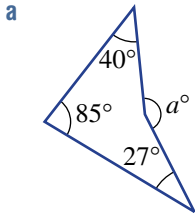

6 Some of the angles in these diagrams are multiples of  $x^\circ$ . Find the value of  $x$  in each case.

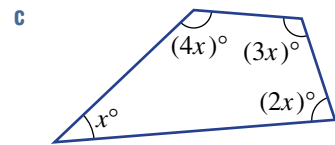
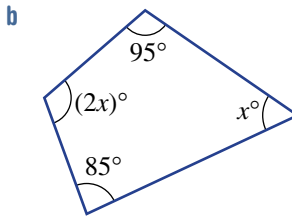
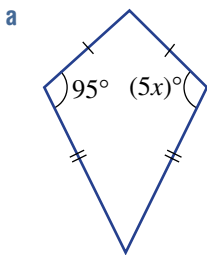

**REASONING** 7      7, 8      8, 9

- 7 The word 'bisect' means to cut in half.
- Which quadrilaterals have diagonals that bisect each other?
  - Which quadrilaterals have diagonals that bisect all their interior angles?
- 8 By considering the properties of special quadrilaterals, decide if the following are always true.
- A square is a type of rectangle.
  - A rectangle is a type of square.
  - A square is a type of rhombus.
  - A rectangle is a type of parallelogram.
  - A parallelogram is a type of square.
  - A rhombus is a type of parallelogram.
- 9 Is it possible to draw a non-convex quadrilateral with two or more interior reflex angles? Explain and illustrate.

## ENRICHMENT: Quadrilateral proofs

10

10 Complete these proofs of two different angle properties of quadrilaterals.

a Angle sum =  $a + b + c + \underline{\hspace{1cm}} + \underline{\hspace{1cm}} + \underline{\hspace{1cm}}$   
 =  $\underline{\hspace{1cm}} + \underline{\hspace{1cm}}$  (angle sum of a triangle)  
 =  $\underline{\hspace{1cm}}$

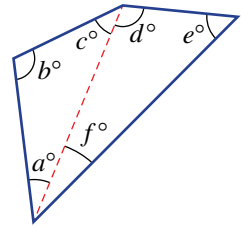

b  $\angle ADC = 360^\circ - (\underline{\hspace{1cm}} + \underline{\hspace{1cm}} + \underline{\hspace{1cm}})$  (angle sum of a quadrilateral)

$$\begin{aligned} \text{Reflex } \angle ADC &= 360^\circ - \angle ADC \\ &= 360^\circ - (360^\circ - (\underline{\hspace{1cm}} + \underline{\hspace{1cm}} + \underline{\hspace{1cm}})) \\ &= \underline{\hspace{1cm}} + \underline{\hspace{1cm}} + \underline{\hspace{1cm}} \end{aligned}$$

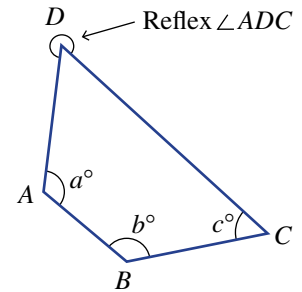

There are many quadrilaterals formed as part of the structure of the Mathematical Bridge in Cambridge, UK.

2A/B

1 Determine the value of the pronumerals in these diagrams.

a

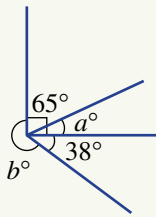

b

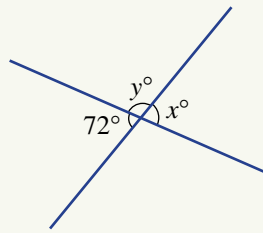

c

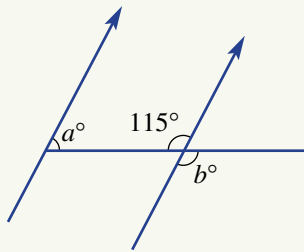

d

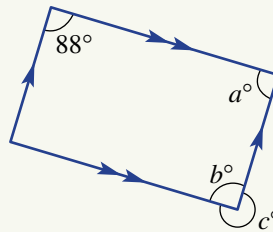

2A

2 For the angles in this diagram name the angle that is:

- a vertically opposite to  $\angle ROS$ .
- b complementary to  $\angle QOR$ .
- c supplementary to  $\angle POT$ .

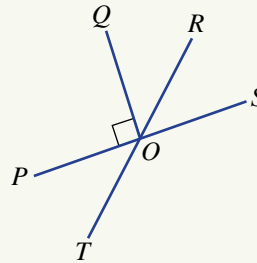

2B

3 Find the value of  $x$  in each of the following diagrams.

a

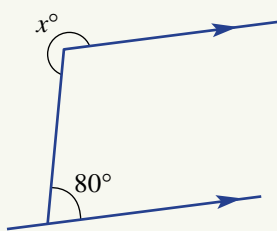

b

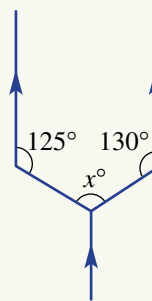

c

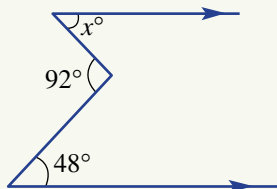

2C

4 Choose two words to describe this triangle from: isosceles, scalene, equilateral, obtuse, acute and right.

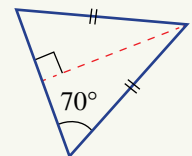



2C

5 Find the value of  $a$  in each of the following diagrams.

a

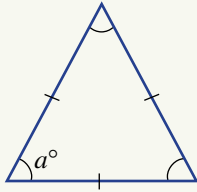

b

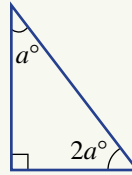

c

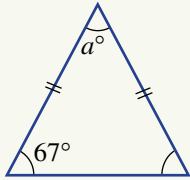

d

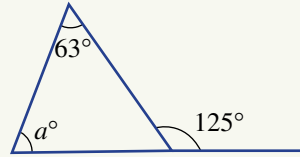

e

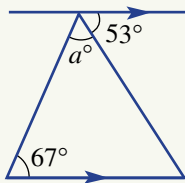

f

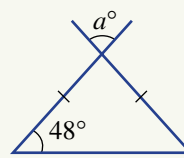

2D

6 Find the value of the pronumerals in these quadrilaterals.

a

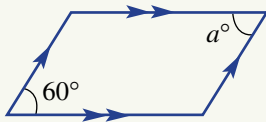

b

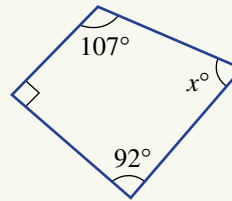

c

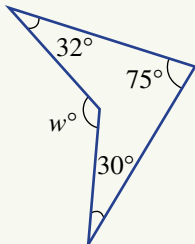

d

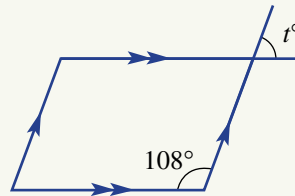

e

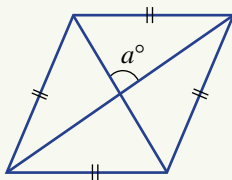

## 2E Polygons EXTENDING

### LEARNING INTENTIONS

- To understand that polygons can be convex or non-convex
- To know the names of different types of polygons with up to 12 sides
- To understand what a regular polygon is
- To be able to find the angle sum of a polygon, and to use this to find unknown angles

The word ‘polygon’ comes from the Greek words *poly*, meaning ‘many’, and *gonia*, meaning ‘angles’. The number of interior angles equals the number of sides and the angle sum of each type of polygon depends on this number. Also, there exists a general rule for the angle sum of a polygon with  $n$  sides, which we will explore in this section.



The Pentagon is a famous government office building in Virginia, USA.

### Lesson starter: Developing the rule

The following procedure uses the fact that the angle sum of a triangle is  $180^\circ$ , which was developed in an earlier section. Complete the table and try to write in the final row the general rule for the angle sum of a polygon.

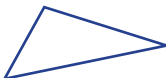
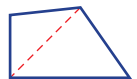
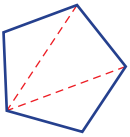
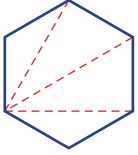
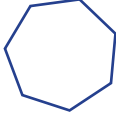
Shape	Number of sides	Number of triangles	Angle sum
Triangle 	3	1	$1 \times 180^\circ = 180^\circ$
Quadrilateral 	4	2	$\_\_\_ \times 180^\circ = \_\_\_$
Pentagon 	5		
Hexagon 	6		
Heptagon 	7		

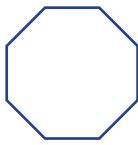
Shape	Number of sides	Number of triangles	Angle sum
Octagon 	8		
$n$ -sided polygon	$n$		$(\quad) \times 180^\circ$

### KEY IDEAS

■ **Polygons** are shapes with straight sides and can be convex or non-convex.

- Convex polygons have all vertices pointing outwards.
- Non-convex (or concave) polygons have at least one vertex pointing inwards and at least one reflex interior angle.

**Convex**

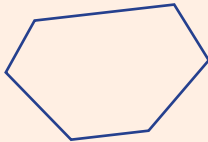

All interior angles less than  $180^\circ$

**Non-convex**

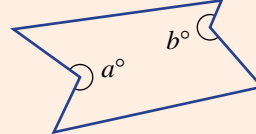

At least one reflex interior angle

■ Polygons are named according to their number of sides.

Number of sides	Name
3	Triangle
4	Quadrilateral
5	Pentagon
6	Hexagon
7	Heptagon
8	Octagon
9	Nonagon
10	Decagon
11	Undecagon
12	Dodecagon



This Moroccan tile design, made over 1000 years ago, includes many different polygons.

■ The angle sum  $S$  of a polygon with  $n$  sides is given by the rule:

$$S = (n - 2) \times 180^\circ.$$

■ A **regular polygon** has sides of equal length and equal interior angles.

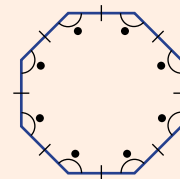

Regular octagon

**BUILDING UNDERSTANDING**

- 1 State the number of sides on these polygons.
 

a hexagon	b quadrilateral	c decagon
d heptagon	e pentagon	f dodecagon
- 2 Evaluate  $(n - 2) \times 180^\circ$  if:
 

a $n = 6$	b $n = 10$	c $n = 22$
-----------	------------	------------
- 3 What is the common name given to these polygons?
 

a regular quadrilateral	b regular triangle
-------------------------	--------------------
- 4 Regular polygons have equal interior angles. Find the size of an interior angle for these regular polygons with the given angle sum.
 

a pentagon ( $540^\circ$ )	b decagon ( $1440^\circ$ )	c octagon ( $1080^\circ$ )
----------------------------	----------------------------	----------------------------

**Example 7 Finding the angle sum of a polygon**

Find the angle sum of a heptagon.

**SOLUTION**

$$\begin{aligned}
 S &= (n - 2) \times 180^\circ \\
 &= (7 - 2) \times 180^\circ \\
 &= 5 \times 180^\circ \\
 &= 900^\circ
 \end{aligned}$$

**EXPLANATION**

A heptagon has 7 sides, so  $n = 7$ .  
Simplify  $(7 - 2)$  before multiplying by  $180^\circ$ .

**Now you try**

Find the angle sum of an octagon.

**Example 8 Finding angles in polygons**

Find the value of  $a$  in this pentagon.

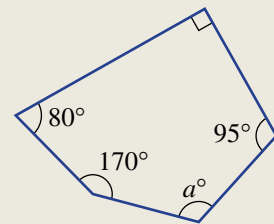
**SOLUTION**

$$\begin{aligned}
 S &= (n - 2) \times 180^\circ \\
 &= (5 - 2) \times 180^\circ \\
 &= 540^\circ
 \end{aligned}$$

$$\begin{aligned}
 a + 170 + 80 + 90 + 95 &= 540 \\
 a + 435 &= 540 \\
 a &= 105
 \end{aligned}$$

**EXPLANATION**

First calculate the angle sum of a pentagon using  $n = 5$ .

Sum all the angles and set this equal to the angle sum of  $540^\circ$ . The difference between 540 and 435 is 105.

**Now you try**

Find the value of  $a$  in this hexagon.

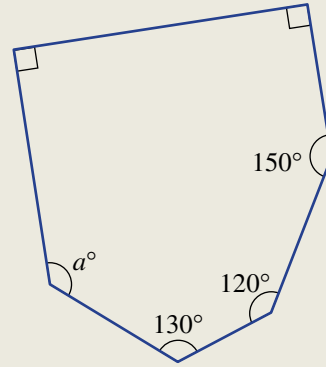
**Example 9 Finding interior angles of regular polygons**

Find the size of an interior angle in a regular octagon.

**SOLUTION**

$$\begin{aligned} S &= (n - 2) \times 180^\circ \\ &= (8 - 2) \times 180^\circ \\ &= 1080^\circ \end{aligned}$$

$$\begin{aligned} \text{Angle size} &= 1080^\circ \div 8 \\ &= 135^\circ \end{aligned}$$

**EXPLANATION**

First calculate the angle sum of an octagon using  $n = 8$ .

All 8 angles are equal in size so divide the angle sum by 8.

**Now you try**

Find the size of an interior angle in a regular hexagon.

**Exercise 2E****FLUENCY**1, 2, 3–4( $\frac{1}{2}$ )2, 3–4( $\frac{1}{2}$ )3–4( $\frac{1}{2}$ )

- Example 7** 1 Find the angle sum of a pentagon. Refer to the Key ideas if you cannot remember how many sides a pentagon has.
- Example 7** 2 Find the angle sum of these polygons.
- hexagon
  - nonagon
  - 15-sided polygon

**Example 8** 3 Find the value of  $a$  in these polygons.

a

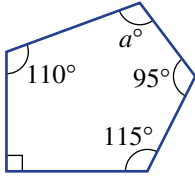

b

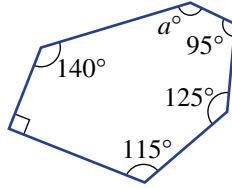

c

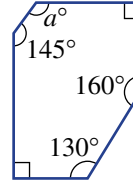

d

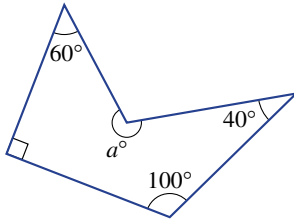

e

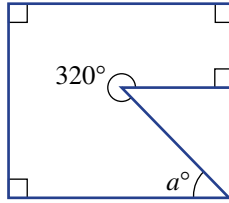

f

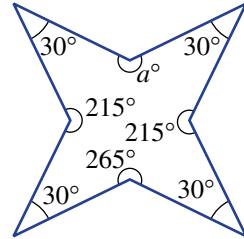

**Example 9** 4 Find the size of an interior angle of these regular polygons. Round the answer to one decimal place where necessary.



- a Regular pentagon
- b Regular heptagon
- c Regular undecagon
- d Regular 32-sided polygon

**PROBLEM-SOLVING**

5

5,  $6\frac{1}{2}$

$5-6\frac{1}{2}$



5 Find the number of sides of a polygon with the given angle sums.

- a  $1260^\circ$
- b  $2340^\circ$
- c  $3420^\circ$
- d  $29700^\circ$

6 Find the value of  $x$  in these diagrams.

a

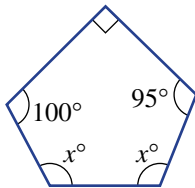

b

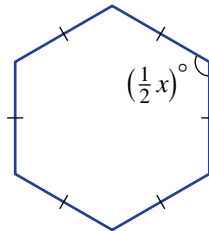

c

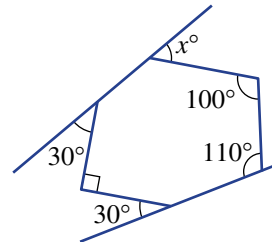

d

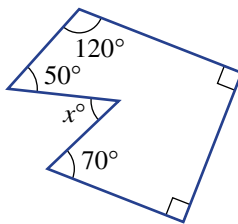

e

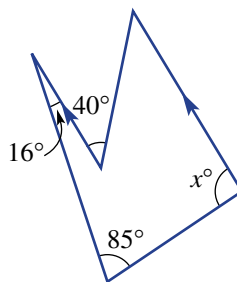

f

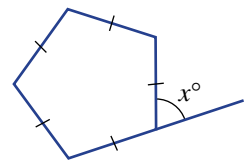

## REASONING

7

7, 8

7-9

- 7 Consider a regular polygon with a very large number of sides ( $n$ ).
- What shape does this polygon look like?
  - Is there a limit to the size of a polygon angle sum or does it increase to infinity as  $n$  increases?
  - What size does each interior angle approach as  $n$  increases?
- 8 a By splitting a pentagon into three triangles, explain why the angle sum of a convex pentagon is  $540^\circ$ .
- Demonstrate that the angle sum of a pentagon will be  $540^\circ$ , even for a non-convex pentagon.
  - Explain why a quadrilateral has an angle sum of  $360^\circ$  and not  $720^\circ$ , even though you could split it into four triangles of  $180^\circ$ , as in this diagram.

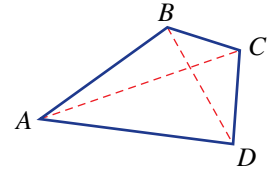

- 9 Let  $S$  be the angle sum of a regular polygon with  $n$  sides.
- State a rule for the size of an interior angle in terms of  $S$  and  $n$ .
  - State a rule for the size of an interior angle in terms of  $n$  only.
  - Use your rule to find the size of an interior angle of these polygons.  
Round to two decimal places where appropriate.
    - regular dodecagon
    - 82-sided regular polygon

## ENRICHMENT: Unknown challenges

-

-

10, 11

- 10 Find the number of sides of a regular polygon if each interior angle is:
- $120^\circ$
  - $162^\circ$
  - $147.272727\dots^\circ$



- 11 With the limited information provided, find the value of  $x$  in these diagrams.

a

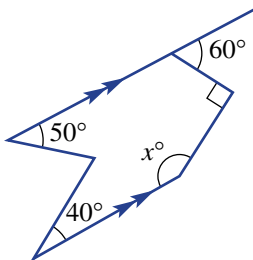

b

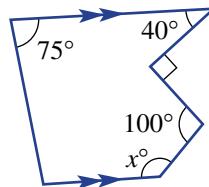

c

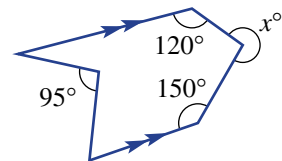

The very 'geometric' CCTV headquarters in Beijing

The following problems will investigate practical situations drawing upon knowledge and skills developed throughout the chapter. In attempting to solve these problems, aim to identify the key information, use diagrams, formulate ideas, apply strategies, make calculations and check and communicate your solutions.

## Designing a spinning wheel

- 1 Kevin is interested in designing a spinning wheel for the school fair. He decides that the spinning wheel should have the numbers 1 to 24 printed on the twenty-four different sectors of the spinning wheel circle.

*Kevin is exploring how varying the spinner's sector angles affects the relative probabilities of the spinner landing on certain numbers.*

- a The wheel is designed so that it is equally likely to land on any number. What will be the angle at the centre of the spinning wheel for each sector?
  - b Kevin wants to introduce the number zero as an additional number that is six times more likely to be landed on than any other number. What will be the sector angle for the number zero? What will be the new sector angle for the other twenty-four numbers?
  - c Instead of including the zero, Kevin decides to make each odd number twice as likely to be landed on compared to each even number. What will be the sector angle for an odd number? What will be the sector angle for an even number?
  - d Kevin wants to stick to just using the numbers from 1 to 24 but has a new idea of making each of the prime numbers the most likely to be landed on. He decides to make the sector angle  $30^\circ$  for each prime number. What will be the sector angle for each of the remaining composite numbers on the spinning wheel?
  - e With this new design, what will be the probability of landing on a prime number?
- Each of Kevin's spinning wheel designs has consisted entirely of acute-angled sectors. His friend Antonio has challenged Kevin to design several spinning wheels with a range of acute, obtuse and reflex angled sectors. There must still be 24 sectors and the minimum sector angle is  $5^\circ$  to ensure that it can be created and the numbers are legible. If possible, provide sector angles for Antonio's spinning wheel challenges below.
- f i Spinning wheel A – must include three obtuse angles
  - ii Spinning wheel B – must include at least one acute, one obtuse and one reflex angle
  - iii Spinning wheel C – must include two reflex angles
  - iv Spinning wheel D – must include one right angle and one obtuse angle

## Designing bow ties

- 2 Jemima is a budding clothes designer who has a fascination for designing bow ties. Each bow tie is made up of two triangles as shown.

*Jemima is interested in how the design of the bow tie influences the size of the internal angles of the two triangles, and vice-versa.*

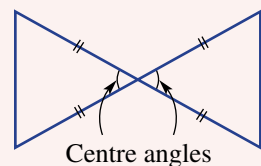



- a** She starts by creating an equilateral bow tie, which contains two equilateral triangles. What is the size of the angles inside the triangles? Illustrate your answer on an accurate diagram.
- b** Jemima decides to create a series of isosceles bow ties. To what size does Jemima need to cut the end angles to make:
- a right-angled isosceles bow tie?
  - an isosceles bow tie with a centre angle of  $30^\circ$ ?
  - an isosceles bow tie with a centre angle of  $140^\circ$ ?
  - an isosceles bow tie with a centre angle of  $y^\circ$ ?
- c** Now assume that all angles must be in a whole number of degrees.
- What is the maximum size to which Jemima can cut the side angles to make an acute isosceles bow tie?
  - What is the minimum size to which Jemima can cut the side angles to make an obtuse isosceles bow tie?
- d** Draw example bow ties matching your answers to parts **c i** and **c ii**, indicating all internal angles involved.

## Pentagons, heptagons and regular stars

- 3** A regular five-pointed star, also known as a pentagram, can be constructed using the vertices of a regular pentagon. Instead of joining adjacent vertices to form a pentagon, a regular five-pointed star is formed by joining non-adjacent vertices.

*Having explored the properties of regular pentagons, we are interested in exploring the properties of these regular stars created from pentagons, and then extending the exploration to seven-pointed stars.*

- Using the pentagon shown, or drawing your own pentagon first, construct a regular five-pointed star by joining non-adjacent vertices (skip one vertex at a time).
- As a result of joining non-adjacent vertices, as well as forming a five-pointed star, how many isosceles triangles have been formed inside the original pentagon?
- What is the name of the centre shape?
- Using your knowledge of angles and polygons, label each of the angles within the different shapes formed by the five-pointed star.
- What is the size of each acute angle in a regular five-pointed star? Mark them on your diagram.
- Extend your exploration of regular stars by constructing seven-pointed stars inside regular heptagons. Can you form two different types of seven-pointed stars? Try joining non-adjacent vertices by skipping one vertex at a time, and then try by skipping two vertices at a time.
- What is the size of each angle in a seven-pointed star formed by joining vertices by:
  - skipping one vertex at a time?
  - skipping two vertices at a time?

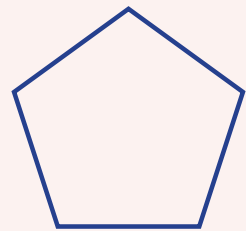

## 2F Three-dimensional solids and Euler's formula

### EXTENDING

#### LEARNING INTENTIONS

- To know the meaning of the terms: polyhedron, prism, pyramid, cylinder, sphere, cone, cube and cuboid
- To be able to name solids using appropriate terminology (e.g. hexagonal prism, square pyramid)
- To be able to use Euler's rule to relate the number of faces, vertices and edges in a polyhedron

A solid occupies three-dimensional space and can take on all sorts of shapes. The outside surfaces could be flat or curved and the number of surfaces will vary depending on the properties of the solid. A solid with all flat surfaces is called a polyhedron, plural *polyhedra* or *polyhedrons*. The word 'polyhedron' comes from the Greek words *poly*, meaning 'many', and *hedron*, meaning 'faces'.



The top of this Canary Wharf building in London (left) is a large, complex polyhedron. Polyhedra also occur in nature, particularly in rock or mineral crystals such as quartz (right).

### Lesson starter: Developing Euler's formula

Create a table with each polyhedron listed below in its own row in column 1 (see below). Include the name and a drawing of each polyhedron. Add columns to the table for faces ( $F$ ), vertices ( $V$ ), edges ( $E$ ) and faces plus vertices added together ( $F + V$ ).

Polyhedron	Drawing	Faces ( $F$ )	Vertices ( $V$ )	Edges ( $E$ )	$F + V$

Count the faces, vertices and edges for each polyhedron and record the numbers in the table.

Tetrahedron



Hexahedron



Pentagonal pyramid

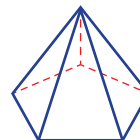

- What do you notice about the numbers in the columns for  $E$  and  $F + V$ ?
- What does this suggest about the variables  $F$ ,  $V$  and  $E$ ? Can you write a rule?
- Add rows to the table, draw your own polyhedra and test your rule by finding the values for  $F$ ,  $V$  and  $E$ .

#### KEY IDEAS

- A **polyhedron** (plural: polyhedra) is a closed solid with flat surfaces (faces), vertices and edges.
  - Polyhedra can be named by their number of faces. For example, tetrahedron (4 faces), pentahedron (5 faces) and hexahedron (6 faces).

- Euler's formula** for polyhedra with  $F$  faces,  $V$  vertices and  $E$  edges is given by:

$$E = F + V - 2$$

- **Prisms** are polyhedra with two identical (congruent) ends. The congruent ends define the **cross-section** of the prism and also its name. The other faces are parallelograms. If these faces are rectangles, as shown, then the solid is called a **right prism**.

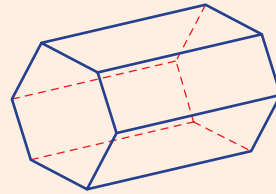

Hexagonal prism

- **Pyramids** are polyhedra with a base face and all other triangular faces meeting at the same vertex point called the apex. They are named by the shape of the base.

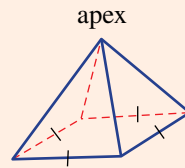

Square Pyramid

- Some solids have **curved** surfaces. Common examples are shown on the right.

Cylinder

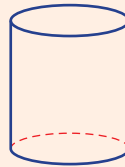

Sphere

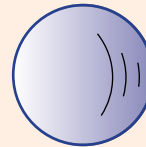

Cone

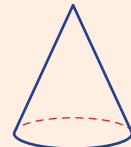

- A **cube** is a hexahedron with six square faces.

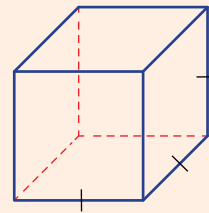

- A **cuboid** is a common name used for a rectangular prism.

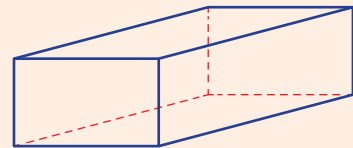

## BUILDING UNDERSTANDING

- State the missing number or word in these sentences.
  - A polyhedron has faces, \_\_\_\_\_ and edges.
  - A heptahedron has \_\_\_\_ faces.
  - A prism has two \_\_\_\_\_ ends.
  - A pentagonal prism has \_\_\_\_ faces.
  - The base of a pyramid has 8 sides. The pyramid is called a \_\_\_\_\_ pyramid.
- Find the value of the pronumeral in these equations.
  - $E = 10 + 16 - 2$
  - $12 = F + 7 - 2$
  - $12 = 6 + V - 2$

3 Count the number of faces, vertices and edges (in that order) on these polyhedra.

a

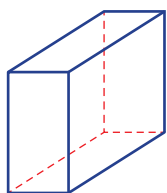

b

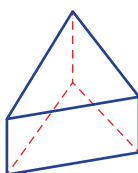

c

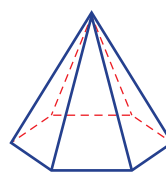

4 Which of these solids are polyhedra (i.e. have only flat surfaces)?

A Cube

B Pyramid

C Cone

D Sphere

E Cylinder

F Rectangular prism

G Tetrahedron

H Hexahedron



### Example 10 Classifying solids

a Classify these solids by considering the number of faces (e.g. octahedron).

i

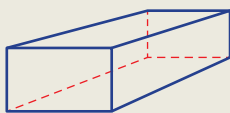

ii

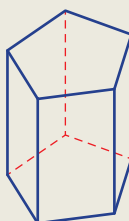

iii

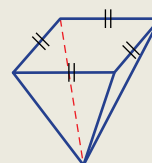

b Name these solids as a type of prism or pyramid (e.g. hexagonal prism or hexagonal pyramid).

#### SOLUTION

a i Hexahedron

ii Heptahedron

iii Pentahedron

b i Rectangular prism

ii Pentagonal prism

iii Square pyramid

#### EXPLANATION

The solid has 6 faces.

The solid has 7 faces.

The solid has 5 faces.

It has two rectangular ends with rectangular sides.

It has two pentagonal ends with rectangular sides.

It has a square base and four triangular faces meeting at an apex.

#### Now you try

a Classify these solids by considering the number of faces (e.g. octahedron).

i

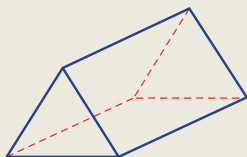

ii

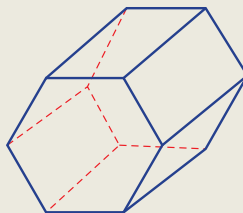

iii

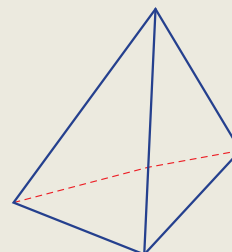

b Name these solids as a type of prism or pyramid (e.g. hexagonal prism or hexagonal pyramid).



### Example 11 Using Euler's formula

Use Euler's formula to find the number of faces on a polyhedron that has 10 edges and 6 vertices.

#### SOLUTION

$$E = F + V - 2$$

$$10 = F + 6 - 2$$

$$10 = F + 4$$

$$F = 6$$

#### EXPLANATION

Write down Euler's formula and make the appropriate substitutions. Solve for  $F$ , which represents the number of faces.

#### Now you try

Use Euler's formula to find the number of vertices on a polyhedron that has 6 faces and 12 edges.

## Exercise 2F

### FLUENCY

1, 2-3(1/2), 4-7

2-3(1/2), 4-8

2-3(1/2), 4, 5, 7, 8

Example 10

- 1 a Classify these solids by considering the number of faces (e.g. octahedron).

i

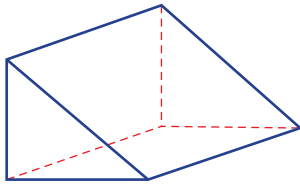

ii

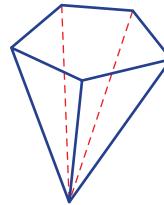

- b Name these solids as a type of prism or pyramid (e.g. hexagonal prism or hexagonal pyramid).

Example 10a

- 2 Name the polyhedron that has the given number of faces.

a 6

b 4

c 5

d 7

e 9

f 10

g 11

h 12

- 3 How many faces do these polyhedra have?

a Octahedron

b Hexahedron

c Tetrahedron

d Pentahedron

e Heptahedron

f Nonahedron

g Decahedron

h Undecahedron

Example 10b

- 4 Name these prisms.

a

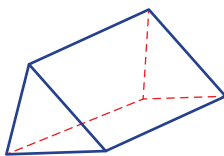

b

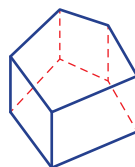

c

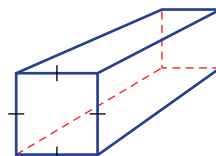

Example 10b

- 5 Name these pyramids.

a

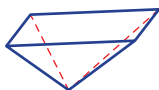

b

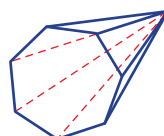

c

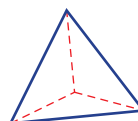

- 6 a Copy and complete this table.

Solid	Number of faces ( $F$ )	Number of vertices ( $V$ )	Number of edges ( $E$ )	$F + V$
Cube				
Square pyramid				
Tetrahedron				
Octahedron				

- b Compare the number of edges ( $E$ ) with the value  $F + V$  for each polyhedron. What do you notice?

Example 11

- 7 Use Euler's formula to calculate the missing numbers in this table.

Faces ( $F$ )	Vertices ( $V$ )	Edges ( $E$ )
6	8	
	5	8
5		9
7		12
	4	6
11	11	

Example 11

- 8 a A polyhedron has 16 faces and 12 vertices. How many edges does it have?  
 b A polyhedron has 18 edges and 9 vertices. How many faces does it have?  
 c A polyhedron has 34 faces and 60 edges. How many vertices does it have?

### PROBLEM-SOLVING

9

9, 10

10, 11

- 9 Decide if the following statements are true or false. Make drawings to help.
- A tetrahedron is a pyramid.
  - All solids with curved surfaces are cylinders.
  - A cube and a rectangular prism are both types of hexahedron.
  - A hexahedron can be a pyramid.
  - There are no solids with 0 vertices.
  - There are no polyhedra with 3 surfaces.
  - All pyramids will have an odd number of faces.
- 10 Decide if it is possible to cut the solid using a single straight cut, to form the new solid given in the brackets.
- Cube (rectangular prism)
  - Square pyramid (tetrahedron)
  - Cylinder (cone)
  - Octahedron (pentahedron)
  - Cube (heptahedron)

- 11 This solid is like a cube but is open at the top and bottom and there is a square hole in the middle forming a tunnel. Count the number of faces ( $F$ ), vertices ( $V$ ) and edges ( $E$ ), and then decide if Euler's rule is true for such solids.

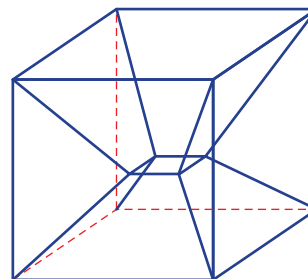

**REASONING** 12 12, 13 13-15

- 12 a A solid with six rectangular faces can be called a cuboid. Give two other names for a solid with six rectangular faces.
- b A pyramid has a base with 10 sides. Name the solid in two ways.
- 13 Rearrange Euler's rule.
  - a Write  $V$  in terms of  $F$  and  $E$ .
  - b Write  $F$  in terms of  $V$  and  $E$ .
- 14 Show that Euler's rule applies for these solids.
  - a Heptagonal pyramid
  - b Octagonal prism
  - c Octahedron
- 15 Decide if the following statements are true or false.
  - a For all pyramids, the number of faces is equal to the number of vertices.
  - b For all convex polyhedra, the sum  $E + V + F$  is even.

**ENRICHMENT: Convex solids** - - 16

16 Earlier you learned that a convex polygon will have all interior angles less than  $180^\circ$ . Notice also that all diagonals in a convex polygon are drawn *inside* the shape.

Convex polygon

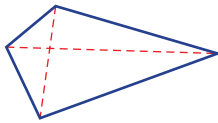

Non-convex polygon

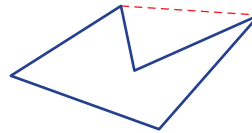

Solids can also be classified as convex or non-convex.

Convex solid

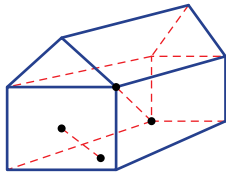

Non-convex solid

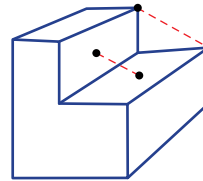

To test for a non-convex solid, join two vertices or two faces with a line segment that passes outside the solid.

a Decide if these solids are convex or non-convex.

i

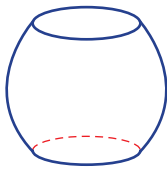

ii

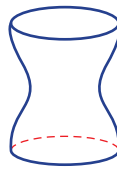

iii



b Draw your own non-convex solids and check by connecting any two vertices or faces with a line segment outside the solid.

## 2G Three-dimensional coordinate systems

### LEARNING INTENTIONS

- To know that the position of objects in three-dimensional (3D) space can be described using a 3D coordinate system
- To be able to describe the position of an object or a point using a 3D coordinate system
- To be able to solve simple geometry problems in 3D space using coordinates

When we find our way around a multi-storey carpark or work with a 3D-printer, we need to consider three-dimensional space. Two dimensions are required to define a space at one level, like zones at ground level in a car park, but a third dimension is required to define spaces above that level. If, for example, a two-dimensional space describes the floor of a 3D printer space, then the third dimension would need to be used to determine the height of the printer nozzle above the floor.



### Lesson starter: Where might 3D coordinates be useful?

We know that when trying to describe the position of a zone in a car park you might try to remember three characters. Two characters for the zone on a level like D4 and another character for the level in the building.

- List two or three other examples where a 3D coordinate system might be used to describe position.
- Choose one of your chosen 3D systems and research how the 3D coordinate system is used to describe position. Write down three or four dot points to summarise your findings.

### KEY IDEAS

- The position of an object in three-dimensional (3D) space can be described using a coordinate system using three components.
- Three axes:  $x$ ,  $y$ , and  $z$  are used to define 3D space.
  - The origin  $O$  has coordinates  $(0, 0, 0)$ .
  - The three axes are all at right angles to each other.
- The position of a cubic unit of space can be described using grid spaces as shown.
  - The red cube in this diagram could be described as  $(B, c, 3)$ .

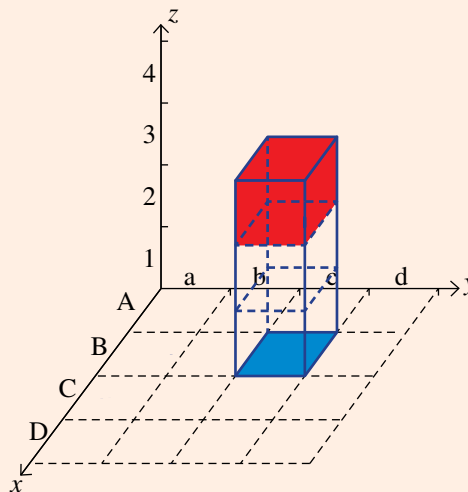



- A point in three-dimensional space is described using  $(x, y, z)$  coordinates.
  - The point  $P$  in this diagram has coordinates  $(1, 2, 4)$ .

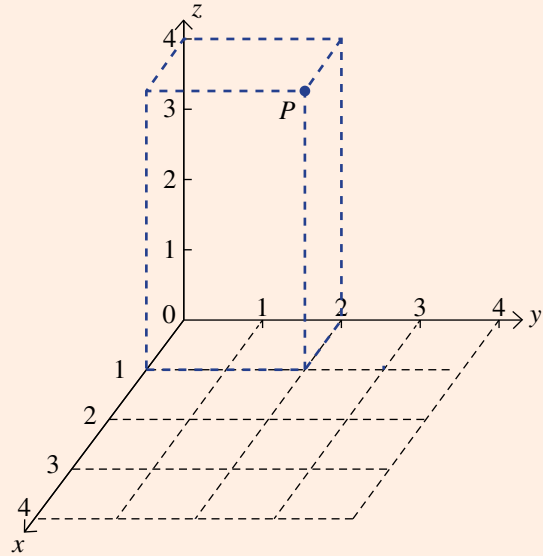

### BUILDING UNDERSTANDING

- 1 Consider this set of two blocks sitting in 3D space.
  - a Which of the following describes the position of the square at the base of the blocks?
 

A $(A, a)$	B $(A, c)$	C $(B, c)$
D $(b, A)$	E $(C, c)$	
  - b Which of the following describes the position of the block which is red?
 

A $(A, a, 2)$	B $(B, c, 3)$	C $(B, c, 2)$
D $(A, c, 2)$	E $(A, c, 1)$	
  - c How many blocks would be required to build a stack where the block at the top is positioned at  $(B, c, 6)$ ?

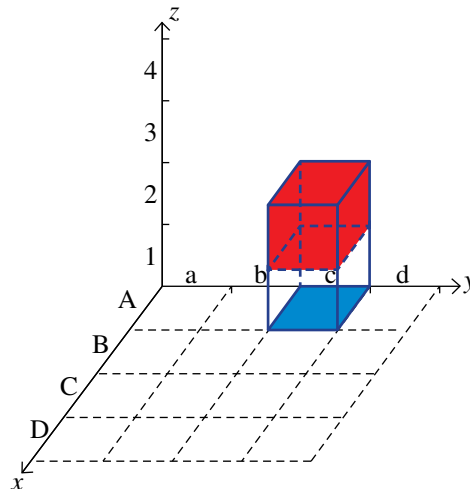

- 2** Consider this 3D coordinate system with point  $P$  as shown.
- a** On the  $x$ - $y$  plane, point  $A$  has coordinates  $(2, 0)$ . Which of the following is the coordinates of point  $A$  in the 3D system?
- |                      |                      |
|----------------------|----------------------|
| <b>A</b> $(2, 0, 1)$ | <b>D</b> $(0, 2, 0)$ |
| <b>B</b> $(2, 0, 3)$ | <b>E</b> $(0, 0, 2)$ |
| <b>C</b> $(2, 0, 0)$ |                      |
- b** What are the 3D coordinates of the following points?
- |              |               |                |
|--------------|---------------|----------------|
| <b>i</b> $B$ | <b>ii</b> $C$ | <b>iii</b> $P$ |
|--------------|---------------|----------------|
- c** Pencil the following points onto the given set of axes.
- |                       |                        |                         |
|-----------------------|------------------------|-------------------------|
| <b>i</b> $A(3, 0, 0)$ | <b>ii</b> $B(3, 3, 0)$ | <b>iii</b> $P(3, 3, 3)$ |
|-----------------------|------------------------|-------------------------|

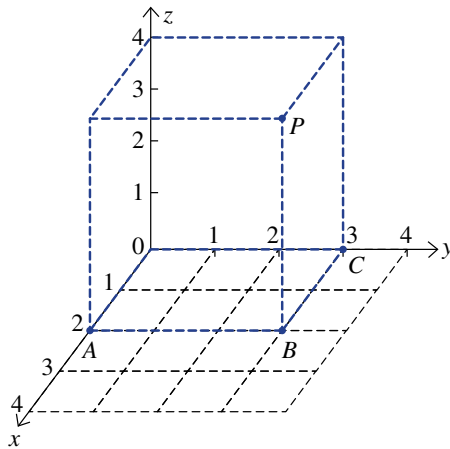

### Example 12 Using grid spaces to describe position in 3D space

Each cube in this 3D space can be described using an  $x(A, B, C \text{ or } D)$ ,  $y(a, b, c \text{ or } d)$  and  $z(1, 2, 3 \text{ or } 4)$  coordinate in that order. Give the coordinates of the cubes with the given colour.

- a** red
- b** yellow
- c** green

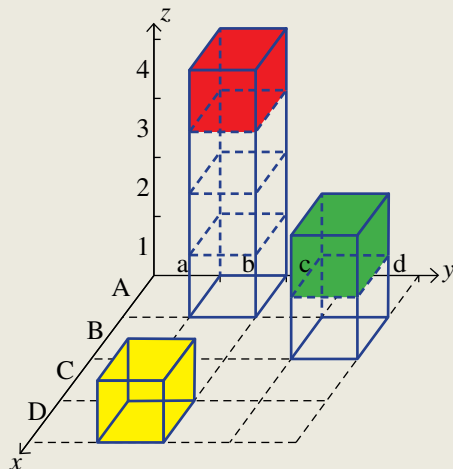

**SOLUTION**

- a (A, b, 4)
- b (D, b, 1)
- c (B, d, 2)

**EXPLANATION**

Using the order  $x$ , then  $y$  then  $z$ , we have the base of the column in the square (A, b) and the red cube is at level 4 on the  $z$ -axis.

The base of the yellow cube is the square (D, b) and it is at level 1 on the  $z$ -axis.

The green cube has a base square at (B, d) and is at level 2 on the  $z$ -axis.

**Now you try**

Each cube in this 3D space can be described using an  $x$ (A, B, C or D),  $y$ (a, b, c or d) and  $z$ (1, 2, 3 or 4) coordinate in that order. Give the coordinates of the cubes with the given colour.

- a red
- b yellow
- c green

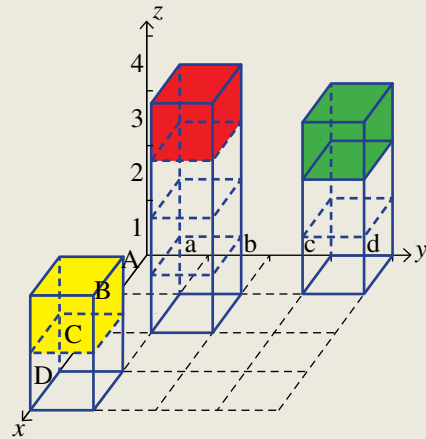

**Example 13 Using 3D coordinates to describe a point**

Write down the coordinates of the following points shown on this 3D graph.

- a A
- b B
- c C
- d P

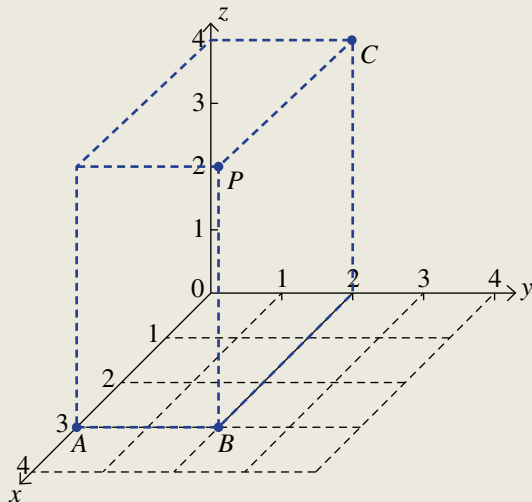

*Continued on next page*

**SOLUTION**
**a** (3, 0, 0)

**b** (3, 2, 0)

**c** (0, 2, 4)

**d** (3, 2, 4)

**EXPLANATION**

 Point  $A$  is positioned at 3 on the  $x$ -axis, 0 on the  $y$ -axis and 0 on the  $z$ -axis.

 Point  $B$  is on the  $x$ - $y$  plane at point (3, 2) and has a  $z$ -coordinate of 0.

 Point  $C$  is on the  $y$ - $z$  plane and so the  $x$ -coordinate is 0.

 On the rectangular prism shown, point  $P$  is aligned with the number 3 on the  $x$ -axis, 2 on the  $y$ -axis and 4 on the  $z$ -axis.

**Now you try**

Write down the coordinates of the following points shown on this 3D graph.

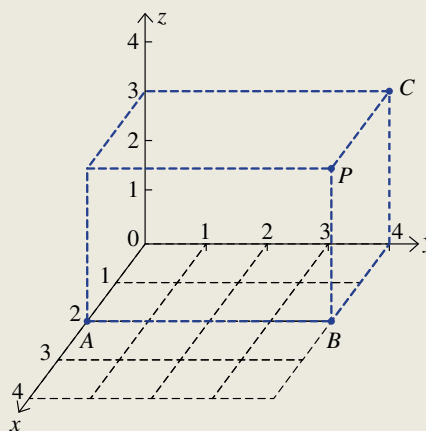
**a**  $A$ 
**b**  $B$ 
**c**  $C$ 
**d**  $P$ 

## Exercise 2G

**FLUENCY**

1–6

2–6

2, 4–6

Example 12

- 1 Each cube in this 3D space can be described using an  $x$  ( $A, B, C$  or  $D$ ),  $y$  ( $a, b, c$  or  $d$ ) and  $z$  (1, 2, 3 or 4) coordinate in that order. Give the coordinates of the cubes with the given colour.

**a** red

**b** yellow

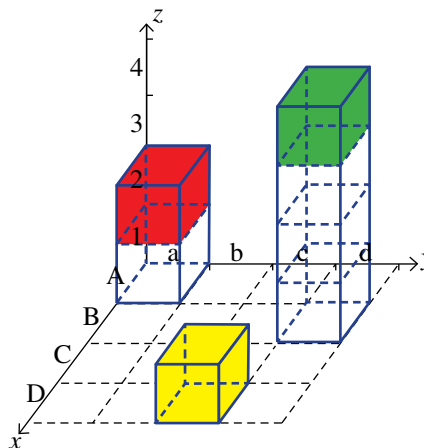
**c** green

2 Each cube in this 3D space can be described using an  $x$  (A, B, C or D),  $y$  (a, b, c or d) and  $z$  (1, 2, 3 or 4) coordinate in that order. Give the coordinates of the cubes with the given colour.

- a red
- b yellow
- c green

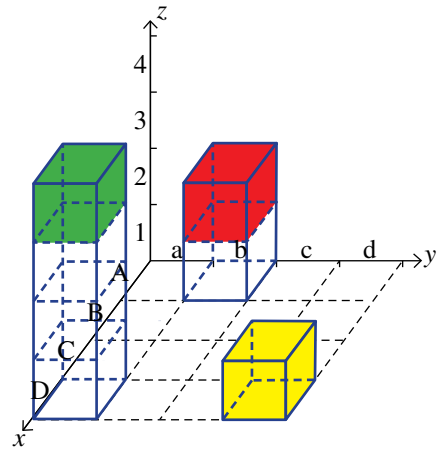

3 Choose the correct square on the 2D diagram (i, ii, iii or iv) that matches the base of the block from the 3D diagram.

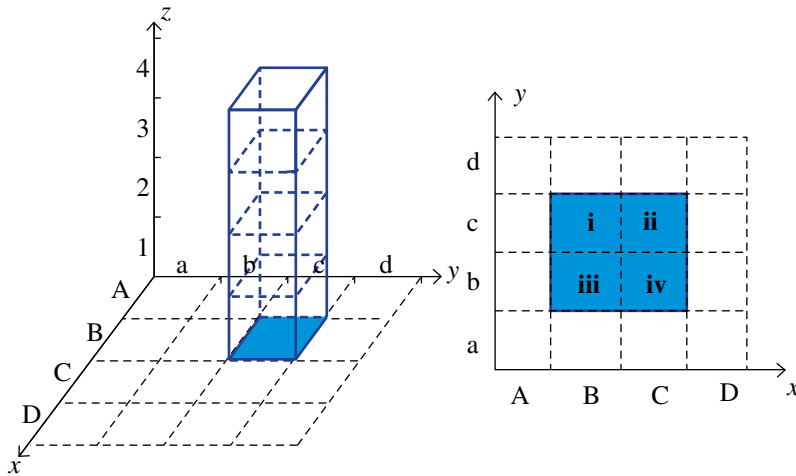

Example 13

4 Write down the coordinates of the following points shown on this 3D graph.

- a A
- b B
- c C
- d P

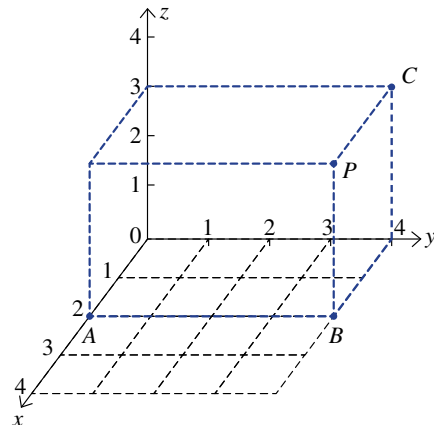

5 Write down the coordinates of the following points shown on this 3D graph.

- a A
- b B
- c C
- d P

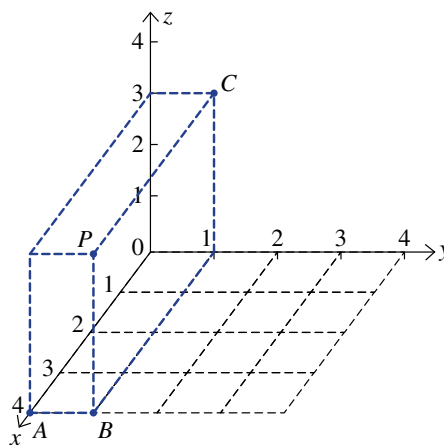

6 Plot the given points onto this 3D coordinate system.

- a A (1, 2, 4)
- b B (3, 1, 2)
- c C (0, 2, 3)
- d D (4, 0, 1)
- e E (3, 3, 0)
- f F (4, 4, 3)

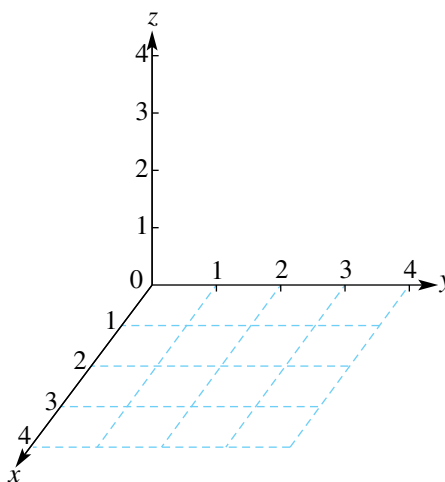

**PROBLEM SOLVING**

7, 8(1/2)

7, 8

8, 9

7 Imagine the cube at (A, a, 1) that can only move in three directions: East (x), North (y) or Up (z). How many spaces would the cube move in total if it was shifted to the positions with the following coordinates?

- a (C, c, 2)
- b (B, a, 3)
- c (A, c, 4)
- d (D, b, 2)
- e (C, d, 4)
- f (B, c, 1)

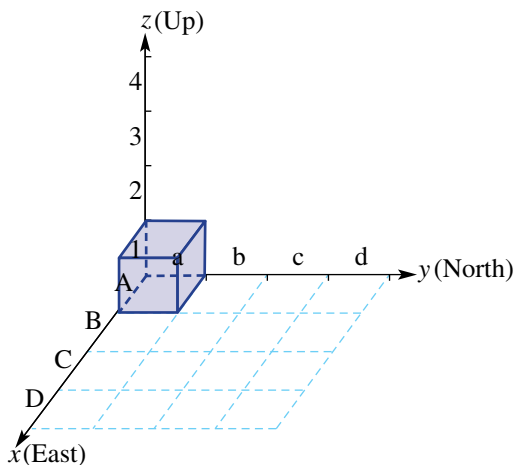

8 A multi-storey carpark has 5 levels and each level is divided into different zones in the same way. The zones for each level are shown in this diagram. A zone which is in the 4th column (East) and 2nd row (North) and on the 3rd level is given the coordinates (D, b, 3).

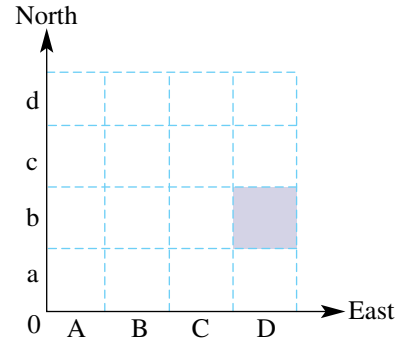

- a Give the coordinates of a zone which is:
  - i in the 3rd column East, 2nd row North and on the 4th level.
  - ii in the 2nd column East, 3rd row North and on the 3rd level.
- b A car is parked in zone (C, a, 2) and is to move two spaces to the West, three spaces to the North and up three levels. What are the coordinates of the zone where the car is to be moved?
- c A car is parked in zone (B, d, 5) and is to move one space to the East, two spaces to the South and down three levels. What are the coordinates of the zone where the car is to be moved?



9 A drone is programmed to only move North/South, East/West and up/down in a system using metres as its units.

- a Find the minimum distance the drone will travel if it moves from the origin (0, 0, 0) to the following points.
  - i (10, 5, 7)
  - ii (20, 35, 40)
  - iii (12, 29, 18)
- b Find the minimum distance the drone will travel if it moves from the point (8, 20, 6) to the following points.
  - i (10, 28, 12)
  - ii (2, 15, 26)
  - iii (0, 20, 30)
- c Find the minimum distance the drone will travel if it moves from the point (−2, 16, 21) to the following points.
  - i (3, 7, 10)
  - ii (10, 0, −4)
  - iii (−40, 4, −20)

**REASONING** 10, 11(1/2) 10,11 10-12

10 Explain why the position of a drone, for example, needs three coordinates rather than just two coordinates.

11 A point  $P$  can be combined with the origin to form a rectangular prism with a certain volume. This diagram shows the point  $P$  producing a rectangular prism with volume  $4 \times 3 \times 2 = 24$  cubic units. Find the volume of the rectangular prisms formed by the following points.

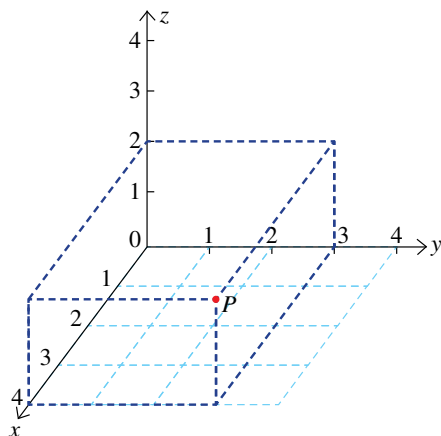

- a  $P(2, 3, 1)$
- b  $P(4, 2, 2)$
- c  $P(5, 3, 2)$
- d  $P(7, 2, 4)$

12 The third dimension (altitude) on a topographical map is defined by the use of contour lines. Each contour line gives the height above sea level. This diagram shows the contour lines of a particular region inside a map where the units are in metres. Use the numbers given on the contour lines to describe the behaviour of the land near the following points.

- a A
- b B
- c C
- d D
- e E

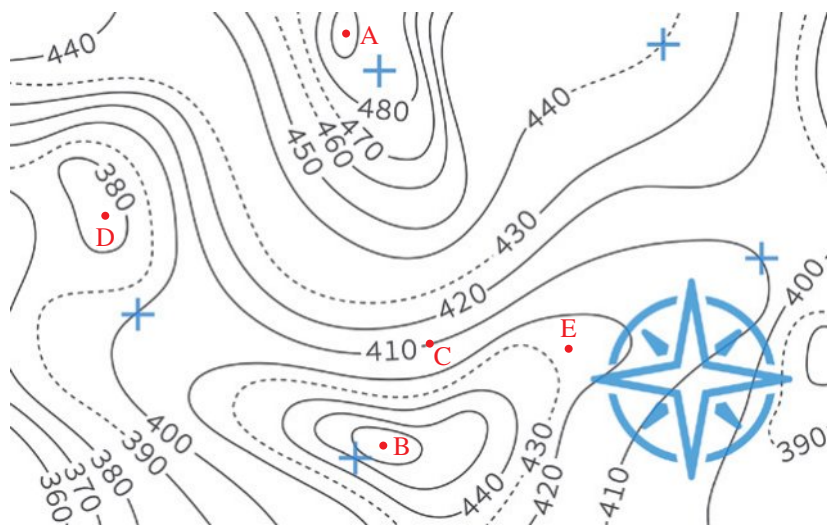



## ENRICHMENT: Aircraft positioning

13

- 13** The position of an aircraft flying above Earth's surface can be determined using three coordinates:
- Latitude – degrees north or south from Earth's equator.
  - Longitude – degrees east or west from the prime meridian line passing through the Royal Observatory in Greenwich, England.
  - Altitude – the height above ground level.
- a** Research latitude and longitude and describe how positions are described on Earth's surface. Include the following information:
- i** how many lines of latitude and longitude are defined for Earth's surface
  - ii** how positions between the lines of latitude and longitude are described using minutes and seconds
  - iii** some examples of objects on Earth's surface and their coordinates.
- b** Describe how an aircraft's position might be described by its latitude, longitude and height above ground level. Give an example.



## Ninja warrior logo

At his workshop, Shane is cutting out soft plastic ninja stars to give to people to play on his Ninja Warrior course.

Shane makes stars that are non-convex quadrilaterals like the one shown. He notices that some of the stars are more popular than others and this seems to depend on the angles formed at each vertex.

Shane works only in multiples of 10 degrees because of the limitation of the equipment that he uses.

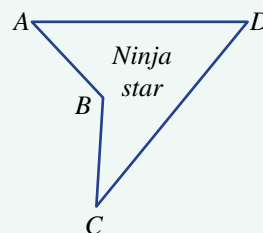

Present a report for the following tasks and ensure that you show clear mathematical workings and explanations where appropriate.

### Preliminary task

- a Shane's 40–140 Ninja star has acute  $\angle ADC = 40^\circ$  and obtuse  $\angle ABC = 140^\circ$ .
  - i Draw an accurate diagram of a star matching this description, and mark in the  $40^\circ$  and  $140^\circ$  angles.
  - ii Find reflex  $\angle ABC$ .
  - iii If  $\angle BAD = 60^\circ$ , find  $\angle BCD$ .
  - iv If  $\angle BCD = 50^\circ$ , find  $\angle BAD$ .
- b Shane also has a 50–150 Ninja star has acute  $\angle ADC = 50^\circ$  and obtuse  $\angle ABC = 150^\circ$ . Draw an accurate diagram of the star and mark in all the internal angles if:
  - i  $\angle BAD = 60^\circ$ .
  - ii  $\angle BCD = 50^\circ$ .
- c What do you notice about the 40–140 and 50–150 stars? Explain why they have some matching angles.

### Modelling task

#### Formulate

- a The problem is to determine all the angles in a range of popular stars so that Shane knows how to manufacture them. Write and draw all the relevant information that will help solve this problem, including the rule for the angle sum of a quadrilateral.



- Solve**
- b** The popular ‘ $2x$ ’ star has the property where obtuse  $\angle ABC = 2\angle ADC$ .
- Find all the internal angles if  $\angle ADC = 70^\circ$  and  $\angle BAD = 60^\circ$ . Draw an accurate diagram to illustrate your star, showing the angle at  $\angle BCD$ .
  - For this type of star, Shane knows not to choose  $\angle ADC = 40^\circ$ . Explain why this would not produce a suitable star. (*Hint*: Try to draw one, marking in all the angles.)
- c** Another popular type is the ‘ $2.5x$ ’ star, which has the property that obtuse  $\angle ABC = 2.5\angle ADC$ .
- Find all the internal angles if  $\angle ADC = 60^\circ$  and  $\angle BAD = 50^\circ$ . Draw an accurate diagram to illustrate your star.
  - If Shane only works with multiples of  $10^\circ$  and uses  $\angle ADC = 60^\circ$ , determine the number of possible stars that he could make.
- Evaluate and verify**
- d** By considering the ‘ $2x$ ’ type of star (where  $\angle ABC = 2\angle ADC$ ), determine the range of angles  $\angle ABC$  that will allow Shane to produce a star that is non-convex.
- e** In the end, Shane decides that the best star is the ‘isosceles’ star, which has the property that  $\angle BAD = \angle BCD$ . Draw some possible isosceles stars that he could produce, given that it should be non-convex and all angles are multiples of  $10^\circ$ .
- Communicate**
- f** Summarise your results and describe any key findings.

### Extension questions

- a** If Shane gets the ability to use multiples of  $5^\circ$ , describe some new  $2x$ ,  $2.5x$  and isosceles stars that are now possible to create that were not possible before.
- b** One type of isosceles star is called the ‘perpendicular’ star. It has the segment  $BC$  perpendicular to  $AD$ . Investigate the possible angles and shapes of perpendicular stars using  $\angle ADC = d^\circ$ . (You can assume that angles are multiples of  $5^\circ$ .)



## 3D city model

### Key technology: Dynamic geometry

From previous studies, we know that the two-dimensional Cartesian plane allows us to construct and analyse two-dimensional shapes and graph relationships between two variables. When a third dimension is added, we can construct and analyse three-dimensional (3D) solids. This is achieved by using a three-dimensional coordinate system  $(x, y, z)$  where all three axes are perpendicular to each other and intersect at the origin  $(0, 0, 0)$ . Such 3D coordinate systems are used by engineers and architects to explore building designs and build city landscapes.

### 1 Getting started

The 3D coordinate system uses coordinates with three components  $(x, y, z)$ . A point  $P$  in 3D space will therefore have an  $x$ -coordinate, a  $y$ -coordinate and a  $z$ -coordinate.

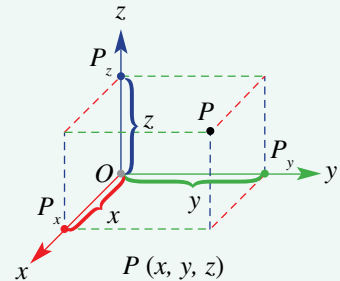

- a For the point  $P(3, 4, 3)$  shown in this set of 3D axes, answer the following.
- State the value of the  $x$ -coordinate,  $y$ -coordinate and  $z$ -coordinate.
  - What is the height of the point  $P$  above the  $x$ - $y$  plane?
  - How far is the point  $P$  from the  $x$ - $z$  plane?
  - How far is the point  $P$  from the  $y$ - $z$  plane?

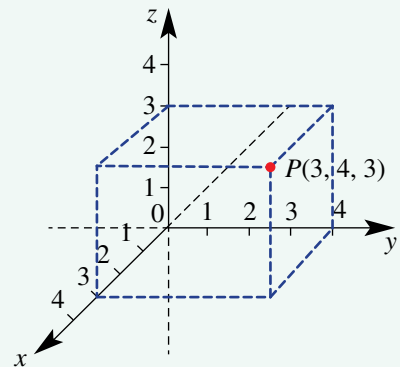

- b Use a 3D coordinate system to plot these points.
- $(0, 2, 4)$
  - $(2, 5, 3)$
  - $(4, 1, 0)$

### 2 Using technology

- Find a 3D dynamic geometry package, like Geogebra 3D, and spend a few moments becoming familiar with its functions.
- Try constructing a rectangular prism as shown on the next page. This example is shown to be a cube if you consider the coordinates of the vertices and side lengths.
- Label the coordinates of the eight vertices and confirm that they are correct by checking how they align with the scale on the three axes.

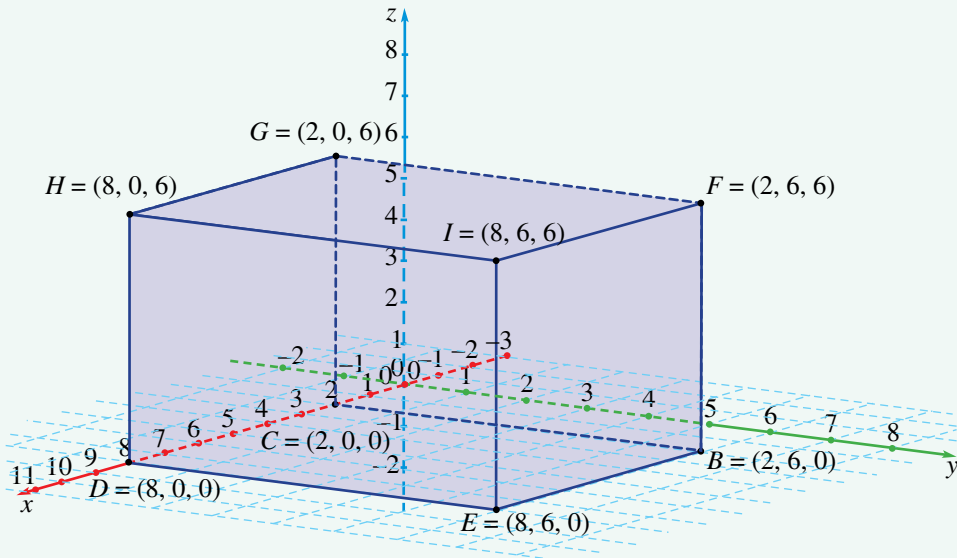

### 3 Applying an algorithm

- a We will construct a simple city landscape by adding two or three other rectangular prisms to your 3D graph. Follow this algorithm for each prism.

Step 1: Use the Polygon tool to construct a four-sided polygon on the  $x$ - $y$  plane. This is usually achieved by selecting the tool then clicking at four points on the  $x$ - $y$  plane and also at the starting point again to finish.

Step 2: Use the Prism or Extrude to prism tool to construct a rectangular prism of a certain altitude of your choice.

Step 3: Adjust the position of your prism (representing buildings) by moving one of the vertices of the polygon base. Also add gaps between prisms to represent city streets.

- b List the coordinates of the vertices of each added building (prism).

### 4 Extension

- a Add further prisms to your city landscape construction so that it might resemble a city block. Take into account the positions of streets and parks.
- b Search your 3D geometry tool and find how you can add other solids, including cylinders and pyramids. For each solid, note its dimensions and any vertex coordinates.

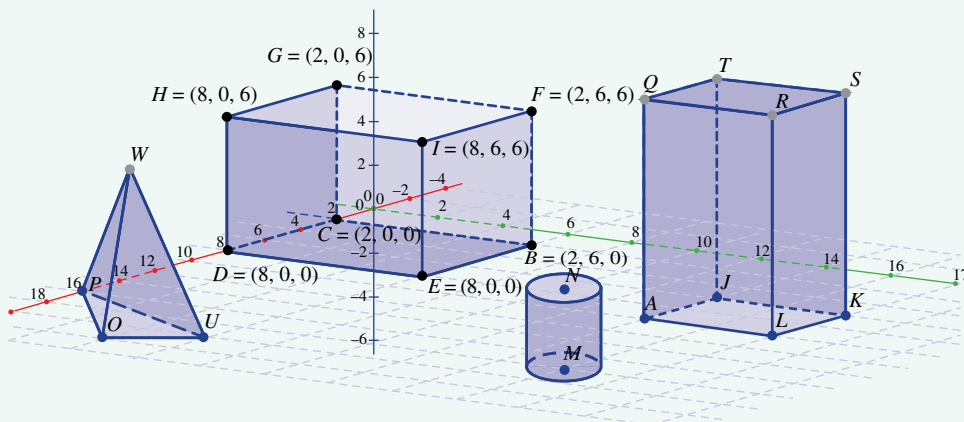

## Constructions

Geometric construction involves a precise set of mathematical and geometric operations that do not involve any approximate measurements or other guess work. The basic tools for geometric construction are a pair of compasses, a straight edge and a pencil or pen. Interactive geometry or drawing packages can also be used, and include digital equivalents of these tools.

For the following constructions, use only a pair of compasses, a straight edge and a pencil.

Alternatively, use interactive geometry software and adapt the activities where required.

### Perpendicular line

- 1 Construct:
  - a a segment  $AB$
  - b a circle with centre  $A$
  - c a circle with centre  $B$
  - d a line joining the intersection points of the two circles.

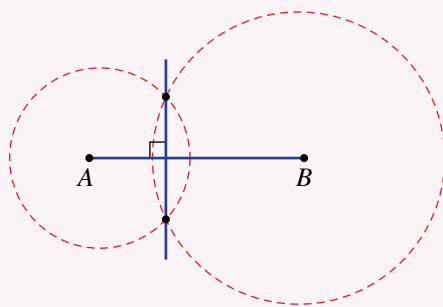

### Perpendicular bisector

- 2 Repeat the construction for a perpendicular line, but ensure that the two circles have the same radius. If interactive geometry is used, use the length of the segment  $AB$  for the radius of both circles.

### A $60^\circ$ angle

- 3 Construct:
  - a a ray  $AB$
  - b an arc with centre  $A$
  - c the intersection point  $C$
  - d an arc with centre  $C$  and radius  $AC$
  - e a point  $D$  at the intersection of the two arcs
  - f a ray  $AD$ .

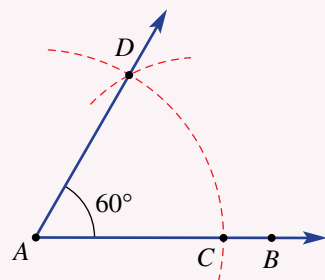

### Equilateral triangle

- 4 Repeat the construction for a  $60^\circ$  angle, and then construct the segment  $CD$ .

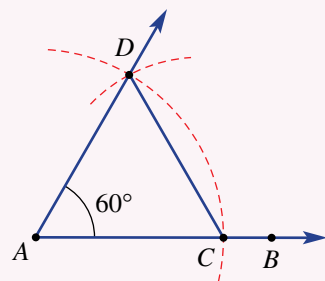

## Angle bisector

- 5 Construct:
- any angle  $\angle BAC$
  - an arc with centre  $A$
  - the two intersection points  $D$  and  $E$
  - two arcs of equal radius with centres at  $D$  and  $E$
  - the intersection point  $F$
  - the ray  $AF$ .

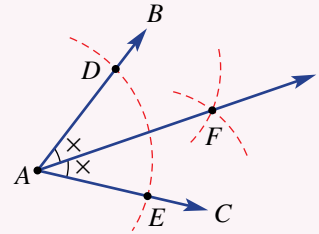

## Parallel line through a point

- 6 Construct:
- a line  $AB$  and point  $P$
  - an arc with centre  $A$  and radius  $AP$
  - the intersection point  $C$
  - an arc with centre  $C$  and radius  $AP$
  - an arc with centre  $P$  and radius  $AP$
  - the intersection point  $D$
  - the line  $PD$ .

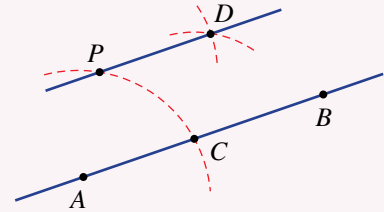

## Rhombus

- 7 Repeat the construction for a parallel line through a point and construct the segments  $AP$  and  $CD$ .

## Construction challenges

- 8 For a further challenge, try to construct these objects. No measurement is allowed.
- |  |                 |
|--|-----------------|
| a $45^\circ$ angle                           | b square        |
| c perpendicular line at the end of a segment | d parallelogram |
| e regular hexagon                            |                 |



1 This shape includes 12 matchsticks. (To solve these puzzles all matches remaining must connect to other matches at both ends.)

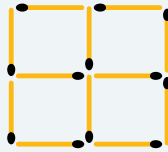

- a Remove 2 matchsticks to form 2 squares.
- b Move 3 matchsticks to form 3 squares.

2 a Use 9 matchsticks to form 5 equilateral triangles.  
 b Use 6 matchsticks to form 4 equilateral triangles.

3 Find the value of  $x$  in these diagrams.

a

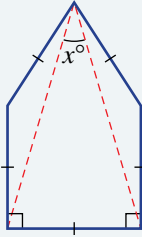

b

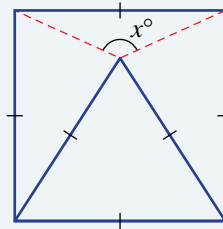

**Up for a challenge?**  
 If you get stuck on a question, check out the 'Working with unfamiliar problems' poster at the end of the book to help you.



4 Find the size of  $\angle ABC$  in this quadrilateral.

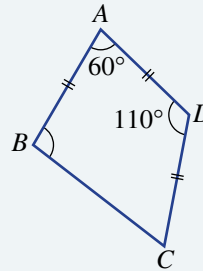

5 If  $\angle ROS = 75^\circ$ , find the size of all other angles.

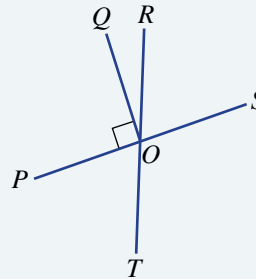

6 Find the value of  $a + b + c + d + e$  in this star. Give reasons for your answer.

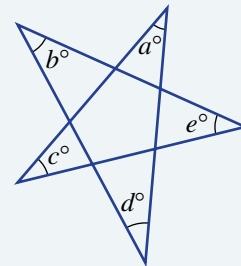



**Complementary angles**



$a + 25 = 90$   
 $a = 65$

**Supplementary angles**



$a + 125 = 180$   
 $a = 55$

**Parallel lines**

- Corresponding angles are equal ( $a = b$ )
- Alternate angles are equal ( $a = c$ )
- Co-interior angles are supplementary ( $a + d = 180$ )

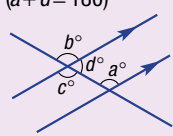
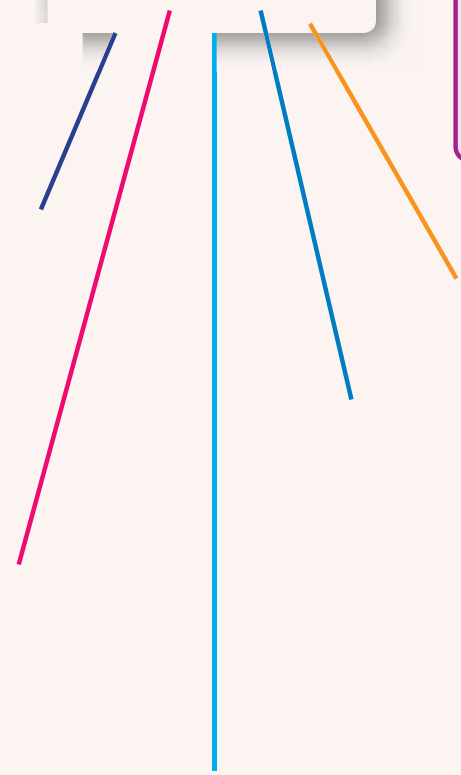
# Chapter checklist with success criteria

A printable version of this checklist is available in the Interactive Textbook



2A

**1. I can find angles at a point using complementary, supplementary or vertically opposite angles.**  
e.g. Determine the value of the pronumerals in this diagram.

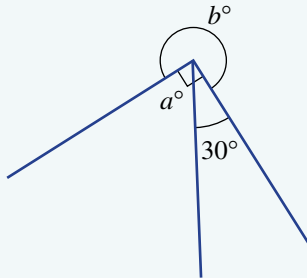

2B

**2. I can find angles using parallel lines and explain my answers using correct terminology.**  
e.g. Find the value of the pronumerals in this diagram, giving reasons.

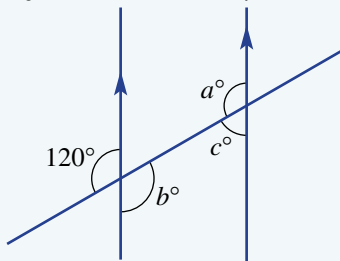

2C

**3. I can find unknown angles in a triangle using the angle sum.**  
e.g. Find the value of  $a$  in this triangle.

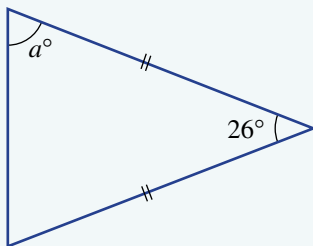

2C

**4. I can use the exterior angle theorem.**  
e.g. Find the value of  $a$  in this diagram.

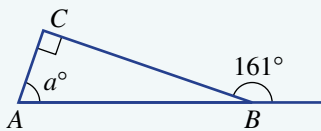

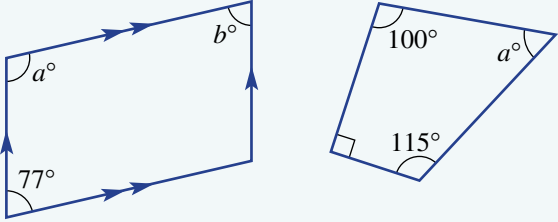
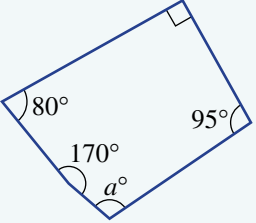
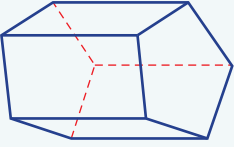
2D	<p><b>5. I can find unknown angles in a quadrilateral.</b> e.g. Find the value of the pronumerals in these quadrilaterals.</p> 	<input checked="" type="checkbox"/>   <input type="checkbox"/>
2E	<p><b>6. I can find the angle sum of a polygon and use it to find unknown angles.</b> e.g. Find the angle sum of a pentagon and use it to find the value of <math>a</math> in this diagram.</p> 	<span style="border: 1px solid red; border-radius: 50%; padding: 2px;">Ext</span>   <input type="checkbox"/>
2E	<p><b>7. I can find the size of each interior angle in a regular polygon.</b> e.g. Find the size of an interior angle in a regular octagon.</p>	<span style="border: 1px solid red; border-radius: 50%; padding: 2px;">Ext</span>  <input type="checkbox"/>
2F	<p><b>8. I can classify solids by their number of faces and by their appropriate name.</b> e.g. Explain why this solid is a heptahedron and state its name (using a name like hexagonal prism or square pyramid).</p> 	<span style="border: 1px solid red; border-radius: 50%; padding: 2px;">Ext</span>   <input type="checkbox"/>
2F	<p><b>9. I can use Euler's rule.</b> e.g. Use Euler's rule to find the number of faces on a polyhedron that has 10 edges and 6 vertices.</p>	<span style="border: 1px solid red; border-radius: 50%; padding: 2px;">Ext</span>  <input type="checkbox"/>

2G

**10. I can use grid spaces to describe a position in 3D space.**

e.g. Using the given coordinate system, give the coordinates of the red cube.

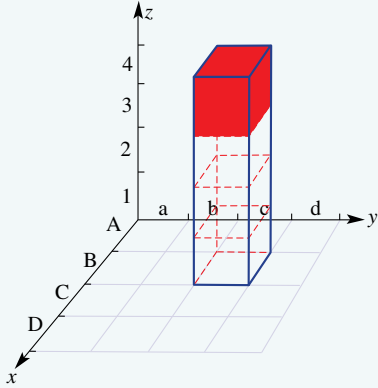

2G

**11. I can describe a point in three-dimensional space using an  $(x, y, z)$  coordinate system.**

e.g. What are the coordinates of the points A, B, C and P?

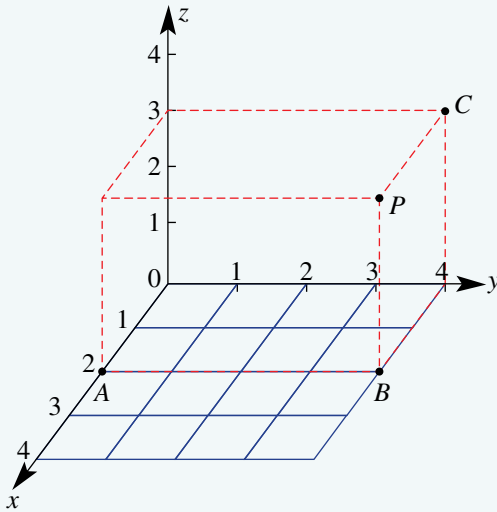

## Short-answer questions

2A

1 Find the value of  $a$  in these diagrams.

a

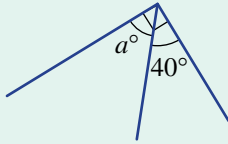

c

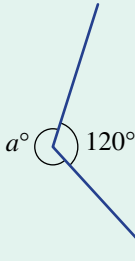

e

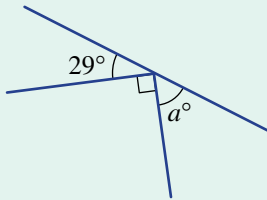

b

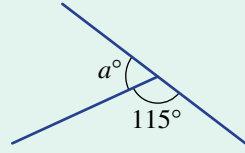

d

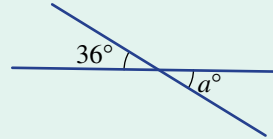

f

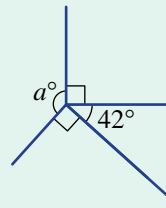

2B

2 These diagrams include parallel lines. Find the value of  $a$ .

a

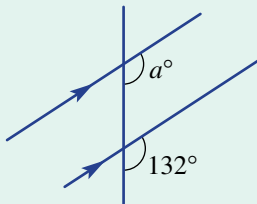

c

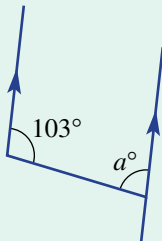

e

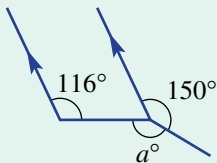

b

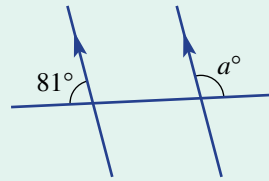

d

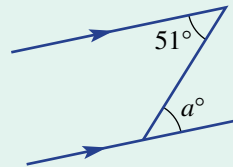

f

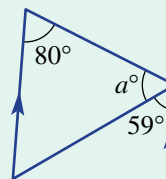

2B

- 3 Use the dashed construction line to help find the size of  $\angle AOB$  in this diagram.

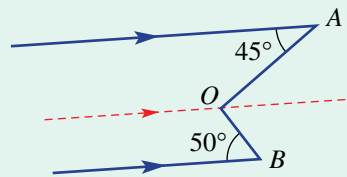

2C

- 4 Classify each triangle (scalene, isosceles, equilateral, acute, right or obtuse) and find the value of  $a$ .

a

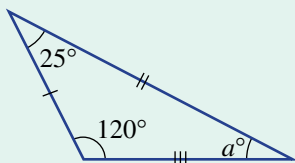

b

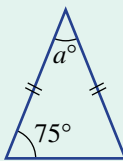

c

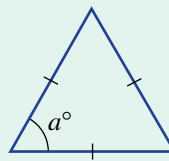

d

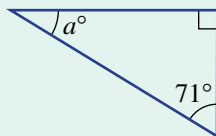

e

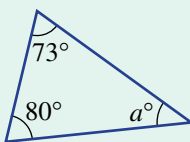

f

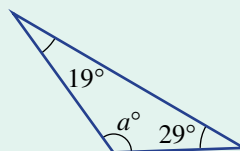

2C

- 5 These triangles include exterior angles. Find the value of  $a$ .

a

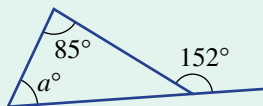

b

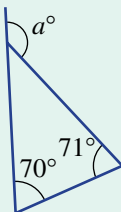

c

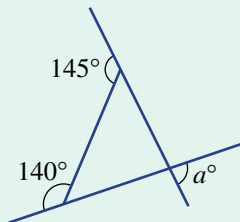

2D

- 6 Find the value of  $a$  and  $b$  in these quadrilaterals.

a

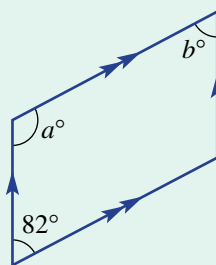

b

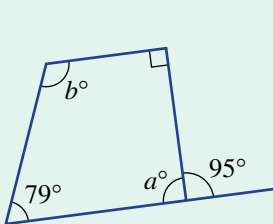

c

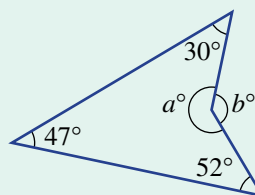

2E

- 7 Find the angle sum of these polygons.

a heptagon

b nonagon

c 62-sided polygon

Ext

2E

- 8 Find the size of an interior angle of these regular polygons.

a regular pentagon

b regular dodecagon

Ext

2E

9 Find the value of  $a$ .

Ext

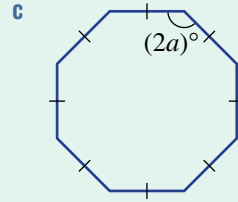
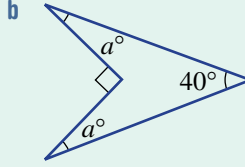
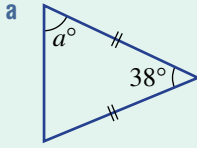

2F

10 Name the polyhedron that has:

Ext

a 6 faces

b 10 faces

c 11 faces.

2F

11 What type of prism or pyramid are these solids?

Ext

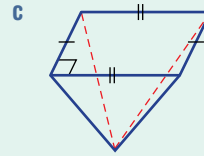
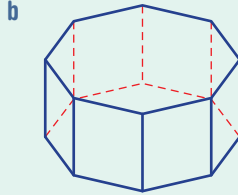
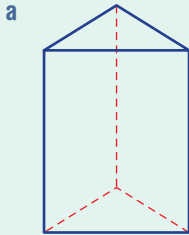

2F

12 Complete this table for polyhedra with number of faces  $F$ , vertices  $V$  and edges  $E$ .

Ext

$F$	$V$	$E$
5	5	
9		21
	10	15

13 Using the given coordinate system, give the coordinates of the red cube.

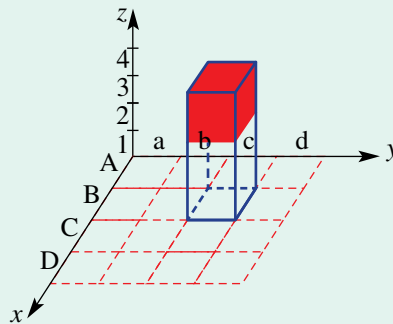

14 Give the coordinates of the following points.

- a A
- b B
- c C
- d D

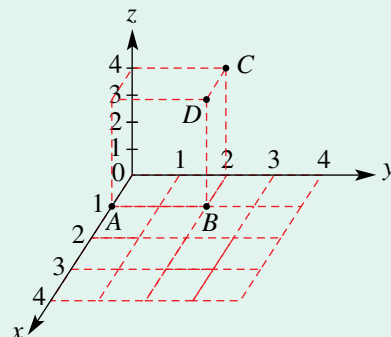

- 15 Find the value of  $x$  in this diagram. (Hint: draw in a third parallel line.)

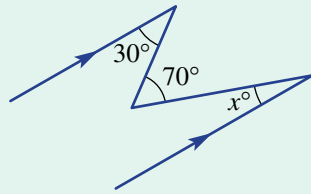

### Multiple-choice questions

2A

- 1 What is the name given to two angles that sum to  $90^\circ$ ?

A Right

B Supplementary

C Revolutionary

D Complementary

E Vertically opposite

2C

- 2 The value of  $a$  in this diagram is equal to:

A  $b + c$

B  $c + d$

C  $b + d$

D  $180 - a$

E  $d + 180$

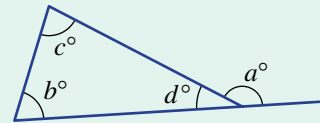

2B

- 3 The value of  $a$  in this diagram is equal to:

A 45

B 122

C 241

D 119

E 61

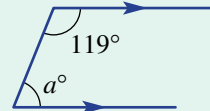

2C

- 4 The size of an exterior angle on an equilateral triangle is:

A  $60^\circ$

B  $120^\circ$

C  $180^\circ$

D  $100^\circ$

E  $45^\circ$

2D

- 5 The most general quadrilateral whose diagonals intersect at right angles and has 2 pairs of equal length sides is a:

A square

B rhombus

C kite

D parallelogram

E rectangle

2E

- 6 The rule for the angle sum  $S$  of a polygon with  $n$  sides is:

A  $S = n \times 180^\circ$

B  $S \times n = 180^\circ$

C  $S = (n - 1) \times 180^\circ$

D  $S = (n - 2) \times 180^\circ$

E  $S = (n + 2) \times 180^\circ$

2E

- 7 The name given to an 11-sided polygon is:

A heptagon

B elevenagon

C decagon

D dodecagon

E undecagon

Ext

Ext





# 3

## Fractions, decimals and percentages

### Maths in context: The value of gold jewellery

Gold is a soft metal and quite expensive, so gold has other metals like silver, copper or zinc melted into it. The proportion of gold in jewellery is measured on a scale of 0 to 24 karat (K) or carat (ct). The current value of gold, named the 'gold spot price' per gram, can be found on the internet.

When buying gold jewellery, would you like to know the percentage and value of the gold in it? You can calculate these measures using your fraction, percentage and decimal skills.

Suppose a gold necklace on eBay is advertised as 'solid gold, 9 K, 20 g'. The word 'solid' doesn't mean

it is pure gold. The calculations below find the value of gold in this necklace.

1. 9-karat gold is  $\frac{9}{24} \times 100 = 37.5\%$  gold.
2. This 20g necklace has  $\frac{37.5}{100} \times 20 = 7.5$  g gold.
3. If gold is \$34.25/g, this necklace has a gold value of  $34.25 \times 7.5 = \$256.88$ .

Sometimes gold objects are rated by the number of grams of gold per 1000 g. Gold rated at 916.7 is 91.67% pure or 22 karat. A rating of 999.9 shows 99.99% purity or 24 karat and is called fine or pure gold.



## Chapter contents

- 3A** Equivalent fractions (**CONSOLIDATING**)
- 3B** Operations with fractions (**CONSOLIDATING**)
- 3C** Operations with negative fractions
- 3D** Understanding decimals (**CONSOLIDATING**)
- 3E** Operations with decimals (**CONSOLIDATING**)
- 3F** Terminating decimals, recurring decimals and rounding
- 3G** Converting fractions, decimals and percentages (**CONSOLIDATING**)
- 3H** Finding a percentage and expressing as a percentage
- 3I** Decreasing and increasing by a percentage
- 3J** Calculating percentage change, profit and loss
- 3K** Solving percentage problems using the unitary method (**EXTENDING**)

## Victorian Curriculum 2.0

This chapter covers the following content descriptors in the Victorian Curriculum 2.0:

### NUMBER

VC2M8N01, VC2M8N03, VC2M8N04, VC2M8N05, VC2M8N06

Please refer to the curriculum support documentation in the teacher resources for a full and comprehensive mapping of this chapter to the related curriculum content descriptors.

© VCAA

## Online resources

A host of additional online resources are included as part of your Interactive Textbook, including HOTmaths content, video demonstrations of all worked examples, auto-marked quizzes and much more.

## 3A Equivalent fractions CONSOLIDATING

### LEARNING INTENTIONS

- To understand what equivalent fractions are
- To understand that fractions have a numerical value, and two distinct fractions, like  $\frac{3}{5}$  and  $\frac{6}{10}$ , can have the same numerical value
- To be able to simplify fractions

Fractions are extremely useful in practical situations whenever a proportion is required. Fractions are used by a chef measuring the ingredients for a cake, a builder measuring the weight of materials for concrete and a musician using computer software to create music.

A fraction is formed when a whole number or amount is divided into equal parts. The bottom number is referred to as the denominator and tells you how many parts the whole is divided up into. The top number is referred to as the numerator and tells you how many of the parts you have selected.



Carpenters use equivalent fractions. For example, to calculate the drill bit size in the middle of  $\frac{1}{8}$  and  $\frac{5}{32}$ , Equivalent fractions are  $\frac{8}{64}$  and  $\frac{10}{64}$ , giving the required drill bit size  $\frac{9}{64}$ .

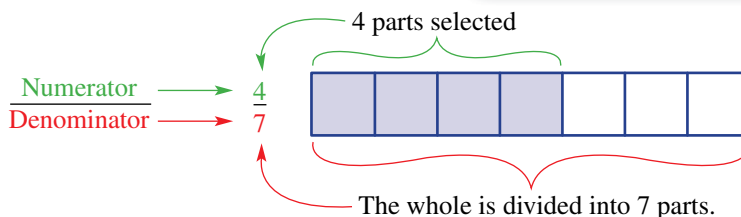

Equivalent fractions are fractions that represent equal portions of a whole amount and so are equal in value. The skill of generating equivalent fractions is needed whenever you add or subtract fractions with different denominators.

### Lesson starter: Know your terminology

It is important to know and understand key terms associated with the study of fractions.

Working with a partner and using your previous knowledge of fractions, write a one-sentence definition or explanation for each of the following key terms.

- Numerator
- Equivalent fraction
- Improper fraction
- Multiples
- Reciprocal
- Lowest common multiple
- Ascending
- Composite number
- Denominator
- Proper fraction
- Mixed numeral
- Factors
- Highest common factor
- Descending
- Lowest common denominator

## KEY IDEAS

- **Equivalent fractions** are equal in value. They mark the same place on a number line.

For example:  $\frac{3}{5}$  and  $\frac{6}{10}$  are equivalent fractions.

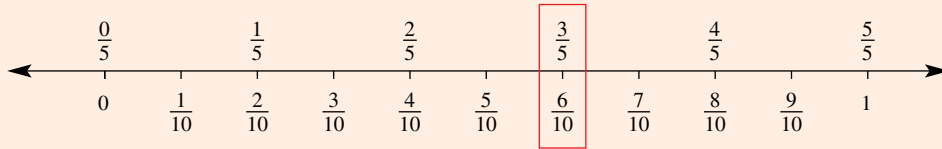

- Equivalent fractions can be produced by multiplying the numerator and the denominator by the same whole number.

For example:  $\frac{2}{7} = \frac{10}{35}$   $\therefore \frac{2}{7}$  and  $\frac{10}{35}$  are equivalent fractions.

*(Diagram: Red arrows show 2 multiplied by 5 to get 10, and 7 multiplied by 5 to get 35.)*

- Equivalent fractions can also be produced by dividing the numerator and the denominator by the same common factor.

For example:  $\frac{6}{21} = \frac{2}{7}$   $\therefore \frac{6}{21}$  and  $\frac{2}{7}$  are equivalent fractions.

*(Diagram: Red arrows show 6 divided by 3 to get 2, and 21 divided by 3 to get 7.)*

- The **simplest form** of a fraction is an equivalent fraction with the lowest possible whole numbers in the numerator and denominator. This is achieved by dividing the numerator and the denominator by their highest common factor (HCF). In the simplest form of a fraction, the HCF of the numerator and the denominator is 1.

For example:  $\frac{12}{18}$  The HCF of 12 and 18 is 6.

$\frac{12}{18} = \frac{2}{3}$   $\therefore \frac{12}{18}$  written in simplest form is  $\frac{2}{3}$ .

*(Diagram: Red arrows show 12 divided by 6 to get 2, and 18 divided by 6 to get 3.)*

This technique is also known as ‘cancelling’.

$$\frac{12}{18} = \frac{2 \times \cancel{6}^1}{3 \times \cancel{6}^1} = \frac{2}{3}$$

The HCF is cancelled (divided) from the numerator and the denominator.

$\frac{6}{6}$  ‘cancels’ to 1 because  $6 \div 6 = 1$

- Two fractions are equivalent if and only if they have the same numerator and denominator when they are written in simplest form.

## BUILDING UNDERSTANDING

1 State the missing numbers to complete the following strings of equivalent fractions.

a  $\frac{3}{5} = \frac{\square}{10} = \frac{12}{\square} = \frac{120}{\square}$

b  $\frac{4}{7} = \frac{8}{\square} = \frac{\square}{70} = \frac{80}{\square}$

c  $\frac{3}{9} = \frac{\square}{3} = \frac{2}{\square} = \frac{14}{\square}$

d  $\frac{18}{24} = \frac{6}{\square} = \frac{\square}{4} = \frac{15}{\square}$

2 Which of the following fractions are equivalent to  $\frac{2}{3}$ ?

$\frac{2}{30}$   $\frac{4}{9}$   $\frac{4}{6}$   $\frac{20}{30}$   $\frac{1}{2}$   $\frac{4}{3}$   $\frac{10}{15}$   $\frac{20}{36}$

3 Are the following statements true or false?

a  $\frac{1}{2}$  and  $\frac{1}{4}$  are equivalent fractions.

b  $\frac{3}{6}$  and  $\frac{1}{2}$  are equivalent fractions.

c  $\frac{14}{21}$  can be simplified to  $\frac{2}{3}$ .

d  $\frac{4}{5}$  can be simplified to  $\frac{2}{5}$ .

e The fraction  $\frac{8}{9}$  is written in its simplest form.

f  $\frac{11}{99}$  and  $\frac{1}{9}$  and  $\frac{2}{18}$  are all equivalent fractions.



### Example 1 Generating equivalent fractions

Rewrite the following fractions with a denominator of 40.

a  $\frac{3}{5}$

b  $\frac{1}{2}$

c  $\frac{7}{4}$

d  $\frac{36}{120}$

#### SOLUTION

a  $\frac{3}{5} = \frac{24}{40}$

b  $\frac{1}{2} = \frac{20}{40}$

c  $\frac{7}{4} = \frac{70}{40}$

d  $\frac{36}{120} = \frac{12}{40}$

#### EXPLANATION

Denominator has been multiplied by 8.  
Numerator must be multiplied by 8.

Multiply numerator and denominator by 20.

Multiply numerator and denominator by 10.

Divide numerator and denominator by 3.

#### Now you try

Rewrite the following fractions with a denominator of 50.

a  $\frac{4}{5}$

b  $\frac{1}{2}$

c  $\frac{11}{10}$

d  $\frac{80}{200}$



## Example 2 Converting fractions to simplest form

Write the following fractions in simplest form.

a  $\frac{8}{20}$

b  $\frac{25}{15}$

### SOLUTION

a  $\frac{8}{20} = \frac{2}{5}$

+4  
+4

b  $\frac{25}{15} = \frac{5}{3}$

+5  
+5

### EXPLANATION

The HCF of 8 and 20 is 4.

Both the numerator and the denominator are divided by the HCF of 4.

The HCF of 25 and 15 is 5.

Both the numerator and the denominator are divided by the HCF of 5.

### Now you try

Write the following fractions in simplest form.

a  $\frac{10}{24}$

b  $\frac{40}{25}$

## Exercise 3A

### FLUENCY

$1-6(\frac{1}{2})$

$2-6(\frac{1}{2})$

$2-6(\frac{1}{4})$

Example 1

1 Rewrite the following fractions with a denominator of 24.

a  $\frac{1}{3}$

b  $\frac{2}{8}$

c  $\frac{1}{2}$

d  $\frac{5}{12}$

e  $\frac{3}{1}$

f  $\frac{5}{1}$

g  $\frac{3}{4}$

h  $\frac{7}{8}$

Example 1

2 Rewrite the following fractions with a denominator of 30.

a  $\frac{1}{5}$

b  $\frac{2}{6}$

c  $\frac{5}{10}$

d  $\frac{3}{1}$

e  $\frac{2}{3}$

f  $\frac{22}{60}$

g  $\frac{5}{2}$

h  $\frac{150}{300}$

3 Find the missing value to make the statement true.

a  $\frac{2}{5} = \frac{\square}{15}$

b  $\frac{7}{9} = \frac{14}{\square}$

c  $\frac{7}{14} = \frac{1}{\square}$

d  $\frac{21}{30} = \frac{\square}{10}$

e  $\frac{4}{3} = \frac{\square}{21}$

f  $\frac{8}{5} = \frac{80}{\square}$

g  $\frac{3}{12} = \frac{\square}{60}$

h  $\frac{7}{11} = \frac{28}{\square}$

- 4 State the missing numerators and denominators for the following sets of equivalent fractions.

a  $\frac{1}{2} = \frac{\square}{4} = \frac{\square}{6} = \frac{\square}{10} = \frac{\square}{20} = \frac{\square}{32} = \frac{\square}{50}$

b  $\frac{2}{5} = \frac{\square}{10} = \frac{\square}{15} = \frac{\square}{20} = \frac{\square}{35} = \frac{\square}{50} = \frac{\square}{75}$

c  $\frac{1}{3} = \frac{2}{\square} = \frac{4}{\square} = \frac{8}{\square} = \frac{10}{\square} = \frac{25}{\square} = \frac{100}{\square}$

d  $\frac{5}{4} = \frac{10}{\square} = \frac{15}{\square} = \frac{35}{\square} = \frac{55}{\square} = \frac{100}{\square} = \frac{500}{\square}$

- Example 2** 5 Write the following fractions in simplest form.

a  $\frac{3}{9}$

b  $\frac{4}{8}$

c  $\frac{10}{12}$

d  $\frac{15}{18}$

e  $\frac{11}{44}$

f  $\frac{12}{20}$

g  $\frac{16}{18}$

h  $\frac{25}{35}$

i  $\frac{15}{9}$

j  $\frac{22}{20}$

k  $\frac{120}{100}$

l  $\frac{64}{48}$

-  6 Using your calculator, express the following fractions in simplest form.

a  $\frac{23}{92}$

b  $\frac{34}{85}$

c  $\frac{375}{875}$

d  $\frac{315}{567}$

e  $\frac{143}{121}$

f  $\frac{707}{404}$

g  $\frac{1197}{969}$

h  $\frac{2673}{1650}$

### PROBLEM-SOLVING

7

7, 8

8, 9

- 7 Three of the following eight fractions are not written in simplest form. Write down these three fractions and simplify them.

$$\frac{17}{31} \quad \frac{14}{42} \quad \frac{5}{11} \quad \frac{51}{68} \quad \frac{23}{93} \quad \frac{15}{95} \quad \frac{1}{15} \quad \frac{13}{31}$$

- 8 Group the following 12 fractions into six pairs of equivalent fractions.

$$\frac{5}{11} \quad \frac{3}{5} \quad \frac{7}{21} \quad \frac{8}{22} \quad \frac{2}{7} \quad \frac{20}{50} \quad \frac{6}{21} \quad \frac{9}{15} \quad \frac{15}{33} \quad \frac{1}{3} \quad \frac{16}{44} \quad \frac{6}{15}$$

- 9 A 24-hour swim-a-thon was organised to raise funds for a local charity. The goal was to swim 1500 laps during the 24-hour event. After 18 hours, a total of 1000 laps had been swum.

- On the basis of time, what fraction, in simplest form, of the swim-a-thon had been completed?
- On the basis of laps, what fraction, in simplest form, of the swim-a-thon had been completed?
- Were the swimmers on target to achieve their goal? Explain your answer by using equivalent fractions.





## REASONING

10

10, 11

10, 12

- 10 a A particular fraction has a prime number in the numerator and a different prime number in the denominator. Using some examples, justify whether or not this fraction can be simplified.
- b A fraction has a composite number in the numerator and a different composite number in the denominator. Using some examples, justify whether or not this fraction can be simplified.

- 11 a A pizza is cut into eight equal pieces. Can it be shared by four people in such a way that no two people receive an equivalent fraction of the pizza?
- b A pizza is cut into 12 equal pieces. Can it be shared by four people in such a way that no-one receives the same amount of the pizza?
- c What is the least number of pieces into which a pizza can be cut such that four people can share it and each receive a different amount?



- 12 Are there a finite or an infinite number of fractions that are equivalent to  $\frac{1}{2}$ ? Justify your answer.

## ENRICHMENT: Equivalent algebraic fractions

-

-

13

- 13 Algebraic fractions contain pronumerals (letters).  $\frac{3a}{5}$  and  $\frac{x}{y}$  are both examples of algebraic fractions.

- a Find the missing term (shown as  $\square$ ) to produce equivalent algebraic fractions.

i  $\frac{2a}{3b} = \frac{4a}{\square}$

ii  $\frac{x}{y} = \frac{\square}{5y}$

iii  $\frac{3b}{20} = \frac{12b}{\square}$

iv  $\frac{4de}{p} = \frac{\square}{3p}$

v  $\frac{a}{b} = \frac{ac}{\square}$

vi  $\frac{3k}{2t} = \frac{\square}{2tm}$

vii  $\frac{4a}{5b} = \frac{\square}{20bc}$

viii  $\frac{x}{y} = \frac{\square}{y^2}$

- b Simplify the following algebraic fractions.

i  $\frac{15b}{20}$

ii  $\frac{4}{8y}$

iii  $\frac{3x}{5x}$

iv  $\frac{5y}{8xy}$

v  $\frac{10p}{15qp}$

vi  $\frac{120y}{12xy}$

vii  $\frac{mnop}{mnpq}$

viii  $\frac{15x}{5x^2}$

- c Can an algebraic fraction be simplified to a non-algebraic fraction? Justify your answer by using examples.
- d Can a non-algebraic fraction have an equivalent algebraic fraction? Justify your answer by using examples.

## 3B Operations with fractions CONSOLIDATING

### LEARNING INTENTIONS

- To be able to add and subtract fractions by first finding a lowest common multiple of the denominators
- To be able to multiply and divide fractions
- To understand that an integer can be written as a fraction with 1 as the denominator
- To be able to perform the four operations on mixed numerals, converting to improper fractions as required

This section reviews the different techniques involved in adding, subtracting, multiplying and dividing fractions. Proper fractions, improper fractions and mixed numerals will be considered for each of the four mathematical operations.



Aviation engineers and mechanics require fraction skills. It is critical that jet turbine engine components are accurate to  $\frac{1}{1000}$ th of an inch. Paint  $\frac{1}{64}$  inches thick, on an aluminium panel  $\frac{5}{32}$  inches thick, increases the panel thickness to  $\frac{11}{64}$  inches.

### Lesson starter: You write the question

Here are six different answers:  $\frac{1}{8}$ ,  $\frac{1}{4}$ ,  $\frac{1}{2}$ ,  $\frac{3}{4}$ , 2,  $-\frac{1}{4}$ .

Your challenge is to write six different questions which will produce each of the above six answers. Each question must use only the two fractions  $\frac{1}{2}$  and  $\frac{1}{4}$  and one operation (+, −, ×, ÷).

### KEY IDEAS

#### ■ Adding and subtracting fractions

- When we add or subtract fractions, we count how many we have of a certain ‘type’ of fraction. For example, we could count eighths: 3 eighths plus 5 eighths minus 1 eighth equals 7 eighths. When we count ‘how many’ eighths, the answer must be in eighths.

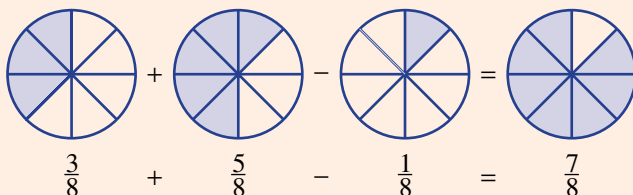

- Denominators *must* be the same before you can proceed with adding or subtracting fractions.
- If the denominators are different, use the lowest common multiple (LCM) of the denominators to find equivalent fractions.
- When the denominators are the same, simply add or subtract the numerators as required. The denominator remains the same.

In this example we are counting sixths: 3 sixths plus 4 sixths equals 7 sixths.

$$\begin{array}{l}
 \textcircled{1} \text{ Equivalent fractions} \quad \frac{1}{2} + \frac{2}{3} \quad \leftarrow \text{Different denominators} \\
 \quad \quad \quad \quad \quad \quad = \frac{3}{6} + \frac{4}{6} \quad \leftarrow \text{Same denominators} \\
 \textcircled{2} \text{ Add numerators} \quad \quad \quad = \frac{7}{6} \quad \leftarrow \text{Denominator stays the same}
 \end{array}$$

### Common multiple and lowest common multiple (LCM)

- A common multiple is found by multiplying whole numbers together.
- The LCM is found by multiplying the whole numbers together and then dividing by the HCF of the whole numbers.

For example, consider the whole numbers 4 and 6.

A common multiple is 24 ( $4 \times 6$ ). The LCM is 12 ( $\frac{4 \times 6}{2}$ ).

- The lowest common denominator (LCD) is the lowest common multiple (LCM) of the denominators.

### Multiplying fractions

For example:

$$\begin{aligned}
 \frac{1}{2} \text{ of } \frac{3}{4} &= \frac{1}{2} \times \frac{3}{4} \\
 &= \frac{3}{8}
 \end{aligned}$$

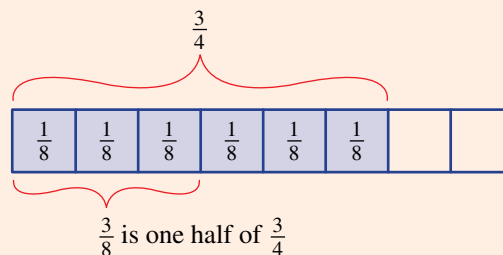
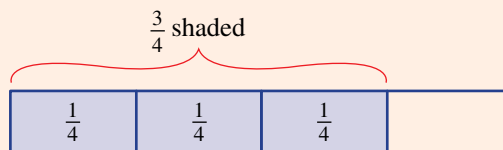

- Denominators *do not* need to be the same before you can proceed with fraction multiplication.
- Simply multiply the numerators together and multiply the denominators together.
- Mixed numerals must be converted to improper fractions before you proceed.
- If possible, simplify or 'cancel' fractions before multiplying.

For example:

$$\frac{2}{3} \times \frac{5}{9} = \frac{2 \times 5}{3 \times 9} = \frac{10}{27}$$

↑ Multiply numerators together.  
 ↓ Multiply denominators together.

### Dividing fractions

For example:

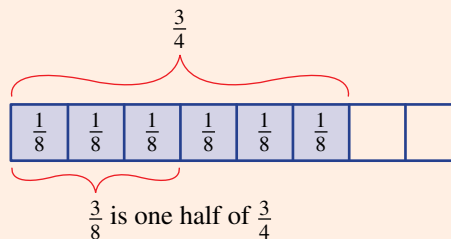
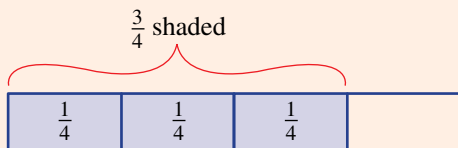

$$\frac{3}{4} \div \frac{1}{4} \text{ is the same as 'how many quarters } \left(\frac{1}{4}\right) \text{ are in } \frac{3}{4}?$$

$$\frac{3}{4} \div \frac{1}{4} = \frac{3}{4} \times \frac{4}{1} = 3$$

$$\frac{3}{4} \div 2 \text{ is the same as 'one half of } \frac{3}{4}.'$$

$$\frac{3}{4} \div 2 = \frac{3}{4} \times \frac{1}{2} = \frac{3}{8}$$

- Denominators *do not* need to be the same before you can proceed.
- Mixed numerals should be converted to improper fractions before you proceed.
- To divide by a fraction, multiply by its reciprocal.
- The **reciprocal** of a fraction is found by swapping the numerator and the denominator. This is known as inverting the fraction.

Proceed as for multiplying fractions.

$$\text{For example: } \frac{3}{8} \div \frac{5}{4} = \frac{3}{8} \times \frac{4}{5} = \frac{12}{40} = \frac{3}{10}$$

### Checking your answer

- Final answers should be written in simplest form.
- It is common to write answers involving improper fractions as mixed numerals.

## Summary

### Adding and subtracting fractions

When the denominators are the same, simply add or subtract the numerators. The denominator remains the same.

### Multiplying fractions

Cancel where possible, then multiply the numerators together and multiply the denominators together.

### Dividing fractions

To divide by a fraction, multiply by its reciprocal.

## BUILDING UNDERSTANDING

- 1 a Which two operations require the denominators to be the same before proceeding?  
b Which two operations do not require the denominators to be the same before proceeding?
- 2 a For which two operations must you first convert mixed numerals to improper fractions?  
b For which two operations can you choose whether or not to convert mixed numerals to improper fractions before proceeding?
- 3 State the LCD for the following pairs of fractions.  
a  $\frac{1}{5} + \frac{3}{4}$       b  $\frac{2}{9} + \frac{5}{3}$       c  $\frac{11}{25} + \frac{7}{10}$       d  $\frac{5}{12} + \frac{13}{8}$
- 4 State the missing numbers in the empty boxes.  
a  $\frac{2}{3} + \frac{1}{4}$   
 $= \frac{8}{12} + \frac{\square}{12}$   
 $= \frac{11}{\square}$   
b  $\frac{7}{8} - \frac{9}{16}$   
 $= \frac{\square}{16} - \frac{9}{16}$   
 $= \frac{\square}{16}$   
c  $1\frac{4}{7} \times \frac{3}{5}$   
 $= \frac{\square}{7} \times \frac{3}{5}$   
 $= \frac{\square}{35}$   
d  $\frac{5}{7} \div \frac{2}{3}$   
 $= \frac{5}{7} \square \frac{3}{2}$   
 $= \frac{15}{\square} = \square \frac{\square}{14}$
- 5 State the reciprocal of the following fractions.  
a  $\frac{5}{8}$       b  $\frac{3}{2}$       c  $3\frac{1}{4}$       d  $1\frac{1}{11}$



## Example 3 Adding and subtracting fractions

Simplify:

a  $\frac{3}{5} + \frac{4}{5}$

b  $\frac{5}{3} - \frac{3}{4}$

## SOLUTION

a  $\frac{3}{5} + \frac{4}{5} = \frac{7}{5}$  or  $1\frac{2}{5}$

b  $\frac{5}{3} - \frac{3}{4} = \frac{20}{12} - \frac{9}{12}$   
 $= \frac{11}{12}$

## EXPLANATION

The denominators are the same, therefore count the number of fifths by simply adding the numerators.

The final answer can be written as a mixed numeral or an improper fraction.

LCM of 3 and 4 is 12.

Write equivalent fractions with a denominator of 12.

The denominators are the same, so subtract the numerators.

## Now you try

Simplify:

a  $\frac{4}{7} + \frac{6}{7}$

b  $\frac{7}{5} - \frac{1}{2}$



### Example 4 Adding and subtracting mixed numerals

Simplify:

a  $3\frac{5}{8} + 2\frac{3}{4}$

b  $2\frac{1}{2} - 1\frac{5}{6}$

#### SOLUTION

$$\begin{aligned} \text{a } 3\frac{5}{8} + 2\frac{3}{4} &= \frac{29}{8} + \frac{11}{4} \\ &= \frac{29}{8} + \frac{22}{8} \\ &= \frac{51}{8} \text{ or } 6\frac{3}{8} \end{aligned}$$

**Alternative method:**

$$\begin{aligned} 3\frac{5}{8} + 2\frac{3}{4} &= 3 + 2 + \frac{5}{8} + \frac{3}{4} \\ &= 5 + \frac{5}{8} + \frac{6}{8} \\ &= 5 + \frac{11}{8} = 6\frac{3}{8} \end{aligned}$$

$$\begin{aligned} \text{b } 2\frac{1}{2} - 1\frac{5}{6} &= \frac{5}{2} - \frac{11}{6} \\ &= \frac{15}{6} - \frac{11}{6} \\ &= \frac{4}{6} = \frac{2}{3} \end{aligned}$$

#### EXPLANATION

Convert mixed numerals to improper fractions.

The LCM of 8 and 4 is 8.

Write equivalent fractions with LCD.

Add numerators together, denominator remains the same.

Add the whole number parts together.

The LCM of 8 and 4 is 8.

Write equivalent fractions with LCD.

Add fraction parts together and simplify the answer.

Convert mixed numerals to improper fractions.

The LCD of 2 and 6 is 6.

Write equivalent fractions with LCD.

Subtract numerators and simplify the answer.

#### Now you try

Simplify:

a  $1\frac{2}{3} + 4\frac{1}{6}$

b  $2\frac{1}{3} - 1\frac{1}{2}$



### Example 5 Multiplying fractions

Simplify:

a  $\frac{2}{5} \times \frac{3}{7}$

b  $\frac{8}{5} \times \frac{7}{4}$

c  $3\frac{1}{3} \times 2\frac{2}{5}$

#### SOLUTION

$$\begin{aligned} \text{a } \frac{2}{5} \times \frac{3}{7} &= \frac{2 \times 3}{5 \times 7} \\ &= \frac{6}{35} \end{aligned}$$

$$\begin{aligned} \text{b } \frac{2\cancel{8}}{5} \times \frac{7}{\cancel{4}} &= \frac{2 \times 7}{5 \times 1} \\ &= \frac{14}{5} \text{ or } 2\frac{4}{5} \end{aligned}$$

$$\begin{aligned} \text{c } 3\frac{1}{3} \times 2\frac{2}{5} &= \frac{2\cancel{10}}{1\cancel{3}} \times \frac{4\cancel{12}}{1\cancel{5}} \\ &= \frac{2 \times 4}{1 \times 1} \\ &= \frac{8}{1} = 8 \end{aligned}$$

#### EXPLANATION

Multiply the numerators together.  
Multiply the denominators together.  
The answer is in simplest form.

Cancel first. Then multiply numerators together and denominators together.  
Write the answer as an improper fraction or mixed numeral.

Convert to improper fractions first.  
Simplify fractions by cancelling.  
Multiply 'cancelled' numerators and 'cancelled' denominators together.  
Write the answer in simplest form.

#### Now you try

Simplify:

a  $\frac{3}{5} \times \frac{7}{8}$

b  $\frac{7}{8} \times \frac{16}{3}$

c  $4\frac{1}{2} \times 1\frac{2}{5}$



Is it possible to calculate what fraction of the blocks are either pink or yellow?



### Example 6 Dividing fractions

Simplify:

a  $\frac{2}{5} \div \frac{3}{7}$

b  $\frac{5}{8} \div \frac{15}{16}$

c  $2\frac{1}{4} \div 1\frac{1}{3}$

#### SOLUTION

$$\begin{aligned} \text{a } \frac{2}{5} \div \frac{3}{7} &= \frac{2}{5} \times \frac{7}{3} \\ &= \frac{14}{15} \end{aligned}$$

$$\begin{aligned} \text{b } \frac{5}{8} \div \frac{15}{16} &= \frac{\cancel{15}^1}{8} \times \frac{16^2}{\cancel{15}_3} \\ &= \frac{1}{1} \times \frac{2}{3} \\ &= \frac{2}{3} \end{aligned}$$

$$\begin{aligned} \text{c } 2\frac{1}{4} \div 1\frac{1}{3} &= \frac{9}{4} \div \frac{4}{3} \\ &= \frac{9}{4} \times \frac{3}{4} \\ &= \frac{27}{16} \text{ or } 1\frac{11}{16} \end{aligned}$$

#### EXPLANATION

Change  $\div$  sign to a  $\times$  sign and invert the divisor (the second fraction).

Proceed as for multiplication.

Multiply numerators together and multiply denominators together.

Change  $\div$  sign to a  $\times$  sign and invert the divisor (the second fraction). Cancel common factors.

Proceed as for multiplication.

Convert mixed numerals to improper fractions.

Change  $\div$  sign to  $\times$  sign and invert the divisor (the second fraction).

Proceed as for multiplication.

#### Now you try

Simplify:

a  $\frac{3}{5} \div \frac{7}{8}$

b  $\frac{5}{7} \div \frac{20}{21}$

c  $2\frac{1}{3} \div 1\frac{3}{4}$

## Exercise 3B

### FLUENCY

1, 2-7( $\frac{1}{2}$ )2-8( $\frac{1}{2}$ )2-8( $\frac{1}{4}$ )

Example 3

1 Simplify:

a  $\frac{1}{7} + \frac{3}{7}$

b  $\frac{4}{9} + \frac{1}{9}$

c  $\frac{11}{5} - \frac{7}{5}$

d  $\frac{7}{8} - \frac{4}{8}$

Example 3

2 Simplify:

a  $\frac{1}{5} + \frac{2}{5}$

b  $\frac{3}{8} + \frac{1}{8}$

c  $\frac{7}{9} - \frac{2}{9}$

d  $\frac{7}{10} - \frac{3}{10}$

e  $\frac{3}{4} + \frac{2}{5}$

f  $\frac{3}{10} + \frac{4}{5}$

g  $\frac{5}{7} - \frac{2}{3}$

h  $\frac{11}{18} - \frac{1}{6}$



**Example 4** 3 Simplify:

a  $3\frac{1}{7} + 1\frac{3}{7}$

b  $7\frac{2}{5} + 2\frac{1}{5}$

c  $3\frac{5}{8} - 1\frac{2}{8}$

d  $8\frac{5}{11} - 7\frac{3}{11}$

e  $5\frac{1}{3} + 4\frac{1}{6}$

f  $17\frac{5}{7} + 4\frac{1}{2}$

g  $6\frac{1}{2} - 2\frac{3}{4}$

h  $4\frac{2}{5} - 2\frac{5}{6}$

**Example 5a,b** 4 Simplify:

a  $\frac{3}{5} \times \frac{1}{4}$

b  $\frac{2}{9} \times \frac{5}{7}$

c  $\frac{7}{5} \times \frac{6}{5}$

d  $\frac{5}{3} \times \frac{8}{9}$

e  $\frac{4}{9} \times \frac{3}{8}$

f  $\frac{12}{10} \times \frac{5}{16}$

g  $\frac{12}{9} \times \frac{2}{5}$

h  $\frac{24}{8} \times \frac{5}{3}$

**Example 5c** 5 Simplify:

a  $2\frac{3}{4} \times 1\frac{1}{3}$

b  $3\frac{2}{7} \times \frac{1}{3}$

c  $4\frac{1}{6} \times 3\frac{3}{5}$

d  $10\frac{1}{2} \times 3\frac{1}{3}$

**Example 6a,b** 6 Simplify:

a  $\frac{2}{9} \div \frac{3}{5}$

b  $\frac{1}{3} \div \frac{2}{5}$

c  $\frac{8}{7} \div \frac{11}{2}$

d  $\frac{11}{3} \div \frac{5}{2}$

e  $\frac{3}{4} \div \frac{6}{7}$

f  $\frac{10}{15} \div \frac{1}{3}$

g  $\frac{6}{5} \div \frac{9}{10}$

h  $\frac{22}{35} \div \frac{11}{63}$

**Example 6c** 7 Simplify:

a  $1\frac{4}{7} \div 1\frac{2}{3}$

b  $3\frac{1}{5} \div 8\frac{1}{3}$

c  $3\frac{1}{5} \div 2\frac{2}{7}$

d  $6\frac{2}{4} \div 2\frac{1}{6}$

8 Simplify:

a  $\frac{1}{2} \times \frac{3}{4} \div \frac{2}{5}$

b  $\frac{3}{7} \div \frac{9}{2} \times \frac{14}{16}$

c  $2\frac{1}{3} \div 1\frac{1}{4} \div 1\frac{3}{5}$

d  $4\frac{1}{2} \times 3\frac{1}{3} \div 10$

### PROBLEM-SOLVING

9, 10

9–11

10–12

9 Max and Tanya are painting a large wall together, which is split equally into two halves. Max paints the left half of the wall at the same time as Tanya paints the right half. Max has painted  $\frac{3}{7}$  of his half and Tanya has painted  $\frac{2}{5}$  of her half.

- What fraction of the overall wall has max painted? Calculate  $\frac{3}{7} \times \frac{1}{2}$  to find this.
- What fraction of the overall wall has Tanya painted?
- What fraction of the wall has been painted?
- What fraction of the wall remains to be painted?

10 Eilish was required to write a 600 word Literature essay. After working away for one hour, the word count on her computer showed that she had typed 240 words. What fraction of the essay does Eilish still need to complete? Write your answer in simplest form.

11 Vernald ordered  $12\frac{1}{4}$  kilograms of Granny Smith apples. Unfortunately  $\frac{3}{7}$  of the apples were bruised and unusable. How many kilograms of good apples did Vernald have to make his apple pies?

12 For Mary's party, she asked her dad to buy 18 bottles of soft drink. Each bottle contained  $1\frac{1}{4}$  litres. The glasses they had for the party could hold  $\frac{1}{5}$  of a litre. How many glasses could be filled from the 18 bottles of soft drink?

## REASONING

13

13, 14

14–16

- 13 Fill in the empty boxes to make the following fraction equations correct. More than one answer may be possible.

a  $\frac{3}{\square} + \frac{2}{\square} = 1$

b  $\frac{11}{7} - \frac{\square}{3} = \frac{5}{21}$

c  $\frac{1}{\square} + \frac{\square}{3} = \frac{13}{15}$

d  $5\frac{\square}{4} - 3\frac{\square}{2} = 1\frac{3}{4}$

- 14 Fill in the empty boxes to make the following fraction equations correct. More than one answer may be possible.

a  $\frac{\square}{4} \times \frac{5}{6} = \frac{\square}{12}$

b  $\frac{\square}{21} \div \frac{3}{7} = 2$

c  $\frac{2}{\square} + \frac{\square}{5} = \frac{2}{5}$

d  $1\frac{1}{4} \times \frac{\square}{\square} = 4\frac{1}{12}$

- 15 a What fraction is  $\frac{1}{4}$  of  $\frac{3}{4}$ ?  
 b How many 'lots' of  $\frac{3}{4}$  are in 1 whole?  
 c Using multiplication find how many 'lots' of  $\frac{3}{4}$  are in  $3\frac{3}{4}$ .  
 d Calculate  $3\frac{3}{8} \div \frac{3}{4}$ .

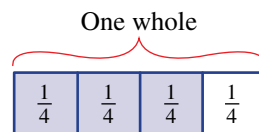

- 16 a Simplify  $\frac{1}{2} + \frac{1}{4}$ .  
 b Simplify  $\frac{1}{2} + \frac{1}{4} + \frac{1}{8}$ .  
 c Without adding each term separately, what is the sum of the 10 fractions:  $\frac{1}{2}, \frac{1}{4}, \frac{1}{8}, \dots, \frac{1}{1024}$  (where each fraction is half the previous one)?  
 d Try to explain why the sum of one million of these fractions will always be less than 1.

## ENRICHMENT: How small, how close, how large?

-

-

17

- 17 You have five different fractions  $\frac{1}{2}, \frac{1}{3}, \frac{1}{4}, \frac{1}{5}, \frac{1}{6}$  and four different operations  $+, -, \times, \div$  at your disposal. You must use each fraction and each operation once and only once. You may use as many brackets as you need. Here is your challenge:
- Produce an expression with the smallest possible positive answer.
  - Produce an expression with an answer of 1 or as close to 1 as possible.
  - Produce an expression with the largest possible answer.

An example of an expression using each of the five fractions and four operations is

$$\left(\frac{1}{2} + \frac{1}{3} - \frac{1}{4}\right) \times \frac{1}{5} \div \frac{1}{6}. \text{ This has an answer of } \frac{7}{10}.$$

## 3C Operations with negative fractions

### LEARNING INTENTIONS

- To understand that the techniques for adding, subtracting, multiplying and dividing positive fractions also apply to negative fractions
- To understand that the rules for positive and negative integers also apply to fractions
- To be able to add, subtract, multiply and divide negative fractions and mixed numerals

The English mathematician named John Wallis (1616–1703) invented a number line that displayed numbers extending in both the positive and negative directions.

So, just as we can have negative integers, we can also have negative fractions. In fact, each positive fraction has an opposite (negative) fraction. Two examples are highlighted on the number line below:

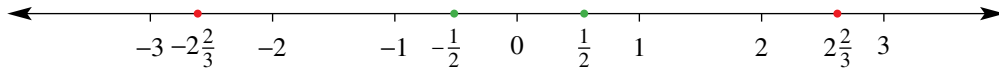

### Lesson starter: Where do you end up?

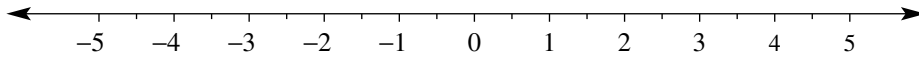

You are given a starting point and a set of instructions to follow. You must determine where the finishing point is. The first set of instructions reviews the addition and subtraction of integers. The other two sets involve the addition and subtraction of positive and negative fractions.

- Starting point is 1. Add 3, subtract 5, add  $-2$ , subtract  $-4$ , subtract 3.  
Finishing point =
- Starting point is 0. Subtract  $\frac{3}{5}$ , add  $\frac{1}{5}$ , add  $-\frac{4}{5}$ , subtract  $\frac{2}{5}$ , subtract  $-\frac{3}{5}$ .  
Finishing point =
- Starting point is  $\frac{1}{2}$ . Subtract  $\frac{3}{4}$ , add  $-\frac{1}{3}$ , subtract  $-\frac{1}{2}$ , subtract  $\frac{1}{12}$ , add  $\frac{1}{6}$ .  
Finishing point =

### KEY IDEAS

- The techniques for  $+$ ,  $-$ ,  $\times$ ,  $\div$  positive fractions also apply to negative fractions.
- The arithmetic rules we observed for integers (Chapter 1) also apply to fractions.
- Subtracting a larger positive fraction from a smaller positive fraction will result in a negative fraction.

For example:  $\frac{1}{5} - \frac{2}{3} = \frac{3}{15} - \frac{10}{15} = -\frac{7}{15}$

- Adding a negative fraction is equivalent to subtracting its opposite.

For example:  $\frac{1}{2} + \left(-\frac{1}{3}\right) = \frac{1}{2} - \left(+\frac{1}{3}\right) = \frac{1}{2} - \frac{1}{3}$

- Subtracting a negative fraction is equivalent to adding its opposite.

For example:  $\frac{1}{2} - \left(-\frac{1}{3}\right) = \frac{1}{2} + \left(+\frac{1}{3}\right) = \frac{1}{2} + \frac{1}{3}$

- The product or quotient of two fractions of the same sign (positive or negative) is a positive fraction.

- Product:  $\frac{1}{3} \times \frac{2}{5} = \frac{2}{15}$       or       $-\frac{1}{3} \times \left(-\frac{2}{5}\right) = \frac{2}{15}$

- Quotient:  $\frac{2}{15} \div \frac{1}{3} = \frac{2}{5}$       or       $-\frac{2}{15} \div \left(-\frac{1}{3}\right) = \frac{2}{5}$

- The product or quotient of two fractions of the opposite sign (positive and negative) is a negative fraction.

- Product:  $\frac{1}{2} \times \left(-\frac{1}{4}\right) = -\frac{1}{8}$       or       $-\frac{1}{2} \times \frac{1}{4} = -\frac{1}{8}$

- Quotient:  $\frac{1}{8} \div \left(-\frac{1}{2}\right) = -\frac{1}{4}$       or       $-\frac{1}{8} \div \frac{1}{2} = -\frac{1}{4}$

### BUILDING UNDERSTANDING

- Using a number line from  $-4$  to  $4$ , indicate the positions of the following negative and positive fractions.

a  $-\frac{1}{4}$

b  $1\frac{1}{2}$

c  $-3\frac{4}{5}$

d  $-\frac{7}{3}$

- State the missing fractions to complete these sentences.

a Adding  $\left(-\frac{1}{4}\right)$  is equivalent to subtracting \_\_\_\_\_.

b Adding  $\frac{1}{3}$  is equivalent to subtracting \_\_\_\_\_.

c Subtracting  $\left(-\frac{3}{5}\right)$  is equivalent to adding \_\_\_\_\_.

d Subtracting  $\frac{2}{7}$  is equivalent to adding \_\_\_\_\_.

- State whether the answer for the following expressions will be positive or negative. Do not evaluate the expressions.

a  $-\frac{3}{5} \times \left(-\frac{1}{3}\right)$

b  $-5\frac{1}{5} \times \frac{9}{11}$

c  $\frac{5}{3} \div \left(-\frac{3}{5}\right)$

d  $-2\frac{1}{7} \div \left(-8\frac{1}{3}\right)$



Dome Argus is in an inland Antarctic weather station.

Summer temperatures can reach  $-20\frac{3}{4}^{\circ}\text{C}$

and a winter temperature of  $-82\frac{1}{2}^{\circ}\text{C}$  has been recorded.

Scientists calculate the difference as:

$$-82\frac{1}{2} - \left(-20\frac{3}{4}\right) = -61\frac{3}{4}.$$



### Example 7 Adding and subtracting negative fractions

Simplify:

a  $\frac{2}{7} + \left(-\frac{5}{7}\right)$

b  $\frac{2}{3} - \left(-\frac{4}{3}\right)$

c  $\frac{1}{5} + \left(-\frac{1}{4}\right)$

d  $-\frac{7}{3} - \left(-3\frac{2}{3}\right)$

#### SOLUTION

$$\begin{aligned} \text{a } \frac{2}{7} + \left(-\frac{5}{7}\right) &= \frac{2}{7} - \frac{5}{7} \\ &= -\frac{3}{7} \end{aligned}$$

$$\begin{aligned} \text{b } \frac{2}{3} - \left(-\frac{4}{3}\right) &= \frac{2}{3} + \frac{4}{3} \\ &= \frac{6}{3} = 2 \end{aligned}$$

$$\begin{aligned} \text{c } \frac{1}{5} + \left(-\frac{1}{4}\right) &= \frac{1}{5} - \frac{1}{4} \\ &= \frac{4}{20} - \frac{5}{20} \\ &= -\frac{1}{20} \end{aligned}$$

$$\begin{aligned} \text{d } -\frac{7}{3} - \left(-3\frac{2}{3}\right) &= -\frac{7}{3} + 3\frac{2}{3} \\ &= -\frac{7}{3} + \frac{11}{3} \\ &= \frac{4}{3} = 1\frac{1}{3} \end{aligned}$$

#### EXPLANATION

Adding  $-\frac{5}{7}$  is equivalent to subtracting  $\frac{5}{7}$ .

Subtracting  $-\frac{4}{3}$  is equivalent to adding  $\frac{4}{3}$ .

Adding  $-\frac{1}{4}$  is equivalent to subtracting  $\frac{1}{4}$ .  
The LCM of 5 and 4 is 20.

Write equivalent fractions with LCD of 20.  
Subtract the numerators.

Subtracting  $-3\frac{2}{3}$  is equivalent to adding  $3\frac{2}{3}$ .  
Convert mixed numeral to improper fraction.  
Denominators are the same, therefore add numerators  
 $-7 + 11 = 4$ .

#### Now you try

Simplify:

a  $\frac{5}{11} + \left(-\frac{8}{11}\right)$

b  $\frac{4}{5} - \left(-\frac{3}{5}\right)$

c  $\frac{2}{3} + \left(-\frac{4}{5}\right)$

d  $-\frac{4}{5} - \left(-2\frac{1}{5}\right)$

**Example 8** Multiplying with negative fractions

Simplify:

a  $\frac{2}{3} \times \left(-\frac{4}{5}\right)$

b  $-\frac{6}{5} \times \left(-\frac{3}{4}\right)$

**SOLUTION**

a  $\frac{2}{3} \times \left(-\frac{4}{5}\right) = -\frac{8}{15}$

b 
$$\begin{aligned} -\frac{6}{5} \times \left(-\frac{3}{4}\right) &= \frac{6}{5} \times \frac{3}{4} \\ &= \frac{3}{5} \times \frac{3}{2} \\ &= \frac{9}{10} \end{aligned}$$

**EXPLANATION**

The two fractions are of opposite sign so the answer is a negative.

The two fractions are of the same sign, so the answer is a positive.

Cancel where possible, then multiply numerators and multiply denominators.

**Now you try**

Simplify:

a  $\frac{3}{5} \times \left(-\frac{6}{7}\right)$

b  $-\frac{3}{4} \times \left(-\frac{2}{9}\right)$

**Example 9** Dividing with negative fractions

Simplify:

a  $-\frac{2}{5} \div \left(-\frac{3}{4}\right)$

b  $-1\frac{1}{3} \div 3$

**SOLUTION**

a 
$$\begin{aligned} -\frac{2}{5} \div \left(-\frac{3}{4}\right) &= -\frac{2}{5} \times \left(-\frac{4}{3}\right) \\ &= \frac{2}{5} \times \frac{4}{3} \\ &= \frac{8}{15} \end{aligned}$$

b 
$$\begin{aligned} -1\frac{1}{3} \div 3 &= -\frac{4}{3} \times \frac{1}{3} \\ &= -\frac{4}{9} \end{aligned}$$

**EXPLANATION**

The reciprocal of  $\left(-\frac{3}{4}\right)$  is  $\left(-\frac{4}{3}\right)$ .

The two fractions are of the same sign so the answer is a positive.

The answer should be in simplest form.

The reciprocal of 3 is  $\frac{1}{3}$ .

The two numbers are of opposite sign, so the answer is a negative.

**Now you try**

Simplify:

a  $-\frac{2}{3} \div \left(-\frac{5}{6}\right)$

b  $-2\frac{1}{3} \div 4$

## Exercise 3C

### FLUENCY

1, 2-5( $\frac{1}{2}$ )2-5( $\frac{1}{2}$ )3-5( $\frac{1}{4}$ )

Example 7a

1 Simplify:

a  $\frac{5}{9} + \left(-\frac{1}{9}\right)$

b  $\frac{13}{20} + \left(-\frac{4}{20}\right)$

c  $-\frac{1}{5} + \frac{4}{5}$

d  $-\frac{3}{7} + \frac{5}{7}$

Example 7a,b

2 Simplify:

a  $-\frac{6}{7} + \frac{2}{7}$

b  $-\frac{3}{5} + \frac{4}{5}$

c  $-\frac{5}{9} - \frac{2}{9}$

d  $-\frac{11}{3} - \frac{5}{3}$

e  $\frac{1}{3} + \left(-\frac{2}{3}\right)$

f  $\frac{1}{5} + \left(-\frac{3}{5}\right)$

g  $\frac{1}{4} - \left(-\frac{5}{4}\right)$

h  $\frac{3}{11} - \left(-\frac{4}{11}\right)$

Example 7c,d

3 Simplify:

a  $\frac{1}{4} + \left(-\frac{1}{3}\right)$

b  $\frac{3}{7} + \left(-\frac{4}{5}\right)$

c  $\frac{1}{2} - \left(-\frac{3}{5}\right)$

d  $\frac{2}{9} - \left(-\frac{2}{3}\right)$

e  $-\frac{3}{2} - \left(-\frac{5}{4}\right)$

f  $-\frac{5}{8} - \left(-\frac{3}{4}\right)$

g  $-\frac{7}{5} - \left(-1\frac{1}{4}\right)$

h  $-\frac{8}{3} - \left(-2\frac{2}{5}\right)$

Example 8

4 Simplify:

a  $\frac{3}{5} \times \left(-\frac{4}{7}\right)$

b  $-\frac{2}{5} \times \frac{8}{11}$

c  $-\frac{1}{3} \times \left(-\frac{4}{5}\right)$

d  $-\frac{5}{9} \times \left(-\frac{3}{2}\right)$

e  $-\frac{3}{9} \times \frac{4}{7}$

f  $\frac{2}{6} \times \left(-\frac{3}{8}\right)$

g  $-1\frac{1}{2} \times \left(-\frac{2}{7}\right)$

h  $-\frac{3}{8} \times 3\frac{1}{5}$

Example 9

5 Simplify:

a  $-\frac{5}{7} \div \frac{3}{4}$

b  $-\frac{1}{4} \div \frac{5}{9}$

c  $-\frac{2}{3} \div \left(-\frac{5}{4}\right)$

d  $-\frac{4}{9} \div \left(-\frac{1}{3}\right)$

e  $-\frac{4}{7} \div 2$

f  $-\frac{3}{5} \div 4$

g  $-1\frac{1}{2} \div (-2)$

h  $-5\frac{1}{3} \div \left(-2\frac{2}{9}\right)$

### PROBLEM-SOLVING

6, 7

6-8

7-9

6 Arrange these fractions in increasing order.

$$\frac{3}{4}, -\frac{1}{2}, -\frac{5}{3}, -\frac{3}{4}, -1\frac{1}{2}, \frac{1}{16}, -\frac{1}{5}, 3\frac{1}{10}$$

7 Toolapool has an average maximum temperature of  $13\frac{1}{2}^{\circ}\text{C}$  and an average minimum temperature of  $-3\frac{1}{4}^{\circ}\text{C}$ . Average temperature range is calculated by subtracting the average minimum temperature from the average maximum temperature. What is the average temperature range for Toolapool?

- 8 Xaio aims to get 8 hours of sleep per week night. On Monday night he slept for  $6\frac{1}{3}$  hours, on Tuesday night  $7\frac{1}{2}$  hours, on Wednesday night  $5\frac{3}{4}$  hours and on Thursday night  $8\frac{1}{4}$  hours.
- State the difference between the amount of sleep Xaio achieved each night and his goal of 8 hours. Give a negative answer if the amount of sleep is less than 8 hours.
  - After four nights, how much is Xaio ahead or behind in terms of his sleep goal?
  - If Xaio is to exactly meet his weekly goal, how much sleep must he get on Friday night?
- 9 Maria's mother wants to make 8 curtains that each require  $2\frac{1}{5}$  metres of material in a standard width, but she only has  $16\frac{1}{4}$  metres. She asks Maria to buy more material. How much more material must Maria buy?

## REASONING

10

10, 11

11–13

- 10 Place an inequality sign (< or >) between the following fraction pairs to make a true statement. (Note: You can use a number line to decide which value is greater.)

a  $-\frac{1}{3} \square -\frac{1}{2}$

b  $-3\frac{1}{5} \square -2\frac{3}{7}$

c  $\frac{1}{4} \square -\frac{1}{2}$

d  $-\frac{3}{5} \square \frac{1}{11}$

e  $2\frac{1}{5} \square -4\frac{3}{5}$

f  $0 \square -\frac{1}{100}$

g  $\frac{4}{9} \square \frac{5}{9}$

h  $-\frac{4}{9} \square -\frac{5}{9}$

- 11 It is possible to multiply two negative fractions and obtain a positive integer. For example,  $-\frac{4}{5} \times \left(-\frac{5}{2}\right) = 2$ . For each of the following, give an example or explain why it is impossible.
- A positive and a negative fraction multiplying to a negative integer
  - A positive and a negative fraction adding to a positive integer
  - A positive and a negative fraction adding to a negative integer
  - Three negative fractions multiplying to a positive integer

- 12 Do not evaluate the following expressions, just state whether the answer will be positive or negative.

a  $-\frac{2}{7} \times \left(-\frac{1}{7}\right) \times \left(-\frac{3}{11}\right)$

b  $-4\frac{1}{5} \times \left(-\frac{9}{11}\right)^2$

c  $-\frac{5}{6} \div \left(-\frac{2}{7}\right) \times \frac{1}{3} \times \left(-\frac{4}{9}\right)$

d  $\left(-\frac{3}{7}\right)^3 \div \left(-4\frac{1}{5}\right)^3$

- 13 If  $a > 0$  and  $b > 0$  and  $a < b$ , place an inequality sign between the following fraction pairs to make a true statement.

a  $\frac{a}{b} \square \frac{b}{a}$

b  $\frac{a}{b} \square -\frac{a}{b}$

c  $-\frac{a}{b} \square -\frac{b}{a}$

d  $-\frac{b}{a} \square -\frac{a}{b}$

## ENRICHMENT: Positive and negative averages

-

-

14

- 14 a Calculate the average (mean) of the following sets of numbers.

i  $1\frac{1}{2}, \frac{3}{4}, \frac{5}{4}, 2\frac{1}{2}$

ii  $-\frac{2}{3}, \frac{5}{6}, \frac{7}{6}, \frac{1}{3}, -1\frac{1}{3}$

iii  $-2\frac{1}{5}, -\frac{3}{5}, 0, \frac{1}{5}, -1\frac{3}{5}$

iv  $-7\frac{1}{3}, -2\frac{1}{2}, -5\frac{1}{6}, -3\frac{3}{10}$

- List a set of five different fractions that have an average of 0.
- List a set of five different fractions that have an average of  $-\frac{3}{4}$ .



# 3D Understanding decimals CONSOLIDATING

## LEARNING INTENTIONS

- To understand place value in a decimal
- To be able to compare two or more decimals to decide which is largest
- To be able to convert decimals to fractions
- To be able to convert some simple fractions to decimals

Decimals are another way of representing ‘parts of a whole’. They are an extension of our base 10 number system. The term *decimal* is derived from the Latin word *decem* meaning ‘ten’.

A decimal point is used to separate the whole number and the fraction part. In this section we revisit the concepts of comparing decimals and converting between decimals and fractions.



Digital micrometres and callipers measure in mm to 3 decimal places. Machinists require this level of accuracy when making intricate components, such as those designed by engineers for surgical instruments and engines of aircraft, ships and vehicles.

## Lesson starter: Order 10

The following 10 numbers all contain a whole number part and a fraction part. Some are decimals and some are mixed numerals.

Work with a partner. Your challenge is to place the 10 numbers in ascending order.

$$4\frac{1}{11} \quad 3\frac{5}{6} \quad 3.3 \quad 3\frac{72}{100} \quad 3\frac{1}{3} \quad 2.85 \quad 3.09 \quad 2\frac{3}{4} \quad 3\frac{2}{5} \quad 3.9$$

## KEY IDEAS

- When dealing with decimal numbers, the place value table is extended to involve tenths, hundredths, thousandths etc.
- The number 517.364 means:

Hundreds	Tens	Units	Decimal point	Tenths	Hundredths	Thousandths
5	1	7	.	3	6	4
$5 \times 100$	$1 \times 10$	$7 \times 1$	.	$3 \times \frac{1}{10}$	$6 \times \frac{1}{100}$	$4 \times \frac{1}{1000}$
500	10	7	.	$\frac{3}{10}$	$\frac{6}{100}$	$\frac{4}{1000}$

### ■ Comparing and ordering decimals

To compare two decimal numbers with digits in the same place value columns, you must compare the left-most digits first. Continue comparing digits as you move from left to right until you find two digits that are different.

For example, compare 362.581 and 362.549.

Decimal point

Hundreds	Tens	Units	Tenths	Hundredths	Thousandths	
3	6	2	.	5	8	1
3	6	2	.	5	4	9

Both numbers have identical digits in the hundreds, tens, units and tenths columns. Only when we get to the hundredths column is there a difference. The 8 is bigger than the 4 and therefore  $362.581 > 362.549$ .

### ■ Converting decimals to fractions

- Count the number of decimal places used.
- This is the number of zeros that you must place in the denominator.
- Simplify the fraction if required.

For example:  $0.64 = \frac{64}{100} = \frac{16}{25}$

### ■ Converting fractions to decimals

- If the denominator is a power of 10, simply change the fraction directly to a decimal from your knowledge of its place value.

For example:  $\frac{239}{1000} = 0.239$

- If the denominator is not a power of 10, try to find an equivalent fraction for which the denominator is a power of 10 and then convert to a decimal.

For example:

$$\frac{3}{20} = \frac{15}{100} = 0.15$$

$\xrightarrow{\times 5}$   
 $\xleftarrow{\times 5}$

- A method that will always work for converting fractions to decimals is to divide the numerator by the denominator. This can result in terminating and recurring decimals and is covered in **Section 3F**.

## BUILDING UNDERSTANDING

- 1 Which of the following is the mixed numeral equivalent of 8.17?
- A  $8\frac{1}{7}$       B  $8\frac{17}{10}$       C  $8\frac{1}{17}$       D  $8\frac{17}{1000}$       E  $8\frac{17}{100}$
- 2 Which of the following is the mixed numeral equivalent of 5.75?
- A  $5\frac{75}{10}$       B  $5\frac{25}{50}$       C  $5\frac{3}{4}$       D  $5\frac{15}{20}$       E  $5\frac{75}{1000}$
- 3 State the missing numbers to complete the following statements to convert the fractions into decimals.
- a  $\frac{3}{5} = \frac{6}{\square} = 0.\square$       b  $\frac{11}{20} = \frac{\square}{100} = 0.5\square$



## Example 10 Comparing decimals

Compare the following decimals and place the correct inequality sign between them.

$$57.89342 \square 57.89631$$

**SOLUTION**

$$57.89342 < 57.89631$$

**EXPLANATION**

Digits are the same in the tens, units, tenths and hundredths columns.

Digits are first different in the thousandths column.  $\frac{3}{1000} < \frac{6}{1000}$

**Now you try**

Compare the following decimals and place the correct inequality sign between them.

$$32.152498 \square 32.15253$$



## Example 11 Converting decimals to fractions

Convert the following decimals to fractions in their simplest form.

a 0.804

b 5.12

**SOLUTION**

a  $\frac{804}{1000} = \frac{201}{250}$

**EXPLANATION**

Three decimal places, therefore three zeros in denominator.

$$0.804 = 804 \text{ thousandths}$$

Divide by common factor of 4.

*Continued on next page*

**SOLUTION**

$$\text{b } 5\frac{12}{100} = 5\frac{3}{25}$$

**EXPLANATION**

Two decimal places, therefore two zeros in denominator.

$0.12 = 12$  hundredths

Divide by common factor of 4.

**Now you try**

Convert the following decimals to fractions in their simplest form.

a 0.225

b 3.65

**Example 12 Converting fractions to decimals**

Convert the following fractions to decimals.

a  $\frac{239}{100}$

b  $\frac{9}{25}$

**SOLUTION**

a  $\frac{239}{100} = 2\frac{39}{100} = 2.39$

b  $\frac{9}{25} = \frac{36}{100} = 0.36$

**EXPLANATION**

Convert improper fraction to a mixed numeral.

Denominator is a power of 10.

$$\frac{9}{25} = \frac{9 \times 4}{25 \times 4} = \frac{36}{100}$$

**Now you try**

Convert the following fractions to decimals.

a  $\frac{407}{100}$

b  $\frac{7}{50}$

	A	B	C
1	Spreadsheet notation for fractions and division operations		
2			
3	Fraction notation for one quarter:	1/4	
4	Formula for the division operation $1 \div 4$ :	=1/4	
5	Result of division operation $1 \div 4$ :	0.25	
6			
7			

A fraction is equivalent to a division operation. In spreadsheets and some calculators, fractions and division operations are typed the same way, using a slash (/) between the numbers.

## Exercise 3D

### FLUENCY

1–3, 4–5( $\frac{1}{2}$ )2, 3, 4–6( $\frac{1}{2}$ )3–6( $\frac{1}{2}$ ), 7

**Example 10** 1 Compare the following decimals and place the correct inequality sign (< or >) between them.

a  $42.1637$    $42.1619$

b  $16.8431$    $16.8582$

**Example 10** 2 Compare the following decimals and place the correct inequality sign (< or >) between them.

a  $36.485$    $37.123$

b  $21.953$    $21.864$

c  $0.0372$    $0.0375$

d  $4.21753$    $4.21809$

e  $65.4112$    $64.8774$

f  $9.5281352$    $9.5281347$

3 Arrange the following sets of decimals in descending order.

a  $3.625, 3.256, 2.653, 3.229, 2.814, 3.6521$

b  $0.043, 1.305, 0.802, 0.765, 0.039, 1.326$

**Example 11** 4 Convert the following decimals to fractions in their simplest form.

a  $0.31$

b  $0.537$

c  $0.815$

d  $0.96$

e  $5.35$

f  $8.22$

g  $26.8$

h  $8.512$

i  $0.052$

j  $6.125$

k  $317.06$

l  $0.424$

**Example 12a** 5 Convert the following fractions to decimals.

a  $\frac{17}{100}$

b  $\frac{301}{1000}$

c  $\frac{405}{100}$

d  $\frac{76}{10}$

**Example 12b** 6 Convert the following fractions to decimals.

a  $\frac{3}{25}$

b  $\frac{7}{20}$

c  $\frac{5}{2}$

d  $\frac{7}{4}$

e  $\frac{11}{40}$

f  $\frac{17}{25}$

g  $\frac{3}{8}$

h  $\frac{29}{125}$

7 Convert the following mixed numerals to decimals and then place them in ascending order.

$2\frac{2}{5}, 2\frac{1}{4}, 2\frac{3}{8}, 2\frac{7}{40}, 2\frac{9}{50}, 2\frac{3}{10}$

### PROBLEM-SOLVING

8, 9

8, 9

9, 10

8 The distances from Nam's locker to his six different classrooms are listed below.

- Locker to room B5 (0.186 km)
- Locker to room A1 (0.119 km)
- Locker to room P9 (0.254 km)
- Locker to gym (0.316 km)
- Locker to room C07 (0.198 km)
- Locker to BW Theatre (0.257 km)

List Nam's six classrooms in order of distance of his locker from the closest classroom to the one furthest away.



- 9 The prime minister's approval rating is 0.35, while the opposition leader's approval rating is  $\frac{3}{8}$ . Which leader is ahead in the popularity polls and by how much?
- 10 Lydia dug six different holes for planting six different types of fruit bushes and trees.

She measured the dimensions of the holes and found them to be:

Hole A: depth 1.31 m, width 0.47 m

Hole B: depth 1.15 m, width 0.39 m

Hole C: depth 0.85 m, width 0.51 m

Hole D: depth 0.79 m, width 0.48 m

Hole E: depth 1.08 m, width 0.405 m

Hole F: depth 1.13 m, width 0.4 m

- a List the holes in increasing order of depth.  
b List the holes in decreasing order of width.



### REASONING

11

11, 12

11( $\frac{1}{2}$ ), 12





- 11 a Write a decimal that lies midway between 2.65 and 2.66.  
b Write a fraction that lies midway between 0.89 and 0.90.  
c Write a decimal that lies midway between 4.6153 and 4.6152.  
d Write a fraction that lies midway between 2.555 and 2.554.
- 12 Complete this magic square using a combination of fractions and decimals.

2.6		$1\frac{4}{5}$
	$\frac{6}{2}$	
4.2		

## ENRICHMENT: Exchange rates

13

- 13 The table below shows a set of exchange rates between the US dollar (US\$), the Great Britain pound (£), the Canadian dollar (C\$), the euro (€) and the Australian dollar (A\$).

	 United States <b>USD</b>	 United Kingdom <b>GBP</b>	 Canada <b>CAD</b>	 European Union <b>EUR</b>	 Australia <b>AUD</b>
USD	1	1.58781	0.914085	1.46499	0.866558
GBP	0.629795	1	0.575686	0.922649	0.545754
CAD	1.09399	1.73705	1	1.60269	0.948006
EUR	0.682594	1.08383	0.623949	1	0.591507
AUD	1.15399	1.83232	1.05484	1.69059	1

The following two examples are provided to help you to interpret the table.

- A\$1 will buy US\$0.866558.
- You will need A\$1.15399 to buy US\$1.

Study the table and answer the following questions.

- How many euros will A\$100 buy?
- How many A\$ would buy £100?
- Which country has the most similar currency rate to Australia?
- Would you prefer to have £35 or €35?
- C\$1 has the same value as how many US cents?
- If the cost of living was the same in each country in terms of each country's own currency, list the five money denominations in descending order of value for money.
-  A particular new car costs £30 000 in Great Britain and \$70 000 in Australia. If it costs A\$4500 to freight a car from Great Britain to Australia, which car is cheaper to buy? Justify your answer by using the exchange rates in the table.
- Research the current exchange rates and see how they compare to those listed in the table.



## 3E Operations with decimals CONSOLIDATING

### LEARNING INTENTIONS

- To be able to add and subtract decimals
- To be able to multiply decimals
- To be able to divide decimals
- To understand that multiplying and dividing by powers of 10 can be done by moving the digits left or right of the decimal point

This section reviews the different techniques involved in adding, subtracting, multiplying and dividing decimals.



Vets use decimal division to calculate the volume of medication to be injected into an animal. For example: volume to be injected = (required mg) ÷ (stock mg/mL) =  $70.2 \div 12 = 5.85$  mL.

### Lesson starter: Match the phrases

There are seven different sentence beginnings and seven different sentence endings below. Your task is to match each sentence beginning with its correct ending. When you have done this, write the seven correct sentences in your workbook.

Sentence beginnings	Sentence endings
When adding or subtracting decimals	the decimal point appears to move two places to the right.
When multiplying decimals	the decimal point in the quotient goes directly above the decimal point in the dividend.
When multiplying decimals by 100	make sure you line up the decimal points.
When dividing decimals by decimals	the number of decimal places in the question must equal the number of decimal places in the answer.
When multiplying decimals	the decimal point appears to move two places to the left.
When dividing by 100	start by ignoring the decimal points.
When dividing decimals by a whole number	we start by changing the question so that the divisor is a whole number.



## KEY IDEAS

### ■ Adding and subtracting decimals

- Ensure digits are correctly aligned in similar place value columns.
- Ensure the decimal points are lined up directly under one another.

$$37.56 + 5.231 \qquad \begin{array}{r} 37.560 \\ + 5.231 \\ \hline \end{array} \checkmark \qquad \begin{array}{r} 37.56 \\ + 5.231 \\ \hline \end{array} \times$$

### ■ Multiplying and dividing decimals by powers of 10

- When multiplying, the decimal point appears to move to the right the same number of places as there are zeros in the multiplier.

$$13.753 \times 100 = 1375.3 \qquad \begin{array}{r} 13.753 \\ \phantom{00} \end{array} \begin{array}{l} \curvearrowright \\ \phantom{00} \end{array}$$

Multiply by 10 twice.

- When dividing, the decimal point appears to move to the left the same number of places as there are zeros in the divisor.

$$586.92 \div 10 = 58.692 \qquad \begin{array}{r} 586.92 \\ \phantom{00} \end{array} \begin{array}{l} \phantom{00} \\ \phantom{00} \end{array}$$

Divide by 10 once.

### ■ Multiplying decimals

- Initially ignore the decimal points and carry out routine multiplication.
- The decimal place is correctly positioned in the answer according to the following rule: ‘The number of decimal places in the answer must equal the total number of decimal places in the question.’

$$5.73 \times 8.6 \longrightarrow \begin{array}{r} 573 \\ \times 86 \\ \hline 49278 \end{array} \longrightarrow 5.73 \times 8.6 = 49.278$$

(3 decimal places in question, 3 decimal places in answer)

### ■ Dividing decimals

The decimal point in the quotient goes directly above the decimal point in the **dividend**.

$$56.34 \div 3 \qquad \begin{array}{r} 18.78 \\ 3 \overline{)56.34} \end{array} \begin{array}{l} \longleftarrow \text{Quotient (answer)} \\ \longleftarrow \text{Dividend} \end{array}$$

We avoid dividing decimals by other decimals. Instead we change the **divisor** into a whole number. Of course, whatever change we make to the divisor we must also make to the dividend, so it is equivalent to multiplying by 1 and the value of the question is not changed.

$$\text{We avoid } \longrightarrow 27.354 \div 0.02$$

preferring to do  $\longrightarrow 2735.4 \div 2$   $\begin{array}{r} 27.354 \\ \phantom{00} \end{array} \begin{array}{l} \phantom{00} \\ \phantom{00} \end{array}$

## BUILDING UNDERSTANDING

- 1 Which of the following is correctly set up for this addition problem?

$$5.386 + 53.86 + 538.6$$

A 
$$\begin{array}{r} 5.386 \\ 53.86 \\ + 538.6 \\ \hline \end{array}$$

B 
$$\begin{array}{r} 5.386 \\ 53.860 \\ + 538.600 \\ \hline \end{array}$$

C 
$$\begin{array}{r} 5.386 \\ 53.86 \\ + 538.6 \\ \hline \end{array}$$

D 
$$\begin{array}{r} 538 + 53 + 5 \\ + 0.386 + 0.86 + 0.6 \\ \hline \end{array}$$

- 2 The correct answer to the problem  $2.731 \div 1000$  is:

A 2731

B 27.31

C 2.731

D 0.02731

E 0.002731

- 3 If  $56 \times 37 = 2072$ , the correct answer to the problem  $5.6 \times 3.7$  is:

A 207.2

B 2072

C 20.72

D 2.072

E 0.2072

- 4 Which of the following divisions would provide the same answer as the division question  $62.5314 \div 0.03$ ?

A  $625.314 \div 3$

B  $6253.14 \div 3$

C  $0.625314 \div 3$

D  $625314 \div 3$



## Example 13 Adding and subtracting decimals

Calculate:

a  $23.07 + 103.659 + 9.9$

b  $9.7 - 2.86$

## SOLUTION

a 
$$\begin{array}{r} 23.070 \\ 103.659 \\ + 9.900 \\ \hline 136.629 \end{array}$$

b 
$$\begin{array}{r} 89.16710 \\ - 2.86 \\ \hline 86.30710 \end{array}$$

## EXPLANATION

Make sure all decimal points and places are correctly aligned directly under one another. Fill in missing decimal places with zeros.

Carry out the addition of each column, working from right to left. The answer can be estimated by rounding each decimal first:  $23 + 104 + 10 = 137$

Align decimal points directly under one another and fill in missing decimal places with zeros.

Carry out subtraction following the same procedure as for subtraction of whole numbers.

The answer can be estimated by rounding each decimal first and finding  $10 - 3 = 7$

## Now you try

Calculate:

a  $12.709 + 104.15 + 8.6$

b  $8.6 - 3.75$

**Example 14** Multiplying and dividing by powers of 10

Calculate:

a  $9.753 \div 100$

b  $27.58 \times 10\,000$

**SOLUTION**

a  $9.753 \div 100 = 0.09753$

b  $27.58 \times 10\,000 = 275\,800$

**EXPLANATION**

Dividing by 100, therefore decimal point must move two places to the left. Additional zeros are inserted as necessary.

$$\overset{\text{m}}{\overset{\text{m}}{09.753}}$$

Multiplying by 10 000, therefore decimal point must move four places to the right. Additional zeros are inserted as necessary.

$$27.58\overset{\text{m}}{\overset{\text{m}}{\overset{\text{m}}{\overset{\text{m}}{0000}}}}$$

**Now you try**

Calculate:

a  $27.135 \div 100$

b  $15.9 \times 1000$

**Example 15** Multiplying decimals

Calculate:

a  $2.57 \times 3$

b  $4.13 \times 9.6$

**SOLUTION**

$$\begin{array}{r} \text{a} \quad 1 \overset{2}{2}57 \\ \times \quad 3 \\ \hline 771 \\ 2.57 \times 3 = 7.71 \end{array}$$

$$\begin{array}{r} \text{b} \quad 413 \\ \times \quad 96 \\ \hline 2478 \\ 37170 \\ \hline 39648 \\ 4.13 \times 9.6 = 39.648 \end{array}$$

**EXPLANATION**

Perform multiplication ignoring decimal point. There are two decimal places in the question, so two decimal places in the answer.

Estimation is approximately  $9(3 \times 3 = 9)$ .

Ignore both decimal points.

Perform routine multiplication.

There is a total of three decimal places in the question, so there must be three decimal places in the answer.

Estimation is approximately  $40(4 \times 10 = 40)$ .

**Now you try**

Calculate:

a  $3.29 \times 4$

b  $2.7 \times 8.19$



### Example 16 Dividing decimals

Calculate:

**a**  $35.756 \div 4$

**b**  $64.137 \div 0.03$

#### SOLUTION

**a** 8.939

$$\begin{array}{r} 8.939 \\ 4 \overline{) 35.756} \end{array}$$

**b**  $64.137 \div 0.03$   
 $= 6413.7 \div 3$   
 $= 2137.9$

$$\begin{array}{r} 2 \\ 3 \overline{) 6137} \end{array}$$

#### EXPLANATION

Carry out division, remembering that the decimal point in the answer is placed directly above the decimal point in the dividend. Estimation is approximately  $36 \div 4 = 9$

Instead of dividing by 0.03, multiply both the divisor and the dividend by 100. Move each decimal point two places to the right.

Carry out the division question  $6413.7 \div 3$ . Estimation is approximately  $6000 \div 3 = 2000$

#### Now you try

Calculate:

**a**  $74.52 \div 6$

**b**  $6.74 \div 0.05$

## Exercise 3E

### FLUENCY

$1, 2(\frac{1}{2}), 5-8(\frac{1}{2})$

$2-8(\frac{1}{2})$

$3-9(\frac{1}{2})$

Example 13a

1 Calculate:

**a**  $23.57 + 39.14$

**b**  $64.28 + 213.71$

**c**  $5.623 + 18.34$

**d**  $92.3 + 1.872$

Example 13b

2 Calculate:

**a**  $38.52 - 24.11$

**b**  $76.74 - 53.62$

**c**  $123.8 - 39.21$

**d**  $14.57 - 9.8$

3 Calculate:

**a**  $13.546 + 35.2 + 9.27 + 121.7$

**b**  $45.983 + 3.41 + 0.032 + 0.8942$

**c**  $923.8 + 92.38 + 9.238 + 0.238$

**d**  $4.572 + 0.0329 + 2.0035 + 11.7003$

4 Calculate:

**a**  $3.456 + 12.723 - 4.59$

**b**  $7.213 - 5.46 + 8.031$

**c**  $26.451 + 8.364 - 14.987$

**d**  $12.7 - 3.45 - 4.67$

- Example 14** 5 Calculate:
- a  $36.5173 \times 100$       b  $0.08155 \times 1000$       c  $7.5 \div 10$       d  $3.812 \div 100$   
 e  $634.8 \times 10000$       f  $1.0615 \div 1000$       g  $0.003 \times 10000$       h  $0.452 \div 1000$
- Example 15** 6 Calculate:
- a  $12.45 \times 8$       b  $4.135 \times 3$       c  $26.2 \times 4.1$       d  $5.71 \times 0.32$   
 e  $0.0023 \times 8.1$       f  $300.4 \times 2.2$       g  $7.123 \times 12.5$       h  $81.4 \times 3.59$
- Example 16a** 7 Calculate:
- a  $24.54 \div 2$       b  $17.64 \div 3$       c  $0.0485 \div 5$       d  $347.55 \div 7$   
 e  $133.44 \div 12$       f  $4912.6 \div 11$       g  $2.58124 \div 8$       h  $17.31 \div 5$
- Example 16b** 8 Calculate:
- a  $6.114 \div 0.03$       b  $0.152 \div 0.4$       c  $4023 \div 0.002$       d  $5.815 \div 0.5$   
 e  $0.02345 \div 0.07$       f  $16.428 \div 1.2$       g  $0.5045 \div 0.8$       h  $541.31 \div 0.4$
- 9 Calculate:
- a  $13.7 + 2.59$       b  $35.23 - 19.71$       c  $15.4 \times 4.3$       d  $9.815 \div 5$   
 e  $13.72 \times 0.97$       f  $6.7 - 3.083$       g  $0.582 \div 0.006$       h  $7.9023 + 34.81$

**PROBLEM-SOLVING**

10, 11

11, 12

11–13

- 10 The heights of Mrs Buchanan's five grandchildren are 1.34 m, 1.92 m, 0.7 m, 1.5 m, and 1.66 m. What is the combined height of Mrs Buchanan's grandchildren?
- 11 If the rental skis at Mt Buller were lined up end to end, they would reach from the summit of Mt Buller all the way down to the entry gate at Mirimbah. The average length of a downhill ski is 1.5 m and the distance from the Mt Buller summit to Mirimbah is 18.3 km. How many rental skis are there?
- 12 Joliet is a keen walker. She has a pedometer that shows she has walked 1 428 350 paces so far this year. Her average pace length is 0.84 metres. How many kilometres has Joliet walked so far this year? (Give your answer correct to the nearest kilometre.)
- 13 A steel pipe of length 7.234 m must be divided into four equal lengths. The saw blade is 2 mm thick. How long will each of the four lengths be?

**REASONING**

14

14, 15

14–16

- 14 An alternative method for multiplying decimals is to convert them to fractions and then multiply them. For example,  $0.3 \times 1.2 = \frac{3}{10} \times 1\frac{2}{10} = \frac{3}{10} \times \frac{12}{10} = \frac{36}{100}$ , which can be converted into 0.36. Use this method to multiply the following decimals.
- a  $0.3 \times 0.7$       b  $0.1 \times 3.07$       c  $0.2 \times 0.05$
- 15 Explain why dividing a number by 0.2 gives the same result as multiplying it by 5.
- 16 If  $a = 0.1$ ,  $b = 2.1$  and  $c = 3.1$ , without evaluating, which of the following alternatives would provide the biggest answer?
- a  $a + b + c$       b  $a \times b \times c$       c  $b \div a + c$       d  $c \div a \times b$

## ENRICHMENT: Target practice

17

- 17 In each of the following problems, you must come up with a starting decimal number/s that will provide an answer within the target range provided when the nominated operation is performed. For example: Find a decimal number that when multiplied by 53.24 will give an answer between 2.05 and 2.1.

You may like to use trial and error, or you may like to work out the question backwards.

Confirm these results on your calculator:

$$0.03 \times 53.24 = 1.5972 \text{ (answer outside target range – too small)}$$

$$0.04 \times 53.24 = 2.1296 \text{ (answer outside target range – too large)}$$

$$0.039 \times 53.24 = 2.07636 \text{ (answer within target range of 2.05 to 2.1)}$$

Therefore a possible answer is 0.039.

Try the following target problems. (Aim to use as few decimal places as possible.)

Question	Starting number	Operation (instruction)	Target range
1	0.039	$\times 53.24$	2.05 – 2.1
2		$\times 0.034$	100 – 101
3		$\div 1.2374$	75.7 – 75.8
4		$\times$ by itself (square)	0.32 – 0.33
5		$\div (-5.004)$	9.9 – 9.99

Try the following target problems. (Each starting number must have at least two decimal places.)

Question	Two starting numbers	Operation (instruction)	Target range
6	0.05, 3.12	$\times$	0.1 – 0.2
7		$\div$	4.1 – 4.2
8		$\times$	99.95 – 100.05
9		$+$	0.001 – 0.002
10		$-$	45.27

Now try to make up some of your own target problems.



## 3F Terminating decimals, recurring decimals and rounding

### LEARNING INTENTIONS

- To know the meaning of the terms terminating decimal and recurring decimal
- To understand the different notations for recurring decimals (involving dots and dashes)
- To be able to convert a fraction to a recurring decimal using division
- To be able to round decimals to a given number of decimal places by first finding the critical digit

Not all fractions convert to the same type of decimal.

For example:

$$\frac{1}{2} = 1 \div 2 = 0.5$$

$$\frac{1}{3} = 1 \div 3 = 0.33333\dots$$

$$\frac{1}{7} = 1 \div 7 = 0.142857\dots$$

Decimals that stop (or terminate) are known as terminating decimals, whereas decimals that continue on forever with some form of pattern are known as repeating or recurring decimals.

### Lesson starter: Decimal patterns

Carry out the following short divisions without using a calculator and observe the pattern of digits which occurs.

For example:  $\frac{1}{11} = 1 \div 11 = 0.09090909\dots$

Try the following:  $\frac{1}{3}$ ,  $\frac{2}{7}$ ,  $\frac{4}{9}$ ,  $\frac{5}{11}$ ,  $\frac{8}{13}$ ,  $\frac{25}{99}$

Remember to keep adding zeros to the dividend until you have a repetitive pattern.

Which fraction gives the longest repetitive pattern?



Clock time, such as this railway station clock, is converted to decimal time when it is coded into algorithms.

$$\text{E.g. } 3 \text{ h } 27 \text{ m } 32 \text{ s} = \left(3 + \frac{27}{60} + \frac{32}{3600}\right)$$

$$= 3 + 0.45 + 0.00888\dots = 3.45888\dots \text{ hours}$$

$$= 3.4589 \text{ hours, rounded to four decimal places.}$$

$$\begin{array}{r} 0.0909\dots \\ 11 \overline{)1.0^{10}0^{10}0^{10}0^{10}} \end{array}$$

### KEY IDEAS

- A **terminating decimal** has a finite number of decimal places (i.e. it terminates).

For example:  $\frac{5}{8} = 5 \div 8 = 0.625$

$$\begin{array}{r} 0.625 \leftarrow \text{Terminating decimal} \\ 3 \overline{)5.0^{20}0^{40}} \end{array}$$

- A **recurring decimal** (or **repeating decimal**) has an infinite number of decimal places with a finite sequence of digits that are repeated indefinitely.

For example:  $\frac{1}{3} = 1 \div 3 = 0.333\dots$

$$\begin{array}{r} 0.333\dots \leftarrow \text{Recurring decimal} \\ 3 \overline{)1.0^{10}0^{10}0^{10}} \end{array}$$

- One convention is to use dots placed above the digits to show the start and finish of a repeating cycle of digits.

For example:  $0.55555\dots = 0.\dot{5}$  and  $0.3412412412\dots = 0.3\dot{4}1\dot{2}$

Another convention is to use a horizontal line placed above the digits to show the repeating cycle of digits.

For example:  $0.55555\dots = 0.\overline{5}$  and  $0.3412412412\dots = 0.3\overline{412}$

- Rounding decimals** involves approximating a decimal number to fewer decimal places.

When rounding, the **critical digit** is the digit immediately after the rounding digit.

- If the critical digit is less than five, the rounding digit is not changed.
- If the critical digit is five or more, the rounding digit is increased by one.

For example: 51.34721 rounded to two decimal places is 51.35.

The critical digit is 7, hence the rounding digit is increased by 1.

- An illustration of rounding to one decimal place:

The decimals 7.41 to 7.44 are closer in value to 7.4 and will all round down to 7.4.

The values 7.46 to 7.49 are closer in value to 7.5 and will all round up to 7.5.

7.45 also rounds to 7.5.

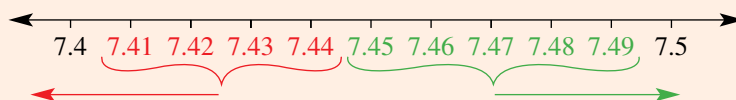

These values are closer to 7.4 and round to 7.4.

These values are closer to 7.5 and round to 7.5.

## BUILDING UNDERSTANDING

- State whether the following are terminating decimals (T) or recurring decimals (R).
 

a 5.47	b 3.1555...	c $8.\dot{6}$	d 7.1834
e 0.333	f $0.\dot{5}34$	g 0.5615	h 0.32727...
- Express the following recurring decimals using the convention of dots or a bar to indicate the start and finish of the repeating cycle.
  - 0.33333...
  - 6.21212121...
  - 8.5764444...
  - 2.135635635...
- State the 'critical' digit (the digit immediately after the rounding digit) for each of the following.
  - 3.5724 (rounding to 3 decimal places)
  - 15.89154 (rounding to 1 decimal place)
  - 0.004571 (rounding to 4 decimal places)
  - 5432.726 (rounding to 2 decimal places)





### Example 17 Writing terminating decimals

Convert the following fractions to decimals.

a  $\frac{1}{4}$

b  $\frac{7}{8}$

#### SOLUTION

a 
$$\begin{array}{r} 0.25 \\ 4 \overline{)1.00} \end{array}$$

$$\frac{1}{4} = 0.25$$

b 
$$\begin{array}{r} 0.875 \\ 8 \overline{)7.000} \end{array}$$

$$\frac{7}{8} = 0.875$$

#### EXPLANATION

Add a decimal point and extra zeros to the numerator in your working.

Three extra zeros are required since the answer terminates after three decimal places.

#### Now you try

Convert the following fractions to decimals.

a  $\frac{2}{5}$

b  $\frac{3}{8}$



### Example 18 Writing recurring decimals

Express the following fractions as recurring decimals.

a  $\frac{2}{3}$

b  $3\frac{5}{7}$

#### SOLUTION

a 
$$\begin{array}{r} 0.66\dots \\ 3 \overline{)2.00} \end{array}$$

$$\frac{2}{3} = 0.\dot{6}$$

b 
$$\begin{array}{r} 0.7142857\dots \\ 7 \overline{)5.000000} \end{array}$$

$$3\frac{5}{7} = 3.71428\dot{5} \text{ or } 3.\overline{714285}$$

#### EXPLANATION

Note that the pattern continues with a '6' in every decimal place.

Continue working through the division until a pattern is established.

#### Now you try

Express the following fractions as recurring decimals.

a  $\frac{5}{9}$

b  $2\frac{3}{7}$

**Example 19 Rounding decimals**

Round each of the following to the specified number of decimal places.

**a** 15.35729 (3 decimal places)

**b** 4.86195082 (4 decimal places)

**SOLUTION**

**a** 15.35729 = 15.357 (to 3 d.p.)

**b** 4.86195082 = 4.8620 (to 4 d.p.)

**EXPLANATION**

Critical digit is 2 which is less than 5.  
Rounding digit remains the same.

Critical digit is 5, therefore increase rounding digit by 1. There is a carry-on effect, as the rounding digit was a 9.

**Now you try**

Round each of the following to the specified number of decimal places.

**a** 12.53604 (2 decimal places)

**b** 4.28995 (4 decimal places)

**Example 20 Rounding recurring decimals**

Write  $\frac{3}{7}$  as a decimal correct to two decimal places.

**SOLUTION**

$$\begin{array}{r} 0.428 \\ 7 \overline{) 3.02000} \\ \underline{28} \phantom{00} \\ 20 \phantom{00} \\ \underline{14} \phantom{00} \\ 60 \\ \underline{56} \\ 40 \end{array}$$

$\frac{3}{7} = 0.43$  (to 2 d.p.)

**EXPLANATION**

Stop the division once the third decimal place is found since we are rounding to two decimal places.

**Now you try**

Write  $\frac{5}{7}$  as a decimal correct to four decimal places.

**Exercise 3F****FLUENCY**

1, 2-7( $\frac{1}{2}$ )

2-7( $\frac{1}{2}$ )

2-7( $\frac{1}{4}$ ), 8

Example 17

**1** Convert the following fractions to decimals.

**a**  $\frac{1}{5}$

**b**  $\frac{5}{8}$

Example 17

**2** Convert the following fractions to decimals.

**a**  $\frac{3}{5}$

**b**  $\frac{3}{4}$

**c**  $\frac{1}{8}$

**d**  $\frac{11}{20}$

**Example 18** 3 Express the following fractions as recurring decimals.

a  $\frac{1}{3}$

b  $\frac{5}{9}$

c  $\frac{5}{6}$

d  $\frac{8}{11}$

e  $\frac{3}{7}$

f  $\frac{5}{13}$

g  $3\frac{2}{15}$

h  $4\frac{6}{7}$

**Example 19** 4 Round each of the following to the specified number of decimal places, which is the number in the bracket.

a 0.76581 (3)

b 9.4582 (1)

c 6.9701 (1)

d 21.513426 (4)

e 0.9457 (2)

f 17.26 (0)

g 8.5974 (2)

h 8.10552 (3)

**Example 19** 5 Write each of the following decimals correct to two decimal places.

a 17.0071

b 5.1952

c 78.9963

d 0.0015

6 Round each of the following to the nearest whole number.

a 65.3197

b 8.581

c 29.631

d 4563.18

**Example 20** 7 Write each of the following fractions as decimals correct to two decimal places.

a  $\frac{6}{7}$

b  $\frac{2}{9}$

c  $\frac{4}{11}$

d  $\frac{5}{12}$

8 Estimate answers by firstly rounding each given number to one decimal place.

a  $2.137 + 8.59 - 1.61$

b  $15.03 - 6.991 + 3.842$

c  $7.05 \times 3$

d  $4 \times 2.89$

e  $6.92 \div 3$

f  $12.04 \div 3.99$

### PROBLEM-SOLVING

9, 10

9–11

10–12

9 Round each of the following to the number of decimal places specified in the brackets.

a 7.699951 (4)

b 4.95953 (1)

c 0.0069996 (5)

10 Simone and Greer are two elite junior sprinters. At the Queensland State Championships, Simone recorded her personal best 100m time of 12.77 seconds, while Greer came a close second with a time of 12.83 seconds.

a If the electronic timing equipment could only display times to the nearest second, what would be the time difference between the two sprinters?

b If the electronic timing equipment could only record times to the nearest tenth of a second, what would be the time difference between the two sprinters?

c What was the time difference between the two girls, correct to two decimal places?

d If the electronic timing system could measure accurately to three decimal places, what would be the quickest time that Simone could have recorded?

e Assume that Simone and Greer ran at a consistent speed throughout the 100m race. Predict the winning margin (correct to the nearest centimetre).

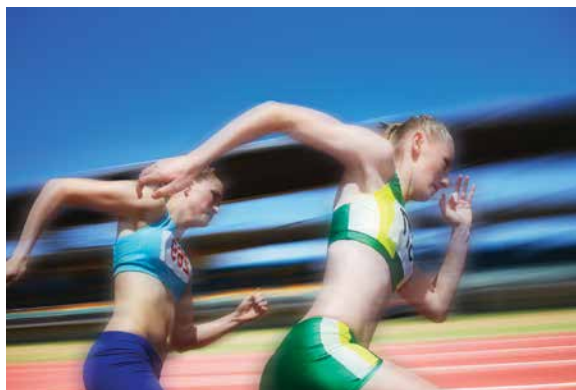

- 11 When  $\frac{3}{7}$  is expressed in decimal form, what is the digit in the 19th decimal place?
- 12 Express  $\frac{1}{17}$  as a recurring decimal.

**REASONING**

13

13, 14

13, 14

- 13 Frieda stated that she knew an infinite non-recurring decimal. Andrew said that was impossible. He was confident that all decimals either terminated or repeated and that there was no such thing as an infinite non-recurring decimal. Who is correct?
- 14 Two students gave the following answers in a short test on rounding. Both students have one particular misunderstanding. Study their answers carefully and write a comment to help correct each student's misunderstanding.

Rounding question		Student A		Student B	
0.543	(2)	0.54	✓	0.50	✗
6.7215	(3)	6.721	✗	6.722	✓
5.493	(1)	5.5	✓	5.5	✓
8.2143	(3)	8.214	✓	8.210	✗
11.54582	(2)	11.54	✗	11.55	✓

**ENRICHMENT: Will it terminate or recur?**

–

–

15

- 15 Can you find a way of determining if a fraction will result in a terminating (T) decimal or a recurring (R) decimal?
- a Predict the type of decimal answer for the following fractions, and then convert them to see if you were correct.
- i  $\frac{1}{8}$       ii  $\frac{1}{12}$       iii  $\frac{1}{14}$       iv  $\frac{1}{15}$       v  $\frac{1}{20}$       vi  $\frac{1}{60}$
- A key to recognising whether a fraction will result in a terminating or recurring decimal lies in the factors of the denominator.
- b Write down the denominators from above in prime factor form.
- c From your observations, write down a rule that assists the recognition of when a particular fraction will result in a terminating or recurring decimal.
- d Without evaluating, state whether the following fractions will result in terminating or recurring decimals.
- i  $\frac{1}{16}$       ii  $\frac{1}{9}$       iii  $\frac{1}{42}$       iv  $\frac{1}{50}$
- v  $\frac{1}{75}$       vi  $\frac{1}{99}$       vii  $\frac{1}{200}$       viii  $\frac{1}{625}$

3A

1 State the missing numbers for the following sets of equivalent fractions.

a  $\frac{1}{3} = \frac{\square}{6} = \frac{\square}{21} = \frac{\square}{45}$

b  $\frac{5}{2} = \frac{20}{\square} = \frac{35}{\square} = \frac{125}{\square}$

3A

2 Write the following fractions in simplest form.

a  $\frac{8}{24}$

b  $\frac{12}{20}$

c  $\frac{35}{45}$

d  $\frac{120}{80}$

3B/C

3 Simplify:

a  $\frac{2}{5} + \frac{2}{5}$

b  $\frac{7}{10} - \frac{3}{5}$

c  $\frac{2}{3} + \left(-\frac{5}{4}\right)$

d  $-\frac{7}{15} - \left(-1\frac{2}{3}\right)$

3B/C

4 Simplify:

a  $\frac{3}{5} \times \frac{2}{7}$

b  $\frac{4}{15} \times \frac{20}{8}$

c  $-1\frac{7}{8} \times 1\frac{1}{5}$

d  $-4\frac{1}{5} \times \left(-1\frac{1}{9}\right)$

3B/C

5 Simplify:

a  $\frac{3}{5} \div \frac{1}{4}$

b  $\frac{6}{5} \div \left(-\frac{9}{10}\right)$

c  $-1\frac{7}{8} \div \left(-1\frac{2}{3}\right)$

d  $\frac{3}{4} \div \frac{9}{10} \times \frac{2}{5}$

3D

6 Compare the following decimals and place the correct inequality sign (&lt; or &gt;) between them.

a  $0.2531 \square 0.24876$

b  $17.3568 \square 17.3572$

3D

7 Convert the following decimals to fractions in their simplest form.

a  $0.45$

b  $6.512$

3D

8 Convert the following fractions to decimals.

a  $\frac{28}{100}$

b  $\frac{43}{1000}$

c  $\frac{7}{4}$

d  $\frac{9}{20}$

3E

9 Calculate:

a  $17.537 + 26.8 + 4.01$

b  $241.6 - 63.85$

3E

10 Calculate:

a  $0.023 \times 100$

b  $9.37 \div 1000$

c  $5.23 \times 7$

d  $3.16 \times 5.8$

e  $36.52 \div 2$

f  $26.460 \div 1.2$

3F

11 Express the following fractions as recurring decimals.

a  $\frac{5}{9}$

b  $\frac{8}{11}$

c  $6\frac{2}{15}$

3F

12 Round each of the following to the specified number of decimal places.

a  $23.6738$  (2 decimal places)

b  $2.73968$  (3 decimal places)

3F

13 Write each of the following fractions as decimals, correct to two decimal places.

a  $\frac{1}{3}$

b  $\frac{5}{12}$

## 3G Converting fractions, decimals and percentages

### CONSOLIDATING

#### LEARNING INTENTIONS

- To understand that a percentage is a number out of 100
- To be able to convert percentages to fractions and decimals
- To be able to convert fractions and decimals to percentages

**Per cent** is Latin for 'out of 100'. One dollar equals 100 **cents** and one **century** equals 100 years.

We come across percentages in many everyday situations. Interest rates, discounts, test results and statistics are just some of the common ways we deal with percentages.

Percentages are closely related to fractions. A percentage is another way of writing a fraction with a denominator of 100. Therefore, 63% means that if something was broken into 100 parts you would have 63 of them (i.e.  $63\% = \frac{63}{100}$ ).



A head chef uses percentages to compare the popularity of each menu item, such as calculating the number of Pavlova desserts ordered as a fraction and a percentage of all the desserts ordered in one week.

### Lesson starter: Estimating percentages

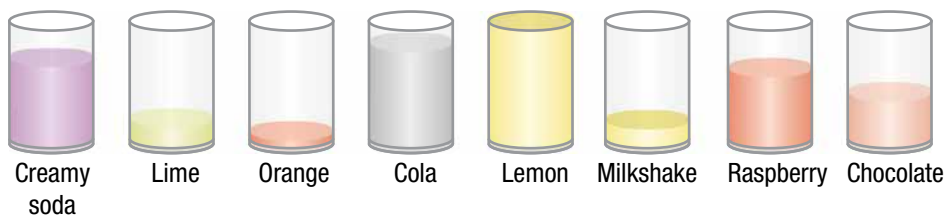

- Estimate the percentage of drink remaining in each of the glasses shown above.
- Discuss your estimations with a partner.
- Estimate what percentage of the rectangle below has been shaded in.



- Use a ruler to draw several  $10\text{cm} \times 2\text{cm}$  rectangles. Work out an amount you would like to shade in and using your ruler measure precisely the amount to shade. Shade in this amount.
- Ask your partner to guess the percentage you shaded.
- Have several attempts with your partner and see if your estimation skills improve.

## KEY IDEAS

- The symbol % means ‘per cent’. It comes from the Latin words *per centum*, which translates to ‘out of 100’.

For example: 23% means 23 out of 100 or  $\frac{23}{100} = 0.23$ .

- **To convert a percentage to a fraction**

- Change the % sign to a denominator of 100.
- Simplify the fraction if required.

For example:  $35\% = \frac{35}{100} = \frac{7}{20}$

- **To convert a percentage to a decimal**

- Divide by 100. Therefore move the decimal point two places to the left.

For example:  $46\% = 46 \div 100 = 0.46$

- **To convert a fraction to a percentage**

- Multiply by 100.







For example:  $\frac{1}{8} \times 100 = \frac{1}{8} \times \frac{100}{1} = \frac{25}{2} = 12\frac{1}{2}$ , so  $\frac{1}{8} = 12\frac{1}{2}\%$

- **To convert a decimal to a percentage**

- Multiply by 100. Therefore move the decimal point two places to the right.

For example:  $0.812 \times 100 = 81.2$ , so  $0.812 = 81.2\%$

- Common percentages and their equivalent fractions are shown in the table below. It is helpful to know these.

Words	Diagram	Fraction	Decimal	Percentage
one whole		1	1	100%
one-half		$\frac{1}{2}$	0.5	50%
one-third		$\frac{1}{3}$	0.333... or $0.\dot{3}$	$33\frac{1}{3}\%$
one-quarter		$\frac{1}{4}$	0.25	25%
one-fifth		$\frac{1}{5}$	0.2	20%
one-tenth		$\frac{1}{10}$	0.1	10%
one-hundredth		$\frac{1}{100}$	0.01	1%

## BUILDING UNDERSTANDING

- 1 The fraction equivalent of 27% is:  
 A  $\frac{2}{7}$                       B  $\frac{27}{100}$                       C  $\frac{2700}{1}$                       D  $\frac{1}{27}$
- 2 The decimal equivalent of 37% is:  
 A 0.037                      B 0.37                      C 3.7                      D 37.00
- 3 The percentage equivalent of  $\frac{47}{100}$  is:  
 A 0.47%                      B 4.7%                      C 47%                      D 470%
- 4 The percentage equivalent of 0.57 is:  
 A 57%                      B 5.7%                      C 570%                      D 0.57%



## Example 21 Converting percentages to fractions

Convert the following percentages to fractions or mixed numerals in their simplest form.

- a 160%    b 12.5%

## SOLUTION

$$\begin{aligned} \text{a } 160\% &= \frac{160}{100} \\ &= \frac{8}{5} = 1\frac{3}{5} \end{aligned}$$

$$\begin{aligned} \text{b } 12.5\% &= \frac{12.5}{100} \text{ or } = \frac{12.5}{100} \\ &= \frac{25}{200} = \frac{125}{1000} \\ &= \frac{1}{8} = \frac{1}{8} \end{aligned}$$

## EXPLANATION

Change % sign to a denominator of 100.

Simplify fraction by dividing by HCF of 20.

Convert answer to a mixed numeral.

Change % sign to a denominator of 100.

Multiply numerator and denominator by 2 or by 10 to make whole numbers.

Simplify fraction by dividing by the HCF.

## Now you try

Convert the following percentages to fractions or mixed numerals in their simplest form.

- a 240%    b 7.5%



**Example 22 Converting percentages to decimals**

Convert the following percentages to decimals.

a 723%

b 13.45%

**SOLUTION**

a  $723\% = 7.23$

**EXPLANATION**

$723 \div 100 = 7.23$

Decimal point appears to move two places to the left.

b  $13.45\% = 0.1345$

$13.45 \div 100 = 0.1345$

**Now you try**

Convert the following percentages to decimals.

a 530%

b 12.43%

**Example 23 Converting fractions to percentages**

Convert the following fractions and mixed numerals into percentages.

a  $\frac{3}{5}$

b  $\frac{7}{40}$

c  $2\frac{1}{4}$

d  $\frac{2}{3}$

**SOLUTION**

$$\begin{aligned} \text{a} \quad \frac{3}{5} \times 100 &= \frac{3}{5} \times \frac{20 \cancel{100}}{1} \\ &= 60 \end{aligned}$$

$\therefore \frac{3}{5} = 60\%$

$$\begin{aligned} \text{b} \quad \frac{7}{40} \times 100 &= \frac{7}{40} \times \frac{5 \cancel{100}}{1} \\ &= \frac{35}{2} = 17\frac{1}{2} \end{aligned}$$

$\therefore \frac{7}{40} = 17\frac{1}{2}\%$

$$\begin{aligned} \text{c} \quad 2\frac{1}{4} \times 100 &= \frac{9}{4} \times \frac{25 \cancel{100}}{1} \\ &= 225 \end{aligned}$$

$\therefore 2\frac{1}{4} = 225\%$

$$\begin{aligned} \text{d} \quad \frac{2}{3} \times 100 &= \frac{2}{3} \times \frac{100}{1} \\ &= \frac{200}{3} = 66\frac{2}{3} \end{aligned}$$

$\therefore \frac{2}{3} = 66\frac{2}{3}\%$

**EXPLANATION**Multiply by 100.  
Simplify by cancelling the HCF.Multiply by 100.  
Simplify by cancelling the HCF.  
Write the answer as a mixed numeral.Convert mixed numeral to improper fraction.  
Cancel and simplify.Multiply by 100.  
Multiply numerators and denominators. Write answer as a mixed numeral.

**Now you try**

Convert the following fractions and mixed numerals into percentages.

a  $\frac{3}{4}$

b  $\frac{70}{80}$

c  $3\frac{1}{2}$

d  $\frac{1}{6}$

**Example 24 Converting decimals to percentages**

Convert the following decimals to percentages.

a 0.458

b 17.5

**SOLUTION**

a  $0.458 = 45.8\%$

b  $17.5 = 1750\%$

**EXPLANATION**

$0.458 \times 100 = 45.8$

The decimal point moves two places to the right.

$17.5 \times 100 = 1750$

**Now you try**

Convert the following decimals to percentages.

a 0.523

b 8.2

**Exercise 3G****FLUENCY**

$1\frac{1}{2}, 3-4\frac{1}{2}, 7\frac{1}{2}$

$1-7\frac{1}{2}$

$1-7\frac{1}{4}$

Example 21a

1 Convert the following percentages to fractions or mixed numerals in their simplest form.

a 39%

b 11%

c 20%

d 75%

e 125%

f 70%

g 205%

h 620%

Example 21b

2 Convert the following percentages to fractions in their simplest form.

a  $37\frac{1}{2}\%$

b 15.5%

c  $33\frac{1}{3}\%$

d  $66\frac{2}{3}\%$

e 2.25%

f 4.5%

g  $10\frac{1}{5}\%$

h 87.5%

Example 22

3 Convert the following percentages to decimals.

a 65%

b 37%

c 158%

d 319%

e 6.35%

f 0.12%

g 4051%

h 100.05%

Example 23a,b

4 Convert the following fractions to percentages.

a  $\frac{2}{5}$

b  $\frac{1}{4}$

c  $\frac{11}{20}$

d  $\frac{13}{50}$

e  $\frac{9}{40}$

f  $\frac{17}{25}$

g  $\frac{150}{200}$

h  $\frac{83}{200}$

Example 23c

5 Convert the following mixed numerals and improper fractions to percentages.

a  $2\frac{3}{4}$

b  $5\frac{1}{5}$

c  $\frac{7}{4}$

d  $\frac{9}{2}$

e  $3\frac{12}{25}$

f  $1\frac{47}{50}$

g  $\frac{77}{10}$

h  $\frac{183}{20}$

Example 23d

6 Convert the following fractions to percentages.

a  $\frac{1}{3}$

b  $\frac{1}{8}$

c  $\frac{1}{12}$

d  $\frac{1}{15}$

e  $\frac{3}{8}$

f  $\frac{2}{7}$

g  $\frac{3}{16}$

h  $\frac{27}{36}$

Example 24

7 Convert the following decimals to percentages.

a 0.42

b 0.17

c 3.541

d 11.22

e 0.0035

f 0.0417

g 0.01

h 1.01

**PROBLEM-SOLVING**

8, 9

9,  $10(\frac{1}{2})$ , 11 $10(\frac{1}{2})$ , 11, 12

8 Which value is largest?

- A 0.8 of a large pizza  
 B 70% of a large pizza  
 C  $\frac{3}{4}$  of a large pizza



9 Complete the following conversion tables involving common fractions, decimals and percentages.

a

Fraction	Decimal	Percentage
$\frac{1}{4}$		
$\frac{2}{4}$		
$\frac{3}{4}$		
$\frac{4}{4}$		

b

Fraction	Decimal	Percentage
	0.3	
	0.6	
	0.9	

c

Fraction	Decimal	Percentage
		20%
		40%
		60%
		80%
		100%

10 Complete the following conversion tables.

a

Fraction	Decimal	Percentage
		15%
	0.24	
$\frac{3}{8}$		
$\frac{5}{40}$		
	0.7	
		62%

b

Fraction	Decimal	Percentage
$\frac{11}{5}$		
	0.003	
		6.5%
		119%
	4.2	
$\frac{5}{6}$		

- 11 A cake is cut into 8 equal pieces. What fraction, what percentage and what decimal does one slice of the cake represent?
- 12 The Sharks team has won 13 out of 17 games for the season to date. The team still has three games to play. What is the smallest and the largest percentage of games the Sharks could win for the season?



<b>REASONING</b>	13	13, 14	14, 15
------------------	----	--------	--------

- 13 The fraction  $\frac{1}{2}$  can be written as a decimal as 0.5. Show two ways of making this conversion, one including division and one involving writing an equivalent fraction over 10.
- 14 a Explain why multiplying by 100% is the same as multiplying by 1.  
 b Explain why dividing by 100% is the same as dividing by 1.
- 15 Let A, B, C and D represent different digits.
- |  |   |
|--|---|
| a Convert BC% into a fraction.             | b Convert CD.B% into a decimal.             |
| c Convert A.BC into a percentage.          | d Convert D.DBCC into a percentage.         |
| e Convert $\frac{A}{D}$ into a percentage. | f Convert $B\frac{C}{A}$ into a percentage. |

<b>ENRICHMENT: Tangram percentages</b>	–	–	16
--	---	---	----

16 An Ancient Chinese puzzle, known as a tangram, consists of 7 geometric shapes (tans) as shown. The tangram puzzle is precisely constructed using vertices, midpoints and straight edges.



- a Express each of the separate tan pieces as a percentage, a fraction and a decimal amount of the entire puzzle.
- b Check your seven tans add up to a total of 100%.
- c Starting with a square, design a new version of a ‘modern’ tangram puzzle. You must have at least six pieces in your puzzle.  
 An example of a modern puzzle is shown.
- d Express each of the separate pieces of your new puzzle as a percentage, a fraction and a decimal amount of the entire puzzle.
- e Separate pieces of tangrams can be arranged to make more than 300 creative shapes and designs, some of which are shown. You may like to research tangrams and attempt to make some of the images.

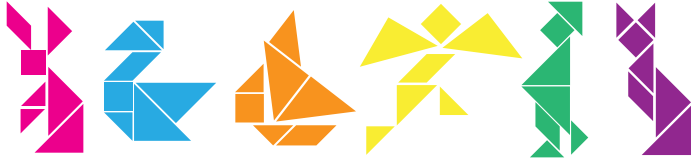
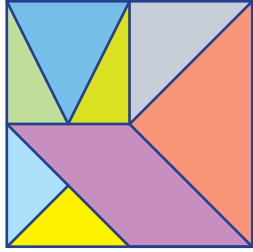

## 3H Finding a percentage and expressing as a percentage

### LEARNING INTENTIONS

- To be able to express one quantity as a percentage of another quantity
- To be able to find a certain percentage of a quantity

Showing values in percentages makes it easier for comparisons to be made. For example, Huen's report card could be written as marks out of each total or in percentages:

French test	$\frac{14}{20}$
German test	$\frac{54}{75}$

French test	70%
German test	72%

It is clear that Huen's German score was the higher result. Comparison is easier when proportions or fractions are written as percentages (equivalent fractions with denominator of 100). Expressing one number as a percentage of another number is the technique covered in this section.

Another common application of percentages is to find a certain percentage of a given quantity. Throughout your life you will come across many examples in which you need to calculate percentages of a quantity. Examples include retail discounts, interest rates, personal improvements, salary increases, commission rates and more.



A sports scientist records and compares heart rates. For example, 80 bpm (beats per minute) when resting; 120 bpm with exercise or 150% of the resting rate; 160 bpm during intense exercise, or 200% of the resting rate.

### Lesson starter: What percentage has passed?

Answer the following questions.

- What percentage of your day has passed?
- What percentage of the current month has passed?
- What percentage of the current season has passed?
- What percentage of your school year has passed?
- What percentage of your school education has passed?
- If you live to an average age, what percentage of your life has passed?
- When you turned 5, what percentage of your life was 1 year?
- When you are 40, what percentage of your life will 1 year be?

## KEY IDEAS

## ■ To express one quantity as a percentage of another

- 1 Write a fraction with the 'part amount' as the numerator and the 'whole amount' as the denominator.
- 2 Convert the fraction to a percentage by multiplying by 100.  
For example: Express a test score of 14 out of 20 as a percentage.  
14 is the 'part amount' that you want to express as a percentage out of 20, which is the 'whole amount'.

$$\frac{14}{20} \times 100 = \frac{14}{\cancel{20}^1} \times \frac{\cancel{100}^5}{1} = 70, \therefore \frac{14}{20} = 70\%$$

Alternatively,  $\frac{14}{20} = \frac{70}{100} = 70\%$

## ■ To find a certain percentage of a quantity

- 1 Express the required percentage as a fraction.
- 2 Change the 'of' to a multiplication sign.
- 3 Express the number as a fraction.
- 4 Follow the rules for multiplication of fractions.

For example: Find 20% of 80.

$$20\% \text{ of } 80 = \frac{20}{100} \times \frac{80}{1} = \frac{\cancel{20}^4}{\cancel{100}^{10}} \times \frac{\cancel{80}^4}{1} = 16$$

Alternatively,  $20\% \text{ of } 80 = \frac{1}{5} \times 80$   
 $= 80 \div 5$   
 $= 16$

## BUILDING UNDERSTANDING

- 1 The correct working line to express 42 as a percentage of 65 is:

A  $\frac{42}{100} \times 65\%$

C  $\frac{100}{42} \times 65\%$

B  $\frac{65}{42} \times 100\%$

D  $\frac{42}{65} \times 100\%$

- 2 The correct working line to find 42% of 65 is:

A  $\frac{42}{100} \times 65$

C  $\frac{100}{42} \times 65$

B  $\frac{65}{42} \times 100$

D  $\frac{42}{65} \times 100$

- 3 State the missing number to complete the following sentences.

- a Finding 1% of a quantity is the same as dividing the quantity by \_\_\_\_.
- b Finding 10% of a quantity is the same as dividing the quantity by \_\_\_\_.
- c Finding 20% of a quantity is the same as dividing the quantity by \_\_\_\_.
- d Finding 50% of a quantity is the same as dividing the quantity by \_\_\_\_.

### Example 25 Expressing one quantity as a percentage of another

Express each of the following as a percentage.

a 34 out of 40

b 13 out of 30

#### SOLUTION

$$\begin{aligned} \text{a } \frac{34}{40} \times \frac{100\%}{1} &= \frac{17}{20} \times \frac{100\%}{1} \\ &= \frac{17}{1} \times \frac{5\%}{1} \\ &= 85\% \end{aligned}$$

$$\begin{aligned} \text{b } \frac{13}{30} \times \frac{100\%}{1} &= \frac{13}{3} \times \frac{10\%}{1} \\ &= \frac{130\%}{3} \\ &= 43\frac{1}{3}\% \text{ or } 43.\dot{3}\% \end{aligned}$$

#### EXPLANATION

Write as a fraction, with the first quantity as the numerator and second quantity as the denominator. Multiply by 100. Cancel and simplify.

Write quantities as a fraction and multiply by 100. Cancel and simplify. Express the percentage as a mixed numeral or a recurring decimal.

#### Now you try

Express each of the following as a percentage.

a 21 out of 30

b 11 out of 60

### Example 26 Converting units before expressing as a percentage

Express:

a 60 cents as a percentage of \$5

b 2 km as a percentage of 800 m.

#### SOLUTION

$$\begin{aligned} \text{a } \frac{60}{500} \times \frac{100\%}{1} &= \frac{60\%}{5} \\ &= 12\% \end{aligned}$$

$$\begin{aligned} \text{b } \frac{2000}{800} \times \frac{100\%}{1} &= \frac{2000\%}{8} \\ &= 250\% \end{aligned}$$

#### EXPLANATION

Convert \$5 to 500 cents. Write quantities as a fraction and multiply by 100. Cancel and simplify.

Convert 2 km to 2000 m. Write quantities as a fraction and multiply by 100. Cancel and simplify.

#### Now you try

Express:

a 30 cents as a percentage of \$2

b 4 m as a percentage of 80 cm.



**Example 27** Finding a certain percentage of a quantity

Find:

**a** 25% of 128

**b** 155% of 60.

**SOLUTION**

$$\begin{aligned} \mathbf{a} \quad 25\% \text{ of } 128 &= \frac{25}{100} \times \frac{128}{1} \\ &= \frac{1}{4} \times \frac{128}{1} \\ &= 32 \end{aligned}$$

$$\begin{aligned} \mathbf{b} \quad 155\% \text{ of } 60 &= \frac{155}{100} \times \frac{60}{1} \\ &= \frac{155}{5} \times \frac{3}{1} \\ &= \frac{31}{1} \times \frac{3}{1} \\ &= 93 \end{aligned}$$

**EXPLANATION**

Write the percentage as a fraction over 100.  
Write 128 as a fraction with a denominator of 1.  
Cancel and simplify.

Write the percentage as a fraction over 100.  
Write 60 as a fraction with a denominator of 1.  
Cancel and simplify.

**Now you try**

Find:

**a** 25% of 84

**b** 140% of 30.

**Exercise 3H****FLUENCY**1, 2( $\frac{1}{2}$ ), 4-8( $\frac{1}{2}$ )2-9( $\frac{1}{2}$ )2-9( $\frac{1}{4}$ )

Example 25a

**1** Express each of the following as a percentage.

**a** 7 out of 10

**b** 16 out of 20

**c** 12 out of 40

**d** 33 out of 55

Example 25

**2** Express each of the following as a percentage.

**a** 20 out of 25

**b** 13 out of 20

**c** 39 out of 50

**d** 24 out of 60

**e** 11 out of 30

**f** 85 out of 120

**g** 17 out of 24

**h** 34 out of 36

Example 25

**3** Express the first quantity as a percentage of the second quantity, giving answers in fractional form where appropriate.

**a** 3, 10

**b** 9, 20

**c** 25, 80

**d** 15, 18

**e** 64, 40

**f** 82, 12

**g** 72, 54

**h** 200, 75

- 4 Express the first quantity as a percentage of the second quantity, giving answers in decimal form, correct to two decimal places where appropriate.

a 2, 24                      b 10, 15                      c 3, 7                      d 18, 48  
e 56, 35                      f 15, 12                      g 9, 8                      h 70, 30

- 5 Express each quantity as a percentage of the total.

a 28 laps of a 50 lap race completed  
b Saved \$450 towards a \$600 guitar  
c 172 people in a train carriage of 200 people  
d Level 7 completed of a 28 level video game  
e 36 students absent out of 90 total  
f 14 km mark of a 42 km marathon



Example 26

- 6 Express:

a 40 cents as a percentage of \$8                      b 50 cents as a percentage of \$2  
c 3 mm as a percentage of 6 cm                      d 400 m as a percentage of 1.6 km  
e 200 g as a percentage of 5 kg                      f 8 km as a percentage of 200 m  
g 1.44 m as a percentage of 48 cm                      h \$5.10 as a percentage of 85¢.

Example 27a

- 7 Find:

a 50% of 36                      b 20% of 45                      c 25% of 68                      d 32% of 50  
e 5% of 60                      f 2% of 150                      g 14% of 40                      h 70% of 250  
i 15% of 880                      j 45% of 88                      k 80% of 56                      l 92% of 40.

Example 27b

- 8 Find:

a 130% of 10                      b 200% of 40                      c 400% of 25                      d 155% of 140  
e 125% of 54                      f 320% of 16                      g 105% of 35                      h 118% of 60.

- 9 Find:

a 20% of 90 minutes                      b 15% of \$5  
c 30% of 150 kg                      d 5% of 1.25 litres  
e 40% of 2 weeks                      f 75% of 4.4 km.

### PROBLEM-SOLVING

10, 11

10( $\frac{1}{2}$ ), 11–1310( $\frac{1}{2}$ ), 12–14

- 10 Find:

a  $33\frac{1}{3}\%$  of 16 litres of orange juice  
b  $66\frac{2}{3}\%$  of 3000 marbles  
c  $12\frac{1}{2}\%$  of a \$64 pair of jeans  
d 37.5% of 120 doughnuts.

- 11 In a survey, 35% of respondents said they felt a penalty was too lenient and 20% felt it was too harsh. If there were 1200 respondents, how many felt the penalty was appropriate?

- 12 Four students completed four different tests. Their results were:  
 Maeheala: 33 out of 38 marks  
 Wasim: 16 out of 21 marks  
 Francesca: 70 out of 85 marks  
 Murray: 92 out of 100 marks  
 Rank the students in decreasing order of test percentage.
- 13 Jasper scored 22 of his team's 36 points in the basketball final. What percentage of the team's score did Jasper shoot? Express your answer as a fraction and as a recurring decimal.
- 14 Due to illness, Vanessa missed 15 days of the 48 school days in Term 1. What percentage of classes did Vanessa attend in Term 1?

**REASONING**

15

15, 16

16–18

- 15 Eric scored 66% on his most recent Mathematics test. He has studied hard and is determined to improve his score on the next topic test, which will be out of 32 marks. What is the least number of marks Eric can score to improve on his previous test percentage?
- 16 Calculate 40% of \$60 and 60% of \$40. What do you notice? Can you explain your findings?

- 17 Which of the following expressions would calculate  $a%$  of  $b$ ?

A  $\frac{100}{ab}$

B  $\frac{ab}{100}$

C  $\frac{a}{100b}$

D  $\frac{100a}{b}$

- 18 Which of the following expressions would express  $x$  as a percentage of  $y$ ?

A  $\frac{100}{xy}$

B  $\frac{xy}{100}$

C  $\frac{x}{100y}$

D  $\frac{100x}{y}$

**ENRICHMENT: Two-dimensional percentage increases**

–

–

19

- 19 A rectangular photo has dimensions of 12 cm by 20 cm.

a What is the area of the photo in  $\text{cm}^2$ ?

The dimensions of the photo are increased by 25%.

b What effect will increasing the dimensions of the photo by 25% have on its area?

c What are the new dimensions of the photo?

d What is the new area of the photo in  $\text{cm}^2$ ?

e What is the increase in the area of the photo?

f What is the percentage increase in the area of the photo?

g What effect did a 25% increase in dimensions have on the area of the photo?

h Can you think of a quick way of calculating the percentage increase in the area of a rectangle for a given increase in each dimension?

i What would be the percentage increase in the area of a rectangle if the dimensions were:

i increased by 10%?

ii increased by 20%?

iii increased by  $33\frac{1}{3}\%$ ?

iv increased by 50%?

You might like to draw some rectangles of particular dimensions to assist your understanding of the increase in percentage area.

j What percentage increase in each dimension would you need to exactly double the area of the rectangle?

k You might like to explore the percentage increase in the volume of a three-dimensional shape when each of the dimensions is increased by a certain percentage.

## 31 Decreasing and increasing by a percentage

### LEARNING INTENTIONS

- To know the meaning of the terms: discount, mark-up, profit, loss, selling price, retail price and wholesale price
- To be able to find the new value if an amount is increased or decreased by a percentage
- To understand that percentage mark-ups and discounts correspond to increasing and decreasing a price by a percentage

Percentages are regularly used when dealing with money. Here are some examples.

- Decreasing an amount by a percentage (Discount)  
All items in the store were reduced by 30% for the three-day sale.  
The value of the car was depreciating at a rate of 18% per annum.
- Increasing an amount by a percentage (Mark-up)  
A retail shop marks up items by 25% of the wholesale price.  
The professional footballer's new contract was increased by 40%.



This stock market display of share prices shows the percentage change in each share price. Minus signs indicate a decrease and plus signs show an increase.

When dealing with questions involving money, you generally round your answers to the nearest cent. Do this by rounding correct to two decimal places. For example, \$356.4781 rounds to \$356.48 (suitable if paying by credit card).

As our smallest coin is the five-cent coin, on many occasions it will be appropriate to round your answer to the nearest five cents. For example, \$71.12 rounds to \$71.10 (suitable if paying by cash).

### Lesson starter: Original value $\pm$ % change = new value

The table below consists of three columns: the original value of an item, the percentage change that occurs and the new value of the item. However, the data in each of the columns have been mixed up. Your challenge is to rearrange the data in the three columns so that each row is correct.

This is an example of a correct row.

Original value	Percentage change	New value
\$65.00	Increase by 10%	\$71.50

Rearrange the values in each column in this table so that each row is correct.

Original value	Percentage change	New value
\$102.00	Increase by 10%	\$73.50
\$80.00	Increase by 5%	\$70.40
\$58.00	Decreased by 2%	\$76.50
\$64.00	Decrease by 25%	\$78.40
\$70.00	Increase by 30%	\$73.80
\$82.00	Decrease by 10%	\$75.40

## KEY IDEAS

- Common words used to represent a *decrease* in price include **reduction, discount, sale, loss** or **depreciation**. In each case the new value equals the original value minus the decrease.
- Common words used to represent an *increase* in price include **mark-up, increase, appreciation** and **profit**. In each case the new value equals the original value plus the increase.
- Increasing or decreasing an item by a set percentage involves the technique of finding a percentage of a quantity (see **Section 3H**).

- Increasing by 5%

Method 1:	Method 2:
Calculate 5%.	Add 5% to 100% to give 105%.
Add that amount to the value.	Calculate 105% of the value.

- Decreasing by 5%

Method 1:	Method 2:
Calculate 5%.	Subtract 5% from 100% to give 95%.
Subtract that amount from the value.	Calculate 95% of the value.

- In retail terms:

Selling price = retail price – discount

Selling price = wholesale price + mark-up

- The GST is 10% of the usual sale price. It is paid by the consumer and passed on to the government by the supplier.
  - The final advertised price, inclusive of the GST, represents 110% of the value of the product: the cost (100%) plus the GST of 10% gives 110%.
  - The unitary method can be used to find the GST included in the price of an item or the pre-tax price. It involves finding the value of ‘one unit’, usually 1%, then using this information to answer the question.
  - Alternatively, this chart could be used:

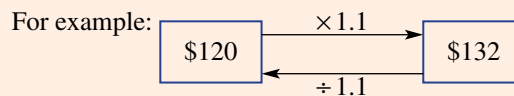
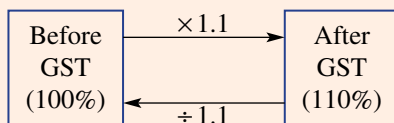

**BUILDING UNDERSTANDING**

- 1** Calculate the new price when:
- an item marked at \$15 is discounted by \$3
  - an item marked at \$25.99 is marked up by \$8
  - an item marked at \$17 is reduced by \$2.50
  - an item marked at \$180 is increased by \$45.
- 2** Calculate the new price when:
- an item marked at \$80 is discounted by 50%
  - an item marked at \$30 is marked up by 20%
  - an item marked at \$45 is reduced by 10%
  - an item marked at \$5 is increased by 200%.
- 3** A toy store is having a sale in which everything is discounted by 10% of the recommended retail price (RRP). A remote-control car is on sale and has a RRP of \$120.
- Calculate the discount on the car (i.e. 10% of \$120).
  - Calculate the selling price of the car (i.e. RRP – discount).



**Example 28** Calculating an increase or decrease by a percentage

Find the new value when:

- a** \$160 is increased by 40%                      **b** \$63 is decreased by 20%.

**SOLUTION**

$$\mathbf{a} \quad 40\% \text{ of } \$160 = \frac{40}{100} \times \frac{160}{1} = \$64$$

$$\begin{aligned} \text{New price} &= \$160 + \$64 \\ &= \$224 \end{aligned}$$

$$\mathbf{b} \quad 20\% \text{ of } \$63 = \frac{20}{100} \times \frac{63}{1} = \$12.60$$

$$\begin{aligned} \text{New price} &= \$63 - \$12.60 \\ &= \$50.40 \end{aligned}$$

**EXPLANATION**

Calculate 40% of \$160.

Cancel and simplify.

New price = original price + increase

Calculate 20% of \$63.

Cancel and simplify.

New price = original price – decrease

**Now you try**

Find the new value when:

- a** \$200 is increased by 30%                      **b** \$60 is decreased by 25%.



- Example 29**
- 4 Calculate the selling prices of the following items if they are to be reduced by 25%.
- |                |                      |                        |
|----------------|----------------------|------------------------|
| a \$16 thongs  | b \$32 sunhat        | c \$50 sunglasses      |
| d \$85 bathers | e \$130 boogie board | f \$6.60 surfboard wax |
- 5 Calculate the selling prices of the following items if they need to have 10% GST added to them. The prices listed do not include GST already.
- |                    |                   |                        |
|--------------------|-------------------|------------------------|
| a \$35 t-shirt     | b \$75 backpack   | c \$42 massage         |
| d \$83 fishing rod | e \$52.50 toaster | f \$149.99 cricket bat |

**PROBLEM-SOLVING**

6, 7

7–9

8–10

- 6 Shop C and shop D purchase Extreme Game packages at a cost price of \$60. Shop C has a mark-up of \$20 for retailers and shop D has a mark-up of 25%. Calculate the selling price for the Extreme Game package at each shop.
- 7 A retail rug store marks up all items by 25% of the wholesale price. The wholesale price of a premier rug is \$200 and for a luxury rug is \$300. What is the customer price for the two different types of rugs?
- 8 A bookstore is offering a discount of 10%. Jim wants to buy a book with a RRP of \$49.90. How much will it cost him if he pays by cash? How much will it cost him if he pays by credit card?
- 9 Shipshape stores were having a sale and reducing all items by 20%. Gerry purchased the following items, which still had their original price tags: jeans \$75, long-sleeved shirt \$94, T-shirt \$38 and shoes \$125. What was Gerry's total bill at the sale?
- 10 At the end of the winter season, an outdoors store had a 20% discount on all items in the store. Two weeks later they were still heavily overstocked with ski gear and so they advertised a further 40% off already discounted items. Calculate the new selling price of a pair of ski goggles with a RRP of \$175.00.

**REASONING**

11

11, 12

12, 13

- 11 Increasing a number by a percentage like 17% is the same as multiplying by 117% ( $100\% + 17\%$ ), which is 1.17. Decreasing by 17% is the same as multiplying by 83% ( $100\% - 17\%$ ), which is 0.83. What could you multiply a value by to:
- |                    |                    |
|--------------------|--------------------|
| a increase by 24%? | b decrease by 35%? |
| c increase by 4%?  | d decrease by 9%?  |
- 12 A \$200 item is marked up by 10%, and then the new price is discounted by 10%.
- |  |
|--|
| a Find the final price and explain why it is less than \$200.  |
| b In general, increasing a number by 10% and then decreasing the result by 10% will be the same as decreasing the original value by a certain percentage. Find this percentage and explain why this works. |
- 13 Patrick wants to purchase a trail bike and has visited three different stores. For the same model, he has received a different deal at each store.
- Pete's Trail Bikes has the bike priced at \$2400 and will not offer any discount.
- Eastern Bikers has the bike priced at \$2900 but will offer a 20% discount.
- City Trail Bikes has the bike priced at \$2750 but will offer a 15% discount.
- What is the cheapest price for which Patrick can purchase his trail bike and which store is offering the best deal?



## ENRICHMENT: Commission

–

–

14

**14** Many sales representatives are paid by commission. This means their wage is calculated as a certain percentage of their sales. For example, Ben, a car salesman, is paid 5% commission. In one week, Ben sold three cars for a total value of \$42 000. His wage for this week was 5% of \$42 000 = \$2100. If in the next week Ben sells no cars, he would receive no wage.

**a** Calculate the following amounts.

- i** 10% commission on sales of \$850
- ii** 3% commission on sales of \$21 000
- iii** 2.5% commission on sales of \$11 000
- iv** 0.05% commission on sales of \$700 000

Generally sales representatives can be paid by commission only, by an hourly rate only, or by a combination of an hourly rate and a percentage commission. The last combination is common, as it provides workers with the security of a wage regardless of sales, but also the added incentive to boost wages through increased sales.

Solve the following three problems involving commission.

- b** Stuart sells NRL records. He earns \$8.50 per hour and receives 5% commission on his sales. Stuart worked for five hours at the Brisbane Broncos vs Canberra Raiders match and sold 320 records at \$4 each. How much did Stuart earn?
- c** Sam, Jack and Justin were all on different pay structures at work. Sam was paid an hourly rate of \$18 per hour. Jack was paid an hourly rate of \$15 per hour and 4% commission. Justin was paid by commission only at a rate of 35%. Calculate their weekly wages if they each worked for 40 hours and each sold \$2000 worth of goods.
- d** Clara earns an hourly rate of \$20 per hour and 5% commission. Rose earns an hourly rate of \$16 per hour and 10% commission. They each work a 40-hour week. In one particular week, Clara and Rose both sold the same value of goods and both received the same wage. How much did they sell and what was their wage?

The following problems will investigate practical situations drawing upon knowledge and skills developed throughout the chapter. In attempting to solve these problems, aim to identify the key information, use diagrams, formulate ideas, apply strategies, make calculations and check and communicate your solutions.

## Splitting the bill

- 1 Five friends go to a cafe together for lunch. They all order different food and drink, but decide to equally share the total price of the bill.

*The friends are interested in calculating the fraction and decimal amounts of the bill and want to compare the amounts contributed by each person.*

- What fraction of the bill does each friend need to pay?
- If the total price of the bill was \$84, what amount does each friend need to pay?

One of the friends, Ginger, feels bad about the group decision to split the bill as she ordered an expensive burger and a large smoothie that came to a total of \$21.

- What fraction of the bill was Ginger's order?
- How much did Ginger save when the group decided to evenly split the bill?
- The friends loved their lunch and were happy to give a small tip. Four of the friends paid \$20 and one friend paid \$15 as this was all the cash she had. What percentage tip did the friends give to the café? Give your answer correct to the nearest per cent.

## Beach swimming

- 2 Mark and Maresh are close friends who are currently debating what percentage of teenagers like swimming at the beach. Mark loves the beach and thinks that almost every teenager likes going to the beach. Maresh is not particularly fond of going to the beach and thinks that there are many others like him who either do not like swimming or do not like the heat and prefer not swimming at the beach. They decide to conduct a survey to find out. Mark thinks 90% of teenagers will respond Yes to the simple survey question: 'Do you like going swimming at the beach?' Maresh thinks that only 50% of teenagers will respond with Yes.

*The two boys are interested in analysing the results of the survey to determine which of them is correct.*

- The boys survey 20 students in their class and find that 15 students respond with Yes. Based on this survey, what is the percentage of students who like going to the beach?
- Maresh surveys 20 teenagers in his neighbourhood and receives 8 No responses. Mark surveys 20 teenagers in his soccer club and receives 13 Yes responses. Based on the combined results of these three surveys, what is the percentage of teenagers who they have surveyed who like going swimming at the beach? Give your answer correct to the nearest whole per cent.
- Which boy's guess appears to be closer to the survey responses?
- The boys decide that they should interview a total of 100 teenagers before concluding which boy was more correct. How many more teenagers do the boys need to survey?
- Before they know the results of this last group of teenagers, find the maximum and minimum percentage of surveyed teenagers that might like going swimming at the beach.
- How many No responses in this final group does Maresh need to ensure that his initial guess was closer than Mark's initial guess?

## Basketball cards

- 3 A basketball enthusiast, Ben, buys basketball cards in bulk and then tries to sell them for a profit using a percentage price increase.

*Ben wants to explore any potential profit in the business and calculate percentage increases and decreases to understand the opportunities and risks associated with card selling.*

A card manufacturer releases new cards of a famous player for \$220 each, and Ben purchases six of these cards. The cards appear to be in great demand and Ben is able to resell them for \$370 each.

- What is the percentage increase in the price of each card? Give your answer correct to one decimal place.
- What is the total profit Ben made in this transaction?

A new card is to be released of another famous player. Cards go on sale for \$85 each and Ben purchases 20 cards. Unfortunately for Ben, the card is not well promoted and plenty of cards are still available through the manufacturer's website. To help sell more cards the website offers a 25% discount when purchasing four cards.

- What does it cost to buy four cards through the website with the new discount?

Ben cannot get anyone to buy the 20 cards at the original cost price and ends up selling 12 of the cards at \$60 each and is left with the remaining 8 cards.

- What is the percentage loss on the cards Ben was able to resell? Give your answer correct to one decimal place.
- What was the overall percentage loss Ben experienced in this transaction? Give your answer correct to one decimal place.

A different card enthusiast makes an 8% profit on five cards purchased for a total of \$180.

- What is the total dollar profit the enthusiast made on this deal?
- What is the total dollar profit an enthusiast would make if they resold  $n$  cards initially purchased for  $\$x$  each with a  $y\%$  increase?



### 3J Calculating percentage change, profit and loss

#### LEARNING INTENTIONS

- To know the meaning of the terms: percentage change, percentage profit, percentage loss and percentage error
- To be able to calculate the percentage change (increase or decrease) when prices are increased or decreased

If you sell something for more than you paid for it, you have made a profit. On the other hand, if you sell something for less than you paid for it, you have made a loss.

Retailers, business people and customers are all interested to know the percentage profit or the percentage loss that has occurred. In other words, they are interested to know about the percentage change. The percentage change provides valuable information over and above the simple value of the change.

For example:

Hat was \$40	Cap was \$8
Discount \$5	Discount \$5
Now \$35	Now \$3

The change for each situation is exactly the same, a \$5 discount. However, the percentage change is very different.

Hat was \$40. Discount 12.5%. Now \$35.

Cap was \$8. Discount 62.5%. Now \$3.

For the hat, there is a 12.5% change, and for the cap there is a 62.5% change. In this case, the percentage change would be known as a **percentage discount**.



#### Lesson starter: Name the acronym

What is an acronym?

How many of the following nine business and finance-related acronyms can you name?

- RRP
- GST
- ATM
- CBD
- COD
- EFTPOS
- GDP
- IOU
- ASX

Can you think of any others?

How about the names of two of the big four Australian banks: NAB and ANZ?

How do these acronyms relate to percentages?

The following three acronyms are provided for fun and interest only. Do you know what they stand for?

- SCUBA diving
- LASER gun
- BASE jumping

Do you know what the acronym TLA stands for? (Three Letter Acronym)

## KEY IDEAS

- **Profit** = selling price – cost price
- **Loss** = cost price – selling price
- Calculating a percentage change involves expressing one quantity as a percentage of another (see **Section 3H**).

$$\text{Percentage change} = \frac{\text{change}}{\text{original value}} \times 100\%$$

$$\text{Percentage profit} = \frac{\text{profit}}{\text{original value}} \times 100\%$$

$$\text{Percentage loss} = \frac{\text{loss}}{\text{original value}} \times 100\%$$

- A calculation **error** is the difference between an estimated or measured value and an exact, actual or given value.

$$\text{Percentage error} = \frac{\text{error}}{\text{actual value}} \times 100\%$$

## BUILDING UNDERSTANDING

- 1 Calculate the profit made in each of the following situations.
  - a Cost price = \$14, Sale price = \$21
  - b Cost price = \$499, Sale price = \$935
- 2 Calculate the loss made in each of the following situations.
  - a Cost price = \$92, Sale price = \$47
  - b Cost price = \$71.10, Sale price = \$45.20
- 3 Which of the following is the correct formula for working out percentage change?
 

<b>A</b> % change = $\frac{\text{change}}{\text{original value}}$	<b>B</b> % change = $\frac{\text{original value}}{\text{change}} \times 100\%$
<b>C</b> % change = change $\times 100\%$	<b>D</b> % change = $\frac{\text{change}}{\text{original value}} \times 100\%$
- 4 The formula used for calculating percentage loss is % loss =  $\frac{\text{loss}}{\text{cost price}} \times 100\%$   
 Which of the following would therefore be the formula for calculating the percentage discount?
 

<b>A</b> % discount = $\frac{\text{discount}}{\text{cost price}} \times 100\%$	<b>B</b> % discount = $\frac{\text{cost price}}{\text{discount}} \times 100\%$
<b>C</b> % discount = discount $\times 100\%$	<b>D</b> % discount = $\frac{\text{discount}}{100\%} \times \text{cost price}$

**Example 30** Calculating percentage change

Calculate the percentage change (profit/loss) when:

**a** \$25 becomes \$32

**b** \$60 becomes \$48.

**SOLUTION**

**a** Profit = \$7

$$\begin{aligned}\% \text{ Profit} &= \frac{7}{25} \times \frac{100}{1} \% \\ &= 28\%\end{aligned}$$

**b** Loss = \$12

$$\begin{aligned}\% \text{ Loss} &= \frac{12}{60} \times \frac{100}{1} \% \\ &= 20\%\end{aligned}$$

**EXPLANATION**

Profit = \$32 - \$25 = \$7

$$\text{Percentage profit} = \frac{\text{profit}}{\text{original value}} \times 100\%$$

This is the same as writing \$7 out of \$25 as a percentage.

Loss = \$60 - \$48 = \$12

$$\text{Percentage loss} = \frac{\text{loss}}{\text{original value}} \times 100\%$$

This is the same as writing \$12 out of \$60 as a percentage.

**Now you try**

Calculate the percentage change (profit/loss) when:

**a** \$50 becomes \$62

**b** \$80 becomes \$68.

**Example 31** Solving worded problems

Ross buys a ticket to a concert for \$125, but is later unable to go. He sells it to his friend for \$75. Calculate the percentage loss Ross made.

**SOLUTION**

Loss = \$125 - \$75 = \$50

$$\begin{aligned}\% \text{ Loss} &= \frac{50}{125} \times \frac{100}{1} \% \\ &= 40\%\end{aligned}$$

Ross made a 40% loss on the concert ticket.

**EXPLANATION**

Loss = cost price - selling price

$$\text{Percentage loss} = \frac{\text{loss}}{\text{cost price}} \times 100\%$$

**Now you try**

Anna buys a top for \$40 on sale and sells it to her class mate for \$62. Calculate the percentage profit Anna made.

## Exercise 3J

### FLUENCY

1, 2–4(½)

2–5(½)

2–5(½)

- Example 30a** 1 Calculate the percentage change (profit) when:  
 a \$20 becomes \$30                      b \$10 becomes \$14                      c \$40 becomes \$50.
- Example 30** 2 Find the percentage change (profit or loss) when:  
 a \$20 becomes \$36                      b \$10 becomes \$13                      c \$40 becomes \$30  
 d \$25 becomes \$21                      e \$12 becomes \$20                      f \$8 becomes \$11.
- Example 30** 3 Find the percentage change (increase or decrease) when:  
 a 15 g becomes 18 g                      b 18 kg becomes 15 kg  
 c 4 m becomes 24 m                      d 12 cm becomes 30 cm.
- 4 Find the percentage change in population when:  
 a a town of 4000 becomes a town of 5000  
 b a city of 750 000 becomes a city of 900 000  
 c a country of 5 000 000 becomes a country of 12 000 000  
 d a region of 10 000 becomes 7500.
- 5 Calculate the percentage error in these situations. Use the formula:  

$$\text{Percentage error} = \frac{\text{error}}{\text{actual value}} \times 100\%$$
 a Albert measures the length of a piece of timber at 24 cm, which is actually 25 cm.  
 b Sally measures the weight of a bowl of flour at 150 g, which is actually 160 g.  
 c Annette records a 100 m race time at 15.5 seconds against the actual time of 15.4 seconds. (Round to one decimal place.)  
 d Kevin records a town's population as 5300 when the actual population is 5327. (Round to one decimal place.)

### PROBLEM-SOLVING

6, 7

6–9

8–10

- Example 31** 6 Gari buys a ticket to a concert for \$90, but is unable to go. She sells it to her friend for \$72. Calculate the percentage loss Gari made.
- Example 31** 7 Estelle purchased a piece of sporting memorabilia for \$120. Twenty years later she sold it for \$900. Calculate the percentage profit Estelle made.
- 8 Xavier purchased materials for \$48 and made a dog kennel. He later sold the dog kennel for \$84.  
 a Calculate the profit Xavier made.  
 b Calculate the percentage profit Xavier made.



- 9 Gemma purchased a \$400 foal, which she later sold for \$750.
- Calculate the profit Gemma made.
  - Calculate the percentage profit Gemma made.
- 10 Lee-Sen purchased a \$5000 car, which she later sold for \$2800.
- Calculate Lee-Sen's loss.
  - Calculate Lee-Sen's percentage loss.



## REASONING

11

11, 12

11, 13

- 11 Explain why the percentage profit from \$40 to \$50 is greater than the percentage loss when \$50 becomes \$40.
- 12 Which of the following stores is offering a larger percentage discount?
- Store A: Jeans originally selling for \$60, now on sale for \$51
- Store B: Jeans originally selling for \$84, now on sale for \$73.50
- 13 The circulation of a student newspaper at Burrough High School was: 60 copies in term 1; 120 copies in term 2; 200 copies in term 3 and 360 copies in term 4.
- Calculate the percentage growth in circulation between:
    - term 1 and term 2
    - term 2 and term 3
    - term 3 and term 4.
  - In which term was there the greatest percentage growth in circulation?
  - What was the overall percentage growth in circulation over the course of the year?





**ENRICHMENT: Australia's population** - - 14

- 14 Australia's population in early 2010 was 22 003 926 and the percentage population growth was 1.8% per year.
- a Given this population size and percentage growth, how many more Australians would there be after one year?
  - b How many people would there be after:
    - i 2 years?
    - ii 5 years?
    - iii 10 years?

The Australian Bureau of Statistics carries out comprehensive population projections. One such projection assumes the following growth rates:

- One birth every 1 minute and 44 seconds
  - One death every 3 minutes and 39 seconds
  - A net gain of one international migrant every 1 minute and 53 seconds
  - An overall total population increase of one person every 1 minute and 12 seconds.
- c Calculate the percentage growth per annum, using the 2010 population of 22 003 926 and the projected total population increase of one person every 1 minute and 12 seconds. Give your answer correct to one decimal place.
  - d Find out the current population of Australia and the population 10 years ago, and work out the percentage growth over the past decade.
  - e How does Australia's percentage growth compare with that of other countries?
  - f Find out the current life expectancy of an Australian male and female. Find out their life expectancy 50 years ago. Calculate the percentage increase in life expectancy over the past 50 years.
  - g A key factor in population growth is the total fertility rate (TFR) (i.e. the number of babies per woman). For Australia the TFR in 2010 was at 1.74 expected births per woman. The peak of Australia's TFR over the past 100 years was 3.6 children per woman in 1961. What is the percentage decrease in TFR from 1961 to 2010?
  - h Carry out some of your own research on Australia's population.

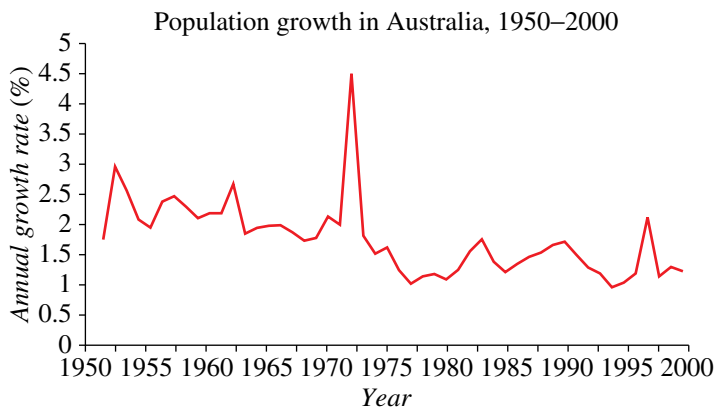

## 3K Solving percentage problems using the unitary method

### EXTENDING

#### LEARNING INTENTIONS

- To understand that the unitary method involves finding the value of 'one unit' as an intermediate step
- To be able to use the unitary method to find a quantity when only a percentage is known
- To be able to use the unitary method to find a new percentage when a different percentage is known
- To be able to apply the unitary method to find the original price when a price has been increased or decreased by a percentage

If you know a percentage of an amount, but do not actually know the amount, you can use a technique known as the unitary method to find the whole amount.

The unitary method involves finding the value of a unit and then using this value to calculate the value of a whole. In this section, the value of a unit will be the value of one per cent (1%).

Generally, the first step in all problems involving the unitary method is to divide the information given to find the value of a unit. The second step is to then multiply the value of a unit to find the value of the number of units required in the question.



Engineering projects require detailed time schedules. The foundations of a highway bridge could be 20% of the overall construction time and take 120 days. Hence 1% is 6 days; 100% is 600 days needed to complete this bridge.

### Lesson starter: Using the unitary method

By first finding the value of '1 unit', answer the following questions using mental arithmetic only.

- 1 Four tickets to a concert cost \$100. How much will 3 tickets cost?
- 2 Ten workers can dig 40 holes in an hour. How many holes can 7 workers dig in an hour?
- 3 Six small pizzas cost \$54. How much would 10 small pizzas cost?
- 4 If 8 pairs of socks cost \$64, how much would 11 pairs of socks cost?
- 5 Five passionfruit cost \$2.00. How much will 9 passionfruit cost?
- 6 If a worker travels 55 km in 5 trips from home to the worksite, how far will the worker travel in 7 trips?

#### KEY IDEAS

- The **unitary method** involves finding the value of 'one unit' and then using this information to answer the question.
- When dealing with percentages, finding 'one unit' corresponds to finding one per cent (1%).
- Once the value of 1% of an amount is known, it can be multiplied to find the value of any desired percentage.

**BUILDING UNDERSTANDING**

- 1 If 10% of an amount of money is \$75, how much is 1% of that amount?  
 A \$1                      B \$7.50                      C \$75                      D \$750
- 2 If 10% of an amount of money is \$22, how much is 100% of that amount?  
 A \$100                      B \$2.20                      C \$22                      D \$220
- 3 Which alternative best describes the unitary method when dealing with percentages?  
 A Work out the factor required to multiply the given percentage to make 100%.  
 B Find the value of 1% and then multiply to find the value of percentage required.  
 C Once you find the full amount, or 100% of the amount, this is known as 'the unit'.  
 D Find what percentage equals \$1 and then find the given percentage.

**Example 32 Using the unitary method to find the full amount**

If 8% of an amount of money is \$48, what is the full amount of money?

**SOLUTION**

$$\begin{array}{l}
 +8 \left\{ \begin{array}{l} 8\% \text{ of amount is } \$48 \\ 1\% \text{ of amount is } \$6 \end{array} \right. \quad \left. \begin{array}{l} \\ \end{array} \right\} +8 \\
 \times 100 \left\{ \begin{array}{l} 1\% \text{ of amount is } \$6 \\ 100\% \text{ of amount is } \$600 \end{array} \right. \quad \left. \begin{array}{l} \\ \end{array} \right\} \times 100
 \end{array}$$

Full amount of money is \$600

**EXPLANATION**

Divide by 8 to find the value of 1%.  
 Multiply by 100 to find the value of 100%.

**Now you try**

If 6% of an amount of money is \$42, what is the full amount of money?

**Example 33 Using the unitary method to find a new percentage**

If 11% of the food bill was \$77, how much is 25% of the food bill?

**SOLUTION**

$$\begin{array}{l}
 +11 \left\{ \begin{array}{l} 11\% \text{ of food bill is } \$77 \\ 1\% \text{ of food bill is } \$7 \end{array} \right. \quad \left. \begin{array}{l} \\ \end{array} \right\} +11 \\
 \times 25 \left\{ \begin{array}{l} 1\% \text{ of food bill is } \$7 \\ 25\% \text{ of food bill is } \$175 \end{array} \right. \quad \left. \begin{array}{l} \\ \end{array} \right\} \times 25
 \end{array}$$

**EXPLANATION**

Divide by 11 to find the value of 1%.  
 Multiply by 25 to find the value of 25%.

**Now you try**

If 14% of a bill was \$28, how much is 25% of the bill?

**Example 34 Using the unitary method to find the original price**

A pair of shoes has been discounted by 20%. If the sale price is \$120, what was the original price of the shoes?

**SOLUTION**

Only paying 80% of original price:

$$\begin{array}{l}
 +80 \left\{ \begin{array}{l} 80\% \text{ of original price is } \$120 \\ 1\% \text{ of original price is } \$1.50 \end{array} \right. \begin{array}{l} +80 \\ \times 100 \end{array} \\
 \times 100 \left\{ \begin{array}{l} 100\% \text{ of original price is } \$150 \end{array} \right. \times 100
 \end{array}$$

The original price of the shoes was \$150.

**EXPLANATION**

20% discount, so paying  $(100 - 20)\%$ .

Divide by 80 to find the value of 1%.

Multiply by 100 to find the value of 100%.

**Now you try**

A jacket has been discounted by 40%. If the sale price is \$180, what was the original price of the jacket?

**Exercise 3K****FLUENCY**1,  $2(\frac{1}{2})$ , 3–5 $2(\frac{1}{2})$ , 3,  $4(\frac{1}{2})$ , 5, 6 $2(\frac{1}{2})$ , 3,  $4(\frac{1}{2})$ , 5, 6

- Example 32** 1 If 6% of an amount of money is \$30, how much is the full amount of money?
- Example 32** 2 Calculate the full amount of money for each of the following.
- a 3% of an amount of money is \$27                      b 5% of an amount of money is \$40
- c 12% of an amount of money is \$132                  d 60% of an amount of money is \$300
- e 8% of an amount of money is \$44                      f 6% of an amount of money is \$15
- Example 33** 3 If 4% of the total bill is \$12, how much is 30% of the bill?
- Example 33** 4 Calculate:
- a 20% of the bill, if 6% of the total bill is \$36
- b 80% of the bill, if 15% of the total bill is \$45
- c 3% of the bill, if 40% of the total bill is \$200
- d 7% of the bill, if 25% of the total bill is \$75.
- 5 What is the total volume if 13% of the volume is 143 litres?
- 6 What is the total mass if 120% of the mass is 720 kg?

**PROBLEM-SOLVING**7,  $8(\frac{1}{2})$  $8(\frac{1}{2})$ , 9 $8(\frac{1}{2})$ , 9, 10

- Example 34** 7 A necklace in a jewellery store has been discounted by 20%. If the sale price is \$240, what was the original price of the necklace?

- 8 Find the original price of the following items.
- A pair of jeans discounted by 40% has a sale price of \$30.
  - A hockey stick discounted by 30% has a sale price of \$105.
  - A second-hand computer discounted by 85% has a sale price of \$90.
  - A second-hand textbook discounted by 80% has a sale price of \$6.
  - A standard rose bush discounted by 15% has a sale price of \$8.50.
  - A motorbike discounted by 25% has a sale price of \$1500.
- 9 Forty per cent of workers for a large construction company prefer to have an early lunch and 25% of workers prefer to work through lunch and leave an hour earlier at the end of the day. All other workers prefer a late lunch. If 70 workers prefer a late lunch, how many workers are employed by the construction company?
- 10 Daryl receives an amount of money from his grandparents for his birthday. He spends 70% of the money buying a new music CD. He then spends 50% of the remaining money buying more credit for his mobile phone. After these two purchases, Daryl has \$6 remaining. How much money did Daryl's grandparents give him for his birthday?

**REASONING**

11

11, 12

12, 13

- 11 If 22% of an amount is \$8540, which of the following would give the value of 1% of the amount?  
**A**  $\$8540 \times 100$       **B**  $\$8540 \div 100$       **C**  $\$8540 \times 22$       **D**  $\$8540 \div 22$
- 12 If  $y\%$  of an amount of money is \$8, how much is the full amount of money?
- 13 If  $C\%$  of an amount of money is \$ $D$ , how much is  $F\%$  of the amount of money?

**ENRICHMENT: GST (Goods and Services Tax)**

–

–

14

- 14 Australia has a current GST rate of 10%. This means that for many items an extra 10% of the price is added on to the value of that item. Therefore, the price including GST for these items is actually 110% of the original price.
- For each of the following items, the cost including GST is given. Calculate the cost of each item before GST was added.
    - a hair-dryer selling for \$77
    - a complete *Family Guy* DVD set selling for \$121
    - a manicure costing \$55
    - a lawn mower selling for \$495
    - an airfare from Adelaide to Broome costing \$715
  - Carry out some research on the GST and then answer the following questions.
    - In which year was the GST introduced in Australia?
    - Why was the GST introduced?
    - The GST is also known as a VAT and prior to the GST, Australia operated with a WST. What do VAT and WST stand for? What are the differences between GST, VAT & WST?
    - List several items that are GST exempt.
    - List several organisations that are GST exempt.

## Up-sized phone screen

The Samsun phone company is considering making a new up-sized phone screen compared to one of its smaller models. The smaller model has dimensions 6.3 cm by 11.3 cm. Market research has indicated that a total increase in screen area of 30% should be enough to meet the demand in the market. To increase the screen size, however, the length and the width need to increase by the same percentage so the length and width are in the same proportion.

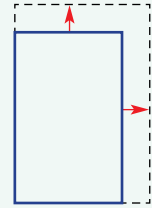

Present a report for the following tasks and ensure that you show clear mathematical workings and explanations where appropriate.

### Preliminary task

- Determine the area of the original Samsun phone screen with a length of 11.3 cm and a width of 6.3 cm.
- Find the length and the width of an up-sized phone if the dimensions (length and width) are increased by 10%.
- Find the area of an up-sized phone screen if the dimensions are increased by 10%. Round your answer to two decimal places.
- What is the difference in areas between the new and old screens when the dimensions are increased by 10%?
- Find the percentage increase in the area of the up-sized phone if the dimensions are increased by 10%. Round your answer to the nearest whole percentage.
- Explain why the area increases by more than 10% when the dimensions are increased by 10%.
- Determine the new phone screen area if the original phone screen's area is increased by 30%. Round your answer to two decimal places.

### Modelling task

Formulate

- The problem is to determine the percentage increase that should be applied to the length and width to achieve a 30% increase in area of the phone screen. Write down all the relevant information that will help solve this problem.
- Make an accurate drawing of the original Samsun phone screen, including an illustration of how the dimensions might be increased.

Solve

- Calculate the area of an up-sized phone, correct to two decimal places, if the original Samsun screen's dimensions are increased by the following percentages.
  - 5%
  - 15%
  - 25%
- Determine which of the above percentage increases leads to an increase of more than 30% in total area. Justify your answer by calculating percentage increases in area.
- One sales executive at Samsun says that to increase the area by 30% you should increase the dimensions by 30%. Demonstrate that the sales executive is wrong.



Evaluate and verify

**f** Examine your results from parts **c** and **d** above and use trial and error to determine the required percentage increase in phone dimensions to achieve a 30% increase in area. Answer correct to the nearest whole percentage.

**g** Refine your calculations from part **f** and find a result correct to two decimal places.

**h** Can you find a more direct approach that helps to answer part **g**? Explain your method.

Communicate

**i** Summarise your results and describe any key findings.

### Extension questions

**a** When the original dimensions are increased by 10%, it has the effect of multiplying the area by 1.21 (a 21% increase). Determine what single number to multiply by to determine the new area if the original dimensions are increased by:

**i** 5%

**ii** 20%

**iii**  $x\%$  (give an expression in terms of  $x$ ).

**b** To return to the original area from the up-sized phone, a percentage decrease is required. Decide if the percentage decrease of the dimensions is the same as the percentage increase that was used to produce the up-sized phone in the first place. Justify your answer with appropriate calculations and diagrams.

**c** An alternative way to increase or decrease the size of the phone screen is to multiply the dimensions by a given fraction (or mixed numeral). For example, if the dimensions are multiplied by  $1\frac{1}{3}$ , then the area will be multiplied by  $1\frac{7}{9}$ . Find a fraction or mixed numeral to multiply the dimensions by to double the area (or get as close as possible to double).



## Paying for Australia

### Key technology: Spreadsheets

As at 2023, Australia's total population is about 25.5 million, its total government expenditure is about \$600 billion and the total taxation revenue is about \$550 billion. About half of Australia's government revenue comes from personal income tax with most people paying tax based on the following tax table.

Taxable income	Tax on this income
0 – \$18 200	Nil
\$18 201 – \$45 000	19 cents for each \$1 over \$18 200
\$45 001 – \$120 000	\$5092 plus 32.5 cents for each \$1 over \$45 000
\$120 001 – \$180 000	\$29 467 plus 37 cents for each \$1 over \$120 000
\$180 001 and over	\$51 667 plus 45 cents for each \$1 over \$180 000

### 1 Getting started

For this activity, assume the following facts about Australia.

- The current population is 25.5 million, including 20 million adults.
  - The total government expenditure is \$600 billion.
  - The average personal income tax is \$12 500 per adult.
  - The total revenue from other taxes (not income tax) is \$300 billion.
- a What is the total revenue to the Australian government from personal income tax paid by adult Australians?
  - b By combining the total personal income tax and other taxes, does Australia earn enough revenue to pay for its total expenditure? Give reasons.
  - c Use the tax table above to calculate the total tax payable on the following taxable incomes. (We will ignore the Medicare levy for now.)
    - i \$30 000
    - ii \$100 000
    - iii \$150 000





## 2 Using technology

The following spreadsheet is a simple balance sheet for the Australian economy using the information from part 1 above.

	A	B	C	D	E	F
1	Paying for Australia		Average adult tax paid	12500		
2						
3		Population increase (%)		Other income increase (%)	Expenditure increase (%)	
4		0.5		1	1	
5						
6	Year	Population	Income tax	Other income	Expenditure	Balance
7		million	\$billions	\$billions	\$billions	\$billions
8						
9	2023	20	=B9*D\$1*1000000/1000000000	300	600	=D9+C9-E9
10	=A9+1	=B9*(1+B\$4/100)		=D9*(1+D\$4/100)	=E9*(1+E\$4/100)	

- a Enter all the information into a spreadsheet and answer the following.
  - i The total revenue from personal income tax is calculated in C9. From which cell does the formula receive the average tax paid by each adult?
  - ii The population increase year by year is currently set at 0.5%. Explain how the formula in cell B10 uses this information to calculate the correct total figure after the increase.
  - iii Explain how the formulas in cells D10 and E10 work.
- b Fill down at cells A10, B10, C9, D10, E10 and F9 to year 2033. What do you notice about the overall financial balance over this time?
- c Change the average amount of income tax paid by Australian adults in cell D1 to \$13 000. Does this improve Australia's balance sheet?
- d Let's now assume that the average Australian taxable income is \$75 000.
  - i Use the above tax table to calculate the average tax paid using this taxable income.
  - ii Use your result from part d i in your spreadsheet to update cell D1. Does this improve Australia's balance sheet?

## 3 Applying an algorithm

- a We will systematically apply this algorithm to explore what average taxable income is needed to provide Australia with enough tax revenue. Start with  $I = 50\,000$ .
  - Step 1: Calculate the tax paid by an Australian earning  $\$I$ .
  - Step 2: Enter this tax amount into cell D1 of your spreadsheet.
  - Step 3: Record Australia's balance at year 2033.
  - Step 4: Increase  $I$  by 5000.
  - Step 5: Return to Step 1.
- b To the nearest \$5000, what average taxable income provides Australia with a positive balance at year 2033?
- c Change the rate of Australia's population growth in cell B4. Explore how this change affects the financial balance at year 2033 compared to the original 0.5% rate.

## 4 Extension

- a Explore how changing the rate of increase of Australia's other reported income in cell D4 changes the overall financial balance.
- b Explore how changing the rate of increase of Australia's expenditure in cell E4 changes the overall financial balance.
- c By choosing values for cells D1, B4, D4 and E4, find a scenario where Australia's balance is approximately the following at 2033.
  - i  $-\$100$  billion
  - ii  $\$50$  billion
  - iii  $\$200$  billion
  - iv  $\$0$  billion

## Phi, the golden number

The Golden ratio involves a special number denoted by the Greek letter phi ( $\Phi$ ). It is often referred to as the golden section or divine proportion. There are remarkable observations of this ratio in nature and in a number of applications in mathematics, and many artists and architects have used this ratio in their paintings and designs. We will explore the Golden ratio further in this investigation.

### Constructing a golden rectangle

- 1 You will need a ruler, a pencil, a pair of compasses and a sheet of A4 paper.
  - a Construct a square of side length 15 cm on your paper.
  - b Rule a line from the midpoint ( $M$ ) of one side of the square to the opposite corner ( $C$ ) as shown.
  - c With your compass point on  $M$  and the compass pencil on  $C$  (radius  $MC$ ), draw an arc from  $C$  as shown.
  - d Extend the base of the square to meet this arc. This new length is the base length of a golden rectangle.
  - e Complete the golden rectangle and erase the vertical line from  $C$  and the arc.
  - f You now have two golden rectangles, one inside the other.

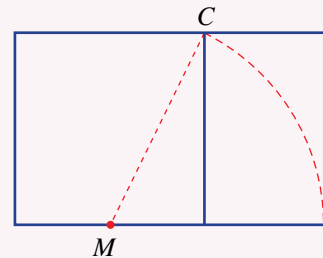

### Constructing a golden spiral

- 2 Using the golden rectangle construction from Question 1, complete the following.
  - a In your smaller golden rectangle, rule the largest square that can be drawn next to the first square.
  - b Continue adding squares in each smaller golden rectangle until there are at least 7 adjacent squares arranged as shown below.
  - c In each square, mark the corners that are closest to the smallest square.
  - d Using a compass with the point on these corners, draw arcs equal to the side of each square.
  - e Colour your golden spiral pattern.

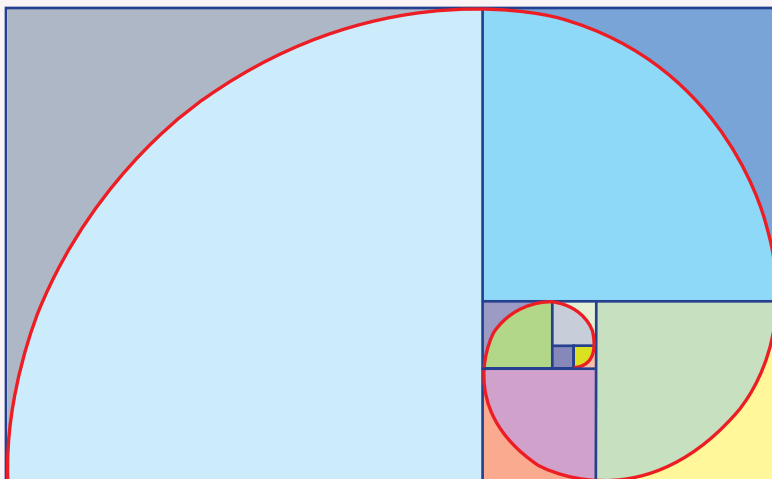

## Calculating phi

- 3 Phi is the ratio of the length to the width (height) of a golden spiral or a golden rectangle. In the design you have drawn, there are several golden rectangles.
- Measure the length and width of each golden rectangle and calculate the value of phi (length divided by width) for each.
  - Work out the average (mean) of all your calculations of phi. Compare your average with the actual value of  $\frac{1 + \sqrt{5}}{2} = 1.61803 \dots$

## Golden rectangles in the human body

- 4 Investigate some of your own measurements to see how close they are to the golden ratio of phi:  
 $1 \approx 1.6 : 1$

Golden ratios in the human body include:

- total height : head to fingertips
- total height : navel (belly button) to floor
- height of head : width of head
- shoulder to fingertips : elbow to fingertips
- length of forearm : length of hand
- hip to floor : knee to floor
- length of longest bone of finger : length of middle bone of same finger
- eyes to the bottom of the chin : width of 'relaxed' smile
- width of two centre teeth : height of centre tooth.

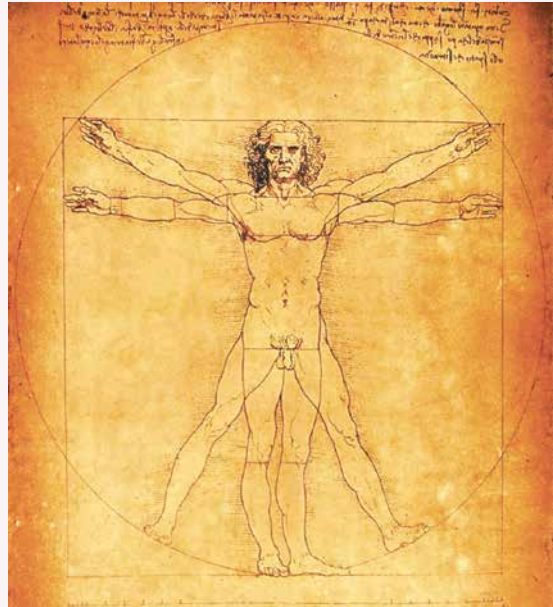

## Research and class presentation

- 5 Research using the internet to discover examples of golden rectangles in nature, human anatomy, architecture, art or graphic design. Present your findings to your class using a poster, report or technology.

- The side lengths of a cube are all increased by 20%. As a percentage, by how much does its volume change?
- The cost of an item in a shop increased by 20% and was later decreased by 20% at a sale. Express the final price as a percentage of the original price.
- Evaluate  $\frac{1}{2} \times \frac{2}{3} \times \frac{3}{4} \times \frac{4}{5} \times \dots \times \frac{999}{1000}$  without using a calculator.
- Some prize money is shared between three students. Abby receives  $\frac{1}{4}$  of the prize, Evie  $\frac{1}{3}$  and Molly the remainder. If Molly was given \$20, what was the total value of the prize money?
- Freshly squeezed orange juice contains 85% water. A food factory has 100 litres of fresh orange juice, which is then concentrated by removing 80% of the water. What percentage of water is in the concentrated orange juice?
- On line segment  $AD$ ,  $AC$  is  $\frac{2}{3}$  of  $AD$  and  $BD$  is  $\frac{3}{4}$  of  $AD$ . What fraction of  $AD$  is  $BC$ ?

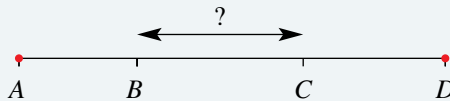

Up for a challenge? If you get stuck on a question, check out the 'Working with unfamiliar problems' poster at the end of the book to help you.



- Fifty people said they liked apples or bananas or both. Forty per cent of the people like apples and 70% of the people like bananas. What percentage of people like only apples?
- A bank balance of \$100 has 10% of its value added to it at the end of every year, so that at the end of the second year the new balance is  $\$110 + \$11 = \$121$ .  
How many full years will it take for the balance to be more than \$10000?
- From the time Lilli gets up until her bus leaves at 8:03 a.m., she uses one-fifth of the time having a shower and getting dressed, then one-quarter of the remaining time packing her lunch and school bag, one-third of the remaining time having breakfast and then one-half of the remaining time practising the piano, which she finishes at exactly 7:45 a.m. At what time does Lilli get up?
- Four numbers  $a, b, c, d$  are evenly spaced along a number line. Without using a calculator, find the values of  $b$  and  $c$  as fractions given that:
  - $a = -1\frac{1}{3}, d = \frac{1}{6}$
  - $a = 1\frac{7}{10}, d = 2\frac{1}{5}$

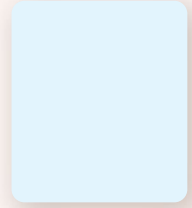
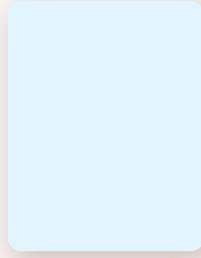

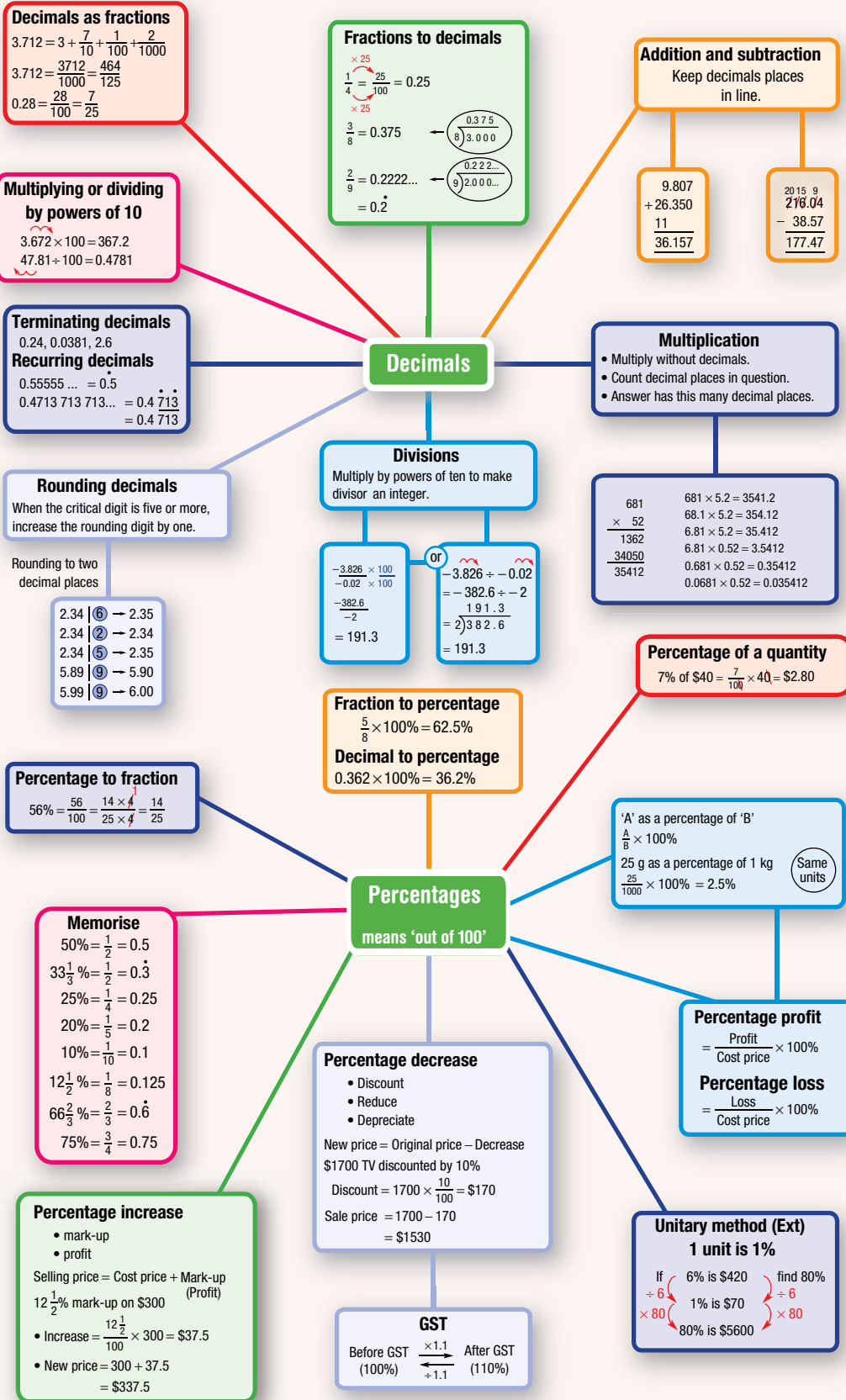

# Chapter checklist with success criteria

A printable version of this checklist is available in the Interactive Textbook



3A	<b>1. I can generate equivalent fractions.</b> e.g. Rewrite $\frac{3}{5}$ as an equivalent fraction with a denominator of 40.	<input type="checkbox"/>
3A	<b>2. I can convert a fraction to simplest form.</b> e.g. Write the fraction $\frac{8}{20}$ in its simplest form.	<input type="checkbox"/>
3B	<b>3. I can add and subtract fractions, including mixed numerals.</b> e.g. Simplify $\frac{5}{3} - \frac{3}{4}$ and $3\frac{5}{8} + 2\frac{3}{4}$ .	<input type="checkbox"/>
3B	<b>4. I can multiply fractions, including mixed numerals.</b> e.g. Simplify $\frac{2}{5} \times \frac{3}{7}$ and $3\frac{1}{3} \times 2\frac{2}{5}$ .	<input type="checkbox"/>
3B	<b>5. I can divide fractions, including mixed numerals.</b> e.g. Simplify $\frac{2}{5} \div \frac{3}{7}$ and $2\frac{1}{4} \div 1\frac{1}{3}$ .	<input type="checkbox"/>
3C	<b>6. I can add and subtract negative fractions.</b> e.g. Simplify $\frac{2}{3} - (-\frac{4}{3})$ and $\frac{1}{5} + (-\frac{1}{4})$ .	<input type="checkbox"/>
3C	<b>7. I can multiply and divide negative fractions.</b> e.g. Simplify $-\frac{6}{5} \times (-\frac{3}{4})$ and $-1\frac{1}{3} \div 3$ .	<input type="checkbox"/>
3D	<b>8. I can compare decimals.</b> e.g. Compare the decimals 57.89342 and 57.89631 and place the correct inequality sign between them.	<input type="checkbox"/>
3D	<b>9. I can convert decimals to fractions.</b> e.g. Convert 5.12 to a fraction in its simplest form.	<input type="checkbox"/>
3D	<b>10. I can convert simple fractions to decimals.</b> e.g. Convert $\frac{9}{25}$ to a decimal.	<input type="checkbox"/>
3E	<b>11. I can add and subtract decimals.</b> e.g. Calculate $9.7 - 2.86$ .	<input type="checkbox"/>
3E	<b>12. I can multiply and divide decimals by powers of 10.</b> e.g. Calculate $9.753 \div 100$ and $27.58 \times 10000$ .	<input type="checkbox"/>
3E	<b>13. I can multiply decimals.</b> e.g. Calculate $4.13 \times 9.6$ .	<input type="checkbox"/>
3E	<b>14. I can divide decimals.</b> e.g. Calculate $64.137 \div 0.03$ .	<input type="checkbox"/>
3F	<b>15. I can convert fractions to a terminating or recurring decimal.</b> e.g. Write $\frac{7}{8}$ as a terminating decimal and $3\frac{5}{7}$ as a recurring decimal.	<input type="checkbox"/>

			✓
3F	<b>16. I can round terminating decimals.</b> e.g. Round 4.86195082 to four decimal places.		<input type="checkbox"/>
3F	<b>17. I can round recurring decimals.</b> e.g. Write $\frac{3}{7}$ as a decimal correct to two decimal places.		<input type="checkbox"/>
3G	<b>18. I can convert percentages to fractions or mixed numerals.</b> e.g. Convert 160% to a mixed numeral in its simplest form.		<input type="checkbox"/>
3G	<b>19. I can convert percentages to decimals.</b> e.g. Convert 13.45% to a decimal.		<input type="checkbox"/>
3G	<b>20. I can convert fractions or mixed numerals to percentages.</b> e.g. Convert $\frac{7}{40}$ to a percentage.		<input type="checkbox"/>
3G	<b>21. I can convert decimals to percentages.</b> e.g. Convert 0.458 to a percentage.		<input type="checkbox"/>
3H	<b>22. I can express one quantity as a percentage of another, converting units if required.</b> e.g. Express 34 out of 40 as a percentage, and 60 cents as a percentage of \$5.		<input type="checkbox"/>
3H	<b>23. I can find a certain percentage of a quantity.</b> e.g. Find 155% of 60.		<input type="checkbox"/>
3I	<b>24. I can find the result when a value is increased by a percentage.</b> e.g. Find the new value of a \$160 item that is marked up by 40%.		<input type="checkbox"/>
3I	<b>25. I can find the result when a value is decreased by a percentage.</b> e.g. Find the cost of a \$860 television that has been discounted by 25%.		<input type="checkbox"/>
3J	<b>26. I can calculate the percentage change when prices are increased or decreased.</b> e.g. Calculate the percentage loss when \$60 becomes \$48.		<input type="checkbox"/>
3K	<b>27. I can use the unitary method to find the full amount.</b> e.g. If 8% of an amount is \$48, what is the full amount of money?	Ext	<input type="checkbox"/>
3K	<b>28. I can use the unitary method to find a new percentage.</b> e.g. If 11% of the food bill was \$77, how much is 25% of the food bill?	Ext	<input type="checkbox"/>
3K	<b>29. I can use the unitary method to find the original price.</b> e.g. A pair of shoes has been discounted by 20%. If the sale price was \$120, what was the original price of the shoes?	Ext	<input type="checkbox"/>



## Short-answer questions

3A

1 Copy and complete the following.

a  $\frac{7}{20} = \frac{\square}{60}$

b  $\frac{25}{40} = \frac{5}{\square}$

c  $\frac{350}{210} = \frac{\square}{6}$

3A

2 Simplify these fractions.

a  $\frac{25}{45}$

b  $\frac{36}{12}$

c  $\frac{102}{12}$

3B

3 Evaluate each of the following.

a  $\frac{5}{11} + \frac{2}{11}$

b  $\frac{7}{8} - \frac{3}{4}$

c  $3 - 1\frac{1}{4}$

d  $3\frac{1}{4} - 1\frac{2}{3}$

e  $2\frac{2}{5} + 3\frac{1}{4}$

f  $1\frac{1}{2} + 2\frac{2}{3} - \frac{3}{5}$

3B

4 Evaluate each of the following.

a  $\frac{2}{3} \times 12$

b  $\frac{3}{7} \times 1\frac{1}{12}$

c  $2\frac{1}{3} \times 6$

d  $3 \div \frac{1}{2}$

e  $\frac{2}{3} \div 12$

f  $1\frac{1}{2} \div \frac{3}{4}$

3C

5 Evaluate each of the following.

a  $\frac{1}{5} - \frac{2}{3}$

b  $-\frac{3}{4} \times \frac{1}{5}$

c  $\left(-\frac{3}{5}\right)^2$

d  $\frac{3}{4} - \left(-\frac{1}{5}\right)$

e  $\frac{5}{3} \div \left(-\frac{1}{3}\right)$

f  $-6\frac{1}{4} + \left(-1\frac{1}{3}\right)$

3D

6 Insert  $>$ ,  $<$  or  $=$  to make each of the statements below true.

a  $\frac{11}{20} \square 0.55$

b  $\frac{2}{3} \square 0.7$

c  $0.763 \square 0.7603$

3E

7 Evaluate each of the following.

a  $12.31 + 2.34 + 15.73$

b  $14.203 - 1.4$

c  $569.74 \times 100$

d  $25.14 \times 2000$

e  $7.4 \times 10^4$

f  $5 - 2.0963$

3E

8 Calculate each of the following.

a  $2.67 \times 4$

b  $2.67 \times 0.04$

c  $1.2 \times 12$

d  $1.02 \div 4$

e  $1.8 \div 0.5$

f  $9.856 \div 0.05$

3F

9 Round these decimals to three decimal places.

a  $0.\dot{6}$

b  $3.57964$

c  $0.00549631$

3G

10 Copy and complete this table of conversions.

0.1					0.75		
	$\frac{1}{100}$			$\frac{1}{4}$		$\frac{1}{3}$	$\frac{1}{8}$
		5%	50%				

- 3H** 11 Express each of the following as a percentage.  
 a \$35 out of \$40                      b 6 out of 24                      c \$1.50 out of \$1  
 d 16 cm out of 4 m                      e 15 g out of  $\frac{1}{4}$  kg
- 3H** 12 Find:  
 a 30% of 80  
 b 15% of \$70  
 c  $12\frac{1}{2}\%$  of 84.
- 3I** 13 a Increase \$560 by 10%.  
 b Decrease \$4000 by 18%.  
 c Increase \$980 by 5% and then decrease the result by 5%. Calculate the overall percentage loss.
- 3I** 14 A new plasma television was valued at \$3999. During the end-of-year sale it was discounted by 9%. What was the discount and the sale price?
- 3J** 15 Jenni works at her local pizza takeaway restaurant and is paid \$7.76 per hour. When she turns 16, her pay will increase to \$10 an hour. What will be the percentage increase in her pay (to the nearest per cent)?
- 3J** 16 Johan saved 15% of his weekly wage. He saved \$5304 during the year. Calculate Johan's weekly wage.
- 3J** 17 Mary measures the volume of a cup to be 240 mL when the actual volume is 250 mL. Find Mary's percentage error.
- 3K** 18 If 5% of an amount equals 56, what is 100% of the amount?
- Ext** 19 A shopping receipt quotes an A4 folder as costing \$3.64, including 10% GST. What is the cost of the folder pre-GST, correct to the nearest cent?

### Multiple-choice questions

- 3A** 1 0.36 expressed as a fraction is:  
 A  $\frac{36}{10}$                       B  $\frac{36}{100}$                       C  $\frac{3}{6}$                       D  $\frac{9}{20}$
- 3B** 2  $\frac{2}{11} + \frac{5}{8}$  is equal to:  
 A  $\frac{7}{19}$                       B  $\frac{10}{19}$                       C  $\frac{71}{88}$                       D  $\frac{31}{44}$
- 3E** 3 When 21.63 is multiplied by 13.006, the number of decimal places in the answer is:  
 A 2                      B 3                      C 4                      D 5
- 3A** 4  $\frac{124}{36}$  is the same as:  
 A 88                      B  $\frac{34}{9}$                       C  $3\frac{4}{9}$                       D 3.49
- 3B** 5 When  $5\frac{1}{3}$  is written as an improper fraction, its reciprocal is:  
 A  $\frac{1}{53}$                       B 53                      C  $\frac{16}{3}$                       D  $\frac{3}{16}$

- 3D** 6 Which decimal has the largest value?  
 A 6.0061                      B 6.06                      C 6.016                      D 6.0006
- 3E** 7  $9.46 \times 100\,000$  is the same as:  
 A 94 600 000                      B 946 000                      C 94 605                      D 0.0000946
- 3H** 8 75% of 84 is the same as:  
 A  $\frac{84}{4} \times 3$                       B  $\frac{84}{3} \times 4$                       C  $84 \times 100 \div 75$                       D  $\frac{(0.75 \times 84)}{100}$
- 3G** 9 590% is the same as:  
 A 59.0                      B 0.59                      C 5.9                      D 0.059
- 3I** 10 \$790 increased by 15% gives:  
 A \$118.50                      B \$908.50                      C \$671.50                      D \$805

### Extended-response question



The table below shows the value of A\$1 (one Australian dollar) in foreign currency.

Indian rupee (INR)	42
Singapore dollar (SGD)	1.25
Thai baht (THB)	30
Hong Kong dollar (HKD)	7

Genevieve is planning an extended holiday to Asia, where she plans on visiting India, Singapore, Phuket and Hong Kong.

- a** She has decided to convert some Australian dollars to each of the above currencies before she flies out. How much of each currency will she receive if she converts A\$500 to each currency?
- b** During the exchange she needs to pay a fee of 1.5% for each transaction. How much has she paid in fees (in A\$)?
- c** **i** The day after she leaves, the exchange rate for Indian rupees is A\$1 = 43.6 INR. How much more would she have received if she had waited until arriving in India to convert her Australian dollars? (Ignore transaction fees.)  
**ii** Express this as a percentage (to one decimal place).
- d** **i** On her return to Australia, Genevieve has in her wallet 1000 INR, 70 SGD and 500 THB. Using the same exchange rate, how much is this in A\$?  
**ii** She also needs to pay the 1.5% transaction fee. How much does she receive in A\$, and is it enough to buy a new perfume at the airport for \$96?



# 4

## Measurement and Pythagoras' theorem

### Maths in context: Measurement skills are essential for our lifestyles

We depend on experts, using geometry and measurement skills, to accurately design and construct our:

- house frames with parallel vertical studs, parallel horizontal ceiling joists, and sloping roof rafter lengths calculated using Pythagoras' theorem.
- houses with rectangular prism rooms having painted surface areas, and rectangular house blocks with perimeter fencing.
- vehicles, circular wheel circumferences fitted with tyres, arc-shaped road curves driven using a vehicle's steering mechanisms, and circle sectors cleaned by windscreen wipers.
- water supply and sewage systems, which are crucial to health, using cylindrical pipes.
- farms with rectangular paddocks for food crops or animals, with perimeters fenced and cylindrical silos for grain storage, circular and rectangular irrigation areas.

We play sport for our health and cultural enjoyment, so geometry and measurement skills are essential for the construction of:

- cricket ovals and rectangular football fields and tennis courts.
- basketball and netball rectangular courts with centre circle, goal semicircles and circular goal rings.
- running, cycling and ice speed-skating tracks following the outer perimeter of a rectangle with semicircles at each end.
- shot put, discus and javelin throwing circles with sector landing areas.
- swimming and diving pools containing rectangular or trapezoidal prism-shaped volumes of water.



## Chapter contents

- 4A Length and perimeter (CONSOLIDATING)
- 4B Circumference of circles (CONSOLIDATING)
- 4C Area (CONSOLIDATING)
- 4D Area of special quadrilaterals
- 4E Area of circles
- 4F Area of sectors and composite shapes (EXTENDING)
- 4G Surface area of prisms (EXTENDING)
- 4H Volume and capacity
- 4I Volume of prisms and cylinders
- 4J Units of time and time zones
- 4K Introducing Pythagoras' theorem
- 4L Using Pythagoras' theorem
- 4M Calculating the length of a shorter side

## Victorian Curriculum 2.0

This chapter covers the following content descriptors in the Victorian Curriculum 2.0:

### MEASUREMENT

VC2M8M01, VC2M8M02, VC2M8M03, VC2M8M04, VC2M8M06, VC2M8M07

### NUMBER

VC2M8N01

Please refer to the curriculum support documentation in the teacher resources for a full and comprehensive mapping of this chapter to the related curriculum content descriptors.

© VCAA

## Online resources

A host of additional online resources are included as part of your Interactive Textbook, including HOTmaths content, video demonstrations of all worked examples, auto-marked quizzes and much more.

## 4A Length and perimeter CONSOLIDATING

### LEARNING INTENTIONS

- To understand that perimeter is the distance around a shape and is measured in one dimensional units, such as kilometres, metres, centimetres and millimetres
- To be able to convert between different metric units of length
- To be able to find the perimeter of a shape when its individual side lengths are known
- To be able to find an unknown side length of a shape when its perimeter is known

For thousands of years, civilisations have found ways to measure length. The Egyptians, for example, used the cubit (length of an arm from the elbow to the tip of the middle finger), the Romans used the pace (5 feet) and the English developed their imperial system using inches, feet, yards and miles. The modern-day system used in Australia (and most other countries) is the metric system, which was developed in France in the 1790s and is based on the unit called the metre. We use units of length to describe the distance between two points, or the distance around the outside of a shape, called the perimeter.

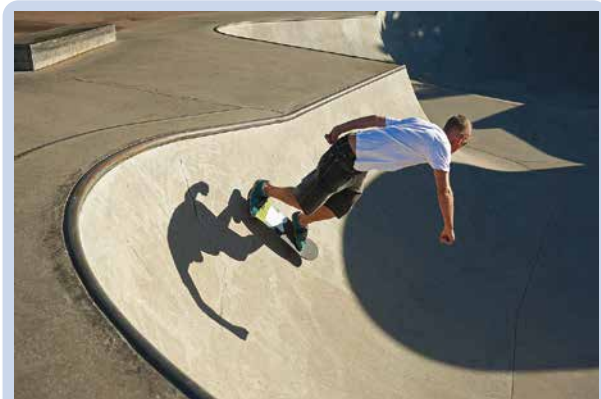

Engineers design skateboard parks with a smooth metal edging attached to the perimeter of the concrete bowls.

### Lesson starter: Provide the perimeter

In this diagram some of the lengths are given. Three students were asked to find the perimeter.

- Will says that you cannot work out some lengths and so the perimeter cannot be found.
- Sally says that there is enough information and the answer is  $9 + 12 = 21$  cm.
- Greta says that there is enough information and the answer is  $90 + 12 = 102$  cm.

Who is correct?

Discuss how each person arrived at their answer.

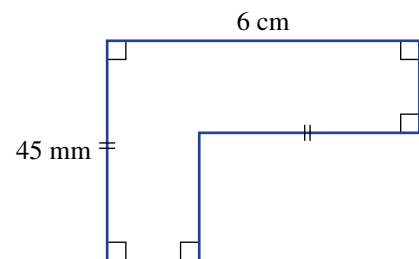

### KEY IDEAS

■ The common metric units of length include the **kilometre** (km), **metre** (m), **centimetre** (cm) and **millimetre** (mm).

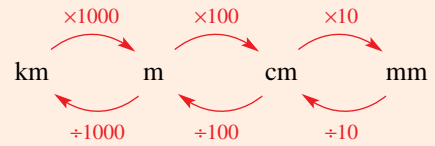

■ **Perimeter** is the distance around a closed shape.

- All units must be of the same type when calculating the perimeter.
- Sides with the same type of markings (dashes) are of equal length.

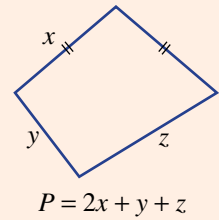

### BUILDING UNDERSTANDING

1 State the missing number in these sentences.

- |                              |                              |
|------------------------------|------------------------------|
| a There are ____ mm in 1 cm. | b There are ____ cm in 1 m.  |
| c There are ____ m in 1 km.  | d There are ____ cm in 1 km. |
| e There are ____ mm in 1 m.  | f There are ____ mm in 1 km. |

2 Evaluate the following.

- |                   |                     |                               |
|-------------------|---------------------|-------------------------------|
| a $10 \times 100$ | b $100 \times 1000$ | c $10 \times 100 \times 1000$ |
|-------------------|---------------------|-------------------------------|

3 State the value of  $x$  in these diagrams.

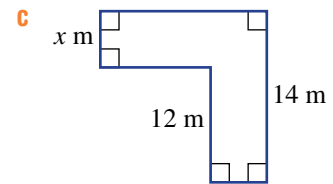
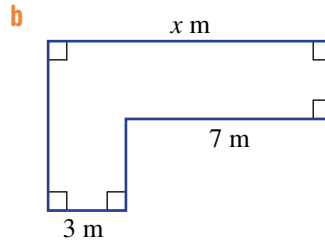
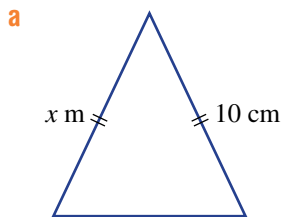

**Example 1 Converting length measurements**

Convert these lengths to the units shown in the brackets.

**a** 5.2 cm (mm)

**b** 85 000 cm (km)

**SOLUTION**

$$\begin{aligned} \mathbf{a} \quad 5.2 \text{ cm} &= 5.2 \times 10 \text{ mm} \\ &= 52 \text{ mm} \end{aligned}$$

$$\begin{aligned} \mathbf{b} \quad 85\,000 \text{ cm} &= 85\,000 \div 100 \text{ m} \\ &= 850 \text{ m} \\ &= 850 \div 1000 \text{ km} \\ &= 0.85 \text{ km} \end{aligned}$$

**EXPLANATION**

1 cm = 10 mm so multiply by 10.

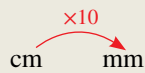

1 m = 100 cm and 1 km = 1000 m so divide by 100 and 1000.

**Now you try**

Convert these lengths to the units shown in the brackets.

**a** 35 cm (mm)

**b** 120 000 cm (km)

**Example 2 Finding perimeters**

Find the perimeter of this shape.

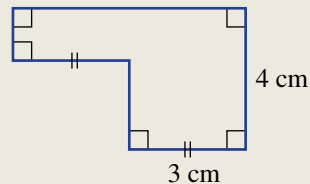
**SOLUTION**

$$\begin{aligned} P &= 2 \times (3 + 3) + 2 \times 4 \\ &= 12 + 8 \\ &= 20 \text{ cm} \end{aligned}$$

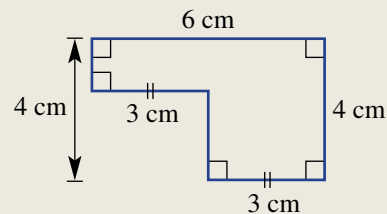
**EXPLANATION****Now you try**

Find the perimeter of this shape.

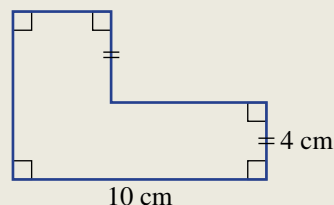





**Example 3 Finding an unknown length given a perimeter**

Find the unknown value  $x$  in this triangle if the perimeter is 19 cm.

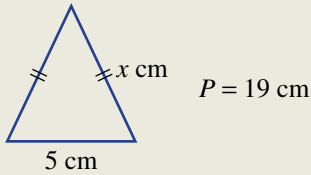

**SOLUTION**

$$\begin{aligned} 2x + 5 &= 19 \\ 2x &= 14 \\ x &= 7 \end{aligned}$$

**EXPLANATION**

$2x + 5$  makes up the perimeter.  
 Subtract 5 from both sides of the equation.  
 If  $2x = 14$  then  $x = 7$  since  $2 \times 7 = 14$ .

**Now you try**

Find the unknown value  $x$  in this triangle if the perimeter is 28 cm.

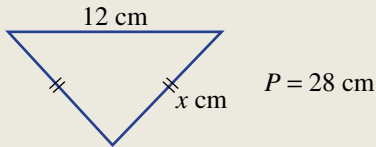

**Exercise 4A**

**FLUENCY**

1, 2–3( $\frac{1}{2}$ ), 5( $\frac{1}{2}$ )

2–5( $\frac{1}{2}$ )

2( $\frac{1}{4}$ ), 3–5( $\frac{1}{3}$ )

1 Convert these lengths to the units shown in the brackets.

Example 1a

a i 3.6 cm (mm)                                      ii 28 mm (cm)

Example 1b

b i 42 000 cm (km)                                      ii 0.21 km (cm)

Example 1

2 Convert these measurements to the units shown in the brackets.

- |                  |                   |
|------------------|-------------------|
| a 3 cm (mm)      | b 6.1 m (cm)      |
| c 8.93 km (m)    | d 3 m (mm)        |
| e 0.0021 km (m)  | f 320 mm (cm)     |
| g 9620 m (km)    | h 38 000 cm (km)  |
| i 0.0043 m (mm)  | j 0.0204 km (cm)  |
| k 23 098 mm (m)  | l 342 000 cm (km) |
| m 194 300 mm (m) | n 10 000 mm (km)  |
| o 0.02403 m (mm) | p 994 000 mm (km) |

**Example 2** 3 Find the perimeter of these shapes.

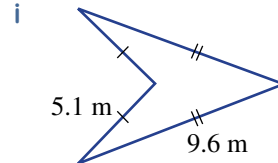
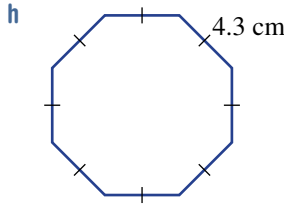
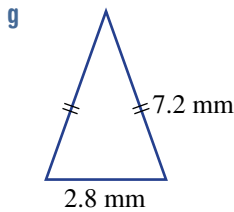
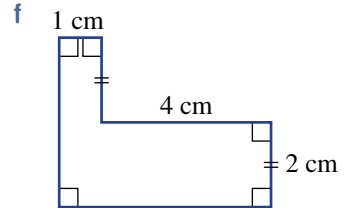
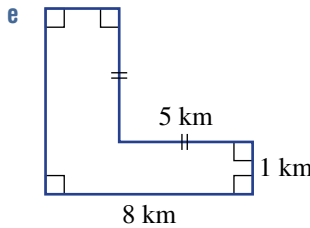
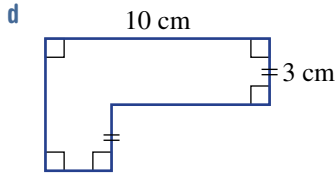
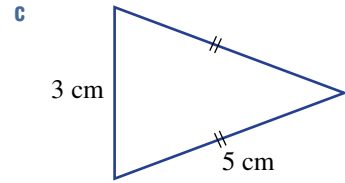
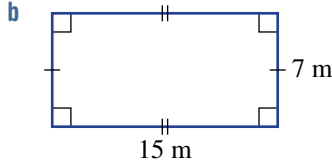
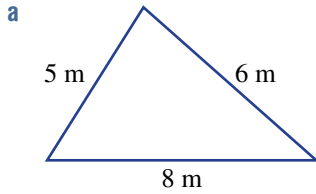

**Example 3** 4 Find the unknown value  $x$  in these shapes with the given perimeter ( $P$ ).

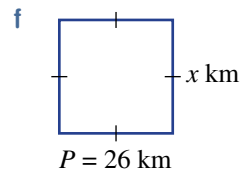
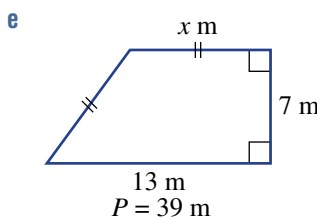
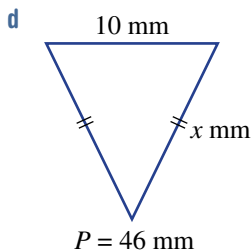
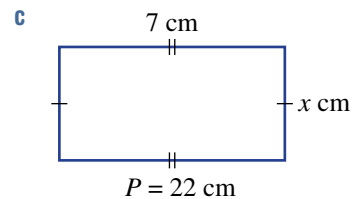
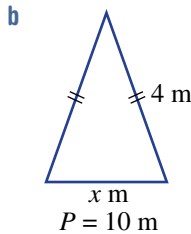
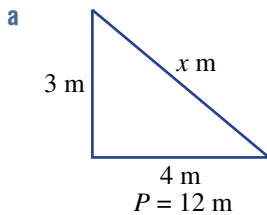

5 Choose the most appropriate unit of measurement from millimetres (mm), metres (m) and kilometres (km) for the following items being measured.

- a** the width of a football ground
- b** the length of a small insect
- c** the distance for a sprinting race
- d** the distance a person drives their car in a week
- e** the height of a building
- f** the distance between lines on a piece of lined paper

**PROBLEM-SOLVING**

6, 7

6, 7,  $8(\frac{1}{2})$ , 9

7,  $8(\frac{1}{2})$ , 10, 11

- 6 A rectangular room has a length of 4 m and a perimeter of 14 m. Draw a diagram showing the length and width of the room, and check that the perimeter is 14 m.
- 7 Jennifer needs to fence her country house block to keep her dog in. The block is a rectangle with length 50 m and width 42 m. Fencing costs \$13 per metre. What will be the total cost of fencing?
- 8 Find the perimeter of these shapes. Give your answers in cm and assume that angles that look right-angled are  $90^\circ$ .

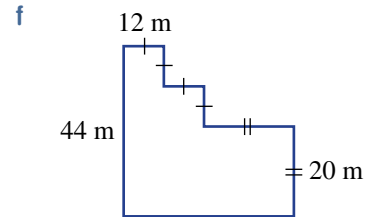
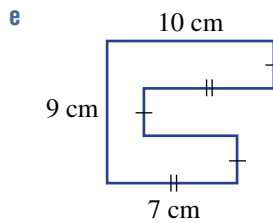
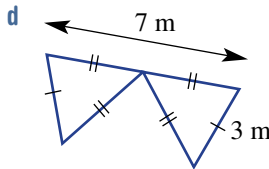
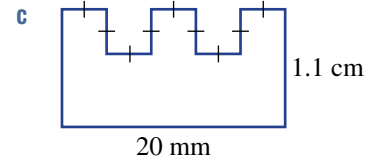
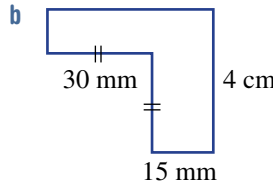
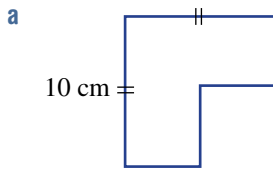

- 9 Gillian can jog 100 metres in 24 seconds. How long will it take her to jog 2 km? Give your answer in minutes.

- 10 A rectangular picture of length 65 cm and width 35 cm is surrounded by a frame of width 5 cm. What is the perimeter of the framed picture?

- 11 Find the unknown value  $x$  in these diagrams. All angles are  $90^\circ$ .

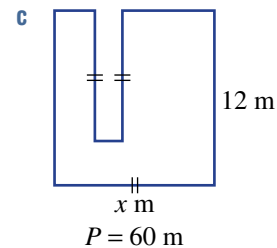
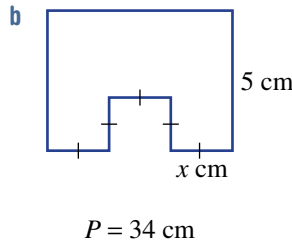
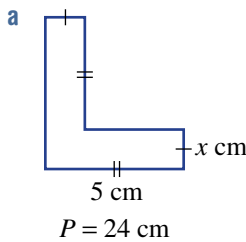

**REASONING**

12, 13

13, 14

13, 14– $15(\frac{1}{2})$

- 12 When a length is measured in practice, the true length of the object might not be exactly the same as the reported measurement. For example, if someone says they are 173 cm tall, they might be anywhere from 172.5 cm to 173.5 cm. Use this principle to give a range for someone whose height is reported as:

a 153 cm

b 178 cm

c 160 cm.

13 A rectangular room is initially estimated to be 4 metres wide and 6 metres long. It is then measured to the nearest centimetre as 403 cm by 608 cm. Finally, it is measured to the nearest millimetre as 4032 mm by 6084 mm.



- a Give the perimeters of the room from each of these three sets of measurements.
- b What is the difference, in millimetres, between the largest and smallest perimeter?
- c Which is the most accurate value to use for the perimeter of the room?

14 Write down rules using the given letters for the perimeter of these shapes, e.g.  $P = a + 2b$ . Assume that angles that look right-angled are  $90^\circ$ .

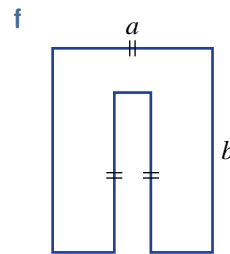
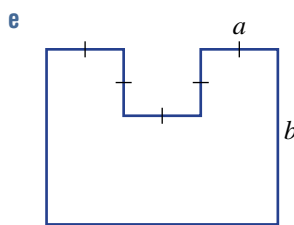
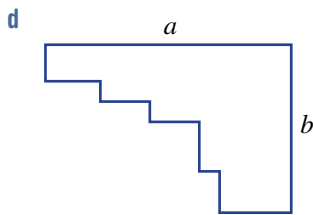
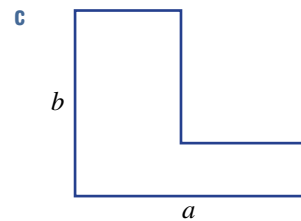
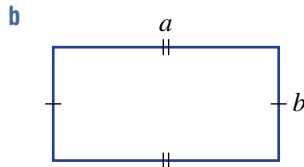
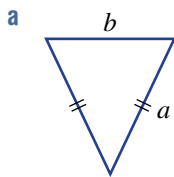

15 Write a rule for  $x$  in terms of its perimeter  $P$ , e.g.  $x = P - 10$ .

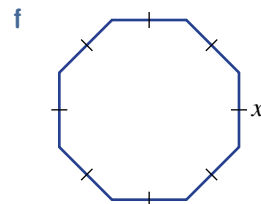
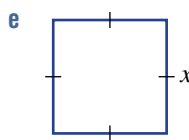
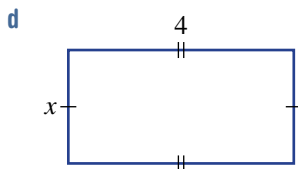
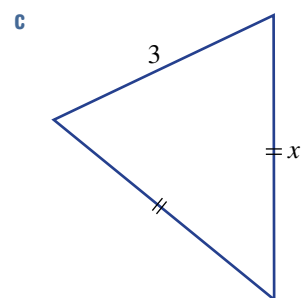
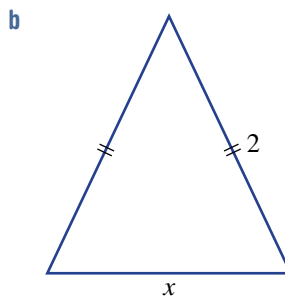
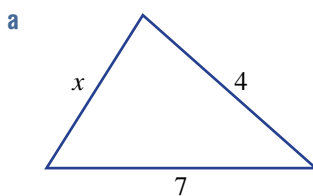

## ENRICHMENT: Disappearing squares

16

- 16 A square is drawn with a particular side length. A second square is drawn inside the square so that its side length is one-third that of the original square. Then a third square is drawn, with side length of one-third that of the second square and so on.
- What is the minimum number of squares that would need to be drawn in this pattern (including the starting square), if the innermost square has a perimeter of less than 1 hundredth the perimeter of the outermost square?
  - Imagine now if the situation is reversed and each square's perimeter is 3 times larger than the next smallest square. What is the minimum number of squares that would be drawn in total if the perimeter of the outermost square is to be at least 1000 times the perimeter of the innermost square?

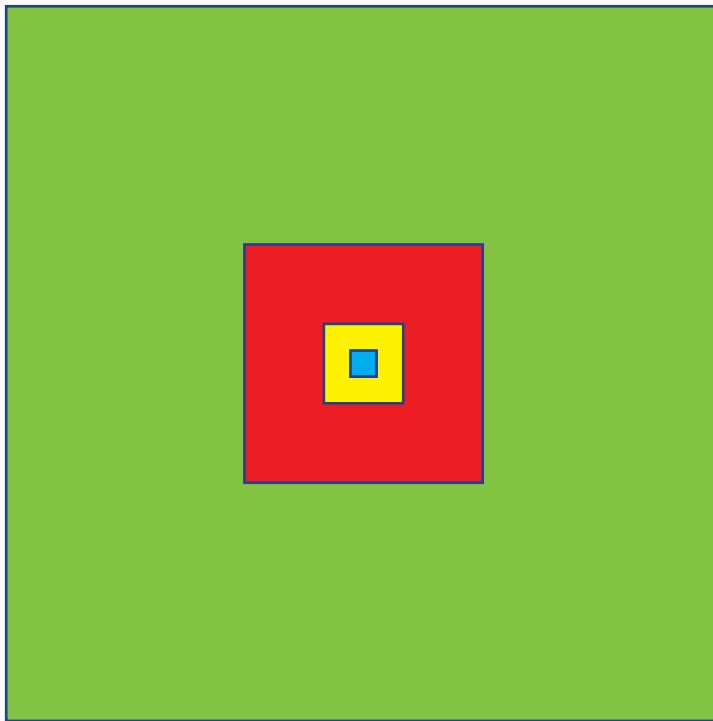

## 4B Circumference of circles CONSOLIDATING

### LEARNING INTENTIONS

- To know the meaning of the terms diameter, radius and circumference
- To understand that pi ( $\pi$ ) is a number that equals the circumference of any circle divided by its diameter
- To be able to find the circumference of a circle using a calculator
- To be able to find the circumference of a circle using an approximation for  $\pi$

Since the ancient times, people have known about a special number that links a circle's diameter to its circumference. We know this number as pi ( $\pi$ ).  $\pi$  is a mathematical constant that appears in formulas relating to circles, but it is also important in many other areas of mathematics. The actual value of  $\pi$  has been studied and approximated by ancient and more modern civilisations over thousands of years. The Egyptians knew  $\pi$  was slightly more than 3 and approximated it to be  $\frac{256}{81} \approx 3.16$ . The Babylonians used  $\frac{25}{8} = 3.125$  and the ancient Indians used  $\frac{339}{108} \approx 3.139$ .

It is believed that Archimedes of Syracuse (287–212 BCE) was the first person to use a mathematical technique to evaluate  $\pi$ .

He was able to prove that  $\pi$  was greater than  $\frac{223}{71}$  and less

than  $\frac{22}{7}$ . In 480 AD, the Chinese mathematician Zu Chongzhi showed that  $\pi$  was close to  $\frac{355}{113} \approx 3.1415929$ , which is accurate to seven decimal places.

Before the use of calculators, the fraction  $\frac{22}{7}$  was commonly used as a good and simple approximation to  $\pi$ . Interestingly, mathematicians have been able to prove that  $\pi$  is an irrational number, which means that there is no fraction that can be found that is exactly equal to  $\pi$ . If the exact value of  $\pi$  was written down as a decimal, the decimal places would continue on forever with no repeated pattern.



Engineers applied circle geometry when designing the Singapore Flyer, a Ferris wheel 150 m in diameter. Passengers have panoramic views when riding around this giant circle of circumference  $C = \pi \times 150 = 471$  m.

### Lesson starter: Discovering $\pi$

Here are the diameters and circumferences for three circles, correct to two decimal places. Use a calculator to work out the value of Circumference  $\div$  Diameter and put your results in the third column. Add your own circle measurements by measuring the diameter and circumference of circular objects such as a can.

Diameter $d$ (mm)	Circumference $C$ (mm)	$C \div d$
4.46	14.01	
11.88	37.32	
40.99	128.76	
Add your own	Add your own	

- What do you notice about the numbers  $C \div d$  in the third column?
- Why might the numbers in the third column vary slightly from one set of measurements to another?
- What rule can you write down which links  $C$  with  $d$ ?

## KEY IDEAS

## ■ Features of a circle

- **Diameter** ( $d$ ) is the distance across the centre of a circle.
- **Radius** ( $r$ ) is the distance from the centre to the circle. (Note:  $d = 2r$ .)

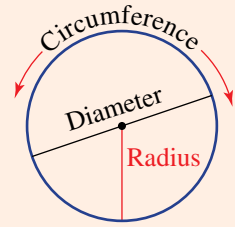
■ Circumference ( $C$ ) is the distance around a circle.

- $C = 2\pi r$  or  $C = \pi d$

- $r = \frac{C}{2\pi}$  or  $d = \frac{C}{\pi}$

■ Pi ( $\pi$ )  $\approx$  3.14159 (correct to five decimal places)

- Common approximations include 3.14 and  $\frac{22}{7}$ .
- A more precise estimate for  $\pi$  can be found on most calculators or on the internet.
- For a circle,  $\pi = \frac{C}{2r}$  or  $\pi = \frac{C}{d}$ .

## BUILDING UNDERSTANDING

1 Evaluate the following using a calculator and round to two decimal places.

a  $\pi \times 5$

b  $\pi \times 13$

c  $2 \times \pi \times 3$

d  $2 \times \pi \times 37$

2 State the value of  $\pi$  correct to:

a one decimal place

b two decimal places

c three decimal places.

3 Name the features of the circle as shown.

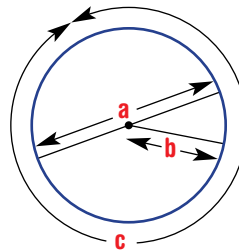

4 A circle has circumference ( $C$ ) 81.7 m and diameter ( $d$ ) 26.0 m, correct to one decimal place. Calculate  $C \div d$ . What do you notice?

## Example 4 Finding the circumference with a calculator

Find the circumference of these circles, correct to two decimal places. Use a calculator for the value of  $\pi$ .

a

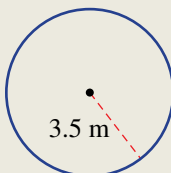

b

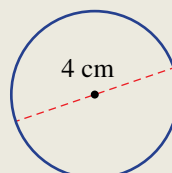

*Continued on next page*

**SOLUTION**

$$\begin{aligned} \text{a } C &= 2\pi r \\ &= 2 \times \pi \times 3.5 \\ &= 7\pi \\ &= 21.99 \text{ m (to 2 d.p.)} \end{aligned}$$

$$\begin{aligned} \text{b } C &= \pi d \\ &= \pi \times 4 \\ &= 4\pi \\ &= 12.57 \text{ cm (to 2 d.p.)} \end{aligned}$$

**EXPLANATION**

Since  $r$  is given, you can use  $C = 2\pi r$ .  
Alternatively, use  $C = \pi d$  with  $d = 7$ .  
Round off as instructed.

Substitute into the rule  $C = \pi d$  or use  
 $C = 2\pi r$  with  $r = 2$ .  
Round off as instructed.

**Now you try**

Find the circumference of these circles, correct to two decimal places. Use a calculator for the value of  $\pi$ .

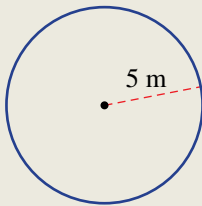
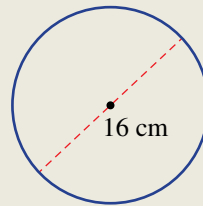
**a****b****Example 5 Finding circumference without a calculator**

Calculate the circumference of these circles using the given approximation of  $\pi$ .

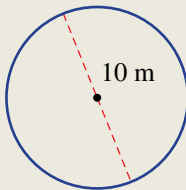
**a**

$$\pi = 3.14$$

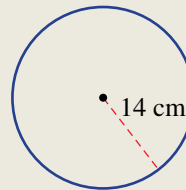
**b**

$$\pi = \frac{22}{7}$$

**SOLUTION**

$$\begin{aligned} \text{a } C &= \pi d \\ &= 3.14 \times 10 \\ &= 31.4 \text{ m} \end{aligned}$$

$$\begin{aligned} \text{b } C &= 2\pi r \\ &= 2 \times \frac{22}{7} \times 14 \\ &= 88 \text{ cm} \end{aligned}$$

**EXPLANATION**

Use  $\pi = 3.14$  and multiply mentally. Move the decimal point one place to the right.  
Alternatively, use  $C = 2\pi r$  with  $r = 5$ .

Use  $\pi = \frac{22}{7}$  and cancel the 14 with the 7 before calculating the final answer.  
 $2 \times \frac{22}{7} \times 14 = 2 \times 22 \times 2$



**Now you try**

Calculate the circumference of these circles using the given approximation of  $\pi$ .

**a**

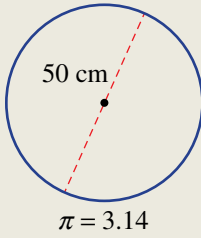

**b**

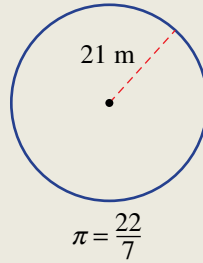

**Exercise 4B**

**FLUENCY**

1, 2–3(1/2)

2–4(1/2)

2–4(1/2)

**Example 4** 1 Find the circumference of these circles, correct to two decimal places. Use a calculator for the value of  $\pi$ .



**a**

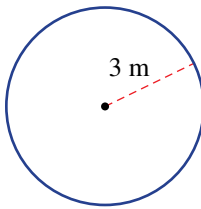

**b**

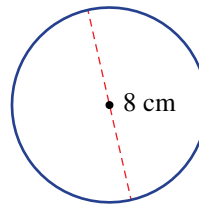

**Example 4** 2 Find the circumference of these circles, correct to two decimal places. Use a calculator for the value of  $\pi$ .



**a**

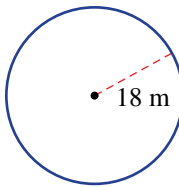

**b**

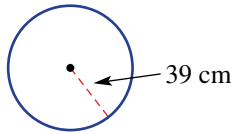

**c**

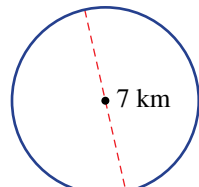

**d**

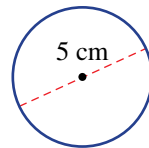

**Example 5** 3 Calculate the circumference of these circles using the given approximation of  $\pi$ .

**a**

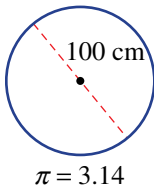

**b**

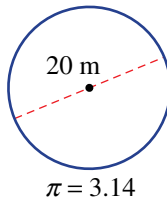

**c**

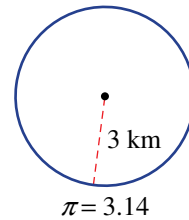

**d**

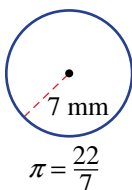

**e**

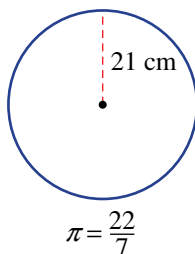

**f**

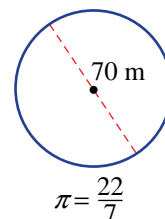

- 4 Using  $r = \frac{C}{2\pi}$  or  $d = \frac{C}{\pi}$ , find the following correct to one decimal place.
- a the diameter of a circle with circumference 20 cm
  - b the diameter of a circle with circumference 150 m
  - c the radius of a circle with circumference 43.8 mm
  - d the radius of a circle with circumference 2010 km

**PROBLEM-SOLVING** 5-7    6-9    8-10

- 5 A water tank has a diameter of 3.5 m. Find its circumference correct to one decimal place.
- 6 An athlete trains on a circular track of radius 40 m and jogs 10 laps each day, 5 days a week. How far does he jog each week? Round the answer to the nearest whole number of metres.
- 7 These shapes are semicircles. Find the perimeter of these shapes including the straight edge and round the answer to two decimal places.

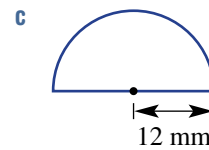
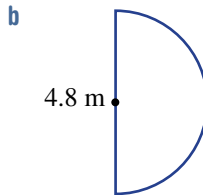
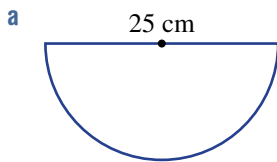

- 8 Calculate the perimeter of these diagrams, correct to two decimal places.

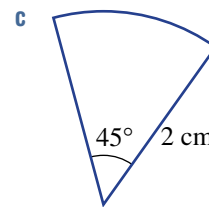
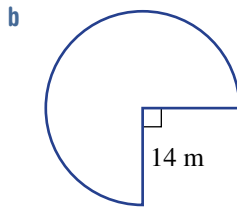
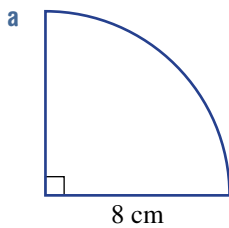

- 9 Calculate the perimeter of these shapes, correct to two decimal places.

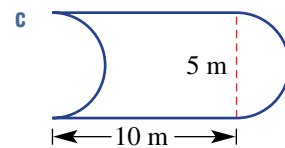
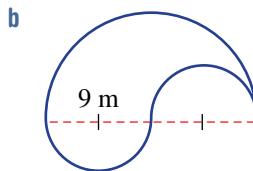
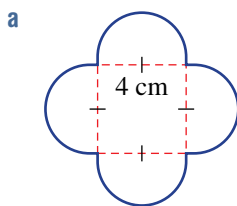

- 10 Here are some students' approximate circle measurements. Which students are likely to have incorrect measurements? (*Hint: Consider the rule linking radius and circumference.*)



	<i>r</i>	<i>C</i>
Mick	4 cm	25.1 cm
Svenya	3.5 m	44 m
Andre	1.1 m	13.8 m

## REASONING

11

11, 12

13–15

-  **11** Draw an accurate number line showing the integers 0, 1, 2, 3 and 4.
- Label the points 3.14,  $\frac{22}{7}$  and  $\pi$  at their locations on the line.
  - Sort the numbers 3.14,  $\frac{22}{7}$ ,  $\pi$  in ascending order.
  - When finding the circumference of a circle with a known diameter, you could use 3.14 or  $\frac{22}{7}$  as an approximate value for  $\pi$ . Which of these values will give you an approximate value that is bigger than the true circumference? Explain your answer.
- 12** Explain why the rule  $C = 2\pi r$  is equivalent to (i.e. the same as)  $C = \pi d$ .
- 13** It is more precise in mathematics to give 'exact' values for circle calculations in terms of  $\pi$ , e.g.  $C = 2 \times \pi \times 3$  gives  $C = 6\pi$ . This gives the final exact answer and is not written as a rounded decimal. Find the exact answers for Question 2 in terms of  $\pi$ .
- 14** Find the exact answers for Question 9 in terms of  $\pi$ .
-  **15** We know that  $C = 2\pi r$  or  $C = \pi d$ .
- Rearrange these rules to write a rule for:
    - $r$  in terms of  $C$
    - $d$  in terms of  $C$ .
  - Use the rules you found in part a to find the following, correct to two decimal places.
    - the radius of a circle with circumference 14 m
    - the diameter of a circle with circumference 20 cm

ENRICHMENT: Memorising  $\pi$ 

–

–

16, 17

- 16** The box shows  $\pi$  correct to 100 decimal places. The world record for the most number of digits of  $\pi$  recited from memory is held by Akira Haraguchi, a retired Japanese engineer. He recited 111 700 digits on Pi day in 2015.

3.14159 26535 89793 23846 26433 83279 50288 41971 69399 37510 58209 74944 59230 78164 06286 20899 86280 34825 34211 70679
--

Challenge your friends to see who can remember the most number of digits in the decimal representation of  $\pi$ .

Number of digits memorised	Report
10+	A good show
20+	Great effort
35+	Superb
50+	Amazing memory
100 000	World record

- 17** Investigate the ways  $\pi$  has been approximated historically and in different cultures.

## 4C Area CONSOLIDATING

### LEARNING INTENTIONS

- To understand what the area of a two-dimensional shape is
- To be able to convert between different metric units of area, including hectares
- To be able to find the area of squares, rectangles, parallelograms and triangles
- To understand that the area of composite shapes can be found by adding or subtracting the area of more basic shapes

Area is a measure of surface and is often referred to as the amount of space contained inside a two-dimensional space. Area is measured in square units, and the common metric units are square millimetres ( $\text{mm}^2$ ), square centimetres ( $\text{cm}^2$ ), square metres ( $\text{m}^2$ ), square kilometres ( $\text{km}^2$ ) and hectares (ha). The hectare is often used to describe area of land, since the square kilometre for such areas is considered to be too large a unit and the square metre too small. A school football oval might be about 1 hectare, for example, and a small forest might be about 100 hectares.



When architects and engineers design luxury cruise ships, they calculate many composite floor areas, including for the shopping mall, restaurants, cinemas, pools and gym.

### Lesson starter: Squares of squares

Consider this enlarged drawing of one square centimetre divided into square millimetres.

- How many square millimetres are there on one edge of the square centimetre?
- How many square millimetres are there in total in 1 square centimetre?
- What would you do to convert between  $\text{mm}^2$  and  $\text{cm}^2$  or  $\text{cm}^2$  and  $\text{mm}^2$  and why?
- Can you describe how you could calculate the number of square centimetres in one square metre and how many square metres in one square kilometre? What diagrams would you use to explain your answer?

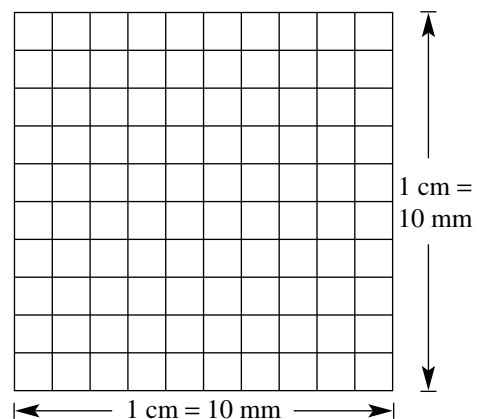

## KEY IDEAS

■ The common metric units for area include:

- square millimetres ( $\text{mm}^2$ )
- square centimetres ( $\text{cm}^2$ )
- square metres ( $\text{m}^2$ )
- square kilometres ( $\text{km}^2$ )
- hectares (ha).

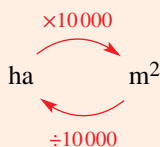
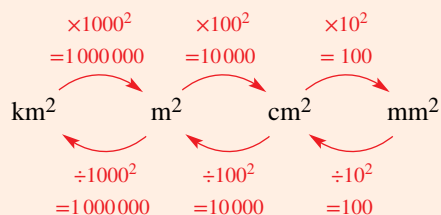

■ Area of squares, rectangles, parallelograms and triangles

- Square  $A = l \times l = l^2$
- Rectangle  $A = l \times w = lw$

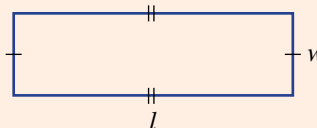
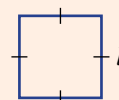

- Parallelogram  $A = b \times h = bh$   
The dashed line which gives the height is **perpendicular** (at right angles) to the base.

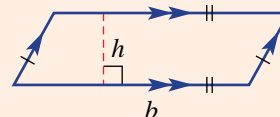

- Triangle  $A = \frac{1}{2} \times b \times h = \frac{1}{2}bh$   
Note that every triangle is half of a parallelogram, which is why this formula works.

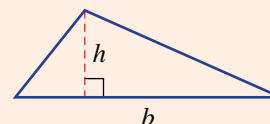

- Areas of **composite shapes** can be found by adding or subtracting the area of more basic shapes.



### BUILDING UNDERSTANDING

1 By considering the given diagrams, answer the questions.

- a i How many  $\text{mm}^2$  in  $1 \text{ cm}^2$ ?
- ii How many  $\text{mm}^2$  in  $4 \text{ cm}^2$ ?
- iii How many  $\text{cm}^2$  in  $300 \text{ mm}^2$ ?

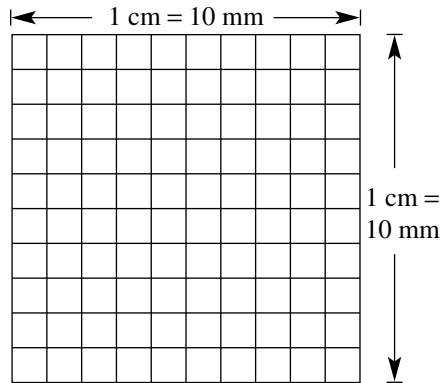

- b i How many  $\text{cm}^2$  in  $1 \text{ m}^2$ ?
- ii How many  $\text{cm}^2$  in  $7 \text{ m}^2$ ?
- iii How many  $\text{m}^2$  in  $40\,000 \text{ cm}^2$ ?

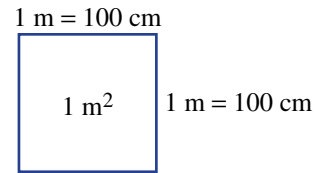

- c i How many  $\text{m}^2$  in  $1 \text{ km}^2$ ?
- ii How many  $\text{m}^2$  in  $5 \text{ km}^2$ ?
- iii How many  $\text{km}^2$  in  $2\,500\,000 \text{ m}^2$ ?

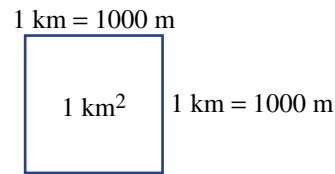

- d i How many  $\text{m}^2$  in  $1 \text{ ha}$ ?
- ii How many  $\text{m}^2$  in  $3 \text{ ha}$ ?
- iii How many  $\text{ha}$  in  $75\,000 \text{ m}^2$ ?

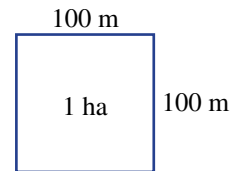

2 Which length measurements would be used for the *base* and the *height* (in that order) to find the area of these triangles?

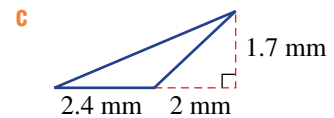
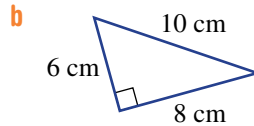
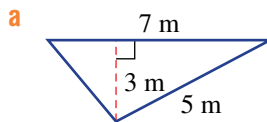

3 How many square metres is one hectare?

**Example 6 Converting units of area**

Convert these area measurements to the units shown in the brackets.

**a**  $0.248 \text{ m}^2 (\text{cm}^2)$

**b**  $3100 \text{ mm}^2 (\text{cm}^2)$

**SOLUTION**

**a**  $0.248 \text{ m}^2 = 0.248 \times 10000 \text{ cm}^2$   
 $= 2480 \text{ cm}^2$

**EXPLANATION**

$1 \text{ m}^2 = 100^2 \text{ cm}^2$   
 $= 10000 \text{ cm}^2$

$\text{m}^2 \xrightarrow{\times 100^2} \text{cm}^2$

Multiply since you are changing to a smaller unit.

**b**  $3100 \text{ mm}^2 = 3100 \div 100 \text{ cm}^2$   
 $= 31 \text{ cm}^2$

$1 \text{ cm}^2 = 10^2 \text{ mm}^2$   
 $= 100 \text{ mm}^2$

$\text{cm}^2 \xleftarrow{\div 10^2} \text{mm}^2$

Divide since you are changing to a larger unit.

**Now you try**

Convert these area measurements to the units shown in the brackets.

**a**  $3.51 \text{ m}^2 (\text{cm}^2)$

**b**  $150 \text{ mm}^2 (\text{cm}^2)$

**Example 7 Finding areas of basic shapes**

Find the area of these basic shapes.

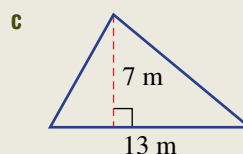
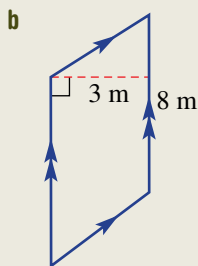
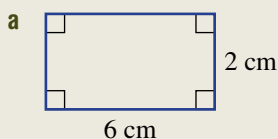
**SOLUTION**

**a**  $A = lw$   
 $= 6 \times 2$   
 $= 12 \text{ cm}^2$

**EXPLANATION**Write the formula for the area of a rectangle and substitute  $l = 6$  and  $w = 2$ .

**b**  $A = bh$   
 $= 8 \times 3$   
 $= 24 \text{ m}^2$

The height is measured at right angles to the base.

*Continued on next page*

$$\begin{aligned}
 \text{c } A &= \frac{1}{2}bh \\
 &= \frac{1}{2} \times 13 \times 7 \\
 &= 45.5 \text{ m}^2
 \end{aligned}$$

Remember that the height is measured using a line that is perpendicular to the base.

### Now you try

Find the area of these basic shapes.

a

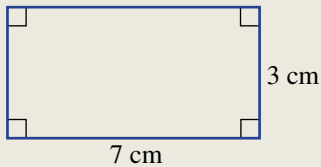

b

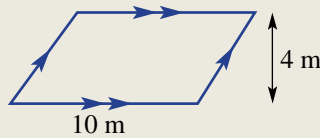

c

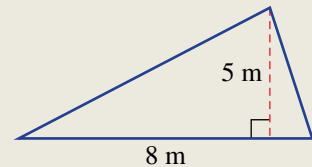

### Example 8 Finding areas of composite shapes

Find the area of these composite shapes using addition or subtraction.

a

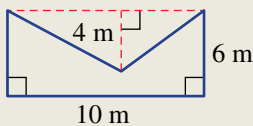

b

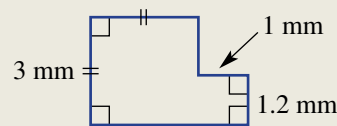

#### SOLUTION

$$\begin{aligned}
 \text{a } A &= lw - \frac{1}{2}bh \\
 &= 10 \times 6 - \frac{1}{2} \times 10 \times 4 \\
 &= 60 - 20 \\
 &= 40 \text{ m}^2
 \end{aligned}$$

#### EXPLANATION

The calculation is done by subtracting the area of a triangle from the area of a rectangle.

Rectangle – triangle

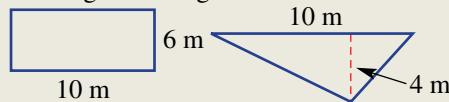



$$\begin{aligned}
 \text{b } A &= l^2 + lw \\
 &= 3^2 + 1.2 \times 1 \\
 &= 9 + 1.2 \\
 &= 10.2 \text{ mm}^2
 \end{aligned}$$

The calculation is done by adding the area of a rectangle to the area of a square.

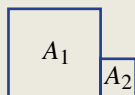

$$\text{Area} = A_1 + A_2$$

### Now you try

Find the area of these composite shapes using addition or subtraction.

a

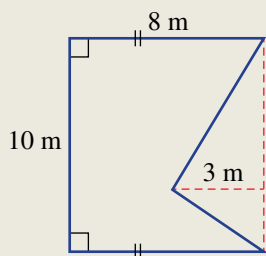

b

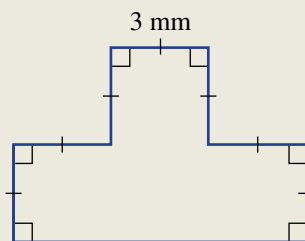

## Exercise 4C

### FLUENCY

1, 2-4(1/2)

2-4(1/2)

2-4(1/3)

Example 6a

1 Convert these area measurements to the units shown in the brackets.

- $2 \text{ m}^2$  ( $\text{cm}^2$ )
- $5 \text{ cm}^2$  ( $\text{mm}^2$ )
- $400 \text{ mm}^2$  ( $\text{cm}^2$ )
- $30000 \text{ cm}^2$  ( $\text{m}^2$ )
- $4 \text{ km}^2$  ( $\text{m}^2$ )
- $8000000 \text{ m}^2$  ( $\text{km}^2$ )

Example 6

2 Convert these area measurements to the units shown in the brackets.

- |  |  |  |
|--|--|--|
| a $2 \text{ cm}^2$ ( $\text{mm}^2$ )     | b $7 \text{ m}^2$ ( $\text{cm}^2$ )      | c $0.5 \text{ km}^2$ ( $\text{m}^2$ )    |
| d $3 \text{ ha}$ ( $\text{m}^2$ )        | e $0.34 \text{ cm}^2$ ( $\text{mm}^2$ )  | f $700 \text{ cm}^2$ ( $\text{m}^2$ )    |
| g $3090 \text{ mm}^2$ ( $\text{cm}^2$ )  | h $0.004 \text{ km}^2$ ( $\text{m}^2$ )  | i $2000 \text{ cm}^2$ ( $\text{m}^2$ )   |
| j $450000 \text{ m}^2$ ( $\text{km}^2$ ) | k $4000 \text{ m}^2$ ( $\text{ha}$ )     | l $3210 \text{ mm}^2$ ( $\text{cm}^2$ )  |
| m $320000 \text{ m}^2$ ( $\text{ha}$ )   | n $0.0051 \text{ m}^2$ ( $\text{cm}^2$ ) | o $0.043 \text{ cm}^2$ ( $\text{mm}^2$ ) |
| p $4802 \text{ cm}^2$ ( $\text{m}^2$ )   | q $19040 \text{ m}^2$ ( $\text{ha}$ )    | r $2933 \text{ m}^2$ ( $\text{ha}$ )     |

**Example 7** 3 Find the areas of these basic shapes.

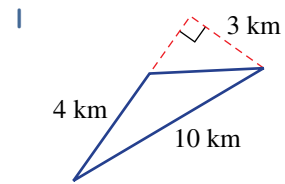
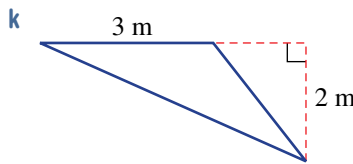
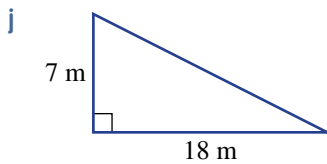
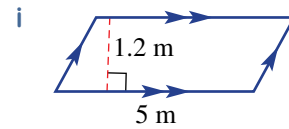
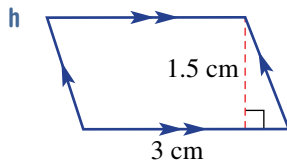
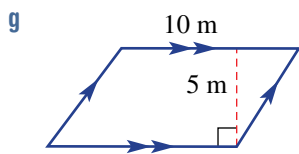
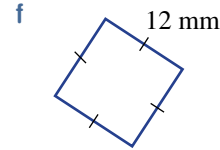
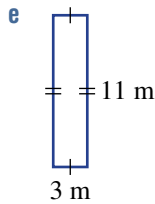
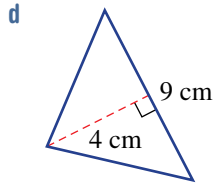
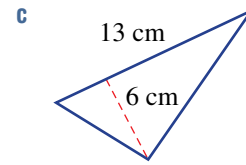
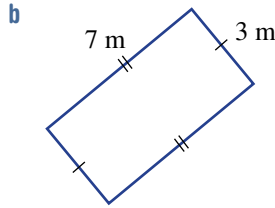
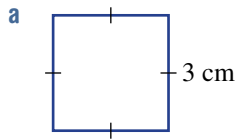

**Example 8** 4 Find the area of these composite shapes by using addition or subtraction.

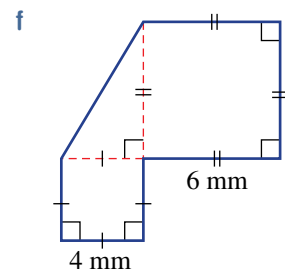
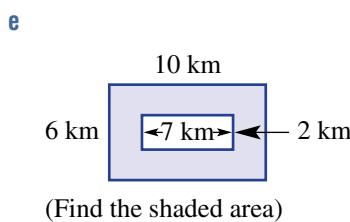
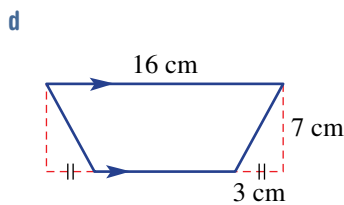
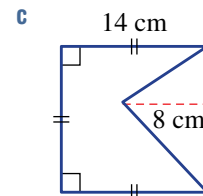
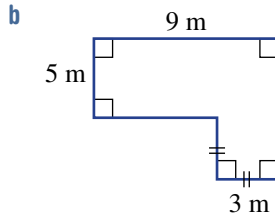
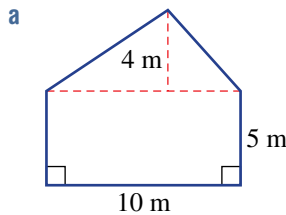

**PROBLEM-SOLVING**

5, 6

5-9

5, 6, 8-11

5 Choose the most suitable unit of measurement ( $\text{cm}^2$ ,  $\text{m}^2$  or  $\text{km}^2$ ) for the following areas.

- a the area of carpet required in a room
- b the area of glass on a phone screen
- c the area of land within one suburb of Australia
- d the area of someone's backyard
- e the area of a dinner plate

- 6 Find the area of these composite shapes. You may need to determine some side lengths first. Assume that angles that look right-angled are  $90^\circ$ .

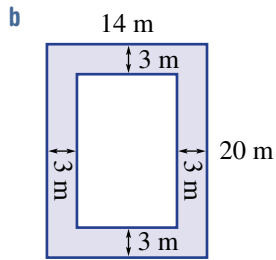
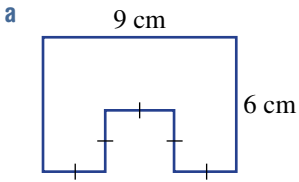

(Find the shaded area)

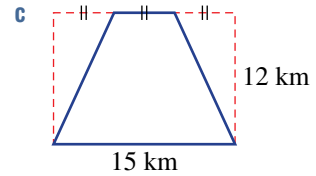

- 7 Find the side length of a square if its area is:
- a**  $36 \text{ m}^2$                                   **b**  $2.25 \text{ cm}^2$ .

- 8 **a** Find the area of a square if its perimeter is 20 m.  
**b** Find the perimeter of a square if its area is  $169 \text{ m}^2$ .

- 9 **a** Estimate the area of the following irregular shapes using the grid provided.

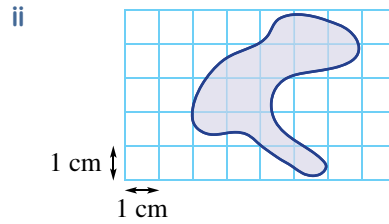
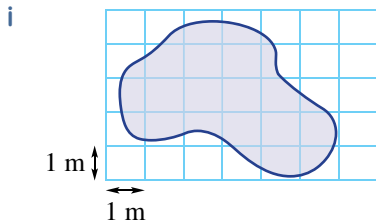

- b** Explain how the accuracy of your answer would change if the grids above used more squares with a smaller area (e.g. using  $\text{cm}^2$  for **(i)** or  $\text{mm}^2$  for **(ii)**).

- 10 **a** A triangle has area  $20 \text{ cm}^2$  and base 4 cm. Find its height.  
**b** A parallelogram has an area of  $26 \text{ m}^2$  and its base length is 13 m. What is its perpendicular height? Draw a diagram to illustrate.

- 11 Paint costs \$12 per litre and can only be purchased in a full number of litres. One litre of paint covers an area of  $10 \text{ m}^2$ . A rectangular wall is 6.5 m long and 3 m high and needs two coats of paint. What will be the cost of paint for the wall?

**REASONING**                                  12                                  12–14                                  13–15

- 12 Explain how the area of land occupied by an irregularly shaped lake could be estimated using a map or scale diagram. Describe how you could improve any estimate, assuming you can zoom in or out on the map.
- 13 Write down expressions for the area of these shapes in simplest form using the letters  $a$  and  $b$  (e.g.  $A = 2ab + a^2$ ).

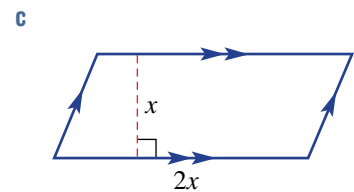
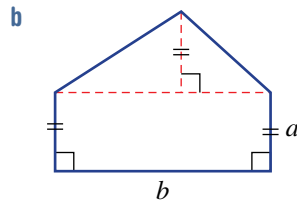
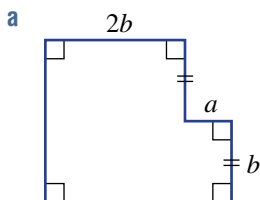

-  **14** An inaccurate measurement can make a big difference when seeking the answer in an area calculation. A square room could be measured as having side length 4 metres, then remeasured in centimetres as 396 cm, then finally measured in millimetres as 3957 mm.
- Find the three areas based on each measurement.
  - Calculate the difference in  $\text{mm}^2$  between the largest and smallest area.
- 15** Write down rules for:
- the width of a rectangle ( $w$ ) with area  $A$  and length  $l$
  - the side length of a square ( $l$ ) with area  $A$
  - the height of a triangle ( $h$ ) with area  $A$  and base  $b$ .

**ENRICHMENT: The acre**

16

-  **16** Two of the more important imperial units of length and area that are still used today are the mile and the acre. Many of our country and city roads, farms and house blocks were divided up using these units.

Here are some conversions.

$$1 \text{ square mile} = 640 \text{ acres}$$

$$1 \text{ mile} \approx 1.609344 \text{ km}$$

$$1 \text{ hectare} = 10\,000 \text{ m}^2$$

- Use the given conversions to find:
  - the number of square kilometres in 1 square mile (round to two decimal places)
  - the number of square metres in 1 square mile (round to the nearest whole number)
  - the number of hectares in 1 square mile (round to the nearest whole number)
  - the number of square metres in 1 acre (round to the nearest whole number)
  - the number of hectares in 1 acre (round to one decimal place)
  - the number of acres in 1 hectare (round to one decimal place).
- A dairy farmer has 200 acres of land. How many hectares is this? (Round your answer to the nearest whole number.)
- A house block is  $2500 \text{ m}^2$ . What fraction of an acre is this? (Give your answer as a percentage rounded to the nearest whole number.)



## 4D Area of special quadrilaterals

### LEARNING INTENTIONS

- To understand that the formulas for the area of special quadrilaterals can be developed from the formulas for the area of rectangles and triangles
- To be able to find the area of rhombuses, kites and trapeziums

The formulas for the area of a rectangle and a triangle can be used to develop formulas for the area of other special quadrilaterals. These quadrilaterals include the parallelogram, the rhombus, the kite and the trapezium. Knowing the formulas for the area of these shapes can save a lot of time dividing shapes into rectangles and triangles.

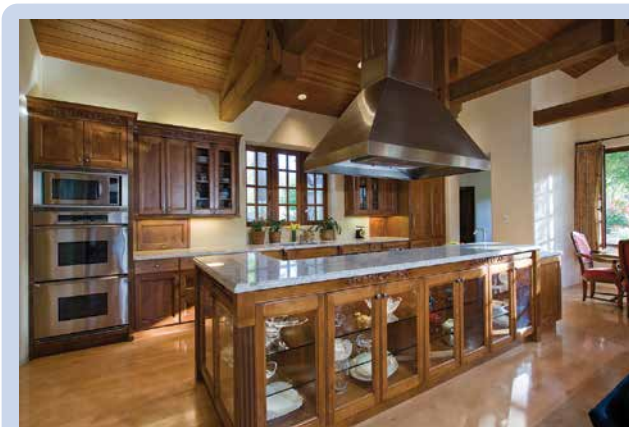

Sheet metal workers use triangle, quadrilateral and polygon area formulas, such as when constructing stove extraction ducts with trapezium shaped sides.

### Lesson starter: Developing formulas

These diagrams contain clues as to how you might find the area of the shape using only what you know about rectangles and triangles. Can you explain what each diagram is trying to tell you?

- Rhombus

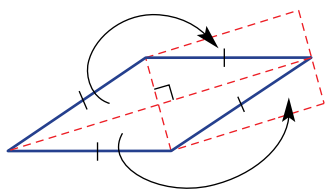

- Kite

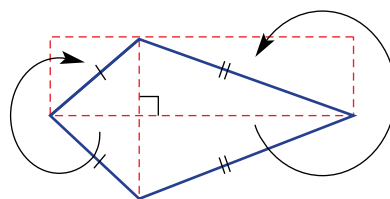

- Trapezium

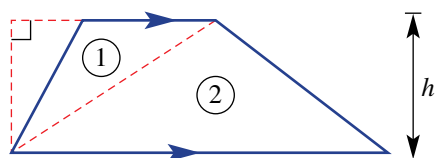

## KEY IDEAS

■ Area of a **rhombus** or **kite**

$$\text{Area} = \frac{1}{2} \times \text{diagonal } x \times \text{diagonal } y$$

$$\text{or } A = \frac{1}{2}xy$$

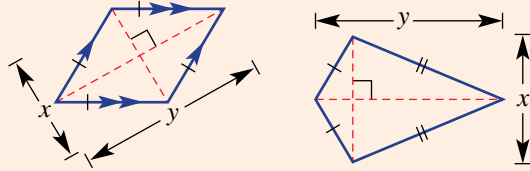
■ Area of a **trapezium**

$$\text{Area} = \frac{1}{2} \times \text{sum of parallel sides} \times \text{perpendicular height}$$

$$\text{or } A = \frac{1}{2}(a + b)h$$

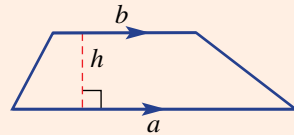

This is the same as finding the average of the parallel lengths and multiplying by the perpendicular height.

## BUILDING UNDERSTANDING

1 Find the value of  $A$  using these formulas and given values.

a  $A = \frac{1}{2}xy$  ( $x = 5$ ,  $y = 12$ )

b  $A = \frac{1}{2}(a + b)h$  ( $a = 2$ ,  $b = 7$ ,  $h = 3$ )

2 State the missing term to complete these sentences.

a A perpendicular angle is \_\_\_\_\_ degrees.

b The two diagonals in a kite or a rhombus are \_\_\_\_\_.

c To find the area of a trapezium you multiply  $\frac{1}{2}$  by the sum of the two \_\_\_\_\_ sides and then by the \_\_\_\_\_ height.

d The two special quadrilaterals that have the same area formula using diagonal lengths  $x$  and  $y$  are the \_\_\_\_\_ and the \_\_\_\_\_.



## Example 9 Finding areas of special quadrilaterals

Find the area of these special quadrilaterals.

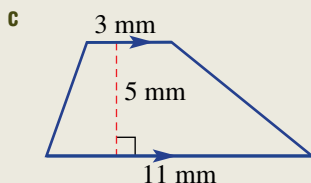
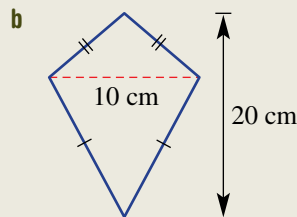
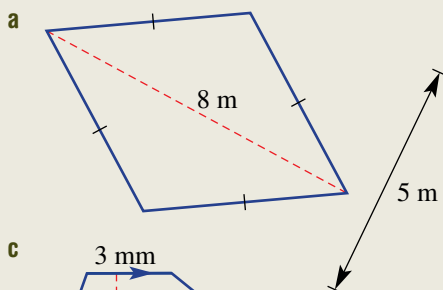

**SOLUTION**

$$\begin{aligned} \text{a } A &= \frac{1}{2}xy \\ &= \frac{1}{2} \times 8 \times 5 \\ &= 20 \text{ m}^2 \end{aligned}$$

$$\begin{aligned} \text{b } A &= \frac{1}{2}xy \\ &= \frac{1}{2} \times 10 \times 20 \\ &= 100 \text{ cm}^2 \end{aligned}$$

$$\begin{aligned} \text{c } A &= \frac{1}{2}(a + b)h \\ &= \frac{1}{2} \times (11 + 3) \times 5 \\ &= \frac{1}{2} \times 14 \times 5 \\ &= 35 \text{ mm}^2 \end{aligned}$$

**EXPLANATION**

Use the formula  $A = \frac{1}{2}xy$ , since both diagonals are given.

Use the formula  $A = \frac{1}{2}xy$ , since both diagonals are given.

The two parallel sides are 11 mm and 3 mm in length. The perpendicular height is 5 mm.

**Now you try**

Find the area of these special quadrilaterals.

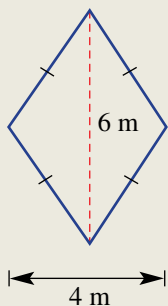
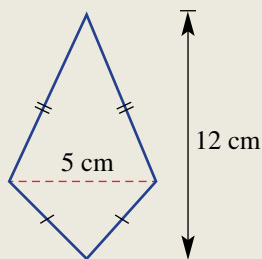
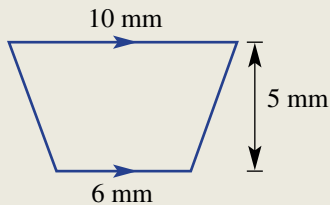
**a****b****c**

## Exercise 4D

### FLUENCY

1, 2(1/2), 3

2(1/2), 3

2-3(1/3)

Example 9a

1 Find the area of each rhombus.

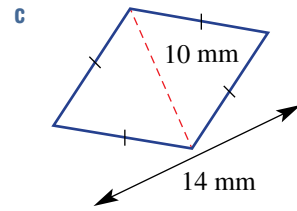
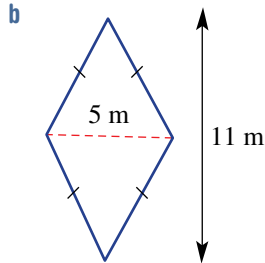
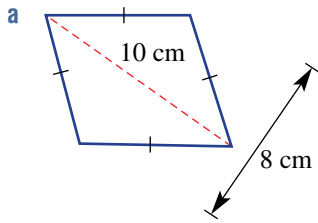

Example 9

2 Find the area of these special quadrilaterals. First state the name of the shape.

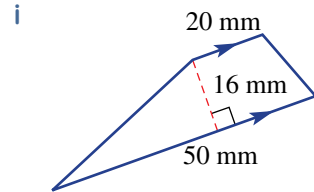
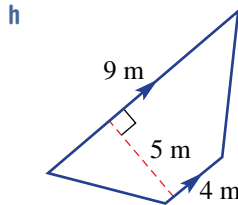
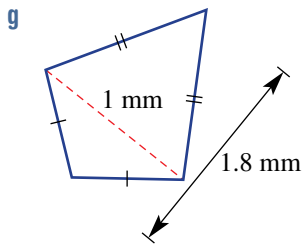
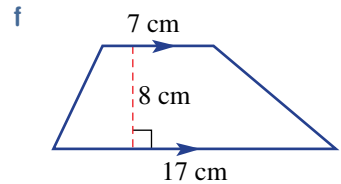
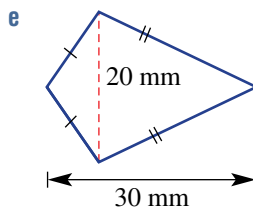
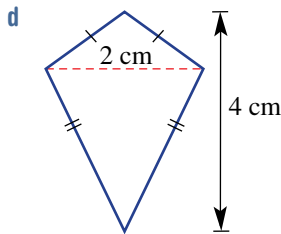
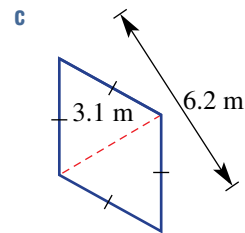
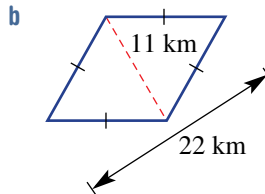
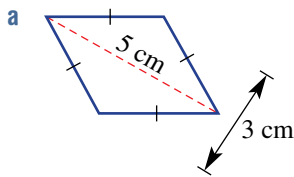

3 These trapeziums have one side at right angles to the two parallel sides. Find the area of each.

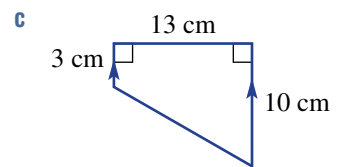
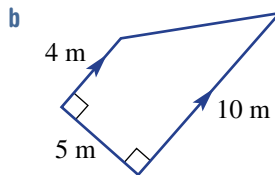
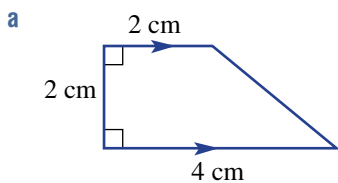



**PROBLEM-SOLVING** 4, 5 4-6 5-7

- 4 A flying kite is made from four centre rods all connected near the middle of the kite as shown. What area of plastic, in square metres, is needed to cover the kite?

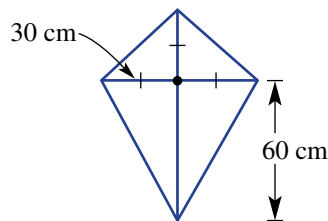

- 5 Find the area of these composite shapes.

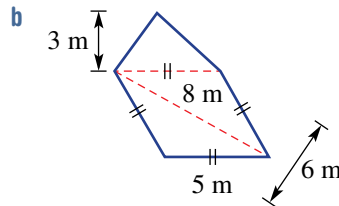
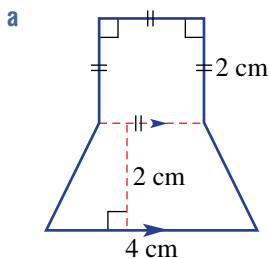

- 6 A landscape gardener charges \$20 per square metre of lawn. A lawn area is in the shape of a rhombus and its diagonals are 8 m and 14.5 m. What would be the cost of laying this lawn?
- 7 The parallel sides of a trapezium are 2 cm apart and one of the sides is 3 times the length of the other. If the area of the trapezium is  $12 \text{ cm}^2$ , what are the lengths of the parallel sides?

**REASONING** 8 8, 9 9-11

- 8 Consider this trapezium.

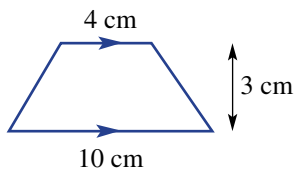

- a Draw the largest rectangle that fits inside the trapezium, and find the rectangle's area.
- b Draw the smallest rectangle that the trapezium fits inside, and find the rectangle's area.
- c Compare the average of the two rectangular areas with the trapezium's area. What do you notice?
- 9 Consider this shape.

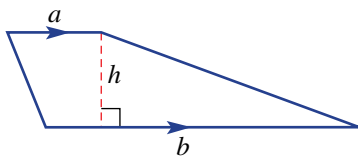

- a What type of shape is it?
- b Find its area if  $a = 5$ ,  $b = 8$ , and  $h = 3$ . All measurements are in cm.

10 Write an expression for the area of these shapes in simplest form (e.g.  $A = 2a + 3ab$ ).

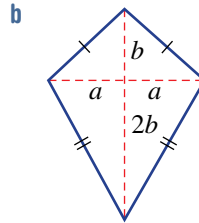
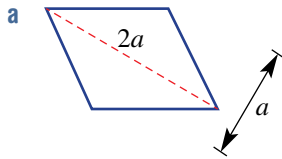

11 Would you use the formula  $A = \frac{1}{2}xy$  to find the area of this rhombus? Explain why or why not, then find the area.

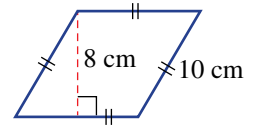

**ENRICHMENT: Proof** - - 12, 13

12 Complete these proofs to give the formula for the area of a rhombus and a trapezium.

a Rhombus

$$\begin{aligned} A &= 4 \text{ triangle areas} \\ &= 4 \times \frac{1}{2} \times \text{base} \times \text{height} \\ &= 4 \times \frac{1}{2} \times \underline{\hspace{2cm}} \times \underline{\hspace{2cm}} \\ &= \underline{\hspace{2cm}} \end{aligned}$$

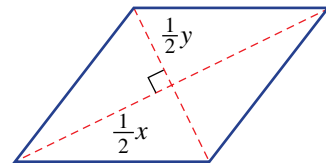

b Trapezium 1

$$\begin{aligned} A &= \text{Area}(\text{triangle 1}) + \text{Area}(\text{triangle 2}) \\ &= \frac{1}{2} \times \text{base}_1 \times \text{height}_1 + \frac{1}{2} \times \text{base}_2 \times \text{height}_2 \\ &= \frac{1}{2} \times \underline{\hspace{2cm}} \times \underline{\hspace{2cm}} + \frac{1}{2} \times \underline{\hspace{2cm}} \times \underline{\hspace{2cm}} \\ &= \underline{\hspace{2cm}} + \underline{\hspace{2cm}} \\ &= \underline{\hspace{2cm}} \end{aligned}$$

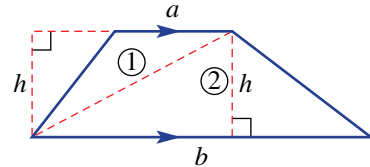

c Trapezium 2

$$\begin{aligned} A &= \text{Area}(\text{rectangle}) + \text{Area}(\text{triangle}) \\ &= \text{length} \times \text{width} + \frac{1}{2} \times \text{base} \times \text{height} \\ &= \underline{\hspace{2cm}} \times \underline{\hspace{2cm}} + \frac{1}{2} \times \underline{\hspace{2cm}} \times \underline{\hspace{2cm}} \\ &= \underline{\hspace{2cm}} + \underline{\hspace{2cm}} - \underline{\hspace{2cm}} \\ &= \underline{\hspace{2cm}} + \underline{\hspace{2cm}} \\ &= \underline{\hspace{2cm}} \end{aligned}$$

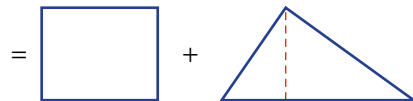
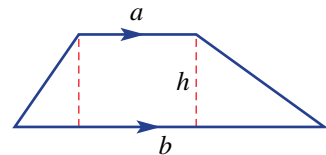

13 Design an A4 poster for one of the proofs in Question 12 to be displayed in your class.

# 4E Area of circles

### LEARNING INTENTIONS

- To be able to find the area of a circle given its radius or diameter using a calculator
- To be able to find the area of a circle given its radius or diameter using an approximation for  $\pi$
- To understand how to find the area of a semicircle or quadrant by multiplying a circle's area by  $\frac{1}{2}$  or  $\frac{1}{4}$

We know that the link between the perimeter of a circle and its radius has challenged civilisations for thousands of years. Similarly, people have studied the link between a circle's radius and its area.

Archimedes (287–212 BCE) attempted to calculate the exact area of a circle using a particular technique involving limits. If a circle is approximated by a regular hexagon, then the approximate area would be the sum of the areas of 6 triangles with base  $b$  and height  $h$ .

$$\text{So } A \approx 6 \times \frac{1}{2}bh$$

If the number of sides ( $n$ ) on the polygon increases, the approximation would improve. If  $n$  gets larger, the error in estimating the area of the circle gets smaller.

### Proof

$$\begin{aligned} A &= n \times \frac{1}{2}bh \\ &= \frac{1}{2} \times nb \times h \\ &= \frac{1}{2} \times 2\pi r \times r \quad (\text{As } n \text{ becomes very large, } nb \text{ becomes } 2\pi r \text{ as } nb \\ &= \pi r^2 \quad \text{is the perimeter of the polygon, and } h \text{ becomes } r.) \end{aligned}$$

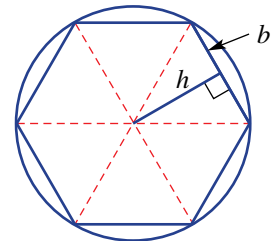

Hexagon ( $n = 6$ )

$$A = 6 \times \frac{1}{2}bh$$

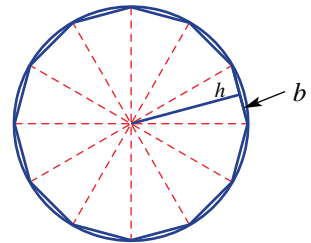

Dodecagon ( $n = 12$ )

$$A = 12 \times \frac{1}{2}bh$$

## Lesson starter: Area as a rectangle

Imagine a circle cut into small sectors and arranged as shown.

Now try to imagine how the arrangement on the right would change if the number of sector divisions was not 16 (as shown) but a much higher number.

- What would the shape on the right look like if the number of sector divisions was a very high number? What would the length and width relate to in the original circle?
- Try to complete this proof.

$$\begin{aligned} A &= \text{length} \times \text{width} \\ &= \frac{1}{2} \times \text{_____} \times r \\ &= \text{_____} \end{aligned}$$

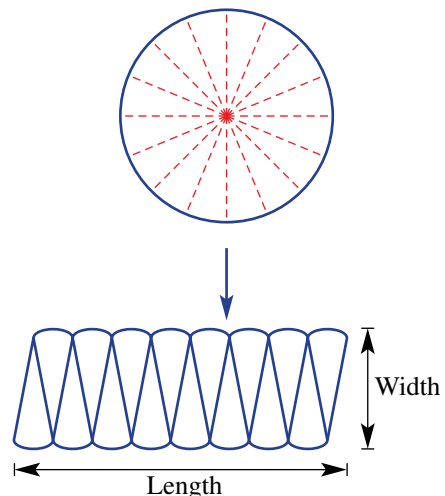

## KEY IDEAS

- The ratio of the area of a circle to the square of its radius is equal to  $\pi$ .

$$\frac{A}{r^2} = \pi, \text{ so } A = \pi r^2$$

$$\text{Rearranging, } r = \sqrt{\frac{A}{\pi}}$$

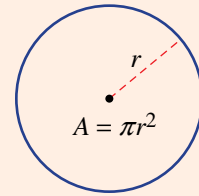

- A half circle is called a **semicircle**.

$$A = \frac{1}{2}\pi r^2$$

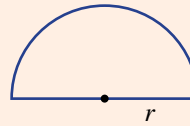

- A quarter circle is called a **quadrant**.

$$A = \frac{1}{4}\pi r^2$$

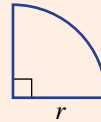

## BUILDING UNDERSTANDING

- 1 Evaluate without the use of a calculator.

a  $3.14 \times 10$

b  $3.14 \times 4$

c  $\frac{22}{7} \times 7$

d  $\frac{22}{7} \times 7^2$

- 2 Use a calculator to evaluate these to two decimal places.

a  $\pi \times 5^2$

b  $\pi \times 13^2$

c  $\pi \times 3.1^2$

d  $\pi \times 9.8^2$

- 3 What radius length ( $r$ ) would be used to help find the area of these shapes?

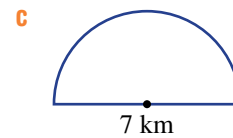
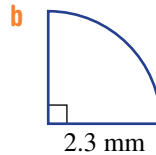
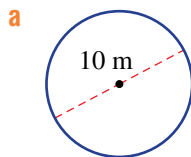

## Example 10 Finding circle areas using a calculator

Use a calculator to find the area of this circle, correct to two decimal places.

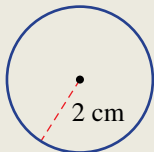

## SOLUTION

$$\begin{aligned} A &= \pi r^2 \\ &= \pi \times 2^2 \\ &= 12.57 \text{ cm}^2 \text{ (to 2 d.p.)} \end{aligned}$$

## EXPLANATION

Use the  $\pi$  button on the calculator and enter  $\pi \times 2^2$  or  $\pi \times 4$ .

**Now you try**

Use a calculator to find the area of this circle, correct to two decimal places.

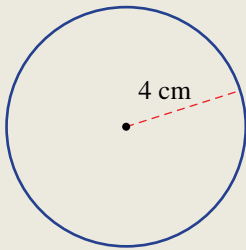
**Example 11 Finding circle areas without technology**

Find the area of these circles using the given approximate value of  $\pi$ .

**a**  $\pi = \frac{22}{7}$

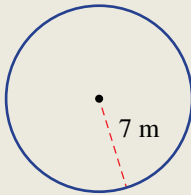

**b**  $\pi = 3.14$

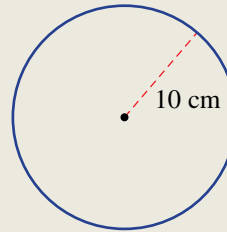
**SOLUTION**

$$\begin{aligned} \mathbf{a} \quad A &= \pi r^2 \\ &= \frac{22}{7} \times 7^2 \\ &= 154 \text{ m}^2 \end{aligned}$$

$$\begin{aligned} \mathbf{b} \quad A &= \pi r^2 \\ &= 3.14 \times 10^2 \\ &= 314 \text{ cm}^2 \end{aligned}$$

**EXPLANATION**

Always write the rule.

Use  $\pi = \frac{22}{7}$  and  $r = 7$ .

$$\frac{22}{7} \times 7 \times 7 = 22 \times 7$$

Use  $\pi = 3.14$  and substitute  $r = 10$ .

$3.14 \times 10^2$  is the same as  $3.14 \times 100$ .

**Now you try**

Find the area of these circles using the given approximate value of  $\pi$ .

**a**  $\pi = \frac{22}{7}$

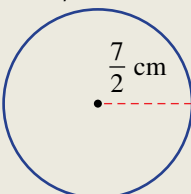

**b**  $\pi = 3.14$

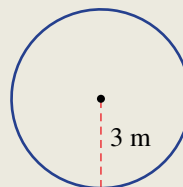



### Example 12 Finding areas of semicircles and quadrants

Find the area of this quadrant and semicircle, correct to two decimal places.

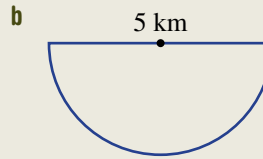
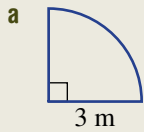

#### SOLUTION

$$\begin{aligned} \mathbf{a} \quad A &= \frac{1}{4} \times \pi r^2 \\ &= \frac{1}{4} \times \pi \times 3^2 \\ &= 7.07 \text{ m}^2 \text{ (to 2 d.p.)} \end{aligned}$$

$$\begin{aligned} \mathbf{b} \quad r &= \frac{5}{2} = 2.5 \\ A &= \frac{1}{2} \times \pi r^2 \\ &= \frac{1}{2} \times \pi \times 2.5^2 \\ &= 9.82 \text{ km}^2 \text{ (to 2 d.p.)} \end{aligned}$$

#### EXPLANATION

The area of a quadrant is  $\frac{1}{4}$  the area of a circle with the same radius.

A calculator can be used for the final evaluation.

The radius is half the diameter.

The area of a semicircle is  $\frac{1}{2}$  the area of a circle with the same radius.

A calculator can be used for the final evaluation.

#### Now you try

Find the area of this quadrant and semicircle, correct to two decimal places.

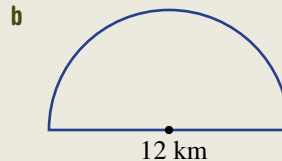
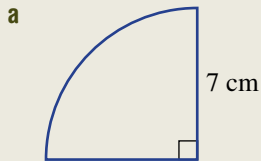

## Exercise 4E

### FLUENCY

1, 2–4( $\frac{1}{2}$ )2–4( $\frac{1}{3}$ ), 52–4( $\frac{1}{3}$ ), 5

Example 10

- 1 Use a calculator to find the area of this circle, correct to two decimal places.

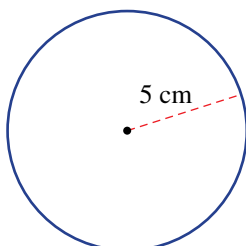

**Example 10** 2 Use a calculator to find the area of these circles, correct to two decimal places

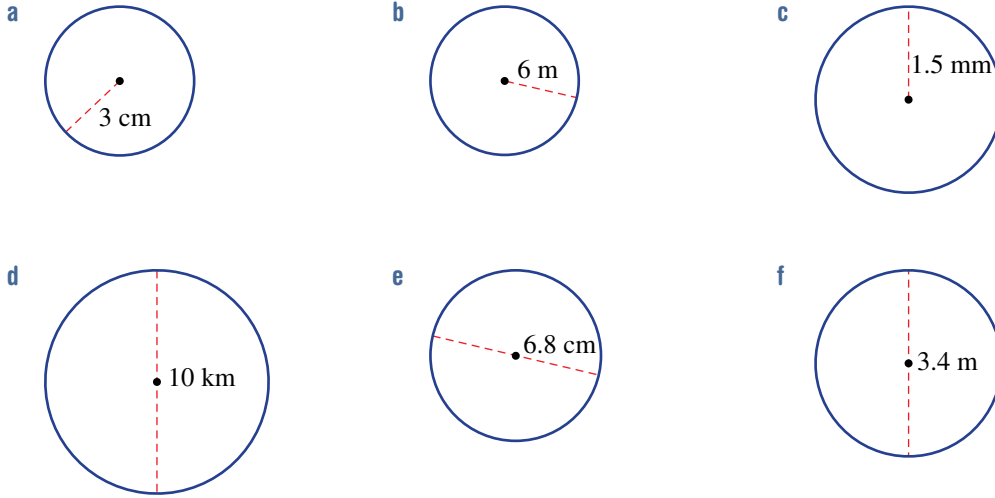

**Example 11** 3 Find the area of these circles, using the given approximate value of  $\pi$ .

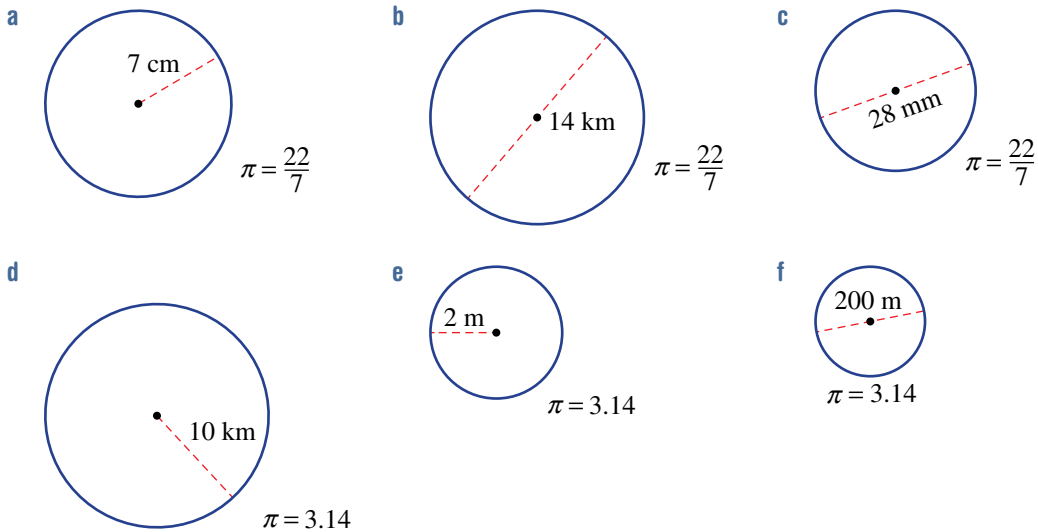

**Example 12** 4 Find the area of these quadrants and semicircles, correct to two decimal places.

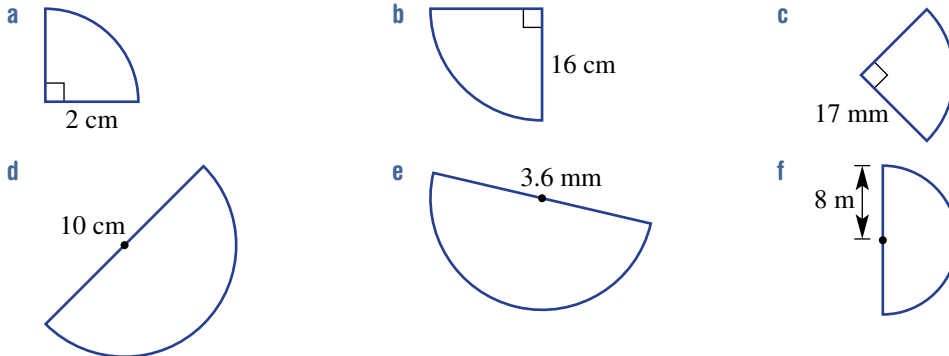

5 Using the formula  $r = \sqrt{\frac{A}{\pi}}$ , find the following correct to one decimal place.

- a the radius of a circle with area  $35 \text{ cm}^2$
- b the diameter of a circle with area  $7.9 \text{ m}^2$

## PROBLEM-SOLVING

6, 7

8–10

9–11

- 6 A pizza tray has a diameter of 30 cm. Calculate its area to the nearest whole number of  $\text{cm}^2$ .
- 7 A tree trunk is cut to reveal a circular cross-section of radius 60 cm. Is the area of the cross-section more than  $1 \text{ m}^2$  and, if so, by how much? Round your answer to the nearest whole number of  $\text{cm}^2$ .
- 8 A circular oil slick has a diameter of 1 km. The newspaper reported an area of more than  $1 \text{ km}^2$ . Is the newspaper correct?
- 9 Two circular plates have radii 12 cm and 13 cm. Find the difference in their area, correct to two decimal places.
- 10 Which has the largest area, a circle of radius 5 m, a semicircle of radius 7 m or a quadrant of radius 9 m?
- 11 A square of side length 10 cm has a hole in the middle. The diameter of the hole is 5 cm. What is the area remaining? Round the answer to the nearest whole number.

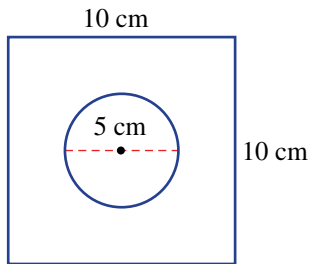

## REASONING

12

12, 13

13–15

- 12 In this question, you will be finding an upper bound and lower bound for  $\pi$ .
- a Use the diagram to explain why the area of a circle of radius  $r$  must be less than  $4r^2$ .
- b Use the diagram to explain why the area of a circle of radius  $r$  must be more than  $2r^2$ .
- c Is the true area of a circle greater than, less than or equal to the average of the two squares' areas?

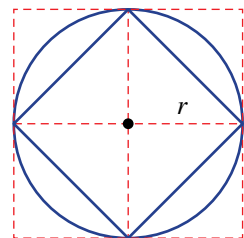
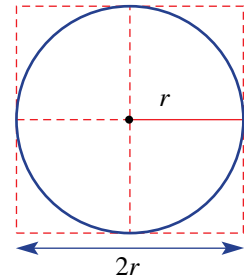

- 13 A circle has radius 2 cm.
- a Find the area of the circle using  $\pi = 3.14$ .
- b Find the area if the radius is doubled to 4 cm.
- c What is the effect on the area if the radius is doubled?
- d What is the effect on the area if the radius is tripled?
- e What is the effect on the area if the radius is quadrupled?
- f What is the effect on the area if the radius is multiplied by  $n$ ?



14 The area of a circle with radius 2 could be written exactly as  $A = \pi \times 2^2 = 4\pi$ . Write the exact area of these shapes.

a

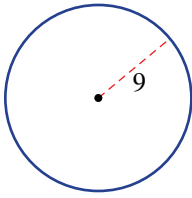

b

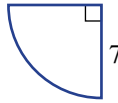

c

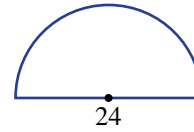

15 We know that the diameter  $d$  of a circle is twice the radius  $r$ , i.e.  $d = 2r$  or  $r = \frac{1}{2}d$ .

- a Substitute  $r = \frac{1}{2}d$  into the rule  $A = \pi r^2$  to find a rule for the area of a circle in terms of  $d$ .
- b Use your rule from part a to check that the area of a circle with diameter 10m is  $25\pi \text{ m}^2$ .

**ENRICHMENT: Reverse problems**

-

-

16

16 Reverse the rule  $A = \pi r^2$  to find the radius in these problems.

- a If  $A = 10$ , use your calculator to show that  $r \approx 1.78$ .
- b Find the radius of circles with these areas. Round the answer to two decimal places.
  - i  $17 \text{ m}^2$
  - ii  $4.5 \text{ km}^2$
  - iii  $320 \text{ mm}^2$
- c Can you write a rule for  $r$  in terms of  $A$ ? Check that it works for the circles defined in part b.

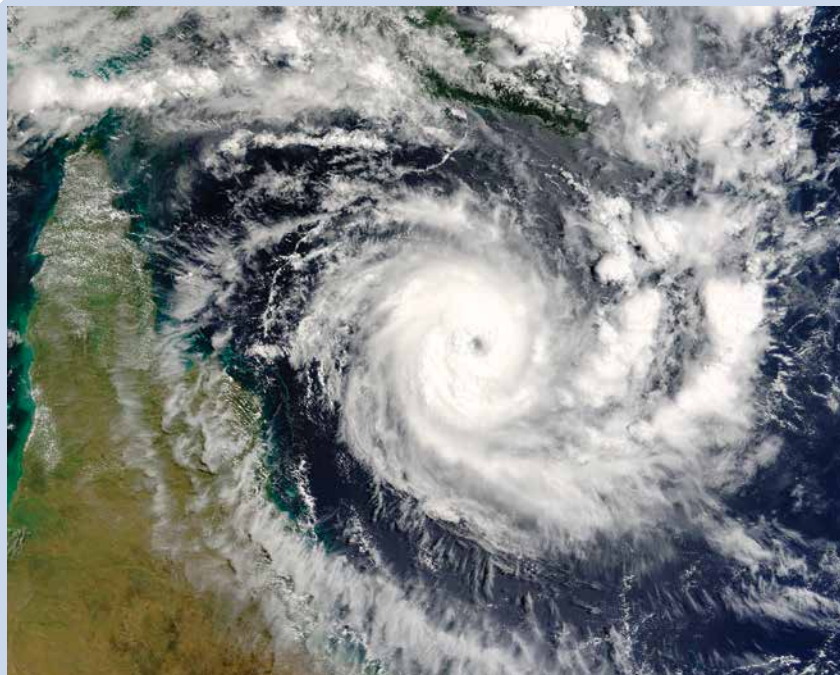

The BOM (Bureau of Meteorology) uses a circle to map a cyclone's most dangerous area. Ships' navigators divide this circle into the slightly safer and the unsafe semicircles. In Australia, the destructive, unsafe semicircle is always on the SE side.

## 4F Area of sectors and composite shapes EXTENDING

### LEARNING INTENTIONS

- To know what a sector is
- To understand that a sector's area can be found by taking a fraction of the area of a circle with the same radius
- To be able to find the area of a sector given its radius and the angle at the centre
- To be able to find the area of composite shapes involving sectors

A slice of pizza or a portion of a round cake cut from the centre forms a shape called a sector. The area cleaned by a windscreen wiper could also be thought of as a difference of two sectors with the same angle but different radii. Clearly the area of a sector depends on its radius, but it also depends on the angle between the two straight edges.

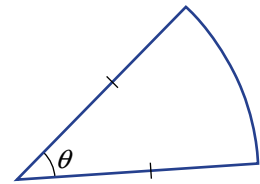

A computer hard drive disk stores data on concentric circular tracks that are divided into track sectors. Each track sector stores 512 bytes of data and its area is the difference in area between two geometric sectors.

### Lesson starter: The sector area formula

Complete this table to develop the rule for finding the area of a sector.

Angle	Fraction of area	Area rule	Diagram
$180^\circ$	$\frac{180}{360} = \frac{1}{2}$	$A = \frac{1}{2} \times \pi r^2$	
$90^\circ$	$\frac{90}{360} = \underline{\hspace{2cm}}$	$A = \underline{\hspace{1cm}} \times \pi r^2$	
$45^\circ$			
$30^\circ$			
$\theta$		$A = \underline{\hspace{1cm}} \times \pi r^2$	

### KEY IDEAS

- A **sector** is formed by dividing a circle with two radii.

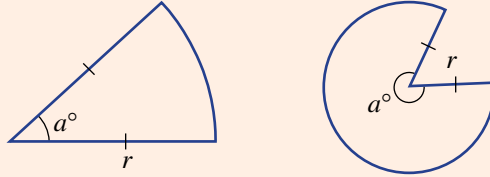

- A sector's area is determined by calculating a fraction of the area of a circle with the same radius.

- Fraction is  $\frac{a}{360}$
- Sector area =  $\frac{a}{360} \times \pi r^2$

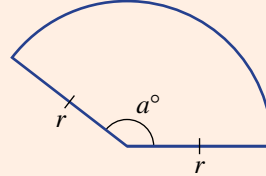

- The area of a **composite shape** can be found by adding or subtracting the areas of more basic shapes.



$$A = lw + \frac{1}{2}\pi r^2$$

### BUILDING UNDERSTANDING

- 1 Simplify these fractions.

a  $\frac{180}{360}$

b  $\frac{90}{360}$

c  $\frac{60}{360}$

d  $\frac{45}{360}$

- 2 Evaluate the following using a calculator. Give your answer correct to two decimal places.

a  $\frac{80}{360} \times \pi \times 2^2$

b  $\frac{20}{360} \times \pi \times 7^2$

c  $\frac{210}{360} \times \pi \times 2.3^2$

- 3 What fraction of a circle in simplest form is shown by these sectors?

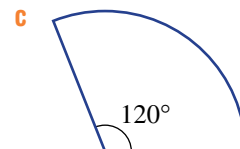
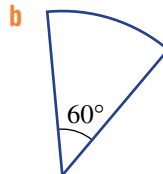
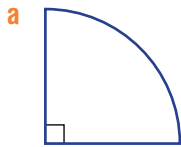



### Example 13 Finding areas of sectors

Find the area of these sectors correct to two decimal places.

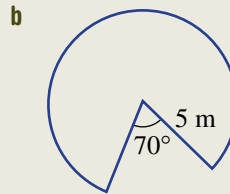
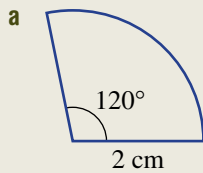

#### SOLUTION

$$\begin{aligned} \mathbf{a} \quad A &= \frac{\theta}{360} \times \pi r^2 \\ &= \frac{120}{360} \times \pi \times 2^2 \\ &= \frac{1}{3} \times \pi \times 4 \\ &= 4.19 \text{ cm}^2 \text{ (to 2 d.p.)} \end{aligned}$$

$$\begin{aligned} \mathbf{b} \quad \theta &= 360 - 70 = 290 \\ A &= \frac{\theta}{360} \times \pi r^2 \\ &= \frac{290}{360} \times \pi \times 5^2 \\ &= 63.27 \text{ m}^2 \text{ (to 2 d.p.)} \end{aligned}$$

#### EXPLANATION

First, write the formula for the area of a sector.

Substitute  $\theta = 120$  and  $r = 2$ .

Note that  $\frac{120}{360}$  simplifies to  $\frac{1}{3}$ .

First, calculate the angle inside the sector and remember that a revolution is  $360^\circ$ . Then substitute  $\theta = 290$  and  $r = 5$  into the formula for the area of a sector.

#### Now you try

Find the area of these sectors, correct to two decimal places.

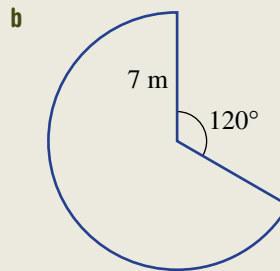
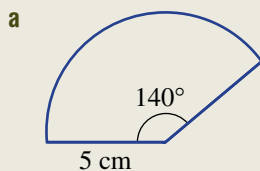

### Example 14 Finding areas of composite shapes

Find the area of this composite shape, correct to the nearest whole number of  $\text{mm}^2$ .

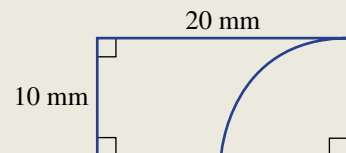

**SOLUTION**

$$\begin{aligned}
 A &= lw - \frac{1}{4}\pi r^2 \\
 &= 20 \times 10 - \frac{1}{4} \times \pi \times 10^2 \\
 &= 200 - 25\pi \\
 &= 121 \text{ mm}^2 \text{ (to nearest whole number)}
 \end{aligned}$$

**EXPLANATION**

The area can be found by subtracting the area of a quadrant from the area of a rectangle.

**Now you try**

Find the area of this composite shape, correct to two decimal places.

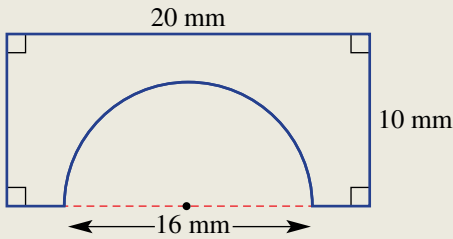

**Exercise 4F**

**FLUENCY**

1, 2(1/2), 4(1/2)

2(1/2), 3, 4(1/2)

2-4(1/3)

Example 13a

1 Find the area of these sectors, correct to one decimal place.

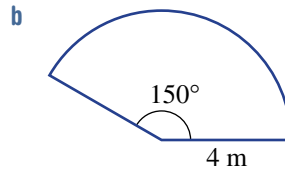
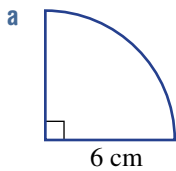

Example 13a

2 Find the area of these sectors, correct to two decimal places.

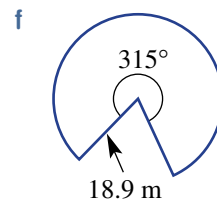
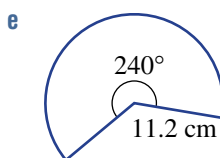
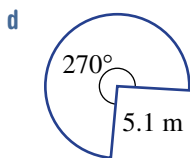
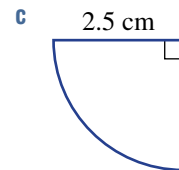
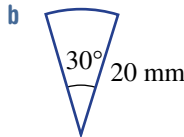
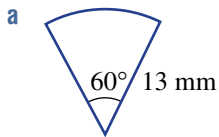

**Example 13b** 3 Find the area of these sectors, correct to two decimal places.

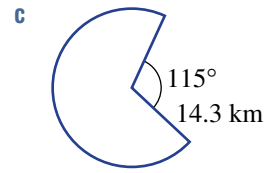
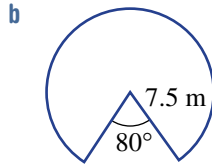
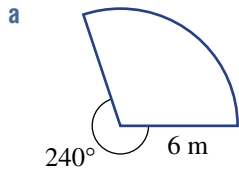

**Example 14** 4 Find the areas of these composite shapes using addition or subtraction. Round the answer to two decimal places.

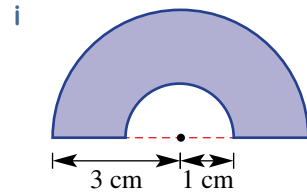
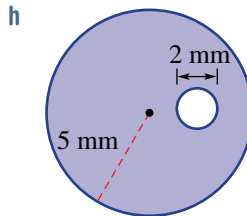
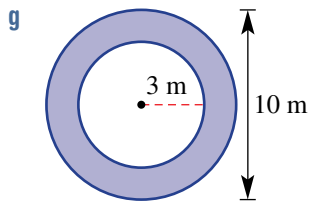
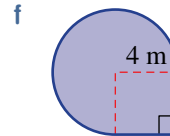
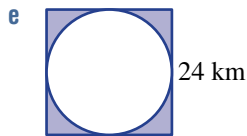
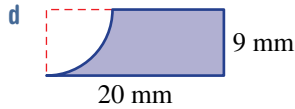
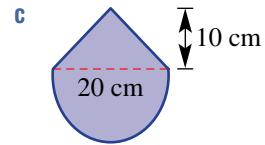
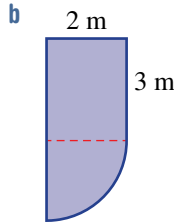
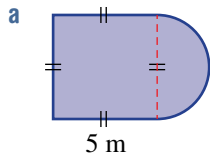

**PROBLEM-SOLVING**

5, 6

6, 7

6-8



5 A simple bus wiper blade wipes an area over  $100^\circ$  as shown. Find the area wiped by the blade, correct to two decimal places.

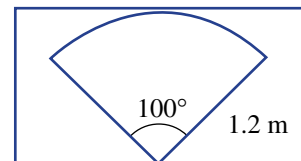

- 6 At Buy-by-the-sector Pizza they offer a sector of a 15 cm radius pizza with an angle of  $45^\circ$  or a sector of a 13 cm radius pizza with an angle of  $60^\circ$ . Which piece gives the bigger area and by how much? Round the answer to two decimal places.

- 7 An archway is made up of an inside and outside semicircle as shown. Find the area of the arch, correct to the nearest whole  $\text{cm}^2$ .

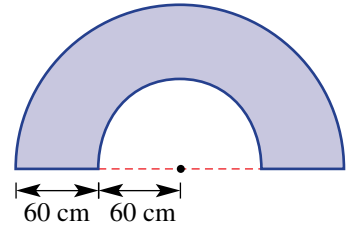

- 8 What percentage of the total area is occupied by the shaded region in these diagrams? Round the answer to one decimal place.

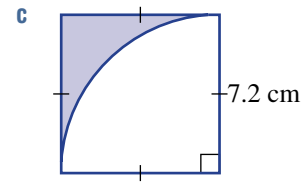
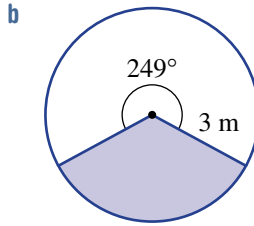
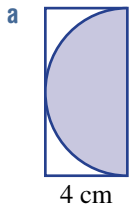

**REASONING**

9

9, 10(1/2)

10, 11

- 9 Consider the sector shown.

- a Use the dashed lines to explain why the sector's area is between  $50\text{ cm}^2$  and  $100\text{ cm}^2$ .  
 b The average of 50 and 100 is 75. How close is the sector's area to  $75\text{ cm}^2$ ? Answer correct to one decimal place.

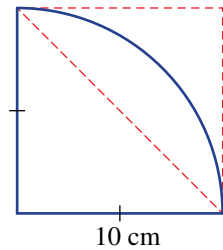

- 10 An exact area measure in terms of  $\pi$  might look like  $\pi \times 2^2 = 4\pi$ . Find the exact area of these shapes in terms of  $\pi$ . Simplify your answer.

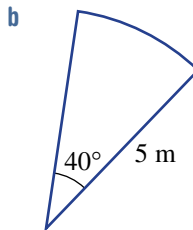
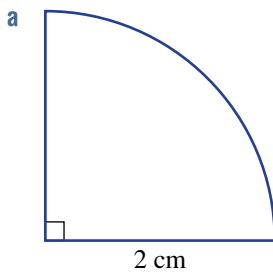

- c Find the shaded area.

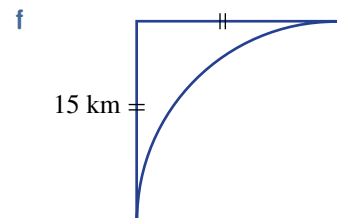
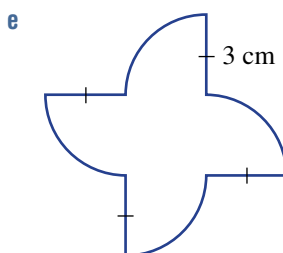
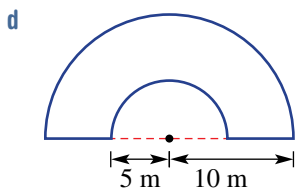
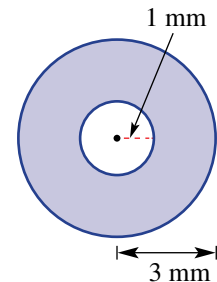



11 Consider the percentage of the area occupied by a circle inside a square and touching all sides as shown.

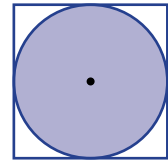

- If the radius of the circle is 4 cm, find the percentage of area occupied by the circle. Round the answer to one decimal place.
- Repeat part **a** for a radius of 10 cm. What do you notice?
- Can you prove that the percentage area is always the same for any radius  $r$ ? (*Hint*: Find the percentage area using the pronumeral  $r$  for the radius.)

**ENRICHMENT: Sprinkler waste**

12



12 A rectangular lawn area has a  $180^\circ$  sprinkler positioned in the middle of one side as shown.

- Find the area of the sector  $OAB$ , correct to two decimal places.
- Find the area watered by the sprinkler outside the lawn area correct to two decimal places.
- Find the percentage of water wasted, giving the answer correct to one decimal place.

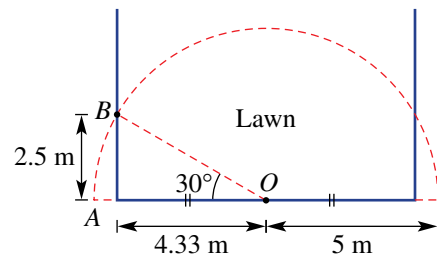



## 4G Surface area of prisms EXTENDING

### LEARNING INTENTIONS

- To know the meaning of the terms prism, net and total surface area (TSA)
- To be able to find the total surface area of a prism

Many problems in three dimensions can be solved by looking at the problem or parts of the problem in two dimensions. Finding the surface area of a solid is a good example of this, as each face can usually be redrawn in two-dimensional space. The surface area of the walls of an unpainted house, for example, could be calculated by looking at each wall separately and adding to get a total surface area.



CubeSats, designed by space engineers for scientific research, are miniaturised satellites made of one or more cubes with 10 cm sides. Their surface area is used for solar power panels.

### Lesson starter: Possible prisms

Here are three nets that fold to form three different prisms.

- Can you draw and name the prisms?
- Try drawing other nets of these prisms that are a different shape from the nets given here.

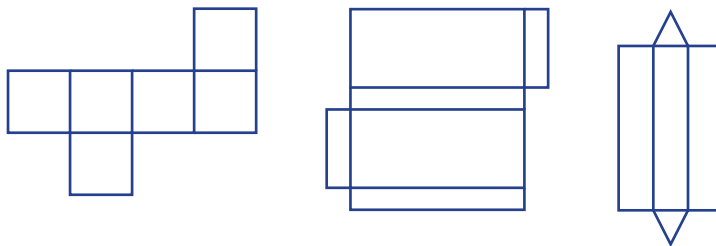

### KEY IDEAS

- A **prism** is a polyhedron with a constant (uniform) **cross-section**.
  - The cross-section is parallel to the two identical (congruent) ends.
  - The other sides are parallelograms (or rectangles for right prisms).

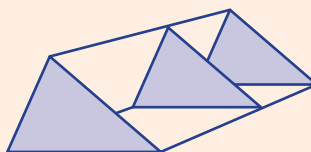

■ A **net** is a two-dimensional representation of all the surfaces of a solid. It can be folded to form the solid.

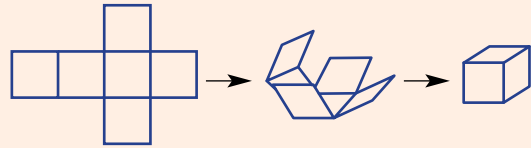

■ The **surface area** of a prism is the sum of the areas of all its faces.

Cube

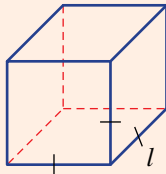

$$A = 6l^2$$

Rectangular prism

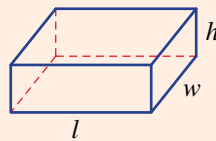

$$A = 2lw + 2lh + 2wh$$

### BUILDING UNDERSTANDING

1 How many faces are there on these right prisms? Also name the types of shapes that make the different faces.

a

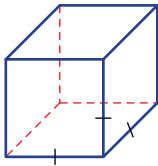

b

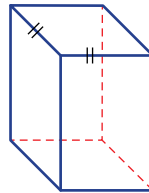

c

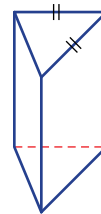

2 Match the net to its solid.

a

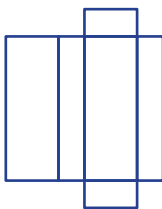

b

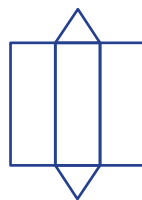

c

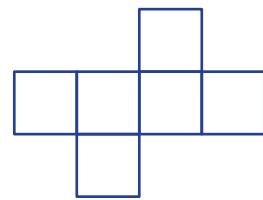

A

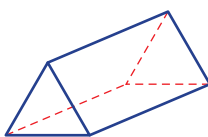

B

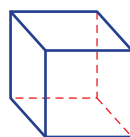

C

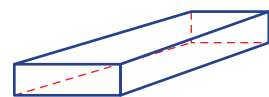

3 How many rectangular faces are on these solids?

a triangular prism

b rectangular prism

c hexagonal prism

d pentagonal prism

Pentagonal prism

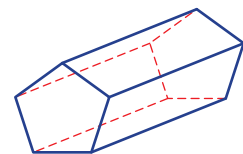



### Example 15 Finding surface areas of prisms

Find the surface area of these prisms.

**a**

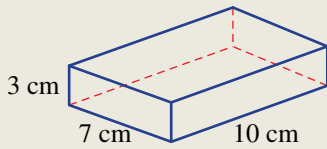

**b**

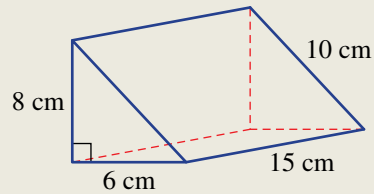

#### SOLUTION

$$\begin{aligned} \mathbf{a} \quad A_{\text{top}} &= A_{\text{base}} = 7 \times 10 \\ &= 70 \text{ cm}^2 \\ A_{\text{front}} &= A_{\text{back}} = 3 \times 10 \\ &= 30 \text{ cm}^2 \\ A_{\text{left}} &= A_{\text{right}} = 3 \times 7 \\ &= 21 \text{ cm}^2 \end{aligned}$$

Surface area

$$\begin{aligned} A &= 2 \times 70 + 2 \times 30 + 2 \times 21 \\ &= 242 \text{ cm}^2 \end{aligned}$$

**b** Area of 2 triangular ends

$$\begin{aligned} A &= 2 \times \frac{1}{2} \times bh \\ &= 2 \times \frac{1}{2} \times 6 \times 8 \\ &= 48 \text{ cm}^2 \end{aligned}$$

Area of 3 rectangles

$$\begin{aligned} A &= (6 \times 15) + (8 \times 15) + (10 \times 15) \\ &= 360 \text{ cm}^2 \end{aligned}$$

Surface area

$$\begin{aligned} A &= 48 + 360 \\ &= 408 \text{ cm}^2 \end{aligned}$$

#### EXPLANATION

Top and base of prism are both rectangles with length 10 cm and width 7 cm.

Front and back faces are both rectangles with length 10 cm and width 3 cm.

Left and right faces are both rectangles with length 7 cm and width 3 cm.

Total surface area is found by adding the area of all six faces.

One possible net is

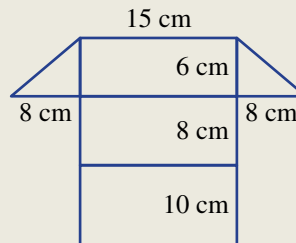

Work out the area of each shape or group of shapes and find the sum of their areas to obtain the total surface area.

#### Now you try

Find the surface area of these prisms.

**a**

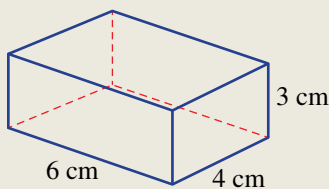

**b**

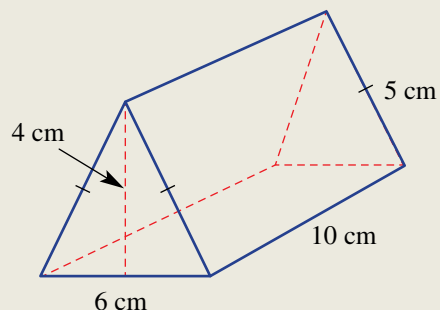

## Exercise 4G

### FLUENCY

1, 2, 3( $\frac{1}{2}$ )

1, 3( $\frac{1}{2}$ ), 4

2, 3( $\frac{1}{3}$ ), 4

Example 15a

- 1 Find the surface area of this prism.

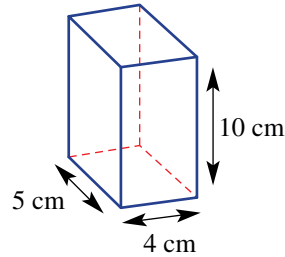

Example 15b

- 2 Find the surface area of this prism.

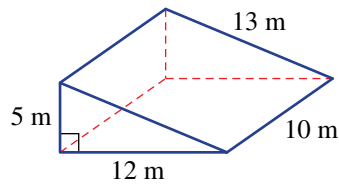

Example 15

- 3 Find the surface area of these right prisms.

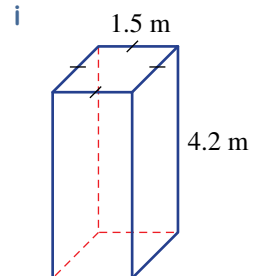
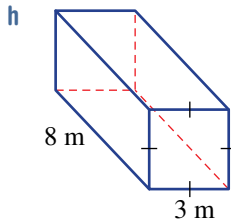
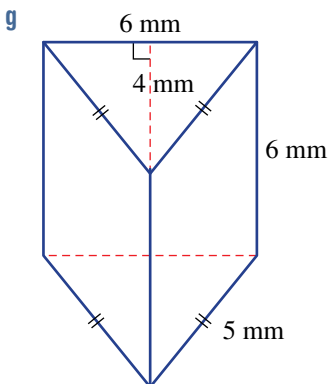
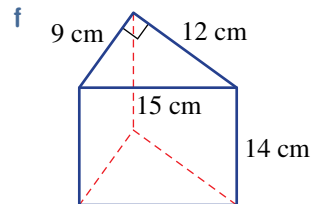
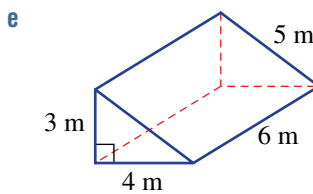
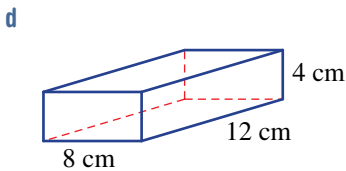
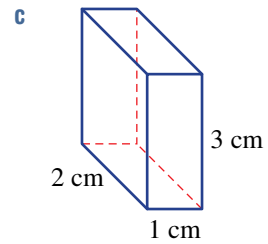
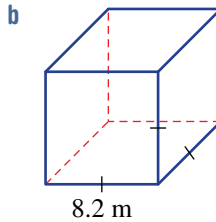
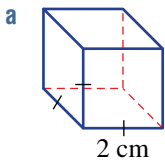

- 4 This prism has two end faces that are parallelograms.  
 a Use  $A = bh$  to find the combined area of the two ends.  
 b Find the surface area of the prism.

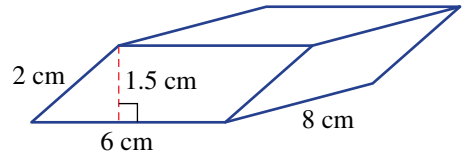

**PROBLEM-SOLVING** 5, 6      5-7      6-8

- 5 An open box (with no lid) is in the shape of a cube and is painted on the outside including the base. What surface area is painted if the side length of the box is 20 cm?
- 6 A book 20 cm long, 15 cm wide and 3 cm thick is wrapped in plastic.  
 a Find the surface area of this book.  
 b Find the total area of plastic required to wrap 1000 books like this. Answer in  $m^2$ .

- 7 Find the surface area of these solids.

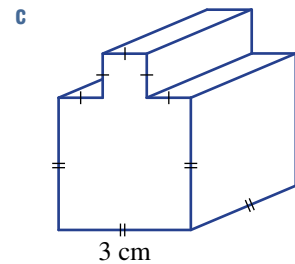
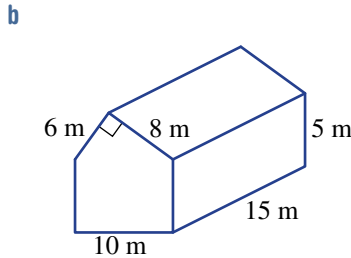
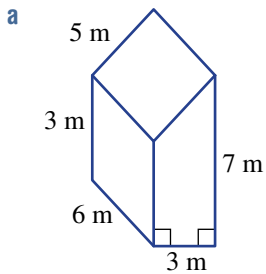

- 8 The floor, sides and roof of this tent are made from canvas at a cost of \$5 per square metre. The tent's dimensions are shown in the diagram. What is the cost of the canvas for the tent?

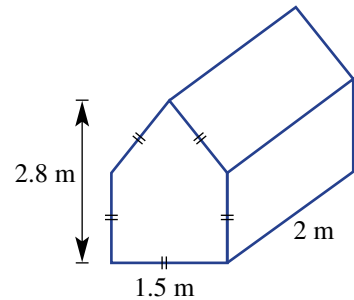

## REASONING

9

9, 10

9–11



9 Write down a rule for the surface area for these right prisms in simplest form.

a

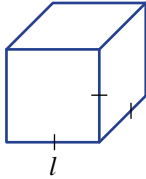

b

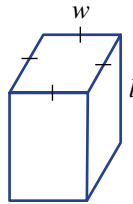

c

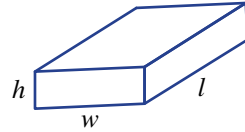

10 Prove that the surface area of a rectangular prism will always be an even number of metres<sup>2</sup>, if the length, width and height are a whole number of metres.

11 A cube of side length 1 cm has a surface area of 6 cm<sup>2</sup>.

a What is the effect on the surface area of the cube if:

- its side length is doubled?
- its side length is tripled?
- its side length is quadrupled?



b Do you notice a pattern from your answers to part a? What effect would multiplying the side length by a factor of  $n$  have on the surface area?

## ENRICHMENT: The thick wooden box

–

–

12

12 An open box (with no lid) in the shape of a cube is made of wood that is 2 cm thick. Its outside side length is 40 cm.

- Find its total surface area both inside and out.
- If the box was made with wood that is 1 cm thick, what would be the change in surface area?

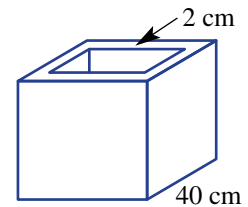

4A

1 Convert:

- a 6.4 m into mm
- c 97 000 cm into km

- b 180 cm into m
- d  $2\frac{1}{2}$  m into cm.

4A

2 Find the perimeter of these shapes.

a

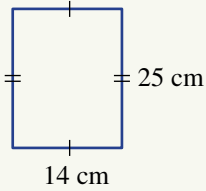

b

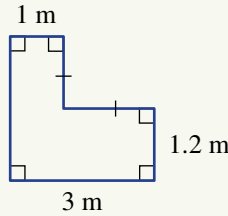

c

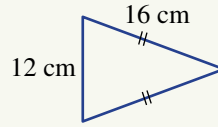

d

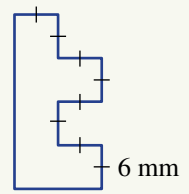

4A

3 If the perimeter of a triangle is 24 cm, find the value of  $x$ .

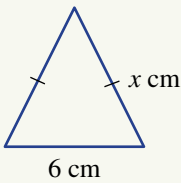

4B

4 Find the circumference and area of these circles, correct to two decimal places.



a

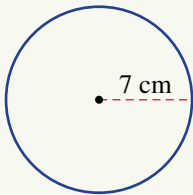

b

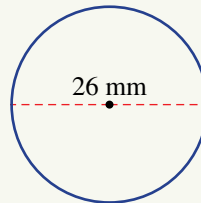

4E

5 Find the area of the circles in Question 4, correct to two decimal places.



4C

6 Convert these area measurements to the units shown in brackets.

- a  $4.7 \text{ m}^2$  ( $\text{cm}^2$ )
- b  $4100 \text{ mm}^2$  ( $\text{cm}^2$ )
- c  $5000 \text{ m}^2$  (ha)
- d  $0.008 \text{ km}^2$  ( $\text{m}^2$ )

4C/D

7 Find the area of these shapes.



a

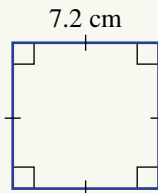

b

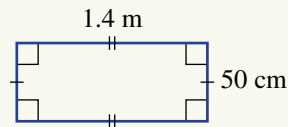

c

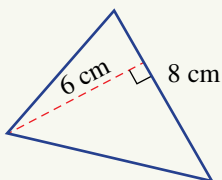

d

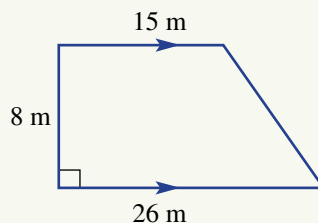

Progress quiz

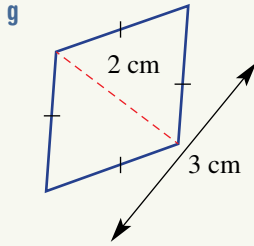
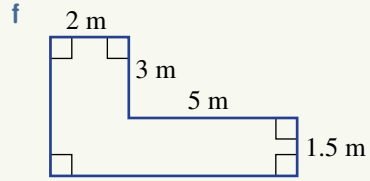
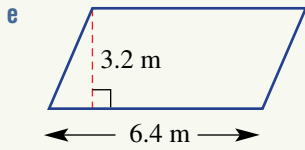

4F

8 Find the area and perimeter of these sectors. Round to two decimal places.

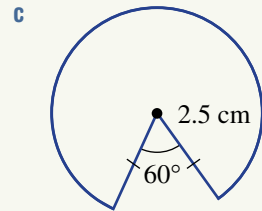
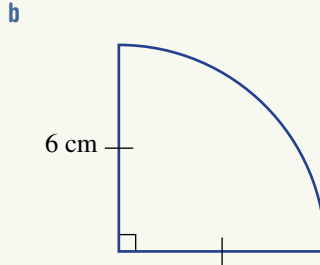
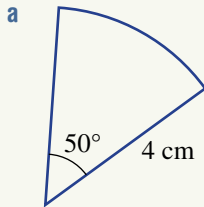

4F

9 Find the area of these composite shapes, correct to two decimal places.

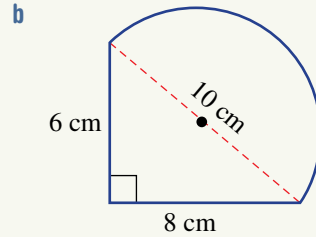
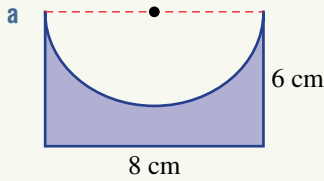

4G/H/I

10 Find the surface area of these prisms.

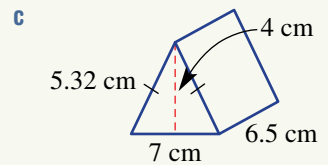
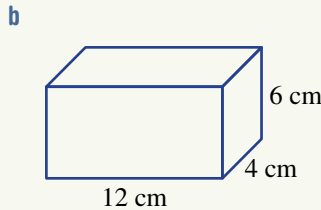
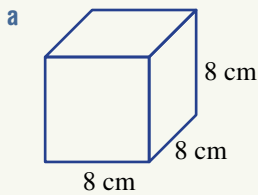



## 4H Volume and capacity

### LEARNING INTENTIONS

- To understand that volume is the space occupied by a three-dimensional object
- To understand that capacity is the volume of fluid or gas that a container can hold
- To be able to convert between units for volume and capacity
- To be able to find the volume of rectangular prisms, including cubes

Volume is a measure of the space occupied by a three-dimensional object. It is measured in cubic units. Common metric units for volume given in abbreviated form include  $\text{mm}^3$ ,  $\text{cm}^3$ ,  $\text{m}^3$  and  $\text{km}^3$ . We also use mL, L, kL and ML to describe volumes of fluids or gases. The volume of space occupied by a room in a house, for example, might be calculated in cubic metres ( $\text{m}^3$ ) or the capacity of a fuel tanker might be measured in litres (L) or kilolitres (kL).



Capsule hotels have hundreds of tiny bed-sized rooms with a TV and a small locker. Each capsule is a rectangular prism, about 2 m long by 1.25 m wide by 1 m high, giving a volume of  $2.5 \text{ m}^3$ .

### Lesson starter: Packing a shipping container

There are 250 crates of apples to be shipped from Australia to Japan. Each crate is 1 m long, 1 m wide and 1 m high. The shipping container used to hold the crates is 12 m long, 4 m wide and 5 m high.

The fruit picker says that the 250 crates will ‘fit in, no problems’. The forklift driver says that the 250 crates will ‘just squeeze in’. The truck driver says that ‘you will need more than one shipping container’.

- Explain how the crates might be packed into the container. How many will fit into one end?
- Who (the fruit picker, forklift driver or truck driver) is the most accurate? Explain your choice.
- What size shipping container and what dimensions would be required to take all 250 crates with no space left over? Is this possible or practical?

## KEY IDEAS

■ **Volume** is measured in cubic units. Common metric units are:

- cubic millimetres ( $\text{mm}^3$ )
- cubic centimetres ( $\text{cm}^3$ )
- cubic metres ( $\text{m}^3$ )
- cubic kilometres ( $\text{km}^3$ ).

■ **Capacity** is the volume of fluid or gas that a container can hold.

Common metric units are:

- millilitre (mL)
- litre (L)
- kilolitre (kL)
- megalitre (ML)

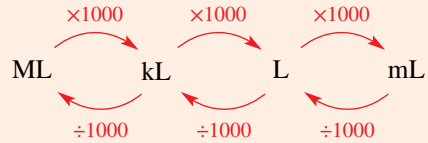

■ Some common conversions are:

- $1 \text{ mL} = 1 \text{ cm}^3$
- $1 \text{ L} = 1000 \text{ mL}$
- $1 \text{ kL} = 1000 \text{ L} = 1 \text{ m}^3$

■ Volume of a rectangular prism

- Volume = length  $\times$  width  $\times$  height

$$V = lwh$$

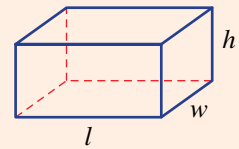

■ Volume of a cube

- $V = l^3$

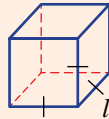

## BUILDING UNDERSTANDING

1 Count how many cubic units are shown in these cube stacks.

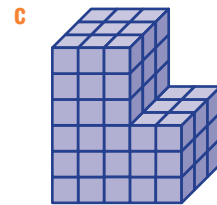
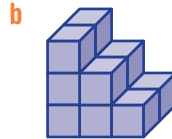
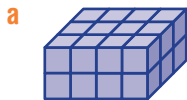

2 State the missing number in the following unit conversions.

- a  $1 \text{ L} = \underline{\hspace{2cm}} \text{ mL}$
- b  $\underline{\hspace{2cm}} \text{ kL} = 1000 \text{ L}$
- c  $1000 \text{ kL} = \underline{\hspace{2cm}} \text{ ML}$
- d  $1 \text{ mL} = \underline{\hspace{2cm}} \text{ cm}^3$
- e  $1000 \text{ cm}^3 = \underline{\hspace{2cm}} \text{ L}$
- f  $1 \text{ m}^3 = \underline{\hspace{2cm}} \text{ L}$



### Example 16 Finding the volume of a rectangular prism

Find the volume of this rectangular prism.

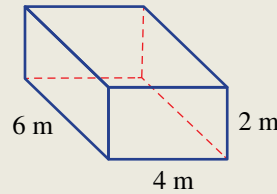

#### SOLUTION

$$\begin{aligned} V &= lwh \\ &= 6 \times 4 \times 2 \\ &= 48\text{m}^3 \end{aligned}$$

#### EXPLANATION

First write the rule and then substitute for the length, width and height. Any order will do since  $6 \times 4 \times 2 = 4 \times 6 \times 2 = 2 \times 4 \times 6$  etc.

#### Now you try

Find the volume of this rectangular prism.

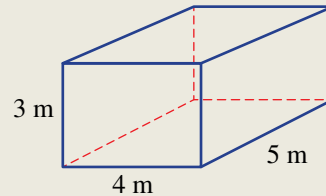

### Example 17 Finding capacity

Find the capacity, in litres, of a container that is a rectangular prism 20 cm long, 10 cm wide and 15 cm high.

#### SOLUTION

$$\begin{aligned} V &= lwh \\ &= 20 \times 10 \times 15 \\ &= 3000\text{cm}^3 \\ \text{Capacity is } 3000\text{mL} &= 3\text{L} \end{aligned}$$

#### EXPLANATION

First calculate the volume of the container in  $\text{cm}^3$ .

Recall  $1\text{cm}^3 = 1\text{mL}$

Then convert to litres using  $1\text{L} = 1000\text{mL}$ .

#### Now you try

Find the capacity, in litres, of a container that is a rectangular prism 25 cm long, 10 cm wide and 10 cm high.

## Exercise 4H

### FLUENCY

1, 2-4( $\frac{1}{2}$ )

2-4( $\frac{1}{2}$ )

2( $\frac{1}{3}$ ), 3( $\frac{1}{2}$ ), 4( $\frac{1}{3}$ )

Example 16

- 1 Find the volume of this rectangular prism.

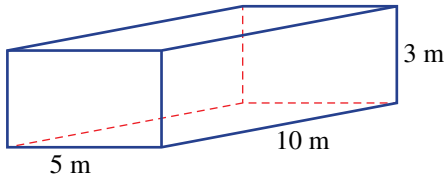

Example 16

- 2 Find the volume of these rectangular prisms.

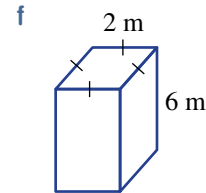
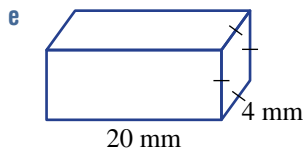
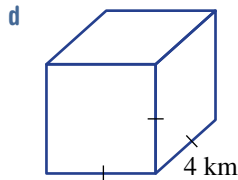
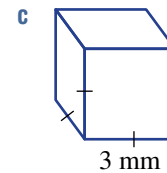
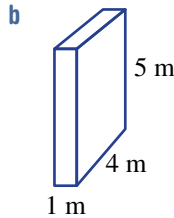
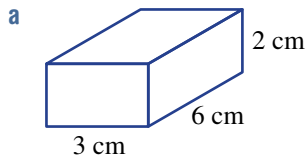

- 3 Convert the measurements to the units shown in the brackets. Refer to the **Key ideas** for help.

a 2 L (mL)

b 5 kL (L)

c 0.5 ML (kL)

d 3000 mL (L)

e 4 mL ( $\text{cm}^3$ )

f  $50 \text{ cm}^3$  (mL)

g  $2500 \text{ cm}^3$  (L)

h 5.1 L ( $\text{cm}^3$ )

Example 17

- 4 Find the capacity of these containers, converting your answer to litres.

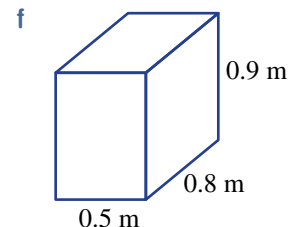
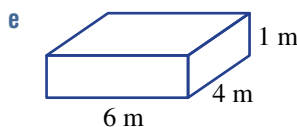
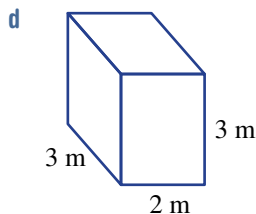
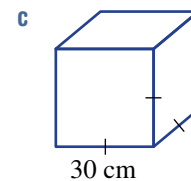
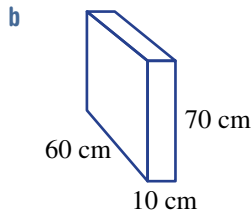
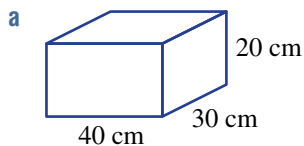

## PROBLEM-SOLVING

5-7

6-8

7-9

- 5 An oil tanker has a capacity of  $60\,000\text{ m}^3$ .
- What is the ship's capacity in:
    - litres?
    - kilolitres?
    - megalitres?
  - If the tanker leaks oil at a rate of  $300\,000$  litres per day, how long will it take for all the oil to leak out?  
Assume the ship started with full capacity.
- 6 Water is being poured into a fish tank at a rate of  $2\text{ L}$  every  $10$  seconds. The tank is  $1.2\text{ m}$  long by  $1\text{ m}$  wide by  $80\text{ cm}$  high. How long will it take to fill the tank? Give the answer in minutes.
- 7 A city skyscraper is a rectangular prism  $50\text{ m}$  long,  $40\text{ m}$  wide and  $250\text{ m}$  high.
- What is the total volume in  $\text{m}^3$ ?
  - What is the total volume in  $\text{ML}$ ?
- 8 If  $1\text{ kg}$  is the mass of  $1\text{ L}$  of water, what is the mass of water in a full container that is a cube with side length  $2\text{ m}$ ?
- 9 Using whole numbers only, give all the possible dimensions of rectangular prisms with the following volume. Assume the units are all the same.
- $12$  cubic units
  - $30$  cubic units
  - $47$  cubic units

## REASONING

10, 11

11, 12

11-13

- 10 Explain why a rectangular prism of volume  $46\text{ cm}^3$  cannot have all its side lengths (length, width and height) as whole numbers greater than  $1$ . Assume all lengths are in centimetres.
- 11 A  $1\text{ m} \times 1\text{ m} \times 1\text{ m}$  cube has a volume of  $1\text{ m}^3$ .
- By converting each measurement to  $\text{cm}$  first, find the volume of the cube in  $\text{cm}^3$ .
  - Describe, in general, how you can convert from  $\text{m}^3$  to  $\text{cm}^3$ .
- 12 How many cubic containers, with side lengths that are a whole number of centimetres, have a capacity of less than  $1$  litre?
- 13 Consider this rectangular prism.
- How many cubes are in the base layer?
  - What is the area of the base?
  - What do you notice about the two answers from above? How can this be explained?
  - If  $A$  represents the area of the base, explain why the rule  $V = Ah$  can be used to find the volume of a rectangular prism.
  - Could any side of a rectangular prism be considered to be the base when using the rule  $V = Ah$ ? Explain your reasoning.

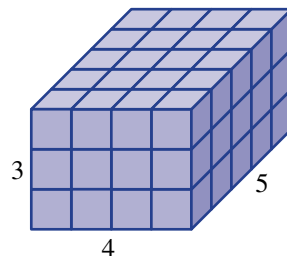
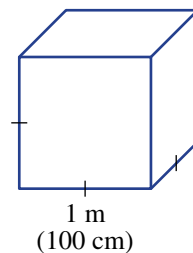

**ENRICHMENT: Halving rectangular prisms**      -      -      14

- 14 This question looks at using half of a rectangular prism to find the volume of a triangular prism.  
 a Consider this triangular prism.

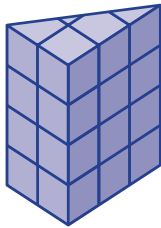

- i Explain why this solid could be thought of as half of a rectangular prism.  
 ii Find its volume.  
 b Using a similar idea, find the volume of these prisms.

i

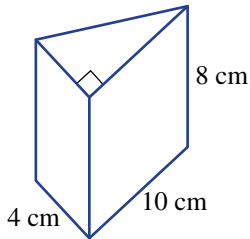

ii

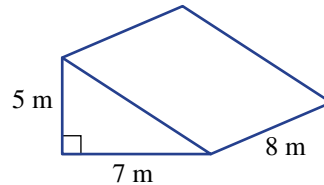

iii

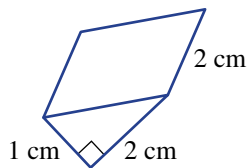

iv

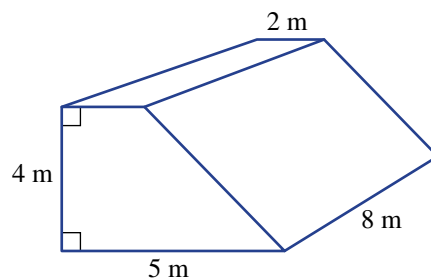

v

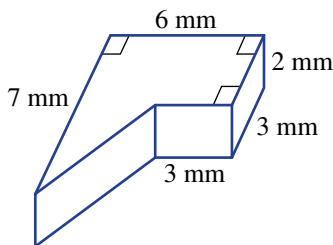

vi

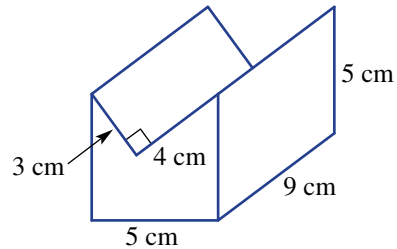

## 41 Volume of prisms and cylinders

### LEARNING INTENTIONS

- To understand what a cross-section is of a prism and cylinder
- To be able to find the volume of a prism
- To be able to find the volume of a cylinder

We know that for a rectangular prism its volume  $V$  is given by the rule  $V = lwh$ . Length  $\times$  width ( $lw$ ) gives the number of cubes on the base, but it also tells us the area of the base  $A$ . So  $V = lwh$  could also be written as  $V = Ah$ .

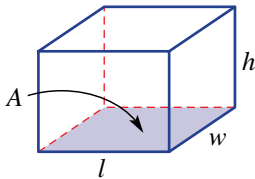

The rule  $V = Ah$  can also be applied to prisms that have different shapes as their bases. One condition, however, is that the area of the base must represent the area of the cross-section of the solid. The height  $h$  is measured perpendicular to the cross-section. Note that a cylinder is *not* a prism as it does not have sides that are parallelograms; however, it can be treated like a prism when finding its volume because it has a constant cross-section, a circle.

Here are some examples of two prisms and a cylinder with  $A$  and  $h$  marked.

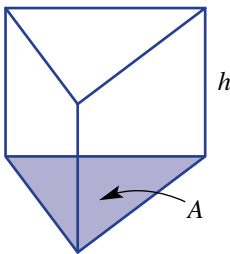

Cross-section is a triangle

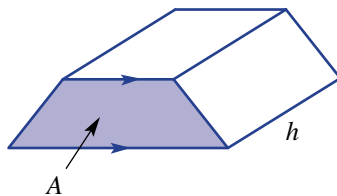

Cross-section is a trapezium

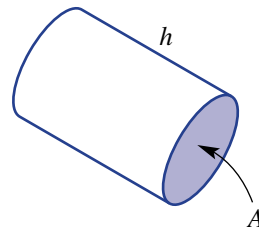

Cross-section is a circle



Engineers designed this cylindrical aquarium in Berlin, that is 25 m high by 12 m in diameter and holds one million litres of water. To view the many fish, guests take a two-storey elevator ride within the tank.

### Lesson starter: Drawing prisms

Try to draw prisms (or cylinders) that have the following shapes as their cross-sections.

- Circle
- Triangle
- Trapezium
- Pentagon
- Parallelogram

The cross-section of a prism should be the same size and shape along the entire length of the prism. Check this property on your drawings.

### KEY IDEAS

- A **prism** is a polyhedron with a constant (uniform) cross-section.
  - The sides joining the two congruent ends are parallelograms.
  - A right prism has rectangular sides joining the congruent ends.

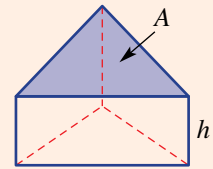

- Volume of a prism = Area of cross-section  $\times$  perpendicular height or  $V = Ah$ .

- Volume of a **cylinder** =  $Ah = \pi r^2 \times h = \pi r^2 h$   
So  $V = \pi r^2 h$

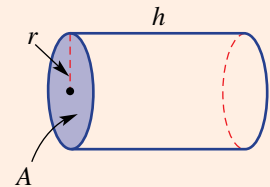

### BUILDING UNDERSTANDING

- 1 For these solids:
- i state whether or not it looks like a prism
  - ii if it is a prism, state the shape of its cross-section.

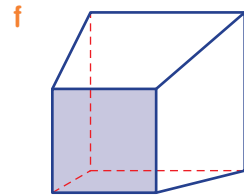
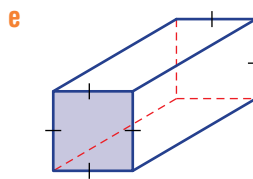
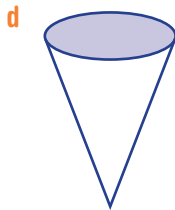
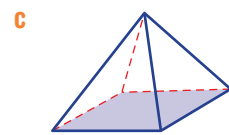
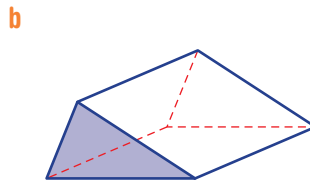
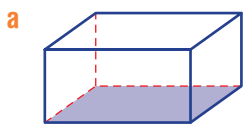

- 2 For these prisms and cylinder, state the value of  $A$  and the value of  $h$  that could be used in the rule  $V = Ah$  to find the volume of the solid.

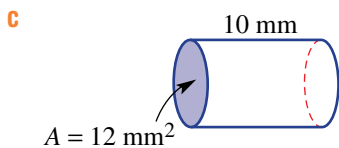
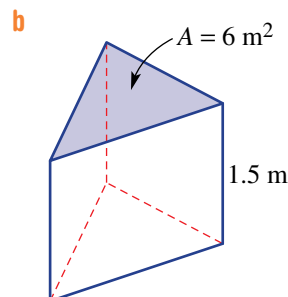
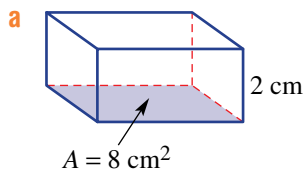



**Example 18 Finding the volumes of prisms**

Find the volumes of these prisms.

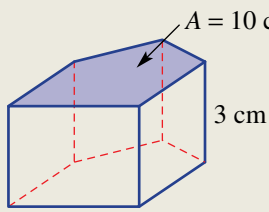
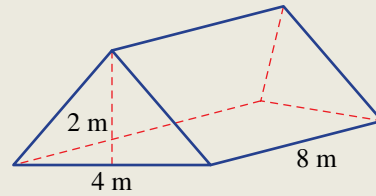
**a****b****SOLUTION**

$$\begin{aligned} \mathbf{a} \quad V &= Ah \\ &= 10 \times 3 \\ &= 30 \text{ cm}^3 \end{aligned}$$

$$\begin{aligned} \mathbf{b} \quad V &= Ah \\ &= \left(\frac{1}{2} \times 4 \times 2\right) \times 8 \\ &= 32 \text{ m}^3 \end{aligned}$$

**EXPLANATION**

Write the rule and substitute the given values of  $A$  and  $h$ , where  $A$  is the area of the cross-section.

The cross-section is a triangle, so use  $A = \frac{1}{2}bh$  with base  $4 \text{ m}$  and height  $2 \text{ m}$ .

**Now you try**

Find the volumes of these prisms.

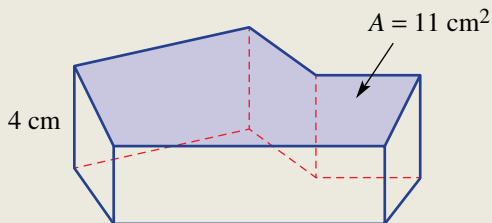
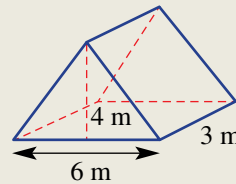
**a****b****Example 19 Finding the volume of a cylinder**

Find the volumes of these cylinders, rounding to two decimal places.

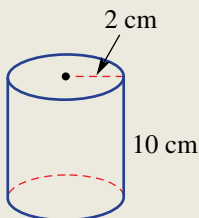
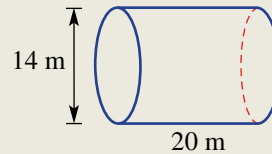
**a****b***Continued on next page*

**SOLUTION**

a  $V = \pi r^2 h$   
 $= \pi \times 2^2 \times 10$   
 $= 125.66 \text{ cm}^3$  (to 2 d.p.)

b  $V = \pi r^2 h$   
 $= \pi \times 7^2 \times 20$   
 $= 3078.76 \text{ m}^3$  (to 2 d.p.)

**EXPLANATION**

Write the rule and then substitute the given values for  $\pi$ ,  $r$  and  $h$ .

Round as required.

The diameter is 14 m so the radius is 7 m.

Round as required.

**Now you try**

Find the volumes of these cylinders, rounding to two decimal places.

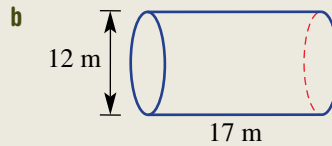
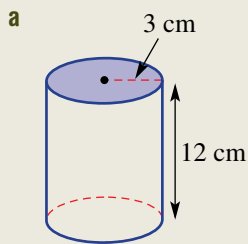

**Exercise 4I**

**FLUENCY**

1, 2, 3–4(1/2)

2, 3–4(1/2)

2–4(1/3)

Example 18a

1 Find the volume of these prisms.

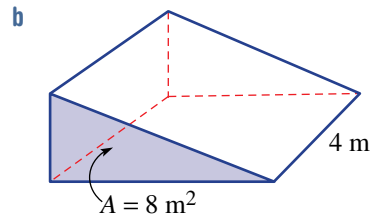
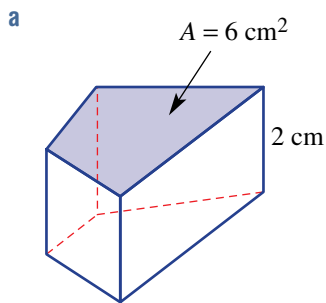

Example 18a

2 Find the volume of these solids using  $V = Ah$ .

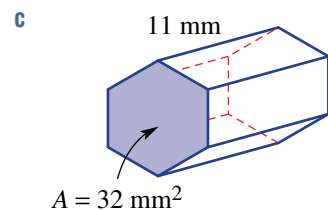
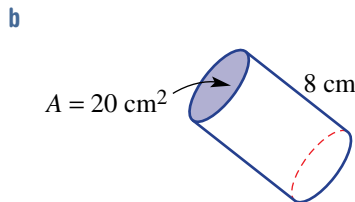
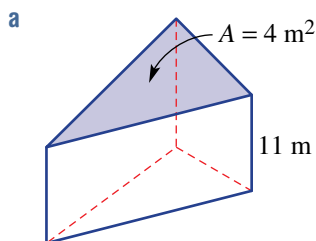

Example 18b

3 Find the volume of these prisms.

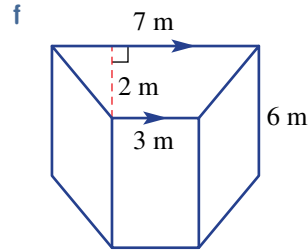
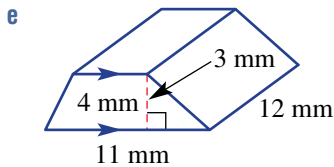
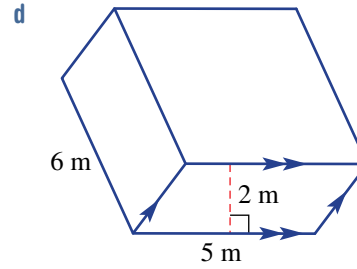
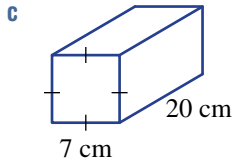
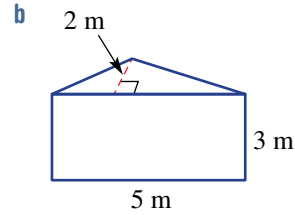
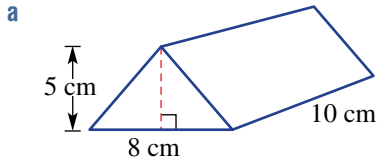

Example 19

4 Find the volume of these cylinders. Round the answer to two decimal places.

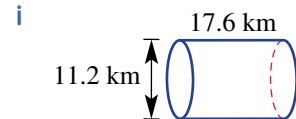
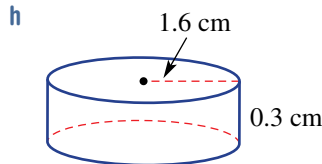
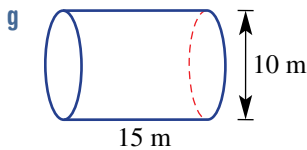
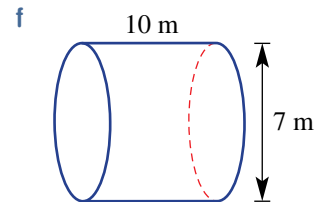
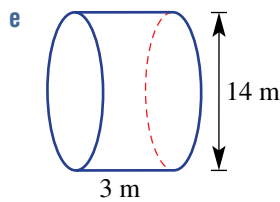
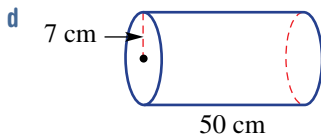
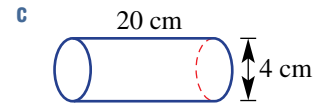
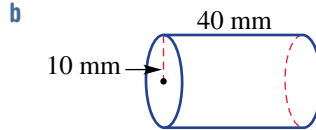
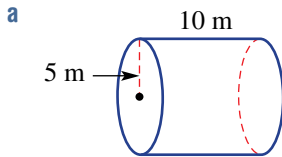

## PROBLEM-SOLVING

5, 6

6–8

7–9

- 5 A cylindrical tank has a diameter of 3 m and height 2 m.  
 a Find its volume in  $\text{m}^3$ , correct to three decimal places.  
 b What is the capacity of the tank in litres?
- 6 Jack looks at buying either a rectangular water tank with dimensions 3 m by 1 m by 2 m or a cylindrical tank with radius 1 m and height 2 m.  
 a Which tank has the greater volume?  
 b What is the difference in the volume, correct to the nearest litre?
- 7 Susan pours water from a full 4 L container into a number of water bottles for a camp hike. Each water bottle is a cylinder with radius 4 cm and height 20 cm. How many bottles can be filled completely?



- 8 There are 80 liquorice cubes stacked in a cylindrical glass jar. The liquorice cubes have a side length of 2 cm and the glass jar has a radius of 5 cm and a height of 12 cm. How much air space remains in the jar of liquorice cubes? Give the answer correct to two decimal places.
- 9 A swimming pool is a prism with a cross-section that is a trapezium as shown. The pool is being filled at a rate of 1000 litres per hour.  
 a Find the capacity of the pool in litres.  
 b How long will it take to fill the pool?

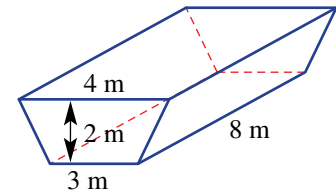

## REASONING

10

10, 11

11, 12

- 10 Using exact values (e.g.  $10\pi\text{cm}^3$ ), calculate the volume of cylinders with these dimensions.  
 a radius 2 m and height 5 m  
 b radius 10 cm and height 3 cm  
 c diameter 8 mm and height 9 mm  
 d diameter 7 m and height 20 m
- 11 A cylinder has a volume of  $100\text{cm}^3$ . Give three different combinations of radius and height measurements that give this volume. Give these lengths, correct to two decimal places.
- 12 A cube has side length  $x$  metres and a cylinder has a radius also of  $x$  metres and height  $h$ . What is the rule linking  $x$  and  $h$  if the cube and the cylinder have the same volume?

**ENRICHMENT: Complex composites** - - 13

**13** Use your knowledge of volumes of prisms and cylinders to find the volume of these composite solids. Round the answer to two decimal places where necessary.

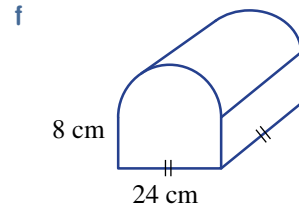
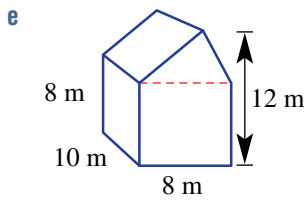
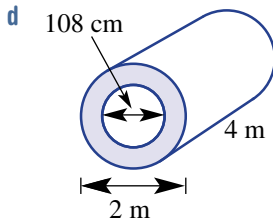
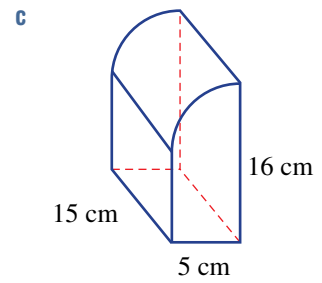
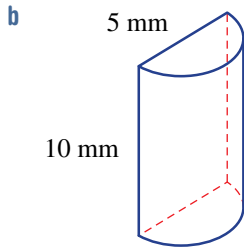
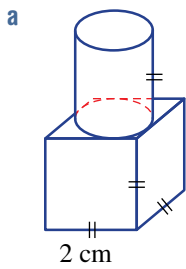

The following problems will investigate practical situations drawing upon knowledge and skills developed throughout the chapter. In attempting to solve these problems, aim to identify the key information, use diagrams, formulate ideas, apply strategies, make calculations and check and communicate your solutions.

## Designing an athletics track

- 1 Jepsen Break Secondary School are planning to turn one of their school ovals into an athletics track. All athletics tracks are designed for the distance to be 400 m in lane 1, the inside lane. One of the students, Jared, has been placed in charge of the design of the track.

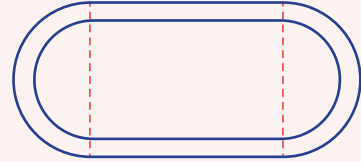

*Jared needs to calculate the dimensions of various parts of the track in order to complete a design.*

Give answers correct to two decimal places where necessary.

- If Jared plans to have 100 m straights, what would be the radius of the semicircles on each end?
- Jared has measured the existing length of the oval and he has calculated that the straights can only be 88 m long. What would the radius of the semicircles need to be for the track to still measure 400 m?
- Official athletics tracks actually have straights of length 84.39 m. What is the radius of the semicircle on an official athletics track?
- The actual official dimensions for an athletics track are 84.39 m straights and 36.50 m radius for each semicircle. If an athlete could run exactly on the innermost line of the track, what distance would the runner run? Give your answer correct to two decimal places.
- The official width of an athletics lane is 1.22 m. How far should the runner in lane 2 start ahead of the runner in lane 1 so that they both run the same distance? This distance is known as the stagger distance.
- If possible, go to an athletics track and as accurately as possible measure the straight length and the inner semicircle radius.

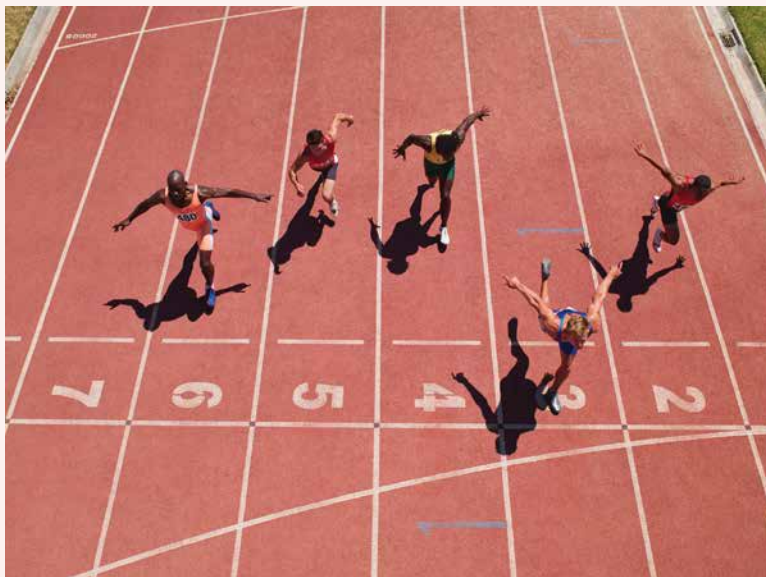

## The Broomchester swimming pool

- 2 The small town of Broomchester has a rectangular public swimming pool that is 25 m long and 16 m wide. The depth of the pool is 1.2 m at the shallow end and 2.0 m at the deep end. The shallow depth of the pool remains the same until the halfway point and then evenly increases to the depth of 2.0 m at the deep end. The diagram below shows the cross-section of the pool.

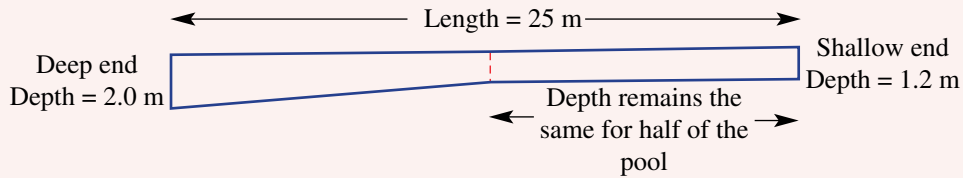

*The council of Broomchester are interested in calculating the total capacity of the pool and how water restrictions and evaporation affect the depth of water in the pool.*

Give answers correct to the nearest whole number where appropriate.

- Determine the volume of the pool in cubic metres.
- Determine the volume of the pool in cubic centimetres.
- To fill the pool a large diameter hose is used with a flow rate of 48 L/min. How many hours does it take to fill the pool at the start of each summer?
- Due to water restrictions, the Broomchester council requested that the pool could only use 0.5 megalitres (ML) for the season. What height would the water be at the shallow end of the pool with these restrictions?
- Water evaporation causes the height of the pool to drop on average by 5 cm per week. What volume of water, in litres, must be added to the pool each week to maintain the depth of the pool?
- If possible, investigate the maximum flow rate of your garden tap. How long would it take your garden hose to fill the Broomchester swimming pool?

## Planning a surprise birthday party

- 3 Meredith is organising a surprise birthday party for her friend Jasmine. Meredith is planning a 3-hour party and wants to invite 10 of Jasmine's close friends. As an extra surprise, Meredith wants to arrange a group FaceTime call with two of Jasmine's friends who now live overseas – one in Vancouver, Canada, and one in Dubai, UAE.

*Meredith is interested in determining the most appropriate time that could work for Jasmine's international friends to virtually join the party.*

- A group FaceTime call is planned for a Friday at 6 p.m. AEST. What day and time would this be in Vancouver and Dubai?
- Suggest the best possible day and time for a half-hour group FaceTime call during the surprise birthday party, stating the day and times in your local time and in Vancouver and Dubai.
- Suggest the best possible day and time for Jasmine's 3-hour birthday party.
- If Jasmine wanted to celebrate New Year's Eve in Brisbane, Australia, and also celebrate New Year's Eve with her good friend in Vancouver, Canada, would this be possible? Investigate time zones, distances and speeds to help determine your answer.

## 4J Units of time and time zones

### LEARNING INTENTIONS

- To be able to convert between different units of time
- To be able to convert between times in 24-hour time and a.m./ p.m.
- To be able to use a time zone map to relate times in different locations in the world

Time measured in minutes and seconds is based on the number 60. Other units of time, including the day and year, are defined by the rate at which Earth spins on its axis and the time that Earth takes to orbit the Sun.

The origin of the units seconds and minutes dates back to the ancient Babylonians, who used a base 60 number system. The 24-hour day dates back to the ancient Egyptians, who described the day as 12 hours of day and 12 hours of night. Today, we use a.m. (*ante meridiem*, which is Latin for 'before noon') and p.m. (*post meridiem*, which is Latin for 'after noon')

to represent the hours before and after noon (midday). During the rule of Julius Caesar, the ancient Romans introduced the solar calendar, which recognised that Earth takes about  $365\frac{1}{4}$  days to orbit the Sun. This gave rise to the leap year, which includes one extra day (in February) every 4 years.



Adjusting clock time is necessary when travelling across some of the world's 24 time zones, each local time being one hour different.

### Lesson starter: Knowledge of time

Do you know the answers to these questions about time and the calendar?

- When is the next leap year?
- Why do we have a leap year?
- Which months have 31 days?
- Why are there different times in different countries or parts of a country?
- What do BCE (or BC) and CE (or AD) mean on time scales?

### KEY IDEAS

■ The standard unit of time is the **second** (s).

■ Units of time include:

- 1 **minute** (min) = 60 seconds (s)
- 1 **hour** (h) = 60 minutes (min)
- 1 **day** = 24 hours (h)
- 1 **week** = 7 days
- 1 **year** = 12 months

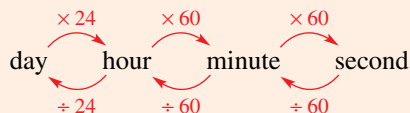



- Units of time smaller than a second include:
  - millisecond = 0.001 second (1000 milliseconds = 1 second)
  - microsecond = 0.000001 second (1 000 000 microseconds = 1 second)
  - nanosecond = 0.000000001 second (1 000 000 000 nanoseconds = 1 second)
- a.m. and p.m. are used to describe the 12 hours before and after noon (midday).
- **24-hour time** shows the number of hours and minutes after midnight.
  - 0330 is 3:30 a.m.
  - 1530 is 3:30 p.m.
- The ‘degrees, minutes and seconds’ button on a calculator can be used to convert a particular time into hours, minutes and seconds.  
For example: 4.42 hours =  $4^{\circ}25' 12''$  meaning 4 hours, 25 minutes and 12 seconds
- Earth is divided into 24 time zones (one for each hour).
  - Twenty-four  $15^{\circ}$  lines of longitude divide Earth into its time zones. Time zones also depend on a country’s borders and its proximity to other countries. (See the map on pages 296–7 for details.)
  - Time is based on the time in a place called Greenwich, United Kingdom, and this is called Coordinated Universal Time (UTC) or Greenwich Mean Time (GMT).
  - Places east of Greenwich are ahead in time.
  - Places west of Greenwich are behind in time.
- Australia has three time zones:
  - Eastern Standard Time (EST), which is UTC plus 10 hours.
  - Central Standard Time (CST), which is UTC plus 9.5 hours.
  - Western Standard Time (WST), which is UTC plus 8 hours.

## BUILDING UNDERSTANDING

- 1 From options **A** to **F**, match up the time units with the most appropriate description.
 

<b>a</b> single heartbeat	<b>A</b> 1 hour
<b>b</b> 40 hours of work	<b>B</b> 1 minute
<b>c</b> duration of a university lecture	<b>C</b> 1 day
<b>d</b> bank term deposit	<b>D</b> 1 week
<b>e</b> 200 m run	<b>E</b> 1 year
<b>f</b> flight from Australia to the UK	<b>F</b> 1 second
- 2 Find the number of:
 

<b>a</b> seconds in 2 minutes	<b>b</b> minutes in 180 seconds
<b>c</b> hours in 120 minutes	<b>d</b> minutes in 4 hours
<b>e</b> hours in 3 days	<b>f</b> weeks in 35 days.
- 3 What is the time difference between these times?
  - a** 12 p.m. and 6:30 p.m. on the same day
  - b** 11 a.m. and 3:30 p.m. on the same day

**Example 20 Converting units of time**

Convert these times to the units shown in brackets.

**a** 3 days (minutes)

**b** 30 months (years)

**SOLUTION**

$$\begin{aligned} \mathbf{a} \quad 3 \text{ days} &= 3 \times 24 \text{ h} \\ &= 3 \times 24 \times 60 \text{ min} \\ &= 4320 \text{ min} \end{aligned}$$

$$\begin{aligned} \mathbf{b} \quad 30 \text{ months} &= 30 \div 12 \text{ years} \\ &= 2\frac{1}{2} \text{ years} \end{aligned}$$

**EXPLANATION**

1 day = 24 hours

1 hour = 60 minutes

There are 12 months in 1 year.

**Now you try**

Convert these times to the units shown in brackets.

**a** 11 days (hours)

**b** 42 months (years)

**Example 21 Using 24-hour time**

Write these times using the system given in brackets.

**a** 4:30 p.m. (24-hour time)

**b** 1945 hours (a.m./p.m.)

**SOLUTION**

$$\begin{aligned} \mathbf{a} \quad 4:30 \text{ p.m.} &= 1200 + 0430 \\ &= 1630 \text{ hours} \end{aligned}$$

**b** 1945 hours = 7:45 p.m.

**EXPLANATION**

Since the time is p.m., add 12 hours to 0430 hours.

Since the time is after 1200 hours, subtract 12 hours.

**Now you try**

Write these times using the system given in brackets.

**a** 10:30 p.m. (24-hour time)

**b** 1720 hours (a.m./p.m.)



### Example 22 Using time zones

Coordinated Universal Time (UTC) and is based on the time in Greenwich, United Kingdom. Use the world time zone map (on pages 296–7) to answer the following.

- a** When it is 2 p.m. UTC, find the time in these places.
- |                |           |
|----------------|-----------|
| i France       | ii China  |
| iii Queensland | iv Alaska |
- b** When it is 9:35 a.m. in New South Wales, Australia, find the time in these places.
- |                 |                      |
|-----------------|----------------------|
| i Alice Springs | ii Perth             |
| iii London      | iv Central Greenland |

#### SOLUTION

**a i**  $2 \text{ p.m.} + 1 \text{ hour} = 3 \text{ p.m.}$

**ii**  $2 \text{ p.m.} + 8 \text{ hours} = 10 \text{ p.m.}$

**iii**  $2 \text{ p.m.} + 10 \text{ hours} = 12 \text{ a.m.}$

**iv**  $2 \text{ p.m.} - 9 \text{ hours} = 5 \text{ a.m.}$

**b i**  $9:35 \text{ a.m.} - \frac{1}{2} \text{ hour} = 9:05 \text{ a.m.}$

**ii**  $9:35 \text{ a.m.} - 2 \text{ hours} = 7:35 \text{ a.m.}$

**iii**  $9:35 \text{ a.m.} - 10 \text{ hours} = 11:35 \text{ p.m.}$   
(the day before)

**iv**  $9:35 \text{ a.m.} - 13 \text{ hours} = 8:35 \text{ p.m.}$   
(the day before)

#### EXPLANATION

Use the time zone map to see that France is to the east of Greenwich and is in a zone that is 1 hour ahead.

From the time zone map, China is 8 hours ahead of Greenwich.

Queensland uses Eastern Standard Time, which is 10 hours ahead of Greenwich.

Alaska is to the west of Greenwich, in a time zone that is 9 hours behind.

Alice Springs uses Central Standard Time, which is  $\frac{1}{2}$  hour behind Eastern Standard Time.

Perth uses Western Standard Time, which is 2 hours behind Eastern Standard Time.

UTC (time in Greenwich, United Kingdom) is 10 hours behind EST.

Central Greenland is 3 hours behind UTC in Greenwich, so is 13 hours behind EST.

#### Now you try

- a** When it is 1 p.m. UTC, find the time in these places.
- |         |          |          |             |
|---------|----------|----------|-------------|
| i Japan | ii Sudan | iii Peru | iv Victoria |
|---------|----------|----------|-------------|
- b** When it is 10:30 p.m. in Western Australia, find the time in these places.
- |              |          |               |           |
|--------------|----------|---------------|-----------|
| i Queensland | ii China | iii Argentina | iv Alaska |
|--------------|----------|---------------|-----------|

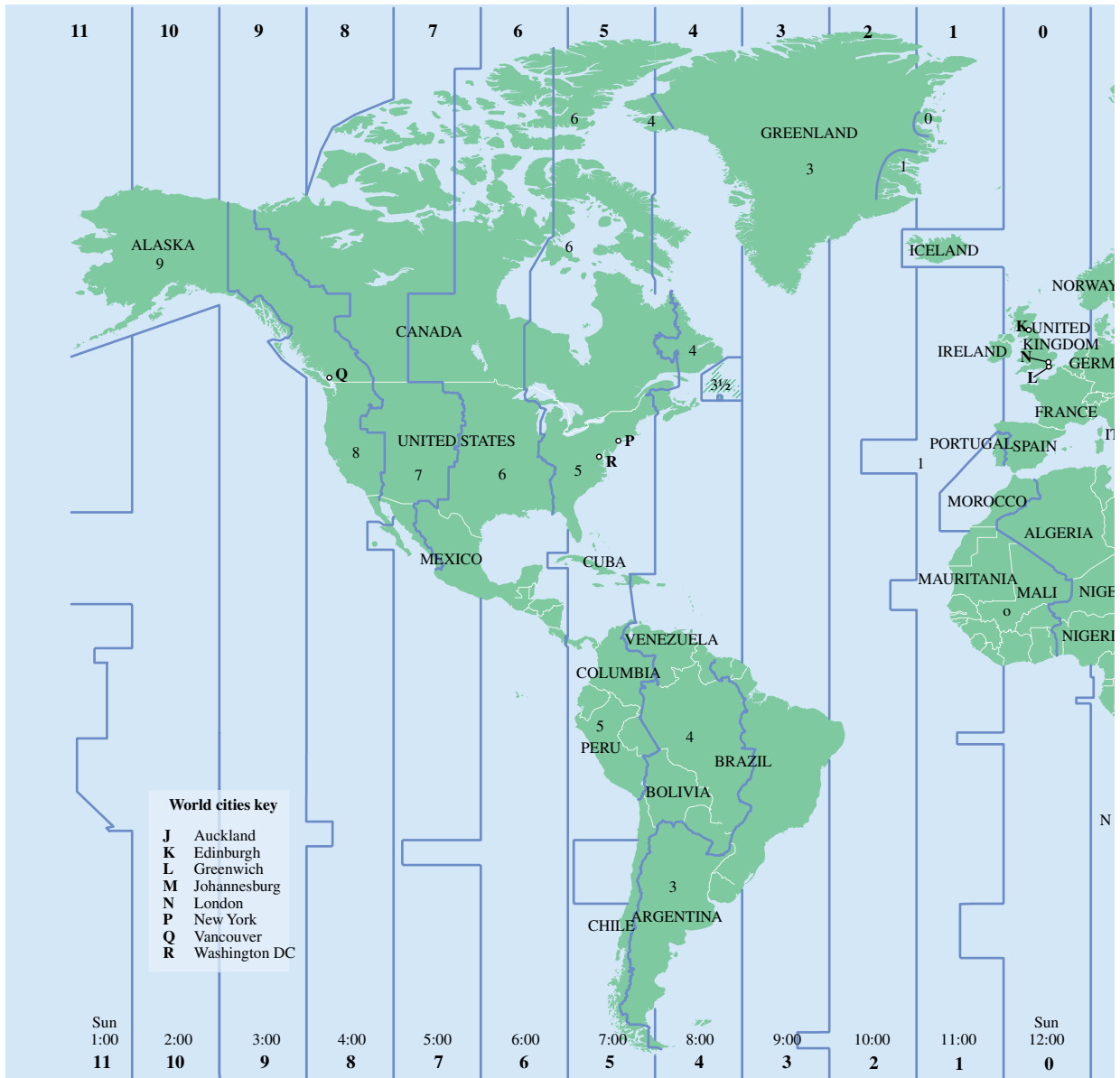

**Australian cities key**

- A Adelaide
- B Alice Springs
- C Brisbane
- D Cairns
- E Canberra, ACT
- F Darwin
- G Hobart
- H Melbourne
- I Perth
- J Sydney

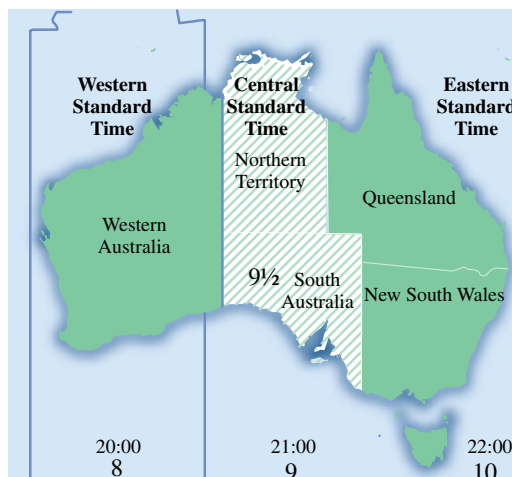

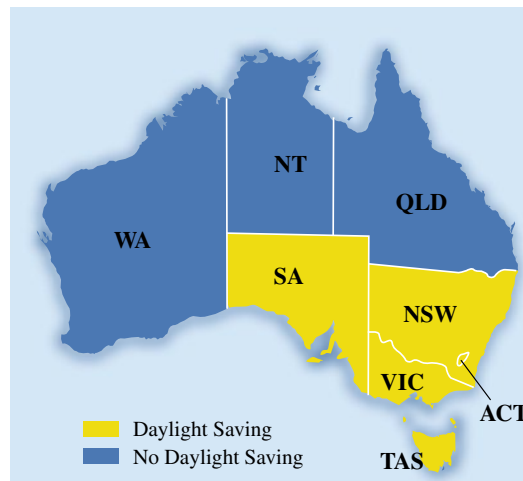

## Exercise 4J

## FLUENCY

1, 2-7( $\frac{1}{2}$ )2-8( $\frac{1}{2}$ )2-4( $\frac{1}{3}$ ), 5-9( $\frac{1}{2}$ )

Example 20a



1 Convert these times to the units shown in brackets.

- a i 2 hours (minutes) ii 240 seconds (minutes)  
b i 5 days (minutes) ii 2880 minutes (days)

Example 20



2 Convert these times to the units shown in brackets.

- a 3 h (min) b 10.5 min (s)  
c 240 s (min) d 90 min (h)  
e 6 days (h) f 72 h (days)  
g 1 week (h) h 1 day (min)  
i 14400 s (h) j 20160 min (weeks)  
k 2 weeks (min) l 24 h (s)  
m 5000 milliseconds (s) n 2500000 microseconds (s)  
o 7000000000 nanoseconds (s) p 0.4 s (milliseconds)  
q 0.0000027 s (microseconds) r 0.00000003 s (nanoseconds)

3 Write the time for these descriptions.

- a 4 hours after 2:30 p.m. b 10 hours before 7 p.m.  
c  $3\frac{1}{2}$  hours before 10 p.m. d  $7\frac{1}{2}$  hours after 9 a.m.  
e  $6\frac{1}{4}$  hours after 11:15 a.m. f  $1\frac{3}{4}$  hours before 1:25 p.m.

Example 21

4 Write these times using the system shown in brackets.

- a 1:30 p.m. (24-hour) b 8:15 p.m. (24-hour) c 10:23 a.m. (24-hour)  
d 11:59 p.m. (24-hour) e 0630 hours (a.m./p.m.) f 1300 hours (a.m./p.m.)  
g 1429 hours (a.m./p.m.) h 1938 hours (a.m./p.m.) i 2351 hours (a.m./p.m.)

5 Round these times to the nearest hour.

- a 1:32 p.m. b 5:28 a.m.  
c 1219 hours d 1749 hours

6 What is the time difference between these time periods?

- a 10:30 a.m. and 1:20 p.m. b 9:10 a.m. and 3:30 p.m.  
c 2:37 p.m. and 5:21 p.m. d 10:42 p.m. and 7:32 a.m.  
e 1451 and 2310 hours f 1940 and 0629 hours

Example 22a

7 Use the time zone map on pages 296–7 to find the time in the following places, when it is 10 a.m. UTC.

- a Spain b Turkey c Tasmania d Darwin  
e Argentina f Peru g Alaska h Portugal

Example 22b

8 Use the time zone map on pages 296–7 to find the time in these places, when it is 3:30 p.m. in Victoria.

- a United Kingdom b Libya c Sweden d Perth  
e Japan f Central Greenland g Alice Springs h New Zealand

- 9 What is the time difference between these pairs of places?
- United Kingdom and Kazakhstan
  - South Australia and New Zealand
  - Queensland and Egypt
  - Peru and Angola (in Africa)
  - Mexico and Germany

**PROBLEM-SOLVING**

10–12

12–15

13–17

- 10 A scientist argues that dinosaurs died out 52 million years ago, whereas another says they died out 108 million years ago. What is the difference in their time estimates?



- 11 Three essays are marked by a teacher. The first takes 4 minutes and 32 seconds to mark, the second takes 7 minutes and 19 seconds, and the third takes 5 minutes and 37 seconds. What is the total time taken to complete marking the essays?
- 12 Adrian arrives at school at 8:09 a.m. and leaves at 3:37 p.m. How many hours and minutes is Adrian at school?
- 13 An international company wishes to schedule a virtual meeting between workers in Hobart, London and New York.
- If the meeting is scheduled for 9 a.m. in Hobart, what time is it in the other two cities?
  - If the meeting needs to be between 8 a.m. and 8 p.m. in both London and New York (but not necessarily Hobart), in what range of times would it occur for the Hobart workers?
  - Explain why it might be challenging for this virtual meeting to take place.
- 14 A doctor earns \$180 000 working 40 weeks per year, 5 days per week, 10 hours per day. What does the doctor earn in each of these time periods?
- per day
  - per hour
  - per minute
  - per second (in cents)
- 15 A 2 hour football match starts at 2:30 p.m. Eastern Standard Time (EST) in Newcastle, NSW. What time will it be in United Kingdom when the match finishes?
- 16 Monty departs on a 20-hour flight from Brisbane to London, United Kingdom, at 5 p.m. on 20 April. Give the time and date of his arrival in London.
- 17 Elsa departs on an 11-hour flight from Johannesburg, South Africa, to Perth at 6:30 a.m. on 25 October. Give the time and date of her arrival in Perth.

## REASONING

18

18–20

19–21

 **18** When there are 365 days in a year, how many weeks are there in a year? Round your answer to two decimal places.

-  **19**
- To convert from hours to seconds, what single number do you multiply by?
  - To convert from days to minutes, what single number do you multiply by?
  - To convert from seconds to hours, what single number do you divide by?
  - To convert from minutes to days, what single number do you divide by?



 **20** Assuming there are 365 days in a year and my birthday falls on a Wednesday this year, on what day will my birthday fall in 2 years' time?

- 21**
- Explain why you gain time when you travel from Australia to Europe.
  - Explain why you lose time when you travel from Germany to Australia.
  - Explain what happens to the date when you fly from Australia to Canada across the International Date Line.

## ENRICHMENT: Daylight saving

–

–

22

- 22** Use the internet to investigate how daylight saving affects the time in some places. Write a brief report discussing the following points.
- Name the states in Australia that use daylight saving.
    - Name five other countries that use daylight saving.
  - Describe how daylight saving works, why it is used and what changes have to be made to our clocks.
  - Describe how daylight saving in Australia affects the time difference between time zones. Use New South Wales and Greece as an example.



# 4K Introducing Pythagoras' theorem

**LEARNING INTENTIONS**

- To be able to identify the hypotenuse in a right-angled triangle
- To be able to determine if three numbers form a Pythagorean triple
- To be able to use Pythagoras' theorem to determine if a triangle has a right angle based on its side lengths

Pythagoras was a philosopher in ancient Greece who lived in the 6th century BCE. He studied astronomy, mathematics, music and religion, but is most well known for the famous Pythagoras' theorem. Pythagoras was believed to provide a proof for the theorem that bears his name, and methods to find Pythagorean triples, which are sets of three whole numbers that make up the sides of right-angled triangles.

The ancient Babylonians, 1000 years before Pythagoras' time, and the Egyptians also knew of this relationship between the sides of a right-angled triangle. The ancient theorem is still one of the most commonly used theorems today.

Pythagoras' theorem states that the square of the hypotenuse (longest side) of a right-angled triangle is equal to the sum of the squares of the other two sides. An illustration of the theorem includes squares drawn on the sides of the right-angled triangle. The area of the larger square ( $c^2$ ) is equal to the sum of the two smaller squares ( $a^2 + b^2$ ).

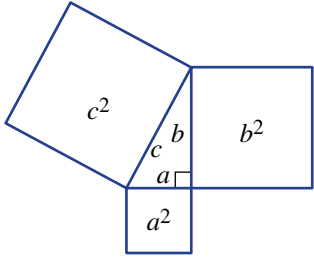

## Lesson starter: Discovering Pythagoras' theorem

Use a ruler to measure the sides of these right-angled triangles to the nearest mm. Then complete the table.

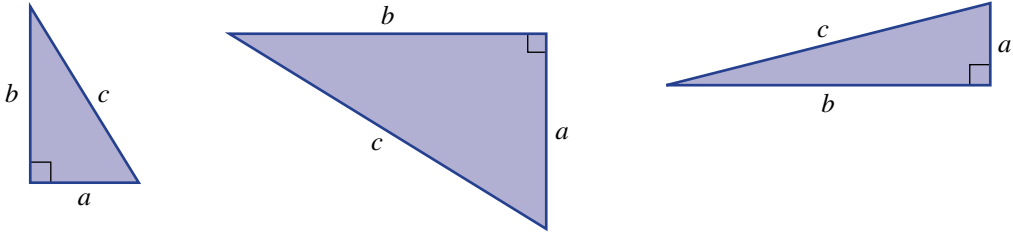

	$a$	$b$	$c$	$a^2$	$b^2$	$c^2$
Triangle 1						
Triangle 2						
Triangle 3						

- Can you see any relationship between the numbers in the columns for  $a^2$  and  $b^2$  and the number in the column for  $c^2$ ?
- Can you write down this relationship as an equation?
- Explain how you might use this relationship to calculate the value of  $c$  if it was unknown.
- Research how you can cut the two smaller squares (with areas  $a^2$  and  $b^2$ ) to fit the pieces into the larger square (with area  $c^2$ ).

## KEY IDEAS

■ The **hypotenuse**

- It is the longest side of a right-angled triangle.
- It is opposite the right angle.

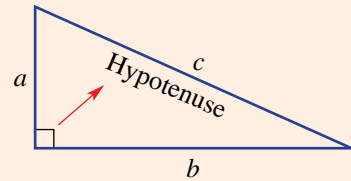
■ **Pythagoras' theorem**

- The square of the length of the hypotenuse is the sum of the squares of the lengths of the other two shorter sides.
- $a^2 + b^2 = c^2$  or  $c^2 = a^2 + b^2$

■ A **Pythagorean triple** (or triad) is a set of three whole numbers which satisfy Pythagoras' theorem.

e.g. 3, 4, 5 is a Pythagorean triple because  $3^2 + 4^2 = 5^2$

■ A triangle can be classified based on its side lengths  $a, b, c$  (in increasing order) as

- right-angled if  $c^2 = a^2 + b^2$
- acute if  $c^2 < a^2 + b^2$
- obtuse if  $c^2 > a^2 + b^2$

## BUILDING UNDERSTANDING

## 1 Calculate these squares and sums of squares.

a  $3^2$

b  $1.5^2$

c  $2^2 + 4^2$

d  $3^2 + 7^2$

## 2 Decide if these equations are true or false.

a  $2^2 + 3^2 = 4^2$

b  $6^2 + 8^2 = 10^2$

c  $6^2 - 3^2 = 2^2$

## 3 State the missing words in this sentence.

The \_\_\_\_\_ is the longest side of a right-angled \_\_\_\_\_.

## 4 Which letter represents the length of the hypotenuse in these triangles?

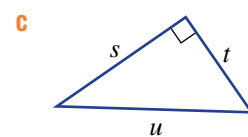
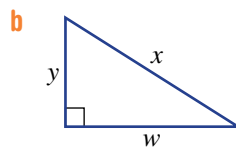
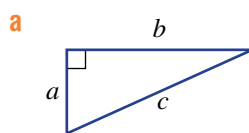



### Example 23 Checking Pythagorean triples

Decide if the following are Pythagorean triples.

**a** 6, 8, 10

**b** 4, 5, 9

#### SOLUTION

$$\begin{aligned} \mathbf{a} \quad a^2 + b^2 &= 6^2 + 8^2 \\ &= 36 + 64 \\ &= 100 (=10^2) \end{aligned}$$

$\therefore$  6, 8, 10 is a Pythagorean triple.

$$\begin{aligned} \mathbf{b} \quad a^2 + b^2 &= 4^2 + 5^2 \\ &= 16 + 25 \\ &= 41 (\neq 9^2) \end{aligned}$$

$\therefore$  4, 5, 9 is not a Pythagorean triple.

#### EXPLANATION

Let  $a = 6$ ,  $b = 8$  and  $c = 10$  and check that  $a^2 + b^2 = c^2$ .

$$\begin{aligned} a^2 + b^2 &= 41 \text{ and} \\ 9^2 &= 81 \text{ so} \\ a^2 + b^2 &\neq c^2 \end{aligned}$$

#### Now you try

Decide if the following are Pythagorean triples.

**a** 4, 6, 8

**b** 3, 4, 5



### Example 24 Classifying a triangle using Pythagoras' theorem

Classify the following triangles as right-angled, acute or obtuse based on their side lengths.

**a**

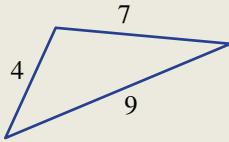

**b**

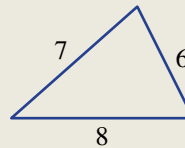

#### SOLUTION

$$\begin{aligned} \mathbf{a} \quad a &= 4, b = 7, c = 9 \\ c^2 &= 9^2 \\ &= 81 \\ a^2 + b^2 &= 4^2 + 7^2 \\ &= 16 + 49 \\ &= 65 \end{aligned}$$

$$81 > 65$$

$\therefore$  This is an obtuse triangle.

#### EXPLANATION

List the side lengths in ascending order so  $c$  is largest. Calculate  $c^2$ .

Calculate  $a^2 + b^2$ .

If  $c^2 > a^2 + b^2$ , then the triangle has an obtuse angle.

*Continued on next page*

$$\text{b } a = 6, b = 7, c = 8$$

$$c^2 = 8^2 \\ = 64$$

$$a^2 + b^2 = 6^2 + 7^2 \\ = 36 + 49 \\ = 85$$

$$64 < 85$$

$\therefore$  This is an acute triangle.

List the side lengths in ascending order.

Calculate  $c^2$ .

Calculate  $a^2 + b^2$ .

If  $c^2 < a^2 + b^2$ , then the triangle has only acute angles.

### Now you try

Classify the following triangles as right-angled, acute or obtuse based on their side lengths.

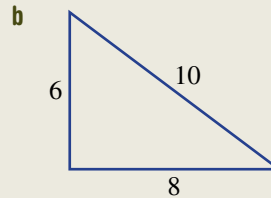
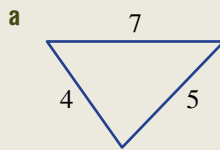

## Exercise 4K

### FLUENCY

1,  $2\frac{1}{2}$ ,  $4\frac{1}{2}$

$2\frac{1}{2}$ , 3, 4

$2\frac{1}{2}$ ,  $4\frac{1}{2}$

Example 23

1 Decide if the following are Pythagorean triples.

**a** 3, 4, 6

**b** 4, 2, 5

**c** 5, 12, 13

Example 23

2 Decide if the following are Pythagorean triples.

**a** 9, 12, 15

**b** 8, 15, 17

**c** 2, 5, 6

**d** 9, 40, 41

**e** 10, 12, 20

**f** 4, 9, 12



3 Check that  $a^2 + b^2 = c^2$  for all these right-angled triangles. Write out the statement (e.g.  $3^2 + 4^2 = 5^2$ ) and check that the two sides are equal.

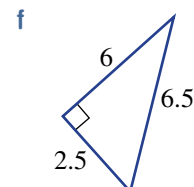
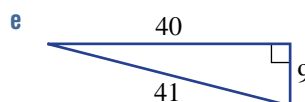
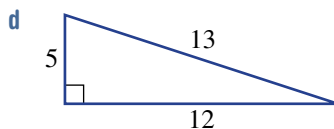
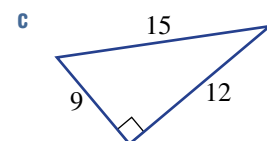
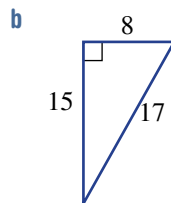
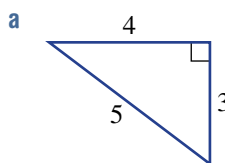

**Example 24** 4 Classify the following triangles as right-angled, acute or obtuse based on their side lengths. Note that the triangles are not drawn to scale.

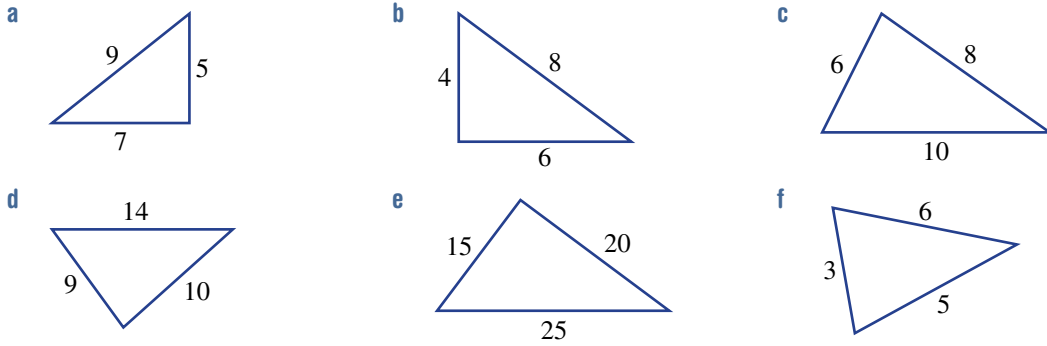

**PROBLEM-SOLVING** 5, 6 5, 6 6, 7

5 Write down an equation using the pronumerals given in these diagrams.

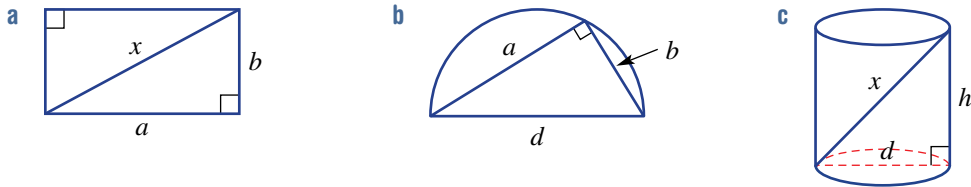

- 6 A cable connects the top of a 30 m mast to a point on the ground. The cable is 40 m long and connects to a point 20 m from the base of the mast.
- a Using  $c = 40$ , decide if  $a^2 + b^2 = c^2$ . (*Hint: Draw a diagram of the situation first.*)
- b Do you think the triangle formed by the mast and the cable is right angled? Give a reason.
- 7 (3, 4, 5) and (5, 12, 13) are Pythagorean triples since  $3^2 + 4^2 = 5^2$  and  $5^2 + 12^2 = 13^2$ .
- a Find 10 more Pythagorean triples using whole numbers all less than 100.
- b Find the total number of Pythagorean triples with whole numbers all less than 100.

**REASONING** 8 8, 9 9–11

- 8 An acute triangle has two shorter side lengths of 7 and 10. If the longest side length is also a whole number, what is the largest perimeter this triangle could have? Explain your answer.
- 9 If the side lengths of a triangle are all multiplied by the same positive number, the angles stay the same. Use this to explain why there are infinitely many Pythagorean triples.
- 10 If  $a^2 + b^2 = c^2$  is true, complete these statements.
- a  $c^2 - b^2 =$  \_\_\_\_\_
- b  $c^2 - a^2 =$  \_\_\_\_\_
- c  $c =$  \_\_\_\_\_

11 This triangle is isosceles. Write Pythagoras' theorem using the given pronumerals. Simplify if possible.

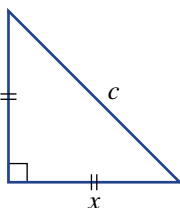

**ENRICHMENT: Pythagoras' proof** 12

12 There are many ways to prove Pythagoras' theorem, both algebraically and geometrically.

a Here is an incomplete proof of the theorem that uses this illustrated geometric construction.

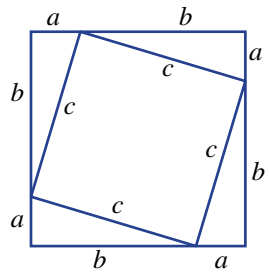

Area of inside square =  $c^2$

Area of 4 outside triangles =  $4 \times \frac{1}{2} \times \text{base} \times \text{height}$   
 = \_\_\_\_\_

Total area of outside square =  $(\text{_____} + \text{_____})^2$   
 =  $a^2 + 2ab + b^2$

Area of inside square = Area (outside square) – Area of 4 triangles  
 = \_\_\_\_\_ – \_\_\_\_\_  
 = \_\_\_\_\_

Comparing results from the first and last steps gives

$c^2 = \text{_____}$

b Use the internet to search for other proofs of Pythagoras' theorem. See if you can explain and illustrate them.

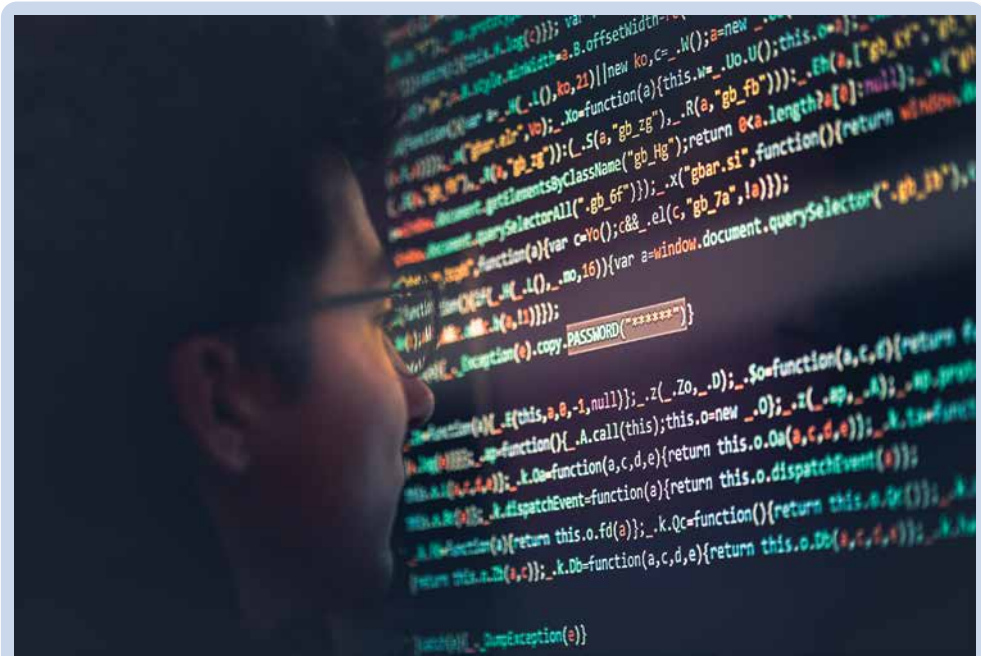

A type of cryptography uses Pythagorean triples together with divisibility tests and provides a secret key for unlocking data.

## 4L Using Pythagoras' theorem

### LEARNING INTENTIONS

- To be able to use Pythagoras' theorem to find the hypotenuse of a right-angled triangle
- To understand what a surd is
- To be able to apply Pythagoras' theorem to simple worded problems involving an unknown hypotenuse or diagonal

From our understanding of algebra, we know that equations can be solved to find the value of an unknown. This is also the case for equations derived from Pythagoras' theorem, where, if two of the side lengths of a right-angled triangle are known, then the third can be found.

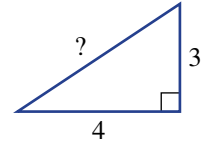

So if  $c^2 = 3^2 + 4^2$  then  $c^2 = 25$  and  $c = 5$ .

We also notice that if  $c^2 = 25$  then  $c = \sqrt{25} = 5$  (if  $c > 0$ ).

This use of Pythagoras' theorem has a wide range of applications wherever right-angled triangles can be drawn.

Note that a number using a  $\sqrt{\quad}$  sign may not always result in a whole number. For example,  $\sqrt{3}$  and  $\sqrt{24}$  are not whole numbers and neither can be written as a fraction, so they are irrational numbers. These types of numbers are called surds and they can be approximated using rounded decimals.



Marine engineers and builders use Pythagoras' theorem to calculate the length of a sloping boat ramp that will be above water at both low and high tides. Sloping boat ramps are used by fishermen and by people driving onto car ferries.

### Lesson starter: Correct layout

Three students who are trying to find the value of  $c$  in this triangle using Pythagoras' theorem write their solutions on a board. There are only very minor differences between each solution and the answer is written rounded to two decimal places. Which student has all the steps written correctly? Give reasons why the other two solutions are not laid out correctly.

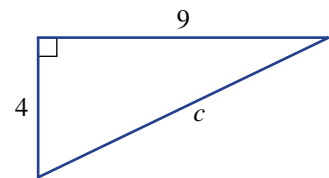

Student 1	Student 2	Student 3
$c^2 = a^2 + b^2$	$c^2 = a^2 + b^2$	$c^2 = a^2 + b^2$
$= 4^2 + 9^2$	$= 4^2 + 9^2$	$= 4^2 + 9^2$
$= 97$	$= 97$	$= 97$
$= \sqrt{97}$	$\therefore c = \sqrt{97}$	$= \sqrt{97}$
$= 9.85$	$= 9.85$	$= 9.85$

## KEY IDEAS

## ■ Using Pythagoras' theorem

- If  $c^2 = a^2 + b^2$ , then  $c = \sqrt{a^2 + b^2}$ .
- The final answer may not always result in a whole number. For example,  $\sqrt{3}$  and  $\sqrt{24}$  are not whole numbers.

■ **Surds** are numbers that have a  $\sqrt{\quad}$  sign when written in simplest form.

- They are not whole numbers and cannot be written as a fraction, so they are irrational numbers.
- Written as a decimal, the decimal places would continue forever with no repeated pattern (just like the number  $\pi$ ). Surds are therefore classified as irrational numbers.
- $\sqrt{2}$ ,  $\sqrt{5}$ ,  $2\sqrt{3}$  and  $\sqrt{90}$  are all examples of surds.

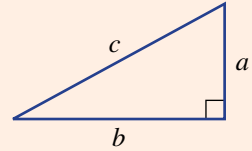

## ■ Note:

- $\sqrt{a^2 + b^2} \neq a + b$ , for example,  $\sqrt{3^2 + 4^2} \neq 3 + 4$
- If  $c^2 = k$ , then  $c = \sqrt{k}$  if  $c > 0$ .

## BUILDING UNDERSTANDING

1 Decide if these numbers written with a  $\sqrt{\quad}$  simplify to a whole number. Answer Yes or No.

a  $\sqrt{9}$

b  $\sqrt{11}$

c  $\sqrt{20}$

d  $\sqrt{121}$

2 Round these surds correct to two decimal places using a calculator.

a  $\sqrt{10}$

b  $\sqrt{26}$

c  $\sqrt{65}$

3 State the missing parts to complete this working out.

$$\begin{aligned} \text{a} \quad c^2 &= a^2 + b^2 \\ &= 5^2 + 12^2 \\ &= \underline{\quad} \\ \therefore c &= \sqrt{\underline{\quad}} \\ &= \underline{\quad} \end{aligned}$$

$$\begin{aligned} \text{b} \quad c^2 &= \underline{\quad} \\ &= 9^2 + 40^2 \\ &= \underline{\quad} \\ \therefore c &= \sqrt{\underline{\quad}} \\ &= \underline{\quad} \end{aligned}$$

## Example 25 Finding the length of the hypotenuse

Find the length of the hypotenuse for these right-angled triangles. Round the answer for part **b** to two decimal places.

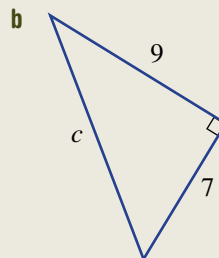
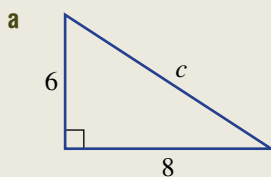



**SOLUTION**

$$\begin{aligned} \mathbf{a} \quad c^2 &= a^2 + b^2 \\ &= 6^2 + 8^2 \\ &= 100 \\ \therefore c &= \sqrt{100} \\ &= 10 \end{aligned}$$

$$\begin{aligned} \mathbf{b} \quad c^2 &= a^2 + b^2 \\ &= 7^2 + 9^2 \\ &= 130 \\ \therefore c &= \sqrt{130} \\ &= 11.40 \text{ (to 2 d.p.)} \end{aligned}$$

**EXPLANATION**

Write the equation for Pythagoras' theorem and substitute the values for the shorter sides.

Find  $c$  by taking the square root.

First calculate the value of  $7^2 + 9^2$ .

$\sqrt{130}$  is a surd, so round the answer as required. A calculator can be used to find this answer.

**Now you try**

Find the length of the hypotenuse for these right-angled triangles. Round the answer for part **b** to two decimal places.

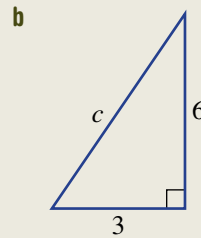
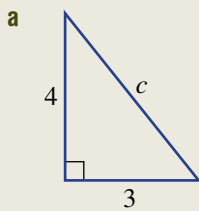
**Example 26 Applying Pythagoras' theorem to find the hypotenuse**

A rectangular wall is to be strengthened by a diagonal brace. The wall is 6 m wide and 3 m high. Find the length of brace required correct to the nearest cm.

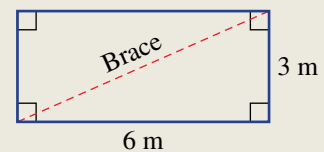
**SOLUTION**

$$\begin{aligned} c^2 &= a^2 + b^2 \\ &= 3^2 + 6^2 \\ &= 45 \\ \therefore c &= \sqrt{45} \\ &= 6.71 \text{ m or } 671 \text{ cm (to nearest cm)} \end{aligned}$$

The length of the brace is 6.71 metres.

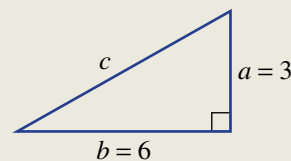
**EXPLANATION**

Write your answer in a sentence.

**Now you try**

A rectangular wall is 5 m wide and 4 m high. Find the length of a diagonal brace correct to the nearest cm.

## Exercise 4L

### FLUENCY

1, 2–3( $\frac{1}{2}$ )

2–3( $\frac{1}{2}$ )

2–3( $\frac{1}{3}$ )

Example 25a



- 1 Find the length of the hypotenuse for these right-angled triangles.

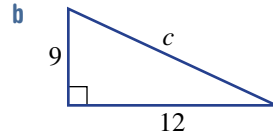
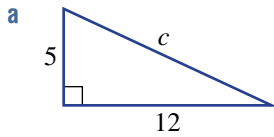

Example 25a



- 2 Find the length of the hypotenuse of these right-angled triangles.

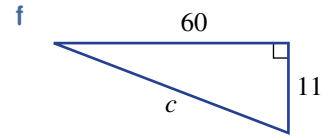
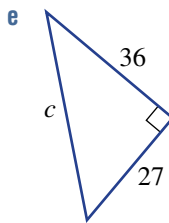
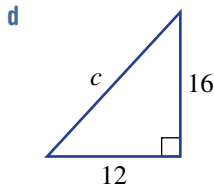
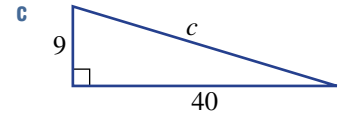
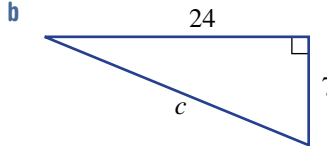
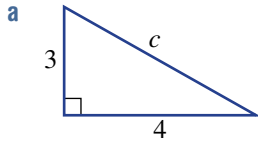

Example 25b



- 3 Find the length of the hypotenuse of these right-angled triangles correct to two decimal places.

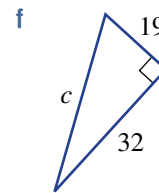
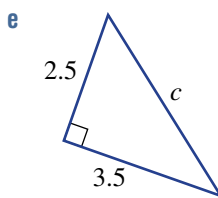
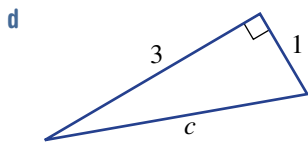
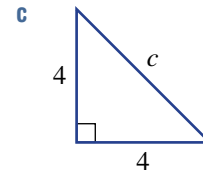
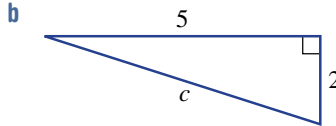
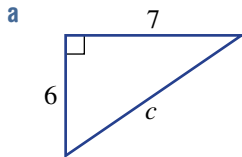

### PROBLEM-SOLVING

4, 5

5–7

5–7

Example 26



- 4 A rectangular board is to be cut along one of its diagonals. The board is 1 m wide and 3 m high. What will be the length of the cut, correct to the nearest cm?

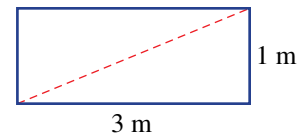

- 5 The size of a television screen is determined by its diagonal length. Find the size of a television screen that is 1.2 m wide and 70 cm high. Round the answer to the nearest cm.

- 6 Here is a diagram showing the path of a bushwalker from Camp 1 to Camp 2. Find the total distance rounded to one decimal place.

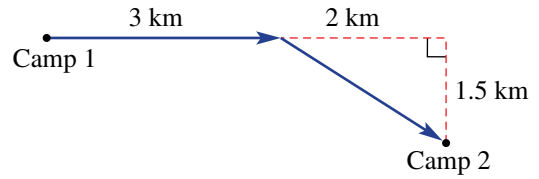

- 7 A 20 cm straw sits in a cylindrical glass as shown. What length of straw sticks above the top of the glass? Round the answer to two decimal places.

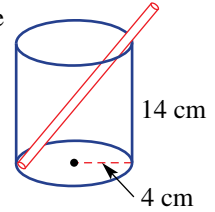

**REASONING**

8

8, 9

9–11

- 8 Explain the error in each set of working.

a  $c^2 = 2^2 + 3^2$   
 $\therefore c = 2 + 3$   
 $= 5$

b  $c^2 = 3^2 + 4^2$   
 $= 7^2$   
 $= 49$   
 $\therefore c = 7$

c  $c^2 = 2^2 + 5^2$   
 $= 4 + 25$   
 $= 29$   
 $= \sqrt{29}$

- 9 An isosceles triangle can be split into two right-angled triangles. Pythagoras' theorem can be used to find side lengths.

- a Use this method to find  $c$  in the triangle shown, with base 6 and height 4.

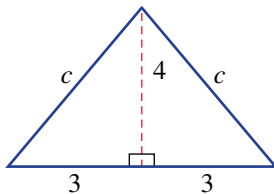

- b Hence, find the perimeter of this isosceles triangle.  
 c Use a similar technique to find the perimeter of the kite shown.

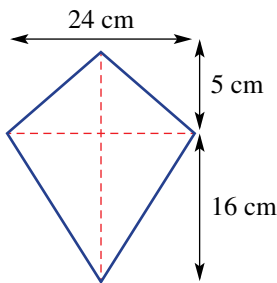

10 Prove that these are not right-angled triangles.

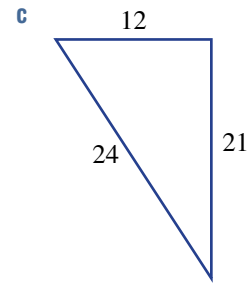
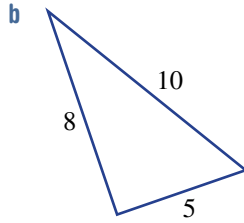
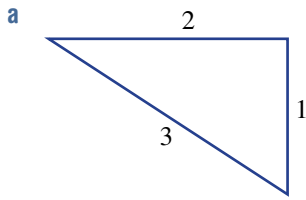

- 11 a Can an isosceles triangle be right-angled? Explain why or why not.  
 b Can an equilateral triangle be right-angled? Explain why or why not.

**ENRICHMENT: Perimeter and Pythagoras**      -      -      12

12 Find the perimeter of these shapes, correct to two decimal places.

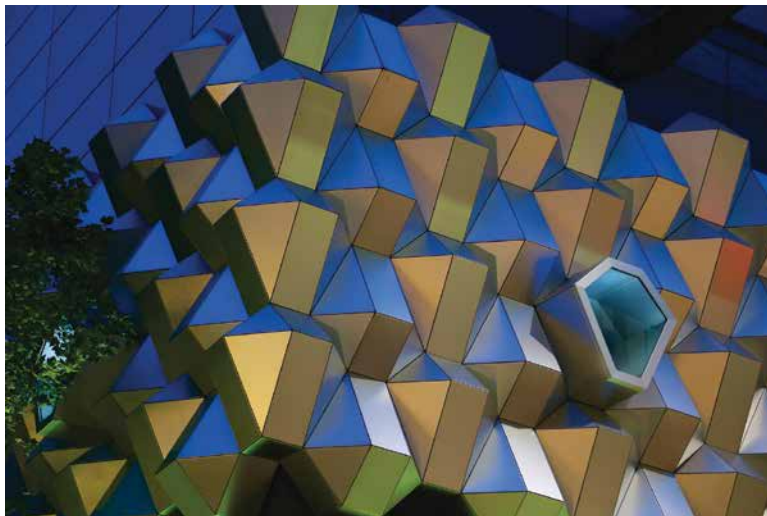
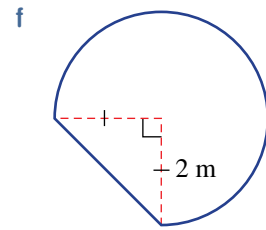
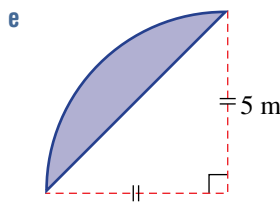
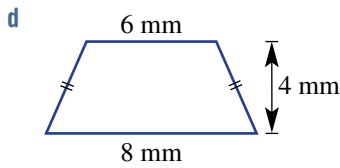
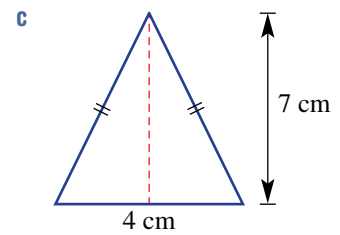
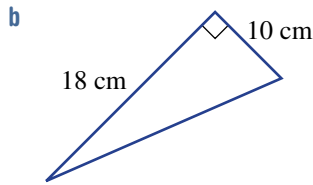
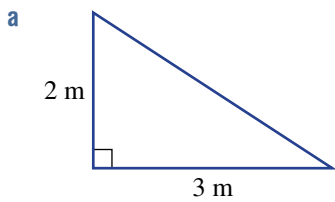

## 4M Calculating the length of a shorter side

### LEARNING INTENTIONS

- To be able to use Pythagoras' theorem to find the length of a shorter side in a right-angled triangle
- To be able to apply Pythagoras' theorem to simple worded problems involving an unknown shorter side

We know that if we are given the two shorter sides of a right-angled triangle we can use Pythagoras' theorem to find the length of the hypotenuse. Generalising further, we can say that if given *any* two sides of a right-angled triangle, we can use Pythagoras' theorem to find the length of the third side.



Firefighters can use Pythagoras' theorem to find the vertical height that a ladder can reach up a wall, from knowing the ladder's length and its distance to the base of the wall.

### Lesson starter: What's the setting out?

The triangle shown has a hypotenuse length of 15 and one of the shorter sides is of length 12. Here is the setting out to find the length of the unknown side  $a$ .

Fill in the missing gaps and explain what is happening at each step.

$$\begin{aligned}
 a^2 + b^2 &= c^2 \\
 a^2 + \underline{\quad}^2 &= \underline{\quad}^2 \\
 a^2 + \underline{\quad} &= \underline{\quad} \\
 a^2 &= \underline{\quad} \text{ (Subtract } \underline{\quad} \text{ from both sides)} \\
 \therefore a &= \sqrt{\underline{\quad}} \\
 &= \underline{\quad}
 \end{aligned}$$

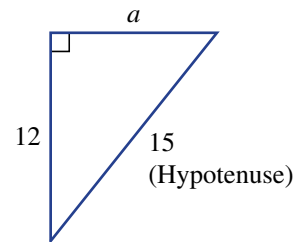

### KEY IDEAS

- Pythagoras' theorem can be used to find the length of the shorter sides of a right-angled triangle if the length of the hypotenuse and another side are known.
- Use subtraction to make the unknown the subject of the equation.

For example:

$$\begin{aligned}
 a^2 + b^2 &= c^2 \\
 a^2 + 24^2 &= 25^2 \\
 a^2 + 576 &= 625 \\
 a^2 &= 49 \text{ (Subtract 576 from both sides.)} \\
 \therefore a &= \sqrt{49} \\
 &= 7
 \end{aligned}$$

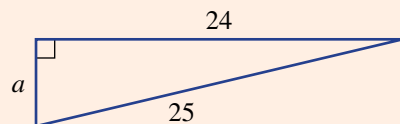

## BUILDING UNDERSTANDING

1 Find the value of  $a$  in these equations. (Assume  $a$  is a positive number.)

a  $a^2 = 16$

b  $a^2 + 16 = 25$

c  $a^2 + 36 = 100$

d  $a^2 + 441 = 841$

e  $10 + a^2 = 19$

f  $6 + a^2 = 31$

2 State the missing numbers to complete the following working.

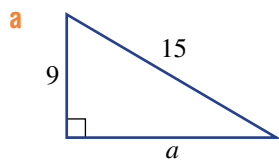

$$\begin{aligned} a^2 + b^2 &= c^2 \\ a^2 + 9^2 &= \_\_\_\_\_\_ \\ a^2 + \_\_\_\_\_\_ &= 225 \\ a^2 &= \_\_\_\_\_\_ \\ \therefore a &= \sqrt{\_\_\_\_\_\_} \\ &= \_\_\_\_\_\_ \end{aligned}$$

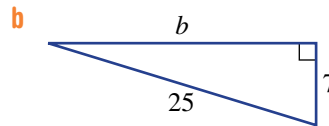

$$\begin{aligned} a^2 + b^2 &= c^2 \\ 7^2 + 9^2 &= \_\_\_\_\_\_ \\ \_\_\_\_\_\_ + b^2 &= \_\_\_\_\_\_ \\ b^2 &= 576 \\ \therefore b &= \sqrt{\_\_\_\_\_\_} \\ &= \_\_\_\_\_\_ \end{aligned}$$



### Example 27 Finding the length of a shorter side

Find the length of the unknown side in this right-angled triangle.

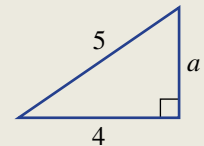

#### SOLUTION

$$\begin{aligned} a^2 + b^2 &= c^2 \\ a^2 + 4^2 &= 5^2 \\ a^2 + 16 &= 25 \\ a^2 &= 9 \\ \therefore a &= \sqrt{9} \\ &= 3 \end{aligned}$$

#### EXPLANATION

Write the equation using Pythagoras' theorem and substitute the known values.

Subtract 16 from both sides. Find  $a$  by taking the square root.

#### Now you try

Find the length of the unknown side in this right-angled triangle.

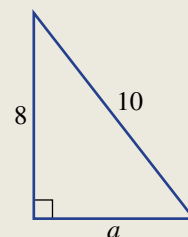



### Example 28 Applying Pythagoras' theorem to find a shorter side

A 10 m steel brace holds up a concrete wall. The bottom of the brace is 5 m from the base of the wall. Find the height of the concrete wall correct to two decimal places.

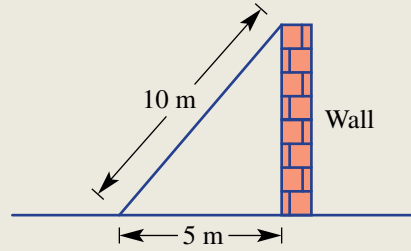

#### SOLUTION

Let  $a$  metres be the height of the wall.

$$a^2 + b^2 = c^2$$

$$a^2 + 5^2 = 10^2$$

$$a^2 + 25 = 100$$

$$a^2 = 75$$

$$\therefore a = \sqrt{75}$$

$$= 8.66 \text{ (to 2 d.p.)}$$

The height of the wall is 8.66 metres.

#### EXPLANATION

Choose a letter (pronumeral) for the unknown height.

Substitute into Pythagoras' theorem.

Subtract 25 from both sides.

$\sqrt{75}$  is the exact answer.

Round as required.

Answer a worded problem using a full sentence.

#### Now you try

A 7 m ladder is placed 3 m from the base of a wall as shown. Find the height of the wall correct to two decimal places.

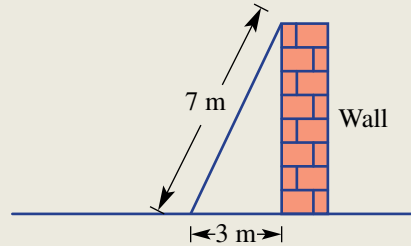

## Exercise 4M

### FLUENCY

1, 2-3(1/2)

2-3(1/2)

2(1/2), 3(1/3)

Example 27



1 Find the length of the unknown side in these right-angled triangles.

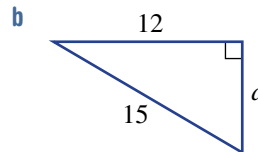
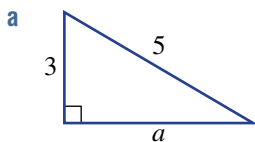

**Example 27** 2 Find the length of the unknown side in these right-angled triangles.

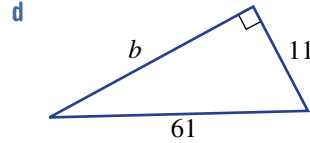
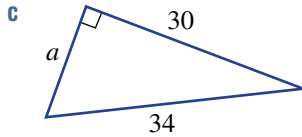
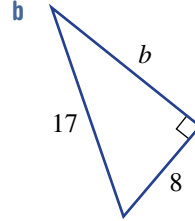
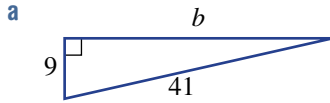

**Example 28** 3 Find the length of the unknown side in these right-angled triangles, giving the answer correct to two decimal places.

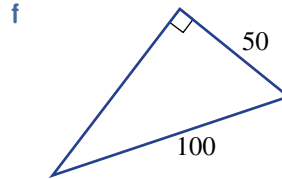
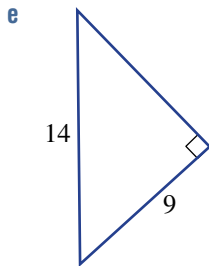
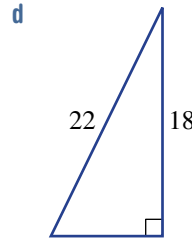
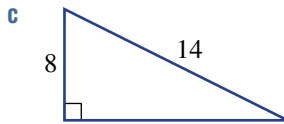
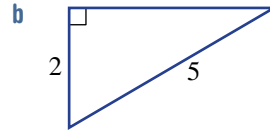
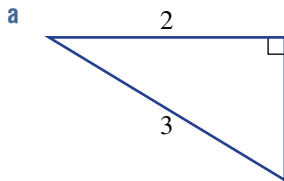

**PROBLEM-SOLVING**

4-6

4-7

5-8

**Example 28** 4 A yacht's mast is supported by a 12 m cable attached to its top. On the deck of the yacht, the cable is 8 m from the base of the mast. How tall is the mast? Round the answer to two decimal places.

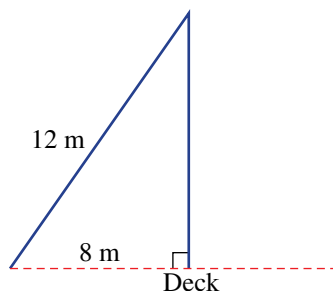



- 5 A circle's diameter  $AC$  is 15 cm and the chord  $AB$  is 9 cm. Angle  $ABC$  is  $90^\circ$ . Find the length of the chord  $BC$ .

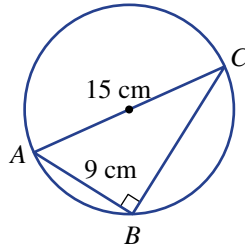

- 6 A 14 cm drinking straw just fits into a can as shown. The diameter of the can is 7 cm. Find the height of the can correct to two decimal places.

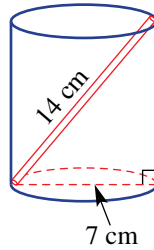

- 7 Find the length  $AB$  in this diagram. Round to two decimal places.

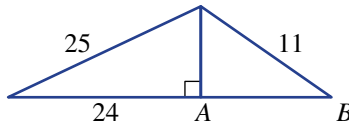

- 8 To cut directly through a rectangular field from  $A$  to  $B$ , the distance is 100 metres. The path from  $A$  to  $C$  is 80 metres. Find how much further a person travels by walking  $A \rightarrow C \rightarrow B$  compared to directly  $A \rightarrow B$ .

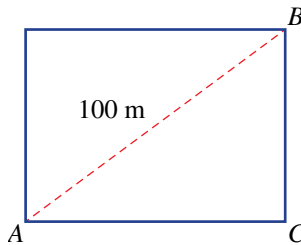

**REASONING** 9      9, 10      10-12

9 Describe what is wrong with the second line of working in each step.

a  $a^2 + 10 = 24$   
 $a^2 = 34$

b  $a^2 = 25$   
 $= 5$

c  $a^2 + 25 = 36$   
 $a + 5 = 6$

10 An isosceles triangle can be split into two right-angled triangles. Use this to find  $x$  and the perimeter of the triangle shown.

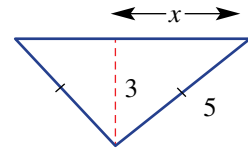

11 The number  $\sqrt{11}$  is an example of a surd that is written as an exact value. Find the surd that describes the exact lengths of the unknown sides of these triangles.

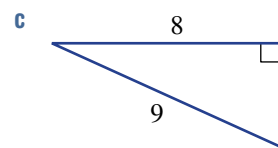
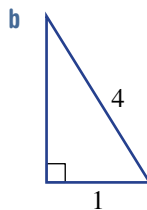
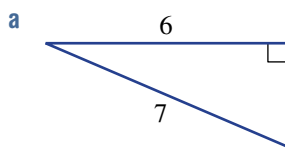

12 Show how Pythagoras' theorem can be used to find the unknown length in these isosceles triangles. Complete the solution for part a and then try the others. Round to two decimal places.

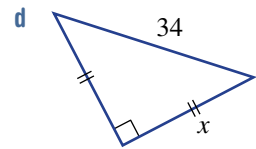
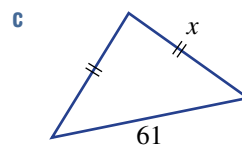
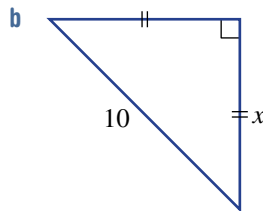
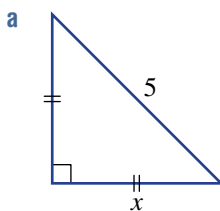

$$a^2 + b^2 = c^2$$

$$x^2 + x^2 = 5^2$$

$$2x^2 = 25$$

$$x^2 = \underline{\hspace{1cm}}$$

$$\therefore x = \sqrt{\underline{\hspace{1cm}}}$$

**ENRICHMENT: Pythagorean families** -      -      13

13 Recall that (3, 4, 5) is called a Pythagorean triple because the numbers 3, 4 and 5 satisfy Pythagoras' theorem ( $3^2 + 4^2 = 5^2$ ).

- a Explain why (6, 8, 10) is also a Pythagorean triple.
- b Explain why (6, 8, 10) is considered to be in the same family as (3, 4, 5).
- c List three other Pythagorean triples in the same family as (3, 4, 5) and (6, 8, 10).
- d Find another triple not in the same family as (3, 4, 5), but has all three numbers less than 20.
- e List five triples that are each the smallest triple of five different families.

## Carving table legs

Kosta is carving cylindrical table legs out of square 10 cm by 10 cm wood poles, each of length 1.2 metres. The cross-section of the pole is shown in this diagram. He uses a wood lathe to remove the timber outside the circle, leaving a timber cylinder of radius  $r$  cm and length 1.2 metres.

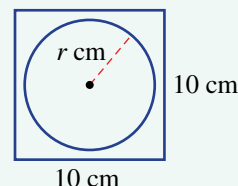

Present a report for the following tasks and ensure that you show clear mathematical working and explanations where appropriate. Round measurements to two decimal places.

### Preliminary task

- Find the volume of the original 10 cm by 10 cm pole of length 1.2 m. Give your answer in cubic centimetres, ensuring you first convert all dimensions to the same unit.
- If the radius of the circular cross-sectional area of the carved pole is 3 cm, find:
  - the cross-sectional area of the carved pole
  - the volume of the carved pole
  - the volume of wood wasted in the process
  - the percentage of wood wasted in the process.

### Modelling task

- |                     |  |
|---------------------|--|
| Formulate           | <b>a</b> The problem is to determine the radius of the carved pole so that no more than 25% of the original timber pole is wasted. Write down all the relevant information that will help to solve this problem with the aid of one or more diagrams.  |
| Solve               | <b>b</b> By first calculating areas, determine the volume of timber wasted if the carved pole is created using the following radii: <ol style="list-style-type: none"> <li>2 cm</li> <li>3 cm</li> <li>4 cm.</li> </ol> <p><b>c</b> By calculating the percentage of timber wasted, decide if any of the three radii above satisfy the requirement that no more than 25% of the timber can be wasted.</p> <p><b>d</b> If the largest cylinder possible is created, determine the percentage of timber wasted.</p>                            |
| Evaluate and verify | Kosta likes to waste slightly more than the absolute minimum amount of timber because there is a better chance of producing a smoother finish. He therefore aims for a figure closer to 25% timber wastage. <p><b>e</b> Explain why you only need to consider the cross-sectional area of the pole rather than looking at the entire volume to solve this problem.</p> <p><b>f</b> Use trial and error to determine the radius that Kosta should aim for to achieve a 25% timber wastage, correct to as many decimal places as possible.</p> |
| Communicate         | <b>g</b> Summarise your results and describe any key findings.   |

### Extension questions

- Write an expression for the percentage of timber wasted if the radius of the pole is  $r$  cm.
- By using your expression from part **a**, outline a direct method for finding the radius of the pole that delivers exactly 25% timber wastage.
- Find, correct to three decimal places, the value of  $r$  that would result in 50% of the wood being wasted.

## Approximating a circle with 2 squares

### Key technology: Dynamic geometry and spreadsheets

We know that to find the area of a circle precisely we use the irrational number  $\pi$ , which is an infinitely non-recurring decimal and part of the area formula  $A = \pi r^2$ . The area of a circle can, however, be approximated using squares and Pythagoras' theorem using the circle's radius only.

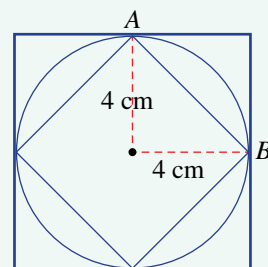

### 1 Getting started

Consider this circle of radius 4 cm and the two squares constructed as shown.

- State the side length of the larger square.
- Use Pythagoras' theorem to find the side length of the smaller square  $AB$ .
- Find the areas of both squares.
- Find the average of the areas of the two squares. This is your approximation to the area of the circle.
- Use the formula for the area of a circle,  $A = \pi r^2$ , and compare this to your approximation found in part **d** above.
- Repeat parts **b** to **e** above using a radius of 5 cm.

### 2 Using technology

- Construct a dynamic circle similar to above using a dynamic geometry package like Desmos Geometry. Follow these steps.
  - Step 1: Construct a segment  $AC$  and centre  $O$  as the midpoint.
  - Step 2: Construct the circle with centre  $O$  and radius  $OC$ .
  - Step 3: Construct the perpendicular line  $BD$  and the points  $B$  and  $D$ .
  - Step 4: Construct the perpendicular lines to form the larger square.
  - Step 5: Construct the smaller and larger squares using the Polygon tool.
  - Step 6: Find the areas of the smaller and larger squares.
- Find the average of the two areas calculated in your construction above. This is your approximation to the area of the circle.
- Drag one of your starting points  $A$  or  $C$  to alter the size of the circle and change the areas of the squares. Recalculate the average of the areas of the two squares.

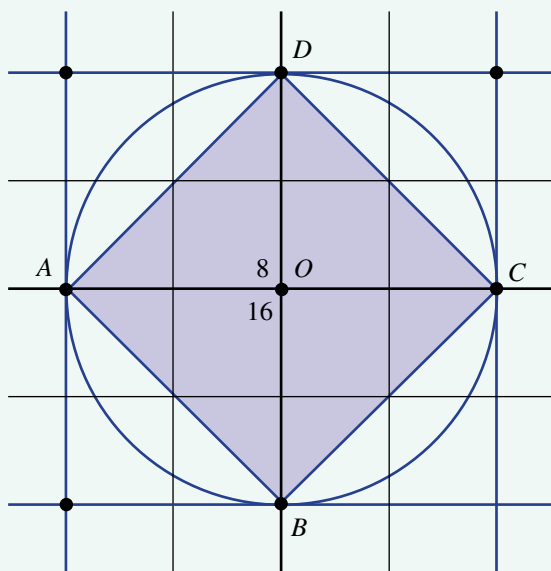

### 3 Applying an algorithm

We note that if the radius of the circle is  $r$ , then the side length of the area of the larger square  $l_1$  is given by  $l_1 = 2r$  and the smaller square  $l_2$  is given by  $l_2 = \sqrt{r^2 + r^2} = \sqrt{2r^2} = \sqrt{2}r$ .

- a Use these above formulas to set up a spreadsheet to approximate the area of a circle as follows.

	A	B	C
1	Approximating circles with squares		
2			
3	Circle radius	Approximation	Exact
4	1	$= (4 * A4^2 + (\text{SQRT}(2) * A4)^2) / 2$	$= \text{PI}() * A4^2$
5	$= A4 + 1$		

- b Fill down at cells A5, B4 and C4. Compare your approximation for the area of the circle with the more exact values in column C, which uses the  $A = \pi r^2$  formula. You can see that your approximation is always less than the exact area. Follow this algorithm to search for a particular percentage increase that is required to bring the approximation closer to the exact.
- c In cell D3, enter a chosen percentage increase and in cell D4, calculate a new approximation using the given formula. Fill down at cell D4.
- d Follow this algorithm to find an accurate percentage increase that gives a precise approximation to the area of a circle.
- Step 1: Change the percentage increase value in cell D3 to a different value.
  - Step 2: Compare the approximate area values in column D to the exact values in columns C.
  - Step 3: Decrease the percentage increase value in cell D3 if the approximation is too large or increase the percentage increase value in cell D3 if the approximation is too small.
  - Step 4: Repeat from Step 2 until you have found a percentage increase that makes your area approximation accurate to two decimal places.
- e Persist with your algorithm above until you have found a percentage increase that makes your area approximation accurate to 3 or 4 decimal places. Compare your result with a friend.

D
% increase
5
$= B4 * (1 + D\$3 / 100)$

### 4 Extension

- a Using a circle of radius  $r$ , prove that the average of the areas of the two squares studied above is given by  $A = 3r^2$ . You will need to use Pythagoras' theorem and find the areas of each square in terms of  $r$ .
- b Calculate the percentage increase required in part 3d above by using this percentage increase formula.

$$\% \text{ increase} = \frac{\text{increase}}{\text{approx.}} \times \frac{100}{1} = \frac{\text{exact} - \text{approx.}}{\text{approx.}} \times \frac{100}{1}.$$

Use the results in one of the rows in your spreadsheet for the values of exact and approx. Compare your answer to the result from part 3e above.

- c Using a circle of radius  $r$ , prove that the result in part 3b above is given by  $\frac{100(\pi - 3)}{3}$ .

## GMT and travel

As discussed in **Section 4J**, the world is divided into 24 time zones, which are determined loosely by each  $15^\circ$  meridian of longitude. World time is based on the time at a place called Greenwich, which is near London, United Kingdom. This time is called Coordinated Universal Time (UTC) or Greenwich Mean Time (GMT). Places east of Greenwich are ahead in time and places west of Greenwich are behind. In Australia, the Western Standard Time is 2 hours behind Eastern Standard Time and Central Standard Time is  $\frac{1}{2}$  hour behind Eastern Standard Time. Use the world time zone map on pages 296–7 to answer these questions and to investigate how the time zones affect the time when we travel.

- 1 Name five countries that are:
  - a ahead of GMT
  - b behind GMT.
- 2 When it is noon in Greenwich, what is the time in these places?
  - a Sydney
  - b Perth
  - c Darwin
  - d Washington, DC
  - e Auckland
  - f France
  - g Johannesburg
  - h Japan
- 3 When it is 2 p.m. Eastern Standard Time (EST) on Wednesday, find the time and day in these places.
  - a Perth
  - b Adelaide
  - c London
  - d Western Canada
  - e China
  - f United Kingdom
  - g Alaska
  - h South America

## Adjusting your watch

- 4 Do you adjust your watch forwards or backwards when you are travelling to these places?
  - a India
  - b New Zealand
- 5 In what direction should you adjust your watch if you are flying over the Pacific Ocean?



## Flight travel

- 6 You fly from Perth to Brisbane on a 4-hour flight that departed at noon. What is the time in Brisbane when you arrive?
- 7 You fly from Melbourne to Edinburgh on a 22-hour flight that departed at 6 a.m. What is the time in Edinburgh when you arrive?
- 8 You fly from Sydney to Los Angeles on a 13-hour flight that departed at 7:30 p.m. What is the time in Los Angeles when you arrive?
- 9 Copy and complete the following table.

Departing	Arriving	Departure time	Flight time (hours)	Arrival time
Brisbane	Broome	7 a.m.	3.5	
Melbourne	London	1 p.m.	23	
Hobart	Adelaide		1.5	4 p.m.
London	Tokyo		12	11 p.m.
New York	Sydney		15	3 a.m.
Beijing	Vancouver	3:45 p.m.		7:15 p.m.

- 10 Investigate how daylight saving alters the time in some time zones and why. How does this affect flight travel? Give examples.



- 1 A cube has capacity 1 L. What are its dimensions in cm, correct to one decimal place?

Up for a challenge? If you get stuck on a question, check out the 'Working with unfamiliar problems' poster at the end of the book to help you.



- 2 A fish tank is 60 cm long, 30 cm wide, 40 cm high and contains 70 L of water. Rocks with a volume of  $3000 \text{ cm}^3$  are placed into the tank. Will the tank overflow?
- 3 What proportion (fraction or percentage) of the semicircle does the full circle occupy?

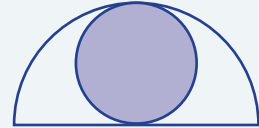

- 4 What is the distance  $AB$  in this cube? (*Hint*: Pythagoras' theorem is required.)

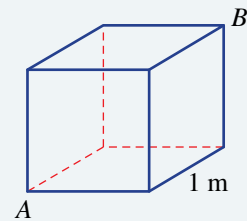

- 5 By what number do you multiply the radius of a circle to double its area?
- 6 Find the exact value (as a surd) of  $a$  in this diagram. (*Hint*: Pythagoras' theorem is required.)

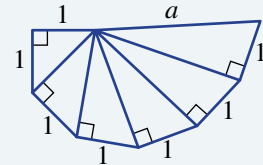

- 7 A cube of side length 3 cm has its core removed in all directions as shown. Find its total surface area both inside and out.

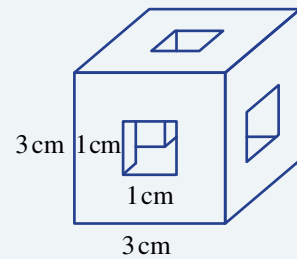

- 8 A square just fits inside a circle. What percentage of the circle is occupied by the square?

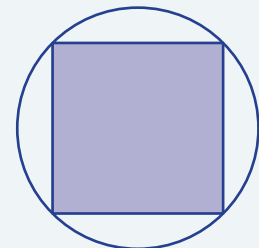



**Quadrilaterals**  
 Square  $A = l^2$   
 Rectangle  $A = lw$   
 Parallelogram  $A = bh$   
 Rhombus  $A = xy$   
 Kite  $A = xy$   
 Trapezium  $A = (a + b)h$

$\pi$   
 $\pi$   
 $\pi$

**Circumference**  
 $C = 2\pi r$  or  $\pi d$   
 $= 2 \times \pi \times 3$   
 $= 6\pi$  m

Length

Measurement

Pythagoras' theorem

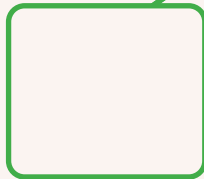

$\pi r^2 h$   
 $\pi$

$\theta$   $\pi$   
 $\pi$

$\sqrt{\quad}$

$\sqrt{\quad}$

# Chapter checklist with success criteria

A printable version of this checklist is available in the Interactive Textbook

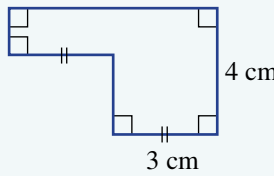
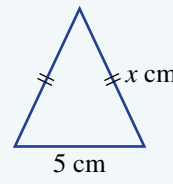
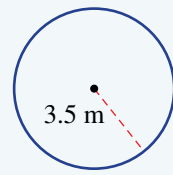
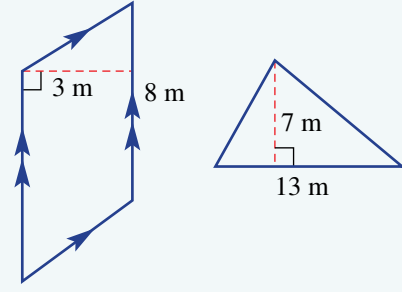
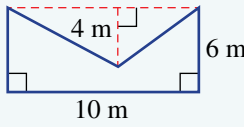

4A	<p><b>1. I can convert length measurements.</b> e.g. Convert 5.2 cm to mm, and 85 000 cm to km.</p>	<input type="checkbox"/>
4A	<p><b>2. I can find the perimeter of a shape.</b> e.g. Find the perimeter of this shape.</p> 	<input type="checkbox"/>
4A	<p><b>3. I can find unknown side lengths in a shape given the perimeter.</b> e.g. Find the value of <math>x</math> given that this triangle's perimeter is 19 cm.</p> 	<input type="checkbox"/>
4B	<p><b>4. I can find the circumference of a circle using a calculator.</b> e.g. Find the circumference of this circle to two decimal places, using a calculator for the value of <math>\pi</math>.</p> 	<input type="checkbox"/>
4B	<p><b>5. I can find the circumference of a circle without a calculator, using an approximation of <math>\pi</math>.</b> e.g. Find the circumference of circle with a diameter of 10 metres using the approximation <math>\pi = 3.14</math>.</p>	<input type="checkbox"/>
4C	<p><b>6. I can convert units of area.</b> e.g. Convert <math>0.248\text{m}^2</math> to <math>\text{cm}^2</math>.</p>	<input type="checkbox"/>
4C	<p><b>7. I can find the area of simple shapes (rectangles, parallelograms, triangles).</b> e.g. Find the area of these shapes.</p> 	<input type="checkbox"/>
4C	<p><b>8. I can find the area of composite shapes.</b> e.g. Find the area of this composite shape using addition or subtraction.</p> 	<input type="checkbox"/>

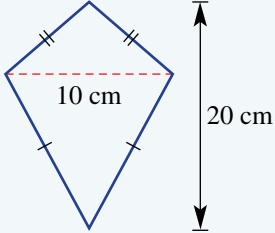
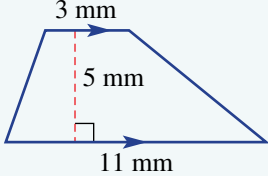
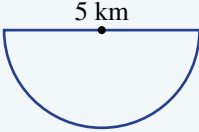
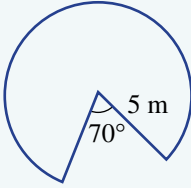
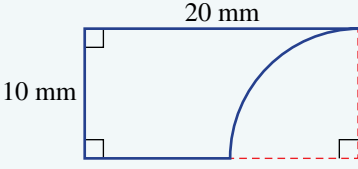
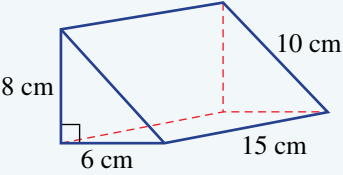
4D	<p><b>9. I can find the area of rhombuses and kites.</b> e.g. Find the area of this shape.</p> 	<p style="text-align: right;">✓</p> <input type="checkbox"/>
4D	<p><b>10. I can find the area of trapeziums.</b> e.g. Find the area of this shape.</p> 	<input type="checkbox"/>
4E	<p><b>11. I can find the area of circles using a calculator.</b> e.g. Find the area of a circle that has a radius of 2 cm, correct to two decimal places.</p>	<input type="checkbox"/>
4E	<p><b>12. I can find the approximate area of circles without a calculator.</b> e.g. Find the area of a circle that has a radius of 7 m, using the approximate value of <math>\pi = \frac{22}{7}</math>.</p>	<input type="checkbox"/>
4E	<p><b>13. I can find the area of semicircles and quadrants.</b> e.g. Find the area of this semicircle, correct to two decimal places.</p> 	<input type="checkbox"/>
4F	<p><b>14. I can find the area of sectors.</b> e.g. Find the area of this sector, correct to two decimal places.</p> 	<p style="text-align: right;">Ext</p> <input type="checkbox"/>
4F	<p><b>15. I can find the area of composite shapes involving sectors.</b> e.g. Find the area of this composite shape, correct to the nearest whole number of <math>\text{mm}^2</math>.</p> 	<p style="text-align: right;">Ext</p> <input type="checkbox"/>
4G	<p><b>16. I can find the surface area of a prism.</b> e.g. Find the surface area of this prism.</p> 	<p style="text-align: right;">Ext</p> <input type="checkbox"/>

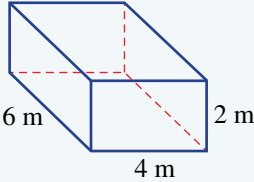
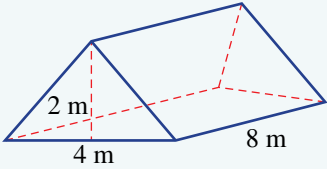
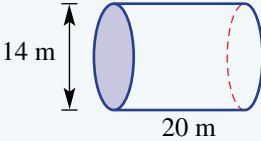
		✓
4H	<p><b>17. I can find the volume of a rectangular prism.</b> e.g. Find the volume of this rectangular prism.</p> 	<input type="checkbox"/>
4H	<p><b>18. I can find the capacity of a rectangular prism.</b> e.g. Find the capacity, in litres, for a container that is a rectangular prism 20 cm long, 10 cm wide and 15 cm high.</p>	<input type="checkbox"/>
4I	<p><b>19. I can find the volume of a prism.</b> e.g. Find the volume of this prism.</p> 	<input type="checkbox"/>
4I	<p><b>20. I can find the volume of a cylinder.</b> e.g. Find the volume of this cylinder, rounding to two decimal places.</p> 	<input type="checkbox"/>
4J	<p><b>21. I can convert between different units of time.</b> e.g. Convert 3 days to minutes.</p>	<input type="checkbox"/>
4J	<p><b>22. I can convert between 24-hour time and a.m./p.m.</b> e.g. Write 4:30 p.m. in 24-hour time and 1945 hours in a.m./p.m.</p>	<input type="checkbox"/>
4J	<p><b>23. I can use time zones.</b> e.g. Use a world time zone map to find the time in London when it is 9:35 a.m. in New South Wales, Australia.</p>	<input type="checkbox"/>
4K	<p><b>24. I can decide if three numbers form a Pythagorean triple.</b> e.g. Decide if 6, 8, 10 is a Pythagorean triple.</p>	<input type="checkbox"/>
4K	<p><b>25. I can classify a triangle as right-angled, acute or obtuse.</b> e.g. A triangle has side lengths 4 m, 7 m and 9 m. Decide if it is right-angled, acute or obtuse.</p>	<input type="checkbox"/>

4L

26. I can find the length of the hypotenuse of a right-angled triangle.

e.g. Find the length of  $c$  correct to two decimal places.

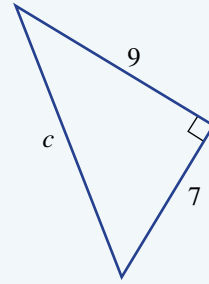

4L

27. I can identify the diagonal of a rectangle as the hypotenuse of a right-angled triangle and find its length.

e.g. Find the length of this diagonal brace, to the nearest centimetre.

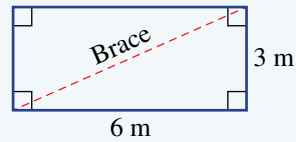

4M

28. I can find the length of a shorter side in a right-angled triangle.

e.g. Find the value of  $a$ .

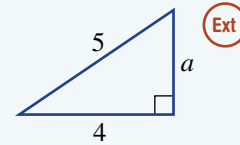

### Short-answer questions

4A

- 1 Convert these measurements to the units given in the brackets.
- |  |  |                                      |  |
|--|--|--------------------------------------|--|
| a 2m (mm)                              | b 50 000 cm (km)                       | c $3 \text{ cm}^2$ ( $\text{mm}^2$ ) | d $4000 \text{ cm}^2$ ( $\text{m}^2$ ) |
| e $0.01 \text{ km}^2$ ( $\text{m}^2$ ) | f $350 \text{ mm}^2$ ( $\text{cm}^2$ ) | g $400 \text{ cm}^3$ (L)             | h $0.2 \text{ m}^3$ (L)                |

4A/B



- 2 Find the perimeter/circumference of these shapes. Round the answer to two decimal places where necessary.

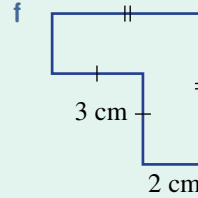
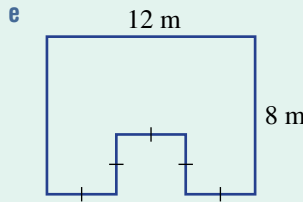
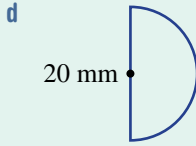
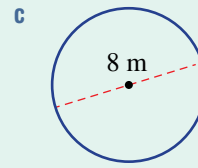
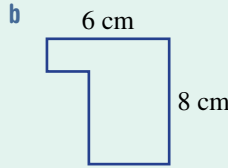
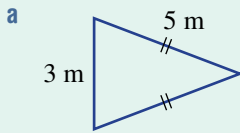

4C/D/E



- 3 Find the area of these shapes. Round the answer to two decimal places where necessary.

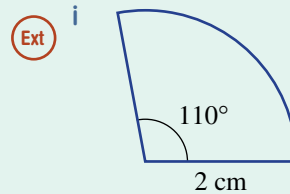
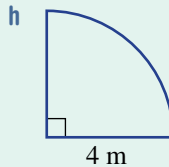
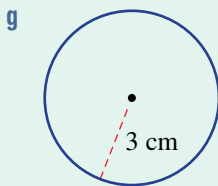
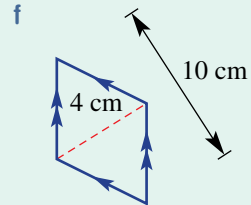
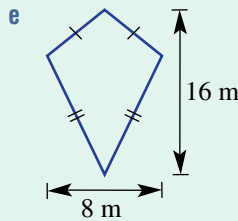
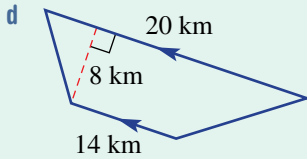
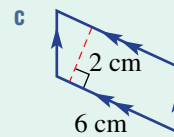
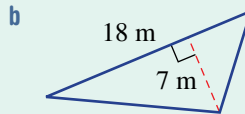
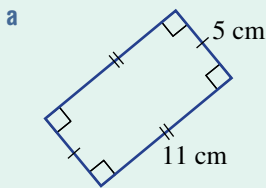

4F



- 4 Find the area of these composite shapes. Round the answer to two decimal places where necessary.

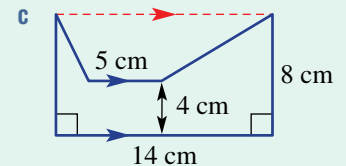
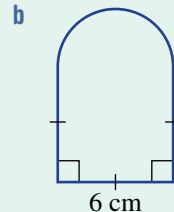
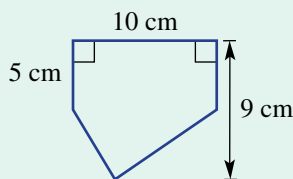

4G

- 5 Find the surface area of each prism.

Ext

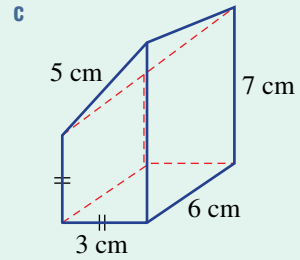
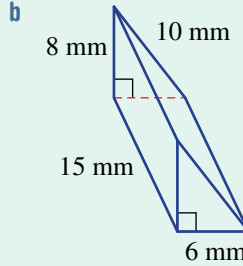
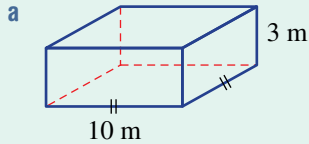

4H/I

- 6 Find the volume of each prism, giving your answer in litres. Remember
- $1\text{ L} = 1000\text{ cm}^3$
- and
- $1\text{ m}^3 = 1000\text{ L}$
- .

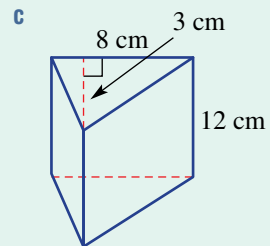
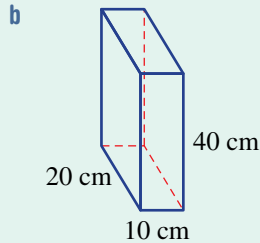
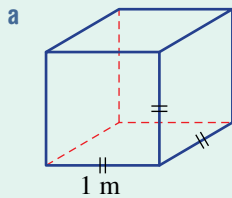

4I

- 7 Find the volume of these cylinders, rounding the answer to two decimal places.

Ext

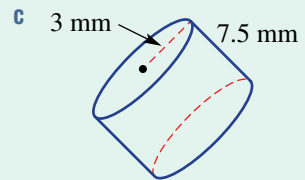
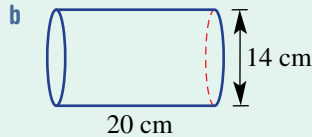
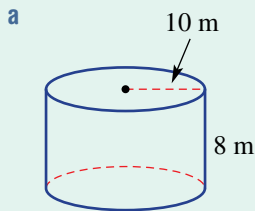

4J

- 8 An oven is heated from
- $23^\circ\text{C}$
- to
- $310^\circ\text{C}$
- in 18 minutes and 37 seconds. It then cools by
- $239^\circ\text{C}$
- in 1 hour, 20 minutes and 41 seconds.

Ext

- a Give the temperature:
- i increase ii decrease.
- b What is the total time taken to heat and cool the oven?
- c How much longer does it take for the oven to cool down than heat up?

4J

- 9 a What is the time difference between 4:20 a.m. and 2:37 p.m.?
- b Write 2145 hours in a.m./p.m. time.
- c Write 11:31 p.m. in 24-hour time.

4J

- 10 When it is 4:30 p.m. in Western Australia, state the time in each of these places.
- a New South Wales b Adelaide
- c United Kingdom d China
- e Finland f South Korea
- g Russia (eastern mainland) h New Zealand

4L



- 11 Use Pythagoras' theorem to find the length of the hypotenuse in these right-angled triangles. Round the answer to two decimal places in part **c**.

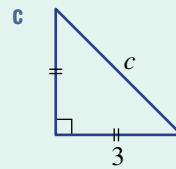
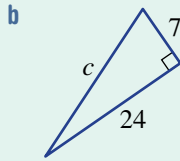
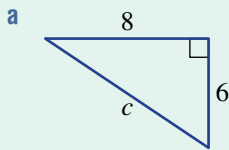

4M



- 12 Use Pythagoras' theorem to find the unknown length in these right-angled triangles. Round the answer to two decimal places in parts **b** and **c**.

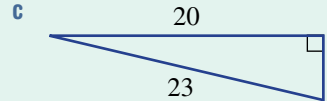
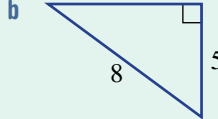
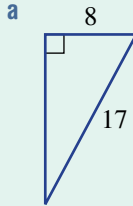

### Multiple-choice questions

4A

- 1 The perimeter of this rectangle is 20 cm. The unknown value  $x$  is:

A 4                      B 16                      C 5  
D 10                     E 6

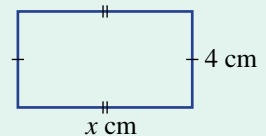

4B

- 2 A wheel has a diameter of 2 m. Its circumference and area (in that order) are given by:

A  $\pi, \pi^2$                 B  $2\pi, \pi$                 C  $4\pi, 4\pi$   
D 2, 1                    E 4, 4

4C

- 3 The area of this triangle is:

A  $27.5 \text{ m}^2$             B  $55 \text{ m}$                 C  $55 \text{ m}^2$   
D  $110 \text{ m}$              E  $16 \text{ m}^2$

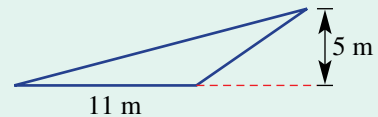

4E

- 4 Using  $\pi = 3.14$ , the area of a circular oil slick with radius 100 m is:

A  $7850 \text{ m}^2$             B  $314 \text{ m}^2$             C  $31400 \text{ m}^2$         D  $78.5 \text{ m}^2$             E  $628 \text{ m}^2$

4F

- 5 A sector of a circle is removed as shown. The fraction of the circle remaining is:

A 290                    B  $\frac{29}{36}$                     C  $\frac{7}{36}$   
D  $\frac{7}{180}$                    E  $\frac{3}{4}$

Ext

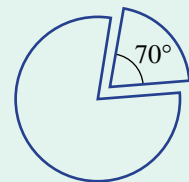

4G

- 6 A cube has a surface area of  $24 \text{ cm}^2$ . The length of its sides is:

A 12 cm                B 8 cm                C 6 cm                D 4 cm                E 2 cm

Ext



4D

7 The rule for the area of the trapezium shown is:

- A  $\frac{1}{2}xh$                       B  $\frac{1}{2}(x+y)$                       C  $\frac{1}{2}xy$   
 D  $\pi xy^2$                       E  $\frac{1}{2}(x+y)h$

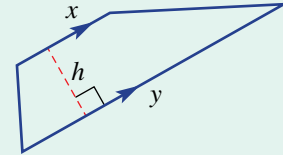

4H

8 The volume of a rectangular prism is  $48 \text{ cm}^3$ . If its width is 4 cm and height 3 cm, its length would be:

- A 3 cm                      B 4 cm                      C 2 cm                      D 12 cm                      E 96 cm

4I

9 A cylinder has radius 7 cm and height 10 cm. Using  $\pi = \frac{22}{7}$ , its volume would be:

- A  $1540 \text{ cm}^2$                       B  $440 \text{ cm}^3$                       C 440 L                      D  $1540 \text{ cm}^3$                       E  $220 \text{ cm}^3$

4K

10 The rule for Pythagoras' theorem for this triangle would be:

- A  $a^2 - b^2 = c^2$                       B  $x^2 + y^2 = z^2$                       C  $z^2 + y^2 = x^2$   
 D  $x^2 + z^2 = y^2$                       E  $y = \sqrt{x^2 - z^2}$

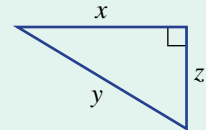

## Extended-response questions



1 A company makes square nuts for bolts to use in building construction and steel structures. Each nut starts out as a solid steel square prism. A cylinder of diameter 2 cm is bored through its centre to make a hole. The nut and its top view are shown here.

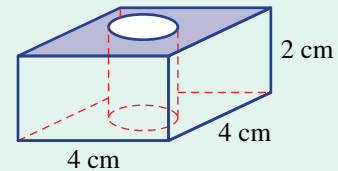

The company is interested in how much paint is required to paint the nuts. The inside surface of the hole is not to be painted. Round all answers to two decimal places where necessary.

- Find the area of the top face of the nut.
- Find the total outside surface area of the nut.
- If the company makes 10 000 nuts, how many square metres of surface needs to be painted?  
The company is also interested in the volume of steel used to make the nuts.
- Find the volume of steel removed from each nut to make the hole.
- Find the volume of steel in each nut.
- Assuming that the steel removed to make the hole can be melted and reused, how many nuts can be made from 1 L of steel?

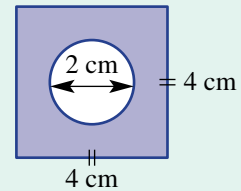

2 A simple triangular shelter has a base width of 2 m, a height of 2 m and a length of 3 m.

- Use Pythagoras' theorem to find the hypotenuse length of one of the ends of the tent. Round the answer to one decimal place.
- All the faces of the shelter including the floor are covered with canvas material. What area of canvas is needed to make the shelter? Round the answer to the nearest whole number of square metres.
- Every edge of the shelter is to be sealed with a special tape. What length of tape is required? Round to the nearest whole number of metres.
- The shelter tag says that it occupies 10 000 L of space. Show working to decide if this is true or false. What is the difference?

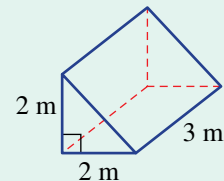

# 5

## Algebraic techniques and index laws

### Maths in context: AI and robots

Artificial intelligence (AI) and new robot technologies are bringing change to our society. Robot and AI design require expertise in many areas including university-level algebra, computer science, engineering and technology. Engineers first developed robots to perform specific, repetitive tasks. However, when a robot uses AI algorithms, machine learning can occur.

The following are examples of artificial intelligence applications:

- voice assistants like Amazon's Alexa, Google Assistant, Microsoft's Cortana, and Apple's Siri

- advertising agencies use AI to find your interests on Facebook, Instagram and Tik Tok etc.
- face-unlock (using 30 000 infrared dots), gesture recognition, autocorrect, suggestions by Amazon, and Netflix all use AI.
- chatbots using AI for machine learning and natural language processing to enable human-to-computer communication.

The examples below include robotic functions:

- agricultural harvesters, weed killers, seed spreader drones and fertiliser drones

## Chapter contents

- 5A The language of algebra  
(CONSOLIDATING)
- 5B Substitution and equivalence  
(CONSOLIDATING)
- 5C Adding and subtracting terms
- 5D Multiplying and dividing terms
- 5E Adding and subtracting algebraic fractions (EXTENDING)
- 5F Multiplying and dividing algebraic fractions (EXTENDING)
- 5G Expanding brackets
- 5H Factorising expressions
- 5I Applying algebra
- 5J Index laws for multiplication and division
- 5K The zero index and power of a power

## Victorian Curriculum 2.0

This chapter covers the following content descriptors in the Victorian Curriculum 2.0:

### ALGEBRA

VC2M8A01, VC2M8A04

### NUMBER

VC2M8N02

Please refer to the curriculum support documentation in the teacher resources for a full and comprehensive mapping of this chapter to the related curriculum content descriptors.

© VCAA

## Online resources

A host of additional online resources are included as part of your Interactive Textbook, including HOTmaths content, video demonstrations of all worked examples, auto-marked quizzes and much more.

- window cleaners, swimming pool vacuum cleaners and home vacuum cleaners
- elevators, automatic sliding doors, vending machines
- 3D printers, drones and automated guided vehicles (AGVs)
- industrial robots that manufacture cars, package food and build other robots
- ROSA, the Robotic Surgical Assistant, combines computer navigation, 3D modelling and a robotic arm allowing specialist surgeons to operate with increased precision.

## 5A The language of algebra CONSOLIDATING

### LEARNING INTENTIONS

- To know the basic terminology of algebra
- To be able to identify coefficients, terms and constant terms within expressions, including in situations where coefficients are zero or negative
- To be able to write expressions from word descriptions

A pronumeral is a letter that can represent one or more numbers. For instance,  $x$  could represent the number of goals a particular soccer player scored last year. Or  $p$  could represent the price (in dollars) of a book. The word ‘variable’ is also used to describe a letter that represents an unknown value or quantity.



Aerospace engineers calculate the orbital speed of satellites, such as the International Space Station's speed of 7.7 km/s. The algebraic formulas used include the pronumerals:  $v$  for velocity,  $g$  for gravity's acceleration and  $r$  for the distance to Earth's centre.

### Lesson starter: Algebra sort

Consider the four expressions  $x + 2$ ,  $x \times 2$ ,  $x - 2$  and  $x \div 2$ .

- If you know that  $x$  is 10, sort the four values from lowest to highest.
- Give an example of a value of  $x$  that would make  $x \times 2$  less than  $x + 2$ .
- Try different values of  $x$  to see if you can:
  - make  $x \div 2$  less than  $x - 2$
  - make  $x + 2$  less than  $x - 2$
  - make  $x \times 2$  less than  $x \div 2$

### KEY IDEAS

- In algebra, letters can be used to represent one or more numbers. These letters are called **pronomerals** or **variables**.
- $a \times b$  is written  $ab$  and  $a \div b$  is written  $\frac{a}{b}$ .
- $a \times a$  is written  $a^2$ .
- An **expression** is a combination of numbers and pronumerals combined with mathematical operations; for example,  $3x + 2yz$  and  $8 \div (3a - 2b) + 41$  are expressions.
- A **term** is a part of an expression with only pronumerals, numbers, multiplication and division; for example,  $9a$ ,  $10cd$  and  $\frac{3x}{5}$  are all terms.

- A **coefficient** is the number in front of a pronumeral. If the term is being subtracted, the coefficient is a negative number, and if there is no number in front, the coefficient is 1. For the expression  $3x + y - 7z$ , the coefficient of  $x$  is 3, the coefficient of  $y$  is 1 and the coefficient of  $z$  is  $-7$ .
- A term that does not contain any variables is called a **constant term**.
- The **sum** of  $a$  and  $b$  is  $a + b$ .
- The **difference** of  $a$  and  $b$  is  $a - b$ .
- The **product** of  $a$  and  $b$  is  $a \times b$ .
- The **quotient** of  $a$  and  $b$  is  $a \div b$ .
- The **square** of  $a$  is  $a^2$ .

## BUILDING UNDERSTANDING

- 1 The expression  $3a + 2b + 5c$  has three terms.
  - a State the terms.
  - b State the coefficient of:
    - i  $a$
    - ii  $b$
    - iii  $c$
  - c Give another expression with three terms.
- 2 The expression  $5a + 7b + c - 3ab + 6$  has five terms.
  - a State the constant term.
  - b State the coefficient of:
    - i  $a$
    - ii  $b$
    - iii  $c$
  - c Give another expression that has five terms.
- 3 Match each of the following worded statements with the correct mathematical expression.
 

a The sum of $x$ and 7	A $3 - x$
b 3 less than $x$	B $\frac{x}{3}$
c $x$ is divided by 2	C $x - 3$
d $x$ is tripled	D $3x$
e $x$ is subtracted from 3	E $x \div 2$
f $x$ is divided by 3	F $x + 7$



### Example 1 Using the language of algebra

- a List the individual terms in the expression  $4a + b - 12c + 5$ .
- b In the expression  $4a + b - 12c + 5$ , state the coefficients of  $a$ ,  $b$ ,  $c$  and  $d$ .
- c What is the constant term in  $4a + b - 12c + 5$ ?
- d State the coefficient of  $b$  in the expression  $3a + 4ab + 5b^2 + 7b$ .

#### SOLUTION

a There are four terms:  $4a$ ,  $b$ ,  $12c$  and  $5$ .

b The coefficient of  $a$  is 4.  
The coefficient of  $b$  is 1.  
The coefficient of  $c$  is  $-12$ .  
The coefficient of  $d$  is 0.

c 5

d 7

#### EXPLANATION

Each part of an expression is a term. Terms get added (or subtracted) to make an expression.

The coefficient is the number in front of a pronumeral. For  $b$ , the coefficient is 1 because  $b$  is the same as  $1 \times b$ . For  $c$ , the coefficient is  $-12$  because this term is being subtracted. For  $d$ , the coefficient is 0 because there are no terms with  $d$ .

A constant term is any term that does not contain a pronumeral.

Although there is a 4 in front of  $ab$  and a 5 in front of  $b^2$ , neither of these is a term containing just  $b$ , so they should be ignored.

#### Now you try

- a List the individual terms in the expression  $3x + y + 4 - 12z$ .
- b In the expression  $3x + y + 4 - 12z$ , state the coefficients of  $x$ ,  $y$ ,  $z$  and  $w$ .
- c What is the constant term in  $3x + y + 4 - 12z$ ?
- d State the coefficient of  $y$  in the expression  $4xy - 3x + 6y + 2y^2$ .

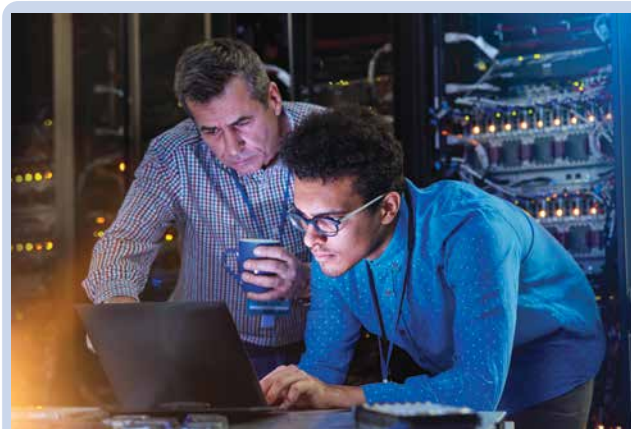

The cost of hiring a computer technician with an upfront fee of \$100 plus \$80 per hour is given by the expression  $\$(100 + 80t)$ , where  $t$  is the number of hours.



### Example 2 Creating expressions from a description

Write an expression for each of the following.

- a The sum of 3 and  $k$
- b The product of  $m$  and 7
- c 5 is added to one-half of  $k$
- d The sum of  $a$  and  $b$  is doubled

#### SOLUTION

- a  $3 + k$
- b  $m \times 7$  or  $7m$
- c  $\frac{1}{2}k + 5$  or  $\frac{k}{2} + 5$
- d  $(a + b) \times 2$  or  $2(a + b)$

#### EXPLANATION

The word 'sum' means +.

The word 'product' means  $\times$ .

One-half of  $k$  can be written  $\frac{1}{2} \times k$  (because 'of' means  $\times$ ), or  $\frac{k}{2}$  because  $k$  is being divided by two.

The values of  $a$  and  $b$  are being added and the result is multiplied by 2. Grouping symbols (the brackets) are required to multiply the whole result by two and not just the value of  $b$ .

#### Now you try

Write an expression for each of the following.

- a The sum of  $q$  and 7
- b The product of 3 and  $k$
- c 3 is subtracted from one quarter of  $p$
- d The sum of  $a$  and double  $b$  is tripled

## Exercise 5A

### FLUENCY

1, 3–5( $\frac{1}{2}$ )2, 3–6( $\frac{1}{2}$ )3–6( $\frac{1}{3}$ )

Example 1a,b

- 1 a List the four individual terms in the expression  $3a + 2b + 5c + 2$ .
- b In the expression  $3a + 2b + 5c + 2$ , state the coefficients of  $a$ ,  $b$  and  $c$ .

Example 1

- 2 a List the individual terms in the expression  $7a - 4b - 2c - 7$ .
- b In the expression  $7a - 4b - 2c - 7$ , state the coefficients of  $a$ ,  $b$ ,  $c$  and  $d$ .
- c What is the constant term in  $7a - 4b - 2c - 7$ ?
- d State the coefficient of  $b$  in the expression  $5ab - a^2 - 3b + 6a$ .

**Example 1a** 3 For each of the following expressions:

- |                                  |                          |
|----------------------------------|--------------------------|
| i state how many terms there are | ii list the terms.       |
| a $7a + 2b + c$                  | b $19y - 52x + 32$       |
| c $a + 2b$                       | d $7u - 3v + 2a + 123c$  |
| e $10f + 2be$                    | f $9 - 2b + 4c + d + e$  |
| g $5 - x^2y + 4abc - 2nk$        | h $ab + 2bc + 3cd + 4de$ |

**Example 1** 4 For each of the following expressions, state the coefficient of  $b$ .

- |                      |                     |
|----------------------|---------------------|
| a $3a + 2b + c$      | b $3a + b + 2c$     |
| c $4a + 9b + 2c + d$ | d $3a - 2b + f$     |
| e $b + 2a + 4$       | f $2a + 5c$         |
| g $7 - 54c + d$      | h $5a - 6b + c$     |
| i $4a - b + c + d$   | j $2a + 4b^2 - 12b$ |
| k $7a - b + c$       | l $8a + c - 3b + d$ |

**Example 2** 5 Write an expression for each of the following.

- |   |   |
|---|---|
| a 7 more than $y$                               | b 3 less than $x$                           |
| c The sum of $a$ and $b$                        | d The product of 4 and $p$                  |
| e Half of $q$ is subtracted from 4              | f One-third of $r$ is added to 10           |
| g The sum of $b$ and $c$ multiplied by 2        | h The sum of $b$ and twice the value of $c$ |
| i The product of $a$ , $b$ and $c$ divided by 7 | j A quarter of $a$ added to half of $b$     |
| k The quotient of $x$ and $2y$                  | l The difference of $a$ and half of $b$     |
| m The product of $k$ and itself                 | n The square of $w$                         |

6 Describe each of the following expressions in words.

- |            |                      |                         |
|------------|----------------------|-------------------------|
| a $3 + x$  | b $a + b$            | c $4 \times b \times c$ |
| d $2a + b$ | e $(4 - b) \times 2$ | f $4 - 2b$              |

### PROBLEM-SOLVING

7, 8

8–10

9–11

7 Marcela buys 7 plants from the local nursery.

- a If the cost is  $\$x$  for each plant, write an expression for the total cost in dollars.  
 b If the cost of each plant is decreased by  $\$3$  during a sale, write an expression for:  
 i the new cost per plant in dollars  
 ii the new total cost in dollars of the 7 plants.

8 Francine earns  $\$p$  per week for her job. She works for 48 weeks each year. Write an expression for the amount she earns:

- a in a fortnight  
 b in one year  
 c in one year, if her wage is increased by  $\$20$  per week after she has already worked 30 weeks in the year.

9 Jon likes to purchase DVDs of some TV shows. One show, *Numbers*, costs  $\$a$  per season, and another show, *Proof by Induction*, costs  $\$b$  per season. Write an expression for the cost of:

- a 4 seasons of *Numbers*  
 b 7 seasons of *Proof by Induction*  
 c 5 seasons of both shows  
 d all 7 seasons of each show, if the total price is halved when purchased in a sale.



- 10 A plumber charges a \$70 call-out fee and then \$90 per hour. Write an expression for the total cost of calling a plumber out for  $x$  hours.



- 11 A satellite phone call costs 20 cents connection fee and then 50 cents per minute.
- Write an expression for the total cost (in cents) of a call lasting  $t$  minutes.
  - Write an expression for the total cost (in dollars) of a call lasting  $t$  minutes.
  - Write an expression for the total cost (in dollars) of a call lasting  $t$  hours.

## REASONING

12

12, 13

12(1/2), 13, 14

- 12 If  $x$  is a positive number, classify the following statements as true or false.
- $x$  is always smaller than  $2 \times x$ .
  - $x$  is always smaller than  $x + 2$ .
  - $x$  is always smaller than  $x^2$ .
  - $1 - x$  is always less than  $4 - x$ .
  - $x - 3$  is always a positive number.
  - $x + x - 1$  is always a positive number.
- 13 If  $b$  is a negative number, classify the following statements as true or false. Give a brief reason.
- $b - 4$  *must* be negative.
  - $b + 2$  *could* be negative.
  - $b \times 2$  *could* be positive.
  - $b + b$  *must* be negative.
- 14 What is the difference between the expressions  $2a + 5$  and  $2(a + 5)$ ? Give a word expression to describe each expression. Describe how the brackets change the meaning.

## ENRICHMENT: Algebraic alphabet

-

-

15

- 15 An expression contains 26 terms, one for each letter of the alphabet. It starts:
- $$a + 4b + 9c + 16d + 25e + \dots$$
- What is the coefficient of  $f$ ?
  - What is the coefficient of  $z$ ?
  - Which pronumeral has a coefficient of 400?
  - One term is removed and now the coefficient of  $k$  is zero. What was the term?
  - Another expression containing 26 terms starts  $a + 2b + 4c + 8d + 16e + \dots$   
What is the sum of all the coefficients?

## 5B Substitution and equivalence CONSOLIDATING

### LEARNING INTENTIONS

- To be able to substitute values to evaluate algebraic expressions
- To understand what it means for two expressions to be equivalent
- To understand how the commutative and associative laws for arithmetic can be used to determine equivalence
- To be able to show that two expressions are not equivalent using substitution

One common thing to do with algebraic expressions is to replace the pronumerals with numbers. This is referred to as substitution or evaluation. In the expression  $4 + x$  we can substitute  $x = 3$  to get the result 7. Two expressions are said to be equivalent if they always give the same result when a number is substituted. For example,  $4 + x$  and  $x + 4$  are equivalent, because  $4 + x$  and  $x + 4$  will be equal numbers no matter what value of  $x$  is substituted.



Wind turbines convert the wind's kinetic energy into rotational energy and then into electrical energy. Wind power  $P = 0.5\rho\pi r^2v^3$ . Engineers calculate power by substituting numerical values for:  $\rho$  (air density),  $r$  (blade length) and  $v$  (wind velocity).

### Lesson starter: AFL algebra

In Australian Rules football, the final team score is given by  $6x + y$ , where  $x$  is the number of goals and  $y$  is the number of behinds scored.

- State the score if  $x = 3$  and  $y = 4$ .
- If the score is 29, what are the values of  $x$  and  $y$ ? Try to list all the possibilities.
- If  $y = 9$  and the score is a two-digit number, what are the possible values of  $x$ ?

### KEY IDEAS

- To **evaluate** an expression or to **substitute** values means to replace each pronumeral in an expression with a number to obtain a final value.

For example: If  $a = 3$  and  $b = 4$ , then we can evaluate the expression  $7a + 2b + 5$ :

$$\begin{aligned} 7a + 2b + 5 &= 7(3) + 2(4) + 5 \\ &= 21 + 8 + 5 \\ &= 34 \end{aligned}$$

- Two expressions are **equivalent** if they have equal values regardless of the number that is substituted for each pronumeral. The laws of arithmetic help to determine equivalence.

- The **commutative** laws of arithmetic tell us that  $a + b = b + a$  and  $a \times b = b \times a$  for all values of  $a$  and  $b$ .
- The **associative** laws of arithmetic tell us that  $a + (b + c) = (a + b) + c$  and  $a \times (b \times c) = (a \times b) \times c$  for all values of  $a$ ,  $b$  and  $c$ .

### BUILDING UNDERSTANDING

- 1 What number is obtained when  $x = 5$  is substituted into the expression  $3 \times x$ ?
- 2 What is the result of evaluating  $20 - b$  if  $b$  is equal to 12?
- 3 What is the value of  $a + 2b$  if  $a$  and  $b$  both equal 10?
- 4
  - a State the value of  $4 + 2x$  if  $x = 5$ .
  - b State the value of  $40 - 2x$  if  $x = 5$ .
  - c Are  $4 + 2x$  and  $40 - 2x$  equivalent expressions?



### Example 3 Substituting values

Substitute  $x = 3$  and  $y = 6$  to evaluate the following expressions.

**a**  $5x$

**b**  $5x^2 + 2y + x$

#### SOLUTION

**a**  $5x = 5(3)$   
 $= 15$

**b**  $5x^2 + 2y + x = 5(3)^2 + 2(6) + (3)$   
 $= 5(9) + 12 + 3$   
 $= 45 + 12 + 3$   
 $= 60$

#### EXPLANATION

Remember that  $5(3)$  is another way of writing  $5 \times 3$ .

Replace all the pronumerals by their values and remember the order in which to evaluate (multiplication before addition).

### Now you try

Substitute  $x = 4$  and  $y = 5$  to evaluate the following expressions.

**a**  $6x$

**b**  $x^2 + 2y - 3x$



### Example 4 Deciding if expressions are equivalent

- a** Are  $x - 3$  and  $3 - x$  equivalent expressions?  
**b** Are  $a + b$  and  $b + 2a - a$  equivalent expressions?

#### SOLUTION

**a** No.

#### EXPLANATION

The two expressions are equal if  $x = 3$  (both equal zero).

But if  $x = 7$ , then  $x - 3 = 4$  and  $3 - x = -4$ .

Because they are not equal for every single value of  $x$ , they are not equivalent.

**b** Yes.

Regardless of the values of  $a$  and  $b$  substituted, the two expressions are equal. It is not possible to check every single number but we can check a few to be reasonably sure they seem equivalent.

For instance, if  $a = 3$  and  $b = 5$ , then  $a + b = 8$  and  $b + 2a - a = 8$ .

If  $a = 17$  and  $b = -2$  then  $a + b = 15$  and  $b + 2a - a = 15$ .

#### Now you try

- a** Are  $p + 3$  and  $3 + p$  equivalent expressions? Give a reason.  
**b** Are  $3a + 2b$  and  $2a + 3b$  equivalent expressions? Give a reason.

## Exercise 5B

### FLUENCY

1,  $2-3(\frac{1}{2})$ ,  $6(\frac{1}{2})$

$2-7(\frac{1}{2})$

$3-6(\frac{1}{3})$ ,  $7-8(\frac{1}{2})$

Example 3a

- 1 Substitute  $x = 4$  to evaluate the following expressions.

**a**  $x + 1$

**b**  $x - 3$

**c**  $2x$

**d**  $9 - x$

Example 3a

- 2 Substitute the following values of  $x$  into the expression  $7x + 2$ .

**a** 4

**b** 5

**c** 2

**d** 8

Example 3a

- 3 Substitute  $x = -3$  to evaluate the following expressions.

**a**  $x + 1$

**b**  $x - 3$

**c**  $2x$

**d**  $9 - x$

- 4 Substitute  $a = 2$  and  $b = 5$  into each of the following.

**a**  $5a + 4$

**b**  $3b$

**c**  $a + b$

**d**  $ab - 4 + b$

**e**  $3a + 2b$

**f**  $8a - 3b$

Example 3b

5 Substitute  $a = 4$  and  $b = -3$  into each of the following.

a  $\frac{12}{a} + \frac{6}{b}$

b  $\frac{ab}{3} + b$

c  $\frac{100}{a+b}$

d  $a^2 + b$

e  $5 \times (b + 6)^2$

f  $a + b^2 - b$

Example 4

6 For the following, state whether they are equivalent (E) or not (N).

a  $x + y$  and  $y + x$

b  $3 \times x$  and  $x + 2x$

c  $4a + b$  and  $4b + a$

d  $7 - x$  and  $4 - x + 3$

e  $4(a + b)$  and  $4a + b$

f  $4 + 2x$  and  $2 + 4x$

g  $\frac{1}{2} \times a$  and  $\frac{a}{2}$

h  $3 + 6y$  and  $3(2y + 1)$

i  $-2(1 - x)$  and  $2x - 2$

7 For each of the following, two of the three expressions are equivalent. State the odd one out.

a  $4x$ ,  $3 + x$  and  $3x + x$

b  $2 - a$ ,  $a - 2$  and  $a + 1 - 3$

c  $5t - 2t$ ,  $2t + t$  and  $4t - 2t$

d  $8u - 3$ ,  $3u - 8$  and  $3u - 3 + 5u$

8 Evaluate the expression  $4ab - 2b + 6c$  when:

a  $a = 4$  and  $b = 3$  and  $c = 9$

b  $a = -8$  and  $b = -2$  and  $c = 9$

c  $a = -1$  and  $b = -8$  and  $c = -4$

d  $a = 9$  and  $b = -2$  and  $c = 5$

e  $a = -8$  and  $b = -3$  and  $c = 5$

f  $a = -1$  and  $b = -3$  and  $c = 6$

## PROBLEM-SOLVING

9

10, 11

10-12

9 Give three expressions that are equivalent to  $2x + 4y + 5$ .

10 A number is substituted for  $x$  in the expression  $10 - 2x$  and the result is a negative number. What does this fact tell you about the number substituted for  $x$ ? (*Hint*: You can try a few different values of  $x$  to help.)

11 Copy and complete the following table.

$x$	3		0.25		-2	
$4x + 2$	14	6				
$4 - 3x$	-5					-2
$2x - 4$				8		

12 Assume that  $a$  and  $b$  are two integers (positive, negative or zero).a List the values they could have if you know that  $ab = 10$ .b What values could they have if you know that  $a + b = 10$ ?c List the values they could have if you know that  $ab = a + b$ .

## REASONING

13

13, 14

15–17

- 13 a** Is it possible to substitute values of  $x$  and  $y$  so that  $x + y$  and  $x + 2y$  are equal? Try to describe all possible solutions.
- b** Does this imply that  $x + y$  and  $x + 2y$  are equivalent? Give reasons.
- 14 a** Give an example to show that  $a \div (b \times c)$  is not equivalent to  $(a \div b) \times c$ .
- b** Does this contradict the laws of associativity (see **Key ideas**)? Justify your answer.
- c** Is  $a \div (b \div c)$  equivalent to  $(a \div b) \div c$ ? Why or why not?
- 15** The expressions  $4 - x$  and  $x - 4$  are not equivalent because they are not always equal (for instance, when  $x = 3$ ). They are sometimes equal (for instance, when  $x = 4$ ).
- a** Give an example of two expressions that are only equal if  $a = 5$ .
- b** Give an example of two expressions that are only equal if  $a = b$ .
- c** Give an example of two expressions that are never equal, regardless of the value of the variables involved.
-  **16 a** By substituting a range of numbers for  $a$  and  $b$ , determine whether  $(ab)^2$  is equivalent to  $a^2b^2$ .
- b** Is  $(a + b)^2$  equivalent to  $a^2 + b^2$ ?
- c** Is  $\sqrt{ab}$  equivalent to  $\sqrt{a}\sqrt{b}$ ?
- d** Is  $\sqrt{a + b}$  equivalent to  $\sqrt{a} + \sqrt{b}$ ?
- e** For pairs of expressions in **a** to **d** that are not equivalent, find an example of values for  $a$  and  $b$  that make the expressions equal.
- 17** Sometimes when two expressions are equivalent you can explain why they are equivalent. For example,  $x + y$  is equivalent to  $y + x$  'because addition is commutative'. For each of the following pairs of expressions, try to describe why they are equivalent.
- a**  $x \times y$  and  $y \times x$
- b**  $x + x$  and  $2x$
- c**  $y - y$  and  $0$
- d**  $\frac{1}{2} \times x$  and  $x \div 2$

## ENRICHMENT: Missing values

-

-

18

- 18** Find the missing values in the table below.

$a$	5	8			-20			
$b$	2		1					
$a + b$		10		10		7		-19
$a + 2b$				17	0		11	
$a - b$			1			13		
$a - 2b$							-29	20

## 5C Adding and subtracting terms

### LEARNING INTENTIONS

- To understand that like terms contain exactly the same pronumerals, possibly in a different order
- To be able to decide if two terms are like terms
- To be able to combine like terms to simplify expressions

Recall from Year 7 that an expression such as  $3x + 5x$  can be simplified to  $8x$ , but an expression such as  $3x + 5y$  cannot be simplified. The reason is that  $3x$  and  $5x$  are like terms; that is, they have exactly the same pronumerals. The terms  $3x$  and  $5y$  are not like terms. Also,  $4ab$  and  $7ba$  are like terms because  $ab$  and  $ba$  are equivalent, as multiplication is commutative. However,  $a^2b$ ,  $ab$ , and  $ab^2$  are all unlike terms, since  $a^2b$  means  $a \times a \times b$ , which is different from  $a \times b$  and from  $a \times b \times b$ .

### Lesson starter: Like terms

- Put these terms into groups of like terms:  $4a$   $5b$   $2ab$   $3ba$   $2a$   $7b^2$   $5a^2b$   $9aba$
- What is the simplified sum of each group?
- Ephraim groups  $5a^2b$  and  $2ab$  as like terms, so he simplifies  $5a^2b + 2ab$  to  $7ab$ . How could you demonstrate to him that  $5a^2b + 2ab$  is not equivalent to  $7ab$ ?

### KEY IDEAS

- **Like terms** contain exactly the same pronumerals with the same powers; the pronumerals do not need to be in the same order; for example,  $4ab$  and  $7ba$  are like terms.
- Like terms can be combined when they are added or subtracted to simplify an expression; for example,  $3xy + 5xy = 8xy$ .
- The sign in front of the term stays with the term even when it is moved.

$$\begin{aligned} 3x + 7y - 2x + 3y + x - 4y &= 3x - 2x + x + 7y + 3y - 4y \\ &= 2x + 6y \end{aligned}$$

### BUILDING UNDERSTANDING

- If  $x = 3$ , evaluate  $5x + 2x$ .
  - If  $x = 3$ , evaluate  $7x$ .
  - $5x + 2x$  is equivalent to  $7x$ . True or false?
- If  $x = 3$  and  $y = 4$ , evaluate  $5x + 2y$ .
  - If  $x = 3$  and  $y = 4$ , evaluate  $7xy$ .
  - $5x + 2y$  is equivalent to  $7xy$ . True or false?
- Substitute  $x = 4$  into the expression  $10x - 5x + 2x$ .
  - Substitute  $x = 4$  into:
    - $3x$
    - $5x$
    - $7x$
  - Which one of the expressions in part **b** is equivalent to  $10x - 5x + 2x$ ?

**Example 5 Identifying like terms**

Classify the following pairs as like terms (L) or not like terms (N).

**a**  $6a$  and  $2a$

**b**  $7ab$  and  $-10ba$

**c**  $3ab^2$  and  $7a^2b$

**SOLUTION**

**a** L

**b** L

**c** N

**EXPLANATION**

Both terms have exactly the same pronumeral.

 $ab = ba$  so both terms have the same pronumerals. $3ab^2 = 3 \times a \times b \times b$  and  $7a^2b = 7 \times a \times a \times b$ .They are not like terms because the first includes only one  $a$  and the second includes two.**Now you try**

Classify the following pairs as like terms (L) or not like terms (N).

**a**  $3pq$  and  $-3qp$

**b**  $5st^2$  and  $3s^2t$

**c**  $8a^2b$  and  $9b^2a$

**Example 6 Simplifying by combining like terms**

Simplify the following by combining like terms.

**a**  $7t + 2t - 3t$

**b**  $4x + 3y + 2x + 7y$

**c**  $7ac + 3b - 2ca + 4b - 5b$

**SOLUTION**

**a**  $7t + 2t - 3t = 6t$

**b**  $4x + 3y + 2x + 7y$   
 $= 4x + 2x + 3y + 7y$   
 $= 6x + 10y$

**c**  $7ac + 3b - 2ca + 4b - 5b$   
 $= 7ac - 2ca + 3b + 4b - 5b$   
 $= 5ac + 2b$

**EXPLANATION**

These are like terms, so they can be combined.

$7 + 2 - 3 = 6.$

Move the like terms next to each other.

Combine the pairs of like terms.

Move the like terms together. Recall that the subtraction sign stays in front of  $2ca$  even when it is moved.

$7 - 2 = 5$  and  $3 + 4 - 5 = 2$

**Now you try**

Simplify the following by combining like terms.

**a**  $8x - 3x + 2x$

**b**  $4a + 3b + 2b + 9a$

**c**  $6pq + 8p - 2qp + 5q - 2p$



## Exercise 5C

## FLUENCY

1, 2-5(1/2)

2-6(1/2)

3-6(1/2)

Example 5a

- 1 Classify the following pairs as like terms (L) or not like terms (N).
- a  $4a$  and  $2b$                       b  $3x$  and  $5x$                       c  $2y$  and  $2z$                       d  $4p$  and  $9p$
- 2 Classify the following pairs as like terms (L) or not like terms (N).
- a  $3a$  and  $5a$                       b  $7x$  and  $-12x$                       c  $2y$  and  $7y$                       d  $4a$  and  $-3b$
- e  $7xy$  and  $3y$                       f  $12ab$  and  $4ba$                       g  $3cd$  and  $-8c$                       h  $2x$  and  $4xy$

Example 5b,c

- 3 Classify the following pairs as like terms (L) or not like terms (N).
- a  $-3x^2y$  and  $5x^2y$                       b  $12ab^2$  and  $10b^2a$                       c  $2ab^2$  and  $10ba^2$
- d  $7qrs$  and  $-10rqs$                       e  $11q^2r$  and  $10rq$                       f  $-15ab^2c$  and  $-10cba^2$

Example 6a

- 4 Simplify the following by combining like terms.
- a  $3x + 2x$                       b  $7a + 12a$                       c  $15x - 6x$
- d  $4xy + 3xy$                       e  $16uv - 3uv$                       f  $10ab + 4ab$
- g  $11ab - 5ab + ab$                       h  $3k + 15k - 2k$                       i  $15k - 2k - 3k$

Example 6b,c

- 5 Simplify the following by combining like terms.
- a  $7f + 2f + 8 + 4$                       b  $10x + 3x + 5y + 3y$                       c  $2a + 5a + 13b - 2b$
- d  $10a + 5b + 3a + 4b$                       e  $10 + 5x + 2 + 7x$                       f  $10a + 3 + 4b - 2a - b$
- g  $10x + 31y - y + 4x$                       h  $11a + 4 - 2a + 12a$                       i  $7x^2y + 5x + 10yx^2$
- j  $12xy - 3yx + 5xy - yx$                       k  $-4x^2 + 3x^2$                       l  $-2a + 4b - 7ab + 4a$
- m  $10 + 7q - 3r + 2q - r$                       n  $11b - 3b^2 + 5b^2 - 2b$

- 6 For each expression, choose an equivalent expression from the options listed.

- a  $7x + 2x$                       A  $10y + 3x$
- b  $12y + 3x - 2y$                       B  $9xy$
- c  $3x + 3y$                       C  $9x$
- d  $8y - 2x + 6y - x$                       D  $3y + 3x$
- e  $4xy + 5yx$                       E  $14y - 3x$

## PROBLEM-SOLVING

7, 8

8-10

10-12

- 7 Write expressions for the perimeters of the following shapes in simplest form.

a

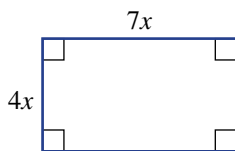

b

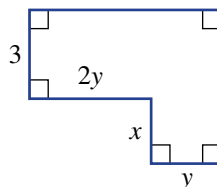

- 8 Towels cost \$c each at a shop.

- a John buys 3 towels, Mary buys 6 towels and Naomi buys 4 towels. Write a fully simplified expression for the total amount spent on towels.
- b On another occasion, Chris buys  $n$  towels, David buys twice as many as Chris and Edward buys 3 times as many as David. Write a simplified expression for the total amount they spent on towels.

9 State the missing numbers to make the following equivalences true.

a  $10x + 6y - \square x + \square y = 3x + 8y$

b  $5a - 7b + \square a + \square b = 11a$

c  $\square c + \square d + \square = 4c + 2d + 1 + 3c + 7d + 4$

d  $\square a^2b + \square b^2a + 2a^2b + b^2a = 7b^2a + 10a^2b$

10 Add the missing expressions to the puzzle to make all six equations true.

$$\begin{array}{ccc} \boxed{5x} & + & \boxed{\phantom{0000}} = \boxed{7x} \\ + & & + \\ \boxed{y} & + & \boxed{\phantom{0000}} = \boxed{\phantom{0000}} \\ = & & = \\ \boxed{\phantom{0000}} & + & \boxed{\phantom{0000}} = \boxed{7x + 3y} \end{array}$$



Wind chill temperature is given by the expression  $t + 0.33e - 0.7v - 4$ , with  $t$  (current temperature),  $e$  (water vapour pressure) and  $v$  (wind speed).

11 In how many ways could the blanks below be filled if all the coefficients must be positive integers?

$$\square a + \square b + \square a = 10a + 7b$$

12 Simplify  $a - 2a + 3a - 4a + 5a - 6a + \dots + 99a - 100a$ .

### REASONING

13

13, 14

14, 15

13 Prove that  $10x + 5y + 7x + 2y$  is equivalent to  $20x - 3x + 10y - 3y$ . (Hint: Simplify both expressions.)

14 a Make a substitution to prove that  $4a + 3b$  is not equivalent to  $7ab$ .

b Is  $4a + 3b$  ever equal to  $7ab$ ? Try to find some values of  $a$  and  $b$  to make  $4a + 3b = 7ab$  a true equation.

c Is  $4a + 3a$  ever not equal to  $7a$ ? Explain your answer.

15 a Decide whether  $7x - 3x$  is equivalent to  $7x + (-3x)$ . Explain why or why not.

b Fill in the missing numbers to make the following equivalence true.

$$14a + 3b + 2ab + \square a + \square b + \square ba = a$$

### ENRICHMENT: Missing expressions

-

-

16

16 a Fill in the missing expressions to make all eight equations true.

$$\begin{array}{ccc} \boxed{5a} & + & \boxed{\phantom{0000}} + \boxed{4a} = \boxed{10a + 3} \\ + & & + \\ \boxed{2b} & + & \boxed{4 + a} + \boxed{\phantom{0000}} = \boxed{\phantom{0000}} \\ + & & + \\ \boxed{\phantom{0000}} & + & \boxed{\phantom{0000}} + \boxed{-3a} = \boxed{1} \\ = & & = \\ \boxed{\phantom{0000}} & + & \boxed{3a + 8} + \boxed{\phantom{0000}} = \boxed{10a + 2b + 8} \end{array}$$

b Design your own 'missing values' puzzle like the one above. It should only have one possible solution.

## 5D Multiplying and dividing terms

### LEARNING INTENTIONS

- To understand the meaning of  $x^2$  and  $x^3$
- To be able to multiply terms and simplify the result
- To be able to divide terms and simplify the result

Recall that a term written as  $4ab$  is shorthand for  $4 \times a \times b$ . Observing this helps to see how we can multiply terms.

$$\begin{aligned} 4ab \times 3c &= 4 \times a \times b \times 3 \times c \\ &= 4 \times 3 \times a \times b \times c \\ &= 12abc \end{aligned}$$

Division is written as a fraction, so  $\frac{12ab}{9ad}$  means  $(12ab) \div (9ad)$ . To simplify a division, we look for common factors:

$$\frac{4\cancel{1}2 \times a \times b}{\cancel{3}9 \times a \times d} = \frac{4b}{3d}$$

$a \div a = 1$  for any value of  $a$  except 0,

so,  $\frac{a}{a}$  cancels to 1.



Marine engineers design underwater turbines to convert tidal flow energy into electricity. Tidal power calculation includes multiplying values for:  $\rho$ , the seawater density;  $A$ , the turbine's circular area; and  $v^3$ , the water speed cubed.

### Lesson starter: Multiple ways

Multiplying  $4a \times 6b \times c$  gives you  $24abc$ .

- In how many ways can positive integers fill the blanks in  $\square a \times \square b \times \square c = 24abc$ ?
- In how many other ways can you multiply three terms to get  $24abc$ ? For example,  $12ab \times 2 \times c$ . You should assume the coefficients are all integers.

### KEY IDEAS

- $12abc$  means  $12 \times a \times b \times c$ .
- When multiplying, the order is not important:  $2 \times a \times 4 \times b = 2 \times 4 \times a \times b$ .
- $x^2$  means  $x \times x$  and  $x^3$  means  $x \times x \times x$ .
- When dividing, cancel any common factors.

For example:  $\frac{3\cancel{1}5xy}{4\cancel{2}0yz} = \frac{3x}{4z}$

## BUILDING UNDERSTANDING

- 1 Which is the correct way to write  $3 \times a \times b \times b$ ?  
**A**  $3ab$                       **B**  $3ab^2$                       **C**  $ab^3$                       **D**  $3a^2b$
- 2 Simplify these fractions by looking for common factors in the numerator and the denominator.  
**a**  $\frac{12}{20}$                       **b**  $\frac{5}{15}$                       **c**  $\frac{12}{8}$                       **d**  $\frac{15}{25}$
- 3 Which one of these is equivalent to  $a \times b \times a \times b \times b$ ?  
**A**  $5ab$                       **B**  $a^2b^3$                       **C**  $a^3b^2$                       **D**  $(ab)^5$
- 4 Express these without multiplication signs.  
**a**  $3 \times x \times y$                       **b**  $5 \times a \times b \times c$   
**c**  $12 \times a \times b \times b$                       **d**  $4 \times a \times c \times c \times c$



## Example 7 Multiplying and dividing terms

**a** Simplify  $7a \times 2bc \times 3d$

**c** Simplify  $\frac{10ab}{15bc}$

**b** Simplify  $3xy \times 5xz$

**d** Simplify  $\frac{18x^2y}{8xz}$

## SOLUTION

$$\begin{aligned} \mathbf{a} \quad 7a \times 2bc \times 3d \\ &= 7 \times a \times 2 \times b \times c \times 3 \times d \\ &= 7 \times 2 \times 3 \times a \times b \times c \times d \\ &= 42abcd \end{aligned}$$

$$\begin{aligned} \mathbf{b} \quad 3xy \times 5xz \\ &= 3 \times x \times y \times 5 \times x \times z \\ &= 3 \times 5 \times x \times x \times y \times z \\ &= 15x^2yz \end{aligned}$$

$$\begin{aligned} \mathbf{c} \quad \frac{10ab}{15bc} &= \frac{2\cancel{10} \times a \times b}{3\cancel{15} \times b \times c} \\ &= \frac{2a}{3c} \end{aligned}$$

$$\begin{aligned} \mathbf{d} \quad \frac{18x^2y}{8xz} &= \frac{9\cancel{18} \times x \times x \times y}{4\cancel{8} \times x \times z} \\ &= \frac{9xy}{4z} \end{aligned}$$

## EXPLANATION

Write the expression with multiplication signs and bring the numbers to the front.

Simplify:  $7 \times 2 \times 3 = 42$  and

$$a \times b \times c \times d = abcd$$

Write the expression with multiplication signs and bring the numbers to the front.

Simplify, remembering that  $x \times x = x^2$ .

Write the numerator and denominator in full, with multiplication signs. Cancel any common factors and remove the multiplication signs.

Write the numerator and denominator in full, remembering that  $x^2$  is  $x \times x$ . Cancel any common factors and remove the multiplication signs.

## Now you try

**a** Simplify  $3p \times 4qr \times 2s$

**c** Simplify  $\frac{12pq}{16qr}$

**b** Simplify  $4ab \times 3bc$

**d** Simplify  $\frac{10a^2bc}{12ac}$

## Exercise 5D

### FLUENCY

1, 2-4( $\frac{1}{2}$ )2-4( $\frac{1}{2}$ )3( $\frac{1}{3}$ ), 4( $\frac{1}{4}$ )

Example 7a

1 Simplify the following.

a  $3a \times 4$

b  $2 \times 5b$

c  $8 \times 3c$

d  $5d \times 6$

Example 7a

2 Simplify the following.

a  $7d \times 9$

b  $5a \times 2b$

c  $3 \times 12x$

d  $4a \times 2b \times cd$

e  $3a \times 10bc \times 2d$

f  $4a \times 6de \times 2b$

Example 7b

3 Simplify the following.

a  $8ab \times 3c$

b  $a \times a$

c  $3d \times d$

d  $5d \times 2d \times e$

e  $7x \times 2y \times x$

f  $5xy \times 2x$

g  $4xy \times 2xz$

h  $4abc \times 2abd$

i  $12x^2y \times 4x$

j  $9ab \times 2a^2$

k  $3x^2y \times 2x \times 4y$

l  $-3xz \times (-2z)$

m  $-5xy \times 2yz$

n  $10ab^2 \times 7ba$

o  $4xy^2 \times 4y$

Example 7c,d

4 Simplify the following divisions by cancelling any common factors.

a  $\frac{5a}{10a}$

b  $\frac{7x}{14y}$

c  $\frac{10xy}{12y}$

d  $\frac{ab}{4b}$

e  $\frac{7xyz}{21yz}$

f  $\frac{2}{12x}$

g  $\frac{-5x}{10yz^2}$

h  $\frac{12y^2}{-18y}$

i  $\frac{-4a^2}{8ab}$

j  $\frac{21p}{-3q}$

k  $\frac{-21p}{-3p}$

l  $\frac{-15z}{-20z^2}$

### PROBLEM-SOLVING

5, 6

6, 7

7( $\frac{1}{2}$ ), 8, 9

- 5 a Give an example of two terms that multiply to  $20ab$ .  
 b Give an example of two terms that multiply to  $15abc$ .

6 Write a simplified expression for the area of the following shapes. Recall that rectangle area = width  $\times$  length.

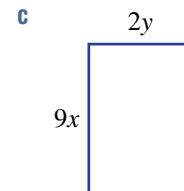
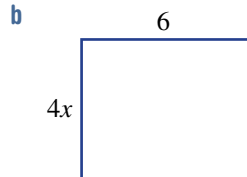
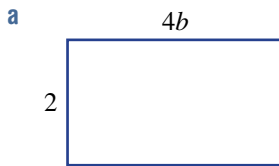

7 Fill in the missing terms to make the following equivalences true.

a  $3x \times \square \times z = 6xyz$

b  $4a \times \square = 12ab^2$

c  $-2q \times \square \times 4s = 16qs$

d  $\frac{\square}{4r} = 7s$

e  $\frac{\square}{2ab} = 4b$

f  $\frac{14xy}{\square} = -2y$

- 8 Write a simplified expression for the area of the following shapes.

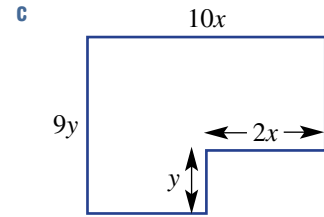
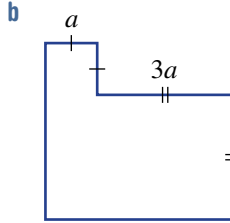
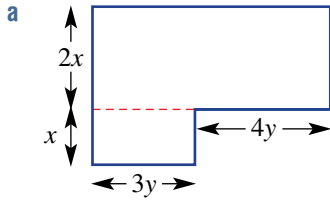

- 9 A box has a height of  $x$  cm. It is 3 times as wide as it is high, and 2 times as long as it is wide. Find an expression for the volume of the box, given that volume = length  $\times$  width  $\times$  height.

### REASONING

10

10, 11

11–13

- 10 A square has a width of  $x$  cm.
- Give an expression for its area in terms of  $x$ .
  - Give an expression for its perimeter in terms of  $x$ .
  - Prove that its area divided by its perimeter is equal to a quarter of its width.
- 11 When  $a$ ,  $b$  and  $c$  are whole numbers, the expression  $5a \times 4b \times 5c$  always results in a number ending in 00 (e.g. when  $a = 2$ ,  $b = 7$  and  $c = 4$ , then it becomes 5600). Use simplification to explain why this will always happen.
- 12 Joanne claims that the following three expressions are equivalent:  $\frac{2a}{5}$ ,  $\frac{2}{5} \times a$ ,  $\frac{2}{5a}$ .
- Is she right? Try different values of  $a$ .
  - Which two expressions are equivalent?
  - There are two values of  $a$  that make all three expressions are equal. What are they?
- 13 Note that  $\frac{14xy}{7x} = 2y$  and  $7x \times 2y = 14xy$ .
- You are told that  $12x^2y^3 \times 3x^5$  is equivalent to  $36x^7y^3$ . What does  $\frac{36x^7y^3}{12x^2y^3}$  simplify to?
  - You are told that  $-7a^5b \times -3b^2c^3$  is equivalent to  $21a^5(bc)^3$ . What does  $\frac{21a^5(bc)^3}{-7a^5b}$  simplify to?
  - Describe how you can find the missing value in a puzzle written as term 1  $\times$   = term 2.

### ENRICHMENT: Multiple operations

–

–

14

- 14 Simplify the following expressions, remembering that you can combine like terms when adding or subtracting.

a  $\frac{2ab \times 3bc \times 4cd}{4a \times 3bc \times 2d}$

b  $\frac{12a^2b + 4a^2b}{4b + 2b}$

c  $\frac{7x^2y - 5yx^2}{12xy}$

d  $\frac{8a^2b + (4a \times 2ba)}{3ba - 2ba}$

e  $\frac{10abc + 5cba + 5a \times bc}{4c \times 10ab}$

f  $\frac{10x^2y - (4x \times 6xy)}{7xy^2}$

## 5E Adding and subtracting algebraic fractions EXTENDING

### LEARNING INTENTIONS

- To understand what an algebraic fraction is
- To be able to find the lowest common denominator of two algebraic fractions
- To be able to find equivalent algebraic fractions with different denominators
- To be able to add and subtract algebraic fractions and simplify the result

An algebraic fraction is an expression involving division that could include any algebraic expression in the numerator or the denominator.

$$\frac{2}{3} + \frac{5}{7} = \frac{20}{3}$$

Fractions

$$\frac{2x}{5} - \frac{3}{7a+4} = \frac{2x-46}{7a+9b}$$

Algebraic fractions

The rules for working with algebraic fractions are the same as the rules for normal fractions. For example, two fractions with the same denominator can be added or subtracted easily.

Normal fractions	Algebraic fractions
$\frac{2}{13} + \frac{7}{13} = \frac{9}{13}$	$\frac{5x}{13} + \frac{3x}{13} = \frac{8x}{13}$
$\frac{8}{11} - \frac{2}{11} = \frac{6}{11}$	$\frac{5x}{11} - \frac{2y}{11} = \frac{5x-2y}{11}$

If two fractions do not have the same denominator, they must be converted to have the lowest common denominator (LCD) before adding or subtracting.

Normal fractions	Algebraic fractions
$\frac{2}{3} + \frac{1}{5} = \frac{10}{15} + \frac{3}{15}$ $= \frac{13}{15}$	$\frac{2a}{3} + \frac{b}{5} = \frac{10a}{15} + \frac{3b}{15}$ $= \frac{10a+3b}{15}$

### Lesson starter: Adding thirds and halves

Dallas and Casey attempt to simplify  $\frac{x}{3} + \frac{x}{2}$ . Dallas gets  $\frac{x}{5}$  and Casey gets  $\frac{5x}{6}$ .

- Which of the two students has the correct answer? You could try substituting different numbers for  $x$ .
- How can you prove that the other student is incorrect?
- What do you think  $\frac{x}{3} + \frac{x}{4}$  is equivalent to? Compare your answers with others in the class.



The study of optometry uses algebraic fractions, such as when calculating the magnifying power of spectacles.

## KEY IDEAS

- An **algebraic fraction** is a fraction with an algebraic expression as the numerator or the denominator.
- The **lowest common denominator** (or LCD) of two algebraic fractions is the smallest multiple of the denominators.
- Adding and subtracting algebraic fractions requires that they both have the same denominator.

For example:  $\frac{2x}{5} + \frac{4y}{5} = \frac{2x + 4y}{5}$

## BUILDING UNDERSTANDING

- 1 State the missing number or word to complete these sentences.
  - a For the fraction  $\frac{2}{7}$  the numerator is 2 and the denominator is \_\_\_\_\_.
  - b For  $\frac{4}{9}$  the numerator is \_\_\_\_\_ and the denominator is \_\_\_\_\_.
  - c The expression  $\frac{12x}{5}$  is an example of an \_\_\_\_\_ fraction.
  - d The denominator of  $\frac{5x+3}{7}$  is \_\_\_\_\_.
- 2 Find the lowest common denominator (LCD) of the following pairs of fractions.
  - a  $\frac{1}{3}$  and  $\frac{2}{5}$
  - b  $\frac{1}{4}$  and  $\frac{1}{5}$
  - c  $\frac{3}{7}$  and  $\frac{5}{6}$
  - d  $\frac{2}{3}$  and  $\frac{1}{6}$
- 3 Find the missing numerator to make the following equations true.
  - a  $\frac{2}{3} = \frac{\square}{6}$
  - b  $\frac{4}{7} = \frac{\square}{21}$
  - c  $\frac{1}{3} = \frac{\square}{12}$
  - d  $\frac{6}{11} = \frac{\square}{55}$
- 4 Evaluate the following, by first converting to a lowest common denominator.
  - a  $\frac{1}{4} + \frac{1}{3}$
  - b  $\frac{2}{7} + \frac{1}{5}$
  - c  $\frac{1}{10} + \frac{1}{5}$
  - d  $\frac{2}{5} - \frac{1}{4}$



## Example 8 Working with denominators

- a Find the lowest common denominator of  $\frac{3x}{10}$  and  $\frac{2y}{15}$ .
- b Convert  $\frac{2x}{7}$  to an equivalent algebraic fraction with the denominator 21.

## SOLUTION

a 30

## EXPLANATION

Need to find the lowest common multiple (LCM) of the denominators 10 and 15.

The multiples of 10 are 10, 20, 30, 40, 50, 60 etc.

The multiples of 15 are 15, 30, 45, 60, 75, 90 etc.

The smallest number in both lists is 30.



$$\begin{aligned} \text{b } \frac{2x}{7} &= \frac{3 \times 2x}{3 \times 7} \\ &= \frac{6x}{21} \end{aligned}$$

Multiply the numerator and denominator by 3, so that the denominator is 21.

Simplify the numerator:  $3 \times 2x$  is  $6x$ .

### Now you try

a Find the lowest common denominator of  $\frac{5x}{12}$  and  $\frac{3x}{8}$ .

b Convert  $\frac{3x}{5}$  to an equivalent algebraic fraction with the denominator 20.



### Example 9 Adding and subtracting algebraic fractions

Simplify the following expressions.

a  $\frac{3x}{11} + \frac{5x}{11}$

b  $\frac{4a}{3} + \frac{2a}{5}$

c  $\frac{6k}{5} - \frac{3k}{10}$

d  $\frac{a}{6} - \frac{b}{9}$

#### SOLUTION

$$\begin{aligned} \text{a } \frac{3x}{11} + \frac{5x}{11} &= \frac{3x + 5x}{11} \\ &= \frac{8x}{11} \end{aligned}$$

$$\begin{aligned} \text{b } \frac{4a}{3} + \frac{2a}{5} &= \frac{5 \times 4a}{15} + \frac{3 \times 2a}{15} \\ &= \frac{20a}{15} + \frac{6a}{15} \\ &= \frac{26a}{15} \end{aligned}$$

$$\begin{aligned} \text{c } \frac{6k}{5} - \frac{3k}{10} &= \frac{12k}{10} - \frac{3k}{10} \\ &= \frac{12k - 3k}{10} \\ &= \frac{9k}{10} \end{aligned}$$

$$\begin{aligned} \text{d } \frac{a}{6} - \frac{b}{9} &= \frac{3a}{18} - \frac{2b}{18} \\ &= \frac{3a - 2b}{18} \end{aligned}$$

#### EXPLANATION

The two fractions have the same denominators, so the two numerators are added.

$3x$  and  $5x$  are like terms, so they are combined to  $8x$ .

The LCD = 15, so both fractions are converted to have 15 as the denominator.

Simplify the numerators.

Combine:  $20a + 6a$  is  $26a$ .

LCD = 10, so convert the first fraction (multiplying numerator and denominator by 2).

Combine the numerators.

Simplify:  $12k - 3k = 9k$ .

LCD = 18, so convert both fractions to have 18 as a denominator.

Combine the numerators. Note this cannot be further simplified since  $3a$  and  $2b$  are not like terms.

### Now you try

Simplify the following expressions.

a  $\frac{2x}{7} + \frac{4x}{7}$

b  $\frac{2a}{3} + \frac{5a}{7}$

c  $\frac{5k}{4} - \frac{3k}{8}$

d  $\frac{a}{4} - \frac{b}{6}$

## Exercise 5E

## FLUENCY

1, 2-5(1/2)

2-6(1/2)

2-6(1/4)

Example 8a

- 1 Find the lowest common denominator of the algebraic fractions
- $\frac{x}{6}$
- and
- $\frac{x}{4}$
- .

Example 8a

- 2 Find the LCD of the following pairs of algebraic fractions.

a  $\frac{x}{3}$  and  $\frac{2y}{5}$

b  $\frac{3x}{10}$  and  $\frac{21y}{20}$

c  $\frac{x}{4}$  and  $\frac{y}{5}$

d  $\frac{x}{12}$  and  $\frac{y}{6}$

Example 8b

- 3 Copy and complete the following, to make each equation true.

a  $\frac{x}{5} = \frac{\square}{10}$

b  $\frac{2a}{7} = \frac{\square}{21}$

c  $\frac{4z}{5} = \frac{\square}{20}$

d  $\frac{3k}{10} = \frac{\square}{50}$

Example 9a,b

- 4 Simplify the following sums.

a  $\frac{x}{4} + \frac{2x}{4}$

b  $\frac{5a}{3} + \frac{2a}{3}$

c  $\frac{2b}{5} + \frac{b}{5}$

d  $\frac{4k}{3} + \frac{k}{3}$

e  $\frac{a}{2} + \frac{a}{3}$

f  $\frac{a}{4} + \frac{a}{5}$

g  $\frac{p}{2} + \frac{p}{5}$

h  $\frac{q}{4} + \frac{q}{2}$

i  $\frac{2k}{5} + \frac{3k}{7}$

j  $\frac{2m}{5} + \frac{2m}{3}$

k  $\frac{7p}{6} + \frac{2p}{5}$

l  $\frac{x}{4} + \frac{3x}{8}$

Example 9c

- 5 Simplify the following differences.

a  $\frac{3y}{5} - \frac{y}{5}$

b  $\frac{7p}{13} - \frac{2p}{13}$

c  $\frac{10r}{7} - \frac{2r}{7}$

d  $\frac{8q}{5} - \frac{2q}{5}$

e  $\frac{p}{2} - \frac{p}{3}$

f  $\frac{2t}{5} - \frac{t}{3}$

g  $\frac{9u}{11} - \frac{u}{2}$

h  $\frac{8y}{3} - \frac{5y}{6}$

i  $\frac{r}{3} - \frac{r}{2}$

j  $\frac{6u}{7} - \frac{7u}{6}$

k  $\frac{9u}{1} - \frac{3u}{4}$

l  $\frac{5p}{12} - \frac{7p}{11}$

Example 9d

- 6 Simplify the following expressions, giving your final answer as an algebraic fraction. (
- Hint*
- :
- $4x$
- is the same as
- $\frac{4x}{1}$
- .)

a  $4x + \frac{x}{3}$

b  $3x + \frac{x}{2}$

c  $\frac{a}{5} + 2a$

d  $\frac{8p}{3} - 2p$

e  $\frac{10u}{3} + \frac{3v}{10}$

f  $\frac{7y}{10} - \frac{2x}{5}$

g  $2t + \frac{7p}{2}$

h  $\frac{x}{3} - y$

i  $5 - \frac{2x}{7}$

## PROBLEM-SOLVING

7

7, 8

8, 9

- 7 Cedric earns an unknown amount,
- $\$x$
- , every week. He spends
- $\frac{1}{3}$
- of his income on rent and
- $\frac{1}{4}$
- on groceries.

- a Write an algebraic fraction for the amount of money he spends on rent.
- b Write an algebraic fraction for the amount of money he spends on groceries.
- c Write a simplified algebraic fraction for the total amount of money he spends on rent and groceries.

- 8 Egan fills the bathtub so it is a quarter full and then adds half a bucket of water. A full bathtub can contain  $T$  litres and a bucket contains  $B$  litres.
- Write the total amount of water in the bathtub as the sum of two algebraic fractions.
  - Simplify the expression in part **a** to get a single algebraic fraction.
  - If a full bathtub contains 1000 litres and the bucket contains 2 litres, how many litres of water are in the bathtub?



- 9 Afshin's bank account is halved in value and then \$20 is removed. If it initially had \$ $A$  in it, write an algebraic fraction for the amount left.

## REASONING

10

10

10, 11

- 10 **a** Demonstrate that  $\frac{x}{2} + \frac{x}{3}$  is equivalent to  $\frac{5x}{6}$  by substituting at least three different values for  $x$ .
- b** Show that  $\frac{x}{4} + \frac{x}{5}$  is not equivalent to  $\frac{2x}{9}$ .
- c** Is  $\frac{x}{2} + \frac{x}{5}$  equivalent to  $x - \frac{x}{3}$ ? Explain why or why not.
- 11 **a** Simplify the following differences.
- i**  $\frac{x}{2} - \frac{x}{3}$       **ii**  $\frac{x}{3} - \frac{x}{4}$       **iii**  $\frac{x}{4} - \frac{x}{5}$       **iv**  $\frac{x}{5} - \frac{x}{6}$
- b** What patterns did you notice in the above results?
- c** Write a difference of two algebraic fractions that simplifies to  $\frac{x}{110}$ .

## ENRICHMENT: Equivalent sums and differences

-

-

12

- 12 For each of the following expressions, find a single equivalent algebraic fraction.
- a**  $\frac{z}{4} + \frac{z}{3} + \frac{z}{12}$       **b**  $\frac{2x}{5} + \frac{x}{2} - \frac{x}{5}$       **c**  $\frac{7u}{2} + \frac{3u}{4} - \frac{5u}{8}$       **d**  $\frac{8k}{3} + \frac{k}{6} - \frac{5k}{12}$
- e**  $\frac{p}{4} + \frac{p}{2} - 3$       **f**  $\frac{u}{3} + \frac{u}{4} + \frac{u}{5}$       **g**  $\frac{5j}{12} - \frac{j}{3} + 2$       **h**  $\frac{7t}{5} - \frac{t}{3} + \frac{2r}{15}$

## 5F Multiplying and dividing algebraic fractions EXTENDING

### LEARNING INTENTIONS

- To understand that the rules of multiplying and dividing fractions extend to algebraic fractions
- To be able to multiply algebraic fractions and simplify the result
- To be able to divide algebraic fractions and simplify the result

As with fractions, it is generally easier to multiply and divide algebraic fractions than it is to add or subtract them.

$$\frac{3}{5} \times \frac{2}{7} = \frac{6}{35} \leftarrow 3 \times 2$$

Fractions

$$\frac{4x}{7} \times \frac{2y}{11} = \frac{8xy}{77}$$

Algebraic fractions

Dividing is done by multiplying by the reciprocal of the second fraction.

$$\begin{aligned} \frac{4}{5} \div \frac{1}{3} &= \frac{4}{5} \times \frac{3}{1} \\ &= \frac{12}{5} \end{aligned}$$

Fractions

$$\begin{aligned} \frac{2x}{5} \div \frac{3y}{7} &= \frac{2x}{5} \times \frac{7}{3y} \\ &= \frac{14x}{15y} \end{aligned}$$

Algebraic fractions

### Lesson starter: Always the same

One of these four expressions always gives the same answer, no matter what the value of  $x$  is.

$$\frac{x}{2} + \frac{x}{3}$$

$$\frac{x}{2} - \frac{x}{3}$$

$$\frac{x}{2} \times \frac{x}{3}$$

$$\frac{x}{2} \div \frac{x}{3}$$

- Which of the four expressions always has the same value?
- Can you explain why this is the case?
- Try to find an expression involving two algebraic fractions that is equivalent to  $\frac{3}{8}$ .

### KEY IDEAS

- To multiply two algebraic fractions, multiply the **numerators** and the **denominators** separately. Then cancel any common factors in the numerator and the denominator.

For example:

$$\begin{aligned} \frac{2x}{5} \times \frac{10y}{3} &= \frac{20^4xy}{15^3} \\ &= \frac{4xy}{3} \end{aligned}$$

- The **reciprocal** of an algebraic fraction is formed by swapping the numerator and denominator. The reciprocal of  $\frac{3b}{4}$  is  $\frac{4}{3b}$ .

- To divide algebraic fractions, take the reciprocal of the second fraction and then multiply.

For example:

$$\begin{aligned}\frac{2a}{5} \div \frac{3b}{4} &= \frac{2a}{5} \times \frac{4}{3b} \\ &= \frac{8a}{15b}\end{aligned}$$

## BUILDING UNDERSTANDING

- 1 State the missing number.

a  $\frac{2}{3} \times \frac{4}{5} = \frac{\square}{15}$

b  $\frac{1}{2} \times \frac{3}{7} = \frac{\square}{14}$

c  $\frac{4}{5} \times \frac{7}{11} = \frac{28}{\square}$

d  $\frac{3}{4} \times \frac{5}{8} = \frac{15}{\square}$

- 2 Which one of the following shows the correct first step in calculating  $\frac{2}{3} \div \frac{4}{5}$ ?

A  $\frac{2}{3} \div \frac{4}{5} = \frac{3}{2} \times \frac{5}{4}$

B  $\frac{2}{3} \div \frac{4}{5} = \frac{2}{4} \times \frac{3}{5}$

C  $\frac{2}{3} \div \frac{4}{5} = \frac{2}{3} \times \frac{5}{4}$

D  $\frac{2}{3} \div \frac{4}{5} = \frac{3}{2} \times \frac{4}{5}$

- 3 Calculate the following, remembering to simplify your result.

a  $\frac{2}{3} \times \frac{7}{10}$

b  $\frac{1}{4} \times \frac{6}{11}$

c  $\frac{2}{3} \div \frac{4}{5}$

d  $\frac{4}{17} \div \frac{1}{3}$



### Example 10 Multiplying algebraic fractions

Simplify the following products.

a  $\frac{2a}{5} \times \frac{3b}{7}$

b  $\frac{4x}{15} \times \frac{3y}{2}$

#### SOLUTION

a  $\frac{2a}{5} \times \frac{3b}{7} = \frac{6ab}{35}$

b **Method 1:**

$$\begin{aligned}\frac{4x}{15} \times \frac{3y}{2} &= \frac{\overset{2}{\cancel{12}}xy}{\underset{5}{\cancel{30}}} \\ &= \frac{2xy}{5}\end{aligned}$$

**Method 2:**

$$\frac{\overset{2}{\cancel{4}}x}{\underset{5}{\cancel{15}}} \times \frac{\overset{3}{\cancel{3}}y}{\underset{2}{\cancel{2}^1}} = \frac{2xy}{5}$$

#### EXPLANATION

Multiply the numerators and denominators separately:

$$2a \times 3b = 6ab \text{ and } 5 \times 7 = 35$$

$$4x \times 3y = 12xy$$

$$15 \times 2 = 30$$

Divide by a common factor of 6 to simplify.

First divide by any common factors in the numerators and denominators:  $4x$  and  $2$  have a common factor of  $2$ . Also  $3y$  and  $15$  have a common factor of  $3$ .

### Now you try

Simplify the following products.

a  $\frac{2c}{7} \times \frac{5d}{11}$

b  $\frac{8a}{21} \times \frac{9b}{4}$

**Example 11** Dividing algebraic fractions

Simplify the following divisions.

a  $\frac{3a}{8} \div \frac{b}{5}$

b  $\frac{u}{4} \div \frac{15p}{2}$

**SOLUTION**

$$\begin{aligned} \text{a } \frac{3a}{8} \div \frac{b}{5} &= \frac{3a}{8} \times \frac{5}{b} \\ &= \frac{15a}{8b} \end{aligned}$$

$$\begin{aligned} \text{b } \frac{u}{4} \div \frac{15p}{2} &= \frac{u}{4} \times \frac{2}{15p} \\ &= \frac{2u}{60p} \\ &= \frac{u}{30p} \end{aligned}$$

**EXPLANATION**Take the reciprocal of  $\frac{b}{5}$ , which is  $\frac{5}{b}$ .Multiply as before:  $3a \times 5 = 15a$ ,  $8 \times b = 8b$ .Take the reciprocal of  $\frac{15p}{2}$ , which is  $\frac{2}{15p}$ .Multiply as before:  $u \times 2 = 2u$  and  $4 \times 15p = 60p$ .

Cancel the common factor of 2.

**Now you try**

Simplify the following divisions.

a  $\frac{2p}{5} \div \frac{3q}{7}$

b  $\frac{x}{3} \div \frac{7y}{6}$

**Exercise 5F****FLUENCY**1, 2-4( $\frac{1}{2}$ )2-5( $\frac{1}{2}$ )2-5( $\frac{1}{3}$ )

Example 10a

1 Simplify the following products.

a  $\frac{3a}{4} \times \frac{5b}{7}$

b  $\frac{5x}{7} \times \frac{2y}{3}$

c  $\frac{11a}{5} \times \frac{2b}{7}$

Example 10a

2 Simplify the following products.

a  $\frac{x}{3} \times \frac{2}{5}$

b  $\frac{1}{7} \times \frac{a}{9}$

c  $\frac{2}{3} \times \frac{4a}{5}$

d  $\frac{4c}{5} \times \frac{1}{5}$

e  $\frac{4a}{3} \times \frac{2b}{5}$

f  $\frac{3a}{2} \times \frac{7a}{5}$

Example 10b

3 Simplify the following products, remembering to cancel any common factors.

a  $\frac{6x}{5} \times \frac{7y}{6}$

b  $\frac{2b}{5} \times \frac{7d}{6}$

c  $\frac{8a}{5} \times \frac{3b}{4c}$

d  $\frac{9d}{2} \times \frac{4e}{7}$

e  $\frac{3x}{2} \times \frac{1}{6x}$

f  $\frac{4}{9k} \times \frac{3k}{2}$

Example 11

4 Simplify the following divisions, cancelling any common factors.

a  $\frac{3a}{4} \div \frac{1}{5}$

b  $\frac{2x}{5} \div \frac{3}{7}$

c  $\frac{9a}{10} \div \frac{1}{4}$

d  $\frac{2}{3} \div \frac{4x}{7}$

e  $\frac{4}{5} \div \frac{2y}{3}$

f  $\frac{1}{7} \div \frac{2}{x}$

g  $\frac{4a}{7} \div \frac{2}{5}$

h  $\frac{4b}{7} \div \frac{2c}{5}$

i  $\frac{2x}{5} \div \frac{4y}{3}$

j  $\frac{2y}{x} \div \frac{3}{y}$

k  $\frac{5}{12x} \div \frac{7x}{2}$

l  $\frac{4a}{5} \div \frac{2b}{7a}$

5 Simplify the following. (Recall that  $3 = \frac{3}{1}$ .)

a  $\frac{4x}{5} \times 3$

b  $\frac{4x}{5} \div 3$

c  $2 \div \frac{x}{5}$

d  $4 \times \frac{a}{3}$

e  $5 \times \frac{7}{10x}$

f  $1 \div \frac{x}{2}$

### PROBLEM-SOLVING

6

6, 7

7, 8

6 Helen's family goes to dinner with Tess' family. The bill comes to a total of \$ $x$  and each family pays half.

a Write an algebraic fraction for the amount Helen's family pays.

b Helen says that she will pay for one-third of her family's bill. Write an algebraic fraction for the amount she pays.

7 The rectangular field shown at right has width  $x$  metres and length  $y$  metres.

a Write an expression for the area of the field.

b A smaller section is fenced off. It is  $\frac{1}{2}$  the width and  $\frac{3}{4}$  the length.

i Write an expression for the width of the smaller section.

ii Write an expression for the length of the smaller section.

iii Then, write an expression for the area of the smaller section.

c To find the proportion of the field that is fenced off, you can divide the fenced area by the total area. Use this to find the proportion of the field that has been fenced.

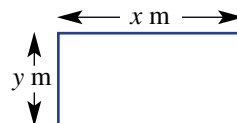

8 Write an algebraic fraction for the result of the following operations.

a A number  $q$  is halved and then the result is tripled.

b A number  $x$  is multiplied by  $\frac{2}{3}$  and the result is divided by  $1\frac{1}{3}$ .

c The fraction  $\frac{a}{b}$  is multiplied by its reciprocal  $\frac{b}{a}$ .

d The number  $x$  is reduced by 25% and then halved.

### REASONING

9

9, 10

9–11

9 Recall that any value  $x$  can be thought of as the fraction  $\frac{x}{1}$ .

a Simplify  $x \times \frac{1}{x}$ .

b Simplify  $x \div \frac{1}{x}$ .

c Show that  $x \div 3$  is equivalent to  $\frac{1}{3} \times x$  by writing them both as algebraic fractions.

d Simplify  $\frac{a}{b} \div c$ .

e Simplify  $a \div \frac{b}{c}$ .

10 a Simplify each of the following expressions.

i  $\frac{x}{5} + \frac{x}{6}$

ii  $\frac{x}{5} - \frac{x}{6}$

iii  $\frac{x}{5} \times \frac{x}{6}$

iv  $\frac{x}{5} \div \frac{x}{6}$

b Which one of the expressions above will always have the same value regardless of  $x$ ?

11 Assume that  $a$  and  $b$  are any two whole numbers.

a Prove that  $1 \div \frac{a}{b}$  is the same as the reciprocal of the fraction  $\frac{a}{b}$ .

b Find the reciprocal of the reciprocal of  $\frac{a}{b}$  by evaluating  $1 \div \left(1 \div \frac{a}{b}\right)$ .

## ENRICHMENT: Irrational squares

12

12 Consider a square with side length  $x$ .

- Write an expression for the area of the square.
- The length of each side is now halved. Give an expression for the area of the new square.
- If each side of the original square is multiplied by  $\frac{3}{5}$ , show that the resulting area is less than half the original area.
- If each side of the original square is multiplied by 0.7, find an expression for the area of the square. Recall that  $0.7 = \frac{7}{10}$ .

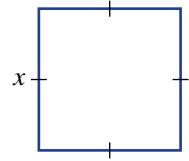

- Each side of the square is multiplied by some amount, which results in the square's area being halved. Find the amount by which they were multiplied, correct to three decimal places.

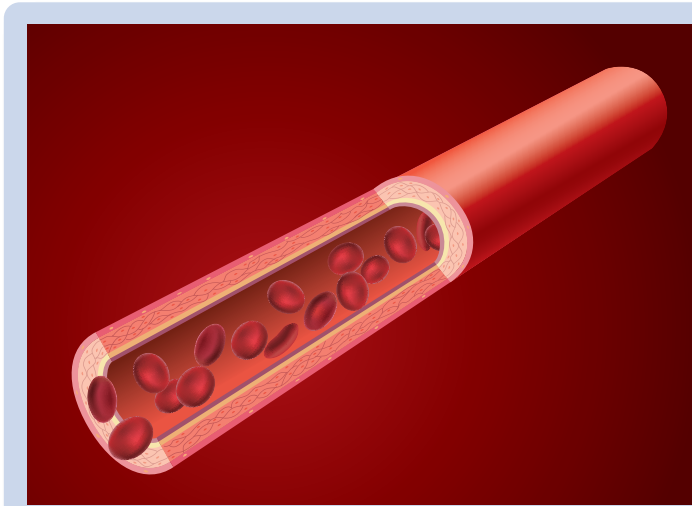

Medical physics shows that blood pressure in an artery or a vein is proportional to the fraction  $\frac{t}{r}$ , where  $t$  is the wall thickness and  $r$  is the inner radius.



5A

- 1 Answer the following questions about the expression  $3a - 9b - ab + c + 8$ .
- How many terms are there?
  - List the individual terms.
  - State the coefficients of  $a$ ,  $b$ ,  $c$  and  $d$ .
  - What is the constant term?
  - State the coefficient of  $ab$ .

5A

- 2 Write an expression for each of the following.
- the sum of 5 and  $m$
  - the product of  $k$  and 8
  - 7 less than  $p$
  - 12 more than  $h$
  - double the sum of  $x$  and  $y$
  - the quotient of  $a$  and  $b$
  - the difference of half of  $k$  and one-third of  $m$
  - the product of  $a$  and  $c$  divided by 5

5B

- 3 Substitute  $x = 3$  and  $y = -6$  to evaluate the following expressions.

- |                |                       |
|----------------|-----------------------|
| a $4x + y$     | b $3 \times (x + 2y)$ |
| c $2x^2 + y^2$ | d $\frac{36}{x - y}$  |

5B

- 4 For the following state whether they are equivalent (E) or not (N).

- |                           |                            |
|---------------------------|----------------------------|
| a $x + y$ and $y + x$     | b $x - 5$ and $5 - x$      |
| c $2(x + y)$ and $2x + y$ | d $2 \times y$ and $y + y$ |

5C

- 5 Classify the following pairs as like terms (L) or not like terms (N).

- |                       |                      |
|-----------------------|----------------------|
| a $5a$ and $-7a$      | b $3xy$ and $5yx$    |
| c $5p^2t$ and $8pt^2$ | d $8abc$ and $-9bac$ |

5C

- 6 Simplify the following by combining like terms.

- |                        |                              |
|------------------------|------------------------------|
| a $4h + 3h + 8 - 5$    | b $12a + 7 - 8a + 1 + a$     |
| c $8xy + 4x - 3yx - x$ | d $-gk + 3g^2k + 12 - 8kg^2$ |

5D

- 7 Simplify the following.

- |                                |                         |
|--------------------------------|-------------------------|
| a $3a \times 2b$               | b $5d \times 2d$        |
| c $5abc \times 3acd \times 2d$ | d $4p^2q \times 3q$     |
| e $\frac{12a}{48a}$            | f $\frac{16x^2}{40x}$   |
| g $\frac{8c}{24ac}$            | h $\frac{-18m^2}{27mt}$ |

5E

- 8 Simplify the following expressions, giving your final answer as an algebraic fraction.

- |                                 |                                 |                                 |                       |
|---------------------------------|---------------------------------|---------------------------------|-----------------------|
| a $\frac{2m}{9} + \frac{5m}{9}$ | b $\frac{4k}{3} + \frac{5k}{6}$ | c $\frac{5a}{6} - \frac{3b}{8}$ | d $5x - \frac{2x}{3}$ |
|---------------------------------|---------------------------------|---------------------------------|-----------------------|

Ext

5F

- 9 Simplify the following.

- |                                      |  |                                    |                                      |
|--------------------------------------|--|------------------------------------|--------------------------------------|
| a $\frac{3a}{5} \times \frac{2b}{7}$ | b $\frac{8m}{9a} \times \frac{6a}{10}$ | c $\frac{5}{2} \div \frac{15}{8y}$ | d $\frac{2m}{5} \div \frac{4mp}{15}$ |
|--------------------------------------|--|------------------------------------|--------------------------------------|

Ext

## 5G Expanding brackets

### LEARNING INTENTIONS

- To understand that the distributive law can be used to expand brackets
- To be able to expand brackets using the distributive law
- To be able to use expansion together with combining like terms to simplify expressions

Two expressions might look different when in fact they are equivalent. For example,  $2(3 - 7b)$  is equivalent to  $4b + 6(1 - 3b)$  even though they look different. One use for expanding brackets is that it allows us to easily convert between equivalent expressions.



Architects and engineers carefully analyse the qualities of materials selected to support buildings. Algebraic skills with brackets, such as  $x^2(3l - x)$ , are applied to determine the deflection, i.e. bend, in a steel girder length,  $l$ , at  $xm$  from one end.

### Lesson starter: Room plans

An architect has prepared floor plans for a house but some numbers are missing. Four students have attempted to describe the total area of the plans shown.

Alice says it is  $5a + 50 + ab$ .

Brendan says it is  $5(a + 10) + ab$ .

Charles says it is  $a(5 + b) + 50$ .

David says it is  $(5 + b)(a + 10) - 10b$ .

- Discuss which of the students is correct.
- How do you think each student worked out their answer?
- The architect later told them that  $a = 4$  and  $b = 2$ . What value would each of the four students get for the area?

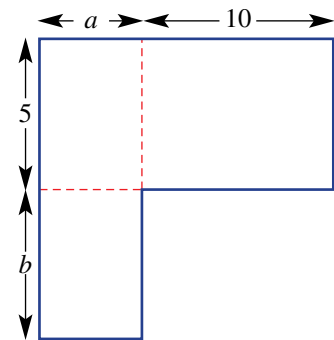

### KEY IDEAS

- The **distributive law** is used to rewrite an expression without brackets.

$$\begin{aligned} a(b+c) &= a \times b + a \times c \\ &= ab + ac \end{aligned}$$

$$\begin{aligned} a(b-c) &= a \times b - a \times c \\ &= ab - ac \end{aligned}$$

For example:  $4(2x + 5) = 8x + 20$  and  $3(5 - 2y) = 15 - 6y$

- The distributive law is used in arithmetic.

$$\begin{aligned} \text{For example: } 5 \times 31 &= 5 \times (30 + 1) \\ &= 5 \times 30 + 5 \times 1 \\ &= 150 + 5 \\ &= 155 \end{aligned}$$

$$\begin{array}{r} 2x + 5 \\ 4 \left[ \begin{array}{|c|c|} \hline 8x & +20 \\ \hline \end{array} \right] \\ \\ 5 - 2y \\ 3 \left[ \begin{array}{|c|c|} \hline 15 & -6y \\ \hline \end{array} \right] \end{array}$$

## BUILDING UNDERSTANDING

1 The area of this combined rectangle is  $5(2 + x)$ .

- a What is the area of the green rectangle?  
 b What is the area of the yellow rectangle?  
 c Give an expression for the sum of these two areas.  
 d Hence complete the following:  
 The expanded form of  $5(2 + x)$  is \_\_\_\_\_.

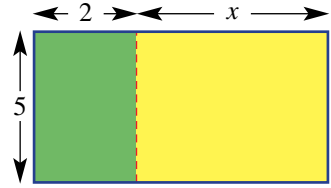

2 The expression  $3(2 + 7x)$  is equivalent to  $(2 + 7x) + (2 + 7x) + (2 + 7x)$ . Simplify this expression by combining like terms.

3 Which of the following is the correct expansion of  $4(3x + 7)$ ?

- A  $12x + 7$       B  $4x + 28$       C  $3x + 28$       D  $12x + 28$

4 State the missing number to complete the following expansions.

- a  $2(b + 5) = 2b + \square$   
 b  $3(2x + 4y) = 6x + \square y$   
 c  $5(3a - 2) = 15a - \square$



## Example 12 Expanding using the distributive law

Expand the following using the distributive law.

- a  $3(2x + 5)$       b  $4x(2 - y)$       c  $-8(7 + 2y)$

## SOLUTION

a  $3(2x + 5) = 3(2x) + 3(5)$   
 $= 6x + 15$

## EXPLANATION

Distributive law:  $3(2x + 5) = 3(2x) + 3(5)$

Simplify the result.

Alternative layout:

$$3 \begin{array}{|c|c|} \hline 2x & +5 \\ \hline 6x & +15 \\ \hline \end{array}$$

So,  $3(2x + 5) = 6x + 15$

b  $4x(2 - y) = 4x(2) - 4x(y)$   
 $= 8x - 4xy$

Distributive law:  $4x(2 - y) = 4x(2) - 4x(y)$

Simplify the result.

Alternative layout:

$$4x \begin{array}{|c|c|} \hline 2 & -y \\ \hline 8x & -4xy \\ \hline \end{array}$$

So,  $4x(2 - y) = 8x - 4xy$

*Continued on next page*

$$\begin{aligned} \text{c } -8(7 + 2y) &= -8(7) + (-8)(2y) \\ &= -56 + (-16y) \\ &= -56 - 16y \end{aligned}$$

Distributive law:  $-8(7 + 2y) = -8(7) + (-8)(2y)$

Simplify the result.

Alternative layout:

$$\begin{array}{r} 7 \quad +2y \\ -8 \quad \boxed{-56} \quad \boxed{-16y} \end{array}$$

So,  $-8(7 + 2y) = -56 - 16y$

### Now you try

Expand the following using the distributive law.

**a**  $5(3x + 4)$

**b**  $7a(4 - b)$

**c**  $-2(8 + 5b)$

### Example 13 Expanding and collecting like terms

Simplify the following by expanding and then collecting like terms.

**a**  $3(2b + 5) + 3b$

**b**  $12xy + 7x(2 - y)$

#### SOLUTION

$$\begin{aligned} \text{a } 3(2b + 5) + 3b &= 3(2b) + 3(5) + 3b \\ &= 6b + 15 + 3b \\ &= 9b + 15 \end{aligned}$$

$$\begin{aligned} \text{b } 12xy + 7x(2 - y) &= 12xy + 7x(2) - 7x(y) \\ &= 12xy + 14x - 7xy \\ &= 5xy + 14x \end{aligned}$$

#### EXPLANATION

Use the distributive law.  
Simplify the result.  
Combine the like terms.

Use the distributive law.

Simplify the result.  
Combine the like terms.

### Now you try

Simplify the following by expanding and then collecting like terms.

**a**  $4(3x + 2) + 2x$

**b**  $5ab + 3a(10 - b)$



## Exercise 5G

### FLUENCY

1, 2–4(½)

2–4(½), 6(½)

3–6(½)

Example 12a

1 Expand the following using the distributive law.

a  $5(3x + 2)$

b  $7(2x + 1)$

c  $6(3x + 5)$

d  $10(4x + 3)$

Example 12a,b

2 Use the distributive law to expand these expressions.

a  $3(2a + 5)$

b  $5(3t + 4)$

c  $8(2m + 4)$

d  $3(v + 6)$

e  $4(3 - 2j)$

f  $6(2k - 5)$

g  $4(3m - 1)$

h  $2(8 - c)$

Example 12

3 Use the distributive law to expand the following.

a  $-5(9 + g)$

b  $-7(5b + 4)$

c  $-9(u - 9)$

d  $-8(5 - h)$

e  $8z(k - h)$

f  $-6j(k + a)$

g  $4u(2r - q)$

h  $4m(5w - 3a)$

Example 13

4 Simplify the following by expanding and then collecting like terms.

a  $7(9f + 10) + 2f$

b  $8(2 + 5x) + 4x$

c  $4(2a + 8) + 7a$

d  $6(3v + 10) + 6v$

e  $7(10a + 10) + 6a$

f  $6(3q - 5) + 2q$

g  $6(4m - 5) + 8m$

h  $4(8 + 7m) - 6m$

5 Simplify the following by expanding and then collecting like terms.

a  $3(3 + 5d) + 4(10d + 7)$

b  $10(4 + 8f) + 7(5f + 2)$

c  $2(9 + 10j) + 4(3j + 3)$

d  $2(9 + 6d) + 7(2 + 9d)$

e  $6(10 - 6j) + 4(10j - 5)$

f  $8(5 + 10g) + 3(4 - 4g)$

6 The distributive law also allows expansion with more than two terms in the brackets, for instance

$3(2x - 4y + 5) = 6x - 12y + 15$ . This can also be laid out with boxes as

$$3 \begin{array}{|c|c|c|} \hline 2x & -4y & +5 \\ \hline 6x & -12y & +15 \\ \hline \end{array}$$

Use this fact to simplify the following.

a  $2(3x + 2y + 4z)$

b  $7a(2 - 3b + 4y)$

c  $2q(4z + 2a + 5)$

d  $-3(2 + 4k + 2p)$

e  $-5(1 + 5q - 2r)$

f  $-7k(r + m + s)$

### PROBLEM-SOLVING

7

7–9

8–10

7 Write an expression for each of the following and then expand it.

a A number  $t$  has 4 added to it and the result is multiplied by 3.b A number  $u$  has 3 subtracted from it and the result is doubled.c A number  $v$  is doubled, and then 5 is added. The result is tripled.d A number  $w$  is tripled, and then 2 is subtracted. The result is doubled.

- 8 Match each operation on the left with an equivalent one on the right. (*Hint*: First convert the descriptions into algebraic expressions.)
- |  |  |
|--|--|
| a The number $x$ is doubled and 6 is added.                            | A $x$ is doubled and reduced by 10.                |
| b The number $x$ is reduced by 5 and the result is doubled.            | B The number $x$ is tripled.                       |
| c The number $x$ is added to double the value of $x$ .                 | C $x$ is decreased by 6.                           |
| d The number $x$ is halved, then 3 is added and the result is doubled. | D $x$ is increased by 3 and the result is doubled. |
| e 2 is subtracted from one-third of $x$ and the result is tripled.     | E $x$ is increased by 6.                           |
- 9 The number of students in a school library is  $s$  and the number of teachers is  $t$ . Each student has 5 pencils and each teacher has 3 pencils.
- Write an expression for the total number of pencils in the library.
  - If the pencils cost \$2 each, write and expand an expression for the total cost of all the pencils in the library.
  - Each student and teacher also has one pencil case, costing \$4 each. Write a simplified and expanded expression for the total cost of all pencils and cases in the library.
  - If there are 20 students and 4 teachers, what is the total cost for all the pencils and cases in the room?



- 10 a When expanded,  $4(2a + 6b)$  gives  $8a + 24b$ . Find two other expressions that expand to give  $8a + 24b$ .
- Give an expression that expands to  $4x + 8y$ .
  - Give an expression that expands to  $12a - 8b$ .
  - Give an expression that expands to  $18ab + 12ac$ .

**REASONING** 11 11, 12 12-14

- 11 Prove that  $4a(2 + b) + 2ab$  is equivalent to  $a(6b + 4) + 4a$  by expanding both expressions.
- 12 The area model for expanding can be used when multiplying two bracketed expressions, such as  $(2a + 3b)(7 + c)$ :

	$2a$	$+ 3b$
$7$	$14a$	$+ 21b$
$+c$	$+ 2ac$	$+ 3bc$

So,  $(2a + 3b)(7 + c) = 14a + 21b + 2ac + 3bc$ . Use this strategy to expand the following.

- a**  $(a + b)(3 + c)$                       **b**  $(3a + 4b)(5 + 6c)$                       **c**  $(x + 3)(x + 4)$

- 13 The distributive law can be used in multiplication of whole numbers. For example,

$$17 \times 102 = 17 \times (100 + 2) = 17(100) + 17(2) = 1734.$$

- a** Use the distributive law to find the value of  $9 \times 204$ . Start with  $9 \times 204 = 9 \times (200 + 4)$ .  
**b** Use the distributive law to find the value of  $204 \times 9$ . Start with  $204 \times 9 = 204 \times (10 - 1)$ .  
**c** Given that  $a \times 11 = a \times (10 + 1) = 10a + a$ , find the value of these products.

- i**  $14 \times 11$                       **ii**  $32 \times 11$                       **iii**  $57 \times 11$                       **iv**  $79 \times 11$

- d** It is known that  $(x + 1)(x - 1)$  expands to  $x^2 - 1$ . For example, if  $x = 7$  this tells you that  $8 \times 6 = 49 - 1 = 48$ . Use this fact to find the value of:

- i**  $7 \times 5$                       **ii**  $21 \times 19$                       **iii**  $13 \times 11$                       **iv**  $201 \times 199$

- e** Using a calculator, or otherwise evaluate  $15^2$ ,  $25^2$  and  $35^2$ . Describe how these relate to the fact that  $(10n + 5)(10n + 5)$  is equivalent to  $100n(n + 1) + 25$ .

- 14 Prove that the following sequence of operations has the same effect as doubling a number.

- 1 Take a number, add 2.
- 2 Multiply by 6.
- 3 Subtract 6.
- 4 Multiply this result by  $\frac{1}{3}$ .
- 5 Subtract 2.

**ENRICHMENT: Expanding algebraic fractions** - - 15

- 15 To simplify  $\frac{x+5}{3} + \frac{x}{2}$ , change both fractions to have a common denominator of 6, giving

$$\frac{2(x+5)}{6} + \frac{3x}{6}. \text{ Then expand to finish off the simplification: } \frac{2x+10}{6} + \frac{3x}{6} = \frac{5x+10}{6}.$$

Use this method to simplify the following sums.

- a**  $\frac{x+1}{3} + \frac{x}{2}$                       **b**  $\frac{x+5}{5} + \frac{x}{3}$                       **c**  $\frac{3x}{8} + \frac{x-1}{4}$   
**d**  $\frac{x+2}{4} + \frac{x+1}{3}$                       **e**  $\frac{2x+1}{5} + \frac{3x+1}{10}$                       **f**  $\frac{2x-1}{7} + \frac{3x+2}{5}$

## 5H Factorising expressions

### LEARNING INTENTIONS

- To understand that factorising is the reverse procedure of expanding
- To be able to find the highest common factor of two terms
- To be able to factorise expressions

Factorising is the opposite procedure to expanding. It allows us to simplify expressions and solve harder mathematical problems. Because  $3(2x + 5)$  expands to  $6x + 15$ , this means that the factorised form of  $6x + 15$  is  $3(2x + 5)$ . The aim in factorising is to write expressions as the product of two or more factors, just as with numbers we can factorise 30 and write  $30 = 2 \times 3 \times 5$ .

### Lesson starter: Expanding gaps

- Try to fill in the gaps to make the following equivalence true:  $\square (\square + \square) = 12x + 18xy$ .
- In how many ways can this be done? Try to find as many ways as possible.
- If the aim is to make the term outside the brackets as large as possible, what is the best possible solution to the puzzle?

### KEY IDEAS

- The **highest common factor** (HCF) of a set of terms is the largest factor that divides into each term.

For example:

HCF of  $15x$  and  $21y$  is 3.

HCF of  $10a$  and  $20c$  is 10.

HCF of  $12x$  and  $18xy$  is  $6x$ .

- To **factorise** an expression, first take the HCF of the terms outside the brackets and divide each term by it, leaving the result in brackets.

For example:

$10x + 15y$   
 HCF = 5  
 Result  $5(2x + 3y)$   
 HCF  $\nearrow$   $10x \div 5$   $\nwarrow$   $15y \div 5$

Alternative layout:

$? \quad ?$   
 $10x \quad +15y$  becomes  $5 \quad 10x \quad +15y$

So  $5(2x + 3y)$  is the factorised form.

- To check your answer, expand the factorised form; for example,  $5(2x + 3y) = 10x + 15y$ . ✓



## BUILDING UNDERSTANDING

- State all the factors of:
  - 20
  - 12
  - 15
  - 27
- The factors of 14 are 1, 2, 7 and 14. The factors of 26 are 1, 2, 13 and 26. What is the highest factor that these two numbers have in common?
- Find the highest common factor of the following pairs of numbers.
  - 12 and 18
  - 15 and 25
  - 40 and 60
  - 24 and 10
- State the missing terms to make these expansions correct.
  - $3(4x + 1) = \square x + 3$
  - $6(2 + 5y) = \square + \square y$
  - $3(2a + \square) = 6a + 21$
  - $7(\square + \square) = 14 + 7q$



## Example 14 Finding the highest common factor (HCF)

Find the highest common factor (HCF) of:

- 20 and 35
- $18a$  and  $24ab$
- $12x$  and  $15x^2$

## SOLUTION

a 5

## EXPLANATION

5 is the largest number that divides into 20 and 35.

b  $6a$

6 is the largest number that divides into 18 and 24, and  $a$  divides into both terms.

c  $3x$

3 divides into both 12 and 15, and  $x$  divides into both terms.

## Now you try

Find the HCF of:

- 24 and 36
- $15x$  and  $20xy$
- $12a$  and  $18a^2$



## Example 15 Factorising expressions

Factorise the following expressions.

- $6x + 15$
- $12a + 18ab$
- $21x - 14y$

## SOLUTION

a  $6x + 15 = 3(2x + 5)$

## EXPLANATION

HCF of  $6x$  and  $15$  is 3.  $6x \div 3 = 2x$  and  $15 \div 3 = 5$ .

b  $12a + 18ab = 6a(2 + 3b)$

HCF of  $12a$  and  $18ab$  is  $6a$ .  $12a \div (6a) = 2$   
and  $18ab \div (6a) = 3b$ .

*Continued on next page*

$$c \quad 21x - 14y = 7(3x - 2y)$$

HCF of  $21x$  and  $14y$  is 7.  $21x \div 7 = 3x$   
and  $14y \div 7 = 2y$ .

The subtraction sign is included as in the original expression.

### Now you try

Factorise the following expressions.

$$a \quad 12x + 30$$

$$b \quad 15a + 25ab$$

$$c \quad 18x - 15y$$

## Exercise 5H

### FLUENCY

1, 2–3(1/2)

2–4(1/2)

2–4(1/3)

Example 14a

- 1 Find the highest common factor (HCF) of the following numbers.

$$a \quad 8 \text{ and } 12$$

$$b \quad 20 \text{ and } 30$$

$$c \quad 21 \text{ and } 28$$

Example 14

- 2 Find the highest common factor (HCF) of the following pairs of terms.

$$a \quad 15 \text{ and } 10x$$

$$b \quad 20a \text{ and } 12b$$

$$c \quad 27a \text{ and } 9b$$

$$d \quad 7xy \text{ and } 14x$$

$$e \quad -2yz \text{ and } 4xy$$

$$f \quad 11xy \text{ and } -33xy$$

$$g \quad 8qr \text{ and } -4r$$

$$h \quad -3a \text{ and } 6a^2$$

$$i \quad 14p \text{ and } 25pq$$

Example 15a

- 3 Factorise the following by first finding the highest common factor. Check your answers by expanding them.

$$a \quad 3x + 6$$

$$b \quad 8v + 40$$

$$c \quad 15x + 35$$

$$d \quad 10z + 25$$

$$e \quad 40 + 4w$$

$$f \quad 5j - 20$$

$$g \quad 9b - 15$$

$$h \quad 12 - 16f$$

$$i \quad 5d - 30$$

Example 15b,c

- 4 Factorise the following expressions.

$$a \quad 10cn + 12n$$

$$b \quad 24y + 8ry$$

$$c \quad 14jn + 10n$$

$$d \quad 24g + 20gj$$

$$e \quad 10h + 4z$$

$$f \quad 30u - 20n$$

$$g \quad 40y + 56ay$$

$$h \quad 12d + 9dz$$

$$i \quad 21hm - 9mx$$

$$j \quad 49u - 21bu$$

$$k \quad 28u - 42bu$$

$$l \quad 21p - 6c$$

### PROBLEM-SOLVING

5

5, 6

6, 7

- 5 The rectangle shown has an area of  $10x + 15$ . Draw two different rectangles that would have an area  $12x + 16$ .

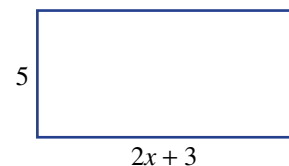

- 6 The area of the rectangle shown is  $10a + 5$ . One side's measurement is unknown.

- a What is the value of the unknown measurement?  
b Write an expression for the perimeter of the rectangle.

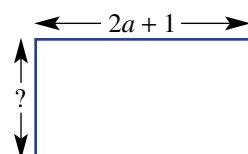

- 7 A group of students lines up for a photo. They are in 6 rows each with  $x$  students in each row. Another 18 students join the photo.
- Write an expression for the total number of students in the photo.
  - Factorise the expression above.
  - How many students would be in each of the 6 rows now? Write an expression.
  - If the photographer wanted just 3 rows, how many students would be in each row? Write an expression.
  - If the photographer wanted just 2 rows, how many students would be in each row? Write an expression.

**REASONING**

8

8, 9

8–10

- 8
- Expand  $2(x + 1) + 5(x + 1)$  and simplify.
  - Factorise your result.
  - Make a prediction about the equivalence of  $3(x + 1) + 25(x + 1)$  if it is expanded, simplified and then factorised.
  - Check your prediction by expanding and factorising  $3(x + 1) + 25(x + 1)$ .
- 9 Consider the diagram shown on the right. What is the factorised form of  $xy + 3x + 2y + 6$ ?

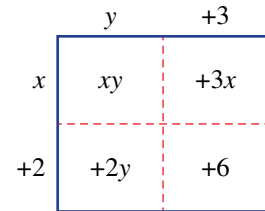

- 10 In English, people often convert between ‘factorised’ and ‘expanded’ sentences. For instance, ‘I like John and Mary’ is equivalent in meaning to ‘I like John and I like Mary’. The first form is factorised with the common factor that I like them. The second form is expanded.

- Expand the following sentences.
  - I eat fruit and vegetables.
  - Rohan likes Maths and English.
  - Petra has a computer and a television.
  - Hayden and Anthony play tennis and chess.
- Factorise the following sentences.
  - I like sewing and I like cooking.
  - Olivia likes ice-cream and Mary likes ice-cream.
  - Brodrick eats chocolate and Brodrick eats fruit.
  - Adrien likes chocolate and Adrien likes soft drinks, and Ben likes chocolate and Ben likes soft drinks.

**ENRICHMENT: Factorising fractions**

–

–

11(½)

- 11 Factorising can be used to simplify algebraic fractions. For example,  $\frac{5x + 10}{7x + 14}$  can be simplified by first factorising the numerator and the denominator  $\frac{5(\cancel{x+2})}{7(\cancel{x+2})} = \frac{5}{7}$ . Factorise and then simplify the following algebraic fractions as much as possible.

a  $\frac{2x + 4}{5x + 10}$

b  $\frac{7x - 7}{2x - 2}$

c  $\frac{3ac + 5a}{a + 2ab}$

d  $\frac{4a + 2b}{8c + 10d}$

e  $\frac{5q - 15}{3q - 9}$

f  $\frac{7p + 14pq}{9p + 18pq}$

g  $\frac{7a - 21}{2a - 6}$

h  $\frac{12p}{8p + 2pq}$

i  $\frac{100 - 10x}{20 - 2x}$

## 51 Applying algebra

### LEARNING INTENTIONS

- To be able to model simple situations using algebra
- To be able to write expressions from descriptions
- To understand that applying a model requires defining what the variables stand for

The skills of algebra can be applied to many situations within other parts of mathematics as well as to other fields such as engineering, sciences and economics.



Antennas convert digital data in a cable to electromagnetic waves, which are converted back to digital data in a smart phone. Antenna engineers require high-level mathematics, including algebra that uses  $d$  for antenna heights and  $\lambda$  for wavelengths.

### Lesson starter: Carnival conundrum

Alwin, Bryson and Calvin have each been offered special deals for the local carnival.

- Alwin can pay \$50 to go on all the rides all day.
- Bryson can pay \$20 to enter the carnival and then pay \$2 per ride.
- Calvin can enter the carnival at no cost and then pay \$5 per ride.
- Which of them has the best deal?
- In the end, each of them decides that they were happiest with the deal they had and would not have swapped. How many rides did they each go on? Compare your different answers.

### KEY IDEAS

- Different situations can be **modelled** with algebraic expressions.
- To apply a rule, the variables should first be clearly defined. Then known values are substituted for the variables.

### BUILDING UNDERSTANDING

1 Evaluate the expression  $3d + 5$  when:

a  $d = 10$

b  $d = 12$

c  $d = 0$

2 Find the value of  $30 + 10x$  when:

a  $x = 2$

b  $x = -1$

c  $x = -3$

3 Consider the isosceles triangle shown.

a Give an expression for the perimeter of the triangle.

b Find the perimeter when  $x = 3$  and  $y = 2$ .

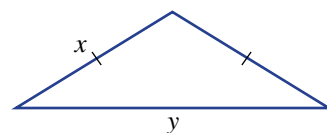



### Example 16 Writing expressions from descriptions

Write an expression for the following situations.

- a The total cost, in dollars, of  $k$  bottles if each bottle cost \$4
- b The area of a rectangle, in  $\text{cm}^2$ , if its length is 2 cm more than its width and its width is  $x$  cm
- c The total cost, in dollars, of hiring a plumber for  $n$  hours if they charge \$40 call-out fee and \$70 per hour

#### SOLUTION

- a  $4 \times k = 4k$
- b  $x \times (x + 2) = x(x + 2)$
- c  $40 + 70n$

#### EXPLANATION

Each bottle costs \$4 so the total cost is \$4 multiplied by the number of bottles purchased.

Width =  $x$  so length =  $x + 2$ .  
The area is length  $\times$  width.

\$70 per hour means that the cost to hire the plumber would be  $70 \times n$ . Additionally, \$40 is added for the call-out fee, which is charged regardless of how long the plumber stays.

#### Now you try

Write an expression for the following situations.

- a The total cost, in dollars, of  $n$  books if each book costs \$12
- b The perimeter of a rectangle, in cm, if its width is  $x$  cm and its length is 3 cm longer than the width
- c The total cost, in dollars, of hiring a plumber for  $n$  hours if he charges \$80 per hour on top of a \$35 call-out fee

## Exercise 51

### FLUENCY

1-4

2-5

3-5

Example 16a

- 1 If cookies cost \$5 each, find the total cost, in dollars, for

- a 3 cookies
- b 10 cookies
- c  $k$  cookies.

Example 16a

- 2 Pens cost \$3 each.

- a Write an expression for the total cost, in dollars, of  $n$  pens.
- b If  $n = 12$ , find the total cost.

Example 16b

- 3 a Write an expression for the total area of the shape shown.  
b If  $x = 9$ , what is the area?

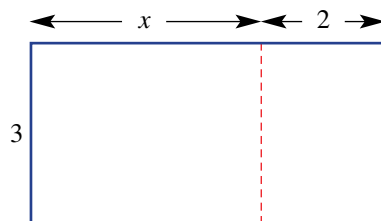

**Example 16c** 4 An electrician charges a call-out fee of \$30 and \$90 per hour. Which of the following represents the total cost, in dollars, for  $x$  hours?

- A  $x(30 + 90)$       B  $30x + 90$       C  $30 + 90x$       D  $120x$

- 5 a Give an expression for the perimeter of this regular pentagon.  
 b If each side length were doubled, what would the perimeter be?  
 c If each side length were increased by 3, write a new expression for the perimeter.

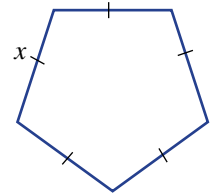

### PROBLEM-SOLVING

6, 7

6–8

7–9

- 6 An indoor soccer pitch costs \$40 per hour to hire plus a \$30 booking fee.  
 a Write an expression for the cost, in dollars, of hiring the pitch for  $x$  hours.  
 b Hence, find the cost of hiring the pitch for an 8-hour round-robin tournament.
- 7 A plumber says that the cost, in dollars, to hire her for  $x$  hours is  $50 + 60x$ .  
 a What is her call-out fee?  
 b How much does she charge per hour?  
 c If you had \$200, what is the longest period you could hire the plumber?
- 8 A repairman says the cost, in dollars, to hire his services for  $x$  hours is  $20(3 + 4x)$ .  
 a How much would it cost to hire him for 1 hour?  
 b Expand the expression he has given you.  
 c Hence, state:  
 i his call-out fee  
 ii the amount he charges per hour.
- 9 Three deals are available at a fair.  
 Deal 1: Pay \$10, rides cost \$4/each  
 Deal 2: Pay \$20, rides cost \$1/each  
 Deal 3: Pay \$30, all rides are free  
 a Write an expression for the total cost, in dollars, of  $n$  rides using deal 1. (The total cost includes the entry fee of \$10.)  
 b Write an expression for the total cost, in dollars, of  $n$  rides using deal 2.  
 c Write an expression for the total cost, in dollars, of  $n$  rides using deal 3.  
 d Which of the three deals is best for someone going on just two rides?  
 e Which of the three deals is best for someone going on 20 rides?  
 f Fill in the gaps.  
 i Deal 1 is best for people wanting up to \_\_\_\_\_ rides.  
 ii Deal 2 is best for people wanting between \_\_\_\_\_ and \_\_\_\_\_ rides.  
 iii Deal 3 is best for people wanting more than \_\_\_\_\_ rides.



## REASONING

10

10, 11

11, 12

- 10 In a particular city, taxis charge \$4 to pick someone up (flagfall) and then \$2 per minute of travel. Three drivers have different ways of calculating the total fare.
- Russell adds 2 to the number of minutes travelled and doubles the result.
  - Jessie doubles the number of minutes travelled and then adds 4.
  - Arash halves the number of minutes travelled, adds 1 and then quadruples the result.
- a Write an expression for the total cost, in dollars, of travelling  $x$  minutes in:
- Russell's taxi
  - Jessie's taxi
  - Arash's taxi.
- b Prove that all three expressions are equivalent by expanding them.
- c A fourth driver starts by multiplying the number of minutes travelled by 4 and then adding 8. What should he do to this result to calculate the correct fare?

- 11 Roberto draws a rectangle with unknown dimensions. He notes that the area is  $(x - 3)(y - 4)$ .

- a If  $x = 5$  and  $y = 7$ , what is the area?
- b What is the value of  $(x - 3)(y - 4)$  if  $x = 1$  and  $y = 1$ ?
- c Roberto claims that this proves that if  $x = 1$  and  $y = 1$ , then his rectangle has an area of 6. What is wrong with his claim?  
(Hint: Try to work out the rectangle's perimeter.)

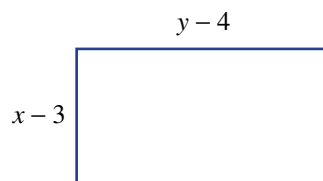

- 12 Tamir notes that whenever he hires an electrician, they charge a call-out fee,  $\$F$ , and an hourly rate of  $\$H$  per hour.
- Write an expression for the cost, in dollars, of hiring an electrician for one hour.
  - Write an expression for the cost, in dollars, of hiring an electrician for two hours.
  - Write an expression for the cost, in dollars, of hiring an electrician for 30 minutes.
  - How much does it cost to hire an electrician for  $t$  hours?

## ENRICHMENT: Ticket sales

-

-

13

- 13 At a carnival there are six different deals available to reward loyal customers.

Deal	Entry cost (\$)	Cost per ride (\$)
A	79	0
B	50	2
C	31	4
D	18	6
E	7	8
F	0	10

The queue consists of 100 customers. The first customer knows they will go on 1 ride, the second will go on 2 rides, and the pattern continues, with the 100th customer wanting to go on 100 rides. Assuming that each customer can work out their best deal, how many of each deal will be sold?

The following problems will investigate practical situations drawing upon knowledge and skills developed throughout the chapter. In attempting to solve these problems, aim to identify the key information, use diagrams, formulate ideas, apply strategies, make calculations and check and communicate your solutions.

## Locker numbers at Southmall School

- 1 Mrs Whitton is the Year 8 Coordinator at Southmall School and at the start of the year she likes to allocate lockers to each of her students through providing them with an algebraic expression connected to their name.

The variable  $f$  stands for the number of letters in a student's first name.

The variable  $s$  stands for the number of letters in a student's surname.

*Holly Newland, a Year 8 student of Mrs Whitton, is interested in what locker number she will have depending on the algebraic expression provided by Mrs Whitton.*

- a What is Holly Newland's value of  $f$  and her value of  $s$ ?
- b Mrs Whitton allocates Holly Newland to her locker by giving her a slip of paper with the following algebraic expression:  $4f + 5s$ . What number is Holly's locker?
- c If you were given the same algebraic expression as Holly, what would be your locker number?
- d Holly Newland asked Mrs Whitton if she could swap to a downstairs locker, where the numbers are all less than 20. Mrs Whitton issued Holly with a new algebraic expression:  $5f - 3s$ . What is Holly's new locker number?
- e Write an algebraic expression for Holly Newland that can allocate her to:
  - i locker 1
  - ii locker 72
  - iii locker 132.
- f Write three equivalent algebraic expressions that would allocate Ali Zhang to locker 20.



## Weekly profits of a school cafeteria

- 2 Patricia runs the school cafeteria on behalf of the Parents' Association. The cafeteria is the main income stream for the Parents' Association and at the end of the year the profit from the cafeteria is gifted back to the school in the form of a gift from the Parents' Association. This year they are hoping to raise as much funds as possible to go towards new musical instruments.



Below are the cost price and sale price for the main three lunch items in the school cafeteria, along with the most recent weekly sales of these items.

Cost price = the item price the cafeteria pays to buy the food for the school.

Sale price = the item price the cafeteria charges the students for the food.

Lunch item	Cost price	Sale price	Weekly sales
Californian rolls	\$2.40	\$3.50	400
Sausage rolls	\$2.80	\$3.50	230
Variety of healthy wraps	\$4.20	\$4.50	600

*The Parents' Association is interested in using algebra to come up with the most effective way of maximising the cafeteria's weekly profit.*

- Using the variables,  $P$  for Profit,  $c$  for the number of Californian rolls,  $s$  for the number of sausage rolls, and  $w$  for the number of wraps, write an algebraic equation for the weekly profit in terms of weekly sales for the three major lunch items.
- What was the overall weekly profit for the above weekly sales?

Patricia thinks she may be able to increase the weekly profit by raising the sales price of the items and hoping that the weekly sales numbers do not decrease too much. The table below shows the new prices for the lunch items and the weekly sales for the first week following the price rise.

Lunch item	Cost price	Sale price	Weekly sales
Californian rolls	\$2.40	\$3.90	300
Sausage rolls	\$2.80	\$3.60	240
Variety of healthy wraps	\$4.20	\$5.20	510

- Write a new algebraic equation for the weekly profit in terms of weekly sales for the three major lunch items.
- What was the overall weekly profit for the week following the price rises?
- Was Patricia's decision to raise the prices effective in increasing the weekly profit?

Assume now that the cafeteria chose to only sell wraps and they wanted to make a weekly profit of \$1200.

- How many wraps would they need to sell if the sale price was \$4.90?
- How much would they need to sell the wraps for if they were able to sell 800?



## Supermarket staff salary costs

- 3 The local supermarket employs many full-time, part-time and casual staff to provide high quality service to their customers for the 16 hours they are open each day of the year.

The staff conditions and salary rates for each group of employees is outlined below:

**Full-time staff** – work 40 hours per week, are paid at a rate of \$24.15/hour and are eligible for sick leave and annual leave.

**Part-time staff** – work 30 hours per week, are paid at a rate of \$26.60/hour plus a 5% loading in recognition that they are not eligible for sick leave or annual leave.

**Casual staff** – work a 5-hour shift and can work up to one shift per day. Casual staff are not eligible for sick leave or annual leave and are not permitted to take tea breaks during their shift.

Casual staff under the age of 21 are called Junior Casual staff and are paid at a rate of \$17.20/hour + \$12 bonus loading/shift.

Casual staff over the age of 21 are called Senior Casual staff and are paid at a rate of \$21.20/hour + \$16 bonus loading/shift.

*The supermarket manager, Maria, needs to fully understand her staffing costs, allocating enough staff to ensure great service while also minimising overall salary costs.*

- Explain the following algebraic expression for the full-time salary costs:  $24.15 \times 40 \times f$
- Write an algebraic expression for the part-time salary costs.
- Write an algebraic expression for the Junior Casual staff salary costs.
- Write an algebraic expression for the Senior Casual staff salary costs.
- Write an algebraic expression for the overall salary costs for the supermarket.

For the first week in January, Maria employs the following number of staff.

Type of staff member	Number employed	Number of shifts
Full-time staff	32	N/A
Part-time staff	24	N/A
Junior Casual staff	N/A	90
Senior Casual staff	N/A	76

- Using your expressions from above, calculate the overall salary cost for the supermarket for the week.
- What was the total number of hours worked by staff at the supermarket during this week?
- What was the overall average salary per hour for the staff who worked at the supermarket during this week?
- Can you help Maria find a cheaper way to provide the same overall service to the customers, in other words, the same number of total hours worked, but for a smaller overall staffing cost?



## 5J Index laws for multiplication and division

### LEARNING INTENTIONS

- To understand the meaning of an expression in the form  $a^n$  in terms of repeated multiplication of  $a$
- To know the meaning of the terms base, index (plural indices) and expanded form
- To be able to apply the index law for multiplying terms with the same base
- To be able to apply the index law for dividing terms with the same base

Recall that  $x^2$  means  $x \times x$  and  $x^3$  means  $x \times x \times x$ . Index notation provides a convenient way to describe repeated multiplication.

$$\begin{array}{c}
 \text{index or exponent} \\
 \swarrow \\
 3^5 = 3 \times 3 \times 3 \times 3 \times 3 \\
 \nwarrow \\
 \text{base}
 \end{array}$$

Notice that  $3^5 \times 3^2 = \underbrace{3 \times 3 \times 3 \times 3 \times 3}_{3^5} \times \underbrace{3 \times 3}_{3^2}$  which means that  $3^5 \times 3^2 = 3^7$ . Similarly it can be

shown that  $2^6 \times 2^5 = 2^{11}$ . When dividing, note that:

$$\begin{aligned}
 \frac{5^{10}}{5^7} &= \frac{5 \times 5 \times 5 \times 5 \times 5 \times 5 \times 5 \times 5 \times 5 \times 5}{5 \times 5 \times 5 \times 5 \times 5 \times 5 \times 5} \\
 &= 5 \times 5 \times 5
 \end{aligned}$$

So  $5^{10} \div 5^7 = 5^3$ . These observations are generalised into index laws.

### Lesson starter: Comparing powers

- Arrange these numbers from smallest to largest.  
 $2^3, 3^2, 2^5, 4^3, 3^4, 2^4, 4^2, 5^2, 1^{20}$
- Did you notice any patterns?
- If all the bases were negative, how would that change your arrangement from smallest to largest? For example,  $2^3$  becomes  $(-2)^3$ .

### KEY IDEAS

- Expressions involving repeated multiplication can be expressed using a **base** and an **index** (plural indices) in **index notation**.

$$\begin{array}{c}
 \text{index or exponent} \\
 \swarrow \\
 a^n = \underbrace{a \times a \times \dots \times a}_{n \text{ copies of } a} \\
 \nwarrow \\
 \text{base}
 \end{array}$$

For example:  $2^6 = 2 \times 2 \times 2 \times 2 \times 2 \times 2 = 64$

- An expression such as  $4x^3$  can be written in **expanded form** as  $4 \times x \times x \times x$ .
- **Index law for multiplying powers** with the same base:  $a^m \times a^n = a^{m+n}$  (e.g.  $a^4 \times a^2 = a^6$ ).
- **Index law for dividing powers** with the same base:  $a^m \div a^n = \frac{a^m}{a^n} = a^{m-n}$  (e.g.  $a^8 \div a^5 = a^3$ ).

## BUILDING UNDERSTANDING

- 1 State the missing numbers. In the expression  $5^7$  the base is \_\_\_\_\_ and the exponent is \_\_\_\_\_.
- 2 Which of the following expressions is the same as  $3^5$ ?  
**A**  $3 \times 5$       **B**  $3 \times 3 \times 3 \times 3 \times 3$       **C**  $5 \times 5 \times 5$       **D**  $5 \times 5 \times 5 \times 5 \times 5$
- 3 **a** Calculate the value of:  
**i**  $2^2$       **ii**  $2^3$       **iii**  $2^5$       **iv**  $2^6$   
**b** Is  $2^2 \times 2^3$  equal to  $2^5$  or  $2^6$ ?
- 4 **a** State  $5^3$  in expanded form.  
**b** State  $5^4$  in expanded form.  
**c** Give the result of multiplying  $5^3 \times 5^4$  in expanded form.  
**d** Which of the following is the same as  $5^3 \times 5^4$ ?  
**A**  $5^{12}$       **B**  $5^5$       **C**  $5^7$       **D**  $5^1$



## Example 17 Multiplying powers

Simplify the following using the index law for multiplication.

**a**  $5^3 \times 5^7 \times 5^2$       **b**  $x^3 \times x^4$       **c**  $a^5 \times a \times a^3$       **d**  $2x^4y^3 \times 5x^2y^8$

## SOLUTION

**a**  $5^3 \times 5^7 \times 5^2 = 5^{12}$

**b**  $x^3 \times x^4 = x^7$

**c**  $a^5 \times a \times a^3 = a^5 \times a^1 \times a^3$   
 $= a^9$

**d**  $2x^4y^3 \times 5x^2y^8$   
 $= 2 \times 5 \times x^4 \times x^2 \times y^3 \times y^8$   
 $= 10x^6y^{11}$

## EXPLANATION

$3 + 7 + 2 = 12$  and use the index law for multiplication (using  $a = 5$ ).

Using the index law for multiplication  
 $3 + 4 = 7$ , so  $x^3 \times x^4 = x^7$ .

Write  $a$  as  $a^1$  so the index law can be used.  
 $5 + 1 + 3 = 9$ , so the final result is  $a^9$ .

Bring all the numbers to the front of the expression and then bring the pronumerals together.

$x^4 \times x^2 = x^6$  and  $y^3 \times y^8 = y^{11}$  by the index law for multiplication and  $2 \times 5 = 10$ .

## Now you try

Simplify the following using the index law for multiplication.

**a**  $3^5 \times 3^2 \times 3^4$       **b**  $a^4 \times a^2$       **c**  $b^4 \times b^2 \times b$       **d**  $3x^2y^5 \times 4x^5y^{11}$



### Example 18 Dividing powers

Simplify the following using the index law for division.

a  $\frac{10^8}{10^5}$

b  $\frac{u^{20}}{u^5}$

c  $\frac{10x^6}{4x^2}$

d  $\frac{a^{10}b^6}{a^3b^2}$

#### SOLUTION

a  $\frac{10^8}{10^5} = 10^3$

b  $\frac{u^{20}}{u^5} = u^{15}$

c  $\frac{10x^6}{4x^2} = \frac{10}{4} \times \frac{x^6}{x^2}$   
 $= \frac{5}{2} \times x^4$   
 $= \frac{5x^4}{2}$

d  $\frac{a^{10}b^6}{a^3b^2} = a^7b^4$

#### EXPLANATION

Using the index law for division with  $8 - 5 = 3$  and  $a = 10$ .

Use the index law for division so  $20 - 5 = 15$ .

First separate the numbers into a separate fraction.

Cancel the common factor of 2 and use the index law for division.

Combine the result as a single fraction.

The two letters are treated separately, with  $10 - 3 = 7$  and  $6 - 2 = 4$ .

#### Now you try

Simplify the following using the index law for division.

a  $\frac{5^{10}}{5^6}$

b  $\frac{x^{12}}{x^3}$

c  $\frac{12a^5}{8a^2}$

d  $\frac{a^{11}b^7}{a^5b^2}$

## Exercise 5J

### FLUENCY

1, 2-3( $\frac{1}{2}$ ), 5-6( $\frac{1}{2}$ )

2-6( $\frac{1}{2}$ )

2-6( $\frac{1}{4}$ )

Example 17a

1 Simplify the following using the index law for multiplication.

a  $4^2 \times 4^3$

b  $5^2 \times 5^2$

c  $3^3 \times 3^4$

d  $10^5 \times 10^3$

Example 17a

2 Simplify the following, giving your answers in index form.

a  $4^3 \times 4^5$

b  $3^{10} \times 3^2$

c  $2^{10} \times 2^5 \times 2^3$

d  $7^2 \times 7 \times 7^3$

Example 17b,c

3 Simplify the following using the index law for multiplication.

a  $m^3 \times m^4$

b  $x^2 \times x^4$

c  $q^{10} \times q^3$

d  $r^7 \times r^2$

e  $m^2 \times m^4 \times m^3$

f  $a^2 \times a^4 \times a^3$

g  $r^2 \times r^3 \times r^4$

h  $z^{10} \times z^{12} \times z^{14}$

i  $k \times k^3$

j  $j^2 \times j$

k  $m^4 \times m^3 \times m$

l  $x^2 \times x \times x$

Example 17d

4 Simplify the following using the index law for multiplication.

- |   |  |   |                           |   |                          |   |                            |
|---|--|---|---------------------------|---|--------------------------|---|----------------------------|
| a | $4m^2 \times 5m^3$                     | b | $2k^3 \times 5k^4$        | c | $7x^2 \times 4x^{12}$    | d | $4y^3 \times 7y^{10}$      |
| e | $m^2 \times n^3 \times m^4 \times n^7$ | f | $x^2y \times y^2$         | g | $3r^3s^2 \times s^5$     | h | $2y^{10}z^2 \times y^5z^3$ |
| i | $11x \times 10x^3$                     | j | $3a \times 5a \times a^4$ | k | $2x^2y^2 \times 4x^3y^5$ | l | $7a^2b^3 \times 2a^3b$     |
| m | $-7x^2y^3 \times 2x^5y$                | n | $-4ab^2 \times a^4b$      | o | $2c^4d \times (-8c^2)$   | p | $7x \times 12x^3y^5$       |

Example 18a

5 Simplify the following, giving your answers in index form.

- |   |                   |   |                        |   |                      |   |                          |
|---|-------------------|---|------------------------|---|----------------------|---|--------------------------|
| a | $\frac{3^7}{3^2}$ | b | $\frac{10^{15}}{10^7}$ | c | $\frac{2^{10}}{2^5}$ | d | $\frac{5^{100}}{5^{98}}$ |
|---|-------------------|---|------------------------|---|----------------------|---|--------------------------|

Example 18b-d

6 Simplify the following using the index law for division.

- |   |                         |   |                            |   |                                   |   |                            |
|---|-------------------------|---|----------------------------|---|-----------------------------------|---|----------------------------|
| a | $\frac{m^5}{m^2}$       | b | $\frac{z^5}{z^2}$          | c | $\frac{q^{10}}{q^3}$              | d | $\frac{r^{10}}{r}$         |
| e | $\frac{m^5n^7}{m^3n^2}$ | f | $\frac{a^{10}b^5}{a^5b^2}$ | g | $\frac{x^3y^{10}z^5}{x^2y^4z^3}$  | h | $\frac{x^4y^7z^3}{x^2y^4}$ |
| i | $\frac{4k^{10}}{k^7}$   | j | $\frac{10m^{20}}{5m^7}$    | k | $\frac{30x^{20}y^{12}}{18x^2y^5}$ | l | $\frac{a^3b}{2ab}$         |

## PROBLEM-SOLVING

7

7, 8

8, 9

- 7 Given that  $2^{12} = 4096$  and  $2^8 = 256$ , find the number that makes this equation true:  $256 \times ? = 4096$
- 8 John enters  $2^{10000} \div 2^{9997}$  into his calculator and he gets the error message 'Number Overflow', because  $2^{10000}$  is too large.
- a According to the index law for division, what does  $2^{10000} \div 2^{9997}$  equal? Give your final answer as a number.
- b Find the value of  $(5^{2000} \times 5^{2004}) \div 5^{4000}$ .
- c What is the value of  $\frac{3^{700} \times 3^{300}}{3^{1000}}$ ?
- 9 Find values of  $a$  and  $b$  so that  $a < b$  and  $a^b = b^a$ .

## REASONING

10

10, 11

11-13



- 10 A student tries to simplify  $3^2 \times 3^4$  and gets the result  $9^6$ .
- a Use a calculator to verify this is incorrect.
- b Write out  $3^2 \times 3^4$  in expanded form, and explain why it is not the same as  $9^6$ .
- c Explain the mistake they have made in attempting to apply the index law for multiplication.
- 11 Recall that  $(-3)^2$  means  $-3 \times (-3)$ , so  $(-3)^2 = 9$ .
- a Evaluate:
- |   |          |    |          |     |          |    |          |
|---|----------|----|----------|-----|----------|----|----------|
| i | $(-2)^2$ | ii | $(-2)^3$ | iii | $(-2)^4$ | iv | $(-2)^5$ |
|---|----------|----|----------|-----|----------|----|----------|
- b Complete the following generalisations.
- i A negative number to an even power is \_\_\_\_\_.
- ii A negative number to an odd power is \_\_\_\_\_.
- c Given that  $2^{10} = 1024$ , find the value of  $(-2)^{10}$ .

- 12 a Use the index law for division to write  $\frac{5^3}{5^3}$  in index form.
- b Given that  $5^3 = 125$ , what is the numerical value of  $\frac{5^3}{5^3}$ ?
-  c According to this, what is the value of  $5^0$ ? Check whether this is also the result your calculator gives.
- d What is the value of  $12^0$ ?
- 13 a If  $\frac{3^a}{3^b} = 9$ , what does this tell you about the value of  $a$  and  $b$ ?
- b Given that  $\frac{2^a}{2^b} = 8$ , find the value of  $\frac{5^a}{5^b}$ .

**ENRICHMENT: Scientific notation for timescales**

-

-

14

- 14 Using indices, we can express very large numbers and very small numbers easily. For example, 8 000 000 can be written as  $8 \times 10^6$  (an 8 followed by six zeros) and 0.0003 can be written as  $3 \times 10^{-4}$  (there are four zeros and then a 3). This is called scientific notation.
- a Express the following numbers in scientific notation.
- i 50 000                      ii 7 000 000 000                      iii 0.005                      iv 0.0000002
- b The following time scales have been written in scientific notation. Rewrite them as regular numbers.
- i  $2 \times 10^6$  hours (the time it takes Pluto to orbit the Sun)
- ii  $4 \times 10^7$  days (the time it takes for light to travel from one side of the Milky Way to the other)
- iii  $3 \times 10^{-3}$  seconds (the time it takes sound to travel one metre)
- iv  $3 \times 10^{-9}$  seconds (the time it takes light to travel one metre)
- c Sometimes scientific notation can be avoided by choosing a more appropriate unit of time (e.g. days instead of seconds). Rewrite the following timescales using the given units.
- i  $3 \times 10^6$  seconds (using days)                      ii  $9 \times 10^8$  milliseconds (using hours)
- iii  $2 \times 10^{-4}$  hours (using seconds)                      iv  $5 \times 10^{-8}$  days (using milliseconds)

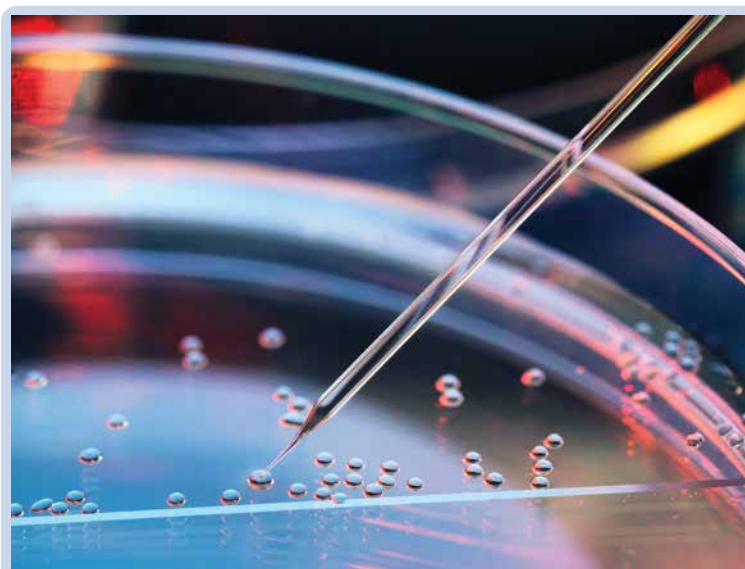

Scientific notation is especially useful when working with very large and very small numbers.

## 5K The zero index and power of a power

### LEARNING INTENTIONS

- To understand the meaning of an expression like  $(b^4)^2$
- To be able to simplify expressions in which the index is zero
- To be able to simplify expressions involving powers of powers
- To be able to expand expressions where a product is taken to a power, e.g.  $(ab)^3$

Consider what the expanded form of  $(a^3)^4$  would be:

$$\begin{aligned}(a^3)^4 &= a^3 \times a^3 \times a^3 \times a^3 \\ &= a \times a \times a \times a \times a \times a \times a \times a \times a \times a \times a \times a \\ &= a^{12}\end{aligned}$$

Similarly:

$$\begin{aligned}(b^4)^2 &= b^4 \times b^4 \\ &= b \times b \times b \times b \times b \times b \times b \times b \\ &= b^8\end{aligned}$$

This leads us to an index law:  $(a^m)^n = a^{mn}$ .

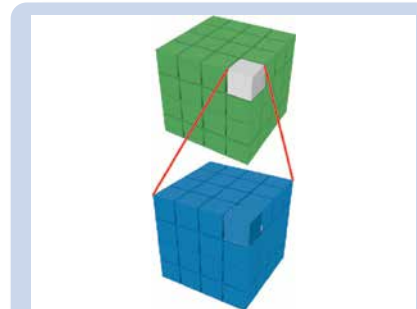

The pictorial representation of  $(4^3)^2$ . Each of the  $4^3$  green cubes in the top figure is made up of  $4^3$  tiny blue cubes shown magnified in the lower figure. How many blue cubes are there in total?

### Lesson starter: How many factors?

The number 7 has two factors (1 and 7) and the number  $7^2$  has three factors (1, 7 and 49).

- Which of these has the most factors?

$$7^5 \qquad 7^2 \times 7^3 \qquad (7^2)^3 \qquad \frac{7^{10}}{7^6}$$

- Which has more factors:  $7^{10}$  or  $10^7$ ? Compare your answers with others in your class.

### KEY IDEAS

- $a^0 = 1$  for every value of  $a$  except 0. For example:  $4^0 = 1$  and  $(73xy)^0 = 1$ .
- A power of a power can be simplified by multiplying indices:  $(a^m)^n = a^{mn}$  (e.g.  $(x^2)^5 = x^{10}$ ).
- Expressions involving powers can be expanded, so  $(3x)^4 = 3^4x^4$  and  $(2y)^{10} = 2^{10}y^{10}$ .

### BUILDING UNDERSTANDING

- Which one of the following is the expanded form of  $5^3$ ?  
 A  $5 \times 5 \times 5$       B  $5 \times 3$       C  $5 + 5 + 5$       D  $5 \times 5 \times 3$
- Which one of the following is equivalent to  $(a^3)^2$ ?  
 A  $a \times a \times a$       B  $a^3 \times a^3$       C  $a^2 \times a^2$       D  $a \times 3 \times 2$
- Which of the following is equivalent to  $(3x)^2$ ?  
 A  $3 \times x$       B  $3 \times x \times x$       C  $3 \times x \times 3 \times x$       D  $3 \times 3 \times x$



**Example 19 Working with zero powers**

Simplify the following expressions using the index laws.

**a**  $10^0 + 5^0$

**b**  $(4x)^0 \times (8xy)^0$

**c**  $4x^0 \times 8xy^0$

**SOLUTION**

**a**  $10^0 + 5^0 = 1 + 1$   
 $= 2$

**b**  $(4x)^0 \times (8xy)^0 = 1 \times 1$   
 $= 1$

**c**  $4x^0 \times 8xy^0 = 4(1) \times 8x(1)$   
 $= 32x$

**EXPLANATION**Recall  $10^0 = 1$  and  $5^0 = 1$  by the index law for zero powers.Any bracketed expression to the power 0 equals 1, so  $(4x)^0 = 1$  and  $(8xy)^0 = 1$ . $4x^0$  means  $4 \times x^0$ , which is  $4 \times 1$ . Similarly,  $8xy^0$  means  $8 \times x \times y^0 = 8 \times x \times 1$ .**Now you try**

Simplify the following expressions using the index laws.

**a**  $4^0 + 2^0 + 3^0$

**b**  $(3a)^0 \times (bc)^0 + 7^0$

**c**  $5a^0 \times 6b^0c$

**Example 20 Simplifying powers of power**

Simplify the following expressions using the index laws.

**a**  $(2^3)^5$

**b**  $(5x^3)^2$

**c**  $(u^2)^4 \times (7u^3)^2$

**SOLUTION**

**a**  $(2^3)^5 = 2^{15}$

**b**  $(5x^3)^2 = 5^2(x^3)^2$   
 $= 5^2x^6$

**c**  $(u^2)^4 \times (7u^3)^2 = u^8 \times 7^2u^6$   
 $= 7^2u^{14}$

**EXPLANATION** $3 \times 5 = 15$ , so we can apply the index law easily.

Expand the brackets to square both terms within them.

 $3 \times 2 = 6$ , so  $(x^3)^2 = x^6$ .Apply the index law with  $2 \times 4 = 8$ .Apply the first index law:  $u^8 \times u^6 = u^{14}$ .**Now you try**

Simplify the following expressions using the index laws.

**a**  $(3^2)^6$

**b**  $(2a^5)^3$

**c**  $(a^3)^4 \times (4a^5)^2$

## Exercise 5K

## FLUENCY

1, 2–4(1/2)

2–5(1/2)

2–5(1/3)

Example 19a

1 Simplify the following expressions using the index laws.

a  $3^0$

b  $4^0 + 7^0$

c  $11^0 - 6^0$

d  $3 \times 5^0$

Example 19

2 Simplify the following.

a  $7^0$

b  $5^0 \times 3^0$

c  $5b^0$

d  $12x^0y^2z^0$

e  $(3x^2)^0$

f  $13(m + 3n)^0$

g  $2(x^0y)^2$

h  $4x^0(4x)^0$

i  $3(a^5y^2)^0a^2$

Example 20a

3 Simplify the following.

a  $(2^3)^4$

b  $(5^2)^8$

c  $(6^4)^9$

d  $(d^3)^3$

e  $(k^8)^3$

f  $(m^5)^{10}$

Example 20b

4 Simplify the following. Large numerical powers like  $5^4$  should be left in index form.

a  $(3x^5)^2$

b  $(2u^4)^3$

c  $(5x^5)^4$

d  $(12x^5)^3$

e  $(4x^4)^2$

f  $(7x^2)^2$

g  $(9x^7)^{10}$

h  $(10x^2)^5$

Example 20c

5 Simplify the following using the index laws.

a  $(x^3)^2 \times (x^5)^3$

b  $(y^2)^6 \times (y^3)^2$

c  $(2k^4)^2 \times (5k^5)^3$

d  $(m^3)^6 \times (5m^2)^2$

e  $4(x^3)^2 \times 2(x^4)^3$

f  $5(p^2)^6 \times (5p^2)^3$

g  $\frac{(y^3)^4}{y^2}$

h  $\frac{(p^7)^2}{(p^3)^2}$

i  $\frac{(2p^5)^3}{2^2p^2}$

j  $\frac{(3x^2)^{10}}{(x^3)^2}$

k  $\frac{8h^{20}}{(h^3)^5}$

l  $\frac{(q^2)^{10}}{(q^3)^6}$

## PROBLEM-SOLVING

6

6–8

7–9

6 Find the missing value that would make the following simplifications correct.

a  $(7^3)^\square = 7^{15}$

b  $(x^\square)^4 = x^{12}$

c  $(x^2)^3 \times x^\square = x^{11}$

d  $(x^4)^\square \times (x^3)^2 = x^{14}$

7 a Use the fact that  $(x^2)^3 = x^6$  to simplify  $((x^2)^3)^4$ .b Simplify  $((x^3)^4)^5$ .

c Put the following numbers into ascending order. (You do not need to calculate the actual values.)

$2^{100}, (2^7)^{10}, ((2^5)^6)^7, ((2^3)^4)^5$

8 a How many zeros do the following numbers have?

i  $10^2$

ii  $10^5$

iii  $10^6$

b How many zeros does the number  $(10^5 \times 10^6 \times 10^7)^3$  have?9 a Simplify  $x^3 \times x^4$ .b Simplify  $(x^3)^4$ .c Explain why  $x^3 \times x^4$  is not equivalent to  $(x^3)^4$ .d Find the two values of  $x$  that make  $x^3 \times x^4$  and  $(x^3)^4$  equal.

## REASONING

10

10, 11

11–13

10 For this question, you will be demonstrating why  $a^0$  should equal 1 for any value of  $a$  other than zero.

- State the value of  $\frac{5^2}{5^2}$ .
- Use the index law for division to write  $\frac{5^2}{5^2}$  as a power of 5.
- Use this method to demonstrate that  $3^0$  should equal 1.
- Use this method to demonstrate that  $100^0$  should equal 1.
- Explain why you cannot use this method to show that  $0^0$  should equal 1.

11 Ramy is using his calculator and notices that  $(2^3)^4 = (2^6)^2$ .

- Explain why this is the case.
- Which of the following are also equal to  $(2^3)^4$ ?  
**A**  $(2^4)^3$                       **B**  $(2^2)^6$                       **C**  $(4^2)^3$                       **D**  $(4^3)^2 \times (6^2)^2$
- Freddy claims that  $(2^5)^6$  can be written in the form  $(4^{\square})^{\square}$ . Find one way to fill in the two missing values.

12 a According to the index laws, what number is equal to  $(9^{0.5})^2$ ?

b What positive number makes the equation  $x^2 = 9$  true?

-  c What should  $9^{0.5}$  equal according to this? Check on a calculator.
- d Use this observation to predict the value of  $36^{0.5}$ .

13 Alexios notices that  $\frac{(a^3)^2 \times a^4}{(a^2)^5}$  is always equal to one, regardless of the value of  $a$ .

- Simplify the expression above.
- Give an example of two other expressions that will always equal 1 because of the index laws.

## ENRICHMENT: Combining index laws

–

–

14(1/2)

14 Simplify the following using the index laws.

a  $\frac{(5x^2)^3 \times (5x^3)^4}{(5x^6)^3}$

b  $\frac{(x^2)^4}{x^3} \times \frac{x^7}{(x^2)^2}$

c  $\frac{(x^2y^3)^4 \times (x^3y^2)^5}{(xy)^7 \times (x^2y)^6}$

d  $\frac{(a^2b^3c^4)^{10}}{a^{10}b^{20}c^{30}} \div \frac{a^3}{b^2}$

e  $\frac{(x^{20}y^{10})^5}{(x^{10}y^{20})^2}$

f  $\frac{(7^8)^9}{(7^{10})^7}$

g  $\frac{(7^6)^5}{(7^5)^6}$

h  $\frac{5^{11} \times 5^{13}}{(5^2)^{11}}$

i  $\frac{100^{20}}{1000^{12}}$



Index laws are routinely applied by financial analysts and planners, investment advisors and accountants; for example, when calculating the amount \$A to be invested at  $i\%$  interest per month that will provide regular payments \$P for  $n$  months.



## Extension questions

Rather than using square tiles, Tommy sometimes uses rectangular tiles that require two spacers on the longer sides and one spacer on the shorter sides as shown.

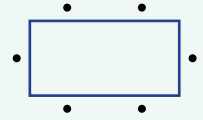

- a Find an expression for the number of spacers required for  $m$  rows of  $n$  columns of these rectangular tiles.
- b Determine the number of:
  - i spacers required for 7 rows with 9 columns
  - ii tiles used if 278 spacers are needed (you should also say how many rows and columns are required).



## Shortcuts to large sums

### Key technology: Spreadsheets and programming

Whenever we see patterns in the real world, we can try to describe the pattern using numbers and pronumerals. For example, the cost of hiring a car for  $n$  days will reveal a number pattern that will depend on the pronumeral  $n$ ; or the total population of people infected by a virus where the number of new infections is increasing by 20% per week will also form a number pattern. Such number patterns can be described using algebraic expressions and it is these expressions which help us make calculations regarding the value of a particular term in the pattern or the total sum of the terms in a pattern up to a particular point.

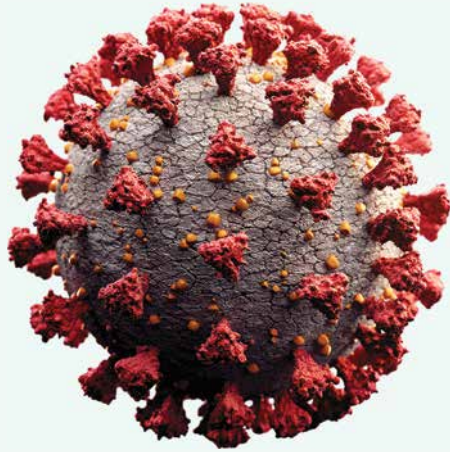

### 1 Getting started

We will start by considering the set of even numbers as shown in this table where:

- $n$  represents the even number
- $t_n$  is the  $n$ th even number
- $S_n$  represents the sum of all the even numbers up to and including the  $n$ th even number.

$n$	1	2	3	4	5	6	7	8
$t_n$	2	4	6	8	10			
$S_n$	2	6	12					

- a The second even number  $t_2$  is 4. State:
  - i the fourth even number,  $t_4$
  - ii the seventh even number,  $t_7$ .
- b The sum of the first two even numbers  $S_2$  is 6. State:
  - i the sum of the first three even numbers,  $S_3$
  - ii the sum of the first five even numbers,  $S_5$ .
- c Complete the table above and describe any patterns that you see.
- d Write an expression for the  $n$ th even number,  $t_n$  using the pronumeral  $n$ . Use your expression to find the 8th even number and check this against your completed table.
- e Evaluate the expression  $n(n + 1)$  for the following values of  $n$ . What do you notice about your answers and the numbers produced in the table above?
  - i 3
  - ii 6
  - iii 8
- f Use the expression given in part e to find the sum of the first 20 even numbers,  $S_{20}$ .

### 2 Applying an algorithm

We will now use an algorithm as shown to explore the sum of the odd numbers.

- $m$  is how many odd numbers you wish to sum.
- $n$  represents the odd number.

- $t_n$  is the  $n$ th odd number.
- $S_n$  represents the sum of all the odd numbers up to and including the  $n$ th odd number.
  - Run through the algorithm for  $m = 5$ . State the output using this table.

$n$	1	2	3	4	5
$t_n$	1	3			
$S_n$	1				

- What do you notice about the values of  $t_n$  in relation to the value of  $n$ ? Write an expression that gives the value of  $t_n$  using the  $n$  value.
- What do you notice about the values of  $S_n$  in relation to the value of  $n$ ? Write an expression that gives the value of  $S_n$  using the  $n$  value.
- Use your expression in part **c** to find the sum of the first 10 odd numbers,  $S_{10}$ .

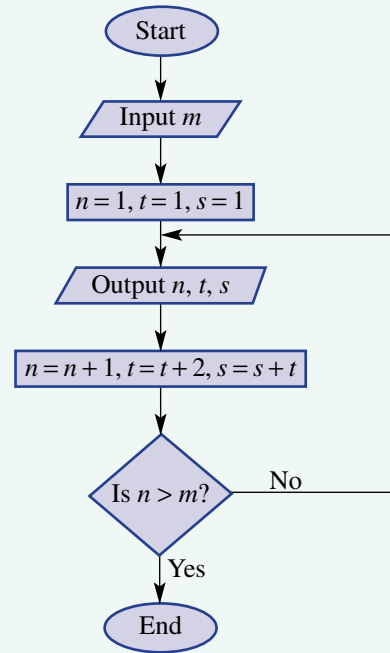

### 3 Using technology

A spreadsheet will be used to apply the above algorithm and generate the sum of odd numbers that were studied above in part 2.

- Construct the following spreadsheet that generates the sequence of odd numbers and the total sum.
- Fill down at cells A6, B6 and C5 for at least 10 rows. Check that your results agree with the results generated in part 2 above.
- Now generate a similar spreadsheet but this time use your expressions from part 2b and 2c above.
- Fill down at cells E6, F5 and G5 for at least 10 rows. Check that your results agree with the results generated in part b above.

	A	B	C
1	Generating patterns		
2			
3	$n$	$t$	$s$
4			
5	1	1	=B5+C4
6	=A5+1	=B5+2	
7			

	E	F	G
	Patterns with expressions		
	$n$	$t$	$s$
	1	=2*E5-1	=E5^2
	=E5+1		

### 4 Extension

- Consider the sum  $1 + 2 + 3 + 4 + \dots + n$ . Create a flow chart that would generate the values of  $n$ ,  $t_n$  and  $S_n$  if  $n = 10$ .
- Create a spreadsheet that generates the output for your algorithm in part a above.
- The expression for the sum of  $n$  integers  $1 + 2 + 3 + 4 + \dots + n$  is given by  $\frac{1}{2}n(n + 1)$ . Use this expression to check your results from parts a and b above.
- Consider the sum of the square numbers  $1 + 4 + 9 + \dots + n^2$ . The expression for the sum of the first  $n$  squares is  $\frac{1}{6}n(n + 1)(2n + 1)$ . Use an algorithm and spreadsheets to explore this sum and confirm that this expression is correct. Write an algorithm and use spreadsheets to find the sum of the first 20 square numbers.

## Card pyramids

Using a deck of playing cards, build some pyramids on your desk like the ones illustrated below.

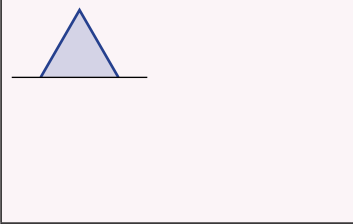
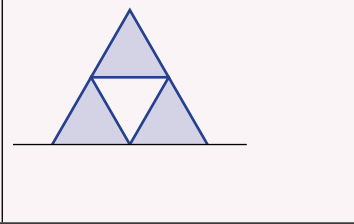
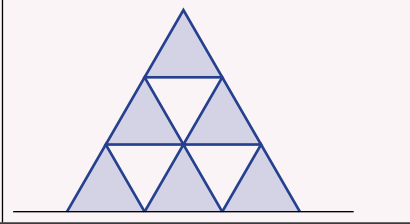
		
Pyramid 1 (One-triangle pyramid) (Two cards)	Pyramid 2 (Three-triangle pyramids) (Seven cards)	Pyramid 3 (Six-triangle pyramids) (Fifteen cards)

1 Copy and complete this table.

Number of triangle pyramids on base	1	2	3	5			
Total number of triangle pyramids	1	3				45	55
Total number of cards required	2		15		100		

- Describe the number of pyramids in and the number of cards required for pyramid 20 (20 pyramids on the base). How did you get your answer?
- If you had 10 decks of playing cards, what is the largest tower you could make? Describe how you obtained your answer.

## Number pyramids

### Number pyramids with a base of three consecutive numbers

- Can you explain how this number pyramid is constructed?
- Draw a similar number pyramid starting with the number 4 on the left of the base.
- Draw a similar number pyramid that has 44 as its top number. Remember the base of the pyramid must be consecutive numbers.
- Can you draw a similar number pyramid that has 48 as its top number? Explain your answer.
- Draw several of these pyramids to investigate how the top number is related to the starting value.
  - Set up a table showing starting values and top numbers.
  - Can you work out an algebraic rule that calculates top numbers given the starting number?
- Draw a number pyramid that has a base row of  $n$ ,  $n + 1$  and  $n + 2$ . What is the algebraic expression for the top number? Check this formula using some other number pyramids.

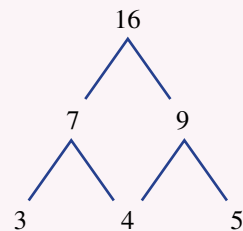



- 7 What is the sum of all the numbers in a pyramid with base row  $-10, -9, -8$ ?
- 8 Determine an expression for the sum of all the numbers in a pyramid starting with  $n$  on the base.

### Number pyramids with four consecutive numbers on the base

- 9 Copy and complete the following number pyramids.

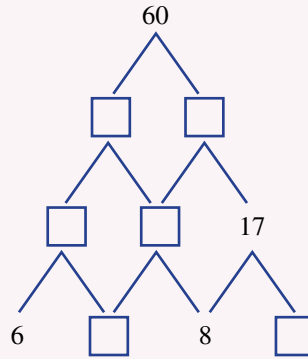
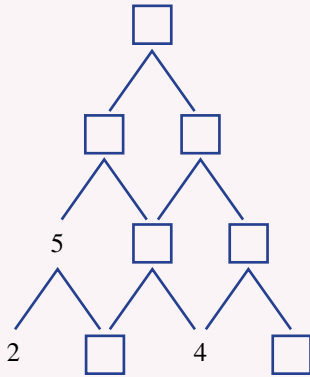

- 10 Investigate how the top number is related to the starting number. Can you show this relationship using algebra?
- 11 Write the sequence of all the possible top numbers less than 100.
- 12 What patterns can you see in this sequence of top numbers? Can you find some ways of showing these patterns using algebraic expressions? Let the bottom row start with  $n$ . (In the examples above,  $n = 2$  and  $n = 6$ .)

### Number pyramids with many consecutive numbers on the base

- 13 Determine the algebraic rule for the value of the top number for a pyramid with a base of six consecutive numbers starting with  $n$ .
- 14 List out the algebraic expressions for the first number of each row for several different-sized pyramids, all starting with  $n$ . What patterns can you see occurring in these expressions for:
- the coefficients of  $n$ ?
  - the constants?
- 15 What is the top number in a pyramid with a base of 40 consecutive numbers starting with 5?
- 16 Write an expression for the top number if the base had 1001 consecutive numbers starting with  $n$ .

- 1 Five consecutive even integers have  $2m + 2$  as the middle integer. Find two simplified equivalent expressions for the sum of these five integers.

Up for a challenge? If you get stuck on a question, check out the 'working with unfamiliar problems' poster at the end of the book to help.



- 2 Rearrange the order of the five expressions  $4(a + 1)$ ,  $6a - 5$ ,  $2 - a$ ,  $a - 7$ ,  $6 - 2a$  so that the sum of the first three expressions and the sum of the last three expressions are both equal to  $3(a + 1)$ .
- 3 Write this list  $16^{1000}$ ,  $8^{1334}$ ,  $4^{1999}$ ,  $2^{4001}$  in ascending order.
- 4 Find the largest value.
- If  $m$  can be any number, what is the largest value that  $10 - m(m + 5)$  could have?
  - If  $x + y$  evaluates to 15, what is the largest value that  $x \times y$  could have?
  - If  $a$  and  $b$  are chosen so that  $a^2 + b^2$  is equal to  $(a + b)^2$ , what is the largest value of  $a \times b$ ?

- 5 Simplify these algebraic expressions.

a  $\frac{a}{5} + \frac{a+1}{6} - \frac{a}{2}$

b  $\frac{x-1}{3} - \frac{2x-3}{7} + \frac{x}{6}$

- 6 The following three expressions all evaluate to numbers between 1 and 100, but most calculators cannot evaluate them. Find their values using the index laws.

a  $\frac{2^{1001} \times 2^{2002}}{(2^{150})^{20}}$

b  $\frac{5^{1000} \times 3^{1001}}{15^{999}}$

c  $\frac{8^{50} \times 4^{100} \times 2^{200}}{(2^{250})^2 \times 2^{48}}$

- 7 Consider the following pattern.

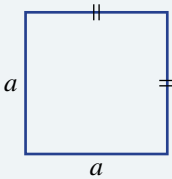

$n = 1$

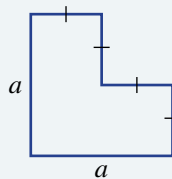

$n = 2$

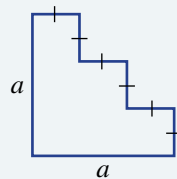

$n = 3$

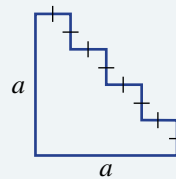

$n = 4$

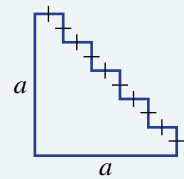

$n = 5$

The perimeter for the shape when  $n = 1$  is given by the expression  $4a$  and the area is  $a^2$ .

- Give expressions for the perimeter and area of the other shapes shown above and try to find a pattern.
  - If  $a = 6$  and  $n = 1000$ , state the perimeter and give the approximate area.
- 8 A cube has a side length of  $2^x 3^y$  cm. Determine the volume and surface area of this cube, writing the answers in index form.
- 9 Determine the value of the pronumerals in each of the following equations.
- $5^x = 125$
  - $3^a = 81$
  - $2^b 3^c = 72$
  - $25^x = 5$
  - $8^k = 32$

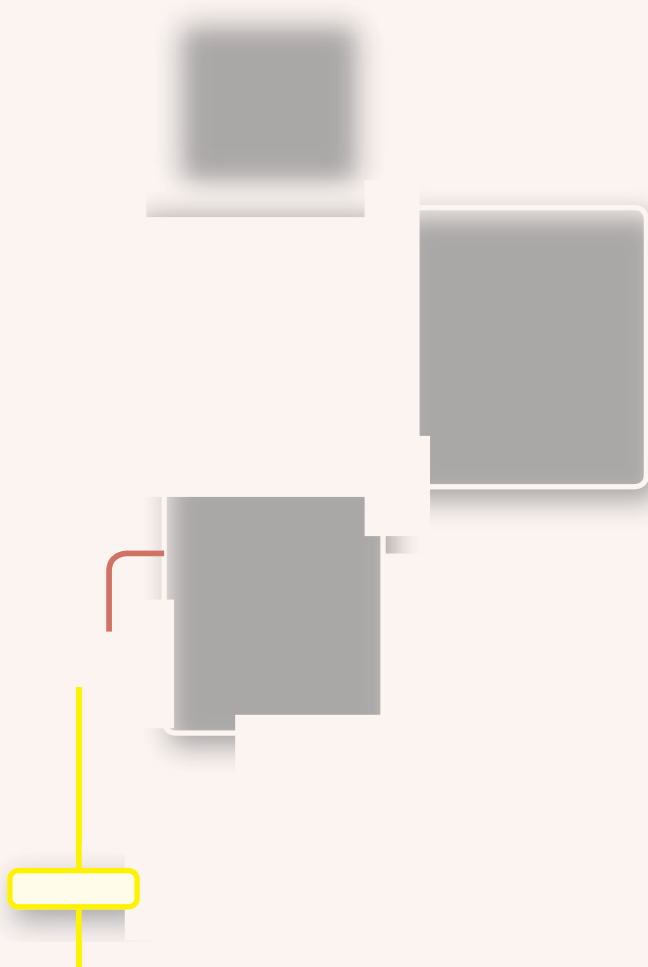

## Chapter checklist with success criteria

A printable version of this checklist is available in the Interactive Textbook



			<input checked="" type="checkbox"/>
5A	<b>1. I can state coefficients of pronumerals.</b> e.g. In the expression $4a + b - 12c + 5$ , state the coefficients of $a$ , $b$ , $c$ and $d$ .		<input type="checkbox"/>
5A	<b>2. I can create expressions from descriptions.</b> e.g. Write an expression for 'The sum of $a$ and $b$ is doubled'.		<input type="checkbox"/>
5B	<b>3. I can substitute values into expressions.</b> e.g. Substitute $x = 3$ and $y = 6$ to evaluate the expression $5x^2 + 2y + x$ .		<input type="checkbox"/>
5B	<b>4. I can decide if expressions are equivalent.</b> e.g. Decide if $x - 3$ and $3 - x$ are equivalent.		<input type="checkbox"/>
5C	<b>5. I can decide if two terms are like terms.</b> e.g. Decide if $3ab^2$ and $7a^2b$ are like terms.		<input type="checkbox"/>
5C	<b>6. I can simplify expressions by combining like terms.</b> e.g. Simplify $5ac + 3b - 2ca + 4b - 5b$ .		<input type="checkbox"/>
5D	<b>7. I can multiply terms and simplify the result.</b> e.g. Simplify $7a \times 2bc \times 3d$ and $3xy \times 5xz$ .		<input type="checkbox"/>
5D	<b>8. I can divide terms and simplify the result.</b> e.g. Simplify $\frac{10ab}{15bc}$ and $\frac{18x^2y}{8xz}$ .		<input type="checkbox"/>
5E	<b>9. I can convert an algebraic fraction to an equivalent expression with a different denominator.</b> e.g. Convert $\frac{2x}{7}$ to an equivalent algebraic fraction with the denominator 21.	Ext	<input type="checkbox"/>
5E	<b>10. I can add and subtract algebraic fractions and simplify the result.</b> e.g. Simplify $\frac{4a}{3} + \frac{2a}{5}$ and $\frac{a}{6} - \frac{b}{9}$ .	Ext	<input type="checkbox"/>
5F	<b>11. I can multiply and divide algebraic fractions and simplify the result.</b> e.g. Simplify $\frac{4x}{15} \times \frac{3y}{2}$ and $\frac{u}{4} \div \frac{15p}{2}$ .	Ext	<input type="checkbox"/>
5G	<b>12. I can expand brackets using the distributive law.</b> e.g. Expand $3(2x + 5)$ and $4x(2 - y)$ .		<input type="checkbox"/>
5G	<b>13. I can expand brackets and combine like terms to simplify.</b> e.g. Simplify $12xy + 7x(2 - y)$ .		<input type="checkbox"/>
5H	<b>14. I can find the highest common factor (HCF) of algebraic terms.</b> e.g. Find the HCF of $18a$ and $24ab$ .		<input type="checkbox"/>
5H	<b>15. I can factorise expressions by taking out the highest common factor.</b> e.g. Factorise $12a + 18ab$ .		<input type="checkbox"/>

		✓
5I	<b>16. I can write an expression to model a practical situation.</b> e.g. Write an expression to model the total cost, in dollars, of hiring a plumber for $n$ hours if they charge a \$40 call-out fee and \$70 per hour.	<input type="checkbox"/>
5J	<b>17. I can multiply powers and use the index law for multiplication.</b> e.g. Simplify $a^5 \times a \times a^3$ .	<input type="checkbox"/>
5J	<b>18. I can divide powers and use the index law for division.</b> e.g. Simplify $\frac{10x^6}{4x^2}$ .	<input type="checkbox"/>
5K	<b>19. I can simplify expressions in which the index is zero.</b> e.g. Simplify $4x^0 \times 8xy^0$ .	<input type="checkbox"/>
5K	<b>20. I can simplify expressions involving products and powers that are in the base.</b> e.g. Simplify $(u^2)^4 \times (7u^3)^2$ .	<input type="checkbox"/>

## Short-answer questions

5A

- 1 State whether each of the following is true or false:
- The constant term in the expression  $5x + 7$  is 5.
  - $16xy$  and  $5yx$  are like terms.
  - The coefficient of  $d$  in the expression  $6d^2 + 7d + 8abd + 3$  is 7.
  - The highest common factor of  $12abc$  and  $16c$  is  $2c$ .
  - The coefficient of  $xy$  in the expression  $3x + 2y$  is 0.

5A

- 2 For the expression  $6xy + 2x - 4y^2 + 3$ , state:
- the coefficient of  $x$
  - the constant term
  - the number of terms
  - the coefficient of  $xy$ .

5B

- 3 Substitute the following values of  $a$  to evaluate the expression  $8 - a + 2a^2$ .
- $-1$
  - $2$
  - $-3$
  - $0$

5B

- 4 Substitute  $x = 2$  and  $y = -3$  into each of the following.
- $2y + 3$
  - $3x + y$
  - $xy + y$
  - $4x - 2y$
  - $\frac{5xy}{6} + 2$
  - $\frac{-3x + 2y}{x + y}$

5B

- 5 For what value of  $x$  is  $3 - x$  equal to  $x - 3$ ?

5C

- 6 Simplify each of these expressions by collecting like terms.
- $7m + 9m$
  - $3a + 5b - a$
  - $x^2 - x + x^2 + 1$
  - $5x + 3y + 2x + 4y$
  - $7x - 4x^2 + 5x^2 + 2x$
  - $-8m + 7m + 6n - 18n$

5D

- 7 Simplify these expressions.
- $9a \times 4b$
  - $30 \times x \times y \div 2$
  - $-8x \times 4y \div (-2)$

5D

- 8 Copy and complete the following equivalences.
- $3y \times \square = 15xy$
  - $3ab \times \square = -12abc$
  - $\frac{3x}{4} = \frac{\square}{20}$
  - $9a^2b \div \square = 3a$

5E/F

Ext

- 9 Express each of the following in their simplest form.
- $\frac{5x}{12} - \frac{x}{6}$
  - $\frac{2a}{5} + \frac{b}{15}$
  - $\frac{6x}{5} \times \frac{15}{2x^2}$
  - $\frac{4a}{7} \div \frac{8a}{21b}$

5G

- 10 Expand and simplify when necessary.
- $3(x - 4)$
  - $-2(5 + x)$
  - $k(3l - 4m)$
  - $2(x - 3y) + 5x$
  - $7 + 3(2 - x)$
  - $10(1 - 2x)$
  - $4(3x - 2) + 2(3x + 5)$

- 5H** 11 Factorise fully.  
 a  $2x + 6$                       b  $24 - 16g$                       c  $12x + 3xy$                       d  $7a^2 + 14ab$
- 5J** 12 Find the missing values.  
 a  $7^5 \times 7^2 = 7 \square$                       b  $5^4 \div 5 = 5 \square$                       c  $4^2 \times 4 \square = 4^8$                       d  $3^3 \times 3 \square = 3^5$
- 5J/K** 13 Use the index laws to simplify each of the following expressions:  
 a  $m^2 \times m^5$                       b  $3m^7 \times 4m$                       c  $\frac{m^5}{m^3}$   
 d  $\frac{12a^6}{6a^2}$                       e  $(x^3)^4$                       f  $(2a^2)^3$
- 5J/K** 14 Simplify:  
 a  $-10x^6y^3z^4 \div (5x^2yz^2)$   
 b  $(y^5)^2$   
 c  $7a^0$   
 d  $(2x^3)^0 \times 2(x^3)^0$   
 e  $(2y^3)^2 \times y^4$   
 f  $(m^4)^3 \div (m^3)^2$   
 g  $(2b)^3 \div (4b^2)$   
 h  $\frac{(d^3e^3y^5)^2}{e^7} \times \frac{e}{(dy)^6}$

## Multiple-choice questions

- 5A** 1 Consider the expression  $5a^2 - 3b + 8$ . Which one of the following statements is true?  
 A The coefficient of  $a$  is 5.  
 B It has 5 terms.  
 C The constant term is 8.  
 D The coefficient of  $b$  is 5.  
 E The coefficient of  $a^2$  is 10.
- 5A** 2 Half the sum of double  $x$  and 3 can be written as:  
 A  $\frac{1}{2} \times 2x + 3$                       B  $\frac{2x+6}{2}$                       C  $x + 6$                       D  $\frac{2x+3}{2}$                       E  $\frac{2(x-3)}{2}$
- 5C** 3 The simplified form of  $12x + 4y - 3x$  is:  
 A  $15x + 4y$                       B  $9x + 4y$                       C  $16xy - 3x$                       D  $13xy$                       E  $12x + y$
- 5B** 4 The value of  $5 - 4a^2$  when  $a = 2$  is:  
 A 3                      B -3                      C 21                      D -11                      E 13
- 5D** 5  $3 \times x \times y$  is equivalent to:  
 A  $3x + y$                       B  $xy$                       C  $3 + x + y$                       D  $3x + 3y$                       E  $xy + 2xy$
- 5D** 6  $\frac{12ab}{24a^2}$  can be simplified to:  
 A  $2ab$                       B  $\frac{2a}{b}$                       C  $\frac{b}{2a}$                       D  $\frac{ab}{2}$                       E  $\frac{b}{2}$

5G

7 The expanded form of  $2x(3 + 5y)$  is:

- A  $6x + 5y$       B  $3x + 5y$       C  $6x + 5xy$       D  $6 + 10y$       E  $6x + 10xy$

5D

8 Simplifying  $3a \div (6b)$  gives:

- A 2      B  $\frac{a}{b}$       C  $\frac{2a}{b}$       D  $\frac{ab}{2}$       E  $\frac{a}{2b}$

5J

9  $5^7 \times 5^4$  is equal to:

- A  $25^{11}$       B  $5^{28}$       C  $25^3$       D  $5^3$       E  $5^{11}$

5H

10 The factorised form of  $3a^2 - 6ab$  is:

- A  $3a^2(1 - 2b)$       B  $3a(a - 2b)$       C  $3a(a - b)$       D  $6a(a - b)$       E  $3(a^2 - 2ab)$

## Extended-response questions

1 Two bus companies have different pricing structures.

Company A: \$120 call-out fee, plus \$80 per hour

Company B: \$80 call-out fee, plus \$100 per hour

- Write an expression for the total cost  $\$A$  of travelling  $n$  hours with company A.
- Write an expression for the total cost  $\$B$  of travelling for  $n$  hours with company B.
- Hence, state the cost of travelling for 3 hours with each company.
- For how long would you need to hire a bus to make company A the cheaper option?
- In the end, a school principal cannot decide which bus company to choose and hires 3 buses from company A and 2 buses from company B. Give an expanded expression to find the total cost for the school to hire the five buses for  $n$  hours.
- If the trip lasts for 5 hours, how much does it cost to hire the five buses for this period of time?





- 2 Consider the floor plan shown, labelled Plan A.
- Write an expanded expression for the floor's area in terms of  $x$  and  $y$ .
  - Hence, find the floor's area if  $x = 6$  metres and  $y = 7$  metres.
  - Write an expression for the floor's perimeter in terms of  $x$  and  $y$ .
  - Hence, find the floor's perimeter if  $x = 6$  metres and  $y = 7$  metres.
  - Another floor plan (Plan B) is shown. Write an expression for the floor's area and an expression for its perimeter.
  - Describe how the area and perimeter change when the floor plan goes from having two 'steps' to having three 'steps'.

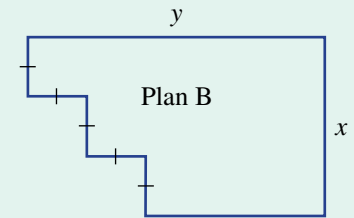
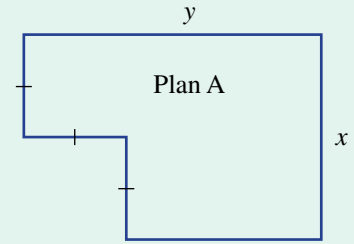

## Computation with integers

### Short-answer questions

1 Evaluate, without using a calculator:

a  $4973 + 196$

b  $1506 - 156$

c  $-96 \times 3$

d  $139 \times 5$

e  $14 \times 99$

f  $14 \times 99 + 14 \times 101$

g  $9^2$

h  $4^3$

i  $-9 - 7 - 3$

2 Evaluate:

a  $10 - 6 \times 4$

b  $15 \times 4 \div 2$

c  $24 \div 2 \times 6$

d  $-3 + (-10 - (-6))$

e  $-81 \div (-3) \times 2$

f  $73 - 72 - 7$

3 Find the HCF of:

a 24 and 42

b 35 and 42

c 100 and 60

d 15, 45 and 36.

4 Write down the LCM of:

a 24 and 42

b 8 and 9

c 100 and 60

d  $7^2 \times 5^2 \times 3^3$  and  $2 \times 7^2 \times 5 \times 3^2$

5 If  $a = -5$ ,  $b = 4$  and  $c = -2$ , evaluate these expressions.

a  $a + b + c$

b  $abc$

c  $a^2 - c$

d  $5(a - b + c)$

e  $a^2$

f  $c^3$

g  $\frac{8a + \sqrt{b}}{c}$

### Multiple-choice questions

1  $156 \div 4$  is the same as:

A  $156 \div 2 \times 2$

B  $156 \div 2 \div 2$

C  $312 \div 2$

D  $156 \times 2 \div 2$

2  $-24 + 6 \times (-3)$  is equal to:

A 6

B 42

C -42

D -6

3 What is the smallest number that can be added to 1923 to make the answer divisible by 9?

A 1

B 2

C 3

D 4

4  $(-15)^2$  equals:

A 225

B 30

C -30

D -225

5 Two numbers have a sum of  $-10$  and a product of  $-56$ . The larger of the two numbers is:

A  $-4$

B 4

C 14

D  $-14$

**Extended-response question**

The weather for a November day is given for different cities around the world.

	Minimum ( $^{\circ}\text{C}$ )	Maximum ( $^{\circ}\text{C}$ )
Amsterdam	3	12
Auckland	11	18
Los Angeles	8	14
Hong Kong	16	28
Moscow	6	8
Beijing	-3	0
New York	8	10
Paris	6	13
Tel Aviv	16	23
Wollongong	18	22

- Which city recorded the highest temperature on the day shown in the table?
- Which two cities only had a two-degree variance in temperature?
- Which city had the largest variance in temperature on this November day?
- What was the mean (average) minimum temperature for the 10 cities listed in the table?
- What was the mean (average) maximum temperature?
- If Bangkok's temperature of 29 to 34 degrees were added to the table, what effect would this have on the means?

**Angle relationships and properties of geometrical figures****Short-answer questions**

- 1 Find the value of  $x$ .

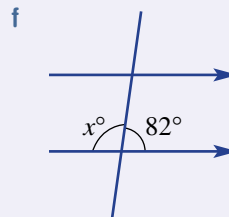
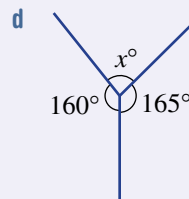
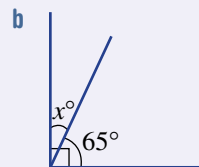
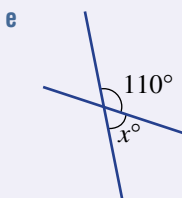
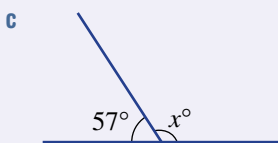
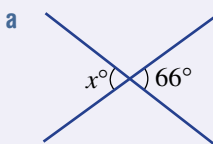

2 Find the value of each pronumeral.

a

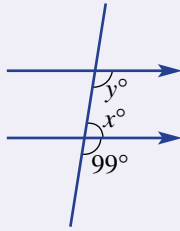

b

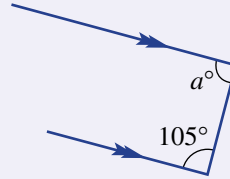

c

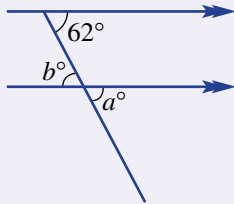

d

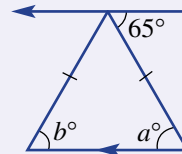

e

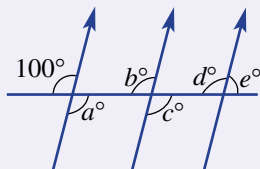

f

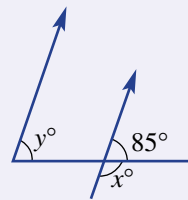

3 Find the value of the pronumeral in these triangles.

a

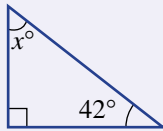

b

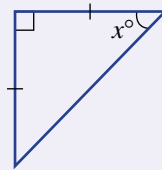

c

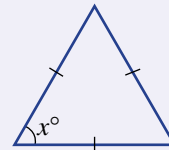

d

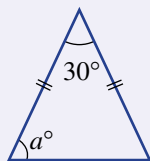

e

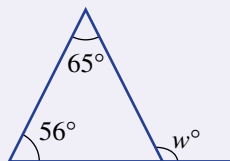

f

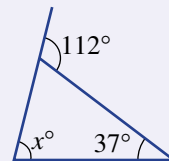

4 Find the value of  $a$  and  $b$  in these quadrilaterals.

a

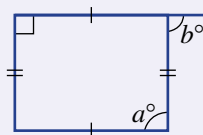

b

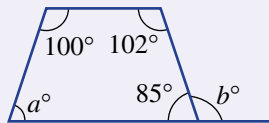

c

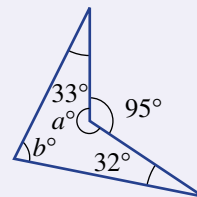

Ext 5 Find the interior angle of a regular hexagon.

**Multiple-choice questions**

- The supplementary angle to  $80^\circ$  is:  
 A  $10^\circ$                       B  $100^\circ$                       C  $280^\circ$                       D  $20^\circ$
- In this diagram  $a$  equals:  
 A 150                      B 220                      C 70                      D 80



- Ext** 3 The interior angle of a regular pentagon is:  
 A  $72^\circ$                       B  $540^\circ$                       C  $108^\circ$                       D  $120^\circ$

- 4 Which diagram shows equal alternate angles?

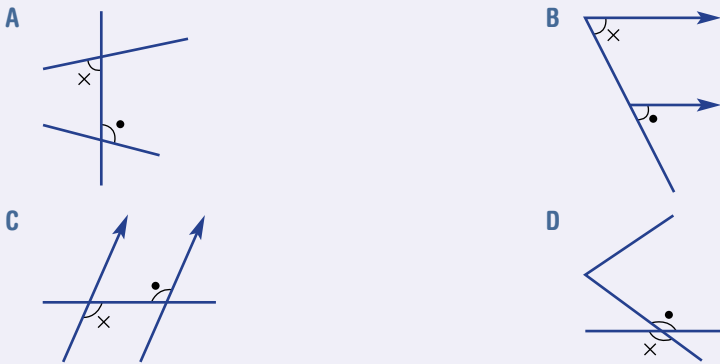

- 5 Give the coordinates of the point  $P$  shown in this three-dimensional diagram.  
 A  $(2, 0, 0)$                       B  $(2, 4, 0)$                       C  $(0, 4, 3)$   
 D  $(2, 4, 3)$                       E  $(4, 2, 3)$

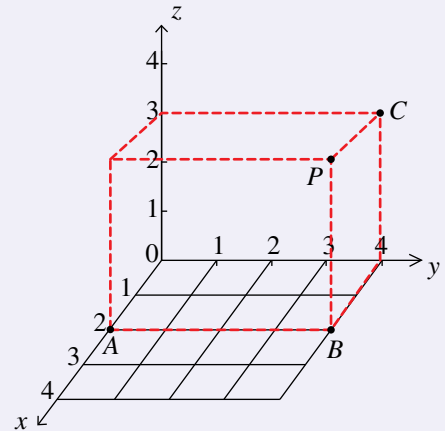

**Extended-response question**

If  $a = 115$ , find the size of each angle marked. Give a reason for each answer. Write your answers in the order you found them.

Is the order the same for everybody in the class? Discuss any differences and the reasons associated with each.

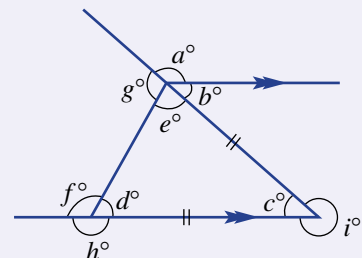

## Fractions, decimals and percentages

### Short-answer questions

1 Copy and complete these equivalent fractions.

a  $\frac{3}{5} = \frac{\square}{30}$

b  $\frac{\square}{11} = \frac{5}{55}$

c  $1\frac{4}{6} = \frac{\square}{3}$

2 Evaluate each of the following.

a  $\frac{3}{4} - \frac{1}{2}$

b  $\frac{4}{5} + \frac{3}{5}$

c  $1\frac{1}{2} + 1\frac{3}{4}$

d  $\frac{4}{7} - \frac{2}{3}$

e  $\frac{4}{9} \times \frac{3}{4}$

f  $1\frac{1}{2} \times \frac{3}{5}$

3 Write the reciprocal of:

a  $\frac{2}{5}$

b 8

c  $4\frac{1}{5}$ .

4 Evaluate:

a  $2\frac{1}{2} \times 1\frac{4}{5}$

b  $1\frac{1}{2} \div 2$

c  $1\frac{1}{2} \times \frac{1}{4} \div \frac{3}{5}$ .

5 Calculate each of the following.

a  $3.84 + 3.09$

b  $10.85 - 3.27$

c  $12.09 \div 3$

d  $6.59 - 0.2 \times 0.4$

e  $96.37 \times 40$

f  $15.84 \div 0.02$

6 Evaluate:

a  $5.3 \times 103$

b  $9.6 \times 105$

c  $61.4 \div 100$ .

7 Copy and complete this table of fractions, decimals and percentages.

<b>Fraction</b>	$\frac{1}{4}$	$\frac{1}{2}$	$\frac{1}{5}$	$\frac{1}{3}$	$\frac{2}{3}$				
<b>Decimal</b>								0.99	0.005
<b>Percentage</b>						80%	95%		

8 Find:

a 10% of 56

b 12% of 98

c 15% of 570 m

d 99% of \$2

e  $12\frac{1}{2}\%$  of \$840

f 58% of 8500 g.

9 a Increase \$560 by 25%.

b Decrease \$980 by 12%.

c Increase \$1 by 8% and then decrease the result by 8%.

10 A \$348 dress sold for \$261. This represents a saving of  $x\%$ . What is the value of  $x$ ?

### Multiple-choice questions

1  $\frac{150}{350}$  simplifies to:

A  $\frac{6}{14}$

B  $\frac{3}{70}$

C  $\frac{15}{35}$

D  $\frac{3}{7}$

- 2 Sienna spends  $\frac{3}{7}$  of \$280 her income on clothes and saves the rest. She saves:  
 A \$470                      B \$120                      C \$160                      D \$2613
- 3  $0.008 \times 0.07$  is equal to:  
 A 0.056                      B 0.0056                      C 0.00056                      D 56
- 4 0.24 expressed as a fraction is:  
 A  $\frac{1}{24}$                       B  $\frac{6}{25}$                       C  $\frac{12}{5}$                       D  $\frac{24}{10}$
- 5 If 5% of  $x = y$ , then 10% of  $2x$  equals:  
 A  $\frac{1}{2}y$                       B  $2y$                       C  $4y$                       D  $10y$

**Extended-response question**

A laptop decreases in value by 15% a year.

- a Find the value of a \$2099 laptop at the end of:  
 i 1 year                      ii 2 years                      iii 3 years.
- b After how many years is the laptop worth less than \$800?
- c Is the laptop ever going to have a value of zero dollars? Explain.

**Measurement and Pythagoras' theorem****Short-answer questions**

- 1 Complete these conversions.

- a  $5 \text{ m} = \underline{\hspace{2cm}} \text{ cm}$   
 b  $1.8 \text{ m} = \underline{\hspace{2cm}} \text{ cm}$   
 c  $9 \text{ m}^2 = \underline{\hspace{2cm}} \text{ cm}^2$   
 d  $1800 \text{ mm} = \underline{\hspace{2cm}} \text{ m}$   
 e  $4 \text{ L} = \underline{\hspace{2cm}} \text{ cm}^3$   
 f  $\frac{1}{100} \text{ km}^2 = \underline{\hspace{2cm}} \text{ m}^2$

- 2 Find the perimeter of these shapes.

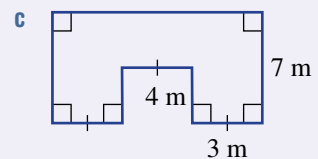
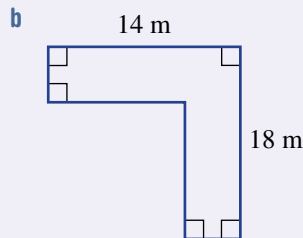
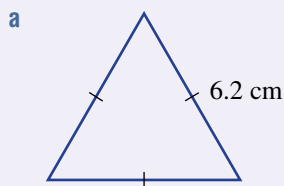

 3 Find, correct to two decimal places:

i the circumference

a

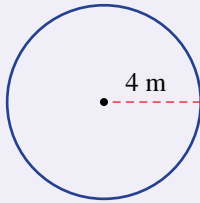

ii the area.

b

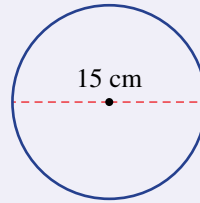

 4 Find, correct to two decimal places:

i the perimeter

a

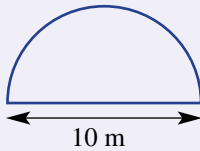

ii the area.

b

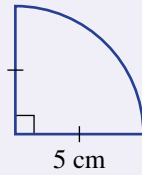

c

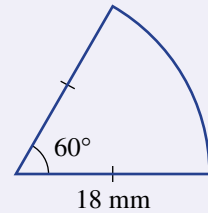

5 Find the area of these shapes.

a

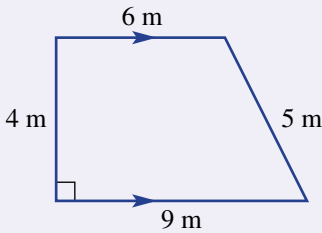

b

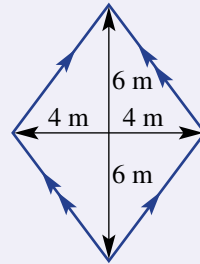

 6 Find the surface area and volume of these solids.

a

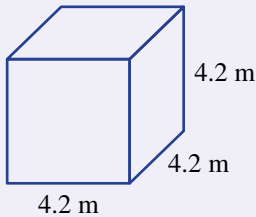

b

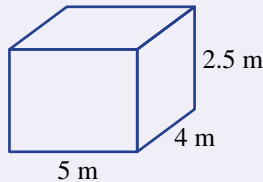

c

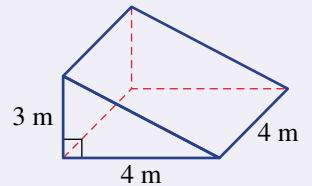

 7 Find the volume of each cylinder correct to two decimal places.

a

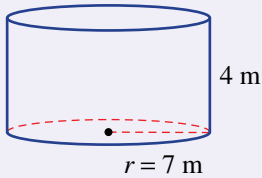

b

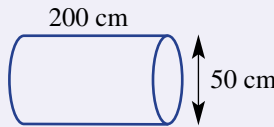

c

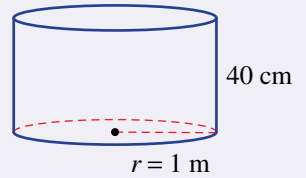



8 Find the value of  $x$  in these triangles. Round to two decimal places for part b.

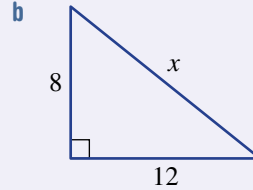
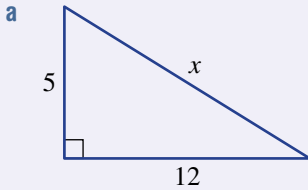

9 Write these times using 24-hour time.

a 3:30 p.m.

b 7:35 a.m.

**Multiple-choice questions**

Ext 1 A cube has a volume of 8 cubic metres. The surface area of this cube is:

- A  $2\text{m}^2$
- C  $24\text{m}^2$

- B  $4\text{m}^2$
- D  $384\text{m}^2$

2 The area of this triangle is:

- A  $48\text{m}^2$
- C  $30\text{m}^2$

- B  $24\text{m}^2$
- D  $40\text{m}^2$

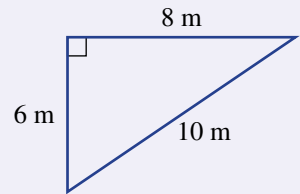

3 The perimeter of this semicircle is closest to:

- A 38 cm
- C 19 cm

- B 30 cm
- D 31 cm

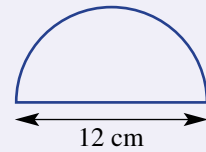

4 The value of  $x$  in this triangle is closest to:

- A 176
- C 274

- B 13
- D 17

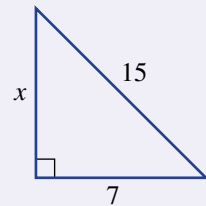

5 The area of this rectangle is:

- A  $48\text{m}^2$
- C  $480\text{cm}^2$

- B  $48000\text{cm}^2$
- D  $0.48\text{m}^2$

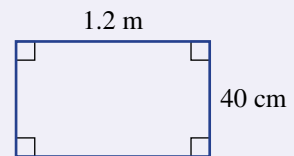

**Extended-response question**

A square sheet of metal 15 m by 15 m has equal squares of sides  $x$  m cut from each corner as shown. It is then folded to form an open tray.

- a What is the length of the base of the tray? Write an expression.
- b What is the height of the tray?
- c Write an expression for the volume of the tray.
- d If  $x = 1$ , find the volume of the tray.
- e What value of  $x$  do you think produces the maximum volume?

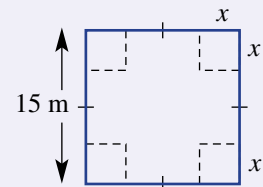

## Algebraic techniques and index laws

### Short-answer questions

1 Write an expression for:

- a the sum of  $p$  and  $q$
- b the product of  $p$  and 3
- c half the square of  $m$
- d the sum of  $x$  and  $y$ , divided by 2.

2 If  $a = 6$ ,  $b = 4$  and  $c = -1$ , evaluate:

- a  $a + b + c$
- b  $ab - c$
- c  $a(b^2 - c)$
- d  $3a^2 + 2b$
- e  $abc$
- f  $\frac{ab}{c}$

3 Simplify each algebraic expression.

- a  $4 \times 6k$
- b  $a + a + a$
- c  $a \times a \times a$
- d  $7p \div 14$
- e  $3ab + 2 + 4ab$
- f  $7x + 9 - 6x - 10$
- g  $18xy \div (9x)$
- h  $m + n - 3m + n$

**Ext** 4 Simplify:

- a  $\frac{5xy}{5}$
- b  $\frac{3x}{7} - \frac{2x}{7}$
- c  $\frac{w}{5} + \frac{w}{2}$
- d  $3a + \frac{a}{2}$

**Ext** 5 Simplify:

- a  $\frac{m}{5} \times \frac{5}{6}$
- b  $\frac{ab}{7} \div \frac{1}{7}$
- c  $\frac{m}{3} \times \frac{n}{2} \div \frac{mn}{4}$

6 Expand, and simplify where necessary.

- a  $6(2m - 3)$
- b  $10 + 2(m - 3)$
- c  $5(A + 2) + 4(A - 1)$

7 Factorise:

- a  $18a - 12$
- b  $6m^2 + 6m$
- c  $-8m^2 - 16mn$

8 Write an expression for this rectangle's:

- a perimeter
- b area.

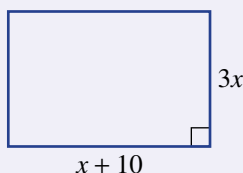

9 Simplify:

a  $m^7 \times m^2$

c  $12a^4b^6 \times (-4a^2b^3)$

e  $a^7b^4 \div (a^3b^2)$

b  $8a^3 \times 4a$

d  $a^{12} \div a^6$

f  $5a^6 \div (10a^6)$

10 Simplify:

a  $(x^7)^2$

c  $(-5a^4b^6)^2$

e  $(3x^2)^0$

b  $(2a^3)^4$

d  $x^0$

f  $-5(ab)^0c^2$

### Multiple-choice questions

1  $8^3 \times 8^4$  is the same as:

A  $8^{-1}$

B  $64^7$

C  $8^7$

D  $8^{12}$

2  $4x + 5 + 3x$  is the same as:

A  $7x + 5$

B  $12x$

C  $12 + x^2$

D  $2x + 12$

3  $12m + 18$  factorises to:

A  $2(6m - 9)$

B  $-6(2m - 3)$

C  $6(3 - 2m)$

D  $6(2m + 3)$

4  $5a + 5 - 4a - 4 - a - 1$  equals:

A  $a - 1$

B  $0$

C  $2 - a$

D  $a + 1$

5 Which answer is **not** equivalent to  $(m \times n) \div (p \times q)$ ?

A  $\frac{mn}{pq}$

B  $m \times \frac{n}{pq}$

C  $\frac{m}{p} \times \frac{n}{q}$

D  $\frac{mnq}{p}$

### Extended-response question

- Write an expression for the perimeter of this triangle.
- Write an expression for the area of this triangle.
- Use Pythagoras' theorem to find a relationship between  $x$  and  $a$ .
- Use your relationship to write an expression for the perimeter in terms of only  $a$ .
- If the perimeter equals 72 cm, what is the area of this triangle?

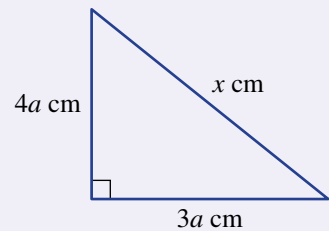

# 6

## Ratios and rates

### Maths in context: The rates and ratios of flying

A passenger jet taking off on full power runs its compressor blades at a rate of 10 000 revs/minute. Its engines can suck air in at a rate of 1200–1500 kg/second with a compression ratio  $CR = 40:1$  of 'air pressure out' to 'air pressure in'.

A plane's aspect ratio (AR) is the ratio of wing length to wing width. A glider's  $AR = 15:1$  meaning its wingspan is 15 times the wing's average width. Commercial planes have  $AR = 7:1$  to  $9:1$ . The Boeing 787 carbon-fibre-polymer wing has  $AR = 11:1$ , significantly improving fuel efficiency.

A Glide Ratio (GR) is the ratio of the horizontal distance travelled to the vertical height dropped, with no power. Modern gliders'  $GR = 60:1$  and can glide 40 km before landing from an altitude of 610 m. Boeing's 787  $GR = 20:1$ , meaning from an altitude of 12 200 m it could glide 244 km before landing.

A Boeing 747 uses fuel at the rate of 4 L/s or 1200 L/100 km, but a Boeing 787 fuel usage is 1.5 L/s = 5400 L/h, or 600 L/100 km and a 4-person car uses 8 L/100 km. Can you compare the L/100 km/person for a car, the 747 (416 passengers) and the 787 (270 passengers)?



## Chapter contents

- 6A Simplifying ratios
- 6B Solving ratio problems
- 6C Scale drawings
- 6D Introducing rates
- 6E Solving rate problems
- 6F Speed
- 6G Ratios and rates and the unitary method  
(EXTENDING)

## Victorian Curriculum 2.0

This chapter covers the following content descriptors in the Victorian Curriculum 2.0:

### MEASUREMENT

VC2M8M05, VC2M8M07

### ALGEBRA

VC2M8A04

Please refer to the curriculum support documentation in the teacher resources for a full and comprehensive mapping of this chapter to the related curriculum content descriptors.

© VCAA

## Online resources

A host of additional online resources are included as part of your Interactive Textbook, including HOTmaths content, video demonstrations of all worked examples, auto-marked quizzes and much more.

## 6A Simplifying ratios

### LEARNING INTENTIONS

- To be able to write equivalent ratios for a given ratio by multiplying or dividing each quantity by a given number
- To understand that simplifying a ratio involves finding an equivalent ratio with no common factors
- To be able to simplify a ratio involving whole numbers by dividing by the highest common factor
- To be able to simplify ratios involving fractions
- To be able to write simplified ratios involving quantities by converting units if necessary

Ratios are used to show the relationship between two (or more) related quantities. The order in which a ratio is written is important. For example, a school with a teacher-to-student ratio of 1:15 would seem very different from a school with a teacher-to-student ratio of 15:1 (which means there are 15 teachers for every 1 student!).

In a similar way to fractions, ratios are simplified by dividing each term by a common factor. A ratio is said to be in its simplest form when it contains whole numbers only and the highest common factor (HCF) between the terms in the ratio is 1.

If a ratio contains fractions or decimals, it can be simplified by multiplying rather than dividing or cancelling.

### Lesson starter: Class ratios

Look around your classroom and write down the following ratios.

- Ratio of girls to boys
- Ratio of teachers to students
- Ratio of wearing a watch to not wearing a watch
- Ratio of white socks to black socks
- Ratio of textbooks open to textbooks closed
- Ratio of not having a pencil case to having a pencil case
- Ratio of blonde hair to brown hair to black hair
- Ratio of blue eyes to brown eyes to other colour eyes

Design your own ratio question for your class or classroom.

Can any of your ratio answers be simplified?



The first outboard motor using fuel was designed by an American engineering student in 1903. Outboard motors require fuel to oil mixed in a certain ratio, such as 5 litres of fuel to 100 mL of oil, which simplifies to the ratio 50:1.

## KEY IDEAS

### ■ Simplifying ratios

A ratio is simplified by dividing both numbers in the ratio by their highest common factor (HCF). For example, the ratio 15:25 can be simplified to 3:5.

$$\begin{array}{c} 15 : 25 \\ \swarrow \quad \searrow \\ +5 \quad \quad +5 \\ \swarrow \quad \searrow \\ 3 : 5 \end{array} \leftarrow \text{Simplest form}$$

- Equivalent ratios are formed by multiplying or dividing each number in the ratio by the same value. For example, 4:12, 8:24 and 1:3 are all equivalent.
- It is conventional to express ratios in their simplest form.
- Ratios in simplest form use whole numbers only, with a highest common factor of 1.
- If a ratio is expressed with fractions, it is simplified by converting the quantities to whole numbers. This is generally done by multiplying by the lowest common denominator (LCD).
- Before ratios are simplified, the quantities must be expressed in the same unit.

## BUILDING UNDERSTANDING

- 1 State the ratio of shaded parts to unshaded parts for each of the following in simplest form.

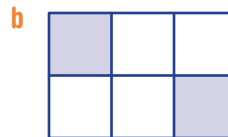
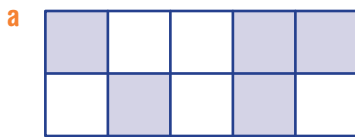

- 2 To express the ratio 4:16 in simplest form, you would:

- A multiply both quantities by 2                      B subtract 4 from both quantities  
C divide both quantities by 2                      D divide both quantities by 4

- 3 Decide which one of the following ratios is not written in simplest form.

- A 1:5                      B 3:9                      C 2:5                      D 11:17

- 4 Decide which one of the following ratios is written in simplest form.

- A 2:28                      B 15:75                      C 14:45                      D 13:39

**Example 1** Producing equivalent ratios

Complete each pair of equivalent ratios.

a  $4:9 = 16 : \square$

b  $30:15 = \square : 5$

**SOLUTION**

a 
$$\begin{array}{c} 4 : 9 \\ \times 4 \quad \quad \times 4 \\ \curvearrowright \quad \quad \quad \curvearrowleft \\ 16 : \boxed{36} \end{array}$$

b 
$$\begin{array}{c} 30 : 15 \\ +3 \quad \quad \quad +3 \\ \curvearrowleft \quad \quad \quad \curvearrowright \\ \boxed{10} : 5 \end{array}$$

**EXPLANATION**

Need to convert from 4 to 16 using multiplication or division.

Both numbers are multiplied by 4.

Need to convert from 15 to 5 using multiplication or division.

Both numbers are divided by 3.

**Now you try**

Complete each pair of equivalent ratios.

a  $3:10 = 9 : \square$

b  $30:20 = \square : 4$

**Example 2** Simplifying ratios

Simplify the following ratios.

a  $7:21$

b  $450:200$

**SOLUTION**

a 
$$\begin{array}{c} 7 : 21 \\ +7 \quad \quad \quad +7 \\ \curvearrowleft \quad \quad \quad \curvearrowright \\ 1 : 3 \end{array}$$

b 
$$\begin{array}{c} 450 : 200 \\ +50 \quad \quad \quad +50 \\ \curvearrowleft \quad \quad \quad \curvearrowright \\ 9 : 4 \end{array}$$

**EXPLANATION**

HCF of 7 and 21 is 7.

Divide both numbers by 7.

HCF of 450 and 200 is 50.

Divide both numbers by 50.

**Now you try**

Simplify the following ratios.

a  $8:20$

b  $210:240$



**Example 3 Simplifying ratios involving fractions**

Simplify the following ratios.

a  $\frac{3}{5} : \frac{1}{2}$

b  $2\frac{1}{3} : 1\frac{1}{4}$

**SOLUTION**

a  $\frac{3}{5} : \frac{1}{2}$

$$\times 10 \left( \frac{6}{10} : \frac{5}{10} \right) \times 10$$

$$6 : 5$$

b  $2\frac{1}{3} : 1\frac{1}{4}$

$\frac{7}{3} : \frac{5}{4}$

$$\times 12 \left( \frac{28}{12} : \frac{15}{12} \right) \times 12$$

$$28 : 15$$

**EXPLANATION**

Write each fraction with the same denominator (LCD of 5 and 2 is 10).

Multiply both fractions by 10 to eliminate denominator.

Alternatively, multiply both fractions by the LCD:

$$\times 10 \left( \frac{3}{5} : \frac{1}{2} \right) \times 10$$

$$6 : 5$$

Convert mixed numerals to improper fractions.

Write each fraction with the same denominator (LCD of 3 and 4 is 12).

Multiply both numbers by 12.

**Now you try**

Simplify the following ratios.

a  $\frac{3}{5} : \frac{1}{6}$

b  $2\frac{2}{3} : 3\frac{1}{2}$

**Example 4 Simplifying ratios involving related units**

First change the quantities to the same unit, and then express each pair of quantities as a ratio in simplest form.

a 4 mm to 2 cm

b 25 minutes to 2 hours

**SOLUTION**

a 4 mm to 2 cm = 4 mm to 20 mm

$$\div 4 \left( 4 : 20 \right) \div 4$$

$$1 : 5$$

b 25 minutes to 2 hours  
= 25 minutes to 120 minutes

$$\div 5 \left( 25 : 120 \right) \div 5$$

$$5 : 24$$

**EXPLANATION**

2 cm = 20 mm.

Once in same unit, write as a ratio.

Simplify ratio by dividing by the HCF of 4.

2 hours = 120 minutes.

Once in same unit, write as a ratio.

Simplify ratio by dividing by the HCF of 5.

**Now you try**

First change the quantities to the same unit, and then express each pair of quantities as a ratio in simplest form.

**a** 3 m to 50 cm

**b** 40 seconds to 2 minutes

**Exercise 6A****FLUENCY**1, 2-6( $\frac{1}{2}$ )2-6( $\frac{1}{2}$ )2-6( $\frac{1}{4}$ )

Example 1a

1 Copy and complete each pair of equivalent ratios.

**a**  $1:3 = 4 : \square$

**b**  $1:7 = 2 : \square$

**c**  $2:5 = \square : 10$

Example 2

2 Simplify the following ratios.

**a** 10:50

**b** 6:18

**c** 8:10

**d** 25:40

**e** 21:28

**f** 24:80

**g** 18:14

**h** 26:13

**i** 45:35

**j** 81:27

**k** 51:17

**l** 300:550

**m** 1200:100

**n** 70:420

**o** 200:125

**p** 90:75

3 Simplify the following ratios. (Note: You can divide all three numbers by the highest common factor.)

**a** 2:4:6

**b** 12:21:33

**c** 42:60:12

**d** 85:35:15

**e** 12:24:36

**f** 100:300:250

**g** 270:420:60

**h** 24:48:84

Example 3

4 Simplify the following ratios involving fractions and mixed numerals.

**a**  $\frac{1}{3}:\frac{1}{2}$

**b**  $\frac{1}{4}:\frac{1}{5}$

**c**  $\frac{2}{5}:\frac{3}{4}$

**d**  $\frac{2}{7}:\frac{1}{5}$

**e**  $\frac{3}{8}:\frac{1}{4}$

**f**  $\frac{7}{10}:\frac{4}{5}$

**g**  $\frac{11}{10}:\frac{2}{15}$

**h**  $\frac{9}{8}:\frac{7}{12}$

**i**  $1\frac{1}{2}:\frac{3}{4}$

**j**  $2\frac{1}{5}:\frac{3}{5}$

**k**  $3\frac{1}{3}:1\frac{2}{5}$

**l**  $4\frac{1}{3}:3\frac{3}{4}$

5 Over the past fortnight, it has rained on eight days and it has snowed on three days. The remaining days were fine. Write down the ratio of:

**a** rainy days to snowy days

**b** snowy days to total days

**c** fine days to non-fine days

**d** rainy days to non-rainy days.

Example 4

6 First change the quantities to the same unit, and then express each pair of quantities as a ratio in simplest form.

**a** 12 mm to 3 cm

**b** 7 cm to 5 mm

**c** 120 m to 1 km

**d** 60 mm to 2.1 m

**e** 3 kg to 450 g

**f** 200 g to 2.5 kg

**g** 2 kg to 440 g

**h** 1.25 L to 250 mL

**i** 400 mL to 1 L

**j** 20 minutes to 2 hours

**k** 3 hours to 15 minutes

**l** 3 days to 8 hours

**m** 180 minutes to 2 days

**n** 8 months to 3 years

**o** 4 days to 4 weeks

**p** 8 weeks to 12 days

**q** 50 cents to \$4

**r** \$7.50 to 25 cents

## PROBLEM-SOLVING

7, 8

7–9

7, 9, 10

- 7 Which of these ratios is the simplest form of the ratio  $\frac{1}{2}:2$ ?  
**A**  $2:\frac{1}{2}$                       **B** 1:4                      **C**  $\frac{1}{4}:1$                       **D** 1:1
- 8 Kwok was absent from school on 8 days in Term 1. There were 44 school days in Term 1. Write the following ratios in simplest form.  
**a** ratio of days absent to total days  
**b** ratio of days present to total days  
**c** ratio of days absent to days present
- 9 Over the past four weeks, the Paske family had eaten takeaway food for dinner on eight occasions. They had hamburgers twice, fish and chips three times and pizza three times. Every other night they had home-cooked dinners. Write the following ratios in simplest form.  
**a** ratio of hamburgers to fish and chips to pizza  
**b** ratio of fish and chips to pizza  
**c** ratio of takeaway dinners to home-cooked dinners  
**d** ratio of home-cooked dinners to total dinners
- 10 When Lisa makes fruit salad for her family, she uses 5 bananas, 5 apples, 2 passionfruit, 4 oranges, 3 pears, 1 lemon (for juice) and 20 strawberries.  
**a** Write the ratio of the fruits in Lisa's fruit salad.  
**b** Lisa wanted to make four times the amount of fruit salad to take to a party. Write an equivalent ratio that shows how many of each fruit Lisa would need.  
**c** Write these ratios in simplest form:  
**i** bananas to strawberries                      **ii** strawberries to other fruits.



## REASONING

11

11, 12

12–14

- 11 Andrew incorrectly simplified 12 cm to 3 mm as a ratio of 4:1. What was Andrew's mistake and what is the correct simplified ratio?
- 12 Mariah has \$4 and Rogan has 50 cents. To write a ratio in simplest form, values must be written in the same unit.  
**a** First convert both units to dollars, and then express the ratio of Mariah's money to Rogan's money in simplest form.  
**b** As an alternative, convert both units to cents and express the ratio in simplest form. Do you arrive at the same simplified ratio?

- 13 a Write two quantities of time, in different units, which have a ratio of 2:5.  
 b Write two quantities of distance, in different units, which have a ratio of 4:3.
- 14 Simplify the following ratios.
- |            |            |                |
|------------|------------|----------------|
| a $2a:4b$  | b $15x:3y$ | c $a:a^2$      |
| d $5f:24f$ | e $hk:3k$  | f $24xyz:60yz$ |

**ENRICHMENT: Aspect ratios**

15

- 15 Aspect ratio is the relationship between the width and height of the image as displayed on a screen.
- a An old analogue television has an aspect ratio of  $1.\dot{3}:1$ . Write this ratio in simplest form.
- b A high definition digital television has an aspect ratio of  $1.\dot{7}:1$ . Write this ratio in simplest form.
- c Although these two ratios are clearly not equivalent, there is a connection between the two. What is it?
- d The digital television aspect ratio of  $1.\dot{7}:1$  was chosen as the best compromise to show widescreen movies on television. Many major films are presented in Panavision, which has an aspect ratio of  $2.35:1$ . Write this ratio in simplest form.
- e Investigate the history of aspect ratio in films and television.
- f Research how formats of unequal ratios are converted through the techniques of cropping, zooming, letterboxing, pillarboxing or distorting.
- g Investigate aspect ratios of other common media.
- Find the aspect ratio for several different newspapers.
  - Find the aspect ratio for several common sizes of photographs.
  - Find the aspect ratio for a piece of A4 paper (a surd is involved!)



## 6B Solving ratio problems

### LEARNING INTENTIONS

- To understand that a quantity can be divided into a ratio
- To be able to find an unknown value for items in a given ratio
- To be able to divide a quantity in a particular ratio

Often when working with ratios, you must combine items in a given ratio; for instance, if you have 2 litres of cordial concentrate and you need to combine it with water in the ratio 1:4. This can be solved using equivalent ratios. In this case, you could double both numbers to get the ratio 2:8, telling you that 8 litres of water would be used with the 2 litres of cordial concentrate.

Another type of problem involves dividing a total amount using a given ratio. For example, imagine Holly and Sam work together to earn \$70. If Holly has worked for 2 hours and Sam has worked for 7 hours they might decide to divide the \$70 into the ratio 2:5.

To solve this problem they can make  $2 + 5 = 7$  boxes (or 'parts') that need to be filled with the same amount each, and then Holly gets 2 boxes and Sam gets 5 boxes, as shown in the diagram.

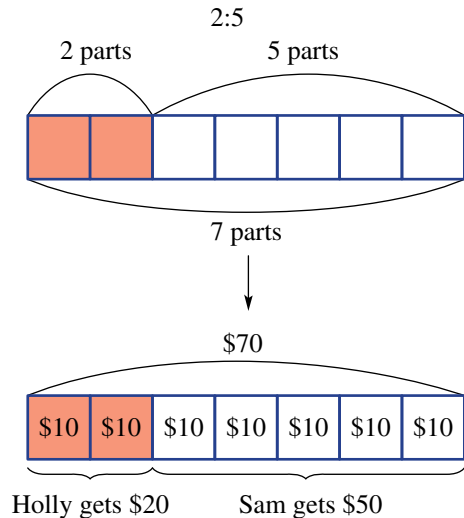

### Lesson starter: Sharing \$120

For each situation below you have \$120 to share out in the given ratios.

With a partner, work out how much each person receives.

Situation 1: Two people, Jack and Pippa, ratio of 1:1

Situation 2: Two people, Andrew and Alex, ratio of 2:2

Situation 3: Two people, Jess and Teresa, ratio of 2:3

Situation 4: Two people, Kyle and Kara, ratio of 3:5

Situation 5: Three people, Matt, Leos and Djarrin, ratio of 1:1:1

Situation 6: Three people, Christine, Prue and Carolyn, ratio of 3:5:7



A jeweller mixes other metal alloys with gold to increase its durability. One yellow gold alloy has a ratio of gold:silver:copper = 15:3:2. Hence, a 40 g yellow gold bracelet contains  $\frac{15}{20} \times 40 = 30$  g of pure gold.

Discuss the strategy that you used to share the \$120. Does your strategy work for every situation?

## KEY IDEAS

- To solve a problem where one part of the ratio is a known value, use equivalent ratios.  
For example, if ratio is 2:3 and the first person gets \$40, multiply both the numbers by 20 to get 40:60. So the second person gets \$60.
- Think of a ratio in terms of 'parts'.  
A ratio of 2:3 has 2 parts of one quantity for every 3 parts of another quantity and a total of 5 parts.
- Using the **unitary method** to divide a quantity in a given ratio:
  - 1 Find the total number of parts in the ratio.
  - 2 Find the value of one part.
  - 3 Find the value of the number of parts required in the ratio.

For example: Share \$20 in ratio of 2:3.  
Think of sharing \$20 into 2 parts and 3 parts.  
Total number of parts =  $2 + 3 = 5$ .  
Value of one part =  $\$20 \div 5 = \$4$ .  
Therefore 2 parts = \$8, and 3 parts = \$12.

$$\begin{array}{r}
 \begin{array}{l}
 \text{\$20} = 5 \text{ parts} \\
 \text{\$4} = 1 \text{ part} \\
 \text{\$8} = 2 \text{ parts}
 \end{array}
 \end{array}$$

$\begin{array}{l} \text{\textit{+5}} \\ \text{\textit{\times 2}} \end{array}$ 
 $\begin{array}{l} \text{\textit{+5}} \\ \text{\textit{\times 2}} \end{array}$

- Fractions can also be used to divide a quantity in a given ratio:
  - 1 Fraction of the amount required =  $\frac{\text{number in ratio}}{\text{total number of parts}}$
  - 2 Calculate the fraction of the amount for each share of the ratio.

For example:  
Share \$20 in ratio of 2:3.  
Fractions of the amount required are  $\frac{2}{5}$  and  $\frac{3}{5}$ .  
Therefore  $\frac{2}{5}$  of \$20 = \$8 and  $\frac{3}{5}$  of \$20 = \$12.

## BUILDING UNDERSTANDING

- 1 Fill in the missing values for the following equivalent ratios.
 

a $1:4 = 3:?$	b $1:5 = 4:?$	c $3:4 = ? : 8$	d $3:1 = ? : 5$
---------------	---------------	-----------------	-----------------
- 2 Find the total number of parts in the following ratios.
 

a 3:7	b 1:5	c 11:3	d 2:3:4
-------	-------	--------	---------
- 3 The diagram shows four glasses that contain different amounts of cordial. Water is then added to fill each glass. For each drink shown, what is the ratio of cordial to water?

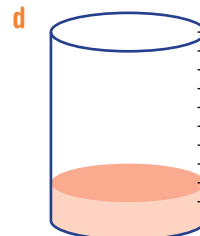
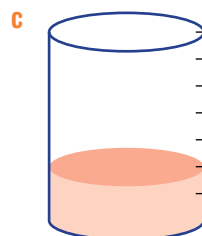
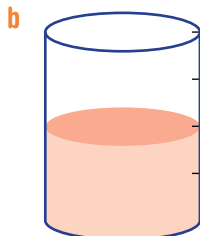
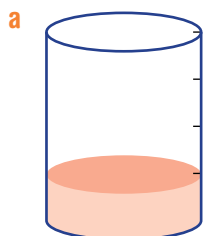

- 4 What fraction of each of the drinks above is cordial?

**Example 5 Using ratios to find unknown quantities**

Rice and water are to be combined in a ratio of 2:3.

- a** Find the amount of water to combine with 10 cups of rice.  
**b** Find the amount of rice to combine with 12 cups of water.

**SOLUTION**

**a** rice : water  
 $2 : 3$   
 $\times 5$   $\left( \begin{array}{l} 2 : 3 \\ \hline 10 : 15 \end{array} \right) \times 5$   
 $\therefore 15$  cups of water

**b** rice : water  
 $2 : 3$   
 $\times 4$   $\left( \begin{array}{l} 2 : 3 \\ \hline 8 : 12 \end{array} \right) \times 4$   
 $\therefore 8$  cups of rice

**EXPLANATION**

Write down the provided ratio with headings rice and water.

Find an equivalent ratio with the number 10 on the rice side. To get from 2 to 10 involves multiplying both numbers by 5.

Answer the question, remembering to include units (cups).

Write down the provided ratio with headings rice and water.

Find an equivalent ratio with the number 12 on the water side. To get from 3 to 12 involves multiplying both numbers by 4.

Answer the question, remembering to include units (cups).

**Now you try**

Blue and yellow paint is being mixed in the ratio 4:5.

- a** Find the amount of yellow paint to mix with 12 litres of blue paint.  
**b** Find the amount of blue paint to mix with 30 litres of yellow paint.

**Example 6 Dividing a quantity in a particular ratio**

Divide 54 m in a ratio of 4:5.

**SOLUTION****Unitary method:**

Total number of parts = 9

$$\begin{array}{l} +9 \left( \begin{array}{l} 9 \text{ parts } 54 \text{ m} \\ \hline 1 \text{ part} = 6 \text{ m} \end{array} \right) +9 \\ \times 4 \left( \begin{array}{l} 4 \text{ parts} = 24 \text{ m} \\ \hline 5 \text{ parts} = 30 \text{ m} \end{array} \right) \times 5 \end{array}$$

54 m divided in a ratio of 4:5 is 24 m and 30 m.

**EXPLANATION**

Total number of parts = 4 + 5 = 9.

Value of 1 part =  $54 \text{ m} \div 9 = 6 \text{ m}$ .

Check numbers add to total:  $24 + 30 = 54$ .

*Continued on next page*

**Fractions method:**

$$\frac{4}{9} \text{ of } 54 = \frac{4}{9} \times \frac{54}{1} = 24$$

$$\frac{5}{9} \text{ of } 54 = \frac{5}{9} \times \frac{54}{1} = 30$$

54 m divided in a ratio of 4:5 is 24 m and 30 m.

$$\text{Fraction} = \frac{\text{number in ratio}}{\text{total number of parts}}$$

Check numbers add to total:  $24 + 30 = 54$

**Now you try**

Divide 30 m in a ratio of 2:3.

**Example 7 Dividing a quantity in a ratio with three terms**

Divide \$300 in the ratio of 2:1:3.

**SOLUTION****Unitary method:**

Total number of parts = 6

$$\begin{array}{l} +6 \left( \begin{array}{l} 6 \text{ parts} = \$300 \\ 1 \text{ part} = \$50 \end{array} \right) \div 6 \\ \times 2 \left( \begin{array}{l} 2 \text{ parts} = \$100 \end{array} \right) \times 2 \quad \times 3 \left( \begin{array}{l} 1 \text{ part} = \$50 \\ 3 \text{ parts} = \$150 \end{array} \right) \times 3 \end{array}$$

\$300 divided in a ratio of 2:1:3 is  
\$100, \$50 and \$150.

**Fractions method:**

$$\frac{2}{6} \text{ of } 300 = \frac{2}{6} \times \frac{300}{1} = 100$$

$$\frac{1}{6} \text{ of } 300 = \frac{1}{6} \times \frac{300}{1} = 50$$

$$\frac{3}{6} \text{ of } 300 = \frac{3}{6} \times \frac{300}{1} = 150$$

\$300 divided in a ratio of 2:1:3  
is \$100, \$50 and \$150.

**EXPLANATION**

Total number of parts =  $2 + 1 + 3 = 6$

Value of 1 part =  $\$300 \div 6 = \$50$

Check numbers add to total:  
 $\$100 + \$50 + \$150 = \$300$

$$\text{Fraction} = \frac{\text{number in ratio}}{\text{total number of parts}}$$

Check numbers add to total:  
 $\$100 + \$50 + \$150 = \$300$

**Now you try**

Divide \$200 in the ratio of 5:2:3.



## Exercise 6B

### FLUENCY

1–3, 5(1/2)

2–4, 5–6(1/2)

3, 4, 5–6(1/2)

- Example 5a** 1 Rice and water are to be mixed in the ratio 2:3. Find the amount of water that would be mixed with:  
**a** 4 cups of rice      **b** 8 cups of rice      **c** 20 cups of rice      **d** 100 cups of rice.
- Example 5** 2 Blue and red paint is to be combined in the ratio 2:5.  
**a** Find the amount of red paint to mix with 6 litres of blue paint.  
**b** Find the amount of red paint to mix with 10 litres of blue paint.  
**c** Find the amount of blue paint to mix with 10 litres of red paint.  
**d** Find the amount of blue paint to mix with 30 litres of red paint.
- Example 5** 3 In a child-care centre the adult-to-child ratio is 1:4.  
**a** Find the number of children that can be cared for by 2 adults.  
**b** Find the number of children that can be cared for by 10 adults.  
**c** Find the number of adults that are required to care for 12 children.  
**d** Find the number of adults that are required to care for 100 children.
- 4 In a nut mixture the ratio of peanuts to walnuts to cashews is 2:3:1.  
**a** If the number of peanuts is 20, find the number of walnuts and cashews.  
**b** If the number of walnuts is 6, find the number of peanuts and cashews.  
**c** If the number of cashews is 8, find the number of peanuts and cashews.
- Example 6** 5 Divide:  
**a** 40 m in the ratio of 2:3      **b** 14 kg in the ratio of 4:3      **c** \$60 in the ratio of 2:3  
**d** 48 kg in the ratio of 1:5      **e** 72 m in the ratio of 1:2      **f** \$110 in the ratio of 7:4.
- Example 7** 6 Divide:  
**a** \$200 in the ratio of 1:2:2      **b** \$400 in the ratio of 1:3:4  
**c** 12 kg in the ratio of 1:2:3      **d** 88 kg in the ratio of 2:1:5  
**e** 320 kg in the ratio of 12:13:15      **f** \$50 000 in the ratio of 1:2:3:4.

### PROBLEM-SOLVING

7, 8

7–10

9–13

- 7 Eliana and Madeleine wish to share a collection of lollies in the ratio 1:2.  
**a** If Eliana takes 12 lollies, how many would Madeleine have?  
**b** If Madeleine takes 12 lollies, how many would Eliana have?  
**c** If there are 12 lollies in total, how many lollies would they each have?
- 8 In an animal hospital the ratio of cats to dogs is 5:7. There are no other animals present. If there are 20 cats in the hospital, find the total number of animals.
- 9 Trudy and Bella made 40 biscuits. If Trudy makes 3 biscuits for every 2 biscuits that Bella makes, how many biscuits did they each make?
- 10 The angles of a triangle are in the ratio 2:3:4. Find the size of each angle.

- 11 Three friends, Cam, Molly and Seb, share a prize of \$750 in a ratio of 3:4:8. How much more money does Seb receive than Cam?
- 12 A book contains three chapters and the ratio of pages in the chapters is 3:2:5. If there are 24 pages in the smallest chapter, how many pages are there in the book?
- 13 The ratio of the cost of a shirt to the cost of a jacket is 2:5. If the jacket cost \$240 more than the shirt, find the cost of the shirt and the cost of the jacket.

**REASONING**

14

14, 15

15, 16

- 14 If an amount of money is divided into the ratio 1:1, how can you quickly determine the amount that each person receives?
- 15 The ratio of students to teachers within a school is known to be 10:1.
- Explain how it is possible for there to be 60 students but it is not possible for there to be 61 students.
  - Explain how it is possible for there to be 60 teachers or 61 teachers, stating the number of students in each case.
  - If the total number of students and teachers is 220, find the number of students and teachers.
  - If the total number of students and teachers is known to be under 1000, find the maximum number of students within the school.
- 16 Arthur and Ben are siblings who were born on the same date in different years. Ben is exactly 12 years older than Arthur.
- Find the age ratio of Arthur's age to Ben's age when Arthur was 3 and Ben was 15. Ensure all ratios are simplified.
  - Find their age ratio one year later, when Arthur was 4 and Ben was 16.
  - Find the ages they each were when their age ratio was 1:3
  - Find the ages they each were when their age ratio was 1:2
  - Explain why their age ratio will never be 1:1 for as long as they live.

**ENRICHMENT: A fair share**

-

-

17

- 17 Three students Ramshid, Tony and Maria entered a group Geography competition.
- Tony spent 3 hours researching the topic.
  - Maria spent  $2\frac{1}{2}$  hours designing the poster.
  - Ramshid spent 5 hours preparing the final presentation.
- Their group won second prize in the competition and received a prize of \$250. Ramshid, Tony and Maria decide to share the prize in a ratio of 3:2:1.
- How much money did each student receive? Round the answer to the nearest cent.
  - If the prize was divided up according to the time spent on the project, what would be the new ratio? Write the ratio in whole numbers.
  - How much money did each student receive with the new ratio? Round the answer to the nearest cent.
  - Although she spent the least time on the project, Maria would prefer to divide the prize according to time spent. How much more money did Maria receive with the new ratio?
  - Tony preferred that the original ratio remained. How much was Tony better off using the original ratio?
  - Which ratio would Ramshid prefer and why?
  - The group ended up going with a ratio based on time spent but then rounded amounts to the nearest \$10. How much prize money did each student receive?

# 6C Scale drawings

## LEARNING INTENTIONS

- To understand that scale drawings can be used to depict large or small objects
- To be able to convert from a distance on a map or diagram to the actual distance in real life
- To be able to convert from the actual distance in real life to a distance on a map or diagram
- To be able to determine the scale factor given a distance on a diagram and the distance in real life

Scale drawings are a special application of ratios. The purpose of a scale drawing is to provide accurate information about an object which has dimensions that are either too large or too small to be shown on a page.

If a scale drawing has a ratio of 1:1, then the drawing would be exactly the same size as the actual (real-life) object. For example, it is not practical to have a map that is the same size as the actual distance you need to travel, so a much smaller map (a scaled drawing) is used. The map shows a scale to indicate the relationship of the map distance to the actual distance. The scale is displayed as a ratio.

Three common travel maps with their scales are shown below.



## Lesson starter: Scaling down and scaling up

- Brainstorm specific examples where you have come across scale drawings. Think of examples where a scale drawing has been used to show very large objects or distances, and also think of examples where a scale drawing has been used to show very small objects.
- Share your list of examples with your partner.
- As a class, make a list on the board of specific examples of scale drawings.
- What are some examples of common scales that are used?

### KEY IDEAS

- A **scale drawing** has exactly the same shape as the original object, but a different size. All scale drawings should indicate the scale ratio.
- The scale on a drawing is written as a scale ratio:  

$$\text{Drawing length} : \text{Actual length}$$
 Drawing length represents the length on the diagram, map or model.  
 Actual length represents the real length of the object.
- A **scale ratio** of 1:100 means the actual or real lengths are 100 times greater than the lengths measured on the diagram.
- A scale ratio of 20:1 means the scaled lengths on the model are 20 times greater than the actual or real lengths.
- It is helpful if scales begin with a 1. Then the second number in the ratio can be referred to as the **scale factor**. Scale ratios that do not start with a 1 can be converted using equivalent ratios.
- To convert a scaled distance to an actual distance you multiply by the scale factor.
- To convert an actual (real) distance to a scaled distance you divide by the scale factor.

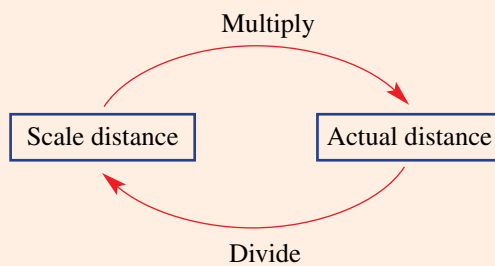

- Conversion of units.** It is important to remember how to correctly convert measurements of length when dealing with scales.

$$1 \text{ km} = 1000 \text{ m}$$

$$1 \text{ m} = 100 \text{ cm}$$

$$1 \text{ cm} = 10 \text{ mm}$$

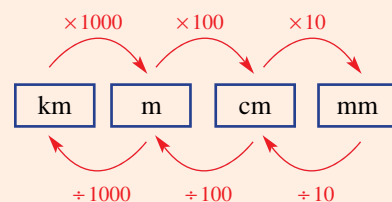

## BUILDING UNDERSTANDING

- 1 A map has a scale of 1:50 000. How many centimetres in real life does 1 cm on the map equal?
- 2 A map has a scale of 1:100. How many metres on the map does 300 m in real life equal?
- 3 Convert 10 000 cm to:
 

a mm	b m	c km.
------	-----	-------
- 4 Convert 560 m to:
 

a km	b cm	c mm.
------	------	-------
- 5 Convert the two measurements provided into the same unit and then write them as a ratio of two numbers in simplest form in the given order.
 

a 2 cm and 200 m	b 5 mm and 500 cm	c 12 mm and 360 cm
------------------	-------------------	--------------------



### Example 8 Converting scale distance to actual distance

A map has a scale of 1:20 000. Find the actual distance for each scaled distance.

- |        |        |           |
|--------|--------|-----------|
| a 2 cm | b 5 mm | c 14.3 cm |
|--------|--------|-----------|

#### SOLUTION

a Actual distance =  $2 \text{ cm} \times 20\,000$   
 $= 40\,000 \text{ cm}$   
 $= 400 \text{ m (or } 0.4 \text{ km)}$

b Actual distance =  $5 \text{ mm} \times 20\,000$   
 $= 100\,000 \text{ mm}$   
 $= 100 \text{ m}$

c Actual distance =  $14.3 \text{ cm} \times 20\,000$   
 $= 286\,000 \text{ cm}$   
 $= 2.86 \text{ km}$

#### EXPLANATION

Scale factor = 20 000  
 Multiply scaled distance by scale factor.  
 Convert answer into sensible units.

Multiply scaled distance by scale factor.  
 Convert answer into sensible units.

Multiply scaled distance by scale factor.  
 Shortcut:  $\times 2$ , then  $\times 10\,000$   
 Convert answer into sensible units.

#### Now you try

A map has a scale of 1:30 000. Find the actual distance for each scaled distance.

- |        |        |           |
|--------|--------|-----------|
| a 2 cm | b 8 mm | c 12.2 cm |
|--------|--------|-----------|



### Example 9 Converting actual distance to scaled distance

A model boat has a scale of 1:500. Find the scaled distance for each of these actual distances.

**a** 50 m

**b** 75 cm

**c** 4550 mm

#### SOLUTION

$$\begin{aligned} \text{a Scaled distance} &= 50 \text{ m} \div 500 \\ &= 5000 \text{ cm} \div 500 \\ &= 10 \text{ cm (0.1 m)} \end{aligned}$$

$$\begin{aligned} \text{b Scaled distance} &= 75 \text{ cm} \div 500 \\ &= 750 \text{ mm} \div 500 \\ &= 1.5 \text{ mm} \end{aligned}$$

$$\begin{aligned} \text{c Scaled distance} &= 4550 \text{ mm} \div 500 \\ &= 45.5 \text{ mm} \div 5 \\ &= 9.1 \text{ mm} \end{aligned}$$

#### EXPLANATION

Scale factor = 500

Convert metres to centimetres.

Divide actual distance by scale factor.

Convert answer into sensible units.

Convert centimetres to millimetres.

Divide actual distance by scale factor.

Divide actual distance by scale factor.

Shortcut:  $\div 100$ , then  $\div 5$  (or vice versa).

#### Now you try

A model truck has a scale of 1:200. Find the scaled distance for each of these actual distances.

**a** 10 m

**b** 60 cm

**c** 1300 mm



### Example 10 Determining the scale factor

State the scale factor in the following situations.

**a** A length of 4 mm on a scale drawing represents an actual distance of 50 cm.

**b** An actual length of 0.1 mm is represented by 3 cm on a scaled drawing.

#### SOLUTION

$$\begin{aligned} \text{a Scale ratio} &= 4 \text{ mm} : 50 \text{ cm} \\ &= 4 \text{ mm} : 500 \text{ mm} \end{aligned}$$

$$\begin{aligned} \text{Scale ratio} &= 4 : 500 \\ &= 1 : 125 \end{aligned}$$

$$\text{Scale factor} = 125$$

#### EXPLANATION

Write the ratio drawing length: actual length.

Convert to 'like' units.

Write the scale ratio without units.

Divide both numbers by 4.

Ratio is now in the form 1: scale factor.

The actual size is 125 times larger than the scaled drawing.

$$\begin{aligned}
 \text{b Scale ratio} &= 3 \text{ cm} : 0.1 \text{ mm} \\
 &= 30 \text{ mm} : 0.1 \text{ mm} \\
 \text{Scale ratio} &= 30 : 0.1 \\
 &= 300 : 1 \\
 &= 1 : \frac{1}{300} \\
 \text{Scale factor} &= \frac{1}{300}
 \end{aligned}$$

Write the ratio drawing length: actual length.

Convert to 'like' units.

Write the scale ratio without units.

Multiply both numbers by 10.

Divide both numbers by 300.

Ratio is now in the form 1 : scale factor.

The actual size is 300 times smaller than the scaled drawing.

### Now you try

State the scale factor in the following situations.

- a** A length of 3 mm on a scale drawing represents an actual distance of 60 cm.  
**b** An actual length of 2 mm is represented by 24 cm on a scale drawing.

## Exercise 6C

### FLUENCY

1,  $2\frac{1}{2}$ ,  $3,5\frac{1}{2}$

$1-5\frac{1}{2}$

$2\frac{1}{3}$ ,  $4\frac{1}{3}$ ,  $5\frac{1}{2}$

Example 8

- 1** A map has a scale 1:30 000. Find the actual distance for each scaled distance:  
**a** 2 cm                                      **b** 10 mm                                      **c** 10 cm

Example 8

- 2** Find the actual distance for each of the following scaled distances. Give your answer in an appropriate unit.



- a** Scale 1:10 000  
**i** 2 cm                                      **ii** 4 mm                                      **iii** 7.3 cm
- b** Scale 1:20 000  
**i** 80 cm                                      **ii** 18.5 mm                                      **iii** 1.25 m
- c** Scale 1:400  
**i** 16 mm                                      **ii** 72 cm                                      **iii** 0.03 m
- d** Scale 1:300  
**i** 5 mm                                      **ii** 8.2 cm                                      **iii** 7.1 m
- e** Scale 1:2  
**i** 44 m                                      **ii** 310 cm                                      **iii** 2.5 mm
- f** Scale 1:0.5  
**i** 12 cm                                      **ii** 3.2 mm                                      **iii** 400 m

Example 9

- 3** A model car has a scale of 1: 400. Find the scaled distance for each of these actual distances.  
**a** 400 cm                                      **b** 2 m                                      **c** 800 mm

**Example 9** 4 Find the scaled distance for each of these actual distances.



- a** Scale 1:200  
 i 200 m                      ii 4 km                      iii 60 cm
- b** Scale 1:500  
 i 10 000 m                      ii 1 km                      iii 75 cm
- c** Scale 1:10 000  
 i 1350 m                      ii 45 km                      iii 736.5 m
- d** Scale 1:20 000  
 i 12 km                      ii 1800 m                      iii 400 mm
- e** Scale 1:250 000  
 i 5000 km                      ii 750 000 m                      iii 1250 m
- f** Scale 1:0.1  
 i 30 cm                      ii 5 mm                      iii 0.2 mm

**Example 10** 5 Determine the scale factor for each of the following.



- a** A length of 2 mm on a scale drawing represents an actual distance of 50 cm.
- b** A length of 4 cm on a scale drawing represents an actual distance of 2 km.
- c** A length of 1.2 cm on a scale drawing represents an actual distance of 0.6 km.
- d** A length of 5 cm on a scale drawing represents an actual distance of 900 m.
- e** An actual length of 7 mm is represented by 4.9 cm on a scaled drawing.
- f** An actual length of 0.2 mm is represented by 12 cm on a scaled drawing.

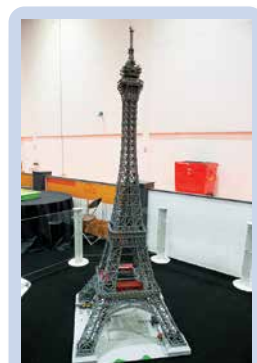

A Lego model of the Eiffel Tower at a scale ratio of 1 : 125

### PROBLEM-SOLVING

6–8

7–10

8–11

- 6** A model city has a scale ratio of 1:1000.  
**a** Find the actual height of a skyscraper that has a scaled height of 8 cm.  
**b** Find the scaled length of a train platform that is 45 m long in real life.
- 7** Blackbottle and Toowoola are 17 cm apart on a map with a scale of 1:50 000. How far apart are the towns in real life?
- 8** Using the house plans shown on the right, state the actual dimensions of the following rooms.  
**a** bedroom 1  
**b** family room  
**c** patio



- 9** From the scaled drawing, calculate the actual length and height of the truck, giving your answer to the nearest metre.





-  **10** The photograph on the right shows Jackson enjoying a walk with their dog. Jackson is 1.8 m tall in real life. Find a scale for the photograph and use this to estimate the height of Jackson's dog.



- 11** A scale length of  $5\frac{1}{2}$  cm is equal to an actual distance of 44 km.
- How many kilometres does a scale length of 3 cm equal?
  - How many kilometres does a scale length of 20 cm equal?
  - How many centimetres does an actual distance of 100 km equal?

**REASONING**

12, 13

12–14

14–16

- 12** Group the six ratios below into pairs of equivalent ratios.  
1:0.01    25:1    20:1    1:0.05    100:1    50:2
- 13** Which of the following scales would be most appropriate if you wanted to make a scale model of:
- |                   |                               |                         |
|-------------------|-------------------------------|-------------------------|
| <b>a</b> a car?   | <b>b</b> your school grounds? | <b>c</b> Mt Kosciuszko? |
| <b>A</b> 1:10 000 | <b>B</b> 1:1 000              | <b>C</b> 1:100          |
|                   |                               | <b>D</b> 1:10           |
- 14** A map maker wants to make a map of a square region of land with an area of  $64 \text{ km}^2$  (side length of 8 km). She decides to use a scale of 1:1000. Describe the problem she is going to have.
- 15** A scientist says that the image of a 1 mm long insect is magnified by a scale of 1:1000 through his magnifying glass. Explain what might be wrong with the scientist's ratio.
- 16** Obtain a map of Australia.
- What is the scale of your map?
  - Which two capital cities in Australia are the furthest apart? State the distance.
  - Which two capital cities in Australia are closest together? State the distance.
  - Which capital city is furthest away from Sydney? State the distance.
  - Which capital city is closest to Adelaide? State the distance.
  - Check the accuracy of your answers on the internet.

**ENRICHMENT: Scaled drawing**

–

–

17

- 17** Design a scaled drawing of one of the following:
- your classroom and the associated furniture
  - your bedroom and the associated furniture
  - a room in your house (bathroom, family room, garage, ...).
- Your scaled drawing should fit comfortably onto an A4 page.
- Measure the dimensions of your chosen room and the dimensions of an A4 page, and determine the most appropriate scale for your diagram.
  - Show size and location of doors and windows where appropriate.
  - Produce a second scale diagram of your room, but show a different arrangement of the furniture.
- Can you produce the scale diagram on a computer software package?

## 6D Introducing rates

### LEARNING INTENTIONS

- To understand that rates compare two quantities measured in different units
- To be able to simplify rates
- To be able to find average rates
- To understand that a rate like \$12/h (or \$12 per hour) means \$12 for 1 hour

A ratio shows the relationship between the same type of quantities with the same units, but a rate shows the relationship between two different types of quantities with different units.

The following are all examples of rates.

- Cost of petrol was \$1.45 per litre.
- Rump steak was on special for \$18/kg.
- Dad drove to school at an average speed of 52 km/h.
- After the match, your heart rate was 140 beats/minute.

Unlike ratios, a rate compares different types of quantities, and so units must be shown.

For example:

- The ratio of students to staff in a school was 10:1 (these have the same unit, 'people').
- The average rate of growth of an adolescent boy is 12 cm/year (these have different units of different types, 'cm' and 'year').



Knowledge of irrigation rates for watering crops at various growth stages is essential for efficient farm management. This includes rates such as: pump flow rates, L/s; drip irrigation rates, L/h; travelling irrigator rates, acres/h; and irrigation frequency rates,  $n/\text{week}$ .

### Lesson starter: State the rate

For each of the following statements, write down a corresponding rate.

- The Lodges travelled 400 km in 5 hours.
- Gary was paid \$98 for a 4-hour shift at work.
- Felicity spent \$600 on a two-day shopping spree.
- Max had grown 9 cm in the last three months.
- Vuong paid \$37 for half a cubic metre of crushed rock.
- Paul cycled a total distance of 350 km for the week.

What was the rate (in questions/minute) at which you answered these questions?

## KEY IDEAS

- **Rates** compare quantities measured in different units.
- All rates must include units for each quantity.
- The two different units are separated by a slash '/', which is the mathematical symbol for 'per'.  
For example:  $20\text{ km/h} = 20\text{ km per hour} = 20\text{ km for each hour}$
- It is a convention to write rates in their simplest form. This involves writing the rate for only one unit of the second quantity.  
For example: If \$45 is spent in 3 hours,

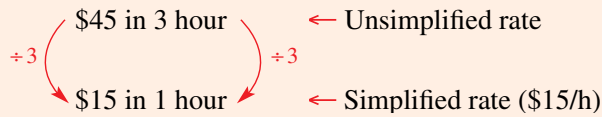

- The **average rate** is calculated by dividing the total change in one quantity by the total change in the second quantity.  
For example: If a 400 page book is read in 4 days,

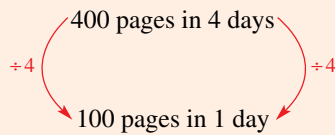

Therefore, average reading rate = 100 pages/day.

## BUILDING UNDERSTANDING

- 1 Which of the following are examples of rates?
- A \$5.50                      B 180 mL/min                      C \$60/h                      D  $\frac{5}{23}$
- E 4.2 runs/over                      F 0.6 g/L                      G 200 cm<sup>2</sup>                      H 84 c/L

- 2 Match each rate in the first column with its most likely unit in the second column.

Employee's wage	90 people/day
Speed of a car	\$2100/m <sup>2</sup>
Cost of building a new home	68 km/h
Population growth	64 beats/min
Resting heart rate	\$15/h

- 3 State typical units for each of the following rates.
- |                                |                             |
|--------------------------------|-----------------------------|
| a price of sausages            | b petrol costs              |
| c typing speed                 | d goal conversion rate      |
| e energy nutrition information | f water usage in the shower |
| g pain relief medication       | h cricket team's run rate   |

**Example 11 Writing simplified rates**

Express each of the following as a simplified rate.

- a 12 laps in two hours  
b \$28 for 4 kilograms

**SOLUTION**

a

$$\begin{array}{l} \text{12 laps in 2 hours} \\ \swarrow \quad \searrow \\ \text{+2} \quad \quad \quad \text{+2} \\ \text{6 laps in 1 hour} \end{array}$$

$$\therefore 6 \text{ laps/hour}$$

b

$$\begin{array}{l} \text{\$28 for 4 kg} \\ \swarrow \quad \searrow \\ \text{+4} \quad \quad \quad \text{+4} \\ \text{\$7 for 1 kg} \end{array}$$

$$\therefore \$7/\text{kg}$$

**EXPLANATION**

Write the given rate in words.

Divide both sides by 2 to find the number of laps per 1 hour.

Write the given rate in words.

Divide both sides by 4 to find the amount per 1 kg.

**Now you try**

Express each of the following as a simplified rate.

- a 21 laps in three hours  
b \$30 for 5 kilograms

**Example 12 Finding average rates**

Tom was 120 cm tall when he turned 10 years old. He was 185 cm tall when he turned 20 years old. Find Tom's average rate of growth per year between 10 and 20 years of age.

**SOLUTION**

$$\begin{array}{l} \text{65 cm in 10 years} \\ \swarrow \quad \searrow \\ \text{+10} \quad \quad \quad \text{+10} \\ \text{6.5 cm in 1 year} \end{array}$$

$$\text{Average rate of growth} = 6.5 \text{ cm/year.}$$

**EXPLANATION**

$$\text{Growth} = 185 - 120 = 65 \text{ cm}$$

Divide both numbers by 10.

**Now you try**

Michelle grew from 90 cm to 130 cm over 5 years. Find her average rate of growth per year.

## Exercise 6D

### FLUENCY

1, 2(1/2)

2-3(1/2)

2-3(1/3)

- Example 11**
- 1 Express each of the following as a simplified rate.
- |  |   |
|--|---|
| <p>a 10 laps in 2 hours</p> <p>c \$20 for 4 kg</p> | <p>b 12 laps in 3 hours</p> <p>d \$1080 for 54 kg</p> |
|--|---|
- Example 11**
- 2 Express each of the following as a simplified rate.
- |   |  |
|---|--|
| <p>a 12 km in 4 years</p> <p>c \$180 in 6 hours</p> <p>e \$126 000 to purchase 9 acres</p> <p>g 12 000 revolutions in 10 minutes</p> <p>i 60 minutes to run 15 kilometres</p> | <p>b 15 goals in 3 games</p> <p>d \$17.50 for 5 kilograms</p> <p>f 36 000 cans in 8 hours</p> <p>h 80 mm rainfall in 5 days</p> <p>j 15 kilometres run in 60 minutes</p> |
|---|--|
- Example 12**
- 3 Find the average rate of change for each situation.
- |  |   |
|--|---|
| <p>a Relma drove 6000 kilometres in 20 days.</p> <p>c A cricket team scored 78 runs in 12 overs.</p> <p>e Russell gained 6 kilograms in 4 years.</p> | <p>b Holly saved \$420 over three years.</p> <p>d Saskia grew 120 centimetres in 16 years.</p> <p>f The temperature dropped 5°C in 2 hours.</p> |
|--|---|

### PROBLEM-SOLVING

4-6

6-8

7-9

- 4 A dripping tap filled a 9 litre bucket in 3 hours.
- What was the dripping rate of the tap in litres/hour?
  - How long would it take the tap to fill a 21 litre bucket?
- 5 Martine grew at an average rate of 6 cm/year for the first 18 years of her life. If Martine was 50 cm long when she was born, how tall was Martine when she turned 18?
- 6 If 30 salad rolls were bought to feed 20 people at a picnic, and the total cost was \$120, find the following rates.
- |  |                    |
|--|--------------------|
| <p>a salad rolls/person</p> <p>b cost/person</p> | <p>c cost/roll</p> |
|--|--------------------|
- 7 The number of hours of sunshine was recorded each day for one week in April. The results are:  
 Monday 6 hours, Tuesday 8 hours, Wednesday 3 hours,  
 Thursday 5 hours, Friday 7 hours, Saturday  
 6 hours, Sunday 7 hours.
- Find the average number of hours of sunshine:
 

i per weekday	ii per weekend day
iii per week	iv per day.
  - Given the above rates, how many hours of sunshine would you expect in April?
- 8 Harvey finished a 10 kilometre race in 37 minutes and 30 seconds. Jacques finished a 16 kilometre race in 53 minutes and 20 seconds. Calculate the running rate of each runner. Which runner had a faster running pace?



- 9 The Tungamah Football Club had 12 000 members. After five successful years and two premierships, they now have 18 000 members.
- What has been the average rate of membership growth per year for the past 5 years?
  - If this membership growth rate continues, how many more years will it take for the club to have 32 000 members?

**REASONING**

10

10, 11

11, 12

- 10 a A car uses 24L of petrol to travel 216km. Express these quantities as a simplified rate in:
- km/L
  - L/km.
- b How can you convert km/L to L/km?
- 11 Shohini and Marc have a race. Shohini runs at a rate of 5 minutes per kilometre and Marc runs at a rate of 6 minutes per kilometre. Explain why Shohini will win the race even though 5 is less than 6.
-  12 The Teleconnect satellite telecommunications company has a variable call charge rate for phone calls of up to 30 minutes. The charges are 50c/min for first 10 minutes, 75c/min for the second 10 minutes and \$1/min for the third 10 minutes.
- Find the cost of phone calls of these given lengths.
    - 8 minutes
    - 13 minutes
    - 24 minutes
    - 30 minutes
  - What is the average charge rate per minute for a 30 minute call?  
Connectplus, a rival telecommunications company, charges a constant call rate of 60c/minute.
  - If you normally made calls that were 15 minutes long, which company has the better deal for you?
  - If you normally made calls that were 25 minutes long, which company has the better deal for you?
  - What is the length of phone call for which both companies would charge the same amount?

**ENRICHMENT: Target 155**

–

–

13

- 13 In Victoria, due to drought conditions, the state government in 2008 urged all residents to save water. The goal was set for each Victorian to use no more than 155 litres of water per day.
- How many people live in your household?
  - According to the Victorian government, how many litres of water can your household use per day?
  - Perform some experiments and calculate the following rates of water flow.
    - shower rate (L/min)
    - washing machine (L/load)
    - hose (L/min)
    - toilet (L/flush, L/half flush)
    - running tap (L/min)
    - drinking water (L/day)
    - dishwasher (L/wash)
    - water for food preparation (L/day)
  - Estimate the average daily rate of water usage for your household.
  - Ask your parents for a recent water bill and find out what your family household water usage rate was for the past three months.  
Before the initiative, Victorians were using an average of 164 litres/day/person. Twelve months after the initiative, Victorians were using 151 litres/day/person.
  - How much water per year for the state of Victoria does this saving of 13 litres/day/person represent?



## 6E Solving rate problems

### LEARNING INTENTIONS

- To understand that rates can be used to model many situations
- To be able to solve problems involving rates

We are constantly interested in rates of change and how things change over a period of time. We are also regularly faced with problems involving specific rates. Strong arithmetic skills and knowing whether to multiply or divide by the given rate allows many rate problems to be solved quickly and accurately.

Over the next few days, keep a record of any rates you observe or experience. Look out for the slash '/' sign and listen for the 'per' word.

### Lesson starter: Estimate the rate

For each of the following statements, estimate a corresponding rate.

- Commercial rate: The number of commercials on TV per hour
- Typing rate: Your typing speed in words per minute
- Laughing rate: The number of times a teenager laughs per hour
- Growth rate: The average growth rate of a child from 0 to 15 years of age
- Running rate: Your running pace in metres per second
- Homework rate: The number of subjects with homework per night
- Clapping rate: The standard rate of audience clapping in claps per minute
- Thank you rate: The number of opportunities to say 'thank you' per day

Compare your rates. Which rate is the 'highest'? Which rate is the 'lowest'? Discuss your answers.



The rate that food energy is burned depends on a person's weight. For example, playing soccer for 30 minutes uses around 4.3 calories/kg. Hence, a 60 kg teenager playing soccer burns energy at a rate of 260 calories per half hour.

### KEY IDEAS

- When a rate is provided, a change in one quantity implies that an equivalent change must occur in the other quantity.

For example: Patrick earns \$20/hour. How much will he earn in 6 hours?

$$\begin{array}{c} \$20 \text{ for 1 hour} \\ \times 6 \quad \quad \quad \times 6 \\ \hline \$120 \text{ for 6 hours} \end{array}$$

For example: Patrick earns \$20/hour. How long will it take him to earn \$70?

$$\begin{array}{c} \$20 \text{ for 1 hour} \\ \times 3\frac{1}{2} \quad \quad \quad \times 3\frac{1}{2} \\ \hline \$70 \text{ for } 3\frac{1}{2} \text{ hours} \end{array}$$

- Carefully consider the units involved in each question and answer.



## BUILDING UNDERSTANDING

1 State the missing components in each rate problem.

a  $\begin{matrix} 60 \text{ km in 1 hour} \\ \times 3 \left( \begin{matrix} \text{ } \\ \text{ } \end{matrix} \right) \times 3 \\ 180 \text{ km in } \underline{\hspace{1cm}} \end{matrix}$

b  $\begin{matrix} \$25 \text{ in 1 hour} \\ \times 5 \left( \begin{matrix} \text{ } \\ \text{ } \end{matrix} \right) \text{---} \\ \$125 \text{ in } \underline{\hspace{1cm}} \end{matrix}$

c  $\begin{matrix} \text{---} \left( \begin{matrix} \text{ } \\ \text{ } \end{matrix} \right) 7 \text{ questions in 3 minutes} \\ \text{---} \left( \begin{matrix} \text{ } \\ \text{ } \end{matrix} \right) \text{---} \\ 70 \text{ questions in } \underline{\hspace{1cm}} \end{matrix}$

d  $\begin{matrix} \text{---} \left( \begin{matrix} \text{ } \\ \text{ } \end{matrix} \right) 120 \text{ litres in 1 minute} \\ \text{---} \left( \begin{matrix} \text{ } \\ \text{ } \end{matrix} \right) \text{---} \\ \text{---} \text{ in 6 minutes} \end{matrix}$

2 State the missing components in each rate problem.

a  $\begin{matrix} +3 \left( \begin{matrix} \$36 \text{ for 3 hours} \\ \text{---} \text{ for 1 hour} \\ \times 5 \left( \begin{matrix} \text{ } \\ \text{ } \end{matrix} \right) +3 \\ \text{---} \text{ for 5 hours} \end{matrix} \right) \text{---} \end{matrix}$

b  $\begin{matrix} \text{---} \left( \begin{matrix} 150 \text{ rotations in 5 minutes} \\ \text{---} \text{ in 1 minute} \\ \text{---} \text{ in 7 minutes} \end{matrix} \right) \text{---} \end{matrix}$

 Example 13 Solving rate problems

- a Rachael can type at 74 words/minute. How many words can she type in 15 minutes?  
 b Leanne works in a doughnut van and sells on average 60 doughnuts every 15 minutes. How long is it likely to take her to sell 800 doughnuts?

## SOLUTION

a  $\begin{matrix} \times 15 \left( \begin{matrix} 74 \text{ words in 1 minute} \\ \underline{1110 \text{ words in 15 minutes}} \\ \times 15 \end{matrix} \right) \end{matrix}$

Rachael can type 1110 words in 15 minutes.

b  $\begin{matrix} +15 \left( \begin{matrix} 60 \text{ doughnuts in 15 minutes} \\ 4 \text{ doughnuts in 1 minute} \\ \times 200 \left( \begin{matrix} \text{ } \\ \text{ } \end{matrix} \right) +15 \\ 800 \text{ doughnuts in } \underline{200 \text{ minutes}} \end{matrix} \right) \times 200 \end{matrix}$

Leanne is likely to take 3 hours and 20 minutes to sell 800 doughnuts.

## EXPLANATION

$$\begin{array}{r} 74 \\ \times 15 \\ \hline 370 \\ 740 \\ \hline 1110 \end{array}$$

Divide both quantities by HCF of 15.

Multiply both quantities by 200.

Convert answer to hours and minutes.

## Now you try

- a Joan can type of 80 words/minute. How many words can she type in 25 minutes?  
 b A hotdog vendor sells on average 60 hotdogs every 20 minutes. How long is it likely to take to sell 210 hotdogs?



### Example 14 Solving combination rate problems

Three water hoses from three different taps are used to fill a large swimming pool. The first hose alone takes 200 hours to fill the pool. The second hose alone takes 120 hours to fill the pool and the third hose alone takes only 50 hours to fill the pool. How long would it take to fill the pool if all three hoses were used?

#### SOLUTION

In 600 hours:

hose 1 would fill 3 pools

hose 2 would fill 5 pools

hose 3 would fill 12 pools

Therefore in 600 hours the three hoses together would fill 20 pools.

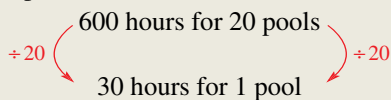

It would take 30 hours to fill the pool if all three hoses were used.

#### EXPLANATION

LCM of 200, 120 and 50 is 600.

Hose 1 =  $600 \text{ h} \div 200 \text{ h/pool} = 3 \text{ pools}$

Hose 2 =  $600 \text{ h} \div 120 \text{ h/pool} = 5 \text{ pools}$

Hose 3 =  $600 \text{ h} \div 50 \text{ h/pool} = 12 \text{ pools}$

Together =  $3 + 5 + 12 = 20 \text{ pools filled.}$

Simplify rate by dividing by HCF.

#### Now you try

Two hoses are used to fill a large pool. The first hose alone takes 100 hours to fill the pool and the second hose takes only 150 hours to fill the pool. How long would it take to fill the pool if both hoses were used?

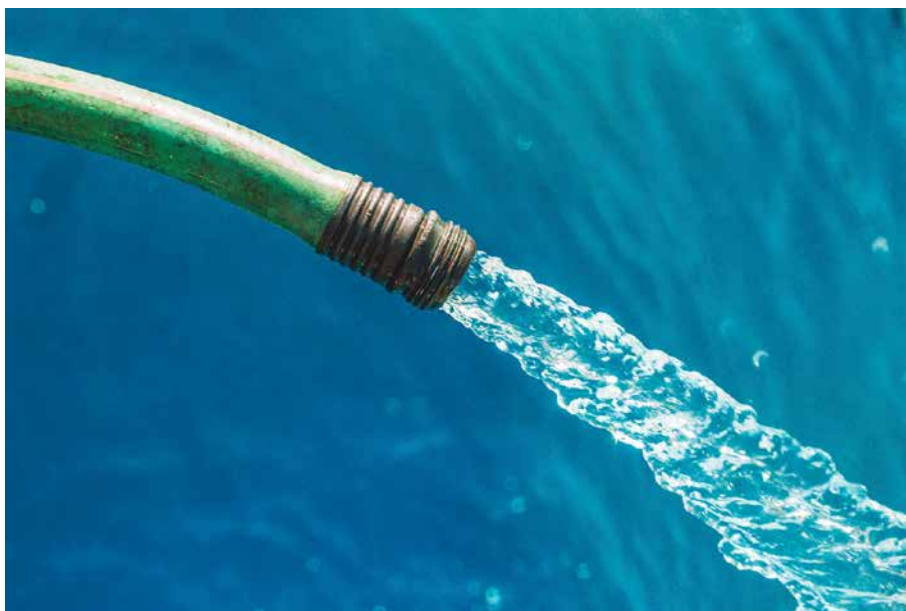

## Exercise 6E

### FLUENCY

1–6

2–7

3–7

- Example 13a**
- Geoff can type 30 words/minute.
    - How many words can he type in 4 minutes?
    - How many words can he type in 10 minutes?
- Example 13a**
- A factory produces 40 plastic bottles per minute.
    - How many bottles can the factory produce in 60 minutes?
    - How many bottles can the factory produce in an 8 hour day of operation?
- Example 13b**
- Mario is a professional home painter. When painting a new home he uses an average of 2 litres of paint per hour. How many litres of paint would Mario use in a week if he paints for 40 hours?
  - A truck travels 7 km per litre of fuel. How many litres are needed for the truck to travel 280 km?
  - Daniel practises his guitar for 40 minutes every day. How many days will it take him to log up 100 hours of practice?
  - A flywheel rotates at a rate of 1500 revolutions per minute.
    - How many revolutions does the flywheel make in 15 minutes?
    - How many revolutions does the flywheel make in 15 seconds?
    - How long does it take for the flywheel to complete 15 000 revolutions?
    - How long does it take for the flywheel to complete 150 revolutions?
  - Putra is an elite rower. When training, he has a steady working heart rate of 125 beats per minute (bpm). Putra's resting heart rate is 46 bpm.
    - How many times does Putra's heart beat during a 30 minute workout?
    - How many times does Putra's heart beat during 30 minutes of 'rest'?
    - If his coach says that he can stop his workout once his heart has beaten 10 000 times, for how long would Putra need to train?

### PROBLEM-SOLVING

8–9

8–10

9–11

- What is the cost of paving a driveway that is 18 m long and 4 m wide, if the paving costs \$35 per square metre?
- A saltwater swimming pool requires 2 kg of salt to be added for every 10 000 litres of water. Joan's swimming pool is 1.5 metres deep, 5 metres wide and 15 metres long. How much salt will she need to add to her pool?
- The Bionic Woman gives Batman a 12 second start in a 2 kilometre race. If the Bionic Woman runs at 5 km/min, and Batman runs at 3 km/min, who will win the race and by how many seconds?
- At a school camp there is enough food for 150 students for 5 days.
  - How long would the food last if there were only 100 students?
  - If the food ran out after only 4 days, how many students attended the camp?

## REASONING

12

12–14

13–15

Example 14

- 12 Michelle can complete a landscaping job in 6 days and Danielle can complete the same job in 4 days. Working together, in how many days could they complete the job?
- 13 Three bricklayers Maric, Hugh and Ethan are cladding a new home. If Maric were to work alone, the job would take him 8 days to complete. If Hugh were to work alone, the job would take him 6 days to complete, and if Ethan were to work by himself, the job would take him 12 days to complete.
- If the three men work together, how long will it take them to complete the job?
  - What fraction of the house will each bricklayer complete?



- 14 Four cans of dog food will feed 3 dogs for 1 day.
- How many cans are needed to feed 10 dogs for 6 days?
  - How many dogs can be fed for 9 days from 60 cans?
  - For how many days will 40 cans feed 2 dogs?
- 15 If it takes 4 workers 4 hours to dig 4 holes, how long would it take 2 workers to dig 6 holes?

## ENRICHMENT: Value for money

–

–

16

- 16 Soft drink can be purchased from supermarkets in a variety of sizes. Below are the costs for four different sizes of a certain brand of soft drink.

600 mL 'buddies'	1.25 L bottles	2 L bottles	10 × 375 mL cans
\$2.70 each	\$1.60 each	\$2.20 each	\$6.00 per pack

- Find the economy rate (in \$/L) for each size of soft drink.
- Find and compare the cost of 30 litres of soft drink purchased entirely in each of the four different sizes.
- If you only have \$60 to spend on soft drink for a party, what is the difference between the greatest amount and the least amount of soft drink you could buy? Assume you have less than \$1.60 left. Most supermarkets now include the economy rate of each item underneath the price tag to allow customers to compare value for money.
- Carry out some research at your local supermarket on the economy rates of a particular food item with a range of available sizes (such as drinks, breakfast cereals, sugar, flour). Write a report on your findings.

## 6F Speed

### LEARNING INTENTIONS

- To understand that speed is a rate relating distance and time
- To be able to find an average speed (given a distance and the time taken)
- To be able to find the distance travelled (given an average speed and the time taken)
- To be able to find the time taken (given an average speed and the distance)
- To be able to convert between different units of speed

A rate that we come across almost every day is speed. Speed is the rate of distance travelled per unit of time.

On most occasions, speed is not constant and therefore we are interested in the average speed of an object. Average speed is calculated by dividing the distance travelled by the time taken.

$$\text{Average speed} = \frac{\text{Distance travelled}}{\text{Time taken}}$$

Given the average speed formula, we can tell that all units of speed must have a unit of length in the numerator, followed by a unit of time in the denominator. Therefore 'mm/h' is a unit of speed and could be an appropriate unit for the speed of a snail!

Two common units of speed are m/s and km/h.



Average speed cameras use automatic number plate recognition technology to record the exact time a car passes under a camera. Average speed is calculated using the time and distance between cameras, and fines are issued for speeding.

### Lesson starter: Which is faster?

With a partner, determine the faster of the two listed alternatives.

- |  |                                  |
|--|----------------------------------|
| <b>a</b> Car A travelling at 10 m/s    | Car B travelling at 40 km/h      |
| <b>b</b> Walker C travelling at 4 km/h | Walker D travelling at 100 m/min |
| <b>c</b> Jogger E running at 1450 m/h  | Jogger F running at 3 m/s        |
| <b>d</b> Plane G flying at 700 km/h    | Plane H flying at 11 km/min      |

## KEY IDEAS

- **Speed** is a measure of how fast an object is travelling.
- If the speed of an object does not change over time, the object is travelling at a **constant speed**. 'Cruise control' helps a car travel at a constant speed.
- When speed is not constant, due to acceleration or deceleration, we are often interested to know the **average speed** of the object.

- Average speed is calculated by the formula:

$$\text{Average speed} = \frac{\text{Distance travelled}}{\text{Time taken}} \quad \text{or} \quad s = \frac{d}{t}$$

- Depending on the unknown value, the above formula can be rearranged to make  $d$  or  $t$  the subject. The three formulas involving  $s$ ,  $d$ , and  $t$  are:

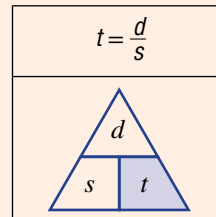
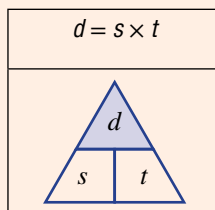
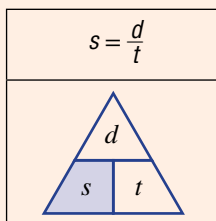

- Care must be taken with units for speed, and on occasions units will need to be converted. The most common units of speed are m/s and km/h.

## BUILDING UNDERSTANDING

- 1 Which of the following is not a unit of speed?  
 A m/s      B km/h      C cm/h      D L/kg      E m/min
- 2 If Average speed =  $\frac{\text{Distance travelled}}{\text{Time taken}}$  then the Distance travelled must equal:  
 A Average speed  $\times$  Time taken      B  $\frac{\text{Average speed}}{\text{Time taken}}$   
 C  $\frac{\text{Time taken}}{\text{Average speed}}$
- 3 If Average speed =  $\frac{\text{Distance travelled}}{\text{Time taken}}$  then Time taken must equal:  
 A Distance travelled  $\times$  Average speed      B  $\frac{\text{Distance travelled}}{\text{Average speed}}$   
 C  $\frac{\text{Average speed}}{\text{Distance travelled}}$
- 4 If an object travels 800 metres in 10 seconds, the average speed of the object is:  
 A 8000 m/s      B 800 km/h      C 80 km/h      D 80 m/s



### Example 15 Finding average speed

Find the average speed in km/h of:

- a a cyclist who travels 140 km in 5 hours
- b a runner who travels 3 km in 15 minutes.

#### SOLUTION

$$\begin{aligned} \text{a } s &= \frac{d}{t} \\ &= \frac{140 \text{ km}}{5 \text{ h}} \\ &= 28 \text{ km/h} \end{aligned}$$

Alternative method:

$$\begin{array}{l} +5 \left( \begin{array}{l} 140 \text{ km in 5 hours} \\ 28 \text{ km in 1 hour} \end{array} \right) +5 \end{array}$$

Average speed = 28 km/h

$$\begin{aligned} \text{b } s &= \frac{d}{t} \\ &= \frac{3 \text{ km}}{15 \text{ min}} \\ &= 3 \div \frac{1}{4} \\ &= 3 \times 4 = 12 \text{ km/h} \end{aligned}$$

Alternative method:

$$\begin{array}{l} \times 4 \left( \begin{array}{l} 3 \text{ km in 15 minutes} \\ 12 \text{ km in 60 minutes} \end{array} \right) \times 4 \end{array}$$

Average speed = 12 km/h

#### EXPLANATION

The unknown value is speed. Write the formula with  $s$  as the subject.

Distance travelled = 140 km

Time taken = 5 h

Speed unit is km/h.

Write down the rate provided in the question.

Divide both quantities by 5.

Distance travelled = 3 km

Time taken = 15 min or  $\frac{1}{4}$  h.

Dividing by  $\frac{1}{4}$  is the same as multiplying by  $\frac{4}{1}$ .

Write down the rate provided in the question.

Multiply both quantities by 4.

#### Now you try

Find the average speed in km/h of:

- a a driver who travels 260 km in 4 hours
- b a walker who travels 2 km in 20 minutes.

**Example 16 Finding the distance travelled**

Find the distance travelled by a truck travelling for 15 hours at an average speed of 95 km/h.

**SOLUTION**

$$\begin{aligned}d &= s \times t \\ &= 95 \text{ km/h} \times 15 \text{ h} \\ &= 1425 \text{ km}\end{aligned}$$

**Alternative method:**

$$\begin{array}{ccc} & 95 \text{ km in 1 hour} & \\ \times 15 \swarrow & & \searrow \times 15 \\ & 1425 \text{ km in 15 hours} & \end{array}$$

Truck travels 1425 km in 15 hours.

**EXPLANATION**

The unknown value is distance.

Write the formula with  $d$  as the subject.

Distance unit is km.

Write the rate provided in the question.

Multiply both quantities by 15.

**Now you try**

Find the distance travelled by a car driving for 3 hours at an average speed of 85 km/h.

**Example 17 Finding the time taken**

Find the time taken for a hiker walking at 4 km/h to travel 15 km.

**SOLUTION**

$$\begin{aligned}t &= \frac{d}{s} \\ &= \frac{15 \text{ km}}{4 \text{ km/h}} \\ &= 3.75 \text{ h} \\ &= 3 \text{ h } 45 \text{ min}\end{aligned}$$

**Alternative method:**

$$\begin{array}{ccc} & 4 \text{ km in 1 hour} & \\ \div 4 \swarrow & & \searrow \div 4 \\ & 1 \text{ km in } \frac{1}{4} \text{ hour} & \\ \times 15 \swarrow & & \searrow \times 15 \\ & 15 \text{ km in } \frac{15}{4} \text{ hours} & \end{array}$$

It takes 3 h 45 min to travel 15 km.

**EXPLANATION**

The unknown value is time.

Write the formula with  $t$  as the subject.

The time unit is h.

Leave answer as a decimal or convert to hours and minutes.

$$0.75 \text{ h} = 0.75 \times 60 = 45 \text{ min}$$

Express the rate as provided in the question.

Divide both quantities by 4.

Multiply both quantities by 15.

(Note:  $\frac{15}{4} = 3\frac{3}{4}$  as a mixed numeral.)

**Now you try**

Find the time taken for someone to jog 4 km at 12 km/h.





- 8 The back end of a 160-metre-long train disappears into a 700-metre-long tunnel. Twenty seconds later the front of the train emerges from the tunnel. Determine the speed of the train in m/s.
- 9 Anna rode her bike to school one morning, a distance of 15 km, at an average speed of 20 km/h. It was raining in the afternoon, so Anna decided to take the bus home. The bus trip home took 30 minutes. What was Anna's average speed for the return journey to and from school?
-  10 *The Ghan* train is an Australian icon. You can board *The Ghan* in Adelaide and 2979 km later, after travelling via Alice Springs, you arrive in Darwin. (Round the answers correct to one decimal place.)
- a If you board *The Ghan* in Adelaide on Sunday at 2:20 p.m. and arrive in Darwin on Tuesday at 5:30 p.m., what is the average speed of the train journey?
- b There are two major rest breaks. The train stops for  $4\frac{1}{4}$  hours at Alice Springs and 4 hours at Katherine. Taking these breaks into account, what is the average speed of the train when it is moving?

## REASONING

11

11, 12

12, 13

- 11 Nina, Shanti and Belle run a 1000 m race at a constant speed. When Nina crossed the finish line first, she was 200 m ahead of Shanti and 400 m ahead of Belle. When Shanti crossed the finish line, how far ahead of Belle was she?
- 12 Julie and Jeanette enjoy finishing their 6 km morning run together. Julie runs at an average speed of 10 km/h and Jeanette runs at an average speed of 3 m/s. If Julie leaves at 8 a.m., at what time should Jeanette leave if they are to finish their run at the same time?
- 13 A person runs at 3 m/s for 60 metres and then at 5 m/s for 60 metres.
- a Find the total amount of time for the person to run 120 metres.
- b Is their average speed slower than, faster than, or equal to 4 m/s? Explain your answer.

## ENRICHMENT: Speed research

-

-

14

-  14 Carry out research to find answers to the following questions.

**Light and sound**

- a What is the speed of sound in m/s?
- b What is the speed of light in m/s?
- c How long would it take sound to travel 100 m?
- d How long would it take light to travel 100 km?
- e How many times quicker is the speed of light than the speed of sound?
- f What is a Mach number?

**Spacecraft**

- g What is the escape velocity needed by a spacecraft to 'break free' of Earth's gravitational pull? Give this answer in km/h and also km/s.
- h What is the orbital speed of planet Earth? Give your answer in km/h and km/s.
- i What is the average speed of a space shuttle on a journey from Earth to the International Space Station?

**Knots**

Wind speed and boat speed are often given in terms of knots (kt).

- j What does a knot stand for?
- k What is the link between nautical miles and a system of locating positions on Earth?
- l How do you convert a speed in knots to a speed in km/h?

The following problems will investigate practical situations drawing upon knowledge and skills developed throughout the chapter. In attempting to solve these problems, aim to identify the key information, use diagrams, formulate ideas, apply strategies, make calculations and check and communicate your solutions.

## Bad news, good news

- 1 For a media project, Kima looks through the newspaper and finds 16 bad news stories and 12 good news stories.

*Kima is interested in the ratio of negative to positive news stories in the media and the best method for calculating these ratios.*

- a Write down the ratio of good news stories to bad news stories from Kima's newspaper in simplest form.
- b If this ratio continued and Kima categorised a total of 140 newspaper stories, how many would be bad news?

Kima thinks it would be fairer to include a third category, which she classifies as 'neutral' – these include predominantly information stories and some sport reports. Kima analyses five newspapers and classifies 180 stories. Kima found the ratio of bad : neutral : good news stories to be 7:3:5.

- c How many neutral stories did Kima find in the five newspapers?
- d If Kima analysed another five newspapers and found 46 bad stories, 44 neutral stories and 30 good news stories, what would the ratio of bad : neutral : good news stories be across the ten different newspapers?
- e The newspaper decided to produce a good news only newspaper for one day. If Kima added this paper to her current set of ten newspapers, how many articles would need to be published for her overall ratio of good: bad news stories to become 1:1?

Kima feels that just counting the number of stories is not the best way to determine the ratio of good to bad news. She finds that most major stories are bad news stories and that these articles can sometimes take up multiple pages of the newspaper, compared to sometimes a small good news story that only takes up a little corner of a page. Kima decides to measure the area of each news story for one newspaper. Her results are provided in the table below.

Category	Area (cm <sup>2</sup> )	Category	Area (cm <sup>2</sup> )	Category	Area (cm <sup>2</sup> )	Category	Area (cm <sup>2</sup> )
Bad	2500	Bad	400	Bad	150	Good	300
Bad	1600	Good	150	Bad	450	Bad	400
Neutral	400	Neutral	1000	Bad	600	Neutral	600
Good	200	Neutral	800	Neutral	200	Bad	100
Bad	800	Good	150	Bad	1000	Good	200

- f Calculate the ratio of area given to the coverage of bad : neutral : good news stories in Kima's newspaper. Give your answer in simplest form.
- g Calculate the ratio of bad : neutral : good news stories in this newspaper. Give your answer in simplest form.
- h Compare the two ratios in parts f and g. Which do you think is a more accurate ratio to report?
- i Choose a different media channel (social media, TV news, school newsletter) and analyse the ratio of good : bad news stories. You may like to consider other categories and you may wish to consider time, length of text, images, order or other variables to increase the sophistication of your analysis.

## Designing maps

- 2 Faibian has been tasked with designing several maps of Australia for his school. When designing a map, a designer must determine the actual size of the area to be represented, the desired size of the map and the scale to fit this area onto the map.

*Faibian is interested in calculating scales for maps of Australia depending on the size of the map required for different scenarios.*

Determine an appropriate scale for the following situations.

- Faibian wishes to have a map of Australia the size of an A4 piece of paper. Note that Australia is approximately 4000 km from the east coast to the west coast and that an A4 piece of paper in landscape format is about 20 cm wide.
- Faibian's school wishes to have a map of Australia which is approximately 10 m wide to go on the outside of their new mathematics building.
- Faibian wishes to have a map of greater Adelaide the size of a large 1 m poster. Note that the diameter of greater Adelaide is about 100 km.

Faibian turns his interest in scaled drawings to Google Maps where the scale of their maps instantly changes as touch screen users move their fingers to zoom in or out of particular maps.

- Faibian gets a map of Australia to show on his phone on Google Maps. He observes the scale located at the bottom of the map. Using a ruler, determine the scale of this map.
- Using Google Maps, determine the scale used to show a map that includes both your home and your school.
- Using Google Maps, how many times larger is the size of your school compared to the map on your phone or computer?

## Four seasons in one day

- 3 Melbourne is known for its changing weather patterns and some visitors refer to the weather as four seasons in one day. For a period of ten consecutive days over summer, Stuart records the following Melbourne temperature information. All temperatures are measured in °C and given to the nearest whole degree.

Day	Temp. at 9 a.m.	Temp. at 3 p.m.	Daily min.	Daily max.
1	12	24	10	28
2	16	28	14	28
3	14	21	14	25
4	21	34	16	36
5	25	38	24	39
6	17	29	15	30
7	14	25	12	30
8	18	27	16	29
9	32	40	22	45
10	22	41	16	41

*Stuart is interested in investigating the rate of change in Melbourne's temperature across the day in summer.*

- a** On which day did Stuart record the highest:
- i** temperature at 9 a.m.?
  - ii** temperature at 3 p.m.?
  - iii** daily minimum?
  - iv** daily maximum?
- b** Using the daily temperature recordings at 9 a.m. and 3 p.m., calculate the average rate of change in temperature in degrees per hour for each of the ten days.
- c**
- i** Which day had the highest average rate of change in temperature?
  - ii** Which day had the lowest average rate of change in temperature?
- d**
- i** What would the temperature at 3 p.m. need to be on day 5 if the average rate of change in temperature on this day was  $2.5^{\circ}\text{C}/\text{hour}$ ?
  - ii** What would the temperature at 9 a.m. need to be on day 2 if the average rate of change in temperature on this day was  $1.5^{\circ}\text{C}/\text{hour}$ ?

Over these ten days, Stuart determines that the daily minimum occurs on average at 5:30 a.m. and the time of the daily maximum occurs on average at 4:15 p.m.

- e** Using this additional time information and by calculating the average daily minimum and average daily maximum for the ten days, determine the average rate of change in  $^{\circ}\text{C}/\text{hour}$  for Melbourne temperature across these ten days.
- f** Investigate the rate of change in temperature for your local area.
- i** Choose one day and record the temperature to the nearest degree each hour from 9 a.m. to 9 p.m.
  - ii** Calculate the rate of change in temperature for each hour.
  - iii** Calculate the average rate of change in temperature across the twelve hours.
  - iv** Calculate the average rate of change in temperature between the daily minimum and the daily maximum.
  - v** Discuss your findings in comparison to Melbourne's temperature.



## 6G Ratios and rates and the unitary method EXTENDING

### LEARNING INTENTIONS

- To understand that the unitary method involves finding the value of 'one unit' first
- To be able to solve ratio and rates problems using the unitary method
- To be able to convert rates between different units using the unitary method

The concept of solving problems using the unitary method was introduced in Chapter 3. The unitary method involves finding the value of 'one unit'. This is done by dividing the amount by the given quantity. Once the value of 'one unit' is known, multiplying will find the value of the number of units required.

### Lesson starter: Finding the value of 1 unit

For each of the following, find the value of 1 unit or 1 item.

- 8 basketballs cost \$200.
- 4 cricket bats cost \$316.
- 5 kg of watermelon cost \$7.50.

For each of the following, find the rate per 1 unit.

- Car travelled 140 km in 2 hours.
- 1000 L of water leaked out of the tank in 8 hours.
- \$51 was the price paid for 3 kg of John Dory fish.

For each of the following, find the value of 1 'part'.

- Ratio of books to magazines read was 2:5. Milli had read 14 books.
- Ratio of pink to red flowers is 7:11. A total of 330 red flowers are in bloom.
- Ratio of girls to boys is 8:5. There are 40 girls in a group.



Southern bluefin tuna are scientifically farmed in South Australia and fed on sardines. The FIFO ratio = Fish In (sardines) : Fish Out (tuna) is a measure of efficiency. If FIFO = 5:1 = 1:0.2, this shows 1 kg of fish food produces 0.2 kg of tuna.

### KEY IDEAS

- The **unitary method** involves finding the value of 'one unit' and then using this information to solve the problem.
- When dealing with **ratios**, find the value of 1 'part' of the ratio.  
For example: If the ratio of phones to televisions is 5:2, find the number of televisions for 15 phones.

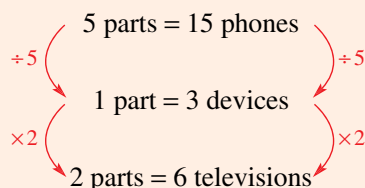

- When dealing with **rates**, find the value of the rate per 1 'unit'.  
For example: Pedro earned \$64 for a 4-hour shift at work.

Therefore, wage rate = \$64 per 4 hours = \$16 per hour = \$16/h.

- Once the value of one ‘part’ or the rate per one ‘unit’ is known, the value of any number of parts or units can be found by multiplying.
- The technique of dividing and/or multiplying values in successive one-step calculations can be applied to the concept of converting rates from a set of given units to a different set of units.

## BUILDING UNDERSTANDING

- 1 12 packets of biscuits cost \$18.60.
  - a What is the cost of one packet?
  - b What is the cost of 7 packets?
- 2 The ratio of books to magazines is 2:3 and there are a total of 25 books and magazines altogether.
  - a If 5 parts = 25 books and magazines, find the value of one part.
  - b How many magazines are there?



### Example 18 Reviewing the unitary method

Andy travels 105 km in 7 identical car trips from home to school. How far would she travel in 11 such car trips?

#### SOLUTION

$$\begin{array}{l}
 +7 \left\{ \begin{array}{l} 7 \text{ car trips} = 105 \text{ km} \\ 1 \text{ car trip} = 15 \text{ km} \end{array} \right. \begin{array}{l} +7 \\ \times 11 \end{array} \\
 \times 11 \left\{ \begin{array}{l} 1 \text{ car trip} = 15 \text{ km} \\ 11 \text{ car trips} = 165 \text{ km} \end{array} \right. \begin{array}{l} \times 11 \\ \end{array}
 \end{array}$$

Andy travels 165 km.

#### EXPLANATION

Find the value of 1 unit by dividing both quantities by 7.

Solve the problem by multiplying both quantities by 11.

#### Now you try

Fred paid \$100 for 4 identical shirts. How much would 7 of these shirts cost?



### Example 19 Solving ratio problems using the unitary method

The ratio of apples to oranges is 3:5. If there are 18 apples, how many oranges are there?

#### SOLUTION

$$\begin{array}{l}
 \div 3 \left\{ \begin{array}{l} 3 \text{ parts} = 18 \text{ apples} \\ 1 \text{ part} = 6 \text{ pieces} \end{array} \right. \begin{array}{l} +3 \\ \times 5 \end{array} \\
 \times 5 \left\{ \begin{array}{l} 1 \text{ part} = 6 \text{ pieces} \\ 5 \text{ parts} = 30 \text{ oranges} \end{array} \right. \begin{array}{l} \times 5 \\ \end{array}
 \end{array}$$

There are 30 oranges.

#### EXPLANATION

Apples = 3 ‘parts’, oranges = 5 ‘parts’  
Need to find the value of 1 ‘part’.

To find 5 ‘parts’, multiply the value of 1 ‘part’ by 5.

**Now you try**

The ratio of bananas to mandarins is 4:7. If there are 24 bananas, how many mandarins are there?

**Example 20 Solving rate problems using the unitary method**

A truck uses 4L of petrol to travel 36 km. How far will it travel if it uses 70L of petrol?

**SOLUTION**

Rate of petrol consumption  
 $\begin{array}{l} 36 \text{ km for 4 L} \\ \xrightarrow{+4} 9 \text{ km for 1 L} \\ \xrightarrow{\times 70} 630 \text{ km for 70 L} \end{array}$

Truck will travel 630 km on 70L.

**EXPLANATION**

Find the petrol consumption rate of 1 unit by dividing both quantities by 4.  
Solve the problem by multiplying both quantities by 70.

**Now you try**

A car uses 6L of petrol to travel 72 km. How far will it travel if it uses 20L of petrol?

**Example 21 Converting units using the unitary method**

Melissa works at the local supermarket and earns \$57.60 for a 4-hour shift. How much does she earn in c/min?

**SOLUTION**

$\begin{array}{l} \$57.60 \text{ for 4 hours} \\ \xrightarrow{+4} \$14.40 \text{ for 1 hour} \\ \xrightarrow{+60} 1440c \text{ for 60 minutes} \\ \xrightarrow{+60} 24c \text{ for 1 minute} \end{array}$

Melissa earns 24c/min.

**EXPLANATION**

Write down Melissa's wage rate.  
Find the rate of \$ per 1 hour.  
Convert \$ to cents and hours to minutes.  
Divide both numbers by 60 to find rate of cents per minute.

**Now you try**

Simone earns \$90 for a 5-hour shift working at a cafe. How much does she earn in c/min?



**Example 22 Converting units of speed****a** Convert 72 km/h to m/s.**b** Convert 8 m/s to km/h.**SOLUTION**

**a**

72 km in 1 hour  
 $\xrightarrow{+60}$  72 000 m in 60 minutes  $\xrightarrow{+60}$   
 1200 m in 1 minute  
 $\xrightarrow{+60}$  1200 m in 60 seconds  $\xrightarrow{+60}$   
 20 m in 1 second

$\therefore 72 \text{ km/h} = 20 \text{ m/s}$

**b**

$\times 60$  8 m in 1 second  $\times 60$   
 $\times 60$  480 m in 1 minute  $\times 60$   
 28 800 m in 1 hour

$\therefore 8 \text{ m/s} = 28.8 \text{ km/h}$

**EXPLANATION**

Express rate in kilometres per hour.  
 Convert km to m and hour to minutes.  
 Divide both quantities by 60.  
 Convert 1 minute to 60 seconds.  
 Divide both quantities by 60.  
 Shortcut for converting km/h  $\rightarrow$  m/s  $\div 3.6$ .

Express rate in metres per second.  
 Multiply by 60 to find distance in 1 minute.  
 Multiply by 60 to find distance in 1 hour.  
 Convert metres to kilometres.  
 Shortcut: m/s  $\times 3.6 \rightarrow$  km/h.  
 $8 \text{ m/s} \times 3.6 \rightarrow 28.8 \text{ km/h}$

**Now you try****a** Convert 18 km/h to m/s.**b** Convert 10 m/s to km/h.**Exercise 6G****FLUENCY**1, 2-4( $\frac{1}{2}$ ), 6-8( $\frac{1}{2}$ )2-4( $\frac{1}{2}$ ), 5, 6-8( $\frac{1}{2}$ )3-4( $\frac{1}{2}$ ), 5, 6-8( $\frac{1}{2}$ )

Example 18

**1** Marissa travels 26 km in 2 identical car trips. How far would she travel in 7 such car trips?

Example 18

**2** Solve the following problems.

- a** If 8 kg of chicken fillets cost \$72, how much would 3 kg of chicken fillets cost?  
**b** If one dozen tennis balls cost \$9.60, how much would 22 tennis balls cost?  
**c** If three pairs of socks cost \$12.99, how much would 10 pairs of socks cost?  
**d** If 500 g of mince meat costs \$4.50, how much would 4 kg of mince meat cost?

Example 19

**3** Solve the following ratio problems.

- a** The required staff to student ratio for an excursion is 2:15. If 10 teachers attend the excursion, what is the maximum number of students who can attend?  
**b** The ratio of commercials to actual show time for a particular TV channel is 2:3. How many minutes of actual show were there in 1 hour?  
**c** A rectangle has length and width dimensions in a ratio of 3:1. If a particular rectangle has a length of 21 m, what is its width?  
**d** Walter and William have a height ratio of 7:8. If William has a height of 152 cm, how tall is Walter?

- Example 20** 4 Solve the following rate problems.
- A tap is dripping at a rate of 200 mL every 5 minutes. How much water drips in 13 minutes?
  - A professional footballer scores an average of 3 goals every 6 games. How many goals is he likely to score in a full season of 22 games?
  - A snail travelling at a constant speed travels 400 mm in 8 minutes. How far does it travel in 7 minutes?
  - A computer processor can process 500 000 kilobytes of information in 4 seconds. How much information can it process in 15 seconds?
- 5 Leonie, Spencer and Mackenzie have just won a prize. They decide to share it in the ratio of 4:3:2. If Spencer receives \$450, how much do Leonie and Mackenzie receive, and what was the total value of the prize?

- Example 21** 6 Convert the following rates into the units given in the brackets.
- |                          |                       |
|--------------------------|-----------------------|
| a \$15/h (c/min)         | b \$144/h (c/s)       |
| c 3.5 L/min (L/h)        | d 20 mL/min (L/h)     |
| e 0.5 kg/month (kg/year) | f 120 g/day (kg/week) |
| g 60 g/c (kg/\$)         | h \$38/m (c/mm)       |
| i 108 km/h (m/s)         | j 14 m/s (km/h)       |

- Example 22a** 7 Convert the following speeds to m/s.
- |           |            |             |          |
|-----------|------------|-------------|----------|
| a 36 km/h | b 180 km/h | c 660 m/min | d 4 km/s |
|-----------|------------|-------------|----------|



- Example 22b** 8 Convert the following speeds to km/h.
- |          |         |            |          |
|----------|---------|------------|----------|
| a 15 m/s | b 2 m/s | c 12 m/min | d 1 km/s |
|----------|---------|------------|----------|

### PROBLEM-SOLVING

9, 10

9–11

10–12

-  9 The Mighty Oats breakfast cereal is sold in boxes of three different sizes: small (400 g) for \$5.00, medium (600 g) for \$7.20, large (750 g) for \$8.25
- Find the value of each box in \$/100 g.
  - What is the cheapest way to buy a 4 kg of the cereal?
-  10 In Berlin 2009, Jamaican sprinter Usain Bolt set a new 100 m world record time of 9.58 seconds. Calculate Usain Bolt's average speed in m/s and km/h for this world record. (Round the answers correct to one decimal place.)
- 11 Zana's hair grew 6 cm in 5 months.
- Find Zana's average rate of hair growth in cm/month and in m/year.
  - How long would it take for Zana's hair to grow 30 cm?
- 12 Maria can paint  $15 \text{ m}^2$  in 20 minutes.
- What is the rate at which Maria paints in  $\text{m}^2/\text{h}$ ?
  - What area can Maria paint in 20 hours?
  - Maria must paint  $1000 \text{ m}^2$  in 20 hours. Find the rate at which she will need to paint in  $\text{m}^2/\text{min}$ .



## REASONING

13

13, 14

13–15

- 13 If  $x$  doughnuts cost  $\$y$ , write expressions for the following costs.
- How much would 1 doughnut cost?
  - How much would one dozen doughnuts cost?
  - How much would  $z$  doughnuts cost?
- 14 a A triangle has side lengths in a ratio of 19:22:17. If the shortest side is 17 cm, find the lengths of the other two sides and the perimeter of the triangle.
- b A triangle has side lengths in a ratio of 3:5:4. If the longest side is 35 cm, find the lengths of the other two sides and the perimeter of the triangle.
- 15 In a faraway galaxy, a thriving alien colony uses the following units:  
 For money they have puks and paks: 1 puk (pu) = 1000 pak (pa)  
 For length they have doits and minidoits: 1 doit (D) = 80 minidoits (mD)  
 Polynaute rope is priced at 4 pu/D. Find the cost of the rope in terms of pa/mD.

## ENRICHMENT: Where will we meet?

–

–

16



- 16 Phil lives in Perth and his friend Werner lives in Sydney. The distance, by road, between their two houses is 4200 km (rounded to the nearest 100 km).

Phil decides to drive to Sydney and Werner decides to drive to Perth. They leave home at the same time and travel the same route, but in opposite directions.

Phil drives at a constant speed of 75 km/h and Werner drives at a constant speed of 105 km/h.

- Will they meet on the road at a spot closer to Sydney or closer to Perth?
- How long will it take Phil to travel to Sydney?
- How long will it take Werner to travel to Perth?
- State the location of each friend after they have been driving for 15 hours.
- At what location (distance from Sydney and/or Perth) will they meet?

When they meet, Phil decides to change into Werner's car and they drive back to Werner's home at an average speed of 105 km/h.

- How long did it take Phil to travel to Sydney?
- Design a similar problem for two friends travelling at different constant speeds between two different capital cities in Australia.



## Ethanol fuel mix

Abbey is planning to make a 2000 km trip from Brisbane to Melbourne. A local fuel retailer advises her that it might be cheaper to buy one of their fuel mixes that contain both petrol and ethanol. The currently available types with their ratios, costs and projected fuel economy for Abbey's car are shown below.

Type	Petrol:ethanol ratio	Fuel economy	Price
E20	4:1	9L/100 km	\$1.30/L
E10	9:1	8L/100 km	\$1.45/L
Petrol	N/A (100% petrol)	7.5L/100 km	\$1.60/L

Present a report for the following tasks and ensure that you show clear mathematical workings and explanations where appropriate.

### Preliminary task

- How much does Abbey spend if she buys:
  - 60 litres of petrol?
  - 65 litres of E10?
  - 67.5 litres of E20?
- The fuel economy for petrol is 7.5L/100km. How far can Abbey travel using 60 litres of petrol?
- How far can Abbey travel if she purchases fuel according to the different options from part **a**?
- The E10 fuel has a petrol:ethanol ratio of 9:1. Divide 65 litres in this ratio to find the amount of ethanol in this mix.
- Determine the amount of ethanol purchased if Abbey buys 67.5 litres of the E20 mix.

### Modelling task

- |                            |  |
|----------------------------|--|
| <b>Formulate</b>           | <b>a</b> The problem is to determine the minimum cost to spend on fuel for her 2000 km trip from Brisbane to Melbourne by considering the different fuel options. Write down all the relevant information that will help solve this problem.   |
| <b>Solve</b>               | <b>b</b> Determine the total amount of fuel Abbey needs to purchase for the trip if she uses: <ol style="list-style-type: none"> <li>petrol fuel</li> <li>E10 fuel</li> <li>E20 fuel.</li> </ol> <b>c</b> Determine the total cost of purchasing the following fuel for the entire trip. <ol style="list-style-type: none"> <li>petrol fuel</li> <li>E10 fuel</li> <li>E20 fuel</li> </ol> <b>d</b> Determine the total saving if Abbey purchases: <ol style="list-style-type: none"> <li>E20 instead of petrol fuel</li> <li>E10 instead of petrol fuel.</li> </ol> |
| <b>Evaluate and verify</b> | <b>e</b> Abbey thinks that she can buy petrol for the trip at an average price of \$1.55/L. Will this mean that petrol is the cheapest option? Justify your response.<br><b>f</b> By hunting around Abbey can find a better price for E20 for the 2000 km trip. At what price should Abbey purchase E20 to make the overall cost less than the overall cost of purchasing E10?   |
| <b>Communicate</b>         | <b>g</b> Summarise your results and describe any key findings.   |

### Extension questions

A friend of Abbey's warned her against ethanol-type fuels and said that for each litre of ethanol consumed by the car, it would add a wear-and-tear cost of 50 cents.

- Determine the amount of ethanol consumed by Abbey's car for the 2000 km trip if E10 is used and also if E20 is used.
- Does this extra wear-and-tear cost make the petrol option the cheapest for the 2000 km trip?

## Paper size ratios

### Key technology: Spreadsheets and programming

The standard international paper size is called ISO 216 and consists of 11 sizes from A0 through to A10. Most of the time we use A4 in our printers and exercise books. The ratio of the length of any standard size paper to its width is constant regardless of the size of paper. A0 to A8 is shown here with measurements rounded to the nearest mm.

### 1 Getting started

First consider these facts for standard paper.

- 1 The total area of A0 is  $1 \text{ m}^2$ .
- 2 The length of A0 is  $\sqrt{2}$  m.
- 3 The width of A0 is  $\frac{1}{\sqrt{2}}$  m.
- 4 The width of all paper sizes is the length divided by  $\sqrt{2}$ .
  - a Use the above facts to show the following, rounded to the nearest mm.
    - i The length of A0 is 1189 mm.
    - ii The width of A0 is 841 mm.

- b Note for example that the width of A3 is equal to the length of A4. Use this fact and fact 4 above to find the lengths and widths of the following paper sizes. Check that your results agree with the figures in the diagram above.
  - i A1
  - ii A2
  - iii A3
  - iv A4

- c Use fact 4 to state the ratio *length:width*.

### 2 Applying an algorithm

This flow chart is designed to determine the length and width of the standard paper sizes A0 through A10 in millimetres.

- a Run through the algorithm for at least five passes and enter the output in the following table. Round to the nearest mm.

<i>i</i>	0	1	2	3	4
<i>l</i>					
<i>w</i>					

- b As we have stated, the width of one piece of paper becomes the length of the paper on the next size down. Which line in the algorithm updates the next length with the old width?
- c Explain why the flow chart contains the line  $w = l \div \sqrt{2}$ .

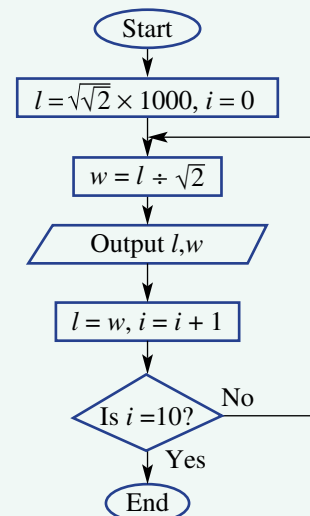
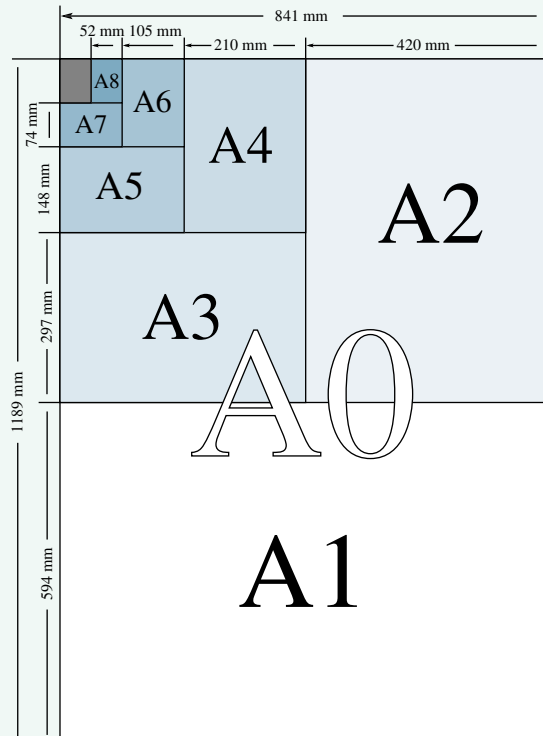

### 3 Using technology

A spreadsheet can be used to execute the algorithm on the previous page.

	A	B	C	D
1	Paper ratios			
2				
3	A size	Length (mm)	Width (mm)	Area (sq. metres)
4				
5	0	=SQRT(SQRT(2))*1000	=1/(SQRT(SQRT(2)))*1000	=B5*C5/1000000
6	=A5+1	=C5	=B6/SQRT(2)	
7				

- Create a spreadsheet to generate the lengths and widths of standard paper sizes by entering the given information.
- Fill down at cells A6, B6, C6 and D5 to produce the information for paper sizes A0 through to A10. Check your results with parts 1 and 2 on the previous page.
- The total area of A0 is  $1 \text{ m}^2$ . Use the formula =SUM(D6:D15) to find the total sum of A1 through to A10. Can you explain why the sum is not equal to 1 when we know that the total area of A0 is  $1 \text{ m}^2$ ? (*Hint: Look at the original diagram showing how an A0 page is divided to form all the other sizes. What do you notice about the remainder each time the next size down is created?*)

### 4 Extension

We know that the ratio of the length of standard paper size to its width is  $\sqrt{2}:1$  and that the area of A0 is  $1 \text{ m}^2$ . Use this information and the variable  $w$  shown in this diagram to complete the following.

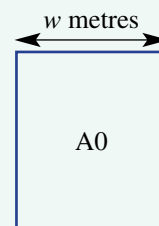

- Write an expression for the length in terms of  $w$ .
- Write an expression for the area in terms of  $w$ .
- Use your expression from part b and the area of A0 paper ( $1 \text{ m}^2$ ) to show the following:
  - $w = \frac{1}{\sqrt{2}}$
  - $l = \sqrt{\sqrt{2}}$
- Write a program in a language like Python to execute the algorithm outlined in part 2 on the previous page.



## Fun run investigation

Three maths teachers, Mrs M, Mr P and Mr A, trained very hard to compete in a Brisbane Fun Run. The 10.44 km route passed through the botanical gardens, along the Brisbane River to New Farm Park, and back again. Their times and average stride lengths were:

- Mrs M: 41 minutes, 50 seconds: 8 strides per 9 m
- Mr P: 45 minutes, 21 seconds: 7 strides per 9 m
- Mr A: 47 minutes, 6 seconds: 7.5 strides per 9 m

Copy and complete the following table and determine which rates are the most useful representations of fitness. Give the answers rounded to one decimal place. Justify your conclusions.

Running rates	Mrs M	Mr P	Mr A	World record 10 km runners	Your family member or friend
Seconds per 100 m					
Seconds per km					
Metres per minute					
Km per hour					
Strides per 100 m					
Strides per minute					
Strides per hour					

## Fitness investigation

- Using a stopwatch, measure your resting heart rate in beats per minute.
- Run on the spot for one minute and then measure your working heart rate in beats per minute.
- Using a stopwatch, time yourself for a 100 m run and also count your strides. At the end, measure your heart rate in beats per minute. Also calculate the following rates.
  - Your running rate in m/s, m/min and km/h
  - Your running rate in time per 100 m and time per km
  - Your rate of strides per minute, strides per km and seconds per stride
- Run 100 m four times without stopping, and using a stopwatch, record your cumulative time after each 100 m.
  - Organise these results into a table.
  - Draw a graph of the distance run (vertical) vs time taken (horizontal).
  - Calculate your running rate in m/min for each 100 m section.
  - Calculate your overall running rate in m/min for the 400 m.
  - Explain how and why your running rates changed over the 400 m.
- Try sprinting fast over a measured distance and record the time. Calculate your sprinting rate in each of the following units:
  - minutes per 100 m
  - time per km
  - metres per minute
  - km per hour.
- Research the running rate of the fastest schoolboy and schoolgirl in Australia. How do their sprinting rates compare to the running rates of Australian Olympian athletes?





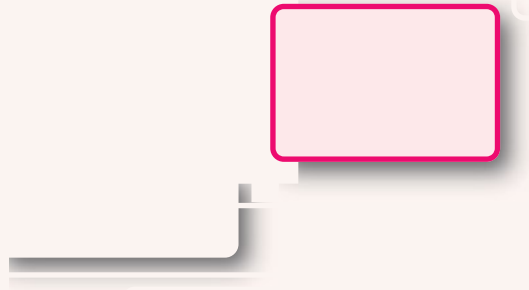
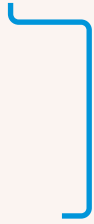

## Chapter checklist with success criteria

A printable version of this checklist is available in the Interactive Textbook



6A	<b>1. I can produce a ratio that is equivalent to a given ratio.</b> e.g. State the missing number in the equivalence $30:15 = ?:5$ .	<input type="checkbox"/>
6A	<b>2. I can simplify ratios involving whole numbers.</b> e.g. Simplify $450:200$ .	<input type="checkbox"/>
6A	<b>3. I can simplify ratios involving fractions.</b> e.g. Simplify $2\frac{1}{3}:1\frac{1}{4}$ .	<input type="checkbox"/>
6A	<b>4. I can write simplified ratios involving quantities by first converting units.</b> e.g. Write the relationship '25 minutes to 2 hours' as a ratio by first changing the quantities to the same unit.	<input type="checkbox"/>
6B	<b>5. I can find an unknown quantity using a ratio.</b> e.g. Find the amount of water to combine with 10 cups of rice if rice and water are combined in the ratio 2:3.	<input type="checkbox"/>
6B	<b>6. I can divide a quantity in a ratio with two or three terms.</b> e.g. Divide 54 m in a ratio of 4:5 and divide \$300 in the ratio of 2:1:3.	<input type="checkbox"/>
6C	<b>7. I can convert from scale distance to actual distance using a scale.</b> e.g. A map has a scale of 1:20 000. Find the actual distance for a scale distance of 5 mm. Answer in metres.	<input type="checkbox"/>
6C	<b>8. I can convert from actual distance to scale distance using a scale.</b> e.g. A model boat has a scale of 1:500. Find the scaled length for an actual length of 75 cm. Answer in millimetres.	<input type="checkbox"/>
6C	<b>9. I can determine the scale factor.</b> e.g. Determine the scale factor if an actual length of 0.1 mm is represented by 3 cm on a scale drawing.	<input type="checkbox"/>
6D	<b>10. I can write simplified rates.</b> e.g. Express \$28 for 4 kilograms as a simplified rate.	<input type="checkbox"/>
6D	<b>11. I can find average rates.</b> e.g. Tom was 120 cm tall when he turned 10 years old, and 185 cm when he turned 20 years old. Find Tom's average rate of growth per year over this period.	<input type="checkbox"/>
6E	<b>12. I can solve rate problems.</b> e.g. Rachael can type at 74 words/minute. How many words can she type in 15 minutes?	<input type="checkbox"/>
6F	<b>13. I can find an average speed.</b> e.g. Find the average speed in km/h of a runner who travels 3 km in 15 minutes.	<input type="checkbox"/>
6F	<b>14. I can find the distance travelled.</b> e.g. Find the distance travelled by a truck travelling for 15 hours at an average speed of 95 km/h.	<input type="checkbox"/>
6F	<b>15. I can find the time taken to travel a given distance at a given speed.</b> e.g. Find the time taken for a hiker walking at 4 km/h to travel 15 km.	<input type="checkbox"/>

			✓
6F	<b>16. I can convert units of speed.</b> e.g. Convert 72 km/h to m/s.		<input type="checkbox"/>
6G	<b>17. I can solve ratio problems using the unitary method.</b> e.g. The ratio of apples to oranges is 3:5. If there are 18 apples, how many oranges are there?	(Ext)	<input type="checkbox"/>
6G	<b>18. I can solve rate problems using the unitary method.</b> e.g. A truck uses 4 L of petrol to travel 36 km. How far will it travel using 70 L?	(Ext)	<input type="checkbox"/>
6G	<b>19. I can convert units for rates using the unitary method.</b> e.g. Melissa works at the local supermarket and earns \$57.60 for a 4 hour shift. How much does she earn in c/min?	(Ext)	<input type="checkbox"/>

## Short-answer questions

6A

1 In Lao's pencil case there are 6 coloured pencils, 2 black pens, 1 red pen, 5 marker pens, 3 lead pencils and a ruler. Find the ratio of:

- a lead pencils to coloured pencils
- b black pens to red pens
- c textas to all pencils.

6A

2 State whether the following are true or false.

- a  $1:4 = 3:6$
- b The ratio 2:3 is the same as 3:2.
- c The ratio 3:5 is written in simplest form.
- d 40 cm:1 m is written as 40:1 in simplest form.
- e  $1\frac{1}{4}:2 = 5:8$

6A

3 Copy and complete.

a  $4:50 = 2 : \square$

b  $1.2:2 = \square : 20$

c  $\frac{2}{3}:4 = 1 : \square$

d  $1 : \square : 5 = 5:15:25$

6A

4 Simplify the following ratios.

a 10:40

b 36:24

c 75:100

d 8:64

e 27:9

f 5:25

g 6:4

h 52:26

i  $6b:9b$

j  $8a:4$

k  $\frac{2}{7}:\frac{5}{7}$

l  $1\frac{1}{10}:\frac{2}{10}$

m  $2\frac{1}{2}:\frac{3}{4}$

n 12:36:72

6A

5 Simplify the following ratios by first changing to the same units.

a 2 cm to 8 mm

b 5 mm to 1.5 cm

c 3L to 7500 mL

d 30 min to 1 h

e 400kg to 2t

f 6h to 1 day

g 120m to 1 km

h 45 min to  $2\frac{1}{2}$ h

6B

6 Divide:

a \$80 in the ratio 7:9

b 200 kg in the ratio 4:1

c 4 mm to 1.5 cm

d \$1445 in the ratio 4:7:6

e \$1 in the ratio 3:1:1

6B

7 a The ratio of the cost price of a TV to its retail price is 5:12. If its cost price is \$480, calculate its retail price.

b The ratio of Sally's height to Ben's height is 12:17. If the difference in their heights is 60 cm, how tall is Sally?

c Orange juice, pineapple juice and guava juice are mixed in the ratio 4:3:2. If 250 mL of guava juice is used, how many litres of drink does this make?

6C

8 For a scale of 1:1000, find the real length (in metres) if the scale length is given as:

a 0.0002 m

b 2.7 cm

c 140 mm

**6C** 9 Two cities are 50 km apart. How many millimetres apart are they on a map that has a scale of 1:100 000?

**6C** 10 Find the scale factor for the following pairs of similar figures, and find the value of  $x$ .

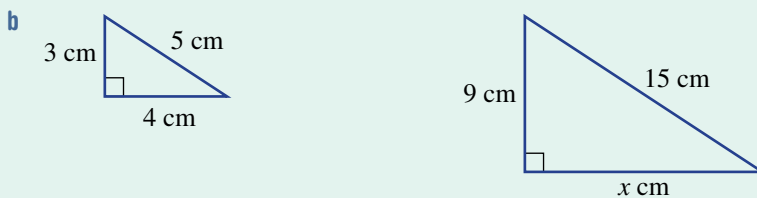
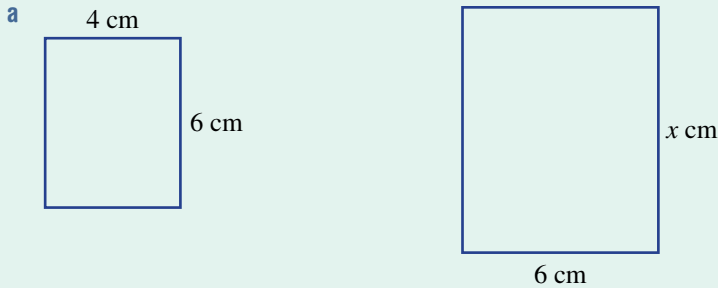

**6D** 11 Express each rate in simplest form.

**a** 10 km in 2 hours

**b** \$650 for 13 hours

**c** 2800 km in 20 days

**6D** 12 Copy and complete.

**a** 400 km on 32 litres = \_\_\_ km/L  
= \_\_\_ L/100 km

**b** 5 grams in 2 min = \_\_\_ g/min  
= \_\_\_ g/h

**c** \$1200 in  $\frac{1}{2}$  day = \_\_\_ \$/day  
= \_\_\_ \$/h

**6E** 13 **a** A truck uses 12 litres of petrol to travel 86 km. How far will it travel on 42 litres of petrol?

**b** Samira earns \$67.20 for a 12-hour shift. How much will she earn for a 7-hour shift?



**c** Tap 1 fills the pool in 12 hours, while tap 2 fills the same pool in 15 hours. How long does it take to fill this pool if both taps are used?

**6F** 14 **a** Sandra drives to her mother's house. It takes 45 minutes. Calculate Sandra's average speed if her mother lives 48 km away.



**b** How long does it take Ari to drive 180 km along the freeway to work if he manages to average 100 km/h for the trip?

**c** How far does Siri ride her bike if she rides at 4.5 km/h for 90 minutes?

**6G** 15 Copy and complete.

**a** \$120/h = \_\_\_ c/min

**b** 6 m/s = \_\_\_ km/h

**c** 720 km/h = \_\_\_ m/s



## Multiple-choice questions

6A

1 The simplified form of 55:5 is:

A 11:1

B 1:11

C 5:6

D 6:5

6A

2 The ratio of the shaded area to the unshaded area in this triangle is:

A 3:5

B 8:5

C 5:3

D 5:8

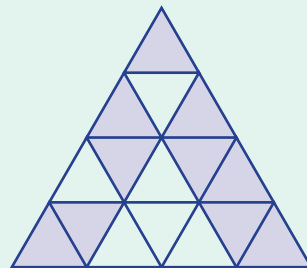

6A

3 The ratio 500 mm to  $\frac{1}{5}$  m is the same as:

A 50:2

B 2500:1

C 2:5

D 5:2

6A

4 The ratio  $1\frac{1}{2}:\frac{3}{4}$  simplifies to:

A 2:1

B 1:2

C 3:4

D 4:3

6B

5 \$750 is divided in the ratio 1:3:2. The smallest share is:

A \$250

B \$125

C \$375

D \$750

6B

6 The ratio of the areas of two triangles is 5:2. The area of the larger triangle is  $60\text{ cm}^2$ . What is the area of the smaller triangle?A  $12\text{ cm}^2$ B  $24\text{ cm}^2$ C  $30\text{ cm}^2$ D  $17\text{ cm}^2$ 

6C

7 On a map, Sydney and Melbourne are 143.2 mm apart. If the cities are 716 km apart, what scale has been used?

A 1:5

B 1:5000

C 1:50 000

D 1:5 000 000

6D

8 The cost of a collectible card rose from \$30 to \$50 over a 5-year period. The average rate of growth is:

A \$2/year

B \$4/year

C \$6/year

D \$10/year

6E

9 Callum fills his car with 28 litres of petrol at 142.7 cents per litre. His change from \$50 cash is:

A \$10

B \$39.95

C \$10.05

D \$40

6F

10 45 km/h is the same as:

A 0.25 m/s

B 25 m/s

C 12.5 m/s

D 75 m/s

Ext

## Extended-response questions

The Harrison family and the Nguyen family leave Wollongong at 8 a.m. on Saturday morning for a holiday in Melbourne. The Harrisons' 17-year-old son drives for the first 2 hours at 80 km/h. They then stop for a rest of  $1\frac{1}{2}$  hours. Mr Harrison drives the rest of the way.

The Nguyen family drives straight to Melbourne with no stops. It takes them 6 hours and 15 minutes to drive the 627 km to Melbourne.

- a At what time did the Nguyen family arrive in Melbourne?
- b Calculate the average speed of the Nguyen's car. Round your answer to the nearest whole number.
- c At what time did the Harrisons resume their journey after their rest stop?
- d How many kilometres did the Harrisons still have to cover after their rest break before arriving in Melbourne?
- e If the Harrisons arrive in Melbourne at 4:30 p.m., for how long did Mr Harrison drive and at what speed?
- f Calculate the cost of the petrol for each family's trip if petrol cost 125 c/L and the Harrison car's consumption is 36 L/100 km, while the Nguyen's car uses 40 L/100 km.



# 7

## Equations and inequalities

### Maths in context: Formulas are algebraic equations

Equations solving skills are essential across many occupations, especially those that uses Excel spreadsheets. This is because formulas, including work-related ones, are in fact algebraic equations that use pronumerals relevant to the variables involved. Equation solving skills are essential when re-arranging formulas or substituting known values and solving the equation for an unknown variable. The following formulas are examples of 'algebra-in-use' at work.

- Welders calculate metal shrinkage  $S = \frac{A}{5T} + 0.05d$ , where  $A$  is weld cross-section area,  $T$  is the plate thickness and  $d$  the opening width.
- Electricians and electrical engineers use  $V = IR$ ;  $P = RI^2$ ;  $V = \sqrt{PR}$ , relating voltage  $V$ , current  $I$ , resistance  $R$  and power  $P$ .
- Vets use  $W = \frac{G^2L}{11880}$  for a horse's weight where  $W$  kg,  $G$  is the heart girth,  $L$  is body length.
- Pilots, aerospace engineers and aircraft maintenance engineers calculate wing lift  $L = \frac{1}{2}Cp v^2A$ , where  $C$  is calculated from wing shape,  $A$  is plane wing area,  $p$  is air density (changes with altitude) and  $v$  is the plane's velocity.
- Mechanical engineers design hydraulic powered lifting equipment that transfers power through pressurised fluid. A car mass,  $M$ , is hoisted by force  $F = Mg \frac{d^2}{D^2}$ , with small and large piston diameters,  $d$  and  $D$ . A 2500 kg car can be hoisted with the same force as lifting 25 kg!





## Chapter contents

- 7A** Reviewing equations (**CONSOLIDATING**)
- 7B** Equivalent equations (**CONSOLIDATING**)
- 7C** Equations with fractions
- 7D** Equations with the pronumeral on both sides
- 7E** Equations with brackets
- 7F** Solving simple quadratic equations (**EXTENDING**)
- 7G** Formulas and relationships
- 7H** Applications of equations
- 7I** Inequalities
- 7J** Solving inequalities

## Victorian Curriculum 2.0

This chapter covers the following content descriptors in the Victorian Curriculum 2.0:

### ALGEBRA

VC2M8A01, VC2M8A02, VC2M8A03

Please refer to the curriculum support documentation in the teacher resources for a full and comprehensive mapping of this chapter to the related curriculum content descriptors.

© VCAA

## Online resources

A host of additional online resources are included as part of your Interactive Textbook, including HOTmaths content, video demonstrations of all worked examples, auto-marked quizzes and much more.

## 7A Reviewing equations CONSOLIDATING

### LEARNING INTENTIONS

- To understand that an equation is a mathematical statement that can be true or false
- To understand that a solution is a value for the unknown that makes an equation true
- To be able to find a solution to simple equations by inspection
- To be able to write equations from worded descriptions

An equation is a statement that two things are equal, such as:

$$\begin{aligned} 2 + 2 &= 4 \\ 7 \times 5 &= 30 + 5 \\ 4 + x &= 10 + y \end{aligned}$$

It consists of two expressions separated by the equals sign ( $=$ ), and it is true if the left-hand side and right-hand side are equal. True equations include  $7 + 10 = 20 - 3$  and  $8 = 4 + 4$ ; examples of false equations are  $2 + 2 = 7$  and  $10 \times 5 = 13$ .

If an equation has a pronumeral in it, such as  $3 + x = 7$ , then a solution to the equation is a value to substitute for the pronumeral to form a true equation. In this case a solution is  $x = 4$  because  $3 + 4 = 7$  is a true equation.



A nurse calculates the number,  $n$ , of pills per day to equal a doctor's prescribed dosage. If the stock strength of heart disease pills is 0.05 mg, and the doctor prescribed 0.15 mg/day, solving:  $0.05n = 0.15$  gives  $n = 3$  pills/day.

### Lesson starter: Solving the equations

- Find a number that would make the equation  $25 = b \times (10 - b)$  true.
- How can you prove that this value is a solution?
- Try to find a solution to the equation  $11 \times b = 11 + b$ .

### KEY IDEAS

- An **equation** is a mathematical statement that two expressions are equal, such as  $4 + x = 32$ . It could be true (e.g.  $4 + 28 = 32$ ) or false (e.g.  $4 + 29 = 32$ ).
- A false equation can be made into a true statement by using the  $\neq$  sign. For instance,  $4 + 29 \neq 32$  is a true statement.

- An equation has a left-hand side (LHS) and a right-hand side (RHS).
- A **solution** to an equation is a value that makes an equation true. The process of finding a solution is called **solving**. In an equation with a variable, the variable is also called an **unknown**.
- An equation could have no solutions or it could have one or more solutions.

### BUILDING UNDERSTANDING

- 1 If the value of  $x$  is 3, what is the value of the following?
 

a $10 + x$	b $3x$
c $5 - x$	d $6 \div x$
- 2 State the value of the missing number to make the following equations true.
 

a $5 + \square = 12$	b $10 \times \square = 90$
c $\square - 3 = 12$	d $3 + 5 = \square$
- 3 Consider the equation  $15 + 2x = x \times x$ .
  - a If  $x = 5$ , find the value of  $15 + 2x$ .
  - b If  $x = 5$ , find the value of  $x \times x$ .
  - c Is  $x = 5$  a solution to the equation  $15 + 2x = x \times x$ ?
  - d Give an example of another equation with  $x = 5$  as a solution.



### Example 1 Classifying equations as true or false

For each of the following equations, state whether they are true or false.

- a  $3 + 8 = 15 - 4$
- b  $7 \times 3 = 20 + 5$
- c  $x + 20 = 3 \times x$ , if  $x = 10$

#### SOLUTION

a True

b False

c True

#### EXPLANATION

Left-hand side (LHS) is  $3 + 8$ , which is 11.  
 Right-hand side (RHS) is  $15 - 4$ , which is also 11.  
 Since LHS equals RHS, the equation is true.

$LHS = 7 \times 3 = 21$   
 $RHS = 20 + 5 = 25$   
 Since LHS and RHS are different, the equation is false.

If  $x = 10$ , then  $LHS = 10 + 20 = 30$ .  
 If  $x = 10$ , then  $RHS = 3 \times 10 = 30$ .  
 LHS equals RHS, so the equation is true.

**Now you try**

For each of the following equations, state whether they are true or false.

**a**  $4 \times 3 = 12 + 2$

**b**  $40 - 5 = 7 \times 5$

**c**  $3x - 12 = 4 + x$ , if  $x = 8$

**Example 2 Stating a solution to an equation**

State a solution to each of the following equations.

**a**  $4 + x = 25$

**b**  $5y = 45$

**c**  $26 = 3z + 5$

**SOLUTION**

**a**  $x = 21$

**b**  $y = 9$

**c**  $z = 7$

**EXPLANATION**

We need to find a value of  $x$  that makes the equation true. Since  $4 + 21 = 25$  is a true equation,  $x = 21$  is a solution.

If  $y = 9$  then  $5y = 5 \times 9 = 45$ , so the equation is true.

$$\begin{aligned} \text{If } z = 7 \text{ then } 3z + 5 &= 3 \times 7 + 5 \\ &= 21 + 5 \\ &= 26 \end{aligned}$$

(Note: The fact that  $z$  is on the right-hand side of the equation does not change the procedure.)

**Now you try**

State a solution to each of the following equations.

**a**  $k + 7 = 39$

**b**  $4q = 48$

**c**  $30 = 4a + 2$

**Example 3 Writing equations from a description**

Write equations for the following scenarios.

**a** The number  $k$  is doubled, then three is added and the result is 52.

**b** Akira works  $n$  hours, earning \$12 per hour. The total she earned was \$156.

**SOLUTION**

**a**  $2k + 3 = 52$

**b**  $12n = 156$

**EXPLANATION**

The number  $k$  is doubled, giving  $k \times 2$ . This is the same as  $2k$ . Since 3 is added, the left-hand side is  $2k + 3$ , which must be equal to 52 according to the description.

If Akira works  $n$  hours at \$12 per hour, the total amount earned is  $12 \times n$ , or  $12n$ . This must equal 156, the total earned.

**Now you try**

Write equations for the following scenarios.

- a** The number  $q$  is tripled, then four is added and the result is 37.  
**b** Joanne works  $n$  hours, earning \$15 per hour. The total she earned was \$345.

**Exercise 7A****FLUENCY**1,  $2-4(\frac{1}{2})$ ,  $6(\frac{1}{2})$  $2-6(\frac{1}{2})$  $2-4(\frac{1}{3})$ ,  $5-6(\frac{1}{2})$ 

- Example 1** 1 For each of the following equations, state whether they are true or false.  
**a**  $2 + 7 = 12 - 5$                       **b**  $9 \times 4 = 72 \div 2$                       **c**  $x + 6 = 2 \times x$  if  $x = 6$

- Example 1a,b** 2 Classify these equations as true or false.  
**a**  $5 \times 3 = 15$                       **b**  $7 + 2 = 12 + 3$                       **c**  $5 + 3 = 16 \div 2$   
**d**  $8 - 6 = 6$                       **e**  $4 \times 3 = 12 \times 1$                       **f**  $2 = 8 - 3 - 3$

- Example 1c** 3 If  $x = 2$ , state whether the following equations are true or false.  
**a**  $7x = 8 + 3x$                       **b**  $10 - x = 4x$                       **c**  $3x = 5 - x$   
**d**  $x + 4 = 5x$                       **e**  $10x = 40 \div x$                       **f**  $12x + 2 = 15x$ .

- Example 1c** 4 If  $a = 3$ , state whether the following equations are true or false.  
**a**  $7 + a = 10$                       **b**  $2a + 4 = 12$                       **c**  $8 - a = 5$   
**d**  $4a - 3 = 9$                       **e**  $7a + 2 = 8a$                       **f**  $a = 6 - a$
- 5 Someone has attempted to solve the following equations. State whether the solution is correct (C) or incorrect (I).  
**a**  $5 + 2x = 4x - 1$ , proposed solution:  $x = 3$                       **b**  $4 + q = 3 + 2q$ , proposed solution:  $q = 10$   
**c**  $13 - 2a = a + 1$ , proposed solution:  $a = 4$                       **d**  $b \times (b + 3) = 4$ , proposed solution,  $b = -4$

- Example 2** 6 State a solution to each of the following equations.  
**a**  $5 + x = 12$                       **b**  $3 = x - 10$                       **c**  $4v + 2 = 14$   
**d**  $17 = p - 2$                       **e**  $10x = 20$                       **f**  $16 - x = x$   
**g**  $4u + 1 = 29$                       **h**  $7k = 77$                       **i**  $3 + a = 2a$

**PROBLEM-SOLVING**7,  $8(\frac{1}{2})$  $7-8(\frac{1}{2})$ , 9, 10

9-11

- Example 3** 7 Write equations for each of the following problems. You do not need to solve the equations.  
**a** A number  $x$  is doubled and then 7 is added. The result is 10.  
**b** The sum of  $x$  and half of  $x$  is 12.  
**c** Aston's age is  $a$ . His father, who is 25 years older, is twice as old as Aston.  
**d** Fel's height is  $h$  cm and her brother Pat is 30 cm taller. Pat's height is 147 cm.  
**e** Coffee costs \$ $c$  per cup and tea costs \$ $t$ . Four cups of coffee and three cups of tea cost a total of \$21.  
**f** Chairs cost \$ $c$  each. To purchase 8 chairs and a \$2000 table costs a total of \$3600.

- 8 Find the value of the unknown number for each of the following.
- a A number is tripled to obtain the result 21.      b Half of a number is 21.  
 c Six less than a number is 7.      d A number is doubled and the result is  $-16$ .  
 e Three-quarters of a number is 30.      f Six more than a number is  $-7$ .
- 9 Berkeley buys  $x$  kg of oranges at \$3.20 per kg. He spends a total of \$9.60.
- a Write an equation involving  $x$  to describe this situation.  
 b State a solution to this equation.



- 10 Emily's age in 10 years' time will be triple her current age. She is currently  $E$  years old.
- a Write an equation involving  $E$  to describe this situation.  
 b Find a solution to this equation.  
 c How old is Emily now?  
 d How many years will she have to wait until she is four times her current age?
- 11 Find two possible values of  $t$  that make the equation  $t(10 - t) = 21$  true.

## REASONING

12

12, 13

12–14

- 12 a Explain why  $x = 3$  is a solution to  $x^2 = 9$ .  
 b Explain why  $x = -3$  is a solution to  $x^2 = 9$ .  
 c Find the two solutions to  $x^2 = 64$ . (*Hint: One is negative.*)  
 d Explain why  $x^2 = 0$  has only one solution, but  $x^2 = 1$  has two.  
 e Explain why  $x^2 = -9$  has no solutions.
- 13 a Explain why the equation  $x + 3 = x$  has no solutions.  
 b Explain why the equation  $x + 2 = 2 + x$  is true, regardless of the value of  $x$ .  
 c Show that the equation  $x + 3 = 10$  is sometimes true and sometimes false.  
 d Classify the following equations as always true (A), sometimes true (S) or never true (N).
- |                       |                        |                                   |
|-----------------------|------------------------|-----------------------------------|
| i $x + 2 = 10$        | ii $5 - q = q$         | iii $5 + y = y$                   |
| iv $10 + b = 10$      | v $2 \times b = b + b$ | vi $3 - c = 10$                   |
| vii $3 + 2z = 2z + 1$ | viii $10p = p$         | ix $2 + b + b = (b + 1) \times 2$ |
- e Give a new example of another equation that is always true.
- 14 a The equation  $p \times (p + 2) = 3$  has two solutions. State the two solutions.  
 (*Hint: One of them is negative.*)  
 b How many solutions are there for the equation  $p + (p + 2) = 3$ ?  
 c Try to find an equation that has three solutions.

## ENRICHMENT: More than one unknown

15, 16

- 15 a There are six equations in the square below. Find the values of  $a$ ,  $b$ ,  $c$ ,  $d$  and  $e$  to make all six equations true.

$a$	+	12	=	22
×		÷		-
2	×	$b$	=	$c$
=		=		=
$d$	÷	$e$	=	10

- b Find the value of  $f$  that makes the equation  $a \times b \times e = c \times d \times f$  true.
- 16 For each of the following pairs of equations, find values of  $c$  and  $d$  that make both equations true. More than one answer may be possible.
- |  |   |
|--|---|
| <p>a <math>c + d = 10</math> and <math>cd = 24</math></p> <p>c <math>c \div d = 4</math> and <math>c + d = 30</math></p> | <p>b <math>c - d = 8</math> and <math>c + d = 14</math></p> <p>d <math>cd = 0</math> and <math>c - d = 7</math></p> |
|--|---|

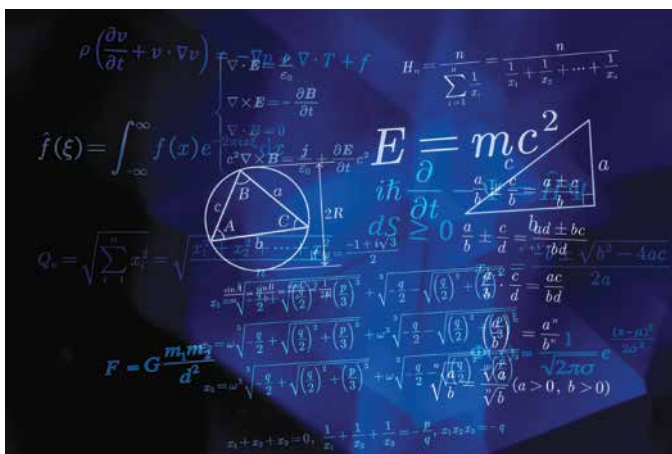

## 7B Equivalent equations CONSOLIDATING

### LEARNING INTENTIONS

- To understand what it means for two equations to be equivalent
- To be able to find equivalent equations by applying the same operation to both sides
- To be able to solve one-step and two-step equations algebraically by finding equivalent equations

If we have an equation, we can obtain an equivalent equation by performing the same operation to both sides. For example, if we have  $2x + 4 = 20$ , we can add 3 to both sides to obtain  $2x + 7 = 23$ .

The new equation will be true for exactly the same values of  $x$  as the old equation. This observation helps us to solve equations algebraically. For example,  $2x + 4 = 20$  is equivalent to  $2x = 16$  (subtract 4 from both sides), and this is equivalent to  $x = 8$  (divide both sides by 2). The bottom equation is only true if  $x$  has the value 8, so this means the solution to the equation  $2x + 4 = 20$  is  $x = 8$ . We write this as:

$$\begin{array}{c}
 2x + 4 = 20 \\
 \swarrow -4 \quad \searrow -4 \\
 2x = 16 \\
 \swarrow \div 2 \quad \searrow \div 2 \\
 x = 8
 \end{array}$$

### Lesson starter: Attempted solutions

Below are three attempts at solving the equation  $4x - 8 = 40$ . Each has a problem.

<p><b>Attempt 1</b></p> $  \begin{array}{c}  4x - 8 = 40 \\  \swarrow +8 \quad \searrow +8 \\  4x = 48 \\  \swarrow -4 \quad \searrow -4 \\  x = 44  \end{array}  $	<p><b>Attempt 2</b></p> $  \begin{array}{c}  4x - 8 = 40 \\  \swarrow +8 \quad \searrow -8 \\  4x = 32 \\  \swarrow +4 \quad \searrow +4 \\  x = 8  \end{array}  $	<p><b>Attempt 3</b></p> $  \begin{array}{c}  4x - 8 = 40 \\  \swarrow \div 4 \quad \searrow \div 4 \\  x - 8 = 10 \\  \swarrow +8 \quad \searrow +8 \\  x = 18  \end{array}  $
---	--	--

- Can you prove that these results are not the correct solutions to the equation above?
- For each one, find the mistake that was made.
- Can you solve  $4x - 8 = 40$  algebraically?

### KEY IDEAS

- Two equations are equivalent if substituting pronumerals always makes both equations true or both equations false. For example  $3x + 5 = 17$  and  $3x = 12$  are always either both true (if  $x$  is 4) or false (if  $x$  is not equal to 4).
- To show that two equations are equivalent you can repeatedly:
  - adding a number to both sides
  - subtracting a number from both sides
  - multiplying both sides by a number other than zero
  - dividing both sides by a number other than zero
  - swapping the left-hand and right-hand sides of the equation.



- To solve an equation **algebraically**, repeatedly find an equivalent equation that is simpler.  
For example:

$$\begin{array}{c}
 5x + 2 = 32 \\
 \swarrow -2 \quad \searrow -2 \\
 5x = 30 \\
 \swarrow +5 \quad \searrow +5 \\
 x = 6
 \end{array}$$

- To check a solution, substitute the unknown's value in to both sides to see if the equation is true.  
For example: LHS =  $5(6) + 2 = 32$  and RHS = 32.

### BUILDING UNDERSTANDING

- 1 For each of the following equations add 4 to both sides to obtain an equivalent equation.

a  $3x = 10$

b  $7 + k = 14$

c  $5 = 2x$

- 2 Copy and complete the following pairs of equivalent equations.

a

$$\begin{array}{c}
 5x = 10 \\
 \swarrow +2 \quad \searrow +2 \\
 5x + 2 = \_\_\_
 \end{array}$$

b

$$\begin{array}{c}
 10 - 2x = 20 \\
 \swarrow +5 \quad \searrow +5 \\
 15 - 2x = \_\_\_
 \end{array}$$

c

$$\begin{array}{c}
 3q + 4 = \_\_\_ \\
 \swarrow -4 \quad \searrow -4 \\
 3q = 12
 \end{array}$$

d

$$\begin{array}{c}
 7z + 12 = 4z + 10 \\
 \swarrow -10 \quad \searrow -10 \\
 7z + 2 = \_\_\_
 \end{array}$$

- 3 Consider the equation  $4x = 32$ .

- a State the missing number to complete the following working.

$$\begin{array}{c}
 4x = 32 \\
 \swarrow +4 \quad \searrow +4 \\
 x = \_\_\_
 \end{array}$$

- b What is the solution to the equation  $4x = 32$ ?

- 4 To solve the equation  $10x + 5 = 45$ , which of the following operations would you first apply to both sides?

A Divide by 5

B Subtract 5

C Divide by 10

D Subtract 45



### Example 4 Finding equivalent equations

Show the result of applying the given operation to both sides of these equations.

a  $8y = 40$  [ $\div 8$ ]

b  $10 + 2x = 36$  [ $-10$ ]

c  $5a - 3 = 12$  [ $+3$ ]

*Continued on next page*

**SOLUTION**

**a**

$$\begin{array}{c} 8y = 40 \\ \begin{array}{c} \curvearrowright +8 \\ \curvearrowleft +8 \end{array} \\ y = 5 \end{array}$$

**b**

$$\begin{array}{c} 10 + 2x = 36 \\ \begin{array}{c} \curvearrowleft -10 \\ \curvearrowright -10 \end{array} \\ 2x = 26 \end{array}$$

**c**

$$\begin{array}{c} 5a - 3 = 12 \\ \begin{array}{c} \curvearrowleft +3 \\ \curvearrowright +3 \end{array} \\ 5a = 15 \end{array}$$

**EXPLANATION**

Write the equation out and then divide both sides by 8.

$$40 \div 8 \text{ is } 5$$

$$8y \div 8 \text{ is } y$$

Write the equation out and then subtract 10 from both sides.

$$36 - 10 \text{ is } 26$$

$$10 + 2x - 10 \text{ is } 2x$$

Write the equation out and then add 3 to both sides.

$$12 + 3 \text{ is } 15$$

$$5a - 3 + 3 \text{ is } 5a$$

**Now you try**

Show the result of applying the given operation to both sides of these equations.

**a**  $3p = 24$  [ $\div 3$ ]

**b**  $14 + 3p = 25$  [ $-14$ ]

**c**  $8m - 2 = 50$  [ $+2$ ]

**Example 5 Solving equations algebraically**

Solve the following equations algebraically and check the solution by substituting.

**a**  $x - 4 = 16$

**b**  $2u + 7 = 17$

**c**  $40 - 3x = 22$

**SOLUTION**

**a**

$$\begin{array}{c} x - 4 = 16 \\ \begin{array}{c} \curvearrowleft +4 \\ \curvearrowright +4 \end{array} \\ x = 20 \end{array}$$

So the solution is  $x = 20$ .

Check:  $20 - 4 = 16$  ✓

**b**

$$\begin{array}{c} 2u + 7 = 17 \\ \begin{array}{c} \curvearrowleft -7 \\ \curvearrowright -7 \end{array} \\ 2u = 10 \\ \begin{array}{c} \curvearrowleft +2 \\ \curvearrowright +2 \end{array} \\ u = 5 \end{array}$$

So the solution is  $u = 5$ .

Check:  $2(5) + 7 = 10 + 7 = 17$  ✓

**EXPLANATION**

By adding 4 to both sides of the equation, we get an equivalent equation.

Check by substituting  $x = 20$  into the original equation.

To get rid of the  $+7$ , we subtract 7 from both sides. Finally, we divide by 2 to reverse the  $2u$ . Remember that  $2u$  means  $2 \times u$ .

Check by substituting  $u = 5$  into the original equation.



Example 5a

4 Solve the following equations algebraically.

a  $a + 5 = 8$

b  $t \times 2 = 14$

c  $7 = q - 2$

d  $11 = k + 2$

e  $19 = x + 9$

f  $-30 = 3h$

g  $-36 = 9l$

h  $g \div 3 = -3$

i  $-2y = -4$

Example 5b

5 Solve the following equations algebraically. Check your solutions using substitution.

a  $5 + 9h = 32$

b  $9u - 6 = 30$

c  $13 = 5s - 2$

d  $-18 = 6 - 3w$

e  $-12 = 5x + 8$

f  $-44 = 10w + 6$

g  $8 = -8 + 8a$

h  $4y - 8 = -40$

i  $-11 = 2x + 1$

Example 5c

6 Solve the following equations algebraically and check your solutions.

a  $20 - 4d = 8$

b  $34 = 4 - 5j$

c  $21 - 7a = 7$

d  $6 = 12 - 3y$

e  $13 - 8k = 45$

f  $44 = 23 - 3n$

g  $13 = -3b + 4$

h  $-22 = 14 - 9b$

i  $6a - 4 = -16$

7 The following equations do not all have whole number solutions. Solve the following equations algebraically, giving each solution as a fraction.

a  $2x + 3 = 10$

b  $5 + 3q = 6$

c  $12 = 10b + 7$

d  $15 = 10 + 2x$

e  $15 = 10 - 2x$

f  $13 + 2p = -10$

g  $22 = 9 + 5y$

h  $12 - 2y = 15$

i  $1 - 3y = -1$

## PROBLEM-SOLVING

8

8, 9, 10(½)

9–11

8 For each of the following, write an equation and solve it algebraically.

a The sum of  $p$  and 8 is 15.b The product of  $q$  and  $-3$  is 12.c 4 is subtracted from double the value of  $k$  and the result is 18.d When  $r$  is tripled and 4 is added the result is 34.e When  $x$  is subtracted from 10 the result is 6.f When triple  $y$  is subtracted from 10 the result is 16.

9 Solve the following equations algebraically. More than two steps are involved.

a  $14 \times (4x + 2) = 140$

b  $8 = (10x - 4) \div 2$

c  $-12 = (3 - x) \times 4$

10 The following shapes are rectangles. By solving equations algebraically, find the value of the variables. Some of the answers will be fractions.

a

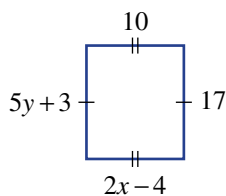

b

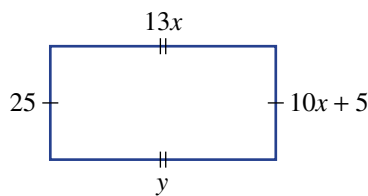

c

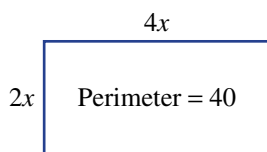

d

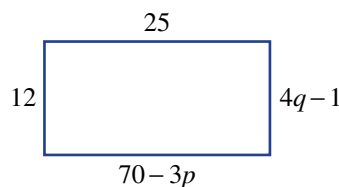

- 11 Sidney works for 10 hours at the normal rate of pay (\$ $x$  per hour) and then the next three hours at double that rate. If he earns a total of \$194.88, write an equation and solve it to find his normal hourly rate.



## REASONING

12

12, 13

13, 14

- 12 a Prove that  $7x + 4 = 39$  and  $-2x + 13 = 3$  are equivalent by filling in the missing steps.

$$\begin{array}{l}
 7x + 4 = 39 \\
 \begin{array}{l} \left. \begin{array}{l} -4 \\ \hline \end{array} \right\} \\ \left. \begin{array}{l} +7 \\ \hline \end{array} \right\} \\ \left. \begin{array}{l} \times -2 \\ \hline \end{array} \right\} \\ \left. \begin{array}{l} +13 \\ \hline \end{array} \right\}
 \end{array}
 \begin{array}{l}
 7x = 35 \\
 \underline{\quad} = \underline{\quad} \\
 \underline{\quad} = \underline{\quad} \\
 -2x + 13 = 3
 \end{array}
 \begin{array}{l}
 \left. \begin{array}{l} -4 \\ \hline \end{array} \right\} \\
 \left. \begin{array}{l} +7 \\ \hline \end{array} \right\} \\
 \left. \begin{array}{l} \times -2 \\ \hline \end{array} \right\} \\
 \left. \begin{array}{l} +13 \\ \hline \end{array} \right\}
 \end{array}
 \end{array}$$

- b Prove that  $10k + 4 = 24$  and  $3k - 1 = 5$  are equivalent.
- 13 a Prove that  $4x + 3 = 11$  and  $2x = 4$  are equivalent. Try to use just two steps to get from one equation to the other.
- b Are the equations  $5x + 2 = 17$  and  $x = 5$  equivalent?
- c Prove that  $10 - 2x = 13$  and  $14x + 7 = 20$  are not equivalent, no matter how many steps are used.
- 14 A student has taken the equation  $x = 5$  and performed some operations to both sides.

$$\begin{array}{l}
 x = 5 \\
 \begin{array}{l} \left. \begin{array}{l} \times 4 \\ \hline \end{array} \right\} \\ \left. \begin{array}{l} +3 \\ \hline \end{array} \right\} \\ \left. \begin{array}{l} \times 2 \\ \hline \end{array} \right\}
 \end{array}
 \begin{array}{l}
 4x = 20 \\
 4x + 3 = 23 \\
 (4x + 3) \times 2 = 46
 \end{array}
 \begin{array}{l}
 \left. \begin{array}{l} \times 4 \\ \hline \end{array} \right\} \\
 \left. \begin{array}{l} +3 \\ \hline \end{array} \right\} \\
 \left. \begin{array}{l} \times 2 \\ \hline \end{array} \right\}
 \end{array}
 \end{array}$$

- a Solve  $(4x + 3) \times 2 = 46$  algebraically.
- b Describe how the steps you used in your solution compare with the steps the student used.
- c Give an example of another equation that has  $x = 5$  as its solution.
- d Explain why there are infinitely many different equations with the solution  $x = 5$ .

## ENRICHMENT: Dividing whole expressions

-

-

 $15\left(\frac{1}{2}\right)$ 

- 15 It is possible to solve  $2x + 4 = 20$  by first dividing both sides by 2, as long as every term is divided by 2. So you could solve it in either of these fashions.

$$\begin{array}{c} 2x + 4 = 20 \\ \swarrow -4 \quad \searrow -4 \\ 2x = 16 \\ \swarrow +2 \quad \searrow +2 \\ x = 8 \end{array}$$

$$\begin{array}{c} 2x + 4 = 20 \\ \swarrow +2 \quad \searrow +2 \\ x + 2 = 10 \\ \swarrow -2 \quad \searrow -2 \\ x = 8 \end{array}$$

Note that  $2x + 4$  divided by 2 is  $x + 2$ , not  $x + 4$ . Use this method of dividing first to solve the following equations and then check that you get the same answer as if you subtracted first.

a  $2x + 6 = 12$

b  $4x + 12 = 16$

c  $10x + 30 = 50$

d  $2x + 5 = 13$

e  $5x + 4 = 19$

f  $3 + 2x = 5$

g  $7 = 2x + 4$

h  $10 = 4x + 10$

i  $12 = 8 + 4x$



When making a business plan, Alex, a physiotherapist, can solve an equation to find the number of patients,  $n$ , to give a profit of \$1700 per week, for example. If expenses (e.g. insurance, rent, wages) are \$2300 per week, and the average patient fee is \$100, then:

$$100n - 2300 = 1700$$

$$100n = 4000$$

$$n = 40.$$

Therefore, 40 patients per week need to be seen.

## 7C Equations with fractions

### LEARNING INTENTIONS

- To understand that fractions are used in algebra to indicate division
- To be able to solve equations involving algebraic fractions

Recall from algebra that a fraction such as  $\frac{x}{3}$  represents  $x \div 3$ . This means that to solve an equation with  $\frac{x}{3}$  on one side, we should first multiply both sides by 3. For example:

$$\begin{array}{c} \frac{x}{3} = 10 \\ \times 3 \quad \swarrow \quad \searrow \quad \times 3 \\ x = 30 \end{array}$$



Accountants and store managers solve equations with fractions to determine prices and profits. If a dress price of \$99 includes 80% profit on the wholesale price \$ $x$ , then  $\frac{180x}{100} = 99$  and  $x = \$55$ .

### Lesson starter: Practising with fractions

- If  $x$  is a number greater than 1, evaluate these expressions and put them into ascending order (smallest to largest).

$$\frac{2x+1}{2} \quad 2\left(\frac{x}{2}+1\right) \quad \frac{2}{x+1} \quad \frac{2+2x}{2} \quad 2\left(x+\frac{1}{2}\right)$$

- Investigate how the order might change if  $x$  could be a number less than 1.

### KEY IDEAS

■  $\frac{a}{b}$  means  $a \div b$ .

■ To solve an equation with a fraction on one side, multiply both sides by the denominator.  
For example:

$$\begin{array}{c} \frac{q}{4} = 12 \\ \times 4 \quad \swarrow \quad \searrow \quad \times 4 \\ q = 48 \end{array}$$

■ Do not multiply by the denominator if there are extra terms that are not part of the fraction  
For example:

$$\frac{q}{4} + 2 = 12$$

extra term

Subtract 2 from both sides before multiplying.

## BUILDING UNDERSTANDING

- 1 a If  $x = 4$  find the value of  $\frac{x}{2} + 6$ .  
 b If  $x = 4$  find the value of  $\frac{x+6}{2}$ .  
 c Are  $\frac{x}{2} + 6$  and  $\frac{x+6}{2}$  equivalent expressions?

2 Fill in the missing steps to solve these equations.

a  $\begin{array}{c} \frac{x}{3} = 10 \\ \times 3 \quad \times 3 \\ \hline x = \_ \end{array}$

b  $\begin{array}{c} \frac{m}{5} = 2 \\ \times 5 \quad \times 5 \\ \hline m = \_ \end{array}$

c  $\begin{array}{c} 11 = \frac{q}{2} \\ \square \quad \square \\ \hline \_ = q \end{array}$

d  $\begin{array}{c} \frac{p}{10} = 7 \\ \square \quad \square \\ \hline p = \_ \end{array}$

3 Match each of these equations with the correct first step to solve it.

A  $\frac{x}{4} = 7$

B  $\frac{x-4}{2} = 5$

C  $\frac{x}{2} - 4 = 7$

D  $\frac{x}{4} + 4 = 3$

a Multiply both sides by 2.

b Add 4 to both sides.

c Multiply both sides by 4.

d Subtract 4 from both sides.



## Example 6 Solving equations with fractions

Solve the following equations algebraically.

a  $\frac{4x}{3} = 8$

b  $\frac{4y+15}{9} = 3$

c  $4 + \frac{5x}{2} = 29$

d  $7 - \frac{2x}{3} = 5$

## SOLUTION

a  $\begin{array}{c} \frac{4x}{3} = 8 \\ \times 3 \quad \times 3 \\ \hline 4x = 24 \\ +4 \quad +4 \\ \hline x = 6 \end{array}$

b  $\begin{array}{c} \frac{4y+15}{9} = 3 \\ \times 9 \quad \times 9 \\ \hline 4y+15 = 27 \\ -15 \quad -15 \\ \hline 4y = 12 \\ +4 \quad +4 \\ \hline y = 3 \end{array}$

## EXPLANATION

Multiplying both sides by 3 removes the denominator of 3.

Both sides are divided by 4 to solve the equation.

Multiplying both sides by 9 removes the denominator of 9.

The equation  $4y + 15 = 27$  is solved in the usual fashion (subtract 15, divide by 4).



**SOLUTION****c**

$$\begin{array}{c}
 4 + \frac{5x}{2} = 29 \\
 \swarrow -4 \quad \searrow -4 \\
 \frac{5x}{2} = 25 \\
 \swarrow \times 2 \quad \searrow \times 2 \\
 5x = 50 \\
 \swarrow +5 \quad \searrow +5 \\
 x = 10
 \end{array}$$

**d**

$$\begin{array}{c}
 7 - \frac{2x}{3} = 5 \\
 \swarrow -7 \quad \searrow -7 \\
 -\frac{2x}{3} = -2 \\
 \swarrow \times (-1) \quad \searrow \times (-1) \\
 \frac{2x}{3} = 2 \\
 \swarrow \times 3 \quad \searrow \times 3 \\
 2x = 6 \\
 \swarrow +2 \quad \searrow +2 \\
 x = 3
 \end{array}$$

**EXPLANATION**

We must subtract 4 first because we do not have a fraction by itself on the left-hand side. Once there is a fraction by itself, multiply by the denominator (2).

Subtract 7 first to get a fraction. When both sides are negative, multiplying (or dividing) by  $-1$  makes them both positive.

**Now you try**

Solve the following equations algebraically.

**a**  $\frac{5k}{2} = 20$

**b**  $\frac{3y+6}{2} = 9$

**c**  $2 + \frac{5x}{3} = 12$

**d**  $10 - \frac{2x}{3} = 4$

**Exercise 7C****FLUENCY**1,  $2(\frac{1}{2})$ ,  $4-5(\frac{1}{2})$  $2-6(\frac{1}{2})$  $3(\frac{1}{2})$ ,  $5-6(\frac{1}{2})$ 

Example 6a

**1** Solve the following equations algebraically.

**a**  $\frac{b}{5} = 4$

**b**  $\frac{8}{10} = 3$

**c**  $\frac{a}{5} = 3$

**d**  $\frac{k}{6} = 3$

Example 6a

**2** Solve the following equations algebraically.

**a**  $\frac{2l}{5} = 8$

**b**  $\frac{5v}{4} = 15$

**c**  $\frac{3m}{7} = 6$

**d**  $\frac{2n}{7} = 10$

Example 6a

**3** Solve the following equations algebraically.

**a**  $\frac{7w}{10} = -7$

**b**  $\frac{3s}{2} = -9$

**c**  $\frac{-7j}{5} = 7$

**d**  $\frac{-6f}{5} = -24$

Example 6b,c

4 Solve the following equations algebraically.

a  $\frac{a+2}{5} = 2$

b  $\frac{b}{5} + 2 = 6$

c  $\frac{c}{4} - 2 = 1$

d  $\frac{d-4}{3} = 6$

Example 6b,c

5 Solve the following equations algebraically

a  $\frac{4u+1}{7} = 3$

b  $\frac{8x}{3} - 4 = 4$

c  $\frac{3k}{2} + 1 = 7$

d  $\frac{7+c}{5} = 2$

e  $8 + \frac{2x}{3} = 14$

f  $\frac{6+3a}{7} = 3$

g  $4 + \frac{c}{2} = 10$

h  $\frac{3+4g}{9} = 3$

Example 6

6 Solve the following equations algebraically. Check your solutions by substituting.

a  $\frac{t-8}{2} = -10$

b  $\frac{h+10}{3} = 4$

c  $\frac{a+12}{5} = 2$

d  $\frac{c-7}{2} = -5$

e  $1 = \frac{2-s}{8}$

f  $\frac{5j+6}{8} = 2$

g  $3 = \frac{7v}{12} + 10$

h  $6 - \frac{4n}{9} = 2$

i  $\frac{7q+12}{5} = -6$

j  $-4 = \frac{f-15}{3}$

k  $15 = \frac{3-12l}{5}$

l  $9 - \frac{4r}{7} = 5$

m  $-6 = \frac{8-5x}{7}$

n  $\frac{5u-7}{-4} = -2$

o  $\frac{5k+4}{-8} = -3$

p  $20 = \frac{3+13b}{-7}$

## PROBLEM-SOLVING

7

7-8( $\frac{1}{2}$ )7-8( $\frac{1}{2}$ ), 9

7 For the following puzzles, write an equation and solve it to find the unknown number.

a A number  $x$  is divided by 5 and the result is 7.b Half of  $y$  is  $-12$ .c A number  $p$  is doubled and then divided by 7. The result is 4.d Four is added to  $x$ . This is halved to get a result of 10.e  $x$  is halved and then 4 is added to get a result of 10.f A number  $k$  is doubled and then 6 is added. This result is halved to obtain  $-10$ .

8 The average of two numbers can be found by adding them and then dividing the result by 2.

a If the average of  $x$  and 5 is 12, what is  $x$ ? Solve the equation  $\frac{x+5}{2} = 12$  to find out.b The average of 7 and  $p$  is  $-3$ . Find  $p$  by writing and solving an equation.

c The average of a number and double that number is 18. What is that number?

d The average of  $4x$  and 6 is 19. What is the average of  $6x$  and 4? (*Hint*: Find  $x$  first.)

9 A restaurant bill of \$100 is to be paid. Blake puts in one-third of the amount in his wallet, leaving \$60 to be paid by the other people at the table.

a Write an equation to describe this situation, if  $b$  represents the amount in Blake's wallet before he pays.

b Solve the equation algebraically, and hence state how much money Blake has in his wallet.

## REASONING

10

10, 11

11, 12( $\frac{1}{2}$ )10 The equation  $\frac{a+2}{3} = 4$  is different from  $\frac{a}{3} + 2 = 4$ .

Find the solution to each equation and explain why they have different solutions.

- 11 In solving  $\frac{2x}{3} = 10$ , we have first been multiplying by the denominator, but we could have written  $2\left(\frac{x}{3}\right) = 10$  and divided both sides by 2.
- Solve  $2\left(\frac{x}{3}\right) = 10$ .
  - Is the solution the same as the solution for  $\frac{2x}{3} = 10$  if both sides are first multiplied by 3?
  - Solve  $\frac{147q}{13} = 1470$  by first:
    - multiplying both sides by 13
    - dividing both sides by 147.
  - What is one advantage in dividing first rather than multiplying?
  - Solve the following equations. using the technique of first dividing both sides by the same value.
    - $\frac{20p}{14} = 40$
    - $\frac{13q}{27} = -39$
    - $\frac{-4p}{77} = 4$
    - $\frac{123r}{17} = 246$

- 12 To solve an equation with a pronumeral in the denominator, we can first multiply both sides by that pronumeral.

$$\begin{array}{c}
 \frac{30}{x} = 10 \\
 \times x \quad \quad \quad \times x \\
 \left. \begin{array}{l} \nearrow \\ \searrow \end{array} \right\} \\
 30 = 10x \\
 \div 10 \quad \quad \quad \div 10 \\
 \left. \begin{array}{l} \nearrow \\ \searrow \end{array} \right\} \\
 3 = x
 \end{array}$$

Use this method to solve the following equations.

- $\frac{12}{x} = 2$
- $\frac{-15}{x} = -5$
- $\frac{1}{x} + 3 = 4$
- $4 + \frac{20}{x} = 14$
- $\frac{16}{x} + 1 = 3$
- $5 = \frac{-10}{x} + 3$

**ENRICHMENT: Fractional solutions**

-

-

13-14( $\frac{1}{2}$ )

- 13 Solve the following equations. Note that the solutions should be given as fractions.
- $\frac{4x+3}{5} = 12$
  - $\frac{8+3x}{5} = 6$
  - $7 = \frac{x}{4} + \frac{1}{3}$
  - $2 = \frac{10-3x}{4}$
- 14 Recall from **Section 5E** (Adding and subtracting algebraic fractions) that algebraic fractions can be combined by finding a common denominator, for example:
- $$\begin{aligned}
 \frac{2x}{3} + \frac{5x}{4} &= \frac{8x}{12} + \frac{15x}{12} \\
 &= \frac{23x}{12}
 \end{aligned}$$
- Use this simplification to solve the following equations.
- $\frac{2x}{3} + \frac{5x}{4} = 46$
  - $\frac{x}{5} + \frac{x}{6} = 22$
  - $10 = \frac{x}{2} + \frac{x}{3}$
  - $4 = \frac{x}{2} - \frac{x}{3}$
  - $\frac{6x}{5} + \frac{2x}{3} = 28$
  - $4 = \frac{3x}{7} - \frac{x}{3}$

## 7D Equations with the pronumeral on both sides

### LEARNING INTENTIONS

- To understand that the same term can be subtracted from or added to both sides of an equation to produce an equivalent equation
- To be able to solve equations involving pronumerals on both sides

So far all the equations we have considered involved a pronumeral either on the left-hand side, for example  $2x + 3 = 11$ , or on the right side, for example  $15 = 10 - 2x$ . But how can you solve an equation with pronumerals on both sides, for example  $12 + 5x = 16 + 3x$ ? The idea is to look for an equivalent equation with pronumerals on just one side.

The equation  $12 + 5x = 16 + 3x$  can be thought of as balancing scales.

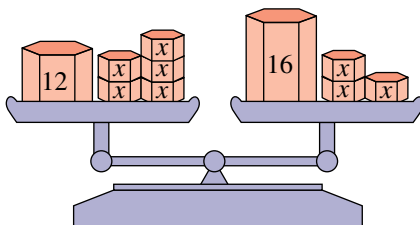

Then  $3x$  can be removed from both sides of this equation to get

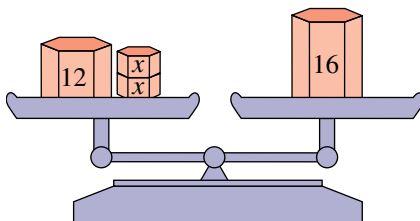

The equation  $12 + 2x = 16$  is straightforward to solve.

### Lesson starter: Moving pronumerals

You are given the equation  $11 + 5x = 7 + 3x$ .

- Can you find an equivalent equation with  $x$  just on the left-hand side?
- Can you find an equivalent equation with  $x$  just on the right-hand side?
- Try to find an equivalent equation with  $9x$  on the left-hand side.
- Do all of these equations have the same solution? Try to find it.

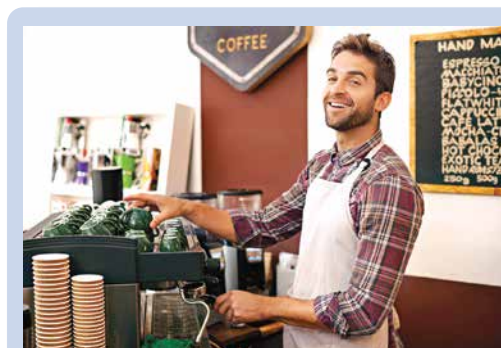

Financial analysts for restaurants solve equations to find the 'break-even' point, where revenue = expenditure (e.g. for wages, rent, equipment and ingredients). A coffee shop accountant could solve:  $1680 + 0.3c = 4.5c$ , giving  $c = 400$  coffees/week to sell to break even.

## KEY IDEAS

- If both sides of an equation have the same term added or subtracted, the new equation will be equivalent to the original equation.
- If pronumerals are on both sides of an equation, add or subtract terms so that the pronumeral appears only one side.

For example:

$$\begin{array}{l} 10 + 5a = 13 + 2a \\ \text{\textit{-2a}} \left( \begin{array}{l} \curvearrowright \\ \curvearrowright \end{array} \right) \text{\textit{-2a}} \\ \hline 10 + 3a = 13 \end{array} \quad \begin{array}{l} 4b + 12 = 89 - 3b \\ \text{\textit{+3b}} \left( \begin{array}{l} \curvearrowright \\ \curvearrowright \end{array} \right) \text{\textit{+3b}} \\ \hline 7b + 12 = 89 \end{array}$$

## BUILDING UNDERSTANDING

- 1 If  $x = 3$ , are the following equations true or false?

a  $5 + 2x = 4x - 1$

b  $2 + 8x = 12x$

c  $9x - 7 = 3x + 11$

- 2 State the missing components for these equivalent equations.

a 
$$\begin{array}{l} 5x + 3 = 2x + 8 \\ \text{\textit{-2x}} \left( \begin{array}{l} \curvearrowright \\ \curvearrowright \end{array} \right) \text{\textit{-2x}} \\ \hline \underline{\quad} = 8 \end{array}$$

b 
$$\begin{array}{l} 9q + 5 = 12q + 21 \\ \text{\textit{-9q}} \left( \begin{array}{l} \curvearrowright \\ \curvearrowright \end{array} \right) \text{\textit{-9q}} \\ \hline \underline{\quad} = 3q + 21 \end{array}$$

c 
$$\begin{array}{l} 3p + 9 = 5 - 2p \\ \text{\textit{+2p}} \left( \begin{array}{l} \curvearrowright \\ \curvearrowright \end{array} \right) \text{\textit{+2p}} \\ \hline \underline{\quad} = \underline{\quad} \end{array}$$

d 
$$\begin{array}{l} 15k + 12 = 13 - 7k \\ \text{\textit{+7k}} \left( \begin{array}{l} \curvearrowright \\ \curvearrowright \end{array} \right) \text{\textit{+7k}} \\ \hline \underline{\quad} = \underline{\quad} \end{array}$$

- 3 To solve the equation  $12x + 2 = 8x + 16$ , which one of the following first steps will ensure that  $x$  is only on one side of the equation?

A Subtract 2

B Subtract  $8x$

C Add  $12x$

D Subtract 16

E Add  $20x$



Equations are used to calculate the power produced from an electric motor.

### Example 7 Solving equations with pronumerals on both sides

Solve the following equations and check your solutions using substitution.

- a  $7t + 4 = 5t + 10$   
 b  $6x + 4 = 22 - 3x$   
 c  $2u = 7u - 20$

#### SOLUTION

a

$$\begin{array}{l} 7t + 4 = 5t + 10 \\ -5t \quad \quad \quad -5t \\ \hline 2t + 4 = 10 \\ -4 \quad \quad \quad -4 \\ \hline 2t = 6 \\ +2 \quad \quad \quad +2 \\ \hline t = 3 \end{array}$$

b

$$\begin{array}{l} 6x + 4 = 22 - 3x \\ +3x \quad \quad \quad +3x \\ \hline 9x + 4 = 22 \\ -4 \quad \quad \quad -4 \\ \hline 9x = 18 \\ +9 \quad \quad \quad +9 \\ \hline x = 2 \end{array}$$

c

$$\begin{array}{l} 2u = 7u - 20 \\ -2u \quad \quad \quad -2u \\ \hline 0 = 5u - 20 \\ +20 \quad \quad \quad +20 \\ \hline 20 = 5u \\ +5 \quad \quad \quad +5 \\ \hline 4 = u \\ \therefore u = 4 \end{array}$$

#### EXPLANATION

Pronumerals are on both sides of the equation, so subtract  $5t$  from both sides.

Once  $5t$  is subtracted, the usual procedure is applied for solving equations.

$$\begin{array}{l} \text{LHS} = 7(3) + 4 \\ = 25 \end{array} \quad \begin{array}{l} \text{RHS} = 5(3) + 10 \\ = 25 \quad \checkmark \end{array}$$

Pronumerals are on both sides. To get rid of  $3x$ , we add  $3x$  to both sides of the equation.

Alternatively,  $6x$  could have been subtracted from both sides of the equation to get  $4 = 22 - 9x$ .

$$\begin{array}{l} \text{LHS} = 6(2) + 4 \\ = 16 \end{array} \quad \begin{array}{l} \text{RHS} = 22 - 3(2) \\ = 16 \quad \checkmark \end{array}$$

Choose to get rid of  $2u$  by subtracting it.

Note that  $2u - 2u$  is equal to 0, so the LHS of the new equation is 0.

$$\begin{array}{l} \text{LHS} = 2(4) \\ = 8 \end{array} \quad \begin{array}{l} \text{RHS} = 7(4) - 20 \\ = 8 \quad \checkmark \end{array}$$

#### Now you try

Solve the following equations and check your solutions using substitution.

- a  $7m + 2 = 4m + 14$   
 b  $5x + 2 = 23 - 2x$   
 c  $4p = 9p - 30$

## Exercise 7D

### FLUENCY

1, 2-3(1/2)

2-4(1/2)

2-5(1/3)

Example 7a

1 Solve the following equations and check your solutions using substitution.

a  $5x = 3x + 8$

b  $6f = 2f + 12$

c  $4n = n + 15$

Example 7a

2 Solve the following equations. Check your solution using substitution.

a  $7s + 7 = 3s + 19$

b  $9j + 4 = 4j + 14$

c  $2t + 8 = 8t + 20$

d  $4 + 3n = 10n + 39$

e  $4 + 8y = 10y + 14$

f  $5 + 3t = 6t + 17$

Example 7b

3 Solve the following equations.

a  $6t - 3 = 7t - 8$

b  $7z - 1 = 8z - 4$

c  $8t - 24 = 2t - 6$

d  $2q - 5 = 3q - 3$

e  $5x + 8 = 6x - 1$

f  $8w - 15 = 6w + 3$

Example 7c

4 Solve the following equations.

a  $12 - 8n = 8 - 10n$

b  $2 + 8u = 37 + 3u$

c  $21 - 3h = 6 - 6h$

d  $37 - 4j = 7 - 10j$

e  $13 - 7c = 8c - 2$

f  $10 + 4n = 4 - 2n$

g  $10a + 32 = 2a$

h  $10v + 14 = 8v$

i  $18 + 8c = 2c$

j  $2t + 7 = 22 - 3t$

k  $6n - 47 = 9 - 8n$

l  $3n = 15 + 8n$

5 Solve the following equation, giving your solutions as improper fractions where necessary.

a  $3x + 5 = x + 6$

b  $5k - 2 = 2k$

c  $3 + m = 6 + 3m$

d  $9j + 4 = 5j + 14$

e  $3 - j = 4 + j$

f  $2z + 3 = 4z - 8$

### PROBLEM-SOLVING

6

6, 7

7-9

6 Write an equation and solve it algebraically to find the unknown number in these problems.

a Doubling  $x$  and adding 3 is the same as tripling  $x$  and adding 1.b If  $z$  is increased by 9, this is the same as doubling the value of  $z$ .c The product of 7 and  $y$  is the same as the sum of  $y$  and 12.

d When a number is increased by 10, this has the same effect as tripling the number and subtracting 6.

7 Find the value of  $x$  and  $y$  in the following rectangles.

a

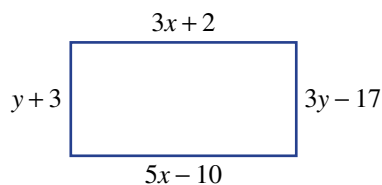

b

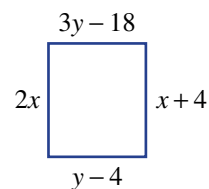

8 Find the area and the perimeter of this rectangle.

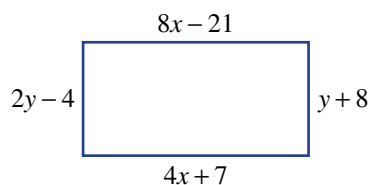

9 At a newsagency, Preeta bought 4 pens and a \$1.50 newspaper, while her husband Levy bought 2 pens and a \$4.90 magazine. To their surprise the cost was the same.



- a Write an equation to describe this, using  $p$  for the cost of a single pen in dollars.
- b Solve the equation to find the cost of pens.
- c If Fred has a \$20 note, what is the maximum number of pens that he can purchase?

**REASONING** 10      10, 11      11, 12

- 10 To solve the equation  $12 + 3x = 5x + 2$  you can first subtract  $3x$  or subtract  $5x$ .
- a Solve the equation above by first subtracting  $3x$ .
  - b Solve the equation above by first subtracting  $5x$ .
  - c What is the difference between the two methods?

11 Prove that the rectangular shape shown to the right must be a square, even though it does not look like one in the diagram. (*Hint:* First find the values of  $x$  and  $y$ .)

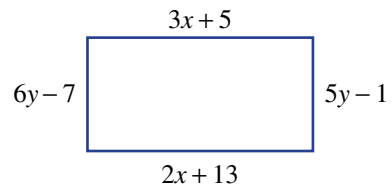

- 12 a Try to solve the equation  $4x + 3 = 10 + 4x$ .
- b This tells you that the equation you are trying to solve has no solutions (because  $10 = 3$  is never true). Prove that  $2x + 3 = 7 + 2x$  has no solutions.
  - c Give an example of another equation that has no solutions.

**ENRICHMENT: Geometric equations** -      -       $13\frac{1}{2}$

13 Find the values of the unknown variables in the following geometric diagrams.

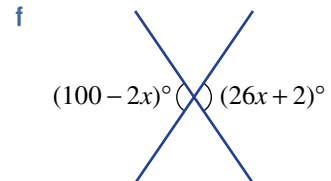
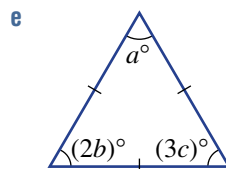
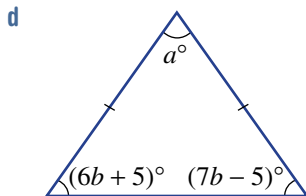
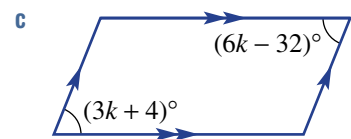
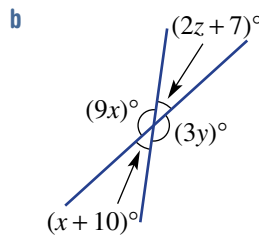
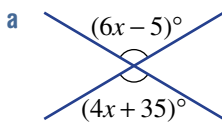



## 7E Equations with brackets

### LEARNING INTENTIONS

- To understand that the distributive law can be used to expand brackets within equations
- To be able to solve equations by expanding brackets

In Chapter 5 it was noted that expressions with brackets could be expanded by considering rectangle areas.

The diagram shows that  $4(x + 2)$  and  $4x + 8$  are equivalent. This becomes quite helpful when solving an equation like  $4(x + 2) = 5x + 1$ . We just solve  $4x + 8 = 5x + 1$  using the techniques from the previous section.

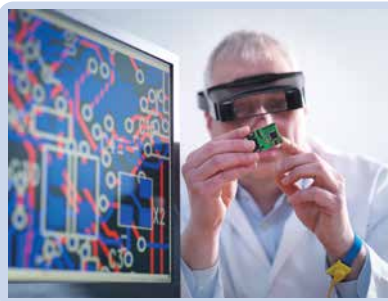
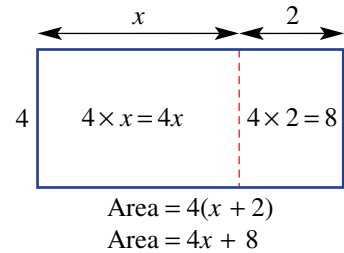

Solving equations is an essential skill for electronic engineers when designing the circuit boards used in vehicles, appliances, audio-visual transmission and technological devices. For a circuit in a TV remote control, a voltage,  $v$ , is found by solving:  $1.14v = 0.8(9 - v)$ .

### Lesson starter: Architect's dilemma

In the house plan shown on the right, the kitchen and dining room are separated by a dividing door. Dimensions are shown in metres.

- If the width of the divider is  $x$ , what is the area of the kitchen? What is the area of the dining room?
- Try to find the width of the divider if the areas of the two rooms are equal.
- Is it easier to solve  $3(7 + x) = 4(x + 4)$  or  $21 + 3x = 4x + 16$ ? Which of these did you solve when trying to find the width of the divider?

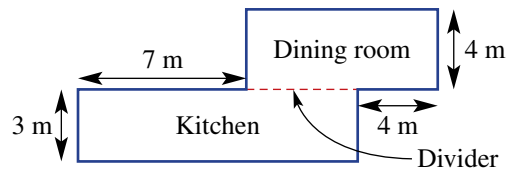

### KEY IDEAS

To expand brackets, use the **distributive law**, which states that

- $a(b + c) = ab + ac$ . For example:  $3(x + 4) = 3x + 12$
- $a(b - c) = ab - ac$ . For example:  $4(b - 2) = 4b - 8$

**Like terms** are terms that contain exactly the same pronumerals and can be collected to simplify expressions. For example:  $5x + 10 + 7x$  can be simplified to  $12x + 10$ .

Equations involving brackets can be solved by first expanding brackets and collecting like terms.

	$x$	$+4$
3	$3x$	$+12$
	$b$	$-2$
4	$4b$	$-8$

## BUILDING UNDERSTANDING

1 State the missing numbers.

a  $4(y + 3) = 4y + \square$

b  $7(2p - 5) = \square p - 35$

c  $2(4x + 5) = \square x + \square$

2 Match each expression **a–d** with its expanded form **A–D**.

a  $2(x + 4)$

A  $4x + 8$

b  $2(2x + 1)$

B  $2x + 8$

c  $4(x + 2)$

C  $2x + 4$

d  $2(x + 2)$

D  $4x + 2$

3 Rolf is unsure whether  $4(x + 3)$  is equivalent to  $4x + 12$  or  $4x + 3$ .

a Give the missing numbers in the table below.

b What is the correct expansion of  $4(x + 3)$ ?

$x$	0	1	2
$4(x + 3)$			
$4x + 12$			
$4x + 3$			

4 Simplify the following expressions by collecting like terms.

a  $7p + 2p + 3$

b  $8x - 2x + 4$

c  $3x + 6 - 2x$



### Example 8 Solving equations with brackets

Solve the following equations by first expanding any brackets.

a  $3(p + 4) = 18$

b  $-12(3q + 5) = -132$

c  $4(2x - 5) + 3x = 57$

d  $2(3k + 1) = 5(2k - 6)$

#### SOLUTION

a

$$\begin{array}{l}
 3(p + 4) = 18 \\
 3p + 12 = 18 \quad -12 \\
 3p = 6 \quad -12 \\
 p = 2 \quad +3
 \end{array}$$

b

$$\begin{array}{l}
 -12(3q + 5) = -132 \\
 -36q + (-60) = -132 \\
 -36q - 60 = -132 \quad +60 \\
 -36q = -72 \quad +60 \\
 q = 2 \quad +(-36)
 \end{array}$$

#### EXPLANATION

Use the distributive law to expand the brackets.

Alternative layout:

$$\begin{array}{cc}
 p & +4 \\
 3 & \boxed{3p} \quad \boxed{+12}
 \end{array}$$

Solve the equation by performing the same operations to both sides.

Use the distributive law to expand the brackets.

Simplify  $-36q + (-60)$  to  $-36q - 60$ .

Alternative layout:

$$\begin{array}{cc}
 3q & +5 \\
 -12 & \boxed{-36q} \quad \boxed{-60}
 \end{array}$$

Solve the equation by performing the same operations to both sides.

**SOLUTION****c**

$$4(2x - 5) + 3x = 57$$

$$8x - 20 + 3x = 57$$

$$11x - 20 = 57$$

$$11x = 77$$

$$x = 7$$

**d**

$$2(3k + 1) = 5(2k - 6)$$

$$6k + 2 = 10k - 30$$

$$2 = 4k - 30$$

$$32 = 4k$$

$$8 = k$$

$$\therefore k = 8$$

**EXPLANATION**

Use the distributive law to expand the brackets.

Alternative layout:

$$4 \begin{array}{|c|c|} \hline 2x & -5 \\ \hline 8x & -20 \\ \hline \end{array}$$

Combine the like terms:

$$8x + 3x = 11x.$$

Solve the equation by performing the same operations to both sides.

Expand brackets on both sides.

Alternative layout:

$$2 \begin{array}{|c|c|} \hline 3k & +1 \\ \hline 6k & +2 \\ \hline \end{array} \quad 5 \begin{array}{|c|c|} \hline 2k & -6 \\ \hline 10k & -30 \\ \hline \end{array}$$

Solve the equation by performing the same operations to both sides.

Write the final answer with the pronumeral on the left-hand side.

**Now you try**

Solve the following equations by first expanding any brackets.

**a**  $5(k + 3) = 30$

**b**  $-2(3m + 4) = -32$

**c**  $2(3x - 4) + 2x = 40$

**d**  $2(3q - 10) = 11(q - 5)$

**Exercise 7E****FLUENCY**

1,  $2-4(\frac{1}{2})$

$2-5(\frac{1}{2})$

$2-6(\frac{1}{3})$

- Example 8a** 1 Solve the following equations by first expanding any brackets.
- a**  $4(p + 1) = 12$       **b**  $2(q + 1) = 10$       **c**  $5(2x + 1) = 35$       **d**  $3(2k + 4) = 18$
- Example 8a** 2 Solve the following equations by first expanding the brackets.
- a**  $2(4u + 2) = 52$       **b**  $3(3j - 4) = 15$       **c**  $5(2p - 4) = 40$   
**d**  $15 = 5(2m - 5)$       **e**  $2(5n + 5) = 60$       **f**  $26 = 2(3a + 4)$
- Example 8b** 3 Solve the following equations involving negative numbers.
- a**  $-6(4p + 4) = 24$       **b**  $-2(4u - 5) = 34$       **c**  $-2(3v - 4) = 38$   
**d**  $28 = -4(3r + 5)$       **e**  $-3(2b - 2) = 48$       **f**  $-6 = -3(2d - 4)$

Example 8c

4 Solve the following equations by expanding and combining like terms.

a  $4(3y + 2) + 2y = 50$

b  $5(2l - 5) + 3l = 1$

c  $4(5 + 3w) + 5 = 49$

d  $49 = 5(3c + 5) - 3c$

e  $28 = 4(3d + 3) - 4d$

f  $58 = 4(2w - 5) + 5w$

g  $23 = 4(2p - 3) + 3$

h  $44 = 5(3k + 2) + 2k$

i  $49 = 3(2c - 5) + 4$

Example 8d

5 Solve the following equations by expanding brackets on both sides.

a  $5(4x - 4) = 5(3x + 3)$

b  $6(4 + 2r) = 3(5r + 3)$

c  $5(5f - 2) = 5(3f + 4)$

d  $4(4p - 3) = 2(4 + 3p)$

e  $2(5h + 4) = 3(4 + 3h)$

f  $4(4r - 5) = 2(5 + 5r)$

g  $4(3r - 2) = 4(2r + 3)$

h  $2(2p + 4) = 2(3p - 2)$

i  $3(2a + 1) = 11(a - 2)$

6 Solve the following equations algebraically.

a  $2(3 + 5r) + 6 = 4(2r + 5) + 6$

b  $3(2l + 2) + 18 = 4(4l + 3) - 8$

c  $2(3x - 5) + 16 = 3 + 5(2x - 5)$

d  $3(4s + 3) - 3 = 3(3s + 5) + 15$

e  $4(4y + 5) - 4 = 6(3y - 3) + 20$

f  $3(4h + 5) + 2 = 14 + 3(5h - 2)$

## PROBLEM-SOLVING

7, 8

8, 9

8–10

7 Desmond notes that in 4 years' time his age when doubled will give the number 50. Desmond's current age is  $d$  years old.

- Write an expression for Desmond's age in 4 years' time.
- Write an expression for double his age in 4 years' time.
- Write an equation to describe the situation described above.
- Solve the equation to find his current age.



8 Rahda's usual hourly wage is  $\$w$ . She works for 5 hours at this wage and then 3 more hours at an increased wage of  $\$(w + 4)$ .

- Write an expression for the total amount Rahda earns for the 8 hours.
- Rahda earns  $\$104$  for the 8 hours. Write and solve an equation to find her usual hourly wage.

9 Kate's age 5 years ago, when doubled, is equal to triple her age 10 years ago.

- Write an equation to describe this, using  $k$  for Kate's current age.
- Solve the equation to find Kate's current age.

10 Rectangles  $A$  and  $B$  in the diagram below have the same area.

- What is the value of  $x$ ?
- State the perimeter of the shape shown below.

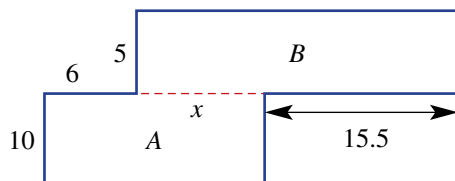

## REASONING

11

11, 12

11, 13, 14

- 11 For some equations with brackets it is possible to solve by dividing first rather than expanding. For example, if  $3(x + 1) = 24$ , we can just divide both sides by 3 first.
- Show how to solve  $5(x + 4) = 30$  without expanding.
  - Show how to solve  $4(x + 2) + 3 = 27$  without expanding.
  - Can you solve  $3(x + 1) + 2x = 28$  without expanding? Why or why not?
- 12 Abraham is asked how many people are in the room next door. He answers that if three more people walked in and then the room's population was doubled, this would have the same effect as quadrupling the population and then 11 people leaving. Explain why what Abraham said cannot be true.



- 13 Ajith claims that three times his age 5 years ago is the same as nine times how old he will be next year. Prove that what Ajith is saying cannot be true.
- 14 A common mistake when expanding is to write  $2(n + 3)$  as  $2n + 3$ . These are not equivalent, since, for example,  $2(5 + 3) = 16$  and  $2 \times 5 + 3 = 13$ .
- Prove that they are never equal by trying to solve  $2(n + 3) = 2n + 3$ .
  - Prove that  $4(2x + 3)$  is never equal to  $8x + 3$  but it is sometimes equal to  $4x + 12$ .

## ENRICHMENT: Challenging expansions

-

-

15(1/2)

- 15 Solve the following equations. Note that your answers might not be integers.
- $2(3x + 4) + 5(6x + 7) = 64x + 1$
  - $-5(3p + 2) + 5(2p + 3) = -31$
  - $-10(n + 1) + 20(2n + 13) = 7$
  - $4(2q + 1) - 5(3q + 1) = 11q - 1$
  - $x + 2(x + 1) + 3(x + 2) = 11x$
  - $m - 2(m + 1) - 3(m - 1) = 2(1 - 4m)$

- 7A** 1 For each of the following equations, state whether they are true (T) or false (F).
- a**  $5 + 11 = 8 \times 2$   
**b**  $x + 9 = 18 - x$ , if  $x = 4$   
**c**  $a \times (a - 4) = 2a$ , if  $a = 6$
- 7A** 2 State a solution to each of the following equations (no working required).
- a**  $k + 5 = 21$   
**b**  $7 = c - 6$   
**c**  $4m = 32$   
**d**  $10 + t = 3t$
- 7A** 3 Write equations for the following scenarios. You do not need to solve the equations.
- a** A number  $n$  is doubled and then 5 is added. The result is 17.  
**b** Archie's age is  $a$ . Archie's mother, who is 26 years older than Archie, is triple Archie's age.
- 7B** 4 Solve the following equations algebraically.
- a**  $a + 8 = 15$       **b**  $12 = 9 - k$       **c**  $-42 = 6h$       **d**  $5 + 3y = 29$   
**e**  $4u - 8 = 40$       **f**  $52 = 8j - 4$       **g**  $68 - 12d = 8$       **h**  $59 = -13 - 9m$
- 7C** 5 Solve the following equations algebraically.
- a**  $\frac{5u}{2} = 100$       **b**  $\frac{-3h}{7} = -6$       **c**  $3 + \frac{4x}{3} = 15$       **d**  $\frac{2w + 7}{3} = 5$
- 7D** 6 Solve the following equations algebraically.
- a**  $4n + 3 = 2n + 17$   
**b**  $9w - 7 = 4w - 17$   
**c**  $e + 8 = -28 - 3e$
- 7E** 7 Solve the following equations by first expanding any brackets.
- a**  $6(a + 2) = 42$   
**b**  $3(4w - 6) = 114$   
**c**  $5(2q - 1) - 3q = 30$   
**d**  $-8(2 - p) = 3(2p - 8)$
- 7B/C** 8 For each of the following, write an equation and solve it algebraically to find the unknown number.
- a** The product of  $q$  and  $-6$  is 30.  
**b** Two thirds of a number  $m$  gives a result of 12.  
**c** A number  $k$  is tripled and then 4 is added. This result is halved to obtain  $-13$ .  
**d** The average of  $3x$  and 10 is 14.
- 7E** 9 Maddie's age 8 years ago when multiplied by 5 is the same as triple Maddie's age in 2 years' time. Write and solve an equation to find Maddie's current age.

## 7F Solving simple quadratic equations (EXTENDING)

### LEARNING INTENTIONS

- To know the form of a simple quadratic equation
- To be able to determine the number of solutions to a simple quadratic equation
- To be able to solve a simple quadratic equation

Most of the equations you have worked with so far are called linear equations like  $2x - 3 = 7$  and  $5(a + 2) = 7(a - 1)$ , where the power of the pronumeral is 1 and there is usually a single solution. Another type of equation is of the form  $x^2 = c$ , and this is an example of a simple quadratic equation. Note that the power of the pronumeral  $x$  is 2. Depending on the value of  $c$ ,  $x$  can have zero, one or two solutions. These types of equations appear frequently in mathematics and in problems involving distance, area, graphs and motion.

### Let's start: How many solutions?

Consider the equation  $x^2 = c$ . How many values of  $x$  can you think of that satisfy the equation when:

- $c = 0$ ?
- $c = 9$ ?
- $c = -4$ ?

What conclusions can you come to regarding the number of solutions for  $x$  depending on the value of  $c$ ?

### KEY IDEAS

■ Simple quadratic equations of the form  $ax^2 = c$ .

- $x^2 = 9$  has two solutions because 9 is a positive number.

$$x^2 = 9$$

$$\begin{array}{l} x = \sqrt{9}, \quad x = -\sqrt{9} \\ x = 3, \quad x = -3 \end{array} \quad \text{Note: } 3^2 = 9 \text{ and } (-3)^2 = 9.$$

$$x = \pm 3$$

where  $\pm 3$  represent both solutions (it is a shorthand way of writing  $x = 3$  or  $x = -3$ ).

- $x^2 = 0$  has one solution ( $x = 0$ ) because  $0^2 = 0$  and no other number could result in 0 when squared.
- $x^2 = -9$  has no solutions because the square of any number is 0 or positive.

■ Solve  $ax^2 = c$  by first dividing both sides by  $a$ .

$$\begin{array}{l} +2 \quad (2x^2 = 32) \quad +2 \\ \quad \quad x^2 = 16 \\ \quad \quad x = \pm 4 \end{array}$$

### BUILDING AND UNDERSTANDING

1 a Calculate the following.

i  $3^2$  and  $(-3)^2$

ii  $6^2$  and  $(-6)^2$

iii  $1^2$  and  $(-1)^2$

iv  $10^2$  and  $(-10)^2$

b What do you notice about the answers to each pair?

- 2 a** Use a calculator to multiply these numbers by themselves. Recall that a neg  $\times$  neg = pos.  
**i**  $-3$                       **ii**  $7$                       **iii**  $13$                       **iv**  $-8$
- b** Did you obtain any negative numbers in part **a**?
- 3** Fill in the missing numbers.
- a**  $(-3)^2 = \underline{\hspace{2cm}}$  and  $3^2 = 9$  so if  $x^2 = 9$  then  $x = \underline{\hspace{2cm}}$  or  $x = \underline{\hspace{2cm}}$ .
- b**  $(5)^2 = \underline{\hspace{2cm}}$  and  $(-5)^2 = 25$  so if  $x^2 = 25$  then  $x = \underline{\hspace{2cm}}$  or  $x = \underline{\hspace{2cm}}$ .
- c**  $(11)^2 = 121$  and  $(-11)^2 = 121$  so if  $x^2 = 121$  then  $x = \underline{\hspace{2cm}}$  or  $x = \underline{\hspace{2cm}}$ .



### Example 9 Solving equations of the form $x^2 = c$ , where $c > 0$

Solve the following equations. Round to two decimal places in part **b** by using a calculator to assist.

**a**  $x^2 = 81$                       **b**  $x^2 = 23$                       **c**  $3x^2 = 27$

#### SOLUTION

**a**  $x = 9$  or  $x = -9$

**b**  $x = \sqrt{23} = 4.80$  (to 2 decimal places) or  
 $x = -\sqrt{23} = -4.80$  (to 2 decimal places)

**c**  $3x^2 = 27$   
 $x^2 = 9$   
 $x = \pm 3$

#### EXPLANATION

The equation has two solutions because 81 is a positive number.  $9^2 = 81$  and  $(-9)^2 = 81$ .

The number 23 is not a perfect square so  $\sqrt{23}$  can be rounded if required.

First divide both sides by 3.  
 Both  $+3$  and  $-3$  square to give 9.

#### Now you try

Solve the following equations. Round to two decimal places in part **b** by using a calculator to assist.

**a**  $x^2 = 25$                       **b**  $x^2 = 17$                       **c**  $2x^2 = 72$



### Example 10 Stating the number of solutions

State the number of solutions for  $x$  in these equations.

**a**  $x^2 = -3$                       **b**  $x^2 = 0$                       **c**  $x^2 = 7$

#### SOLUTION

**a** zero solutions

**b** one solution

**c** two solutions

#### EXPLANATION

In  $x^2 = c$ , if  $c < 0$  there are no solutions because any number squared is positive or zero.

$x = 0$  is the only solution to  $x^2 = 0$ .

The equation has two solutions because 7 is a positive number.



**Now you try**State the number of solutions for  $x$  in these equations.

**a**  $x^2 = 11$

**b**  $x^2 = -5$

**c**  $x^2 = 0$

**Exercise 7F****FLUENCY**1–3( $\frac{1}{2}$ )1–4( $\frac{1}{2}$ )1–4( $\frac{1}{4}$ )

Example 9a

**1** Solve the following equations.

**a**  $x^2 = 4$

**b**  $x^2 = 49$

**c**  $x^2 = 100$

**d**  $x^2 = 64$

**e**  $x^2 = 1$

**f**  $x^2 = 144$

**g**  $x^2 = 36$

**h**  $x^2 = 121$

**i**  $x^2 = 169$

**j**  $x^2 = 256$

**k**  $x^2 = 900$

**l**  $x^2 = 10\,000$

Example 9b

**2** Solve the following and round to two decimal places.

**a**  $x^2 = 6$

**b**  $x^2 = 12$

**c**  $x^2 = 37$

**d**  $x^2 = 41$

**e**  $x^2 = 104$

**f**  $x^2 = 317$

**g**  $x^2 = 390$

**h**  $x^2 = 694$

Example 9c

**3** Solve the following equations.

**a**  $2x^2 = 8$

**b**  $2x^2 = 32$

**c**  $5x^2 = 45$

**d**  $3x^2 = 300$

**e**  $2x^2 = 288$

**f**  $5x^2 = 125$

**g**  $3x^2 = 363$

**h**  $7x^2 = 567$

Example 10

**4** State the number of solutions for these equations.

**a**  $x^2 = 10$

**b**  $x^2 = 4$

**c**  $x^2 = 3917$

**d**  $x^2 = -4$

**e**  $x^2 = -94$

**f**  $x^2 = 0$

**g**  $a^2 = 0$

**h**  $y^2 = 1$

**PROBLEM-SOLVING**

5, 6

6, 7

6, 7( $\frac{1}{2}$ )

- 5** The area of a square is  $25\text{ m}^2$ . Find its perimeter.
- 6** A square mirror has an area of  $1\text{ m}^2$ . Find its perimeter.

7 By first dividing both sides by the coefficient of  $x^2$ , solve these simple quadratic equations.

a  $-2x^2 = -8$

b  $-3x^2 = -3$

c  $-5x^2 = -45$

d  $-3x^2 = -12$

e  $-2x^2 = -50$

f  $-7x^2 = 0$

g  $-6x^2 = -216$

h  $-10x^2 = -1000$

### REASONING

8, 9

8–10

9–11

8 Explain why:

a  $x^2 = 0$  has only one solution

b  $x^2 = c$  has no solutions when  $c < 0$ .

9 Solve the equations with the given conditions.

a  $x^2 = 16$  where  $x > 0$

b  $x^2 = 25$  where  $x < 0$

c  $x^2 = 49$  where  $x < 0$

d  $x^2 = 196$  where  $x > 0$

10 The exact value solutions to  $x^2 = 5$ , for example, are written as  $x = \sqrt{5}$  or  $-\sqrt{5}$ . Alternatively, we can write  $x = \pm\sqrt{5}$ .

Write the exact value solutions to these equations.

a  $x^2 = 11$

b  $x^2 = 17$

c  $x^2 = 33$

d  $x^2 = 156$

11 The triad  $(a, b, c) = (3, 4, 5)$  satisfies the equation  $a^2 + b^2 = c^2$  because  $3^2 + 4^2 = 5^2$ .

a Decide if the following triads also satisfy the equation  $a^2 + b^2 = c^2$ .

i  $(6, 8, 10)$

ii  $(5, 12, 13)$

iii  $(1, 2, 3)$

iv  $(-3, -4, -5)$

v  $(-2, -3, -6)$

vi  $(-8, 15, 17)$

b Can you find any triads, for which  $a, b, c$  are positive integers, that satisfy  $a^3 + b^3 = c^3$ ?

### ENRICHMENT: Solving more complex linear equations

-

-

12

12 Compare this linear and quadratic equation solution.

Now solve these quadratic equations.

a  $2x^2 + 1 = 9$

b  $5x^2 - 2 = 3$

c  $3x^2 - 4 = 23$

d  $-x^2 + 1 = 0$

e  $-2x^2 + 8 = 0$

f  $7x^2 - 6 = 169$

g  $4 - x^2 = 0$

h  $27 - 3x^2 = 0$

i  $38 + 2x^2 = 110$

## 7G Formulas and relationships

### LEARNING INTENTIONS

- To know the meaning of the terms formula, rule and subject
- To be able to apply a formula to find an unknown value

Some equations involve two or more variables that are related. For example, you know from measurement that the area of a rectangle is related to its length and width, given by the formula  $A = l \times w$ , and its perimeter is given by  $P = 2l + 2w$ . Although these are often used as a definition for the area and a definition of perimeter, they are also examples of equations – two expressions written on either side of an equal sign.

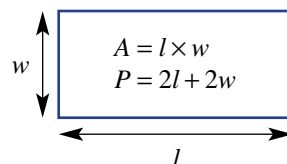

### Lesson starter: Rectangular dimensions

You know that the area and perimeter of a rectangle are given by  $A = l \times w$  and  $P = 2l + 2w$ .

- If  $l = 10$  and  $w = 7$ , find the perimeter and the area.
- If  $l = 8$  and  $w = 2$ , find the perimeter and the area.
- Notice that sometimes the area is bigger than the perimeter and sometimes the area is less than the perimeter. If  $l = 10$ , is it possible to make the area and the perimeter equal?
- If  $l = 2$ , can you make the area and the perimeter equal? Discuss.



This viaduct in France has a rail and road bridge. Engineers designed its support structure using semicircular arches, radius  $r$ , and vertical pylons, height  $h$ . Each railway support section has an inside perimeter:  $P = \pi r + 2h$ .

### KEY IDEAS

- The **subject** of an equation is a variable (or pronumeral) that occurs by itself on the left-hand side. For example:  $V$  is the subject of  $V = 3x + 2y$ .
- A **formula** or **rule** is an equation containing two or more variables, one of which is the subject of the equation.
- To use a formula, substitute all known values and then solve the equation to find the unknown value.

## BUILDING UNDERSTANDING

- 1 a Substitute  $x = 4$  into the expression  $x + 7$ .  
 b Substitute  $p = 5$  into the expression  $2p - 3$ .
- 2 If you substitute  $P = 10$  and  $x = 2$  into the formula  $P = 3m + x$ , which of the following equations would you get?  
 A  $10 = 6 + x$       B  $10 = 3m + 2$       C  $2 = 3m + 10$       D  $P = 30 + 2$
- 3 If you substitute  $k = 10$  and  $L = 12$  into the formula  $L = 4k + Q$ , which of the following equations would you get?  
 A  $12 = 40 + Q$       B  $L = 40 + 12$       C  $12 = 410 + Q$       D  $10 = 48 + Q$



## Example 11 Applying a formula

Apply the formula for a rectangle's perimeter  $P = 2l + 2w$  to find:

- a  $P$  when  $l = 7$  and  $w = 4$   
 b  $l$  when  $P = 40$  and  $w = 3$ .

## SOLUTION

a  $P = 2l + 2w$   
 $P = 2(7) + 2(4)$   
 $P = 22$

b  $P = 2l + 2w$   
 $40 = 2l + 2(3)$

$$\begin{array}{r}
 40 = 2l + 6 \\
 \begin{array}{c} \curvearrowleft -6 \end{array} \\
 34 = 2l \\
 \begin{array}{c} \curvearrowright +2 \\ \curvearrowright +2 \end{array} \\
 17 = l \\
 \therefore l = 17
 \end{array}$$

## EXPLANATION

Write the formula.

Substitute in the values for  $l$  and  $w$ .

Simplify the result.

Write the formula.

Substitute in the values for  $P$  and  $w$  to obtain an equation.

Solve the equation to obtain the value of  $l$ .

## Now you try

Apply the formula for a rectangle's perimeter  $P = 2l + 2w$  to find:

- a  $P$  when  $l = 8$  and  $w = 3$   
 b  $l$  when  $P = 30$  and  $w = 6$ .

## Exercise 7G

### FLUENCY

1–5

2–6

3–7

Example 11a

- 1 Consider the rule  $A = 4p + 7$ . Find the value of  $A$  if:
- a**  $p = 3$                       **b**  $p = 6$                       **c**  $p = 10$                       **d**  $p = 0$ .

Example 11

- 2 Apply the formula for a rectangle's perimeter  $P = 2l + 2w$  to find:
- a**  $P$  when  $l = 5$  and  $w = 3$   
**b**  $l$  when  $P = 28$  and  $w = 6$ .

Example 11

- 3 Consider the rule  $U = 8a + 4$ .
- a** Find  $a$  if  $U = 44$ . Set up and solve an equation.  
**b** Find  $a$  if  $U = 92$ . Set up and solve an equation.  
**c** If  $U = -12$ , find the value of  $a$ .
- 4 Consider the relationship  $y = 2x + 4$ .
- a** Find  $y$  if  $x = 3$ .  
**b** By solving an appropriate equation, find the value of  $x$  that makes  $y = 16$ .  
**c** Find the value of  $x$  if  $y = 0$ .
- 5 Use the formula  $P = mv$  to find the value of  $m$  when  $P = 22$  and  $v = 4$ .
- 6 Assume that  $x$  and  $y$  are related by the equation  $4x + 3y = 24$ .
- a** If  $x = 3$ , find  $y$  by solving an equation.  
**b** If  $x = 0$ , find the value of  $y$ .  
**c** If  $y = 2$ , find  $x$  by solving an equation.  
**d** If  $y = 0$ , find the value of  $x$ .
- 7 Consider the formula  $G = k(2a + p) + a$ .
- a** If  $k = 3$ ,  $a = 7$  and  $p = -2$ , find the value of  $G$ .  
**b** If  $G = 78$ ,  $k = 3$  and  $p = 5$ , find the value of  $a$ .

### PROBLEM-SOLVING

8

8, 9

9, 10

- 8 The cost \$ $C$  to hire a taxi for a trip of length  $d$  km is  $C = 3 + 2d$ .
- a** Find the cost of a 10 km trip (i.e. for  $d = 10$ ).  
**b** A trip has a total cost of \$161.  
     **i** Set up an equation by substituting  $C = 161$ .  
     **ii** Solve the equation algebraically.  
     **iii** How far did the taxi travel? (Give your answer in km.)
-  9 To convert temperature between Celsius and Fahrenheit, the rule is  $F = 1.8C + 32$ .
- a** Find  $F$  if  $C = 10$ .  
**b** Find  $C$  if  $F = 95$ .  
**c** Vinod's body temperature is  $100^\circ$  Fahrenheit. What temperature is this in degrees Celsius? Answer correct to one decimal place.

- 10 The formula for the area of a trapezium is  $A = \frac{1}{2}(a + b)h$ .

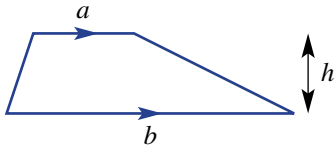

- a Find the area of the trapezium shown below.

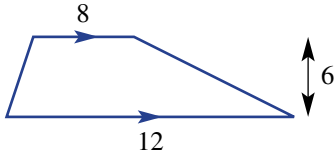

- b Find the value of  $h$  if  $A = 20$ ,  $a = 3$  and  $b = 7$ .  
c Find the missing value in the trapezium below.

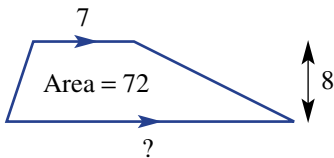

### REASONING

11

11, 12

12–14

- 11 Evangeline is a scientist who tries to work out the relationship between the volume of a gas,  $V$  mL, and its temperature  $T$ °C. She makes a few measurements.

- a What is a possible rule between  $V$  and  $T$ ?

$V$	10	20
$T$	10	15

- b Use your rule to find the volume at a temperature of 27°C.

- c Prove that the rule  $T = \frac{(V - 10)^2}{20} + 10$  would also work for Evangeline's results.

- 12 Consider the rule  $G = 120 - 4p$ .

- a If  $p$  is between 7 and 11, what is the largest value of  $G$ ?  
b If  $p$  and  $G$  are equal, what value do they have?

- 13 Marie is a scientist who is trying to discover the relationship between the volume of a gas  $V$ , its temperature  $T$  and its transparency  $A$ . She makes a few measurements.

	Test 1	Test 2
$V$	10	20
$A$	2	5
$T$	15	12

Which one or more of the following rules are consistent with the experiment's results?

**A**  $T = \frac{3V}{A}$

**B**  $T = V + 2A$

**C**  $T = 17 - A$

- 14 Temperatures in degrees Fahrenheit and Celsius are related by the rule  $F = 1.8C + 32$ .

- a By substituting  $F = x$  and  $C = x$ , find a value such that the temperature in Fahrenheit and the temperature in Celsius are equal.  
b By substituting  $F = 2x$  and  $C = x$ , find a temperature in Celsius that doubles to give the temperature in Fahrenheit.  
c Prove that there are no Celsius temperatures that can be multiplied by 1.8 to give the temperature in Fahrenheit.

## ENRICHMENT: Mobile phone plans

15

- 15 Two companies have mobile phone plans that factor in the number of minutes spent talking each month ( $t$ ) and the total number of calls made ( $c$ ).

Company A's cost in cents:  $A = 20t + 15c + 300$

Company B's cost in cents:  $B = 30t + 10c$

- In one month 12 calls were made, totalling 50 minutes on the phone. Find the cost in dollars that company A and company B would have charged.
- In another month, a company A user was charged \$15 (1500 cents) for making 20 calls. How long were these calls in total?
- In another month, a company B user talked for 60 minutes in total and was charged \$21. What was the average length of these calls?
- Briony notices one month that for her values of  $t$  and  $c$ , the two companies cost exactly the same. Find a possible value of  $t$  and  $c$  that would make this happen.
- Briony reveals that she made exactly 20 calls for the month in which the two companies' charges would be the same. How much time did she spend talking?



The following problems will investigate practical situations drawing upon knowledge and skills developed throughout the chapter. In attempting to solve these problems, aim to identify the key information, use diagrams, formulate ideas, apply strategies, make calculations and check and communicate your solutions.

## Habi and Harry's algebraic challenge

- 1 Two friends, Habi and Harry, are trying to challenge one another with increasingly difficult algebra problems. They focus on working with rectangles with varying algebraic expressions for their lengths and widths.

*They are interested in finding out how much information they need to solve their rectangle puzzle problems.*

Habi goes first and presents Harry with the rectangle shown on the right, which contains two unknowns. He sets Harry the task of finding the perimeter and area of this rectangle.

- Solve equations to find the value of  $x$  and  $y$ .
- What is the perimeter and area of Habi's rectangle?

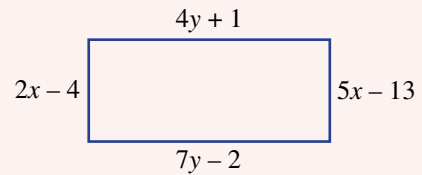

Harry goes next and says that his pronumerals will include fractions, but that the perimeter and area of the rectangle will be whole numbers. He presents Habi with the rectangle shown on the right, which also contains two unknowns.

- Solve equations to find the value of  $x$  and  $y$ .
- What is the perimeter and area of Harry's rectangle?
- Explain how the pronumeral answers can include fractions, but the perimeter and area of the rectangle are whole numbers.

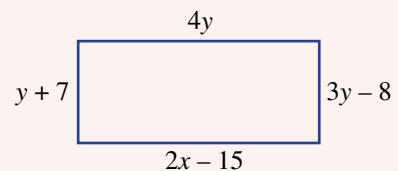

Harry and Hiba decide to randomly write two pairs of algebraic expressions – one pair including  $x$  for the width of the rectangle and one pair including  $y$  for the length of the rectangle.

- Will Harry and Hiba always find an answer for the perimeter and area of their rectangle?
- Write a pair of algebraic expressions for the width and length of a rectangle that results in the perimeter and the area equalling zero.

## The cost and efficiency of light bulbs

- 2 Robyn's research uncovers that lumens is the unit used for how bright a light is and that watts, a measure of electricity, determines the cost of running a light.

In the past, when there was only one main type of light bulb, known as an incandescent bulb, the light bulbs were simply referred to by their wattage. A higher number of watts simply meant more power being used and more light being emitted. Nowadays, newer light bulbs such as CFL and LED bulbs are more efficient and more environmentally friendly, and report the brightness (in terms of lumens) as well as the wattage.

*Robyn is trying to understand more about the relationship between the brightness of a light bulb and the cost of running a light bulb.*





Robyn gathers the following information for four different strengths of light bulb and three different types of light bulb.

Brightness (lumens, $L$ )	Incandescent bulbs (watts, $W$ )	CFL bulbs (watts, $W$ )	LED bulbs (watts, $W$ )
500	40	12.5	8
750	60	18.75	12
1000	80	25	16
1250	100	31.25	20

- Determine a rule between  $L$  and  $W$  for incandescent bulbs.
- Use your rule to determine the brightness, in lumens, for a 150 watt incandescent bulb.
- Determine a rule between  $L$  and  $W$  for CFL bulbs.
- Use your rule to determine the wattage required to produce 600 lumens of light for a CFL bulb.
- Determine a rule between  $L$  and  $W$  for LED bulbs.
- Determine what the letters CFL and LED stand for in terms of light bulbs.

## Savings from a part-time job

- Anai has just commenced a part-time job at her local bakery. Anai's weekday rate of pay is \$16.50 per hour. On weekends her rate increases to \$19.20 per hour and on public holidays she is paid \$28.50 per hour.

*Anai wants to work out how much money she earns for different shifts and how long it is likely to take her to earn \$2000.*

- Write an expression for the amount Anai earns if she works  $x$  hours during the week.
- Write an equation to show how much Anai will earn ( $E$ ) if she works  $x$  hours during the week,  $y$  hours over the weekend and  $z$  hours on a public holiday.
- In one month over the summer holidays, Anai works 30 hours during the week, 32 hours on the weekend and 6 hours on a public holiday. Using your equation, determine Anai's pay for the month.
- Provide a possible combination of hours that Anai would have to work so that she could earn \$2000 in one month.
- A different employer offers to pay Anai just one standard hourly rate, regardless of whether she works during the week, on weekends or on public holidays. What would this standard hourly rate need to be for Anai to be better off? Justify your answer.

## 7H Applications of equations

### LEARNING INTENTIONS

- To understand that equations can be applied to real-world situations
- To be able to solve problems using equations

Although knowing how to solve equations is useful, it is important to be able to recognise when real-world situations can be thought of as equations. This is the case whenever it is known that two values are equal. In this case, an equation can be constructed and solved. It is important to translate this solution into a meaningful answer within the real-world context.

### Lesson starter: Sibling sum

John and his elder sister are 4 years apart in their ages.

- If the sum of their ages is 42, describe how you could work out how old they are.
- Could you write an equation to describe the situation above, if  $x$  is used for John's age?
- How would the equation change if  $x$  is used for John's sister's age instead?



Solving equations can answer financial questions, such as: how long does it take to get back \$15600 spent on a solar power battery and panels? If  $n$  = number of years, and the power bill is then reduced by \$1200 p.a., solving  $1200n = 15600$  gives  $n = 13$  years.

### KEY IDEAS

■ An equation can be used to describe any situation in which two values are equal.

■ To solve a problem follow these steps.

1 Define pronumerals to stand for unknown numbers

2 Write an equation to describe the problem.

3 Solve the equation algebraically if possible, or by inspection.

4 Ensure you answer the original question, including the correct units (e.g. dollars, years, cm).

5 Check that your answer is reasonable.

1 Let  $x$  = John's current age  
 $\therefore x + 4$  = his sister's age

2  $x + x + 4 = 32$

3

$$\begin{array}{r} 2x + 4 = 32 \\ -4 \quad \quad \quad -4 \\ \hline 2x = 28 \\ +2 \quad \quad \quad +2 \\ \hline x = 14 \end{array}$$

4 John is 14 years old and his sister is 18

5 This solution seems reasonable (both numbers are plausible ages that are four years apart).

## BUILDING UNDERSTANDING

1 Match each of these worded descriptions with an appropriate expression.

- |  |           |
|--|-----------|
| a The sum of $x$ and 3                               | A $2x$    |
| b The cost of 2 apples if they cost $\$x$ each       | B $x + 1$ |
| c The cost of $x$ oranges if they cost $\$1.50$ each | C $3x$    |
| d Triple the value of $x$                            | D $x + 3$ |
| e One more than $x$                                  | E $1.5x$  |

2 For the following problems choose the equation to describe them.

- |   |                   |                |                |                |
|---|-------------------|----------------|----------------|----------------|
| a The sum of $x$ and 5 is 11.                                   | A $5x = 11$       | B $x + 5 = 11$ | C $x - 5 = 11$ | D $11 - 5$     |
| b The cost of 4 pens is $\$12$ . Each pen costs $\$p$ .         | A $4 = p$         | B $12p$        | C $4p = 12$    | D $12p = 4$    |
| c Josh's age next year is 10. His current age is $j$ .          | A $j + 1 = 10$    | B $j = 10$     | C 9            | D $j - 1 = 10$ |
| d The cost of $n$ pencils is $\$10$ . Each pencil costs $\$2$ . | A $n \div 10 = 2$ | B 5            | C $10n = 2$    | D $2n = 10$    |

3 Solve the following equations.

- |             |                 |                  |                 |
|-------------|-----------------|------------------|-----------------|
| a $5p = 30$ | b $5 + 2x = 23$ | c $12k - 7 = 41$ | d $10 = 3a + 1$ |
|-------------|-----------------|------------------|-----------------|



## Example 12 Solving a problem using equations

The weight of 6 identical books is 1.2 kg. What is the weight of one book?

## SOLUTION

Let  $b$  = weight of one book in kg.

$$\begin{array}{c} 6b = 1.2 \\ \swarrow \quad \searrow \\ +6 \quad \quad +6 \\ \swarrow \quad \searrow \\ b = 0.2 \end{array}$$

The books weigh 0.2 kg each, or 200 g each.

## EXPLANATION

Define a pronumeral to stand for the unknown number.

Write an equation to describe the situation.  
Solve the equation.

Answer the original question. It is not enough to give a final answer as 0.2; this is not the weight of a book, it is just a number.

## Now you try

The cost of 8 identical toys is  $\$24$ . What is the cost of one toy? Show complete working.

**Example 13 Solving a harder problem using equations**

Purchasing 5 apples and a \$2.40 mango costs the same as purchasing 7 apples and a mandarin that costs 60 cents. What is the cost of each apple?

**SOLUTION**

Let  $c$  = cost of one apple in dollars.

$$5c + 2.4 = 7c + 0.6$$

$$\begin{array}{l} 5c + 2.4 = 7c + 0.6 \\ -5c \quad -5c \\ \hline 2.4 = 2c + 0.6 \\ -0.6 \quad -0.6 \\ \hline 1.8 = 2c \\ +2 \quad +2 \\ \hline 0.9 = c \end{array}$$

Apples cost 90 cents each.

**EXPLANATION**

Define a pronumeral to stand for the unknown number.

Write an equation to describe the situation. Note that 60 cents must be converted to \$0.6 to keep the units the same throughout the equation.

Solve the equation.

Answer the original question. It is not enough to give a final answer as 0.9; this is not the cost of an apple, it is just a number.

**Now you try**

Purchasing 4 cans of soft drink and a \$3.00 carton of milk costs the same as purchasing 2 cans of soft drink and a \$6.40 bottle of juice. What is the cost of one can of soft drink?

**Example 14 Solving problems with two related unknowns**

Jane and Luke have a combined age of 60. Given that Jane is twice as old as Luke, find the ages of Luke and Jane.

**SOLUTION**

Let  $l$  = Luke's age

$$l + 2l = 60$$

$$l + 2l = 60$$

$$\begin{array}{l} 3l = 60 \\ \div 3 \quad \div 3 \\ \hline l = 20 \end{array}$$

Luke is 20 years old and Jane is 40 years old.

**EXPLANATION**

Define a pronumeral for the unknown value. Once Luke's age is found, we can double it to find Jane's age.

Write an equation to describe the situation. Note that Jane's age is  $2l$  because she is twice as old as Luke.

Solve the equation by first combining like terms.

Answer the original question.

**Now you try**

Jaime and Lisa have a combined age of 48. Given that Lisa is three times as old as Jaime, find their ages.

## Exercise 7H

### FLUENCY

1–3

2–5

3–5

- Example 12** 1 Thomas buys 3 doggy treats at a cafe for his dog Loui. The total cost is \$12. Let  $d$  to stand for the cost, in dollars, of one doggy treat.
- Write an equation to describe this problem.
  - Solve the equation algebraically.
  - Hence, state the cost of one doggy treat.
- Example 12** 2 Jerry buys 4 cups of coffee for \$13.20.
- Choose a pronumeral to stand for the cost of one cup of coffee.
  - Write an equation to describe the problem.
  - Solve the equation algebraically.
  - Hence state the cost of one cup of coffee.
- Example 12** 3 A combination of 6 chairs and a table costs \$3000. The table alone costs \$1740.
- Define a pronumeral for the cost of one chair.
  - Write an equation to describe the problem.
  - Solve the equation algebraically.
  - Hence state the cost of one chair.
- 4 The perimeter of this rectangle is 72 cm.
- Write an equation to describe the problem, using  $w$  for the width.
  - Solve the equation algebraically.
  - Hence state the width of the rectangle.
- 5 A plumber charges a \$70 call-out fee and \$52 per hour. The total cost of a particular visit was \$252.
- Define a variable to stand for the length of the visit in hours.
  - Write an equation to describe the problem.
  - Solve the equation algebraically.
  - State the length of the plumber's visit, giving your answer in minutes.

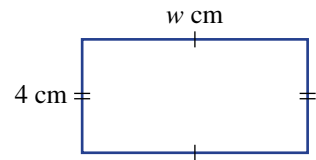

### PROBLEM-SOLVING

6–8

6–9

8–11

- Example 13** 6 A number is tripled, then 2 is added. This gives the same result as if the number were quadrupled. Set up and solve an equation to find the original number.



- 7 A square has a perimeter of 26 cm.
- Solve an equation to find its width.
  - State the area of the square.

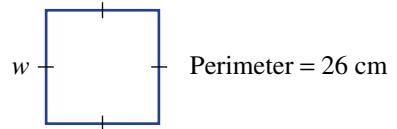

- Example 14** 8 Alison and Flynn's combined age is 40. Given that Flynn is 4 years older than Alison, write an equation and use it to find Alison's age.

- 9 Recall that in a quadrilateral the sum of all angles is  $360^\circ$ . Find the values of  $x$  and  $y$  in the diagram shown.

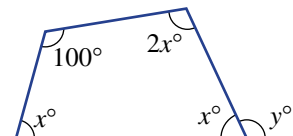



## 71 Inequalities

### LEARNING INTENTIONS

- To understand that an inequality is a mathematical statement that one value is larger than (or as large as) another value
- To be able to represent inequalities on a number line using open or closed circles and/or arrows
- To be able to describe real-life situations using inequalities

An inequality is like an equation but, instead of indicating that two expressions are equal, it indicates which of the two has a greater value. For example,  $2 + 4 < 7$ ,  $3 \times 5 \geq 15$  and  $x \leq 10$  are all inequalities. The first two are true, and the last one could be true or false depending on the value of  $x$ . For instance, the numbers 9.8, 8.45, 7 and  $-120$  all make this inequality true.

We could represent all the values of  $x$  that make  $x \leq 10$  a true statement.

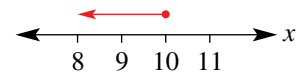

### Lesson starter: Small sums

Two positive whole numbers are chosen:  $x$  and  $y$ . You are told that  $x + y \leq 5$ .

- How many possible pairs of numbers make this true? For example,  $x = 2$  and  $y = 1$  is one pair and it is different from  $x = 1$  and  $y = 2$ .
- If  $x + y \leq 10$ , how many pairs are possible? Try to find a pattern rather than listing them all.
- If all you know about  $x$  and  $y$  is that  $x + y > 10$ , how many pairs of numbers could there be? Explain.

### KEY IDEAS

- An **inequality** is a statement of the form:
  - LHS  $>$  RHS (greater than). For example:  $5 > 2$
  - LHS  $\geq$  RHS (greater than or equal). For example:  $7 \geq 7$  or  $10 \geq 7$
  - LHS  $<$  RHS (less than). For example:  $2 < 10$
  - LHS  $\leq$  RHS (less than or equal). For example:  $5 \leq 5$  or  $2 \leq 5$
- Inequalities can be reversed:  $3 < x$  and  $x > 3$  are equivalent.
- Inequalities can be represented on a number line, using closed circles at the end points if the value is included, or open circles if it is excluded.

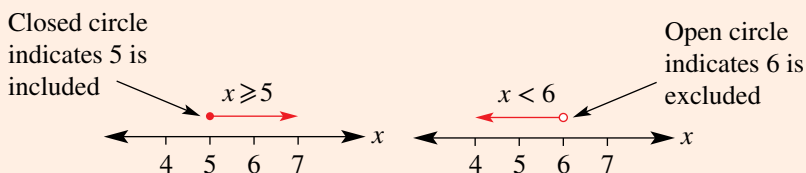

- A range can be represented as a segment on the number line using appropriate closed and open end points.

## BUILDING UNDERSTANDING

- 1 Classify the following statements as true or false.
- a  $5 > 3$                       b  $7 < 5$                       c  $13 < 13$                       d  $13 \leq 13$
- 2 Match each of these inequalities with the appropriate description.
- a  $x > 5$                       b  $x < 5$                       c  $x \geq 3$                       d  $x \leq 3$
- A The number  $x$  is less than 5.  
 B The number  $x$  is greater than or equal to 3.  
 C The number  $x$  is less than or equal to 3.  
 D The number  $x$  is greater than 5.
- 3 For each of the following, state whether they make the inequality  $x > 4$  true or false.
- a  $x = 5$                       b  $x = -2$                       c  $x = 4$                       d  $x = 27$
- 4 If  $x = 12$ , classify the following inequalities as true or false.
- a  $x > 2$                       b  $x < 11$                       c  $x \geq 13$                       d  $x \leq 12$



## Example 15 Representing inequalities on a number line

Represent the following inequalities on a number line.

- a  $x \geq 4$                       b  $x < 6$                       c  $1 < x \leq 5$

## SOLUTION

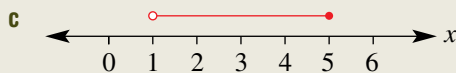
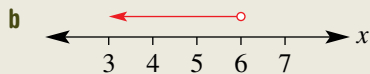
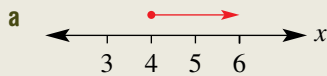

## EXPLANATION

A circle is placed at 4 and then the arrow points to the right, towards all numbers greater than 4. The circle is filled (closed) because 4 is included in the set.

A circle is placed at 6 and then the arrow points to the left, towards all numbers less than 6. The circle is hollow (open) because 6 is not included in the set.

Circles are placed at 1 and 5, and a line goes between them to indicate that all numbers in between are included. The circle at 1 is open because the inequality is  $<$  not  $\leq$ .

## Now you try

Represent the following inequalities on a number line.

- a  $x \geq 5$                       b  $x < 9$                       c  $3 \leq x < 6$





## PROBLEM-SOLVING

5

5, 6

6, 7

Example 16

- 5 For each of the following descriptions, choose an appropriate inequality from **A–H** below.
- a John is more than 12 years old.
  - b Marika is shorter than 150 cm.
  - c Matthew is at least 5 years old but he is younger than 10.
  - d The temperature outside is between  $-12^{\circ}\text{C}$  and  $10^{\circ}\text{C}$  inclusive.
- A**  $x < 150$                       **B**  $x < 12$                       **C**  $x > 12$                       **D**  $x \leq 150$   
**E**  $10 \leq x \leq -12$               **F**  $-12 \leq x \leq 10$               **G**  $5 \leq x < 10$               **H**  $5 < x \leq 10$
- 6 It is known that Tim's age is between 20 and 25 inclusive, and Nick's age is between 23 and 27 inclusive.
- a If  $t$  = Tim's age and  $n$  = Nick's age, write two inequalities to represent these facts.
  - b Represent both inequalities on the same number line.
  - c Nick and Tim are twins. What is the possible range of their ages? Represent this on a number line.
- 7 At a certain school the following grades are awarded for different scores.

<b>Score</b>	$x \geq 80$	$60 \leq x < 80$	$40 \leq x < 60$	$20 \leq x < 40$	$x < 20$
<b>Grade</b>	A	B	C	D	E

- a Convert the following scores into grades.
  - i 15                      ii 79                      iii 80                      iv 60                      v 30
- b Emma got a B on one test, but her sister Rebecca got an A with just 7 more marks. What is the possible range for Emma's score?
- c Hugh's mark earned him a C. If he had scored half this mark, what grade would he have earned?
- d Alfred and Reuben earned a D and a C respectively. If their scores were added together, what grade or grades could they earn?
- e Michael earned a D and was told that if he doubled his mark he would have a B. What grade or grades could he earn if he got an extra 10 marks?

## REASONING

8

8, 9

9,  $10(\frac{1}{2})$ 

- 8 An inequality statement can be reversed and have the opposite symbol used. For example,  $2 < 5$  is equivalent to  $5 > 2$ , and  $7 \geq 3$  is equivalent to  $3 \leq 7$ .  
 Write an equivalent statement for each of these inequalities.
- a  $2 \leq 8$                       b  $6 > 4$                       c  $3 < x$                       d  $8 \geq y$
- 9 Sometimes multiple inequalities can be combined to form a simpler inequality.
- a Explain why the combination  $x \geq 5$ ,  $x \geq 7$  is equivalent to the inequality  $x \geq 7$ .
  - b Simplify the following pairs of inequalities to a single inequality statement.
    - i  $x > 5$ ,  $x \geq 2$                       ii  $x < 7$ ,  $x < 3$                       iii  $x \geq 1$ ,  $x > 1$
    - iv  $x \leq 10$ ,  $x < 10$                       v  $x > 3$ ,  $x < 10$                       vi  $x > 7$ ,  $x \leq 10$
  - c Simplify the following pairs of inequalities to a single inequality statement.
    - i  $3 < x < 5$ ,  $2 < x < 7$                       ii  $-2 \leq x < 4$ ,  $-2 < x \leq 4$
    - iii  $7 < x \leq 10$ ,  $2 \leq x < 8$                       iv  $5 \leq x < 10$ ,  $9 \leq x \leq 11$

**10** Some inequalities, when combined, have no solutions; some have one solution and some have infinitely many solutions. Label each of the following pairs using 0, 1 or  $\infty$  (infinity) to say how many solutions they have. A number line diagram could be helpful.

**a**  $x \geq 5$  and  $x \leq 5$

**b**  $x > 3$  and  $x < 10$

**c**  $x \geq 3$  and  $x < 4$

**d**  $x > 3$  and  $x < 2$

**e**  $-2 < x < 10$  and  $10 < x < 12$

**f**  $-3 \leq x \leq 10$  and  $10 \leq x \leq 12$

**g**  $x > 2.5$  and  $x \leq 3$

**h**  $x \geq -5$  and  $x \leq -7$

**ENRICHMENT: Working within boundaries**

-

-

11-12(½)

**11** If it is known that  $0 \leq x \leq 10$  and  $0 \leq y \leq 10$ , which of the following inequalities must be true? Justify your answers.

**a**  $x + y \leq 30$

**b**  $2x \leq 20$

**c**  $10 \leq 2y \leq 20$

**d**  $x \times y \leq 100$

**e**  $0 \leq x - y \leq 10$

**f**  $x + 5y \leq 100$

**12** If it is known that  $0 \leq a \leq 10$ ,  $0 \leq b \leq 10$  and  $0 \leq c \leq 10$ , what is the largest value that the following expressions could have?

**a**  $a + b + c$

**b**  $ab + c$

**c**  $a(b + c)$

**d**  $a \times b \times c$

**e**  $a - b - c$

**f**  $a - (b - c)$

**g**  $3a + 4$

**h**  $a - bc$



Bacteria multiply in temperatures  $5^\circ\text{C} \leq T \leq 60^\circ\text{C}$ ; high-risk foods include meat, seafood, eggs and cooked rice. Bacteria hibernate in a freezer,  $T \leq -18^\circ\text{C}$ , or in a fridge,  $T < 5^\circ\text{C}$ . When food is cooked at  $T \geq 75^\circ\text{C}$ , bacteria are killed.

## 7J Solving inequalities

### LEARNING INTENTIONS

- To understand that inequalities can be solved using equivalent inequalities
- To understand that the sign of an inequality is reversed if both sides are multiplied or divided by a negative number
- To understand that the sign of an inequality is reversed if the two sides are switched
- To be able to solve inequalities algebraically

Sometimes a problem arises in which an inequality is more complicated than something such as  $x > 5$  or  $y \leq 40$ . For instance, you could have the inequality  $2x + 4 > 100$ . To **solve** an inequality means to find all the values that make it true. For the inequality above,  $x = 50$ ,  $x = 90$  and  $x = 10000$  are all part of the solution, but the solution is best described as  $x > 48$ , because any number greater than 48 will make this inequality true and any other number makes it false.

The rules for solving inequalities are very similar to those for equations: perform the same operation to both sides. The one exception occurs when multiplying or dividing by a negative number. We can do this, but we must flip the sign because of the following observation.

$$\begin{array}{c} 5 > 2 \\ \times(-1) \quad \quad \quad \times(-1) \\ \curvearrowright \quad \quad \quad \curvearrowleft \\ -5 > -2 \end{array}$$

Incorrect method

$$\begin{array}{c} 5 > 2 \\ \times(-1) \quad \quad \quad \times(-1) \\ \curvearrowleft \quad \quad \quad \curvearrowright \\ -5 < -2 \end{array}$$

Correct method



Manufacturing companies employ financial analysts to determine the number of sales,  $n$ , to make a minimum profit. If an orange juice company makes a profit of \$1.25/bottle, then for \$1000/week minimum profit, solving:  $1.25n \geq 1000$  gives  $n \geq 800$  bottles/week to be sold.

### Lesson starter: Limousine costing

A limousine is hired for a wedding. The charge is a \$50 hiring fee plus \$200 per hour.

- If the total hire time was more than 3 hours, what can you say about the total cost?
- If the total cost is less than \$850 but more than \$450, what can you say about the total time the limousine was hired?

### KEY IDEAS

- Given an inequality, an **equivalent** inequality can be obtained by:
  - adding or subtracting an expression from both sides
  - multiplying or dividing both sides by any positive number
  - multiplying or dividing both sides by a negative number and reversing the inequality symbol

- swapping sides and reversing the inequality symbol.

For example:

$$\begin{array}{c} 2x + 4 < 10 \\ \swarrow -4 \quad \searrow -4 \\ 2x < 6 \\ \swarrow +2 \quad \searrow +2 \\ x < 3 \end{array}$$

$$\begin{array}{c} -4x + 2 < 6 \\ \swarrow -2 \quad \searrow -2 \\ -4x < 4 \\ \swarrow \div (-4) \quad \searrow \div (-4) \\ x > -1 \end{array}$$

Sign is reversed  
multiplying or dividing  
by a negative

$$\begin{array}{c} 2 > x + 1 \\ \swarrow -1 \quad \searrow -1 \\ 1 > x \\ \downarrow \\ x < 1 \end{array}$$

Sign is reversed  
when swapping sides

## BUILDING UNDERSTANDING

- If  $x = 3$ , classify the following inequalities as true or false.
  - $x + 4 > 2$
  - $5x \geq 10$
  - $10 - x < 5$
  - $5x + 1 < 16$
- State whether the following choices of  $x$  make the inequality  $2x + 4 \geq 10$  true or false.
  - $x = 5$
  - $x = 1$
  - $x = -5$
  - $x = 3$

- State the missing number.

$$\begin{array}{c} 2x < 8 \\ \swarrow \div 2 \quad \searrow \div 2 \\ x < \_ \end{array}$$

- What is the solution to the inequality  $2x < 8$ ?

- State the missing numbers.

$$\begin{array}{c} 2x + 4 \geq 10 \\ \swarrow -4 \quad \searrow -4 \\ 2x \geq \_ \\ \swarrow \div 2 \quad \searrow \div 2 \\ x \geq \_ \end{array}$$

- What is the solution to the inequality  $2x + 4 \geq 10$ ?
- If  $x = 7.1328$ , is  $2x + 4 \geq 10$  true or false?



### Example 17 Solving inequalities

Solve the following inequalities.

**a**  $5x + 2 < 47$

**b**  $\frac{3 + 4x}{9} \geq 3$

**c**  $15 - 2x > 1$

#### SOLUTION

**a**

$$\begin{array}{l} 5x + 2 < 47 \\ \begin{array}{c} \text{---} -2 \text{---} \\ \text{---} -2 \text{---} \end{array} \\ 5x < 45 \\ \begin{array}{c} \text{---} +5 \text{---} \\ \text{---} +5 \text{---} \end{array} \\ x < 9 \end{array}$$

**b**

$$\begin{array}{l} \frac{3 + 4x}{9} \geq 3 \\ \begin{array}{c} \text{---} \times 9 \text{---} \\ \text{---} \times 9 \text{---} \end{array} \\ 3 + 4x \geq 27 \\ \begin{array}{c} \text{---} -3 \text{---} \\ \text{---} -3 \text{---} \end{array} \\ 4x \geq 24 \\ \begin{array}{c} \text{---} +4 \text{---} \\ \text{---} +4 \text{---} \end{array} \\ x \geq 6 \end{array}$$

**c**

$$\begin{array}{l} 15 - 2x > 1 \\ \begin{array}{c} \text{---} -15 \text{---} \\ \text{---} -15 \text{---} \end{array} \\ -2x > -14 \\ \begin{array}{c} \text{---} +(-2) \text{---} \\ \text{---} +(-2) \text{---} \end{array} \\ x < 7 \end{array}$$

#### EXPLANATION

The inequality is solved in the same way as an equation is solved: 2 is subtracted from each side and then both sides are divided by 5. The sign does not change throughout.

The inequality is solved in the same way as an equation is solved. Both sides are multiplied by 9 first to eliminate 9 from the denominator.

15 is subtracted from each side.

Both sides are divided by  $-2$ . Because this is a negative number, the inequality is reversed from  $>$  to  $<$ .

#### Now you try

Solve the following inequalities.

**a**  $3x + 6 < 21$

**b**  $\frac{4 + 2x}{3} \leq 2$

**c**  $20 - 3x < 8$

## Exercise 7J

### FLUENCY

1,  $2 - 3(\frac{1}{2})$

$2 - 4(\frac{1}{2})$

$2 - 4(\frac{1}{4}), 5$

Example 17

1 Solve the following inequalities.

**a**  $x + 3 < 7$

**b**  $x - 2 > 9$

**c**  $x + 4 \geq 6$

**d**  $x - 5 \leq 12$

Example 17a

2 Solve the following inequalities.

**a**  $x + 9 > 12$

**b**  $4l + 9 \geq 21$

**c**  $8g - 3 > 37$

**d**  $2r - 8 \leq 6$

**e**  $9k + 3 > 21$

**f**  $8s - 8 < 32$

**g**  $8a - 9 > 23$

**h**  $2 + n \geq 7$

**i**  $9 + 2d \geq 23$

**j**  $8 + 6h < 38$

**k**  $10 + 7r \leq 24$

**l**  $6 + 5y < 26$

Example 17b

3 Solve the following inequalities involving fractions.

a  $\frac{d-9}{2} > 10$

b  $\frac{y+4}{2} \leq 7$

c  $\frac{x-3}{4} > 2$

d  $\frac{q+4}{2} \leq 11$

e  $\frac{2x+4}{3} > 6$

f  $\frac{7+3h}{2} < 5$

g  $\frac{4+6p}{4} \geq 4$

h  $\frac{8j+2}{7} < 6$

Example 17c

4 Solve the following inequalities involving negative numbers. Remember to reverse the inequality when multiplying or dividing by a negative number.

a  $6 - 2x < 4$

b  $24 - 6s \geq 12$

c  $43 - 4n > 23$

d  $34 - 2j < 14$

e  $2 - 9v \leq 20$

f  $2 - 7j \leq 37$

g  $48 - 8c \geq 32$

h  $42 - 8h \leq 42$

i  $7 - 8s > 31$

j  $6 - 8v > 22$

k  $10 - 4v \geq 18$

l  $4 - 5v < 29$

5 Match the following inequalities with their solutions depicted on a number line.

a  $5x + 2 \geq 17$

b  $\frac{x+1}{6} > 3$

c  $9(x+4) < 45$

d  $5 - 2x < 3$

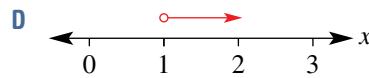
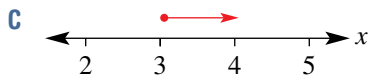
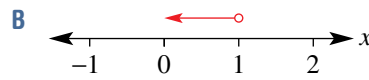
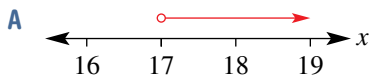

## PROBLEM-SOLVING

6, 7

6, 7

7, 8

- 6 Kartik buys 4 cartons of milk and a \$20 phone card. The total cost of his shopping was greater than \$25.
- If  $c$  is the cost of a carton of milk, write an inequality to describe the situation above.
  - Solve the inequality to find the possible values of  $c$
  - If the milk's cost is a multiple of 5 cents, what is the minimum price it could be?
- 7 In AFL football the score is given by  $6g + b$  where  $g$  is the number of goals and  $b$  is the number of behinds. A team scored 4 behinds and their score was less than or equal to 36.
- Write an inequality to describe this situation.
  - Solve the inequality.
  - Given that the number of goals must be a whole number, what is the maximum number of goals that they could have scored?
- 8 Recall that to convert degrees Celsius to Fahrenheit the rule is  $F = 1.8C + 32$ . Pippa informs you that the temperature is between  $59^\circ$  and  $68^\circ$  Fahrenheit inclusive.
- Solve  $1.8C + 32 \geq 59$ .
  - Solve  $1.8C + 32 \leq 68$ .
  - Hence state the solution to  $59 \leq 1.8C + 32 \leq 68$ , giving your answer as a single inequality.
  - Pippa later realised that the temperatures she gave you should have been doubled – the range was actually  $118^\circ$  to  $136^\circ$  Fahrenheit. State the range of temperatures in Celsius, giving your answer as an inequality.

## REASONING

9

9, 11

10–12

- 9 To say that a number  $x$  is positive is to say that  $x > 0$ .
- If  $10x - 40$  is positive, find all the possible values of  $x$ . That is, solve  $10x - 40 > 0$ .
  - Find all  $k$  values that make  $2k - 6$  positive.
  - If  $3a + 6$  is negative and  $10 - 2a$  is positive, what are the possible values of  $a$ ?
  - If  $5a + 10$  is negative and  $10a + 30$  is positive, what are the possible values of  $a$ ?
- 10
- Prove that if  $5x - 2$  is positive then  $x$  is positive.
  - Prove that if  $2x + 6$  is positive then  $x + 5$  is positive.
  - Is it possible that  $10 - x$  is positive and  $10 - 2x$  is positive but  $10 - 3x$  is negative? Explain.
  - Is it possible that  $10 - x$  is positive and  $10 - 3x$  is positive but  $10 - 2x$  is negative? Explain.
- 11 A puzzle is given below with four clues.
- Clue A:  $3x > 12$       Clue B:  $5 - x \leq 4$       Clue C:  $4x + 2 \leq 42$       Clue D:  $3x + 5 < 36$
- Two of the clues are unnecessary. State which two clues are not needed.
  - Given that  $x$  is a whole number divisible by 4, what is the solution to the puzzle?
- 12 Multiplying or dividing by a negative number can be avoided by adding the variable to the other side of the equation. For example:

$$\begin{array}{c}
 -4x + 2 < 6 \\
 \begin{array}{c} \text{+4x} \quad \text{+4x} \\ \curvearrowright \quad \curvearrowleft \end{array} \\
 2 < 6 + 4x \\
 \begin{array}{c} \text{-6} \quad \text{-6} \\ \curvearrowleft \quad \curvearrowright \end{array} \\
 -4 < 4x \\
 \begin{array}{c} \text{+4} \quad \text{+4} \\ \curvearrowleft \quad \curvearrowright \end{array} \\
 -1 < x
 \end{array}$$

This can be rearranged to  $x > -1$ , which is the same as the answer obtained using the method shown in the **Key ideas**. Use this method to solve the following inequalities.

- a  $-5x + 20 < 10$       b  $12 - 2a \geq 16$       c  $10 - 5b > 25$       d  $12 < -3c$

## ENRICHMENT: Pronumerals on both sides

-

-

 $13\frac{1}{2}$ 

- 13 This method for solving inequalities allows both sides to have any expression subtracted from them. This allows us to solve inequalities with pronumerals on both sides. For example:

$$\begin{array}{c}
 12x + 5 \leq 10x + 11 \\
 \begin{array}{c} \text{-10x} \quad \text{-10x} \\ \curvearrowleft \quad \curvearrowright \end{array} \\
 2x + 5 \leq 11
 \end{array}$$

which can then be solved as usual. If we end up with a pronumeral on the right-hand side, such as  $5 < x$ , the solution is rewritten as  $x > 5$ .

Solve the following inequalities.

- a  $12x + 5 \leq 10x + 11$       b  $7a + 3 > 6a$       c  $5 - 2b \geq 3b - 35$   
d  $7c - 5 < 10c - 11$       e  $14k > 200 + 4k$       f  $9g + 40 < g$   
g  $4(2a + 1) > 7a + 12$       h  $2(3k - 5) \leq 5k - 1$       i  $2(3p + 1) > 4(p + 2) + 3$



## Wedding marquee

Natasha and Mark wish to hire marquees for their wedding reception. They need to hire the marquees for a number of days to allow for the preparation, the reception itself and the pack up. The local supplier charges a fixed amount per marquee that covers the setting up and packing up of the marquee, as well as a cost per day to hire. The rates are shown in the table.

Type	Total set-up and pack-up fee	Fee per day
Small	\$200	\$600
Large	\$620	\$1140

Natasha and Mark think that two small marquees or one large marquee will provide enough room for their guests. The marquee company only accepts the hiring of marquees for a whole number of days.

*Present a report for the following tasks and ensure that you show clear mathematical workings and explanations where appropriate.*

### Preliminary task

- Determine the cost of hiring one large marquee for:
  - 2 days
  - 5 days.
- Determine the cost of hiring two small marquees (the setting up and packing up fee of \$200 must be paid on both marquees) for:
  - 2 days
  - 5 days.
- If Natasha and Mark only require the marquees for 3 days, would it be cheaper to hire one large marquee or two small marquees?

### Modelling task

- |                            |  |
|----------------------------|--|
| <b>Formulate</b>           | <ol style="list-style-type: none"> <li>The problem is to determine the cheapest marquee option for Natasha and Mark's wedding, depending on the number of days the marquees are required. Write down all the relevant information that will help solve this problem.</li> <li>Construct a formula for the cost (\$C) of hiring the following for <math>n</math> days:               <ol style="list-style-type: none"> <li>2 small marquees</li> <li>1 large marquee.</li> </ol> </li> </ol> |
| <b>Solve</b>               | <ol style="list-style-type: none"> <li>Solve an equation to find the number of days Mark and Natasha can hire:               <ol style="list-style-type: none"> <li>1 large marquee using \$5180</li> <li>2 small marquees using \$7600.</li> </ol> </li> <li>Solve an equation that determines the <math>n</math> value for which the cost for hiring two small marquees is the same as that for one large marquee.</li> </ol>  |
| <b>Evaluate and verify</b> | <ol style="list-style-type: none"> <li>By noting that the marquee company only hires out marquees for a whole number of days, determine the number of days that they can hire for so that the single large marquee is the cheaper option.</li> </ol>   |
| <b>Communicate</b>         | <ol style="list-style-type: none"> <li>Summarise your results and describe any key findings.</li> </ol>  |

### Extension questions

- The marquee company wishes to make the cost of hiring two small marquees for three days the same as hiring one large marquee for three days. Describe how they could achieve this by:
  - changing the set-up and pack-up fee for the large marquee
  - changing the daily fee for the large marquee.
- For a large food festival that lasts many days, Natasha and Mark are deciding between 25 small marquees or 13 large marquees (at the original prices in the table on the previous page). Describe which option they should choose based on how long the festival lasts.

## The 6 metre benchtop

### Key technology: Spreadsheets

A kitchen company produces special stone benchtops including a rectangular island with a semicircular end.

One of their island benchtops includes a rectangle of length 2 metres and perimeter 6 metres as shown.

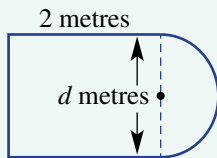

### 1 Getting started

- We know that the circumference of a circle is given by  $C = \pi d$ . Use this information to find the perimeter of a benchtop if the diameter,  $d$  metres, is the following. Round your answers correct to one decimal place.
  - 1 metre
  - 2 metres
  - 0.7 metres
- Knowing that the perimeter of the benchtop for this kitchen company is 6 metres, use trial and error to find the value of  $d$  correct to one decimal place.
- Explain why the equation that relates to what we are finding in part **b** is  $d + 4 + \frac{1}{2}\pi d = 6$ .

### 2 Using technology

The equation above can be solved with a high degree of accuracy using a spreadsheet.

- Enter the given information into a spreadsheet.
- Fill down at cells A6, B5 and C5 until the perimeter is beyond 6 metres.
- Which value of  $d$  gives the perimeter which is closest to 6 metres? What is the percentage error shown in this case?

	A	B	C
1	<b>Stone benchtops</b>		
2			
3	<b><math>d</math></b>	<b>Perimeter</b>	<b>Percentage error</b>
4			
5	0.1	=A5+4+0.5*PI()*A5	=ABS(6-B5)/6*100
6	=A5+0.1		
7			

### 3 Applying an algorithm

To obtain a more accurate solution for the value of  $d$  that gives a 6-metre perimeter, we will apply this algorithm.

- Step 1: Change the starting number in cell A5 to be closer to the solution for  $d$ .
- Step 2: Change the increment in cell A6 to a smaller number. Suggest 0.01, 0.001 etc.
- Step 3: Fill down until the perimeter is beyond 6 metres.
- Step 4: Choose the value of  $d$  that gives a perimeter closest to 6 metres and has the smallest percentage error.
- Step 5: Repeat from Step 1.
  - a Apply this algorithm until you are satisfied that you have found the solution for  $d$ , correct to two decimal places.
  - b Persist with your algorithm to now find the solution for  $d$ , correct to three or even four decimal places.

	A	B	C
1	Stone benchtops		
2			
3	$d$	Perimeter	Percentage error
4			
5	0.77	5.979513172	0.341447139
6	0.771	5.982083968	0.298600534
7	0.772	5.984654764	0.255753929
8	0.773	5.987225561	0.212907323
9	0.774	5.989796357	0.170060718
10	0.775	5.992367153	0.127214112
11	0.776	5.99493795	0.084367507
12	0.777	5.997508746	0.041520901
13	0.778	6.000079542	0.001325704
14	0.779	6.002650339	0.04417231
15	0.78	6.005221135	0.087018915
16	0.781	6.007791931	0.12986552

### 4 Extension

- a Modify your spreadsheet so that it can solve a similar problem for a different perimeter. Describe your problem and use your spreadsheet to find the value of  $d$ , correct to three decimal places.
- b Use algebraic techniques to solve the equation studied above for  $d$ . The equation was  $d + 4 + \frac{1}{2}\pi d = 6$ . Your answer should be in terms of  $\pi$ . (*Hint:* Simplify the equation and factorise out the  $d$ .) Check that your result agrees with your value of  $d$  found in part 3 above.
- c Explore a similar problem where the perimeter,  $P$ , can vary as well as the length,  $l$ , of the rectangle part of the benchtop. Create a spreadsheet that can cater for both variables.
- d Use algebraic techniques to solve the equation formed in part c. Your answer should be in terms of  $\pi$ ,  $l$  and  $P$ .

## Tiling a pool edge

The Sunny Swimming Pool Company constructs rectangular pools each 4 m wide with various lengths. There are non-slip square tiles, 50 cm by 50 cm, that can be used for the external edging around the pool perimeter where swimmers walk.

- 1 Draw a neat diagram illustrating the pool edge with one row of flat tiles bordering the perimeter of a rectangular pool 4 m wide and 5 m long.
- 2 Develop a table showing the dimensions of rectangular pools each of width 4 m and ranging in length from 5 m to 10 m. Add a column for the total number of tiles required for each pool when one row of flat tiles borders the outside edge of the pool.
- 3 Develop an algebraic rule for the total number of tiles,  $T$ , required for bordering the perimeter of rectangular pools that are 4 m wide and  $x$  m long.
- 4
  - a Use your algebraic rule to form equations for each of the following total number of tiles when a single row of flat tiles is used for pool edging.
    - i 64 tiles
    - ii 72 tiles
    - iii 80 tiles
    - iv 200 tiles
  - b By manually solving each equation, determine the lengths of the various pools that use each of the above numbers of tiles.
- 5 Develop an algebraic rule for the total number of tiles,  $T$ , required for two rows of flat tiles bordering rectangular pools that are 4 m wide and  $x$  m long.
- 6
  - a Use your algebraic rule to form equations for each of the following total numbers of tiles when two rows of flat tiles are used for pool edging.
    - i 96 tiles
    - ii 120 tiles
    - iii 136 tiles
    - iv 248 tiles
  - b By manually solving each equation, determine the lengths of the pools that use these numbers of tiles.
- 7 Determine an algebraic rule for the total number of tiles,  $T$ , required for  $n$  rows of flat tiles bordering rectangular pools that are 4 m wide and  $x$  m in length.
- 8 Use this algebraic rule to form equations for each of the following pools, and then manually solve each equation to determine the length of each pool.

Pool	Width of pool 4 m	Length of pool $x$ m	Number of layers $n$	Total number of tiles $T$
A	4		3	228
B	4		4	228
C	4		5	500



1 Find the unknown value in the following problems.

- A number is increased by 2, then doubled, then increased by 3 and then tripled. The result is 99.
- A number is doubled and then one-third of the number is subtracted. The result is 5 larger than the original number.
- In five years' time, Alf will be twice as old as he was two years ago. How old is Alf now?
- The price of a shirt is increased by 10% for GST and then decreased by 10% on a sale. The new price is \$44. What was the original price?
- One-third of a number is subtracted from 10 and then the result is tripled, giving the original number back again.
- The sides of a quadrilateral are four consecutive integers. If the longest side is 26% of the perimeter, find the perimeter.

Up for a challenge? If you get stuck on a question, check out the 'Working with unfamiliar problems' poster at the end of the book to help you.



2 Consider the 'proof' that  $0 = 1$  shown at right.

- Which step caused the problem in this proof? (*Hint*: Consider the actual solution to the equation.)
- Prove that  $0 = 1$  is equivalent to the equation  $22 = 50$  by adding, subtracting, multiplying and dividing both sides.

$$\begin{array}{c}
 2x + 5 = 3x + 5 \\
 \begin{array}{c} \curvearrowleft -5 \quad \quad \quad \curvearrowright -5 \end{array} \\
 2x = 3x \\
 \begin{array}{c} \curvearrowleft +x \quad \quad \quad \curvearrowright +x \end{array} \\
 2 = 3 \\
 \begin{array}{c} \curvearrowleft -2 \quad \quad \quad \curvearrowright -2 \end{array} \\
 0 = 1
 \end{array}$$

3 Find all the values of  $x$  that would make both these inequalities false.

$$19 - 2x < 5 \text{ and } 20 + x > 4x + 2$$

4 The following six expressions could appear on either side of an equation. Using just two of the expressions, create an equation that has no solution.

$$2x \quad 3x + 1 \quad 7x + 4 \quad 4(x + 7) \quad 2 + 3(x + 1) \quad 2(3 + x) - 1$$

5 A certain pair of scales only registers weights between 100 kg and 150 kg, but it allows more than one person to get on at a time.

- If three people weigh themselves in pairs and the first pair weighs 117 kg, the second pair weighs 120 kg and the third pair weighs 127 kg, what are their individual weights?
- If another three people weigh themselves in pairs and get weights of 108 kg, 118 kg and 130 kg, what are their individual weights?
- A group of four children who all weigh less than 50 kg weigh themselves in groups of three, getting the weights 122 kg, 128 kg, 125 kg and 135 kg. How much do they each weigh?

6 Each link in a chain has an outer length of 44 mm and is made of wire 4 mm thick.

- Find the greatest length (in mm) of a chain with 5 links.
- Determine an expression for the greatest length  $L$  (in mm) of a chain with  $n$  links.
- Find the smallest number of links required to make a chain with length greater than 7 metres.

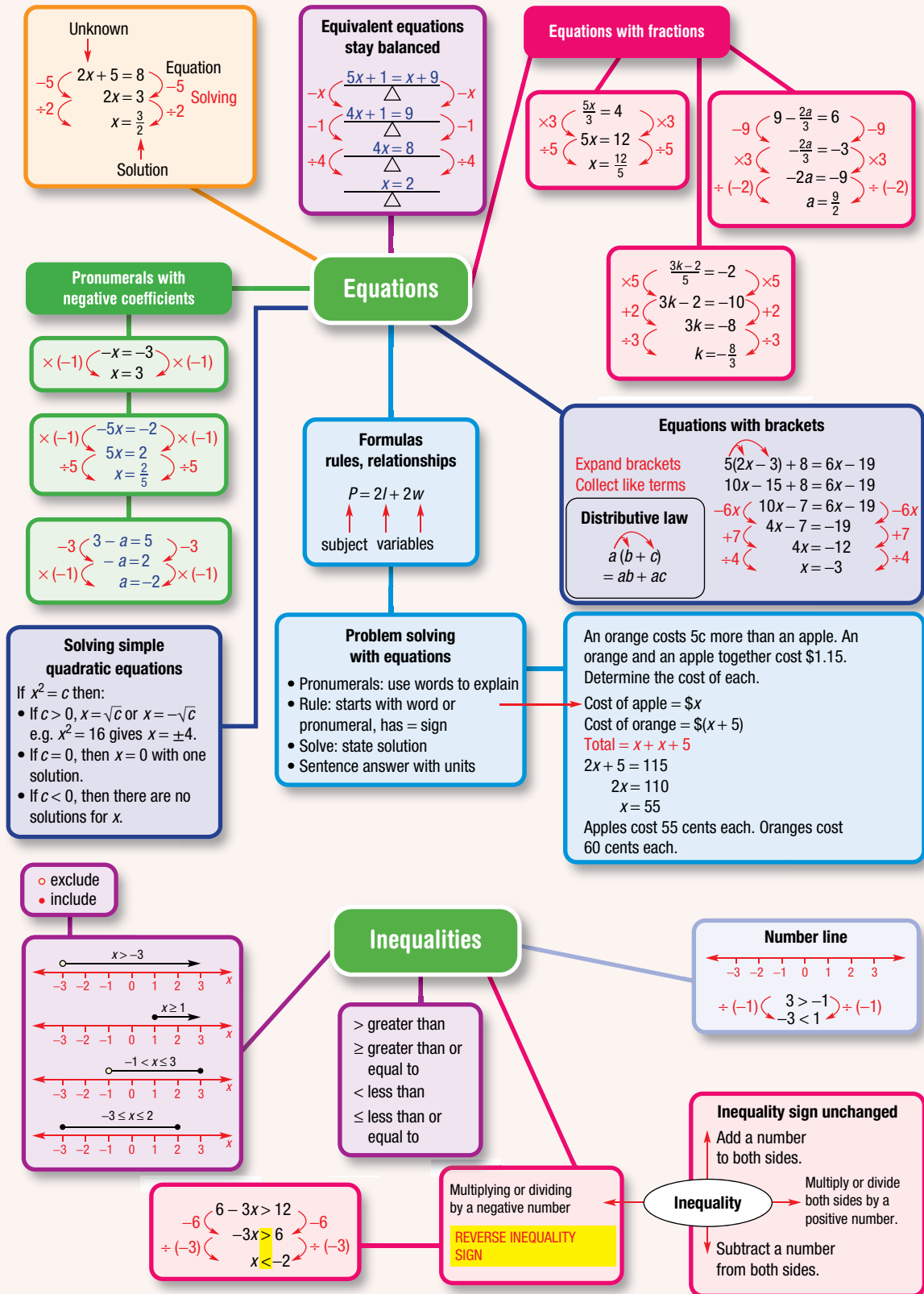

# Chapter checklist with success criteria

A printable version of this checklist is available in the Interactive Textbook



7A	<b>1. I can classify equations as true or false.</b> e.g. State whether the equation $x + 20 = 3 \times x$ is true or false if $x = 10$ .	<input type="checkbox"/>
7A	<b>2. I can write an equation from a description.</b> e.g. Write an equation for the following scenario: The number $k$ is doubled, then three is added and the result is 52.	<input type="checkbox"/>
7B	<b>3. I can find equivalent equations.</b> e.g. Show the result of adding 3 to both sides of the equation $5a - 3 = 12$ .	<input type="checkbox"/>
7B	<b>4. I can solve simple equations algebraically and check my solution.</b> e.g. Solve $2u + 7 = 17$ algebraically and check the solution by substitution.	<input type="checkbox"/>
7C	<b>5. I can solve equations involving algebraic fractions.</b> e.g. Solve $\frac{4y + 15}{9} = 3$ and $7 - \frac{2x}{3} = 5$ algebraically.	<input type="checkbox"/>
7D	<b>6. I can solve equations with pronumerals on both sides.</b> e.g. Solve $6x + 4 = 22 - 3x$ algebraically.	<input type="checkbox"/>
7E	<b>7. I can solve equations with brackets by expanding and collecting like terms.</b> e.g. Solve $4(2x - 5) + 3x = 57$ .	<input type="checkbox"/>
7F	<b>8. I can solve a simple quadratic equation.</b> e.g. Solve $x^2 = 9$ and $3x^2 = 21$ (to two decimal places).	<input type="checkbox"/>
7F	<b>9. I can state the number of solutions to a simple quadratic equation.</b> e.g. State the number of solutions for $x$ in the following equations: $x^2 = 0$ , $x^2 = -3$ and $x^2 = 16$ .	<input type="checkbox"/>
7G	<b>10. I can apply a formula to find unknown values.</b> e.g. Apply the formula for a rectangle's perimeter, $P = 2l + 2w$ , to find the value of $l$ when $P = 40$ and $w = 3$ .	<input type="checkbox"/>
7H	<b>11. I can solve problems using equations.</b> e.g. The weight of 6 identical books is 1.2 kg. Set up and solve an equation to find the weight of one book.	<input type="checkbox"/>
7H	<b>12. I can solve harder problems using equations.</b> e.g. Purchasing 5 apples and a \$2.40 mango costs the same as purchasing 7 apples and a 60 cent mandarin. What is the cost of each apple?	<input type="checkbox"/>
7I	<b>13. I can represent an inequality on a number line.</b> e.g. Represent $1 < x \leq 5$ on a number line.	<input type="checkbox"/>
7I	<b>14. I can use inequalities to describe real-life situations.</b> e.g. Fred is shorter than 160 cm. Describe this as an inequality, using $x$ to stand for Fred's height in cm.	<input type="checkbox"/>
7J	<b>15. I can solve inequalities algebraically.</b> e.g. Solve $15 - 2x > 1$ algebraically.	<input type="checkbox"/>

## Short-answer questions

7A

- 1 Classify each of the following as true or false.

- a If  $3x = 6$ , then  $x = 3$ .  
b If  $a = 21$ , then  $a + a - a = a$ .  
c  $5 \times 4 = 10 + 10$

7B

- 2 Find the solutions to these equations.

- a  $4m = 16$                       b  $\frac{m}{3} = -4$                       c  $9 - a = 10$   
d  $10m = 2$                       e  $2m + 6 = 36$                       f  $a + a = 12$

7A

- 3 Write an equation to represent each of the following statements. You do not need to solve the equations.

- a Double  $m$  plus 3 equals three times  $m$ .  
b The sum of  $n$  and four is multiplied by five; the answer is 20.  
c The sum of two consecutive even numbers, the first being  $x$ , is 74.

7B

- 4 For each equation below, state the first operation you would apply to both sides.

- a  $15 + 2x = 45$                       b  $\frac{x}{2} - 5 = 6$                       c  $3a + 3 = 2a + 10$

7B

- 5 Solve the following equations.

- a  $a + 8 = 12$                       b  $6 - y = 15$                       c  $2x - 1 = -9$   
d  $5 + 3x = 17$                       e  $20 - 4x = 12$                       f  $8a - 8 = 0$

7C

- 6 Solve the following equations algebraically.

- a  $\frac{m}{3} = -2$                       b  $\frac{5x}{2} = 20$                       c  $\frac{-2y}{3} = 12$   
d  $\frac{k+3}{11} = -5$                       e  $\frac{8-2w}{3} = 4$                       f  $\frac{2a-8}{6} = 13$

7C

- 7 Solve these equations including fractions.

- a  $2 = \frac{x+2}{8}$                       b  $\frac{x}{6} + 2 = 3$                       c  $\frac{2x-10}{7} = 10$

7D

- 8 Solve these equations.

- a  $8a - 3 = 7a + 5$                       b  $2 - 3m = m$                       c  $3x + 5 = 7x - 11$   
d  $10 - 4a = a$                       e  $2x + 8 = x$                       f  $4x + 9 = 5x$

7E

- 9 Solve the following equations by first expanding the brackets.

- a  $2(x + 5) = 16$                       b  $3(x + 1) = -9$   
c  $18 = -2(2x - 1)$                       d  $3(2a + 1) = 27$   
e  $5(a + 4) = 3(a + 2)$                       f  $2(3m + 5) = 16 + 3(m + 2)$   
g  $8(3 - a) + 16 = 64$                       h  $2x + 10 = 4(x - 6)$   
i  $4(2x - 1) - 3(x - 2) = 10x - 3$

7F

- 10 For each of the following equations, state the number of solutions for
- $x$
- and find the solutions, if any. Round your answer in part d, correct to one decimal place.

- a  $x^2 = 36$                       b  $x^2 = 0$                       c  $x^2 = -2$                       d  $3x^2 = 30$



7G

- 11 a If  $P = 2(I + b)$ , find  $I$  when  $P = 48$  and  $b = 3$ .  
 b If  $M = \frac{f}{f-d}$ , find  $M$  when  $f = 12$  and  $d = 8$ .  
 c If  $F = 2.5c + 20$ , find  $c$  when  $F = 30$ .  
 d Find the value of  $x$  and  $y$  for this rectangle.

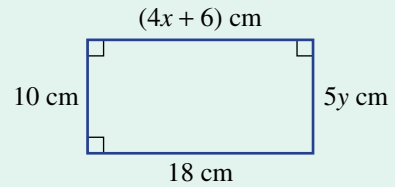

7H

- 12 a The sum of three consecutive numbers is 39. First, write an equation and then find the value of the smallest number.  
 b Four times a number less 5 is the same as double the number plus 3. Write an equation and then find the number.  
 c The difference between a number and three times that number is 17. What is the number?

7I

- 13 Write the inequality represented by each number line below.

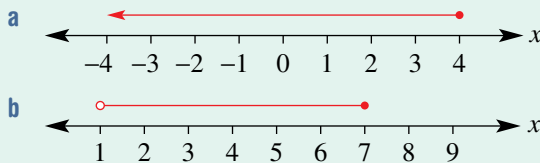

7I

- 14 Represent the following inequalities on separate number lines.

- |               |                   |                      |
|---------------|-------------------|----------------------|
| a $x \leq -1$ | b $x > 2$         | c $x < -1$           |
| d $x \geq -2$ | e $1 > x$         | f $-3 \leq x$        |
| g $x < 7$     | h $-2 < x \leq 4$ | i $-1 \leq x \leq 1$ |

7I

- 15 Write an inequality to represent these situations, where  $x$  is the unknown value.

- a The profit of a company is at least \$100 000.  
 b The cost of a new car cannot exceed \$6700.  
 c To ride on the roller-coaster, a person's height must be between 1.54 m and 1.9 m inclusive.

7J

- 16 Solve the following inequalities.

- |                       |                        |                            |
|-----------------------|------------------------|----------------------------|
| a $x + 3 > 5$         | b $x - 2 < 6$          | c $x - 2 < -6$             |
| d $6x \geq 12$        | e $4x < -8$            | f $\frac{x}{4} \geq 2$     |
| g $\frac{2x}{3} < -8$ | h $\frac{2x+1}{3} > 9$ | i $\frac{6-5x}{4} \leq -1$ |

## Multiple-choice questions

7A

- 1 Which one of the following equations is true?

- |                                       |                                      |                                     |
|---------------------------------------|--------------------------------------|-------------------------------------|
| A $20 \div (2 \times 5) = 20 \div 10$ | B $12 - 8 = 2$                       | C $5 \div 5 \times 5 = \frac{1}{5}$ |
| D $15 + 5 \times 4 = 20 + 4$          | E $10 - 2 \times 4 = 4 \times 2 - 5$ |                                     |

7A

- 2 Which one of the following equations does not have the solution  $x = 9$ ?

- |               |                |                     |
|---------------|----------------|---------------------|
| A $4x = 36$   | B $x + 7 = 16$ | C $\frac{x}{3} = 3$ |
| D $x + 9 = 0$ | E $14 - x = 5$ |                     |

7B

- 3 The solution to the equation  $3a + 8 = 29$  is:

- |            |                       |           |
|------------|-----------------------|-----------|
| A $a = 21$ | B $a = 12\frac{1}{3}$ | C $a = 7$ |
| D $a = 18$ | E $a = 3$             |           |

7H

- 4 'Three less than half a number is the same as four more than the number' can be expressed as an equation by:

A  $\frac{x}{2} - 3 = 4x$                       B  $\frac{(x-3)}{2} = x + 4$                       C  $\frac{x}{2} - 3 = x + 4$

D  $\frac{x}{2} + 3 = x + 4$                       E  $\frac{x}{2} - 3 + 4$

7E

- 5 The solution to the equation  $-3(m+4) = 9$  is:

A  $m = 7$                                       B  $m = -7$                                       C  $m = -1$

D  $m = 1$                                       E  $m = -3$

7D

- 6 If  $12 + 2x = 4x - 6$ , then  $x$  equals:

A 8                                      B 9                                      C 12                                      D 15                                      E 23

7I

- 7 If  $\square < -4$ , then  $\square$  could have the value:

A 0                                      B  $-\frac{1}{4}$                                       C -3                                      D -5                                      E 3

7A

- 8 Which one of the following equations has the solution  $n = 10$ ?

A  $4 - n = 6$                                       B  $2n + 4 = 3n + 5$                                       C  $50 - 4n = 90$

D  $2(n+5) = 3(n+1)$                                       E  $70 - 6n = n$

7B

- 9 Malcolm solves an equation as follows:

$5 - 2x + 4 = 11$  line 1

$1 - 2x = 11$  line 2

$-2x = 10$  line 3

$x = -5$  line 4

Choose the correct statement.

- A The only mistake was made in moving from line 1 to line 2.  
 B The only mistake was made in moving from line 2 to line 3.  
 C The only mistake was made in moving from line 3 to line 4.  
 D A mistake was made in moving from line 1 to line 2 and from line 3 to line 4.  
 E No mistakes were made.

7H

- 10 The value of  $x$  in this isosceles triangle is:

- A 30  
 B 45  
 C 62.5  
 D 65  
 E 130

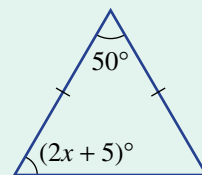

## Extended-response questions

- 1 To upload an advertisement to the [www.searches.com.au](http://www.searches.com.au) website costs \$20 and then 12 cents whenever someone clicks on it.
- Write a formula relating the total cost (\$ $S$ ) and the number of clicks ( $n$ ) on the advertisement.
  - If the total cost is \$23.60, write and solve an equation to find out how many times the advertisement has been clicked on.
  - To upload to the [www.yousearch.com.au](http://www.yousearch.com.au) website costs \$15 initially and then 20 cents for every click. Write a formula for the total cost \$ $Y$  when the advertisement has been clicked  $n$  times.

- d** If a person has at most \$20 to spend, what is the maximum number of clicks they can afford on their advertisement at yousearch.com.au?
- e** Set up and solve an equation to find the minimum number of clicks for which the total cost of posting an advertisement to searches.com.au is less than the cost of posting to yousearch.com.au.
- 2** Mahni plans to spend the next 12 weeks saving some of her income. She will save \$ $x$  a week for the first 6 weeks and then \$ $(2x - 30)$  a week for the following 6 weeks.
- a** Write an expression for the total amount saved over the 12 weeks.
- b** If she managed to save \$213 in the first six weeks, how much did she save:
- i** in the first week?
  - ii** in the 7th week?
  - iii** in total over the 12 weeks?
- c** If Mahni wants to save a total of \$270, write and solve an equation to find out how much she would have to save in the first week.
- d** If Mahni wants to save the same amount in the first 6 weeks as in the last 6 weeks, how much would she save each week?
- e** In the end, Mahni decides that she does not mind exactly how much she saves but wants it to be between \$360 and \$450. State the range of  $x$ -values that would achieve this goal, giving your answer as an inequality.



# 8

## Probability and statistics

### Maths in context: Measuring Australia's cultural diversity

Every 5 years the ABS (Australian Bureau of Statistics) takes a census asking some questions of everyone in the population. The census data is statistically analysed and one of its stories is how our ethnic diversity is changing.

Australia's first census in 1911 showed 17.7% of Australians were born overseas. This dropped to 9.8% during the world wars. By 2021, 27.6% of the population were born overseas, just over 7 million people.

In the 20th century, migrants were mostly from the United Kingdom. In fact, over 1 million migrants from the UK came to Australia between 1947 and 1981. Then between 2006 and 2021, 3.3 million migrants came to Australia and 27.1% were born in China or India.

In 2021, immigrants who reported speaking a language other than English at home included speakers of Hindi, Tagalog, Khmer, Vietnamese, Hazaraghi, Chaldean Neo-Aramaic, Korean, Assyrian Neo-Aramaic, Mandarin, Burmese, Dari, Cantonese, Afrikaans, Dutch, German and Filipino, among many others.

In 2021, the top five countries of birth, by number and % of whole population, were England (3.6%), India (2.6%), China (2.2%), New Zealand (2.1%), and Philippines (1.2%). The census data allows Australians to better understand and provide support for our 278 cultural and ethnic groups.

Source: Data from ABS: *Cultural diversity of Australia*, Released 20/09/2022



## Chapter contents

- 8A Interpreting graphs and tables (CONSOLIDATING)
- 8B Frequency tables and tallies (CONSOLIDATING)
- 8C Graphs of frequency tables
- 8D Measures of centre
- 8E Measures of spread (EXTENDING)
- 8F Surveying and sampling
- 8G Probability
- 8H Two-step experiments
- 8I Tree diagrams
- 8J Venn diagrams and two-way tables
- 8K Experimental probability

## Victorian Curriculum 2.0

This chapter covers the following content descriptors in the Victorian Curriculum 2.0:

### STATISTICS

VC2M8ST01, VC2M8ST02, VC2M8ST03, VC2M8ST04

### PROBABILITY

VC2M8P01, VC2M8P02, VC2M8P03

### ALGEBRA

VC2M8A04

Please refer to the curriculum support documentation in the teacher resources for a full and comprehensive mapping of this chapter to the related curriculum content descriptors.

© VCAA

## Online resources

A host of additional online resources are included as part of your Interactive Textbook, including HOTmaths content, video demonstrations of all worked examples, auto-marked quizzes and much more.

## 8A Interpreting graphs and tables CONSOLIDATING

### LEARNING INTENTIONS

- To know the meaning of the terms numerical, categorical, discrete and continuous
- To be able to interpret column graphs, line graphs and pie charts
- To be able to interpret data presented in a table

Statistics give us a way to understand many parts of our world, from weather patterns to outcomes of horse races. By taking a large amount of data, people can understand complicated principles and even predict the future with high accuracy. Graphs and tables are the most common way to represent data that has been collected.



Fitness app designers use pie charts and line and column graphs to display data such as step count, cycling and running distances. Most home power bills also include a column graph displaying the home's previous 12 months of power usage.

### Lesson starter: Representing results as graphs and tables

A number of people are surveyed about how many pets they have. They give the following results:

4, 0, 2, 2, 3, 1, 2, 5, 1, 4, 2, 1, 1, 0, 0, 2, 0, 3, 1, 2

- How could these results be put into a table to make them easier to understand?
- Try to represent the results in a graph. It could be a pie chart (sector graph), a column graph or some other type of graph you have seen.
- Compare your graph with those of classmates and discuss why the graph is easier to understand than the original list of results.

### KEY IDEAS

- Data can be **numerical** or **categorical**.
  - Numerical data can either be **discrete** (can only be particular numerical values) or **continuous** (can be any numerical value in a range).
  - Categorical data is non-numerical data that can be grouped into 'categories'.
- Data can be represented as a graph or a table.

Common types of graphs include:

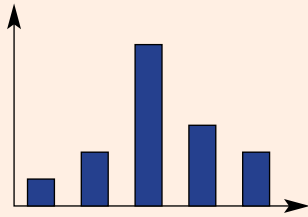

Column graphs

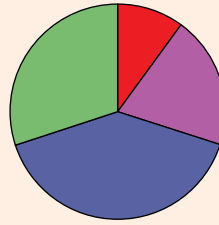

Pie charts (also called sector graphs)

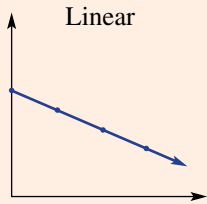

Line graphs

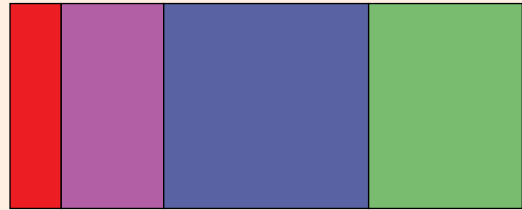
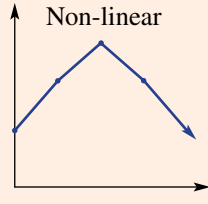

Divided bar graphs

## BUILDING UNDERSTANDING

1 The following table shows the population of some small towns over a 10-year period.

Year	Expton	Calcville	Statsland
2005	400	200	300
2010	320	240	310
2015	180	270	290

- What was the population of Expton in 2010?
- What was the population of Calcville in 2015?
- What was the population of Statsland in 2005?
- Which town's population decreased over time?
- Which town's population increased over time?



### Example 1 Interpreting column graphs

This column graph represents the annual income of five different people.

- What is Aruvin's annual income?
- What is the difference between Jami's income and Ashdev's income?
- Who earns the most?

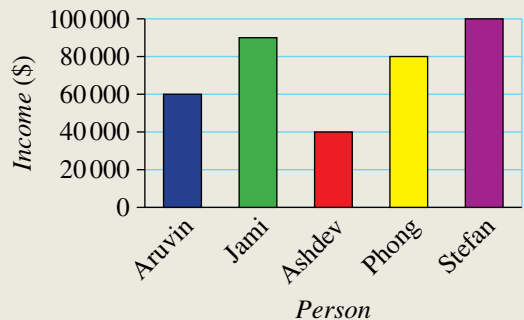

Continued on next page

**SOLUTION**

- a** \$60 000
- b**  $90\,000 - 40\,000 = \$50\,000$
- c** Stefan earns the most.

**EXPLANATION**

Reading off the graph, Aruvin earns \$60 000.

Jami earns \$90 000 and Ashdev earns \$40 000, so the difference is \$50 000.

With the highest column, Stefan earns the most (\$100 000).

**Now you try**

The column graph on the previous page represents the annual income of five different people.

- a** What is Phong's annual income?
- b** What is the difference between Stefan's income and Jami's income?
- c** Who earns the least?

**Example 2 Interpreting pie charts**

A car owner graphs the amount of money spent per year on car-related expenses.

- a** What is the largest expense each year?
- b** What percentage of the car's expenses is devoted to maintenance?
- c** If the car owner spends \$3000 per year on petrol, what is the total amount spent on the car each year?

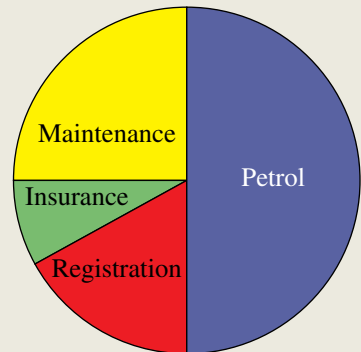
**SOLUTION**

- a** Petrol
- b** 25%
- c**  $50\%$  of expenses = \$3000  
 $\times 2$   $\times 2$   
 $100\%$  of expenses = \$6000
- The car owner spends \$6000 each year.

**EXPLANATION**

Since petrol occupies the largest area of the graph, it is the largest expense.

Maintenance occupies  $\frac{1}{4}$  of the chart's area, which equals 25%.

Petrol occupies half the chart's area, which is 50%. This is doubled to find the total amount spent.

Alternatively, calculate  $\$3000 \div \frac{1}{2} = \$6000$ .



**Now you try**

The pie chart on the previous page shows the amount of money spent per year on car-related expenses.

- a What is the smallest expense each year?
- b What percentage of the car’s expenses is devoted to petrol?
- c If the car owner spends \$1200 per year on maintenance, what is the total amount spent on the car each year?

**Exercise 8A**

**FLUENCY**

1, 3, 4-6

2-7

4-7

Example 1

- 1 This column graph represents the population of five small villages.
- a What is the population of Delant?
  - b What is the difference between Wilber’s population and Bronnen’s population?
  - c Which village has the smallest population?

**Village’s populations**

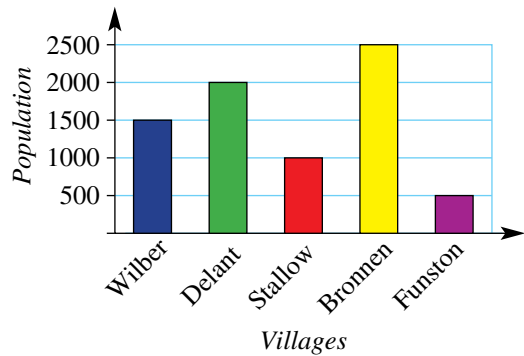

Example 1

- 2 The column graph shows the age of five children.
- a How old is Peta?
  - b How old is Kris?
  - c Who is the oldest of the five children?
  - d Who is the youngest of the five children?
  - e What is the difference in age between Tsets and Nyree?

**Children’s ages**

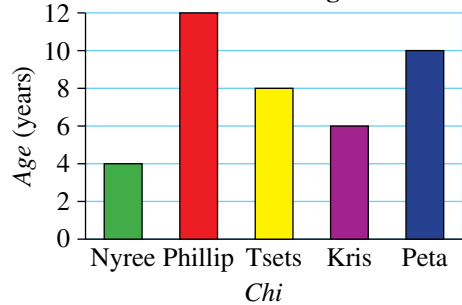

- 3 Six Year 8 classes are asked to vote for which sport they would like to do next in Physical Education. Their results are shown in the table.
- a How many students in 8B want to do water polo?
  - b What is the most popular sport in 8C?
  - c How many students are in 8F?
  - d If the teachers decide all of Year 8 will do badminton, which class will this please the most?
  - e Which sport had the most votes in total?

Sport	8A	8B	8C	8D	8E	8F
Badminton	3	5	7	0	8	12
Water polo	9	9	8	14	11	9
Handball	12	10	11	11	7	3

- 4 The line graph shows the height of Slesha and her twin brother Ross from the time they were born.
- Which of the children was taller on their first birthday?
  - Which of the children was taller on their eighth birthday?
  - How old were the children when they were the same height?
  - Would you describe the general shape of the graphs as linear (straight line) or non-linear?

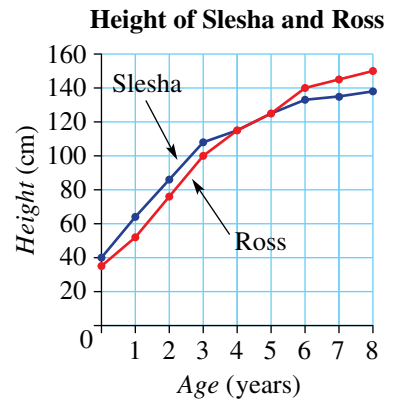

Example 2

- 5 This pie chart shows one person's spending in a month.
- What is the largest expense in that month?
  - What is the smallest expense in that month?
  - What percentage of the month's spending was on rent?
  - If the person spent a total of \$600 on food in the month, what was their total spending?

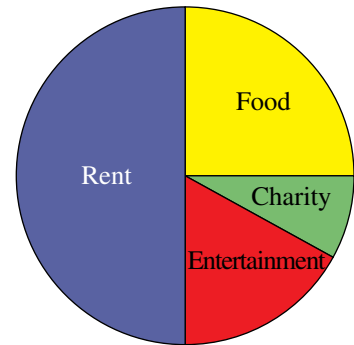

- 6 This table shows the value of the Australian dollar against the US dollar over a period of 6 months.

Time	0	1	2	3	4	5	6
AUD	0.90	0.87	0.85	0.81	0.78	0.76	0.72

- a Plot a graph of the value of the Australian dollar against the US dollar over the 6-month period. Use these axes to help you get started.

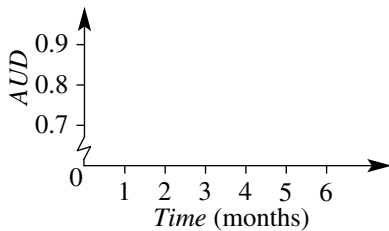

- Would you describe the general shape of the graph as linear (straight line) or non-linear?
- By how much did the Australian dollar decrease in:
  - the first 3 months?
  - the second month?
- Assuming this trend continued, what would the Australian dollar be worth after:
  - 7 months?
  - 9 months?

7 A student has recorded how she spent her time during one day, in the divided bar graph shown below.

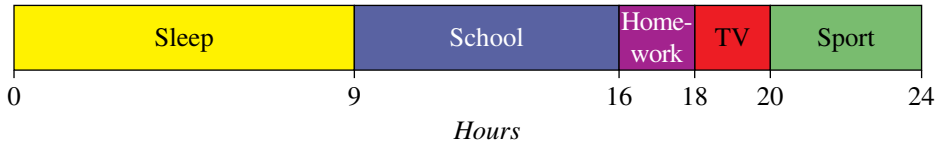

- a How much time did she spend doing homework on that day?
- b How much time was spent at school during that day?
- c What did she spend the most time doing?
- d What fraction of her day was spent playing sport?

**PROBLEM-SOLVING** 8      8, 9      8, 9

8 The temperature in a classroom is graphed over an eight-hour period.

- a What was the temperature at 8 a.m.?
- b By how much did the temperature increase in the eight-hour period?
- c Students complain that it is uncomfortably hot when the temperature is 25°C or greater. At what time does it become uncomfortably hot?

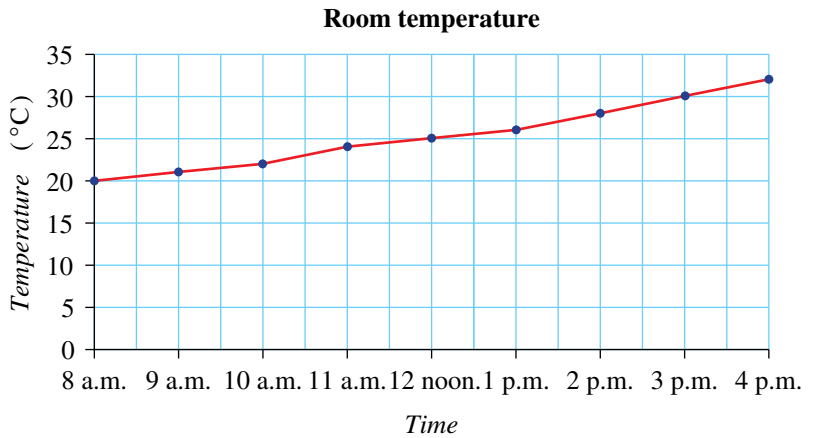

9 A diver jumps off a 10-metre diving board into a pool. The height of the top of her head above the water is given by the table below.

<b>Time (s)</b>	0	1	2	3	4	5	6	7
<b>Height (m)</b>	11.5	9.0	5.0	1.0	-1.5	-2.0	-0.2	0.2

- a Plot this data on the given graph.
- b Would you describe the general shape of the graph as linear (straight line) or non-linear?
- c How tall is the diver?
- d During which second does her head first enter the water?
- e What is the deepest that her head reaches?
- f Draw a graph that the diver might have if she were diving from a 3-metre spring board.

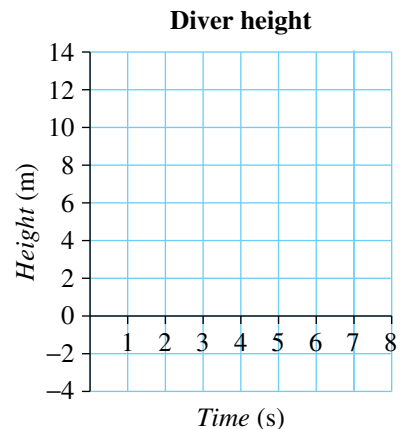

## REASONING

10

10–12

11–13

- 10 Three different surveys are conducted to establish whether soft drinks should be sold in the school canteen.

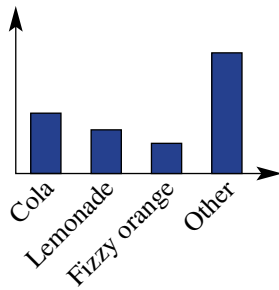

Survey 1: Favourite drink

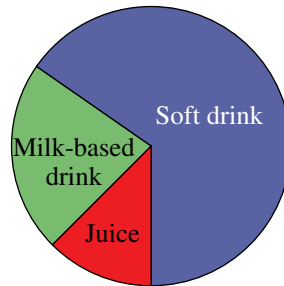

Survey 2: Favourite type of drink

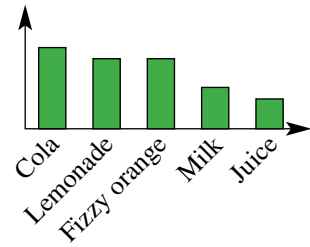

Survey 3: Sugar content per drink

- a Which survey's graph would be the most likely to be used by someone who wished to show the financial benefit to the cafeteria of selling soft drinks?
- b Which survey's graph would be the most likely to be used by someone who wanted to show there was not much desire for soft drink?
- c Which survey's graph would be the most likely to be used by a person wanting to show how unhealthy soft drink is?
- 11 The population of three nearby towns is shown over a 10-year period.

	2006	2007	2008	2009	2010	2011	2012	2013	2014	2015
Town A	1414	1277	1204	1118	1026	1083	1171	1254	1317	1417
Town B	1062	1137	1188	1285	1371	1447	1502	1571	1665	1728
Town C	1042	1100	1174	1250	1312	1176	1075	992	895	783

- a Describe how the population of each town has changed over time.
- b A row is added to the bottom, containing the total of the three numbers above it. A column is added to the right-hand side, containing the total of all the numbers in each row. Give an example of a situation in which:
- the 'total' row at the bottom would be useful
  - the 'total' column at the right would be useful.
- 12 Explain why you can use a pie chart for categorical data but you cannot use a line graph for categorical data.





## 8B Frequency tables and tallies CONSOLIDATING

### LEARNING INTENTIONS

- To understand that a tally can be used for counting during the collection of data
- To be able to interpret tallies
- To be able to construct a tally and frequency table from a set of data

Often the actual values in a set of data are not required – just knowing how many numbers fall into different ranges is often all the information that is needed. A frequency table allows us to do this by listing how common the different values are.

Frequency tables can be used for listing particular values or ranges of values.

Number of cars	Frequency
0	10
1	12
2	5
3	3

Age	Frequency
0–4	7
5–9	12
10–14	10
15–19	11



The ABS (Australian Bureau of Statistics) used frequency tables to help sort and count data from the 2016 Census, such as counting the number of degrees, diplomas and certificate qualifications held by 9.6 million Australians.

### Lesson starter: Subject preferences

- Survey a group of peers to find their favourite school subject out of Maths, English, Science, Music and Sport.
- Represent your results in a table like the one below.

	Maths	English	Science	Music	Sport
Tally	###	###I	###III	IIII	II
Frequency	5	6	8	4	2

- How would you expect the results to differ for different classes at your school, or for different schools?

### KEY IDEAS

- A **tally** is a tool used for counting as results are gathered. Numbers are written as vertical lines with every 5th number having a cross through a group of lines. For example: 4 is IIII and 7 is ###I.
- **Frequency tables** show how common a certain value is in a frequency column. A tallying column is also often used as data is gathered.
- The items can be individual values or intervals of values.

## BUILDING UNDERSTANDING

- 1 The table shows survey results for students' favourite colours.

Colour	Frequency
Red	5
Green	2
Orange	7
Blue	3

Classify the following as true or false.

- a Five people chose red as their favourite colour.  
 b Nine people chose orange as their favourite colour.  
 c Blue is the favourite colour of 3 people.  
 d More people chose green than orange as their favourite colour.
- 2 State the missing parts in the following sentences.
- a The tally IIII represents the number \_\_\_\_\_.  
 b The tally ###II represents the number \_\_\_\_\_.  
 c The tally \_\_\_\_\_ represents the number 2.  
 d The tally \_\_\_\_\_ represents the number 11.



## Example 3 Interpreting tallies

The different car colours along a quiet road are noted.

- a Convert the following tally into a frequency table.

White	Black	Blue	Red	Yellow
III	#####III	#####II	###I	###III

- b Then state how many red cars were spotted.

## SOLUTION

a

Colour	White	Black	Blue	Red	Yellow
Frequency	3	13	17	6	9

- b 6 red cars were spotted.

## EXPLANATION

Each tally is converted into a frequency. For example, black is two groups of 5 plus 3, giving  $10 + 3 = 13$ .

This can be read directly from the table.

## Now you try

The colour of cars along a street are noted.

- a Convert the following tally into a frequency table.

White	Black	Blue	Red	Yellow
#####III	###II	###III	###	###I

- b Then state how many black cars were spotted.



### Example 4 Constructing tables from data

Put the following data into a frequency table:

1, 4, 1, 4, 1, 2, 3, 4, 6, 1, 5, 1, 2, 1.

#### SOLUTION

Number	1	2	3	4	5	6
Tally						
Frequency	6	2	1	3	1	1

#### EXPLANATION

Construct the tally as you read through the list. Then go back and convert the tally to frequencies.

#### Now you try

Put the following data into a frequency table:

1, 2, 4, 2, 1, 2, 2, 4, 5, 2, 4, 1, 5, 3, 2.

## Exercise 8B

### FLUENCY

1-3

2-4

3, 4

Example 3

- 1 A basketball player's performance in one game is recorded in the following table.

	Passes	Shots at goal	Shots that go in	Steals
Tally				
Frequency				

- Copy and complete the table, filling in the frequency row.
- How many shots did the player have at the goal?
- How many shots went in?
- How many shots did the player miss during the game?

Example 3

- 2 Braxton surveys a group of people to find out how much time they spend watching television each week. They give their answers rounded to the nearest hour.

Number of hours	0-1	2-4	5-9	10-14	15-19	20-24	25-168
Tally							

- Draw a frequency table of his results, converting the tallies to numbers.
- How many people did he survey?
- How many people spend 15-19 hours per week watching television?
- How many people watch television for less than 5 hours per week?
- How many people watch television for less than 2 hours per day on average?



Example 4

- 3 A student surveys her class to ask how many people are in their family.

The results are:

6, 3, 3, 2, 4, 5, 4, 5, 8, 5, 4, 8, 6, 7, 6, 5, 8, 4, 7, 6

- a Construct a frequency table. Include a tally row and a frequency row.  
 b How many students have exactly 5 people in their family?  
 c How many students have at least 6 people in their family?
- 4 The heights of a group of 21 people are shown below, given to the nearest cm.

174 179 161 132 191 196 138 165 151 178 189

147 145 145 139 157 193 146 169 191 145

- a Copy and complete the frequency table below.

Height (cm)	130–139	140–149	150–159	160–169	170–179	180–189	190+
Tally							
Frequency							

- b How many people are in the range 150–159 cm?  
 c How many people are 180 cm or taller?  
 d How many people are between 140 cm and 169 cm tall?

### PROBLEM-SOLVING

5

5, 6

6, 7

- 5 A tennis player records the number of double faults they serve per match during one month.

Double faults	0	1	2	3	4	5
Frequency	4	2	1	0	2	1

- a How many matches did they play in total during the month?  
 b How many times did they serve exactly 1 double fault?  
 c In how many matches did they serve no double faults?  
 d How many double faults did they serve in total during the month?
- 6 Match each of these data sets with the correct column (A, B, C or D) in the frequency table shown below.
- a 1, 1, 2, 3, 3  
 b 1, 2, 2, 2, 3  
 c 1, 1, 1, 2, 3  
 d 1, 2, 3, 3, 3

Value	A	B	C	D
1	3	2	1	1
2	1	1	1	3
3	1	2	3	1

- 7 Five different classes are in the same building in different rooms. The ages of students in each room are recorded in the frequency table below.

Age	Room A	Room B	Room C	Room D	Room E
12	3	2	0	0	0
13	20	18	1	0	0
14	2	4	3	0	10
15	0	0	12	10	11
16	0	0	12	10	11
17	0	0	0	1	0

- a How many students are in room C?  
 b How many students are in the building?  
 c How many 14-year-olds are in the building?  
 d What is the average (mean) age of students in room B? Answer to one decimal place.  
 e What is the average (mean) age of students in the building? Answer to one decimal place.

### REASONING

8

8, 9

9, 10

- 8 A number of students sat an exam for which they got a score out of 100. There were no part marks given. The results are presented in the frequency table below.

Score	0–9	10–19	20–29	30–39	40–49	50–59	60–69	70–79	80–89	90–100
Frequency	0	0	3	1	2	5	8	12	10	2

- a Redraw the table so that the intervals are of width 20 rather than 10 (i.e. so the first column is 0–19, the second is 20–39, and so on).  
 b Show how the table would look if it were drawn with the intervals 0–29, 30–59, 60–89, 90–100.  
 c Explain why it is not possible to fill out the frequency table below without additional information.

Score	0–24	25–49	50–74	75–100
Frequency				

- d You are told that 2 students got less than 25, and 15 students got scores between 60 and 74. Use this information to fill out the frequency table above.  
 e What is the total of the frequency row in each of the tables you have drawn? Explain what this tells you.
- 9 a How could the stem-and-leaf plot below be represented as a frequency table using intervals 10–19, 20–29 and 30–39? (Remember that in a stem-and-leaf plot 1|2 represents the number 12, 3|5 represents 35 and so on.)

Stem	Leaf
1	2 5 8
2	1 7 9 9
3	5 5 7 7 8 9

- b Give an example of a different stem-and-leaf plot that would give the same frequency table.  
 c Which contains more information: a stem-and-leaf plot or a frequency table?  
 d When would a frequency table be more appropriate than a stem-and-leaf plot?

10 An AFL player notes the number of points he scores in his 22-week season.

- a Write out one possible list showing the scores he got for each of the 22 weeks. Note that the range 10–14 means at least 10 but less than 15.
- b The list you wrote has a number from 10 to 14 written at least twice. Explain why this must be the case, regardless of what list you chose.
- c Your list contains a number from 5 to 9 at least three times. Why must this be the case?
- d Apart from the two numbers in parts b and c, is it possible to make a list that has no other repeated values?
- e Is it possible to play 22 games and always score a different number of points?

Points	Frequency
0–4	3
5–9	11
10–14	6
15–19	1
20–24	1

**ENRICHMENT: Homework puzzle**

–

–

11

11 Priscilla records the numbers of hours of homework she completes each evening from Monday to Thursday. Her results are shown in this frequency table.

Number of hours	Frequency
1	1
2	1
3	2

- a One possibility is that she worked 3 hours on Monday, 2 hours on Tuesday, 3 hours on Wednesday and 1 hour on Thursday. Give an example of another way her time could have been allocated for the four nights.
- b If she spent at least as much time doing homework each night as on the previous night, how long did she spend on Tuesday night?
- c How many ways are there of filling in the table below to match her description?

Monday	Tuesday	Wednesday	Thursday
<input type="text"/> hours	<input type="text"/> hours	<input type="text"/> hours	<input type="text"/> hours

- d If you know she spent two hours on Monday night, how many ways are there to fill in the table?
- e If you know she spent three hours on Monday night, how many ways are there to fill in the table?
- f Priscilla's brother Joey did homework on all five nights. On two nights he worked for 1 hour, on two nights he worked for 2 hours and on one night he worked for 3 hours. In how many ways could the table below be filled in to match his description?

Monday	Tuesday	Wednesday	Thursday	Friday
<input type="text"/> hours	<input type="text"/> hours	<input type="text"/> hours	<input type="text"/> hours	<input type="text"/> hours

## 8C Graphs of frequency tables

### LEARNING INTENTIONS

- To understand that a frequency table can be represented as a frequency graph
- To be able to construct a graph from a frequency table
- To understand that dot plots can be used for small collections of discrete numerical data
- To be able to construct and analyse a dot plot

A graphical representation of a frequency table can be constructed so that patterns can be observed more easily. For example, the data below is represented as a frequency table and as a frequency graph.

As a table

Number	Frequency
0	57
1	29
2	31
3	61
4	26

As a frequency graph

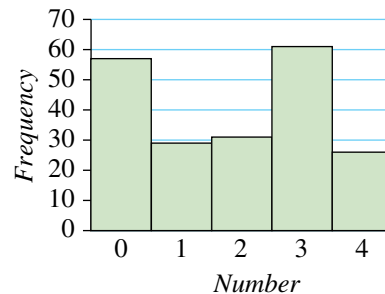

At a glance you can see from the graph that 0 and 3 are about twice as common as the other values. This is harder to read straight from the table. Graphs like the one above are often used in digital cameras and photo editing software to show the brightness of a photo.

An alternative way to show a frequency table graphically is with a dot plot, where each data point is shown as a single dot.

As a table

Number	Frequency
0	4
1	2
2	3
3	1
4	5

As a dot plot

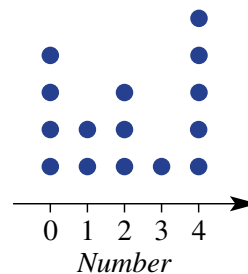

## Lesson starter: Test analysis

The results for some end-of-year tests are shown for four different classes in four different graphs below.

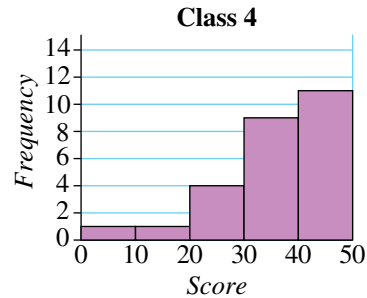
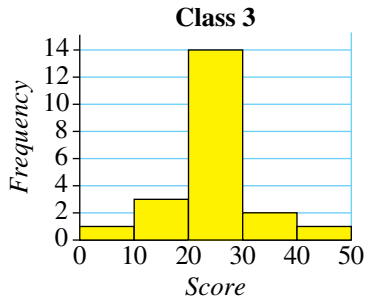
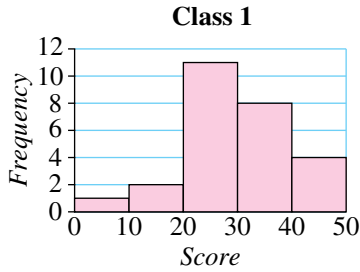

- Describe each class on the basis of these graphs.
- Which class has the highest average score?
- Which class has the highest overall score?
- Which class would be the easiest to teach and which would be the hardest, do you think?

### KEY IDEAS

- Frequency tables can be represented using a frequency graph, which has a vertical axis (y-axis) used to represent the frequency of each item.
- Sometimes the values are grouped (e.g. 0–9, 10–19, 20–29) before the graph is drawn.
- A half-column-width space is sometimes placed between the vertical axis and the first column of the frequency graph if the first vertical bar does not start at zero.
- A dot plot is an alternative graph of frequency tables for discrete data with a small number of values.
- An outlier is a value noticeably distinct from the main cluster of points.

### BUILDING UNDERSTANDING

- The graph on the next page shows the ages of people in an Art class.
  - How many 8-year-olds are in this class?
  - What is the most common age for students in this class?
  - What is the age of the oldest person in the class?

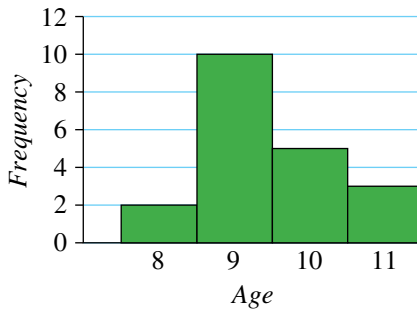

- 2 A survey is conducted of the number of people in different families. The results are shown.
- a What is the most likely number of people in a family, on the basis of this survey?
  - b How many people responding to the survey said they had a family of 6?
  - c What is the least likely number (from 2 to 8) of people in a family, on the basis of this survey?



- 3 The graph on the right shows the number of computers owned by a group of surveyed households.
- a How many households were surveyed?
  - b How many households had 4 computers?
  - c What was the most common number of computers owned?

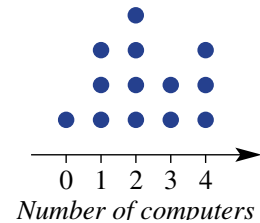

### Example 5 Constructing and interpreting dot plots

- a Construct a dot plot for the frequency table shown of the number of books read in the past month.
- b Use your dot plot to find the most common number of books read.
- c Use your dot plot to identify any outliers.

Number of books	Frequency
0	2
1	5
2	3
3	4
4	2
9	1

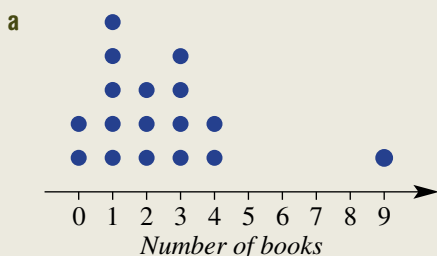
**SOLUTION**

b 1

c 9 books is an outlier.

**EXPLANATION**

The scale is chosen to fit all the values from the minimum (0) to the maximum.

Each dot represents one value, so there are 5 dots above 1, representing the frequency of 5.

The highest point is at 1, with a frequency of 5.

The dot at 9 is separated from the main cluster.

**Now you try**

- a Construct a dot plot for the frequency table shown.  
 b Use your dot plot to find the most common number of games.  
 c Use your dot plot to identify any outliers.

Games	Frequency
1	3
2	1
3	4
4	2
5	1
10	1

**Example 6 Constructing frequency graphs from frequency tables**

Represent the frequency tables below as frequency graphs.

a

Number of siblings	Frequency
0	15
1	20
2	13
3	2

b

Number of words in story	Frequency
0–99	2
100–199	10
200–299	12
300–399	8
400–500	3

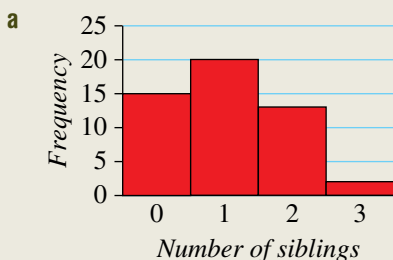
**SOLUTION****EXPLANATION**

The scale 0–25 is chosen to fit the highest frequency (20).

Each different number of siblings in the frequency table is given a column in the graph.

*Continued on next page*

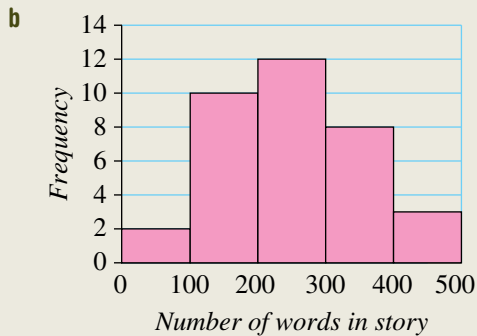

The scale 0–14 is chosen to fit the highest frequency (12).

The different intervals (0–99 words, 100–199 words etc.) are displayed on the horizontal axis.

### Now you try

Represent the frequency tables below as frequency graphs.

**a**

Number of pets	Frequency
0	4
1	3
2	9
3	2

**b**

Age of customer (years)	Frequency
0–9	4
10–19	12
20–29	25
30–39	18
40–50	7

## Exercise 8C

### FLUENCY

1–4

2–5

2, 4–6

Example 5a

- 1 Construct a dot plot for the following frequency tables.

**a**

Number	Frequency
0	3
1	5
2	1
3	2

**b**

Number	Frequency
1	4
2	2
3	1
4	3
5	2

Example 5

- 2 **a** Construct a dot plot for the frequency table showing the number of aces served by a tennis player.  
**b** Use your dot plot to find the most common number of aces served.  
**c** Use your dot plot to identify any outliers.

Aces	Frequency
0	1
1	3
2	4
3	2
4	6
5	1
10	1



**Example 6a** 3 Represent the following frequency tables as frequency graphs. Ensure that appropriate scales and labels are put on the axes.

**a**

Number	Frequency
0	3
1	9
2	3
3	10
4	7

**b**

Number of cars	Frequency
0	4
1	5
2	4
3	2

**Example 6b** 4 Represent the following frequency table as a frequency graph.

Number	Frequency
0-5	5
6-10	12
11-15	14
16-20	11
21-25	5
26-30	8
31-35	2
36-40	1

**Example 6** 5 Represent the frequency tables below as frequency graphs.

**a**

Number	Frequency
0	5
1	3
2	5
3	2
4	4

**b**

Score	Frequency
0-19	1
20-39	4
40-59	10
60-79	12
80-100	5

6 A set of results is shown below for a quiz out of 10.  
4, 3, 8, 9, 7, 1, 6, 3, 1, 1, 4, 6, 2, 9, 7, 2, 10, 5, 5, 4.

- a Create a frequency table.
- b Draw a frequency graph to represent the results.
- c Construct a dot plot to represent the results.

**PROBLEM-SOLVING**

7

7, 8

8-10

- 7 a Draw a frequency table to match the dot plot shown.
- b If one of the data points is removed, the dot plot and frequency table will both be reduced in size. What is the point?

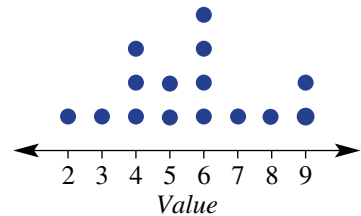

- 8 Edwin records the results for his spelling tests out of 10. They are 3, 9, 3, 2, 7, 2, 9, 1, 5, 7, 10, 6, 2, 6, 4.
- Draw a frequency graph for his results.
  - Is he a better or a worse speller generally than Fred, whose results are given by the graph shown?

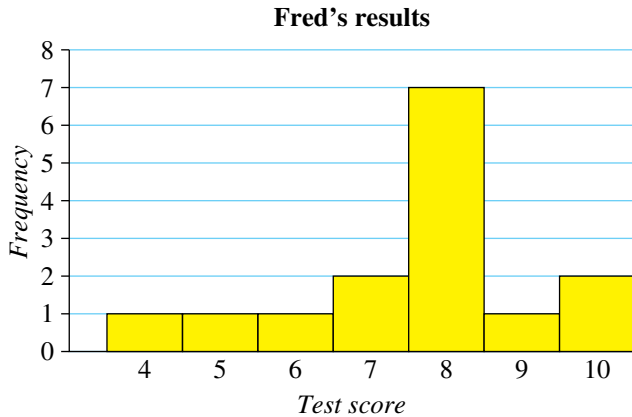

- 9 Some tennis players count the number of aces served in different matches. Match up the graphs with the descriptions.

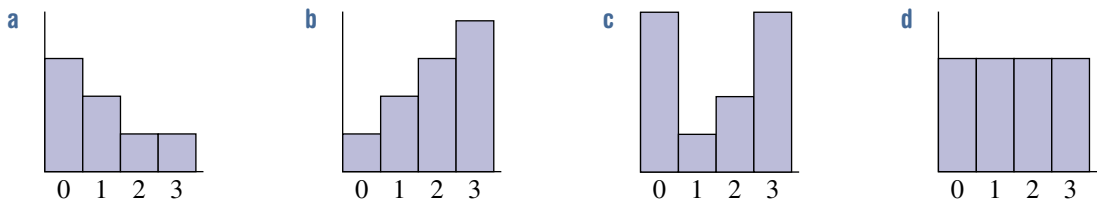

- Often serves aces.
- Generally serves 3 aces or 0 aces.
- Serves a different number of aces in each match.
- Rarely serves aces.

- 10 A car dealership records the number of sales each salesperson makes per day over three weeks.

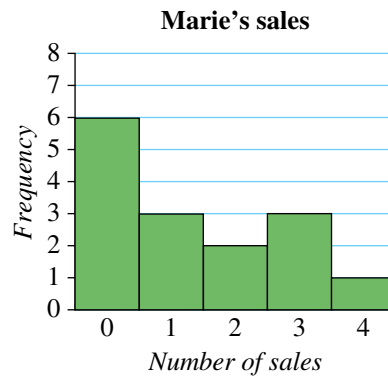
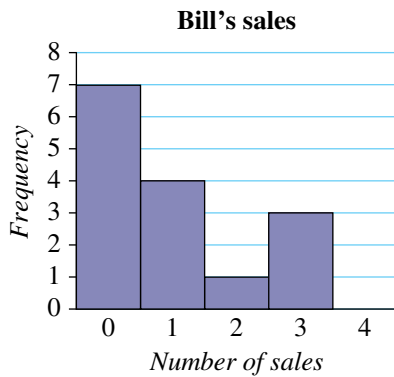

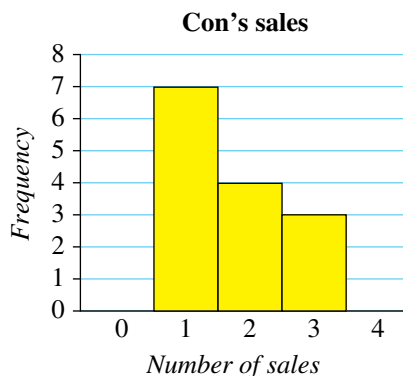
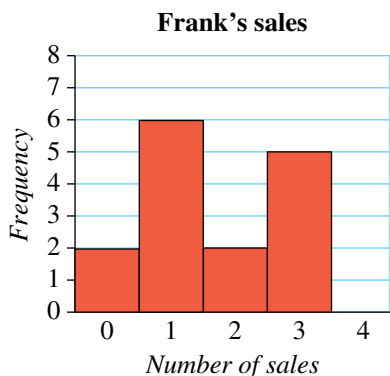

- Which salesperson holds the record for the greatest number of sales in one day?
- Which salesperson made a sale every day?
- Over the whole period, which salesperson made the most sales in total?
- Over the whole period, which salesperson made the fewest sales in total?

**REASONING**

11

11, 12

12, 13

- 11** This graph shows the ages of a group of people in a room.
- Describe a graph that shows the ages of this same group of people in 12 years' time.
  - Describe a graph that shows the ages of this same group of people 12 years ago. Include a rough sketch.

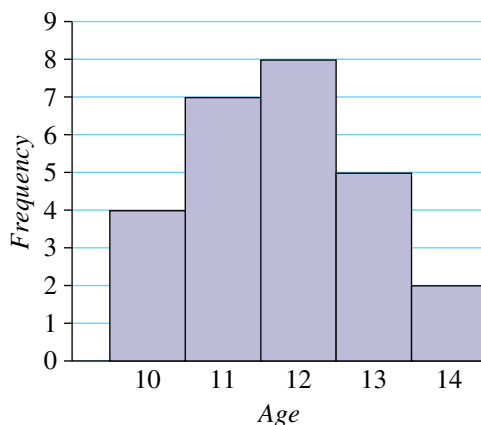

- 12** If you wanted to graph the number of phones per household for everyone in your class, you could use a dot plot or a frequency graph. Which of these types of graph would be better if you wanted to graph the number of phones per household for everyone in your school? Explain your answer.
- 13** Two students have each drawn a graph that shows their results for a number of spelling tests. Each test is out of 10.

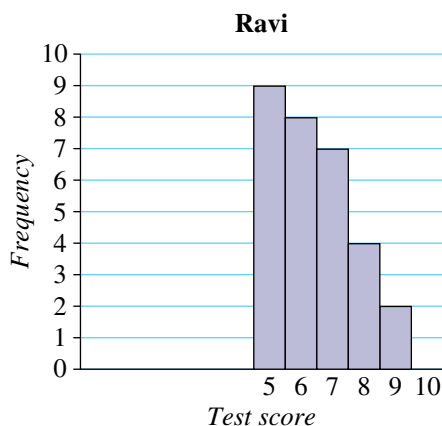
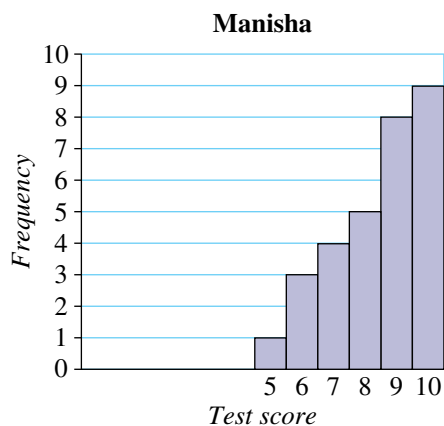

- a Does Manisha's graph show that her spelling is improving over the course of the year? Explain.
- b Ravi's spelling has actually improved consistently over the course of the year. Give an example of a list of the scores he might have received for the 30 weeks so far.
- c A third student has the results shown on the right. What is a likely explanation for the '0' results?

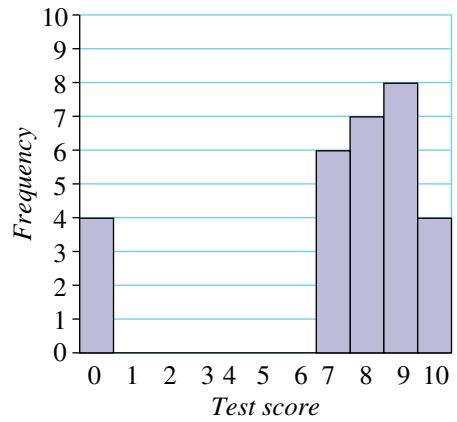

**ENRICHMENT: Heights, weights and ages mix-up** - - 14

14 Three students survey different groups of people to find out their heights, weights and ages. Unfortunately they have mixed up all the graphs they obtained.

- a Copy and complete the table below, stating which graph corresponds to which set of data.

Survey location	Height graph (cm)	Weight graph (kg)	Age graph (years)
Primary school classroom	Graph 4		
Shopping centre			
Teachers' common room			

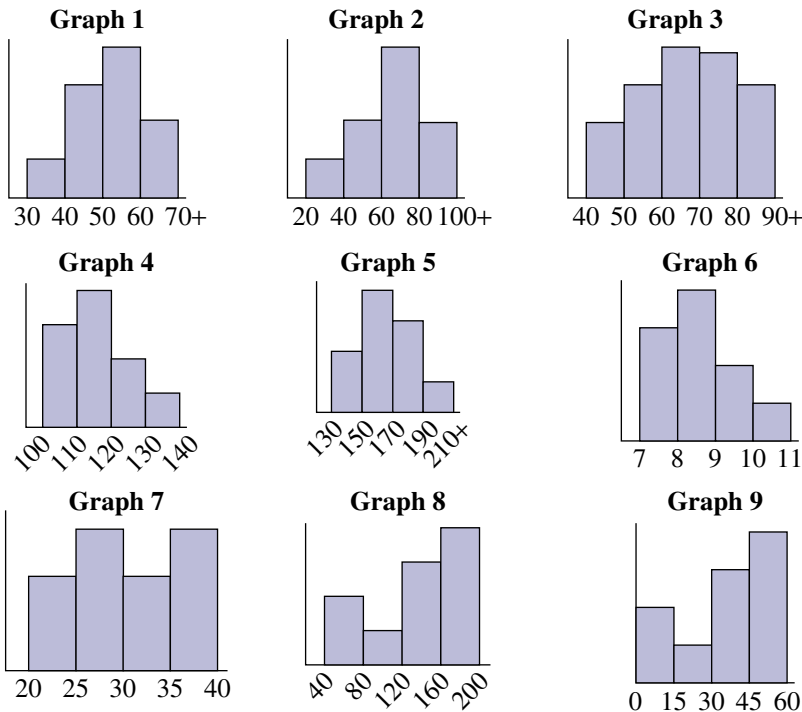

- b Show with rough sketches how the height, weight and age graphs would look for:
  - i people in a retirement village
  - ii students at a secondary school
  - iii guests at a 30-year high school reunion.

## 8D Measures of centre

### LEARNING INTENTIONS

- To understand that the mean (also called average) and median are different measures of centre for numerical data
- To understand that the mean of a set of data can be affected significantly by an outlier, whereas the median is not affected
- To be able to calculate the mean, median and mode for a set of numerical data

It is sometimes useful to summarise a large group of data as a single value. The concept of ‘average’ is familiar to most people, but more precise mathematical terms to use are ‘mean’, ‘median’ and ‘mode’. The mean and the median are considered values that are approximately at the ‘centre’ of the data set, although this is not always the case.



Marine ecologists research ocean populations and the marine environment. The monthly mean and median can be found for recorded data, such as ocean pH and temperature, the number of turtles, or species of sea slugs.

### Lesson starter: Tug-of-war competition

At a school there are 20 students in each class. They are to compete in a tug-of-war round-robin and it is known that a heavier team will always beat a lighter team. You are told some information about the classes.

- 8A: The mean weight is 53 kg.
- 8B: Half the class weighs more than 55 kg.
- 8C: Half the class weighs less than 52 kg.
- 8D: The mean weight is 56 kg.
- 8E: The most common weight is 60 kg.
- 8F: The mean weight is 54 kg.

- In a tug-of-war round-robin in which everyone in each class is involved, which results would you be able to determine from these facts alone? (For example, 8D would beat 8A.)
- Is it possible for 8A to beat 8E? Give an example of how this could happen.
- Is it possible for 8C to beat 8B? Explain.

## KEY IDEAS

- Statisticians use **summary statistics** to highlight important aspects of a data set. These are summarised below.
  - The **mean**, **median** and **mode** are called **measures of location**, **measures of centre** or **measures of central tendency**.
- The **mean** is sometimes called the arithmetic mean or average. The formula used for calculating the mean,  $\bar{x}$ , is:

$$\bar{x} = \frac{\text{sum of data values}}{\text{number of data values}}$$

For example:

$$7 + 8 + 1 + 10 + 2 + 1 + 6 = 35$$

$$\text{Mean} = 35 \div 7 = 5$$

- The **median** is the middle value if the values are in order (ascending or descending). If there are two middle values then the average of them is taken, by adding them together and dividing by 2.

For example: 1 1 2 6 7 8 10

Middle  $\Rightarrow$  Median = 6

For example: 2 3 5 9 10 12

$$\frac{5 + 9}{2} \Rightarrow \text{Median} = 7$$

- The **mode** is the most common value, i.e. the one with the highest frequency. There can be more than one mode. When there are two modes, the data set is said to be bi-modal.

For example:

1 1 2 6 7 8 10

Mode = 1

- An **outlier** is a data point that is significantly smaller or larger than the rest of the data.
  - The median and mode are generally unaffected by outliers, whereas the mean can be affected significantly by an outlier.

## BUILDING UNDERSTANDING

- 1 State the missing words.
  - a The most common value in a set of data is called the \_\_\_\_\_.
  - b The sum of all values, divided by the number of values is called the \_\_\_\_\_.
  - c The \_\_\_\_\_ can be calculated by finding the middle values of the numbers placed in ascending order.
- 2 Consider the set of numbers 1, 7, 1, 2, 4.
  - a Find the sum of these numbers.
  - b How many numbers are listed?
  - c Find the mean.
- 3 Consider the values 5, 2, 1, 7, 9, 4, 6.
  - a Sort these numbers from smallest to largest.
  - b What is the middle value in your sorted list?
  - c What is the median of this set?

- 4 Consider the set 1, 5, 7, 9, 10, 13.
- State the two middle values.
  - Find the sum of the two middle values.
  - Divide your answer by 2 to find the median of the set.



### Example 7 Finding the mean and the mode

For the set of numbers 10, 2, 15, 1, 15, 5, 11, 19, 4, 8, find:

- the mean
- the mode.

#### SOLUTION

a  $10 + 2 + 15 + 1 + 15 + 5 + 11 + 19 + 4 + 8 = 90$   
 Mean =  $90 \div 10 = 9$

b Mode = 15

#### EXPLANATION

The numbers are added.  
 The mean is found by dividing the total by the number of items (in this case 10).

The most common value is 15, so this is the mode.

#### Now you try

For the set of numbers 3, 9, 3, 5, 10, 3, 5, 2, find:

- the mean
- the mode.



### Example 8 Finding the median

Find the median of:

- 16, 18, 1, 13, 14, 2, 11
- 7, 9, 12, 3, 15, 10, 19, 3, 19, 1

#### SOLUTION

a Sorted: 1, 2, 11, 13, 14, 16, 18  
 Median = 13

b Sorted: 1, 3, 3, 7, 9, 10, 12, 15, 19, 19  
 Median =  $\frac{9 + 10}{2} = 9.5$

#### EXPLANATION

Sort the numbers.  
 The middle value is 13.

Sort the numbers.  
 There are two middle values (9 and 10) so we add them and divide by 2.

#### Now you try

Find the median of:

- 15, 12, 5, 10, 13, 8, 11
- 7, 9, 13, 3, 15, 12, 19, 3

## Exercise 8D

### FLUENCY

1,  $2\frac{1}{2}$ ,  $4-5\frac{1}{2}$ 2- $6\frac{1}{2}$ 2- $6\frac{1}{2}$ , 7

- Example 7** 1 For the set of numbers 5, 6, 3, 4, 4, 8, find:
- a** the mean **b** the mode.
- Example 7** 2 For each of the following sets of numbers, find: **i** the mean **ii** the mode.
- a** 2, 2, 1, 2, 1, 4, 2 **b** 4, 3, 3, 10, 10, 2, 3
- c** 13, 15, 7, 7, 20, 9, 15, 15, 11, 17 **d** 20, 12, 15, 11, 20, 3, 18, 2, 14, 16
- e** 18, 12, 12, 14, 12, 3, 3, 16, 5, 16 **f** 18, 5, 14, 5, 19, 12, 13, 5, 10, 3
- Example 7** 3 Find the mean of the following sets of numbers.
- a** -10, -4, 0, 0, -2, 0, -5 **b** 3, 4, 5, -9, 6, -9
- c** 3, -6, 7, -4, -3, 3 **d** -15, -6, -6, 16, 6, 13, 3, 2, 19, -8
- Example 8a** 4 For each of the following sets find the median.
- a** 3, 5, 6, 8, 10 **b** 3, 4, 4, 6, 7
- c** 1, 2, 4, 8, 10, 13, 13 **d** 2, 5, 5, 5, 8, 12, 14
- e** 14, 15, 7, 1, 11, 2, 8, 7, 15 **f** 4, 14, 5, 7, 12, 1, 12, 6, 11
- Example 8b** 5 For each of the following sets find the median.
- a** 2, 2, 4, 6, 7, 9 **b** 1, 1, 2, 9, 9, 10
- c** 1, 3, 5, 7, 8, 10, 13, 14 **d** 0, 1, 9, 13, 1, 10, 7, 12, 9, 2
- Example 8** 6 Find the median of the following sets of numbers.
- a** 6, -10, 8, 1, 15, 8, 3, 1, 2 **b** 5, -7, 12, 7, -3, 7, -3, 11, 12
- c** 12, 17, 7, 10, 2, 17, -2, 15, 11, -8 **d** -2, -1, -3, 15, 13, 11, 14, 17, 1, 14
- 7 Some people's ages are placed into a stem-and-leaf plot.

Stem	Leaf
1	8 9
2	0 3 5 7
3	1 2 2 7

2|3 means 23 years old

- a** Write this set of data out as a list in ascending order. (Recall 1|8 means 18, 2|0 means 20 etc.)
- b** Find the median.
- c** Calculate the mean.
- d** State the mode.

### PROBLEM-SOLVING

8, 9

9-11

10, 11

- 8** Jared measures the weights of 10 eggs at two shops. Both shops sell eggs at the same price.
- Shop A (grams):** 52.5, 49.6, 49.1, 47.8, 54.1, 53.7, 49.8, 45.7, 54.4, 53.3
- Shop B (grams):** 49.0, 48.1, 60.0, 55.4, 47.0, 53.9, 58.5, 46.5, 43.3, 42.2
- a** Find the mean weight of an egg in:
- i** shop A **ii** shop B.
- b** Which shop has heavier eggs, on average?



- 9 Federica is in a dancing competition and each week she is rated out of 10. Her results for one term are shown in the frequency table below.

Score	7	8	9	10
Frequency	3	0	3	4

- a In how many weeks did she get 7 out of 10?
- b What score did she receive the most often?
- c What is her mean dancing score for the 10 weeks? (*Hint: Write out the scores as a list.*)
- d What is her median dancing score for the 10 weeks?
- e Give an example of a single change that would reduce the mean score but keep the median the same.



- 10 The graph on the right shows the ages of all students in a school's chess club.

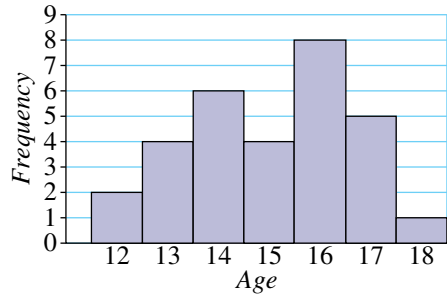

- a What is the most common age?
- b Calculate the mean age, correct to two decimal places.
- c Calculate the median age.

- 11 In each case, find the missing number.
- a The mean of the set 7, 12, , 5 is equal to 10.
  - b The mean of the set 4, 5, 6,  is equal to 3.
  - c The mode of the set 2, 6, , 5 is equal to 5.
  - d The median of the set 1, 9, 3, , 100 is equal to 7.
  - e The median of the set 15, 11, 2, , 7, 23 is equal to 10.

**REASONING**

12, 14

12–14

13–16

- 12 Bernie writes down how many hours he works each day for one week.

Day	Monday	Tuesday	Wednesday	Thursday	Friday
Number of hours	8	10	8	7	9

- a What is the mean number of hours Bernie worked each day?
- b What is the median number of hours Bernie worked each day?
- c What is the mode number of hours Bernie worked each day?
- d If the number of hours worked on Tuesday changed to 20 (becoming an outlier), which of your answers above would be affected?

- 13 Consider the set 1, 5, 7, 8, 9.

- a Find the mean of this set.
- b What happens to the mean if every number is multiplied by 3?
- c What happens to the mean if every number has 4 added?
- d What happens to the mean if every number is squared?
- e What happens to the median if every number is squared?



- 14 The prices of all the houses in School Court are recorded:  
 \$520 000, \$470 000, \$630 000, \$580 000, \$790 000, \$540 000, \$710 000, \$8.4 million, \$660 000.
- What is the mean house price in School Court, correct to the nearest dollar?
  - What is the median house price in School Court?
  - What effect does having a single \$8.4 million mansion in School Court have on the mean?
  - What effect does having a single \$8.4 million mansion in School Court have on the median?
  - Why might 'median house price' be a more informative measure than 'mean house price' when people are looking at living in a particular area?

- 15 For the following graphs drawn to scale, the frequencies have been omitted. Determine the median for each one.

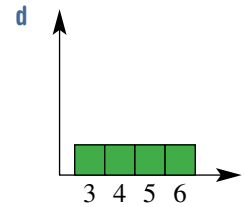
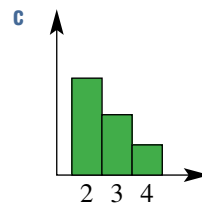
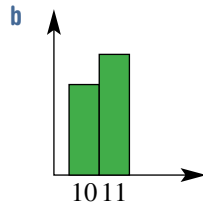
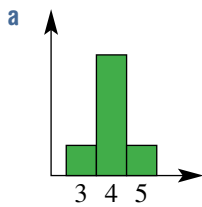

- 16 For the following descriptions of data sets, determine whether they are possible. If so, give an example; if not, explain why not.
- This set has four items with a mean of 5, a median of 6 and a mode of 7.
  - This set has two items with a mean greater than the median.
  - This set has three elements and the mode is less than the median.
  - This set has four elements and the median is double the mean.

### ENRICHMENT: Report cards

-

-

17

- 17 At a particular school the grades are given according to this guide.

Mark	80–100	60–79	40–59	20–39	0–19
Grade	A	B	C	D	E

In one semester Kathryn's grades were C, B, A, B, B, E, D, A. Her final mark is the mean of all the marks she obtained that semester.

- Give a possible set of 8 marks that would give these grades.
- Give the lowest possible set of 8 marks that would give these grades.
- Give the highest possible set of 8 marks that would give these grades.
- Is it possible for Kathryn to have a final mark of 80 on the basis of these grades?
- What range of values could her final mark have?
- What are the possible final grades that she could have?
- Explain why the median must be a B, regardless of what the individual marks were.
- Another student has just four results: A, B, A, A.
  - What is the range of numbers for this student's final mark?
  - What are the possible grades that this student could have?

## 8E Measures of spread EXTENDING

### LEARNING INTENTIONS

- To understand that range and interquartile range (IQR) are two measures of spread for numerical data
- To understand that the range of a set of data is affected by an outlier, but the IQR is not
- To be able to calculate the range of a set of numerical data
- To be able to calculate the IQR of a set of numerical data

While a mean, median and a mode can give a summary of data, it is often helpful to know how spread out the data are. Two commonly used values are the range and the interquartile range. These are both examples of measures of spread.

### Lesson starter: Golfing

Three golfers record their scores over 5 games. In golf, lower scores are better.

Alfred: 82, 87, 80, 112, 79

Brenton: 90, 89, 91, 92, 89

Charlie: 72, 103, 94, 83, 80

- Which golfer do you think is best? Explain.
- Which golfer is most consistent? Explain.
- Alfred's range of values ( $112 - 79 = 33$ ) is larger than Charlie's ( $103 - 72 = 31$ ). Discuss whether this means that Charlie is a more consistent golfer than Alfred.



Climate scientists determine statistically significant trends in historical weather data and past greenhouse gas concentrations from ice cores. Predictions are made of climate change effects, such as possible ranges of future rainfall and temperature.

### KEY IDEAS

- The **range** and **interquartile range** are summary statistics known as **measures of spread**.
- The **range** of a set of data is given by:
 
$$\text{Range} = \text{highest number} - \text{lowest number}$$
- The **interquartile range** (or IQR) is found by the following procedure.
  - Sort the data into ascending order.
  - If there is an odd number of values, remove the middle one.
  - Split the data into two equal-sized groups.
  - The median of the lower half is called the **lower quartile**.
  - The median of the upper half is called the **upper quartile**.

- $\text{IQR} = \text{upper quartile} - \text{lower quartile}$

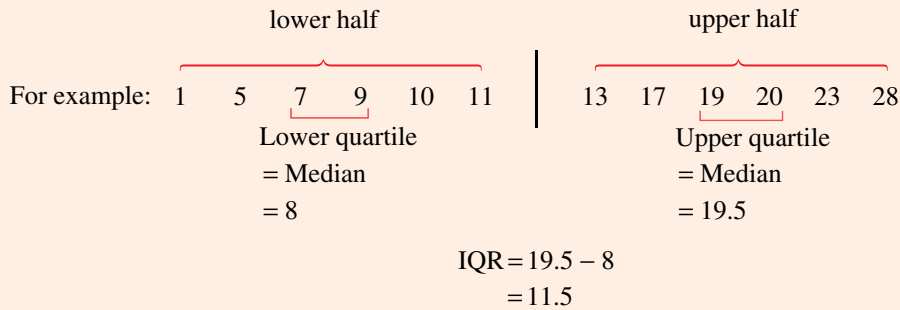

- The range and the interquartile range are **measures of spread**; they summarise the amount of spread in a set of numerical data. Outliers affect the range but not the IQR.

### BUILDING UNDERSTANDING

- 1 Consider the set of numbers 1, 3, 2, 8, 5, 6.
  - a State the largest number.
  - b State the smallest number.
  - c Then state the range by finding the difference of these two values.
- 2 Consider the set of numbers 1, 2, 4, 5, 5, 6, 7, 9, 9, 10.
  - a State the median of 1, 2, 4, 5, 5.
  - b State the median of 6, 7, 9, 9, 10.
  - c Then state the interquartile range, by finding the difference of these two values.
- 3 Consider the set of numbers 1, 5, 6, 8, 10, 12, 14.
  - a State the median of the lower half (1, 5, 6).
  - b State the median of the upper half (10, 12, 14).
  - c Then state the interquartile range.
- 4 State the missing words to complete these sentences.
  - a The median of the lower half is called the \_\_\_\_\_.
  - b The difference between the highest and \_\_\_\_\_ values is the range.
  - c In order to calculate the IQR you should first \_\_\_\_\_ the numbers from lowest to highest.
  - d The upper quartile is the \_\_\_\_\_ of the upper half of the sorted data.
  - e When calculating the IQR, you remove the middle term if the number of values is \_\_\_\_\_.
  - f The range and IQR are measures of \_\_\_\_\_.

**Example 9 Finding the range**

Find the range of the following sets of data.

**a** 1, 5, 2, 3, 8, 12, 4

**b** -6, -20, 7, 12, -24, 19

**SOLUTION**

**a** Range =  $12 - 1$   
= 11

**b** Range =  $19 - (-24)$   
= 43

**EXPLANATION**Maximum: 12, minimum: 1  
Range = maximum - minimumMaximum: 19, minimum: -24  
Range =  $19 - (-24) = 19 + 24$ **Now you try**

Find the range of the following sets of data.

**a** 2, 5, 12, 3, 10, 17

**b** -3, 1, -6, 12, 8, -11

**Example 10 Finding the interquartile range**

Find the interquartile range (IQR) of the following sets of data.

**a** 1, 15, 8, 2, 13, 10, 4, 14

**b** 2, 7, 11, 8, 3, 8, 10, 4, 9, 6, 8

**SOLUTION****a** Sorted: 1 2 4 8 10 13 14 15

1 2 4 8 10 13 14 15

Median =  $\frac{2+4}{2}$       Median =  $\frac{13+14}{2}$   
= 3                      = 13.5

IQR =  $13.5 - 3$   
= 10.5

**b** Sorted: 2 3 4 6 7 ~~8~~ 8 8 9 10 11

2 3 4 6 7      8 8 9 10 11

Lower quartile      Upper quartile

IQR =  $9 - 4$   
= 5

**EXPLANATION**

Values must be sorted from lowest to highest.

Lower quartile = median of the lower half.

Upper quartile = median of the upper half.

IQR = upper quartile - lower quartile

Sort the data and remove the middle value (so there are two equal halves remaining).

Lower quartile = median of the lower half.

Upper quartile = median of the upper half.

IQR = upper quartile - lower quartile

**Now you try**

Find the interquartile range of the following sets of data.

**a** 7, 12, 3, 17, 5, 13, 1, 12

**b** 6, 10, 11, 9, 14, 13, 4

## Exercise 8E

### FLUENCY

1, 2–4( $\frac{1}{2}$ )2–5( $\frac{1}{2}$ )2–5( $\frac{1}{3}$ )

- |             |   |  |   |  |
|-------------|---|--|---|--|
| Example 9a  | 1 | Find the range of the following sets of data.<br>a 5, 1, 7, 9, 10, 3, 10, 6  | b | 3, 1, 8, 9, 1, 4, 7, 12, 5   |
| Example 9   | 2 | Find the range of the following sets.<br>a 9, 3, 9, 3, 10, 5, 0, 2<br>c 16, 7, 17, 13, 3, 12, 6, 6, 3, 6<br>e 3.5, 6.9, –9.8, –10.0, 6.2, 0.8  | b | 4, 13, 16, 9, 1, 6, 5, 8, 11, 10<br>d 16, –3, –5, –6, 18, –4, 3, –9<br>f –4.6, 2.6, –6.1, 2.6, 0.8, –5.4   |
| Example 10a | 3 | Find the IQR of the following sets.<br>a 1, 9, 11, 13, 28, 29<br>c 0, 0, 4, 5, 7, 8, 8, 8, 11, 12, 17, 18<br>e 0.28, 2.13, 3.64, 3.81, 5.29, 7.08  | b | 7, 9, 13, 16, 20, 28<br>d 1, 9, 9, 9, 12, 18, 19, 20<br>f 1.16, 2.97, 3.84, 3.94, 4.73, 6.14   |
| Example 10b | 4 | Find the IQR of the following sets.<br>a 4, 4, 11, 16, 21, 27, 30<br>c 1, 1, 2, 9, 9, 12, 18, 18, 18<br>e 0.4, 0.9, 0.9, 1.9, 2.0, 3.9, 4.3, 4.4, 4.7  | b | 10, 11, 13, 22, 27, 30, 30<br>d 2, 2, 8, 9, 12, 14, 15, 16, 19<br>f 0.5, 1.1, 1.2, 1.4, 1.5, 2.1, 2.2, 2.4, 4.8  |
| Example 10  | 5 | Find the IQR of the following sets. Remember to sort first.<br>a 0, 12, 14, 3, 4, 14<br>c 6, 11, 3, 15, 18, 14, 13, 2, 16, 7, 7<br>e 18, –15, 17, –15, –1, 2<br>g –19, 8, 20, –10, 6, –16, 0, 14, 2, –2, 1 | b | 14, 0, 15, 18, 0, 3, 14, 7, 18, 12, 9, 5<br>d 6, 4, 6, 5, 14, 8, 10, 18, 16, 6<br>f –12, –17, –12, 11, 15, –1<br>h –4, –9, 17, 7, –8, –4, –16, 4, 2, 5 |

### PROBLEM-SOLVING

6, 7

7–9

8–10

- 6 Gary and Nathan compare the number of runs they score in cricket over a number of weeks.
- Gary:** 17, 19, 17, 8, 11, 20, 5, 13, 15, 15
- Nathan:** 39, 4, 26, 28, 23, 18, 37, 18, 16, 20
- Calculate Gary's range.
  - Calculate Nathan's range.
  - Who has the greater range?
  - Which cricketer is more consistent, on the basis of their ranges only?

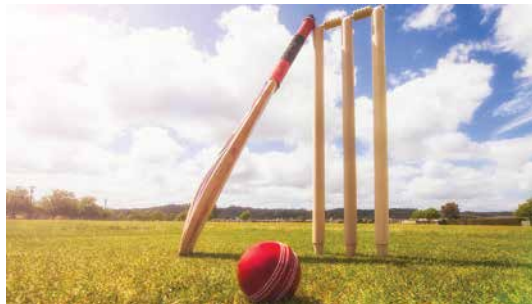

- 7 The dot plot shows the number of years that people have worked at a shop.  
 a Find the range.

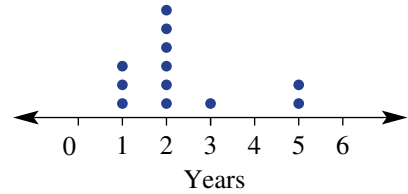

- b Another person is surveyed and this causes the range to increase by 2. How long has this person been working at the shop?
- 8 Winnie and Max note the amount of water they drink (in litres) every day for a week.



	Mon	Tue	Wed	Thu	Fri	Sat	Sun
Winnie	2.4	1.3	3	2.2	2	4	1.2
Max	1.5	2.3	0.8	1.2	3	2.5	4.1

- a Calculate Winnie's IQR.  
 b Calculate Max's IQR.  
 c Who has the larger IQR?
- 9 Over a 20-week period, Sara and Andy tally their spelling test results.

Score	0	1	2	3	4	5	6	7	8	9	10
Sara						###					###
Andy									###		###

- a Find the range for:  
 i Sara  
 ii Andy.
- b Find the IQR for:  
 i Sara  
 ii Andy.
- c On the basis of the range only, which student is more consistent?  
 d On the basis of the IQR only, which student is more consistent?
- 10 a Give an example of a set of numbers with mean = 10 and median = 10 and:  
 i range = 2  
 ii range = 20.
- b Give an example of a set of numbers with range = 20 and:  
 i mean = 10  
 ii mean = 1.

## REASONING

11

11, 12, 14

11, 13, 14

- 11 Consider the set of numbers 2, 3, 3, 4, 5, 5, 5, 7, 9, 10.
- Calculate the:
    - range
    - IQR.
  - If the number 10 changed to 100, calculate the new:
    - range
    - IQR.
  - Explain why the IQR is a better measure of spread if there are outliers in a data set.
- 12 Consider the set 1, 4, 5, 5, 6, 8, 11.
- Find the range.
  - Find the IQR.
  - Is it ever possible for the IQR of a set to be larger than the range? Explain.
  - Is it possible for the IQR of a set to equal the range? Explain.
- 13 For a set of 3 numbers, what effect is there on the range if:
- each number is increased by 10?
  - each number is doubled?
- 14 Why are the words 'upper quartile' and 'lower quartile' used? Think about what 'quart' might mean.

## ENRICHMENT: Changing the frequency

–

–

15

- 15 Consider the data below, given as a frequency table.

Number	1	2	3	4	5
Frequency	2	4	1	1	3

- What is the range?
- Calculate the IQR. (*Hint*: Write the data as a list first.)
- How would the range change if the frequency of each number were doubled?
- How would the IQR change if the frequency of each number were doubled?
- If the numbers themselves were doubled but the frequencies kept the same as in the table above, how would this change:
  - the range?
  - the IQR?



## 8F Surveying and sampling

### LEARNING INTENTIONS

- To know the meaning of these terms: population, sample, stratified, survey, census, symmetric, skewed and bi-modal
- To understand that a sample needs to be representative of a larger group in order for the conclusions to be meaningful
- To be able to interpret results from a survey
- To be able to decide whether a bias is introduced by different methods of collecting data

To find information about a large number of people it is generally not possible to ask everybody to complete a survey, so instead a sample of the population is chosen and surveyed. It is hoped that the information given by this smaller group is representative of the larger group of people. Choosing the right sample size and obtaining a representative sample are harder than many people realise.



Shops, restaurants, hotels and websites constantly ask us to rate our experience. Marketing analysts conduct surveys to determine customer satisfaction with both service and products. Customer feedback provides data on which to base future advertising.

### Lesson starter: Average word length

To decide how hard the language is in a book, you could try to calculate the average length of the words in it. Because books are generally too large, instead you can choose a smaller sample. For this activity, you must decide or be assigned to the 'small sample', 'medium sample' or 'large sample' group. Then:

- 1 Pick a page from the book at random.
- 2 Find the average (mean) length of any English words on this page, choosing the first 10 words if you are in the 'small sample' group, the first 30 words for the 'medium sample' group and the first 50 words for the 'large sample' group.

Discuss as a class:

- Which of the groups would have the best estimate for the average word length in the book?
- What are the advantages and disadvantages of choosing a large sample?
- Does this sample help to determine the average length of words in the English language?
- How could the results of a whole class be combined to get the best possible estimate for average word length in the book?
- If all students are allowed to choose the page on which to count words, rather than choosing one at random, how could this bias the results?

## KEY IDEAS

- A **population** is the set of all members of a group which is to be studied.  
For example: All the people in a town, looking at which local beach they prefer.  
All the kangaroos in a park, looking at the presence of any diseases.
- A **sample** is a subset (selected group) of a population.  
For example: 20 students selected from all Year 8 students in a school, looking at what their favourite football team is.
  - A **simple random sample** is found by randomly selecting from the population.
  - When a population has distinct groups within it (e.g. different year levels in a school), a **stratified sample** is found by randomly selecting separately from each group (e.g. randomly selecting 10 people from each year level, rather than randomly selecting 60 people from the school).
  - A **convenience sample** is found by selecting easily available data (e.g. surveying the people in your class) and is likely not to be representative.
- A **survey** can be conducted to obtain information about a large group by using a smaller sample.  
A survey conducted on an entire population is called a **census**.
- The accuracy of the survey's conclusion can be affected by:
  - the **sample size** (number of participants or items considered)
  - whether the sample is **representative** of the larger group, or **biased**, which can result in a sample mean significantly different from the population mean
  - whether there were any **measurement errors**, which could lead to **outliers** – values that are noticeably different from the other values.
- Data represented as a graph can be seen as **symmetric**, **skewed** or **bi-modal**.

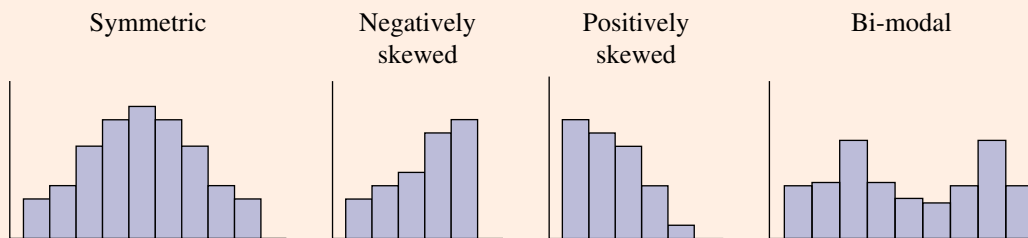

- If a data distribution is symmetric, the mean and the median are approximately equal.

## BUILDING UNDERSTANDING

- 1 Marieko wishes to know the average age of drivers in her city. She could survey 10 of her friends, or survey 1000 randomly selected drivers.
- Which of these options would give a more accurate result?
  - Which would be easier for Marieko to perform?
- 2 Ajith looks at a random sample of penguins and notes that of the 50 he sees, 20 of them have spots on their bodies.
- What proportion of the population has spots?
  - If there are 5000 penguins in a region, on the basis of this sample how many would you expect to have spots on their bodies?
  - If there are 500 penguins in a region, how many would you expect not to have spots on their bodies?



## Example 11 Interpreting survey results

A survey is conducted asking 100 randomly selected adults how many children they have. The results are shown in this graph.

- Assume that this sample is representative of the population.
  - What proportion of the adult population has two or more children?
  - In a group of 9000 adults, how many would you expect to have 4 children?
- Describe the shape of the distribution.
- Which of the following methods of conducting the survey could lead to bias?

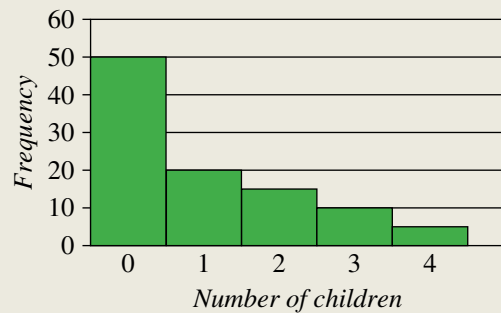

**Method 1:** Asking people waiting outside a childcare centre

**Method 2:** Randomly selecting people at a night club

**Method 3:** Choosing 100 adults at random from the national census and noting how many children they claimed to have

## SOLUTION

a i  $\frac{3}{10}$

ii 450

b Positively skewed

## EXPLANATION

$15 + 10 + 5 = 30$  adults have two or more children.

$$\text{Proportion} = \frac{30}{100} = \frac{3}{10}$$

In the survey  $\frac{5}{100} = \frac{1}{20}$  of the population have four children.

$$\frac{1}{20} \times 9000 = 450$$

Many more people have 0 children, so the distribution is not symmetric.

*Continued on next page*

c Methods 1 and 2 could both lead to bias.

If someone is waiting outside a childcare centre, they are more likely to have at least one child.

If someone is at a night club, they are likely to be a younger adult, and so less likely to have a child.

### Now you try

A survey is conducted asking 40 randomly selected adults how many children they would like to have. The results are shown in this graph.

- a Assume that this sample is representative of the population.
- What proportion of the adult population would like to have four or more children?
  - In a group of 8000 adults, how many would you expect to want no children?
- b Describe the shape of the distribution.
- c Give an example of a method of surveying that is likely to lead to bias.

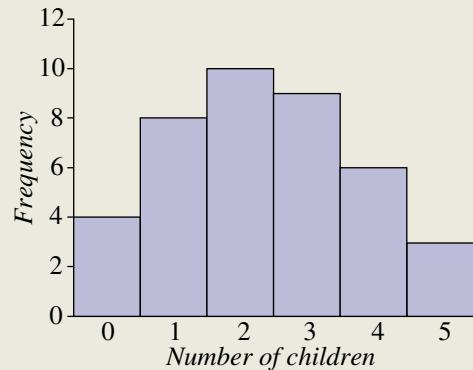

## Exercise 8F

### FLUENCY

1–6

2–7

2–4, 6–8

Example 11a

- 1 Morris notices that of 40 randomly selected cars, 8 have brake pads that are in poor condition.
- What proportion of cars have brake pads in poor condition?
  - If the region had 600 cars, on the basis of this sample how many would you expect to have brake pads in poor condition?

Example 11b

- 2 Use the guide in the **Key ideas** to classify the following as symmetric, positively skewed, negatively skewed or bi-modal.

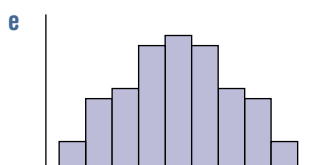
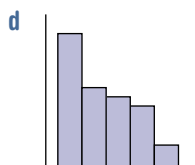
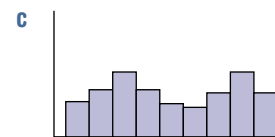
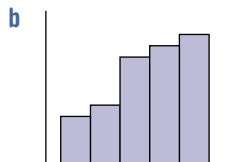
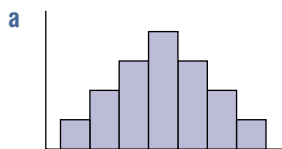

- Example 11c** 3 A survey is conducted asking people how many pets they own. You can assume it is a representative sample of the population.

Pets	0	1	2	3	4	Total
Responses	20	18	6	4	2	50

- Plot the results on a graph.
- Describe the shape of the distribution.
- Of a group of 1000 people, how many of them would you expect to have no pets?
- Of a group of 5000 people, how many of them would you expect to have 2 or more pets?
- Why would conducting this survey outside a veterinary clinic cause a bias in the results?

- Example 11** 4 A survey is conducted to determine how many siblings children have. A simple random sample of 20 children are surveyed. The results are shown in this graph.

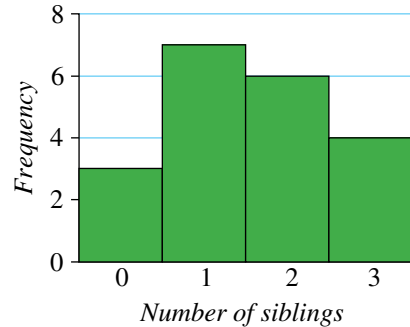

- Assume that this sample is representative of the population.
  - What proportion of the child population has one sibling?
  - In a group of 60 children, how many would you expect to have two siblings?
- Describe the shape of the distribution.
- Which of the following methods of conducting the survey is more likely to lead to bias?

**Method 1:** Choosing 20 children at random from a school.

**Method 2:** Asking 20 children waiting outside a primary school at the end of a day.

- Decide if the following is a *sample* or a *population*. These terms are defined in the **Key ideas**.
  - A group of 10 chocolates is selected from a box of chocolates in a taste test.
  - All the employees of a particular company are surveyed as to how they travel to work.
  - Every electricity bill for the month of January in a state is analysed by the state government.
  - 120 droplets of water are taken from a tank and analysed for their chemical content.
- Zeke attempts to find a relationship between people's ages and their incomes. He is considering some questions to put in his survey. For each question, decide whether it should be included in the survey, giving a brief explanation.
  - What is your current age in years?
  - Are you rich?
  - Are you old?
  - How much money do you have?
  - What is your name?
  - How much money did you earn in the past year?
  - How much money did you receive today?
- Imagine you wanted to know the average number of subjects taken by a student in your high school. You cannot ask everyone in the school but want a sample of 20–30 students.
  - For the following sampling methods, classify them as 'simple random', 'convenience' or 'stratified'.
    - Method 1: Ask the first 24 students you see
    - Method 2: Randomly select 4 students from each year level (Year 7, Year 8, up to Year 12).
    - Method 3: Randomly select 24 students from a list of all students in the school.
  - Compare the three methods above in terms of reliability of any conclusions.

- 8 a Design a survey question to decide the mean number of siblings of a Year 8 student in your school.  
 b Conduct the survey among a random sample of students from your class.  
 c Present the results as a graph.  
 d Comment on whether the distribution is symmetric, positively skewed, negatively skewed or bi-modal.  
 e How might the mean vary based on the random sample you chose?

**PROBLEM-SOLVING**

9

9, 10

9, 10

- 9 For each of the following survey questions, give an example of an unsuitable location and time to conduct the survey if you wish to avoid a bias.  
 a A survey to find the average number of children in a car.  
 b A survey to find how many people are happy with the current prime minister.  
 c A survey to find the proportion of Australians who are vegetarians.  
 d A survey to find the average amount spent on supermarket groceries.
- 10 In a factory producing chocolate bars, a sample of bars is taken and automatically weighed to check whether they are between 50 and 55 grams. The results are shown in a frequency table.

<b>Weight (g)</b>	49	50	51	52	53	54	55	108
<b>Frequency</b>	2	5	10	30	42	27	11	1

- a Which weight value is an outlier?  
 b How could the automatic weighing mechanism have caused this measurement error?  
 c Disregarding the 108 gram result, is this distribution skewed or symmetric?  
 d To find the spread of weights, the machine can calculate the range, or the IQR. Which would be a better value to use? Justify your answer.  
 e If measurement errors are not removed, would the mean or the median be a better guide to the 'central weight' of the bars?
- 11 A survey is being conducted to decide how many adults use mathematics later in life.  
 a If someone wanted to make it seem that most adults do not use mathematics, where and when could they conduct the survey?  
 b If someone wanted to make it seem that most adults use mathematics a lot, where and when could they conduct the survey?  
 c How could the survey be conducted to provide less biased results?

**REASONING**

12

12, 13

13, 14

- 12 Robert wishes to find out how much time high school students spend on homework.  
 a Give some reasons why surveying just his Maths class might introduce bias.  
 b Why would surveying just the people on his soccer team introduce bias?  
 c He decides to choose 50 people from across the whole school. Who should he choose in order to minimise the bias? Justify your answer.  
 d Explain how the mean time spent on homework varies based on the sample chosen.



- 13 In a population of 100 people, a census was conducted to find the number of bedrooms in their main residence.

The results are shown below.

Number of bedrooms	1	2	3	4	5	6
Frequency	5	14	30	38	11	2

The mean number of bedrooms for the population is 3.42. Unfortunately, the complete set of results shown in the table above was not published so a researcher chooses a sample of ten to estimate the number of bedrooms.

- Explain how it could be possible for the researcher to find that the mean number of bedrooms is 4. (State a sample of ten people where the mean is 4.)
  - Explain how it is possible to choose a sample with a mean of 1.5.
  - What is the largest mean value the sample could have?
  - Assuming the researcher is already using a random sample, how could they reduce the amount of variation in sample means?
- 14 Whenever a survey is conducted, even if the people being asked are randomly selected, bias can be introduced by the fact that some people will not answer the questions or return the surveys.
- Assume 1000 surveys are mailed out to a random sample of people asking the question ‘Do you think Australia should be a republic?’ and 200 replies are received: 150 say ‘yes’ and 50 say ‘no’.
    - On the basis of the 200 people who returned the survey, what percentage are in favour of a republic?
    - If all 800 people who did not respond would have said ‘yes’, what percentage are in favour of a republic?
    - If all 800 people who did not respond would have said ‘no’, what percentage are in favour of a republic?
    - If the 1000 people receiving the survey are representative of the Australian population, what conclusion can be drawn about the popularity of a republic?
  - A survey is being conducted to decide how many people feel they are busy. Describe how bias is introduced by the people who agree to participate in the survey.
  - Give an example of another survey question that would cause a bias to be introduced simply on the basis of the people who participate.
  - Sometimes surveys ask the same question in different ways over a number of pages. Although this additional length makes it less likely that people will return the survey, why might the questioner wish to ask the same question in different ways?

#### ENRICHMENT: Media bias

–

–

15

- 15 Search a newspaper, magazine or website and find an example of a survey or poll that has been conducted.
- Decide the following, with justifications.
    - Can you tell if they chose a large enough sample for the survey?
    - Can you tell whether the sample chosen was representative or biased?
    - Would this newspaper, magazine or website have an incentive to choose or publish biased results?
  - Design a perfect survey to get the information that has been reported, and describe how you would choose the survey recipients.
  - Conduct the survey on a small random sample that is representative of the wider population, and compare your results with those reported.

8A

- 1 The column graph represents the monthly profit for a company in its first six months of operation.
- In which month did they have the greatest profit, and how much did they make?
  - What is the difference in profit from February to March?
  - What was the total profit for the six months shown?

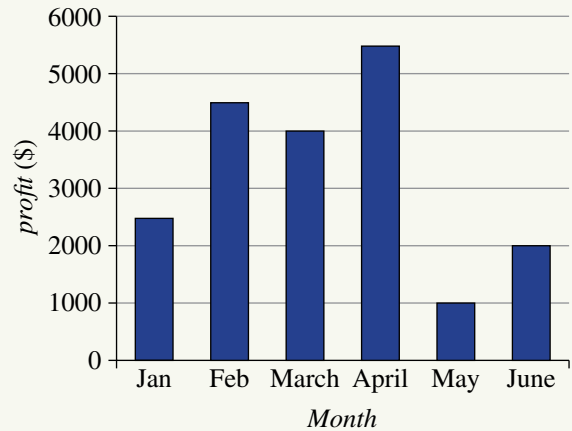

8A

- 2 A pie chart shows the favourite type of drink of a group of students.
- What is the angle of the sector indicating water?
  - If 100 were surveyed, how many said water was their favourite drink?
  - What two types of drinks had the same number of votes?

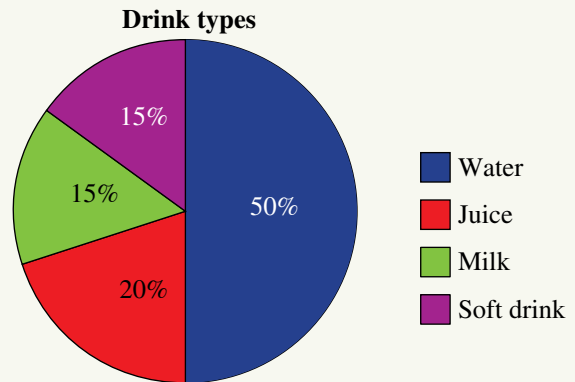

8A

- 3 The height, in centimetres, of a seedling is measured at the same time each day for a week and its height is shown in the line graph.

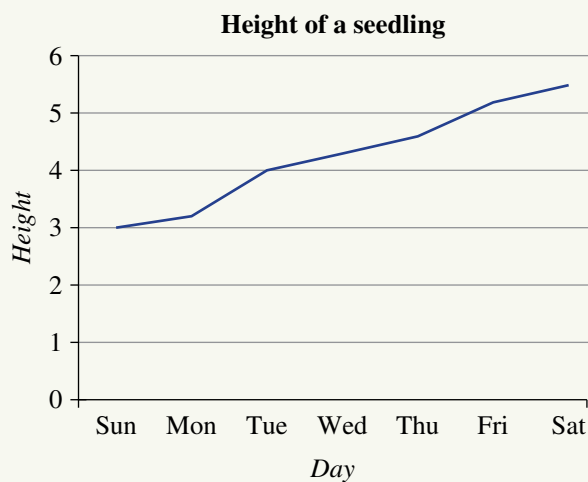

- On which day was the height:
  - 4 cm?
  - 4.6 cm?
  - 55 mm?
- What was the height of the seedling on day 1?
- How many millimetres did the seedling grow over the week?



8C

4 a Draw a dot plot for the frequency table shown.

<b>Value</b>	3	4	5	6	11
<b>Frequency</b>	2	3	1	4	1

- b What is the most common value?
- c State the value of the outlier.

8B/C

5 a Put the following data into a frequency table.

2, 3, 2, 3, 4, 4, 4, 4, 5, 3, 4, 5, 3, 2, 5, 4, 3, 4, 4, 4, 5, 5, 2, 4, 3, 5, 5, 4, 5

<b>Number</b>	2	3	4	5
<b>Tally</b>				
<b>Frequency</b>				

b Represent the frequency table as a frequency graph.

8D

6 For the data set 3, 7, 2, 8, 10:

- a find the mean
- b state the median.

8D/E

7 For the data in Question 4, find the:

- a mean
- b median
- c mode
- d range
- e IQR.



Ext

Ext

8F

8 When conducting a survey, it is important to avoid bias. In each of the following cases within a school, explain how the bias is introduced.

- a Surveying people in a cafeteria to find out how many times per week students eat homemade food.
- b Surveying Year 12 students to find out how much time an average high school student spends on homework.
- c Surveying parents of Year 7 students to find out how many children the average adult has.



## 8G Probability

### LEARNING INTENTIONS

- To understand that a probability is a number between 0 and 1, representing the likelihood of an event
- To know the meaning of the terms: experiment, trial, outcome, event, sample space and complement
- To be able to calculate the probability of simple events

Most people would agree that being hit by lightning and getting rained upon are both possible when going outside, but that rain is more likely. Probability gives us a way to describe how much more likely one event is than another. A probability is a number between 0 and 1 where 0 means ‘impossible’ and 1 means ‘certain’.

If the outcomes are equally likely, we find the probability of an event by counting the ways it can happen and dividing by the total number of outcomes.

### Lesson starter: Estimating probabilities

Try to estimate the probability of the following events, giving a number between 0 and 1. Compare your answers with other students in the class and discuss any differences.

- Flipping a ‘tail’ on a 50-cent coin
- The next word you hear the prime minister say is ‘good’
- Rolling three 6s in a row on a fair die
- Correctly guessing a number between 1 and 10
- Tomorrow being a rainy day
- A shuffled deck of cards having an ace on top

Are there some events for which there is more than one correct answer?



Meteorologists use statistics to calculate probabilities of forecast temperatures, rainfall, thunderstorms, wind speeds and wind directions. These probabilities are important for air traffic control, farming, fishing and emergency services.

### KEY IDEAS

- An **experiment** is a situation involving chance which leads to a set of results.
- A **trial** is a process which can be repeated to produce results.  
For example: flipping a coin, rolling a die or spinning a spinner
- An **outcome** is a possible result of the experiment, like rolling a 5 or a coin showing heads.
- An **event** is either a single outcome (e.g. rolling a 3) or a collection of outcomes (e.g. rolling a 3, 4 or 5).
- The **probability** of an event is a number between 0 and 1 that represents the chance that the event occurs. If all the outcomes are equally likely:

$$\text{Pr}(\text{event}) = \frac{\text{number of favourable outcomes}}{\text{total number of outcomes}}$$

- Probabilities are often written as fractions, but can also be written as decimals or percentages.

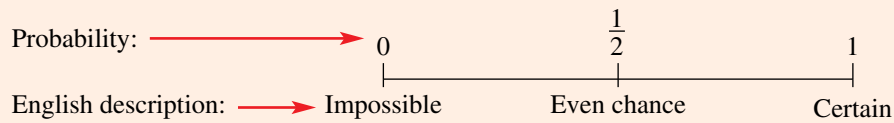

- The **sample space** is the set of possible outcomes of an experiment. For example, the sample space for the roll of a die is  $\{1, 2, 3, 4, 5, 6\}$ .
- The **complement** of some event  $E$  is written  $E'$  (or not  $E$ ).  $E'$  is the event that  $E$  does not occur. For example: the complement of 'rolling the number 3' is 'rolling a number other than 3'.
- For any event, either it or its complement will occur. That is,  $\Pr(E) + \Pr(E') = 1$ .
- The following language is also commonly used in probability:
  - 'at least', for example, 'at least 3' means  $\{3, 4, 5, \dots\}$
  - 'at most', for example, 'at most 7' means  $\{\dots, 5, 6, 7\}$
  - 'or', for example, 'rolling an even number or a 5' means rolling a number from  $\{2, 4, 5, 6\}$
  - 'and', for example, 'rolling an even number and a prime number' means rolling a 2

## BUILDING UNDERSTANDING

- 1 Match each experiment with the set of possible outcomes.

a Flipping a coin	A $\{1, 2, 3, 4, 5, 6\}$
b Choosing a number that is at least 2 and at most 5	B $\{\text{Heads, Tails}\}$
c Choosing a letter of the word MATHS	C $\{2, 3, 4, 5\}$
d Rolling a die	D $\{\text{M,A,T,H,S}\}$

- 2 The following events are shown with their probabilities.

Event A : 0    Event B : 0.9    Event C : 1    Event D : 0.5

- a Which of the four events is most likely to occur?
- b Which of the four events is sure not to occur?
- c Which is more likely – event B or event D?
- d Which event is certain to occur?
- 3 The spinner is spun and could land with the pointer on any of the four sections. Answer true or false for the following.
- a Red and blue are equally likely outcomes.
- b Green is less likely to occur than blue.
- c The probability of it landing yellow is 0.
- d Red is less likely to occur than green.

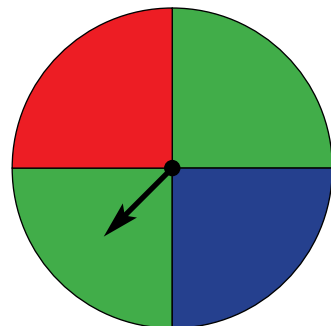



### Example 12 Working with probabilities

The letters of the word PRINCE are written onto 6 equal-sized cards and one is chosen at random.

- List the sample space.
- Find  $\Pr(\text{the letter N is chosen})$ .
- What is the sample space of the event  $V = \text{choosing a vowel}$ ?
- Find  $\Pr(V)$ .
- State the sample space of the complement of choosing a vowel, written  $V'$ .
- Find  $\Pr(V')$ .

#### SOLUTION

**a**  $\{P, R, I, N, C, E\}$

**b**  $\Pr(N) = \frac{1}{6}$

**c**  $\{I, E\}$

**d**  $\Pr(V) = \frac{2}{6}$   
 $= \frac{1}{3}$

**e**  $\{P, R, N, C\}$

**f**  $\Pr(V') = \frac{4}{6}$   
 $= \frac{2}{3}$

#### EXPLANATION

The sample space is all the possible outcomes when a single card is chosen. In this case each of the letters in the word.

There are 6 equally likely cards and 1 of them has the letter N.

The sample space  $V$  includes all the vowels in the word PRINCE.

There are 2 cards with vowels, so probability  $= 2 \div 6$ .

The complement of  $V$  is all the outcomes that are not in  $V$ , i.e. all the letters that are not vowels.

There are 4 cards that do not have vowels.

Alternatively,  $\Pr(V') = 1 - \Pr(V)$

$$\begin{aligned} \text{so } \Pr(V') &= 1 - \frac{1}{3} \\ &= \frac{2}{3} \end{aligned}$$

#### Now you try

The letters of the word SPARE are written onto 5 equal-sized cards and one is chosen at random.

- List the sample space.
- Find  $\Pr(\text{the letter R is chosen})$ .
- What is the sample space of the event  $V = \text{choosing a vowel}$ ?
- Find  $\Pr(V)$ .
- State the sample space of the complement of choosing a vowel, written  $V'$ .
- Find  $\Pr(V')$ .

**Example 13** Finding probabilities involving complementary events

- a Find  $\Pr(A')$  if  $\Pr(A) = \frac{3}{5}$   
b Find  $\Pr(B)$  if  $\Pr(B') = 0.8$

**SOLUTION**

a  $\Pr(A') = 1 - \Pr(A)$   
 $= 1 - \frac{3}{5}$   
 $= \frac{5}{5} - \frac{3}{5}$   
 $= \frac{2}{5}$

b  $\Pr(B) = 1 - \Pr(B')$   
 $= 1 - 0.8$   
 $= 0.2$

**EXPLANATION**

Complementary events add to 1, so  
 $\Pr(A') = 1 - \Pr(A)$ .  
Convert to the same denominator to subtract.

Complementary events add to 1, so  
 $\Pr(B) = 1 - \Pr(B')$ .

**Now you try**

- a Find  $\Pr(A')$  if  $\Pr(A) = \frac{5}{6}$                       b Find  $\Pr(B)$  if  $\Pr(B') = 0.3$

**Exercise 8G****FLUENCY**

1–4

2–5, 7

2, 4, 6, 7

- Example 12** 1 The letters of the word PIANO are written on 5 cards and then one card is drawn from a hat at random.
- a List the sample space.
  - b Find  $\Pr(\text{the letter A is chosen})$ .
  - c What is the sample space of the event  $C = \text{choosing a consonant}$ ?
  - d Find  $\Pr(C)$ .
  - e State the sample space of the complement of choosing a consonant,  $C'$ .
  - f Find  $\Pr(C')$ .
- Example 12** 2 A fair die is rolled.
- a List the sample space.
  - b Find  $\Pr(5)$ . That is, find the probability that a 5 is rolled.
  - c Find  $\Pr(\text{even number})$ .
  - d State the sample space of the complement of ‘rolling a 5’.
  - e State the probability that a 5 is not rolled.
  - f What is the probability of rolling a 14?



## PROBLEM-SOLVING

8, 9

9–11

10–12

- 8 On a game show, a wheel is spun for a prize with the options as shown.
- Joan wants to go on a \$10 000 holiday so she is happy with the cash or the holiday. What is the probability she will get what she wants?
  - What is the probability of getting a prize that is not the cash?
  - What is  $\Pr(\text{car or motorbike})$ ?
  - What is the probability of winning a prize?

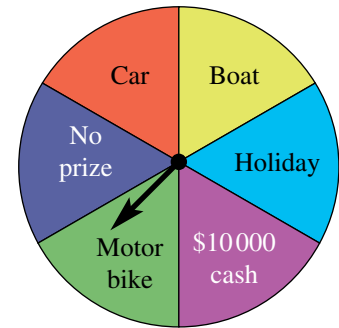

- 9 In a lucky dip, a person chooses an item at random. Of the twenty possible items, there are eight prizes that are worth money. What is the probability that a prize is selected that is not worth money? Answer as a fraction.
- 10 Jake has a collection of equally shaped and sized marbles in his pocket. Some are blue, some are green and some are white. It is known there is a 0.3 chance of a green marble being chosen, and a 0.75 chance of not choosing a blue marble.
- What is the probability of not choosing a green marble?
  - What is the probability of choosing a blue marble?
  - Find the probability of choosing a white marble. (*Hint*: The sum of the three colours' probabilities is 1.)
  - What is the minimum number of marbles Jake could have in his pocket?
- 11 A weighted die has the numbers 1 to 6, but the probability of each number occurring is unknown. Decide whether or not the following statements are guaranteed to be true for this die.
- |  |   |
|--|---|
| a $\Pr(3) = \frac{1}{6}$                                 | b $\Pr(\text{at least } 4) = \Pr(4) + \Pr(5) + \Pr(6)$            |
| c $\Pr(\text{at least } 1) = 1$                          | d $\Pr(\text{odd}) = \Pr(\text{even})$                            |
| e $\Pr(\text{odd}) + \Pr(\text{even}) = 1$               | f $\Pr(\text{at most } 3) = 1 - \Pr(\text{at least } 3)$          |
| g $\Pr(\text{at most } 4) = 1 - \Pr(\text{at least } 5)$ | h $\Pr(\text{at most } 4) + \Pr(\text{at least } 4) = 1 + \Pr(4)$ |

- 12 Six counters coloured red, purple or orange are placed in a pocket. You are told that

$$\Pr(\text{red or orange}) = \frac{1}{2} \text{ and } \Pr(\text{red or purple}) = \frac{2}{3}.$$

- How many counters of each colour are there?
- State  $\Pr(\text{red})$ .
- Find  $\Pr(\text{purple})$ .
- Find  $\Pr(\text{orange})$ .

## REASONING

13

13

13, 14

- 13 In a large bucket there are 2 red balls and 8 blue balls.
- State  $\Pr(\text{red})$ .
  - One of each colour is added. What is the new  $\Pr(\text{red})$ ?
  - The procedure of adding a red ball and a blue ball is repeated several times. How many balls are in the bucket when  $\Pr(\text{red}) = \frac{1}{3}$ ?
  - Imagine the procedure is repeated many times. What value does  $\Pr(\text{red})$  eventually approach as more balls are added? It might be helpful to imagine 1000 balls of each colour are added and use decimals.

- 14 In a driving test, each student can pass or fail. That is, pass and fail are complements of each other. For Noni,  $\Pr(\text{pass}) = 0.4$  and for Anthony,  $\Pr(\text{pass}) = 0.6$ .
- Maria says she is twice as likely to pass as Noni. What is Maria's probability of passing?
  - Olivia says she is twice as likely to fail as Anthony. Find the following probabilities.
    - $\Pr(\text{Anthony fails})$
    - $\Pr(\text{Olivia fails})$
    - $\Pr(\text{Olivia passes})$
  - If the probability of Noni passing is  $p$ , what is the probability of someone passing if they are twice as likely as Noni to pass? Write an expression involving  $p$ .
  - If the probability of Anthony passing is  $p$ , what is the probability of passing of someone who is twice as likely as Anthony to fail? Write an expression involving  $p$ .
  - Give an example to illustrate the difference between being twice as likely to fail and half as likely to pass.

**ENRICHMENT: Marble puzzle**

15

- 15 A bag initially contains 7 blue, 2 red and 6 green marbles. For each of the following, describe which marbles were removed from the bag.
- 3 marbles are removed. Now  $\Pr(R) = 0$ ,  $\Pr(B) = \frac{1}{2}$ .
  - 3 marbles are removed. Now  $\Pr(B) = \Pr(G)$  and  $\Pr(R) = \frac{1}{6}$ .
  - 5 marbles are removed. Now  $\Pr(G) < \Pr(R) < \Pr(B)$ .
  - 12 marbles are removed. Now  $\Pr(B) = \Pr(G) = \Pr(R)$ .
  - 1 marble is removed. Now  $\Pr(B) = \frac{1}{2}$ ,  $\Pr(G) = \frac{5}{14}$ .
  - Some marbles are removed. Now  $\Pr(G) \times 2 = \Pr(R)$  and  $\Pr(R) \times 3 = \Pr(B)$ .
  - Some marbles are removed. Now  $\Pr(R) = \frac{1}{2}$  and  $\Pr(B) = \Pr(G) = \frac{1}{4}$ .



## 8H Two-step experiments

### LEARNING INTENTIONS

- To understand that a table can be used to list the sample space of a two-step experiment
- To be able to calculate the probability of events in two-step experiments

Sometimes an experiment consists of two independent steps, such as when a coin is tossed and then a die is rolled. Or perhaps a card is pulled from a hat and then a spinner is spun. We can use tables to list the sample space.

Consider the following example in which a coin is flipped and then a die is rolled.

		Die					
		1	2	3	4	5	6
Coin	Heads	H1	H2	H3	H4	H5	H6
	Tails	T1	T2	T3	T4	T5	T6

There are 12 outcomes listed in the table. So the probability of getting a ‘tail’ combined with the number 5 is  $\frac{1}{12}$ .



Psychologists record observations of people’s social interactions and thinking processes. Statistical methods are used to analyse and interpret the data, providing psychologists with a better understanding of another person’s experiences.

### Lesson starter: Monopoly mystery

In a board game, two dice are rolled and the player moves forward by their sum.

- What are the possible values that the sum could have?
- Are some values more likely than others? Discuss.
- How likely is it that the numbers showing on the two dice will add to 5?

## KEY IDEAS

- If an experiment has two independent steps, the outcomes can be listed as a table.
- The probability is still given by:

$$\Pr(\text{event}) = \frac{\text{number of favourable outcomes}}{\text{total number of possible outcomes}}$$

## BUILDING UNDERSTANDING

- 1 A coin is flipped and then a spinner is spun. The possible outcomes are listed in the table below.

	1	2	3	4	5
H	H1	H2	H3	H4	H5
T	T1	T2	T3	T4	T5

- a How many outcomes are possible?
  - b List the four outcomes in which an even number is displayed on the spinner.
  - c Hence, state the probability that an even number is displayed.
  - d List the outcomes for which tails is flipped and an odd number is on the spinner.
  - e What is  $\Pr(\text{T, odd number})$ ?
- 2 Two coins are flipped and the four possible outcomes are shown below.

		20-cent coin	
		H	T
50-cent coin	H	HH	HT
	T	TH	TT

- a What is the probability that the 50-cent coin will be heads and the 20-cent coin will be tails?
- b For which outcomes are the two coins displaying the same face?
- c What is the probability of the two coins displaying the same face?



The sample space from rolling two dice can be listed in a table.



### Example 14 Using a table for two-step experiments

A spinner with the numbers 1, 2 and 3 is spun, and then a card is chosen at random from the letters ATHS written on four cards.

- Draw a table to list the sample space of this experiment.
- How many outcomes does the experiment have?
- Find the probability of the combination 2S.
- Find the probability of an odd number being spun and the letter H being chosen.

#### SOLUTION

a

	A	T	H	S
1	1A	1T	1H	1S
2	2A	2T	2H	2S
3	3A	3T	3H	3S

b There are 12 outcomes.

c  $\Pr(2S) = \frac{1}{12}$

d  $\Pr(\text{odd, H}) = \frac{2}{12} = \frac{1}{6}$

#### EXPLANATION

The sample space of the spinner (1, 2, 3) is put into the left column.

The sample space of the cards (A, T, H, S) is put into the top row.

The table has  $4 \times 3 = 12$  items in it.

All 12 outcomes are equally likely. Spinning 2 and choosing an S is one of the 12 outcomes.

Possible outcomes are 1H and 3H, so probability =  $2 \div 12$ .

#### Now you try

A spinner with the numbers 1, 2, 3 and 4 is spun and then a card is chosen at random from the letters PIE written on three cards.

- Draw a table to list the sample space of this experiment.
- How many outcomes does the experiment have?
- Find the probability of the combination 3P.
- Find the probability of an even number being chosen together with a vowel.

## Exercise 8H

### FLUENCY

1–3

2–4

2–4

Example 14

- 1 A coin is flipped and then a die is rolled.

- a Copy and complete the table shown to list the sample space of this experiment.

	1	2	3	4	5	6
H	H1					
T						T6

- How many possible outcomes are there?
- Find the probability of the pair H3.
- Find the probability of 'heads' on the coin with an odd number on the die.

- Example 14**
- 2** A letter is chosen from the word LINE and another is chosen from the word RIDE.
- Draw a table to list the sample space.
  - How many possible outcomes are there?
  - Find  $\Pr(\text{NR})$ , i.e. the probability that N is chosen from LINE and R is chosen from RIDE.
  - Find  $\Pr(\text{LD})$ .
  - Find the probability that two vowels are chosen.
  - Find the probability that two consonants are chosen.
  - Find the probability that the two letters chosen are the same.
- 3** The spinners shown below are each spun.

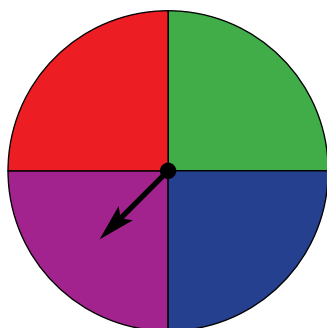

Spinner 1

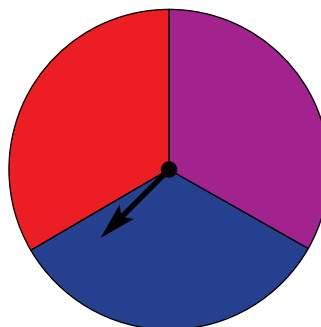

Spinner 2

- Draw a table to list the sample space. Use R for red, P for purple and so on.
  - Find the probability that spinner 1 will display red and spinner 2 will display blue.
  - Find the probability that both spinners will display red.
  - What is the probability that spinner 1 displays red and spinner 2 displays purple?
  - What is the probability that one of the spinners displays red and the other displays blue?
  - What is the probability that both spinners display the same colour?
  - What is the probability that the spinners display a different colour (that is, the complement of displaying the same colour)?
- 4** A letter from the word EGG is chosen at random and then a letter from ROLL is chosen at random. The sample space is shown below.

	R	O	L	L
E	ER	EO	EL	EL
G	GR	GO	GL	GL
G	GR	GO	GL	GL

- Find  $\Pr(\text{ER})$ .
- Find  $\Pr(\text{GO})$ .
- Find  $\Pr(\text{both letters are vowels})$ .
- Find  $\Pr(\text{both letters are consonants})$ .

## PROBLEM-SOLVING

5

5, 6

6, 7

- 5 Two dice are rolled for a board game. The numbers showing are then added together to get a number between 2 and 12.
- Draw a table to describe the sample space.
  - Find the probability that the two dice add to 5.
  - Find the probability that the two dice do not add to 5. Recall that complementary events add to 1.
  - What is the most likely sum to occur?
  - What are the two least likely sums to occur between 2 and 12?
- 6 In Rosemary's left pocket she has two orange marbles and one white marble. In her right pocket she has a yellow marble, a white marble and 3 blue marbles. She chooses a marble at random from each pocket.
- Draw a table to describe the sample space. (*Hint:* The left-pocket outcomes are W, O, O.)
  - Find the probability that she will choose an orange marble and a yellow marble.
  - What is the probability that she chooses a white marble and a yellow marble?
  - What is the probability that she chooses a white marble and an orange marble?
  - Find the probability that a white and a blue marble are selected.
  - What is the probability that the two marbles selected are the same colour?
- 7 In a game show, a wheel is spun to determine the prize money and then a die is rolled. The prize money shown is multiplied by the number on the die to give the total winnings.
- What is the probability that a contestant will win \$6000?
  - What is the probability that they win more than \$11 000?
  - What is the probability they will win \$11 000 or less?

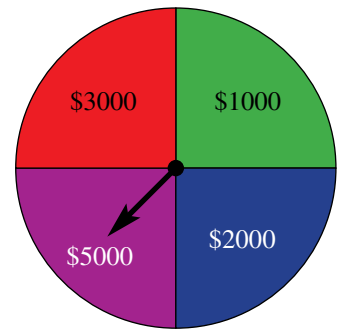

## REASONING

8

8, 9

9, 10

- 8 Two separate experiments are conducted simultaneously. The first has 7 possible outcomes and the second has 9 outcomes. How many outcomes are there in the combined experiment?
- 9 When two dice are rolled, there is a  $\frac{1}{36}$  chance they will multiply to 1 and a  $\frac{1}{9}$  chance they will multiply to 6.
- What is the probability they do not multiply to 1?
  - What is the probability they do not multiply to 6?
  - What is the probability they multiply to 1 or 6?
  - What is the probability they do not multiply to 1 or 6?

10 In a deck of cards there are four suits ( $\heartsuit$ ,  $\spadesuit$ ,  $\clubsuit$ ,  $\diamondsuit$ ) and 13 cards in each suit (A, 2, 3, 4, 5, 6, 7, 8, 9, 10, J, Q, K).  $\heartsuit$ ,  $\diamondsuit$  are red suits.

- If a card is chosen at random, what is  $\Pr(3\diamondsuit)$ ?
- What is  $\Pr(\text{red king})$ ?
- If two cards are chosen at random from separate decks, what is the probability that they are both diamonds? (*Hint*: Do not draw a  $52 \times 52$  table.)
- If two cards are chosen at random from separate decks, what is the probability that they are both red cards?
- What is the probability that  $3\diamondsuit$  is chosen from both decks?
- Why is it important that the two cards are chosen from separate decks? How would your answers to parts c–e change if the two cards were drawn from the same deck?

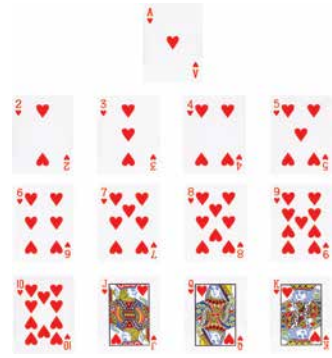

**ENRICHMENT: Spinners with unequal areas**

11

11 Spinner 1 and Spinner 2 are identical in terms of their probabilities, even though the regions in Spinner 2 do not have equal areas.

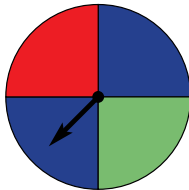

**Spinner 1**

Outcomes: {R, G, B, B}

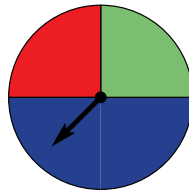

**Spinner 2**

Outcomes: {R, G, B, B}

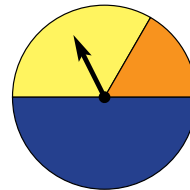

**Spinner 3**

Outcomes: {B, Y, O}

- Use the fact that Spinner 1 and Spinner 2 are equivalent to find the following probabilities for Spinner 2:
  - $\Pr(\text{red})$
  - $\Pr(\text{blue})$ .
- Spinner 2 is also equivalent to choosing a letter from the word RGBB. If Spinner 2 is spun twice, what is the probability of:
  - two reds?
  - two blues?
  - a red, then a green?
  - a red and a green (in either order)?
- Spinner 3 has  $\Pr(\text{orange}) = \frac{1}{6}$ ,  $\Pr(\text{yellow}) = \frac{1}{3}$  and  $\Pr(\text{blue}) = \frac{1}{2}$ .  
What 6 letters could be used to describe the 6 equally likely outcomes when Spinner 3 is spun?
- If Spinner 3 is spun twice, find the probability of obtaining:
  - yellow twice
  - the same colour twice
  - orange and then blue
  - orange and blue (either order)
  - at least one orange
  - at least one blue.
- Spinners 2 and 3 are both spun. Find the probability of obtaining:
  - red then orange
  - green then blue
  - orange and not blue
  - both blue
  - neither blue
  - neither red.

The following problems will investigate practical situations drawing upon knowledge and skills developed throughout the chapter. In attempting to solve these problems, aim to identify the key information, use diagrams, formulate ideas, apply strategies, make calculations and check and communicate your solutions.

## Reducing traffic around a school

- 1 At Kingham State School there is growing concern about the volume of traffic around the school and the increased danger to student safety. The main road causing concern is School Road.

For ten consecutive school days, Jim, a Year 8 student at Kingham State School, determines the number of cars driving along School Road between 8 a.m. and 9 a.m., and the results are shown.

Week 1	Cars 8 a.m. – 9 a.m.	Week 2	Cars 8 a.m. – 9 a.m.
Monday	815	Monday	805
Tuesday	804	Tuesday	781
Wednesday	765	Wednesday	1150
Thursday	839	Thursday	790
Friday	912	Friday	989

*Jim wishes to reduce the likelihood of an accident by conducting a statistical analysis of the collected data and making recommendations to the school.*

- What is the mean number of cars using School Road between 8 a.m. and 9 a.m. over this two-week period?
- What is the median number of cars using School Road between 8 a.m. and 9 a.m. over this two-week period?
- To support Jim's case, should he refer to the centre of the data using the mean or the median figure?
- There was clearly a spike in cars on Wednesday of week 2. Why do you suggest this might have been? If the spike had been 2150, rather than just 1150, what would the effect have been on the mean and median number of cars over the two weeks?
- Over the two weeks, on average, which day of the week was the busiest day and which day was the quietest day?
- What is the range and the interquartile range for Jim's data?

Jim decides to collect the same data for a third week.

- Jim finds his mean for the whole three weeks to be 920. What must have been the mean for the number of cars in week 3 alone?
- What is the median weekly number of cars travelling along School Road between 8 a.m. and 9 a.m.?

Jim hopes the range between the weeks is relatively small to show how consistent the problem is, and that the problem is not just on special days. He hopes the range for the weekly number of cars is less than 100.

- Calculate the range for the mean weekly number of cars travelling along School Road between 8 a.m. and 9 a.m.

## Supermarket checkout queues

- 2 In general, people do not like to wait in a queue to be served. At the same time, store owners do not like their cashiers having no customers. It is a fine balance for store owners to determine how many employees they roster to work; they want to provide an excellent service to customers but need to be careful how much money they spend on staff salaries.

Janis is the manager of a small supermarket in her local town. For a number of consecutive days, Janis observes the queues at exactly 5 p.m. and then determines the mean number of customers waiting in line across each of the open checkouts. Her data is shown:

Mean number of customers in a queue at 5 p.m.	Frequency
0	1
1	12
2	26
3	8
4	3

*Janis is interested to understand how long her checkout queues are, particularly at the peak time of 5 p.m. on weekdays.*

- How many days did Janis observe the queues at 5 p.m.?
- What was the mean, median and mode number of customers in the queue over the observed days?
- Determine the observed probabilities for the number of customers in a queue at 5 p.m.
- What is the probability at 5 p.m. that there will be on average two or more people in the queue?
- If Janis continued her observations for the whole year (365 days), how many times would you expect there to be 1 person in the queue at 5 p.m.? Give your answer to the nearest whole number of days.





## The reasons for car accidents

- 3 Sylvia is a research statistician at the TAC (Transport Accident Commission). She has just received police reports for non-fatal car accidents over the past six months in her district. She reads through the 120 accident reports and produces the table of data on the right, which summarises the contributing factors for the accidents.

Contributing factor	Frequency
Speed	58
Alcohol	39
Mobile phone use	61
Drugs	32
Poor weather	11
Poor road conditions	16
Tiredness	34
Distraction	27
Other	10

*By analysing this data and doing some further research, Sylvia is aiming to pinpoint the main contributing factors in non-fatal car accidents.*

- What is the number of different factors Sylvia listed as contributing to these accidents?
- What is the probability that a non-fatal car accident had 'mobile phone use' as a contributing factor to the accident? Give your answer correct to 2 decimal places.
- What is the total frequency of contributing factors in these accidents?
- On average, how many factors did Sylvia find contributed to each of the accidents?
- What is the probability that drugs, speed or alcohol are a contributing factor in a non-fatal car accident? Give your answer correct to 2 decimal places.

Sylvia wishes to create a Venn diagram for the interrelated car accident factors of alcohol, drugs and speed.

- In drawing a three-circle Venn diagram, how many different categories will Sylvia create?

In re-reading the police reports, Sylvia collated the following information:

- Alcohol listed as a contributing factor: 39
  - Drugs only listed as a contributing factor: 4
  - Speed and alcohol but not drugs listed as a contributing factor: 20
- Only two of the above three findings can be directly placed into a Venn diagram. Which one cannot and why?

Sylvia also finds that:

- 75 of the 120 accidents had at least one of the three factors of alcohol, drugs or speed
  - 13 of the accidents had drugs and speed as contributing factors, but not alcohol.
- Using all the relevant information Sylvia has discovered, draw a completed three-circle Venn diagram for the interrelated car accident factors of alcohol, drugs and speed.
  - From these police reports, what is the probability that all three factors of alcohol, drugs and speed are involved in a non-fatal car accident?

## 81 Tree diagrams

### LEARNING INTENTIONS

- To understand that a tree can be used to list the outcomes of experiments involving two or more steps
- To be able to use a tree diagram to determine the probability of events in multi-step events

When two coins are flipped, we can draw a table to list the sample space. But if three coins are flipped, then we would need a three-dimensional table to list all outcomes. Imagine trying to find probabilities when five coins are flipped!

Another tool that mathematicians use for probability is the tree diagram. This tree diagram describes the four outcomes when two coins are flipped.

It is important to be able to read a tree diagram correctly. The first row (HH) represents the outcome where the first coin flipped was heads and the second coin flipped was heads. The third row (TH) represents the outcome where the first coin was tails and the second was heads.

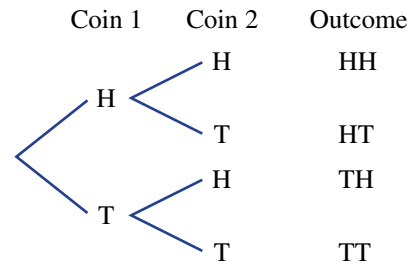

Viral marketing occurs when social media users advertise a product to friends. A calculation based on a tree diagram shows that if each person shares with 5 others, then, after 9 stages of sharing, over 2 million people have received this advertising.

### Lesson starter: Coin puzzle

- If two coins are flipped, rank these outcomes from most likely to least likely.
  - Exactly two heads are flipped.
  - Exactly one head and exactly one tail are flipped.
  - At least one coin shows tails.
  - Three tails are shown.
- How might the order change if three coins are flipped?  
Compare your answers with other students.

### KEY IDEAS

■ A **tree diagram** can be used to list the outcomes of experiments that involve two or more steps.

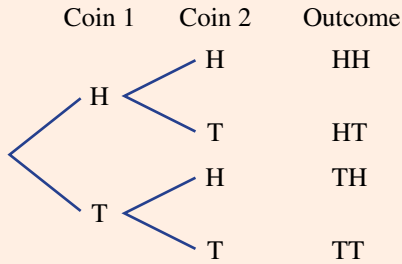

■ At this stage, we will only consider tree diagrams for which each branch corresponds to an equally likely outcome.

### BUILDING UNDERSTANDING

- 1 Two coins are flipped.
- State the missing parts to complete the tree diagram on the right.
  - How many equally likely outcomes are possible?

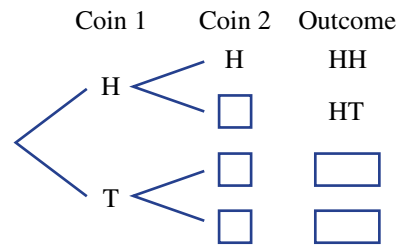

- 2 A letter from the word ON is chosen and then a letter from the word FOR is chosen.
- State the missing parts to complete the tree diagram.
  - State the missing outcomes. The sample space is OF, OO, \_\_\_\_\_, \_\_\_\_\_, \_\_\_\_\_, \_\_\_\_\_.
  - How many equally likely outcomes are there in total?
  - How many outcomes have two consonants?

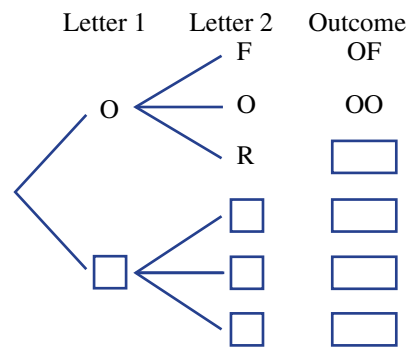



### Example 15 Using tree diagrams

Three fair coins are flipped.

- List the sample space using a tree diagram.
- How many possible outcomes are there?
- Find the probability that the first coin is heads and the next two are tails.
- Find the probability that exactly two of the coins show heads.

#### SOLUTION

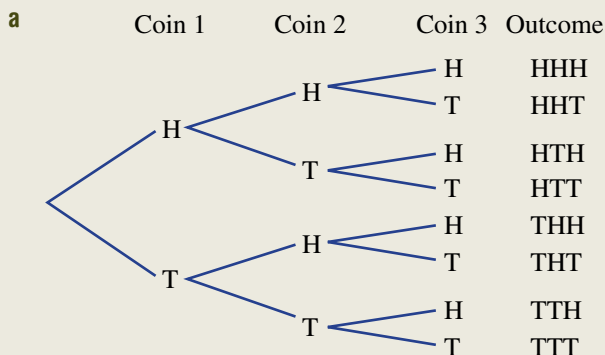

- There are 8 possible outcomes.

- $\Pr(\text{HTT}) = \frac{1}{8}$

- Outcomes: HHT, HTH, THH  
 $\Pr(\text{exactly 2 heads}) = \frac{3}{8}$

#### EXPLANATION

Each coin has two outcomes: heads (H) and tails (T). After each coin is flipped, the next coin has two outcomes, so the tree branches out.

They are listed: HHH, HHT, HTH, HTT, THH, THT, TTH, TTT.

This is just one of the eight equally likely outcomes.

List the outcomes with exactly two heads. There are 3 of them so the probability is  $\frac{3}{8}$ .

#### Now you try

A spinner consists of two equally sized regions: red and blue. It is spun three times.

- List the sample space using a tree diagram.
- How many possible outcomes are there?
- Find the probability that the first spin is blue and the next two spins show red.
- Find the probability that all spins show the same colour.

## Exercise 81

### FLUENCY

1, 2

2, 3

2, 3

- Example 15** 1 A letter from the word CAT is chosen and then a letter from the word GO is chosen.
- a List the sample space using a tree diagram.      b How many outcomes are possible?  
 c Find  $\Pr(\text{C then G})$ .      d Find  $\Pr(\text{T then O})$ .  
 e Find  $\Pr(\text{2 consonants})$ .
- Example 15** 2 A spinner with numbers 1, 2 and 3 is spun twice.
- a Show the sample space in a tree diagram.      b Find  $\Pr(\text{1 then 1})$ .  
 c Find  $\Pr(\text{1 then 2})$ .      d Find  $\Pr(\text{1 and 2 spun in either order})$ .  
 e Find  $\Pr(\text{both show the same number})$ .      f Find  $\Pr(\text{numbers add to 4})$ .
- Example 15** 3 A coin is tossed three times.
- a Draw a tree diagram to represent the sample space.  
 b Find  $\Pr(\text{3 tails})$ .  
 c Find  $\Pr(\text{at least one head})$ . (*Hint: This is the complement of 3 tails.*)  
 d Find  $\Pr(\text{2 tails then 1 head})$ .  
 e Find  $\Pr(\text{2 tails and 1 head, in any order})$ .  
 f Which is more likely: getting exactly 3 tails or getting exactly 2 tails?  
 g Find the probability of getting at least 2 tails.

### PROBLEM-SOLVING

4

4, 5

5, 6

- 4 Two letters are chosen from the word CAR. Once a letter is chosen it cannot be chosen again.
- a Draw a tree diagram of the six possible outcomes.  
 b What is the probability that A and C will be chosen?  
 c Find  $\Pr(\text{2 consonants})$ .  
 d Find  $\Pr(\text{2 vowels})$ .  
 e What is the probability that the letters chosen will be different?
- 5 In a game a prize wheel is spun, then a die is rolled and finally a coin is flipped. If the coin displays heads, you win the prize multiplied by the amount on the die. If the coin displays tails, you get nothing.
- a What amount do you win if you spin \$20 then roll a 5 and then flip heads?  
 b Draw a tree diagram showing the 36 possible outcomes.  
 c What is the probability that you win \$80?  
 d Find  $\Pr(\text{win } \$100 \text{ or more})$ .  
 e Find  $\Pr(\text{receive less than } \$15)$ . Include the possibility that you get nothing.

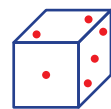
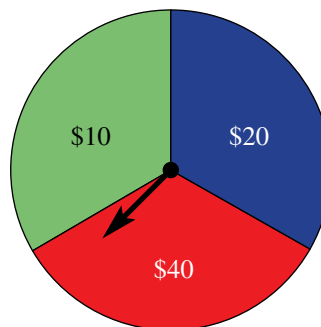

- 6 The letters of the word PIPE are placed on four cards. Two of the cards are chosen.
- Draw a tree diagram showing all 12 outcomes.
  - Find  $\Pr(2 \text{ vowels})$ .
  - Find  $\Pr(\text{the same letter is on the 2 cards})$ .
  - What is  $\Pr(\text{at least one letter is a P})$ ?

## REASONING

7

8–10

9–11

- 7 If 2 coins are tossed there are 4 outcomes. If 3 coins are tossed there are 8 outcomes. How many outcomes are there if 5 coins are tossed?
- 8
- If a coin is flipped 4 times, what is the probability that it will display heads four times?
  - If a coin is flipped 4 times, what is the probability that it will display H, T, T, H in that order?
  - If a coin is flipped 5 times, which is more likely: the result HHHHH or the result HTHHT?
  - If a coin is flipped 5 times, which is more likely: 5 heads or 3 heads?
  - Explain why your answers to parts **c** and **d** are different.
- 9 The words WORM and MORROW both have four different letters.
- What is the difference between choosing 2 letters from WORM and choosing 2 letters from MORROW?
  - Give an example of an event that is impossible when choosing 2 letters from WORM but not impossible when choosing 2 from MORROW.
- 10 If 3 coins are flipped, there are many possible events. For example,  
 $\Pr(\text{exactly 3 heads}) = \frac{1}{8}$  and  $\Pr(\text{first coin is tails}) = \frac{1}{2}$ . Give an example of an event using 3 coins that has the following probabilities.
- a  $\frac{1}{4}$       b  $\frac{5}{8}$       c  $\frac{3}{4}$       d  $\frac{7}{8}$       e 0      f 1
- 11 A word has 5 different letters that are written on cards.
- How many different outcomes will there be if 2 letters are chosen? The order matters, so EP and PE are different outcomes.
  - How many different outcomes will there be if 5 letters are chosen? Again, the order does matter.
  - Assume that 4 letters are chosen from the word MATHS. What is the probability that they are all consonants? (*Hint*: Choosing 4 letters to consider is the same as choosing 1 letter to ignore.)
  - If 4 letters are chosen from the word MATHS, what is the probability that at least one is a vowel?

## ENRICHMENT: Lucky test

–

–

12

- 12 In a test a student has to flip a coin 5 times. They get 1 point for every time they flip 'heads' and 0 when the flip 'tails'. Their final score is out of 5.
- Draw a tree diagram for this situation.
  - What is  $\Pr(5 \text{ out of } 5)$ ?
  - What is  $\Pr(0 \text{ out of } 5)$ ?
  - To pass the test they must get at least 50%. What is  $\Pr(\text{pass the test})$ ?
  - What is  $\Pr(2 \text{ out of } 5)$ ?
  - If a student gets 2 out of 5 they may sit a re-test in which they flip 10 coins. What is the probability that a student sitting the re-test will pass? Try to list the outcomes systematically.



## 8J Venn diagrams and two-way tables

### LEARNING INTENTIONS

- To understand that two-way tables and Venn diagrams can be used to show the number of possible outcomes when two different events are considered
- To understand that 'or' can mean 'inclusive or' or 'exclusive or' depending on the context or wording
- To be able to construct a Venn diagram from a worded situation
- To be able to construct a two-way table from a worded situation

When two events are being considered, Venn diagrams and two-way tables give another way to view the probabilities. They can be useful when survey results are being considered and converted into probabilities.

### Lesson starter: Are English and Mathematics enemies?

Conduct a poll among students in the class, asking whether they like English and whether they like Maths. Use a tally like the one shown.

	Like Maths	Do not like Maths
Like English	### I	### IIII
Do not like English	### IIII I	### II

Use your survey results to debate these questions:

- Are the students who like English more or less likely to enjoy Maths?
- If you like Maths does that increase the probability that you will like English?
- Which is the more popular subject within your class?



Survey results can give the number of people in various age groups who respond positively to an advertisement. Market analysts can then use Venn diagrams or two-way tables to analyse this advertisement's effectiveness for these age groups.

### KEY IDEAS

- A **two-way table** shows the number of outcomes or people in different categories, with the final row and column being the total of the other entries in that row or column. For example:

	Like Maths	Do not like Maths	Total
Like English	28	33	61
Do not like English	5	34	39
Total	33	67	100

- A two-way table can be used to find probabilities.

For example:

$$\Pr(\text{like Maths}) = \frac{33}{100}$$

$$\Pr(\text{like Maths and not English}) = \frac{5}{100} = \frac{1}{20}$$

■ A **Venn diagram** is a pictorial representation of a two-way table without the total row and column. The two-way table on the previous page can be written as shown.

■ The word ‘or’ can sometimes mean ‘inclusive or’ (A or B or both), and it can sometimes mean ‘exclusive or’ (A or B but not both).

■ Two events are **mutually exclusive** if they cannot both occur at the same time, e.g. ‘rolling an odd number’ and ‘rolling a 6’ are mutually exclusive.

If A and B are mutually exclusive:

Venn diagram

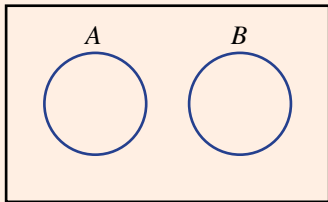

Two-way table

	A	A'	Total
B	0	...	...
B'	...	...	...
Total	...	...	...

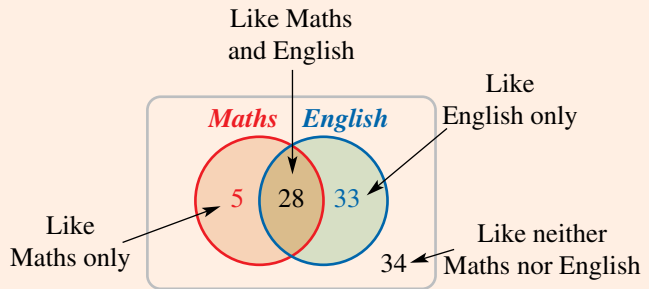

### BUILDING UNDERSTANDING

1 a State the missing values to complete the two-way table.

	Like bananas	Dislike bananas	Total
Like apples	30	15	45
Dislike apples	10	20	
Total		35	75

- b How many people like both apples and bananas?
- c How many people dislike apples and dislike bananas?
- d How many people were surveyed?

2 Consider the Venn diagram representing cat and dog ownership. State the missing number (1, 2, 3 or 4) to make the following statements true.

- a The number of people who own a cat and a dog is \_\_\_\_\_.
- b The number of people who own a cat but do not own a dog is \_\_\_\_\_.
- c The number of people who own neither a cat nor a dog is \_\_\_\_\_.
- d The number of people who own a dog but do not own a cat is \_\_\_\_\_.

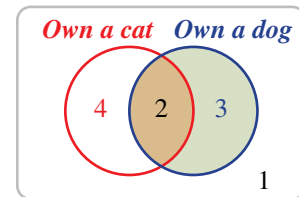



### Example 16 Constructing Venn diagrams and two-way tables

A survey is conducted of 50 people, asking who likes coffee and who likes tea. It was found that 20 people liked both, 15 people liked coffee but not tea, and 10 people liked tea but not coffee.

- How many people liked neither tea nor coffee?
- Represent the survey findings in a Venn diagram.
- How many people surveyed like tea?
- How many people like coffee or tea or both (inclusive 'or')?
- How many people like either coffee or tea but not both (exclusive 'or')?
- Represent the survey findings in a two-way table.

#### SOLUTION

a 5

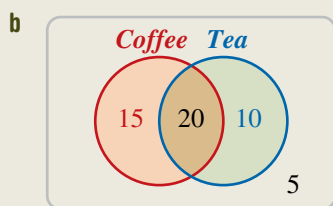

c  $20 + 10 = 30$

d 45

e 25

f

	Like coffee	Dislike coffee	Total
Like tea	20	10	30
Dislike tea	15	5	20
Total	35	15	50

#### EXPLANATION

$50 - 20 - 15 - 10 = 5$  people who do not like either.

The Venn diagram includes four numbers corresponding to the four possibilities. For example, the number 15 means that 15 people like coffee but not tea.

10 people like tea but not coffee, but 20 people like both. In total, 30 people like tea.

$15 + 20 + 10 = 45$  people like either coffee or tea or both.

15 people like coffee but not tea and 10 people like tea but not coffee.

The two-way table has the four numbers from the Venn diagram and also a 'total' column (e.g.  $20 + 10 = 30$ ,  $15 + 5 = 20$ ) and a 'total' row. Note that 50 in the bottom corner is both  $30 + 20$  and  $35 + 15$ .

#### Now you try

A survey is conducted of 30 people, asking who likes coffee and who likes tea. It was found that 7 people liked both, 12 people liked coffee but not tea, and 8 people liked tea but not coffee.

- How many people liked neither tea nor coffee?
- Represent the survey findings in a Venn diagram.
- How many people surveyed like tea?
- How many people like coffee or tea or both (inclusive 'or')?
- How many people like coffee or tea but not both (exclusive 'or')?
- Represent the survey findings in a two-way table.



### Example 17 Using two-way tables to calculate probabilities

Consider the two-way table below showing the eating and sleeping preferences of different animals at the zoo.

	Eats meat	No meat	Total
Sleeps during day	20	12	32
Only sleeps at night	40	28	68
Total	60	40	100

- a** For a randomly selected animal, find:
- Pr(sleeps only at night)
  - Pr(eats meat or sleeps during day or both).
- b** If an animal is selected at random and it eats meat, what is the probability that it sleeps during the day?
- c** What is the probability that an animal that sleeps during the day does not eat meat?

#### SOLUTION

$$\begin{aligned} \text{a i Pr(sleeps only at night)} &= \frac{68}{100} \\ &= \frac{17}{25} \end{aligned}$$

$$\begin{aligned} \text{ii Pr(eats meat or sleeps during day or both)} \\ &= \frac{72}{100} \\ &= \frac{18}{25} \end{aligned}$$

$$\begin{aligned} \text{b Pr(sleeps during day given that it eats meat)} \\ &= \frac{20}{60} \\ &= \frac{1}{3} \end{aligned}$$

$$\begin{aligned} \text{c Pr(does not eat meat given it sleeps during day)} \\ &= \frac{12}{32} \\ &= \frac{3}{8} \end{aligned}$$

#### EXPLANATION

The total of animals that sleep at night is 68.  
So  $\frac{68}{100} = \frac{17}{25}$

$20 + 12 + 40 = 72$  animals eat meat or sleep during the day (or both). So  $\frac{72}{100} = \frac{18}{25}$

Of the 60 animals that eat meat, 20 sleep during the day, so the probability is  $\frac{20}{60} = \frac{1}{3}$

Of the 32 animals that sleep during the day, 12 do not eat meat. The probability is  $\frac{12}{32} = \frac{3}{8}$

**Now you try**

The two-way table below shows how many vegetarian and non-vegetarians are at a party of men and women.

	Men	Women	Total
Vegetarian	5	10	15
Not a vegetarian	20	25	45
Total	25	35	60

- a For a randomly selected person at the party, find:
  - i  $\Pr(\text{vegetarian})$
  - ii  $\Pr(\text{a vegetarian or a man or both})$ .
- b If a man is selected at random, what is the probability that he is not a vegetarian?
- c If a vegetarian is selected at random, what is the probability that they are a woman?

**Exercise 8J**

**FLUENCY**

1–5

2–6

3–7

- Example 16**
- 1 In a group of 30 students it is found that 10 play both cricket and soccer, 5 play only cricket and 7 play only soccer.
    - a How many people play neither cricket nor soccer?
    - b Represent the survey findings in a Venn diagram.
    - c How many of the people surveyed play cricket?
    - d How many of the people surveyed play either cricket or soccer or both? (This is inclusive ‘or’.)
    - e How many of the people surveyed play either cricket or soccer but not both? (This is exclusive ‘or’.)
    - f Represent the survey findings in a two-way table.

- Example 16**
- 2 In a group of 40 dogs, 25 had a name tag and a collar, 7 had only a name tag and 4 had only a collar.
    - a How many dogs had neither a name tag nor a collar?
    - b Represent the survey findings in a Venn diagram.
    - c How many dogs had a name tag?
    - d How many dogs had either a name tag or a collar or both?
    - e How many dogs had either a name tag and a collar but not both?
    - f Represent the survey findings in a two-way table.

- 3 Consider this Venn diagram showing the number of people who have a university degree and the number who are now employed.
  - a What is the total number of people in the survey who are employed?
  - b Copy and complete the two-way table shown below.

	Employed	Unemployed	Total
University degree			
No university degree			
Total			

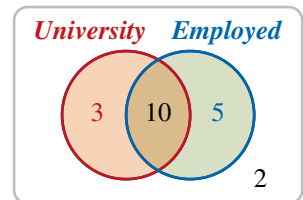

- c If the 10 in the centre of the Venn diagram changed to an 11, which cells in the two-way table would change?

- Example 17a** 4 The two-way table below shows the results of a poll conducted of a group of boys and girls who own mobile phones to see who pays their own bills.

	Boys	Girls	Total
Pay own bill	4	7	11
Do not pay own bill	8	7	15
Total	12	14	26

- How many people participated in this poll?
- How many boys were surveyed?
- How many of the people surveyed pay their own bill?
- Find the probability that a randomly selected person:
  - is a boy and pays his own bill
  - is a girl and pays her own bill
  - is a girl
  - does not pay their own bill.

- Example 17b,c** 5 The two-way table below shows the results of a survey on car and home ownership at a local supermarket.

	Own car	Do not own car	Total
Own home	8	2	10
Do not own home	17	13	30
Total	25	15	40

- Represent the two-way table above as a Venn diagram.
  - Find  $\Pr(\text{randomly selected person owns a car and a home})$ .
  - Find  $\Pr(\text{randomly selected person owns a car but not a home})$ .
  - What is the probability that a randomly selected person owns their own home?
  - If a person from the group is selected at random and they own a car, what is the probability that they also own a home?
  - If a person from the group is selected at random and they own a home, what is the probability that they also own a car?
- 6 A school classroom has 25 people in it: students, staff and visitors. Use the Venn diagram to answer the questions.
- How many visitors are in the classroom?
  - There are no people who are both students and staff. What is the name given to events like this with no overlap?
  - If a person is chosen at random, find:
    - $\Pr(\text{student})$
    - $\Pr(\text{staff})$
    - $\Pr(\text{student}' )$
    - $\Pr(\text{student and staff})$ .

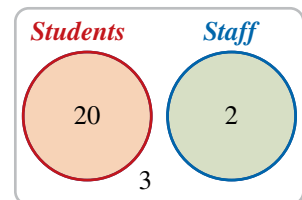

7 The Venn diagram shows the number of people who like juice and/or soft drinks.

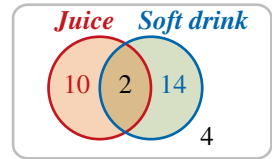

- a What is the total number of people who like juice?
- b What is the probability that a randomly selected person likes neither juice nor soft drink?
- c What is the probability that a randomly selected person likes either juice or soft drink or both?
- d What is the probability that a randomly selected person likes just one of the two drink types listed?
- e What is the probability that a randomly selected person likes juice, given that they like soft drink?
- f Are 'liking juice' and 'liking soft drink' mutually exclusive? Why or why not?

**PROBLEM-SOLVING** 8, 9 8–10 9–11

8 Copy and complete the following two-way tables.

a

	B	Not B	Total
A	20		70
Not A			
Total		60	100

b

	B	Not B	Total
A		5	
Not A			7
Total	10		18

9 A car salesman notes that among his 40 cars, there are 15 automatic cars and 10 sports cars. Only two of the sports cars are automatic.

- a Create a two-way table of this situation.
- b What is the probability that a randomly selected car will be a sports car that is not automatic?
- c What is the probability that a randomly selected car will be an automatic car that is not a sports car?
- d If an automatic car is chosen at random, what is the probability that it is a sports car?

10 Events *A* and *B* are mutually exclusive events.

The two-way table shown is partially filled.

a Copy and complete the table.

	B	B'	Total
A			60
A'			
Total	30		100

- b Find:
- i  $\Pr(A)$
  - ii  $\Pr(A')$
  - iii  $\Pr(A' \text{ and } B')$ .

11 A page of text is analysed and, of the 150 words on it, 30 were nouns, 10 of which started with a vowel. Of the words that were not nouns, 85 of them did not start with vowels.

- a If a word on the page is chosen at random, what is the probability that it is a noun?
- b How many of the words on the page started with vowels?
- d If a word on the page starts with a vowel, what is the probability that it is a noun?
- e If a noun is chosen at random, what is the probability that it starts with a vowel?

## REASONING

12

12, 13

13, 14

- 12 The word 'or' can mean inclusive 'or' and it can mean exclusive 'or'.
- Which has a higher probability: A inclusive-or B or A exclusive-or B? Justify your answer.
  - Explain how your answer changes if A and B are mutually exclusive.
- 13 In a two-way table, there are 9 spaces to be filled with numbers.
- What is the minimum number of spaces that must be filled before the rest of the table can be determined? Explain your answer.
  - If you are given a two-way table with 5 spaces filled, can you always determine the remaining spaces? Justify your answer.
  - Explain why the following two-way table must contain an error.

	<i>B</i>	<i>B'</i>	Total
<i>A</i>	20		
<i>A'</i>		29	
Total	62		81

- 14 a Use a two-way table or Venn diagram to explain why  $\Pr(A \text{ and } B)$ ,  $\Pr(A' \text{ and } B)$ ,  $\Pr(A \text{ and } B')$  and  $\Pr(A' \text{ and } B')$  must add to 1.
- b If A and B are mutually exclusive, explain why  $\Pr(A' \text{ and } B) + \Pr(A \text{ and } B') + \Pr(A' \text{ and } B') = 1$

## ENRICHMENT: Algebraic probabilities

–

–

15

- 15 In this Venn diagram,  $w$ ,  $x$ ,  $y$  and  $z$  are all unknown positive integers.
- Write an algebraic expression for  $\Pr(\text{both } A \text{ and } B)$  using any of the variables  $w$ ,  $x$ ,  $y$  and  $z$ .
  - Write an algebraic expression for  $\Pr(A)$  using any of the variables  $w$ ,  $x$ ,  $y$  and  $z$ .
  - Copy and complete this two-way table using algebraic expressions.

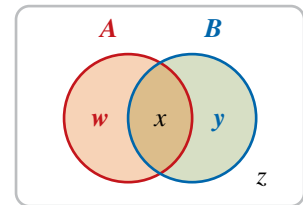

	<i>B</i>	<i>B'</i>	Total
<i>A</i>	$x$		
<i>A'</i>		$z$	
Total	$x + y$		

- d If A and B are mutually exclusive events, use the variables  $a$ ,  $b$  and  $x$  to give expressions for:
- $\Pr(A)$
  - $\Pr(B)$
  - $\Pr(A')$
  - $\Pr(A \text{ or } B)$
  - $\Pr(A' \text{ and } B')$ .

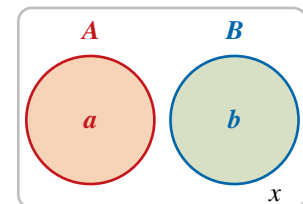

## 8K Experimental probability

### LEARNING INTENTIONS

- To understand that the theoretical probability of an event can be estimated by running an experiment, and that running more trials generally gives a better estimate
- To be able to calculate the experimental probability of an event given the results of the experiment
- To be able to calculate the expected number of occurrences given a probability and a number of trials
- To be able to design a simulation using random devices and interpret the results of running it

Sometimes the probability of an event is unknown or cannot be determined using the techniques learnt earlier. An experiment can be used to estimate an event's probability and this estimate is called an experimental probability.



Bioinformatics combines statistics, biology, engineering and computer science. Statistical analysis of biological data and processes can lead to treatments with a higher chance of success for diseases such as cancer, diabetes, arthritis and malaria.

### Lesson starter: Dice roller

For this experiment, three dice are required per student or group.

- Roll the dice 20 times and count how many times the dice add to 10 or more.
- Each group should use this to estimate the probability that three dice will add to 10 or more when rolled.
- Combine the results from multiple groups to come up with a probability for the entire class. Discuss whether this should be more or less accurate than the individual estimates.

### KEY IDEAS

- The **experimental probability (or observed probability)** of an event based on a particular experiment is defined as:

$$\frac{\text{number of times the event occurs}}{\text{total number of trials in the experiment}}$$

- The **expected number** of occurrences = probability  $\times$  number of trials.
- Complex events can be simulated. A **simulation** is conducted using random devices such as coins, dice, spinners or random number generators.
- Experimental probability can be determined using **relative frequency**.

## BUILDING UNDERSTANDING

- 1 A spinner is spun 10 times and the colour shown is recorded:  
blue, blue, green, red, blue, green, blue, red, blue, blue
  - a How many times was green shown?
  - b What is the experimental probability of green being spun?
  - c What is the experimental probability of blue being spun?
- 2 A fair die is rolled 100 times and the number 5 occurs 19 times.
  - a What is the experimental probability of a 5 being rolled?
  - b What is the actual probability of a 5 being rolled on a fair die?
  - c For this experiment, which is greater: the experimental probability or the actual probability?



## Example 18 Working with experimental probability

A number of red, white and orange marbles are placed in a jar. Repeatedly, a marble is taken out, its colour is noted and the marble is replaced in the jar. The results are tallied in the table.

Red	White	Orange
### III	### ### II	### ###

- a What is the experimental probability of a red marble being chosen next?
- b What is the experimental probability of a red or a white marble being chosen?
- c If the experiment is done 600 times, what is the expected number of times that an orange marble is selected?

## SOLUTION

$$\text{a } \frac{8}{30} = \frac{4}{15}$$

$$\text{b } \frac{20}{30} = \frac{2}{3}$$

$$\text{c } \text{Expected number} = \frac{1}{3} \times 600 = 200$$

## EXPLANATION

Experimental probability =  

$$\frac{\text{number of times the event occurs}}{\text{total number of trials in the experiment}}$$

Red or white marbles were selected 20 times out of the 30 trials.

$$\text{Pr}(\text{orange}) = \frac{1}{3}$$

Expected number = probability  $\times$  number of trials

## Now you try

In an experiment a spinner is spun with the colours red, white and orange. They are not equally likely to occur because the regions have different areas. The results are tallied in the table.

Red	White	Orange
IIII	### ### I	###

- a What is the experimental probability of spinning red?
- b What is the experimental probability of spinning red or orange?
- c If the spinner is spun 100 times, what is the expected number of times that white will be spun?





### Example 19 Designing and running a simulation



A tennis player has a 1 in 2 chance of getting his first serve in. If it goes in he has a 1 in 6 chance of losing the point. Design and run a simulation to estimate the probability that he gets his first serve in and wins the point.

#### SOLUTION

Create a tally for the results.

	Serve not in	Serve in but lose point	Serve in and win point
Tally			
Frequency			

Use one coin and one die.

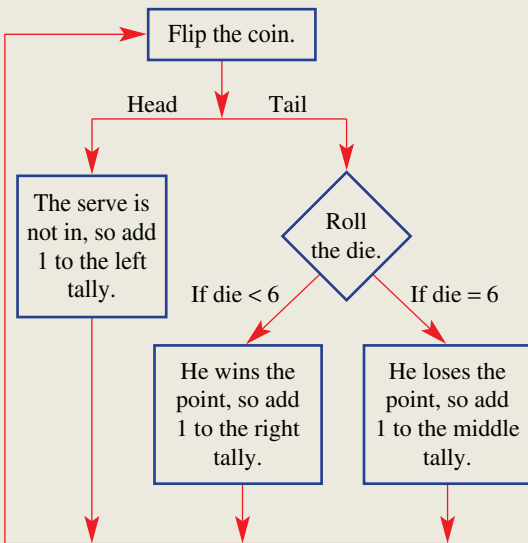

Repeat the experiment as many times as desired.

#### EXPLANATION

The results will be stored in a tally.

Decide which random devices will be used for the simulation.

The simulation is described using the random devices.

The more times the simulation is repeated, the closer the experimental probability should be to the actual probability.

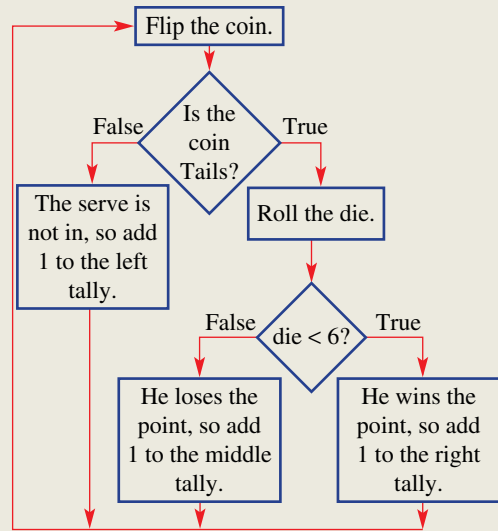

#### Now you try

Another tennis player has a 5 in 6 chance of getting his first serve in. If it goes in, he has a 1 in 2 chance of winning the point. Design and run a simulation to estimate the probability that he gets his first serve in and wins the point.

## Exercise 8K

### FLUENCY

1–5

2–6

3–7

Example 18

- 1 A number of yellow, blue and purple counters are placed in a jar. Repeatedly, a counter is taken out, its colour is noted and the counter is then replaced in the jar. The results are tallied in the table.

Yellow	Blue	Purple
	###	

- What is the experimental probability of a yellow counter being chosen next?
- What is the experimental probability of a yellow or blue counter being chosen?
- If the experiment is done 150 times, what is the expected number of times that a purple counter is selected?

Example 18

- 2 A spinner is spun 50 times and the results are shown in the frequency table below.

Red	Blue	White	Purple
30	5	2	13

- What is the experimental probability of red?
- What is the experimental probability of blue?
- What is the experimental probability of red or purple?
- If the spinner were spun 1000 times, what is the expected number of times that white would be spun?

- 3 A group of households are surveyed on how many cars they own. The results are shown.

0 cars	1 car	2 cars	3 cars	4 cars
### ###	### ### ### ### ### ### ###	### ### ### ### ### ### ### ###	###	

- Write the tallied results as a frequency table.
  - How many households were surveyed?
  - What is the experimental probability that a randomly chosen household owns no cars?
  - What is the experimental probability that a randomly chosen household owns at least 2 cars?
- 4 A fair coin is tossed 100 times.
- What is the expected number of times that it will land heads?
  - Is it possible that it will land heads 52 times?
  - Is it possible that it will land heads 100 times?
- 5 A die is painted so that 3 faces are blue, 2 faces are red and 1 face is green.
- What is the probability that it will display red on one roll?
  - How many times would you expect it to display red on 600 rolls?
  - How many times would you expect it to display blue on 600 rolls?
- 6 A spinner displays the numbers 1, 2, 3 and 4 on four sectors of different sizes. It is spun 20 times and the results are 1, 3, 1, 2, 2, 4, 1, 1, 3, 1, 2, 4, 4, 2, 4, 3, 1, 1, 3, 2.
- Give the experimental probability that the spinner landed on:
 

i 1	ii 2	iii 3	iv 4
-----	------	-------	------
  - On the basis of this experiment, what is the expected number of times in 1000 trials that the spinner will land on 3?

- 7 A basketball player has a 1 in 2 chance of getting a shot in from the free throw line. To simulate these, use a coin: heads represents the shot going in; tails represents missing.
- Flip a coin 20 times and write down the results.
  - Based on your experiment, what is the experimental probability that a shot will go in?
  - Based on the actual probability of  $\frac{1}{2}$ , how many of 20 throws are expected to go in?

**PROBLEM-SOLVING** 8      8, 9      9, 10

Example 19

- 8 Ashwin sits a test consisting of 5 true or false questions. He plans to guess the answers. If he gets at least 3 questions correct he will pass the test.
- Design a simulation using 5 coins for this situation.
  - Run your simulation 20 times and give the experimental probability that Ashwin passes the test.
- 9 A number of marbles are placed in a bag – some are red and some are green. A marble is selected from the bag and then replaced after its colour is noted. The results are shown in the table.

Red	Green
28	72

Based on the experiment, give the most likely answer to the following questions.

- If there are 10 marbles in the bag, how many are red?
  - If there are 6 marbles in the bag, how many are red?
  - If there are 50 marbles, how many are red?
  - If there are 4 marbles, how many are green?
  - If there are 14 green marbles in the bag, how many marbles are there in total?
  - If there are 3 red marbles, how many green marbles are there?
- 10 A baseball batter has up to 3 opportunities to hit a ball. Each time he has a 1 in 6 chance of hitting a home run, a 1 in 3 chance of hitting a small shot and a 1 in 2 chance of missing altogether. He uses a die to simulate each hitting opportunity.

Number	1	2 or 3	4 or 5 or 6
Outcome	Home run	Small shot	Miss

- a He rolls the die up to three times. Match each of the simulation results **i–iv** with the correct outcome **A–D**.
- i** 5, 6, 1                      **ii** 4, 3                      **iii** 2                      **iv** 6, 5, 6
- Hit small shot off first throw
  - Miss twice then hit home run
  - Miss 3 times
  - Miss once, then small shot
- b Conduct this simulation 50 times, keeping track of the result in a table like the one below.

Home runs	Small shots	3 Strikes (miss all three)

- Based on your simulation, estimate the probability that the batter hits a home run if he has up to three chances.
- Based on your simulation, how many times would the batter have 3 strikes if he has 500 attempts?
- The batter’s results are recorded for 50 attempts: he hits 15 home runs, 29 small shots and 6 times he has three strikes. Estimate the number of home runs he would hit if he has 130 attempts.

**REASONING** 11      11, 12      12, 13

11 It is possible to simulate a coin toss using a die by using the numbers 1–3 to stand for tails and 4–6 to stand for heads. Which of the following spinners could be simulated using a single roll of a die? Justify your answer.

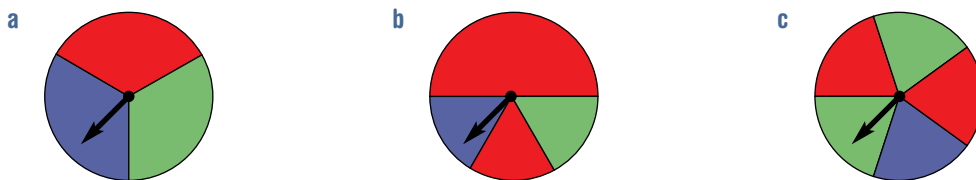

- 12 a An event has a (theoretical) probability of  $\frac{1}{8}$ . How could this be simulated using three coins?  
 b An event has a probability of  $\frac{1}{12}$ . How could this be simulated with a coin and a die?  
 c An event has a probability of  $\frac{1}{9}$ . How could this be simulated with two dice?  
 d How could an event with a probability of  $\frac{1}{36}$  be simulated with two dice?

13 Four coins are flipped and the number of tails is noted.

Number of tails	0	1	2	3	4
Frequency	1	3	5	2	0

- a Based on this experiment, what is the experimental probability of obtaining 4 tails?  
 b Based on this experiment, what is the experimental probability of obtaining 3 heads?  
 c Use a tree diagram to give the actual probability of obtaining 4 tails.  
 d True or False? If the experimental probability is 0 then the theoretical probability is 0.  
 e True or False? If the theoretical probability is 0 then the experimental probability is 0.

**ENRICHMENT: Monte Carlo method** –      –      14

14 Probability simulations can be used to find the area of an object by throwing darts randomly and seeing whether they land in the object. The following questions assume that all darts thrown hit the object.

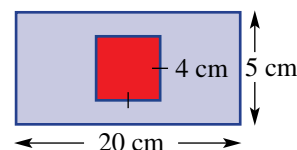

- a Darts are thrown at the picture shown.  
 i Find the red area.  
 ii Find the total area of the picture.  
 iii A dart is thrown randomly at the picture. What is the probability that it hits the red part?  
 iv If 100 darts are thrown, how many would you expect to land in the blue area?

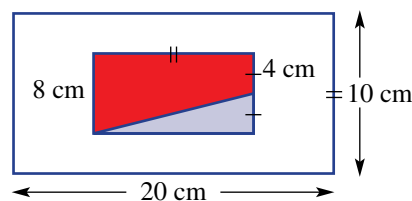

- b 1000 darts are thrown at the picture on the right. How many of them would you expect them to hit:  
 i red?      ii white?      iii blue?

- c The map on the right has had 1000 darts thrown at it. The darts landed in the black area 375 times. Based on this, estimate the area of the black shape.  
 d The map shown at right has a scale of 1:1 000 000. Estimate the actual area of the island shown in the map.

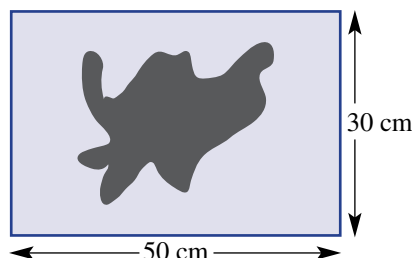

## Seven free chocolate bars

Sasha notices that a chocolate company claims that one in six chocolate bars has a message that entitles you to a free chocolate bar. He plans to purchase one bar each day for 10 days in the hope of winning at least 3 free bars.

*Present a report for the following tasks and ensure that you show clear mathematical workings and explanations where appropriate.*

### Preliminary task

Use a 6-sided die to simulate buying a chocolate bar. If the number 6 is rolled, this represents finding the 'free chocolate bar' message inside the wrapper.

- Roll the die once and see what number comes up. Did you receive a free chocolate bar?
- Repeat part **a** for a total of 10 trials. How many 6s did you obtain?
- Using your result from part **b**, decide how many free chocolates Sasha received when he bought 10 chocolate bars. How does this compare to other students in your class?

### Modelling task

#### Formulate

- The problem is to determine a good estimate for the probability that Sasha will receive at least 3 free chocolate bars after 10 purchases. Write down all the relevant information that will help solve this problem.
- Describe how a 6-sided die can be used to simulate the purchase of a chocolate bar and decide whether or not you win a free one.

#### Solve

- Repeat the simulation including 10 trials and count the number of times a 6 (free chocolate bar) is obtained.
- Continue to repeat part **a** for a total of 12 simulations. Record your results in a table similar to the following using a tally.

Simulation	1	2	3	4	5	6	7	8	9	10	11	12
Number of 6s tally (out of 10)												
Number of 6s (frequency)												

- Out of the 12 simulations, how many indicate that at least 3 free chocolate bars will be obtained?
  - By considering your results from the 12 simulations, determine the experimental probability that Sasha will obtain at least 3 free chocolate bars after 10 purchases.
  - Compare your result from part **f** with others in your class.
  - Explain how you might alter your experiment so that your experimental probability might be closer to the theoretical probability.
- Communicate**
- Summarise your results and describe any key findings.

### Extension questions

- Find the average experimental probability that Sasha will obtain at least 3 chocolate bars after 10 purchases using the data collected from the entire class.
- Compare your result from part **a** with the theoretical value of 0.225, correct to three decimal places.
- Explore how random number generators and technology could be used to repeat this experiment for a large number of trials.

## Cutting the hay

### Key technology: Spreadsheets and programming

The Williams family own a farm and cut hay each year to store for the winter or sell on the market. The timing is quite tight as the grass needs to be cut and baled over a 3-week period. This work can only be done on Saturday as the members of the Williams family hold other work positions on the weekdays and are otherwise busy on Sunday. They therefore have three Saturdays available of which at least two out of the three need to be dry in order to complete the work. History shows that there is a 3 in 5 chance that any particular Saturday at that time of year is dry.



### 1 Getting started

We will use a random number generator to simulate the number of dry days on the three Saturdays available. By generating a random integer between 1 and 5 inclusive we will allocate the outcomes as follows.

- Dry weather: {1, 2, 3}
  - Wet weather: {4, 5}
- a Search for 'Random number generator' on the internet and set the Min as 1 and the Max as 5. Then generate a random integer.
  - b Decide if your given random number from part a represents dry weather or wet weather.
  - c Now generate three random integers between 1 and 5 inclusive (representing three Saturdays) and count how many times dry weather is obtained.
  - d Based on your result from part c, will the Williams family be able to complete the work required to make the hay? Remember that at least two out of the three need to be dry in order to complete the work making hay.

### 2 Using technology

We will use a spreadsheet to complete the three-day simulation described above.

- a Create a spreadsheet using the given information and fill down at cells A5 and B5 for three rows.
- b Explain why the formula in cell B5 allocates the word 'Dry' for the integers 1, 2 or 3.
- c Press Function F9 to rerun the simulation for a total of 10 times. For each simulation, note the total number of dry days and enter your results into this table. For example, if your simulation results in 2 dry days, then add a dash to the tally in the number 2 column.

	A	B
1	<b>Making hay</b>	
2		
3	<b>Integer</b>	<b>Dry/Wet?</b>
4		
5	=RANDBETWEEN(1,5)	=IF(A5<=3,"Dry","Wet")
6	=RANDBETWEEN(1,5)	=IF(A6<=3,"Dry","Wet")
7	=RANDBETWEEN(1,5)	=IF(A7<=3,"Dry","Wet")
8		
9	<b>Total Dry</b>	=COUNTIF(B5:B7,"Dry")
10		

- d** By counting the dashes made in each of the four tally cells, fill in the cells for Frequency. How many of the 10 simulations resulted in at least two dry days?
- e** What fraction of the 10 simulations resulted in at least two dry days?
- f** Your answer to part **e** is your experimental probability that the Williams family will be able to complete the work making hay. Compare your answer with your fellow students. Are your experimental probabilities reasonably close together or spread out?

Total dry	0	1	2	3
Tally				
Frequency				

### 3 Applying an algorithm

We will now try to improve on your experimental probability result above by increasing the number of simulations completed.

- a** Use your spreadsheet to apply this algorithm.
- Step 1: Use Function F9 to rerun the simulation.
  - Step 2: Note the total number of dry days.
  - Step 3: Record a dash in the corresponding tally.
  - Step 4: Repeat from Step 1 until the simulation as been repeated 50 times.
- b** Calculate the frequencies in your table and count the total number of simulations that resulted in at least two dry days.
- c** Calculate the experimental probability that the Williams family will be able to complete the work making hay.
- d** Compare your result with your fellow students. Are the class results closer together or more spread out compared to the result obtained in part **2f** above? Can you provide a reason for this observation?

### 4 Extension

- a** Try writing an algorithm using a flow chart that does the following:
- Runs the above simulation representing dry or wet weather for three Saturdays
  - Counts the number of dry days for each simulation
  - Repeats the simulation a given number of times, e.g. 50
  - Counts the total number of simulations which result in at least 2 dry days
  - Calculates the experimental probability that the Williams family will be able to complete the work making hay.
- b** Convert your above flow chart algorithm into code like Python and run it to produce the experimental probability as above. Run your simulation a large number of times to produce a long-run proportion. Compare this with the theoretical probability of 0.648.



## The maths cup

### The class race

- 1 The table below should be copied so that everyone in the race can see it and write on it.
- 2 Each student selects one horse as their 'own' (choose a winner!).
- 3 Each student rolls 2 dice and states the sum of the uppermost faces of the dice.
- 4 The total of each roll refers to the horse number. When its number is rolled, that horse moves another 100 m towards the finish line and a cross is placed next to its name.
- 5 The winning horse is the first to reach the finish!
- 6 Keep rolling the dice until first, second and third places are decided.

	Horse	100 m	200 m	300 m	400 m	500 m	600 m	700 m	800 m	900 m	1000 m
1	SCRATCHED										
2	Greased Lightning										
3	Flying Eagle										
4	Quick Stix										
5	Silver Blaze										
6	Slow and Steady										
7	The Donkey										
8	My Little Pink Pony										
9	Tooting Tortoise										
10	Ripper Racer										
11	Speedy Gonzales										
12	Phar Lap										

### Small group races

- 7 Start a tally to record the number of wins for each horse.
- 8 Repeat the above activity several times individually, or in small groups. Maintain a tally of how many times each horse wins the race.
- 9 Collate the results into a frequency table and place this on a graph.

### Discussion questions

- 10 Which horse won most often? Would you expect that horse to always win? Why?
- 11 Do any of the horses have the same chance of winning? Do any of the horses have the same chance of gaining a place? Do any of the horses have the same chance of losing?
- 12 Are some horses luckier than others? In this game does luck affect which horse wins? How?
- 13 Write a report to explain to a jockey which horse would be expected to win, and which horses he needs to beat, as they are most likely to be close to the winner at the finish line. Mathematically justify your decision by demonstrating your understanding of probability.



- 1 Find a set of three numbers that have a range of 9, a mean of 10 and a median of 11.
- 2 The mean of a set of 20 numbers is 20. After the 21st number is added, the mean is now 21. What was the 21st number?
- 3 The median of a set of 10 numbers is 10. An even number is added, and the median is now 11 and the range is now 4. What number was added?
- 4 At the local sports academy, everybody plays netball or tennis. Given that half the tennis players also play netball and one-third of the netballers also play tennis, what is the probability that a randomly chosen person at the academy plays both?
- 5 For each of the following, find an English word that matches the description.
  - a  $\Pr(\text{vowel}) = \frac{1}{2}$
  - b  $\Pr(F) = \frac{2}{3}$
  - c  $\Pr(\text{vowel}) = \frac{1}{4}$  and  $\Pr(D) = \frac{1}{4}$
  - d  $\Pr(I) = \frac{2}{11}$  and  $\Pr(\text{consonant}) = \frac{7}{11}$
  - e  $\Pr(M) = \frac{1}{7}$  and  $\Pr(T) = \frac{1}{7}$  and  $\Pr(S) = \frac{1}{7}$
  - f  $\Pr(\text{vowel}) = 0$  and  $\Pr(T) = \frac{1}{3}$
- 6 In the following game, the player flips a fair coin each turn to move a piece. If the coin shows 'heads' the piece goes right, and if it is 'tails' the coin goes left. What is the approximate probability that the player will win this game?
 

WIN					START				LOSE
-----	--	--	--	--	-------	--	--	--	------
- 7 If a person guesses all the answers on a 10-question true or false test, what is the probability that they will get them all right?
- 8 A bag contains 8 counters that are red, blue or yellow. A counter is selected from the bag, its colour noted and the counter replaced. If 100 counters were selected and 14 were red, 37 were blue and 49 were yellow, how many counters of each colour are likely to be in the bag?

Up for a challenge? If you get stuck on a question, check out the 'Working with unfamiliar problems' poster at the end of the book to help you.



**Graphs**

**Graphs of frequency tables**

Single scores

Grouped scores

**Statistics**

**Measures of centre**

ascending order  
0, 1, 4, 4, 5, 6, 9, 30

Median (middle) =  $\frac{4+5}{2} = 4.5$

Mean (average) =  $\frac{59}{8} = 7.4$

Mode (most frequent) = 4

**Frequency tables**

**Single scores**

Number of children Score	Number of families Tally	Frequency
0		3
1		5
2	+	11
3		5
4		6
		$n = 30$

**Grouped scores**

Age range	Frequency
0-4	3
5-9	7
10-14	5
$n = 15$	

**Measures of spread (Ext)**

Range =  $28 - 1 = 27$

lower half: 1, 5, 7, 9, 10, 11  
Upper half: 13, 17, 19, 20, 23, 28

Lower quartile = Median = 8  
Upper quartile = Median = 19.5

IQR =  $19.5 - 8 = 11.5$   
Interquartile range

Probabilities are written as  
• fractions • percentage • decimals

100% 1 - Certain  
Likely  
0.5 50%  $\frac{1}{2}$  - Even chance (50-50)  
Unlikely  
0% 0 - Impossible

Sample space from experiments with two or more steps

**Table**

		Die					
		1	2	3	4	5	6
Coin	H	H1	H2	H3	H4	H5	H6
	T	T1	T2	T3	T4	T5	T6

(inside the table)

**Tree diagram**

Possible outcomes  
Sample space

Die Coin

- 1: H, T
- 2: H, T
- 3: H, T
- 4: H, T
- 5: H, T
- 6: H, T

1H, 1T, 2H, 2T, 3H, 3T, 4H, 4T, 5H, 5T, 6H, 6T

**Probability**

**Theoretical probability**

Trial: Roll a fair die  
Sample space (possible outcomes) { 1, 2, 3, 4, 5, 6 }

Pr(odd number) =  $\frac{3}{6} = \frac{1}{2}$

**Experimental probability**

Playing card selected and replaced 20 times, and its suit noted.

Outcome	Frequency	Experimental probability
Heart	4	$\frac{4}{20}$
Diamond	5	$\frac{5}{20}$
Club	4	$\frac{4}{20}$
Spade	7	$\frac{7}{20}$
$n = 20$		

Trial: Select a playing card and note its suit. (Heart and diamond are red suits.)  
Sample space: spade, diamond, club, heart

**Theoretical probabilities**

Pr(black) =  $\frac{26}{52} = \frac{1}{2}$   
Pr(heart) =  $\frac{13}{52} = \frac{1}{4}$   
Pr(not spade) =  $\frac{39}{52} = \frac{3}{4}$   
Pr(either red or a spade) =  $\frac{39}{52} = \frac{3}{4}$   
Pr(red ace) =  $\frac{2}{52} = \frac{1}{26}$

**Expected number of outcomes**

Outcome	Theoretical probability	Expected number in 20 trials
Heart	$\frac{13}{52} = \frac{1}{4}$	$\frac{1}{4} \times 20 = 5$
Diamond	$\frac{13}{52} = \frac{1}{4}$	$\frac{1}{4} \times 20 = 5$
Club	$\frac{13}{52} = \frac{1}{4}$	$\frac{1}{4} \times 20 = 5$
Spade	$\frac{13}{52} = \frac{1}{4}$	$\frac{1}{4} \times 20 = 5$

**Two events**

**Venn diagrams**

**Mutually exclusive**  
Pr(A and B) = 0

**Two-way tables**

	B	B'	Total
A	5	10	15
A'	7	3	10
Total	12	13	25

# Chapter checklist with success criteria

A printable version of this checklist is available in the Interactive Textbook



<p>8A</p>	<p><b>1. I can interpret data presented in graphical form.</b> e.g. State the difference between Jami's income and Ashdev's income based on this column graph.</p>	<table border="1"> <caption>Income Data</caption> <thead> <tr> <th>Person</th> <th>Income (\$)</th> </tr> </thead> <tbody> <tr> <td>Aruvin</td> <td>60,000</td> </tr> <tr> <td>Jami</td> <td>90,000</td> </tr> <tr> <td>Ashdev</td> <td>40,000</td> </tr> <tr> <td>Phong</td> <td>80,000</td> </tr> <tr> <td>Stefan</td> <td>100,000</td> </tr> </tbody> </table>	Person	Income (\$)	Aruvin	60,000	Jami	90,000	Ashdev	40,000	Phong	80,000	Stefan	100,000	<input type="checkbox"/>
Person	Income (\$)														
Aruvin	60,000														
Jami	90,000														
Ashdev	40,000														
Phong	80,000														
Stefan	100,000														
<p>8B</p>	<p><b>2. I can interpret tallies.</b> e.g. Write the frequency for each colour car based on the tally below.</p> <table border="1"> <thead> <tr> <th>White</th> <th>Black</th> <th>Blue</th> <th>Red</th> <th>Yellow</th> </tr> </thead> <tbody> <tr> <td>   </td> <td>     </td> <td>     </td> <td>   </td> <td>    </td> </tr> </tbody> </table>	White	Black	Blue	Red	Yellow						<input type="checkbox"/>			
White	Black	Blue	Red	Yellow											
<p>8B</p>	<p><b>3. I can construct a tally and frequency table from a set of data.</b> e.g. Put the following data into a frequency table: 1, 4, 1, 4, 1, 2, 3, 4, 6, 1, 5, 1, 2, 1.</p>	<input type="checkbox"/>													
<p>8C</p>	<p><b>4. I can construct a graph from a frequency table.</b> e.g. Represent the table at right as a frequency graph and as a dot plot.</p> <table border="1"> <thead> <tr> <th>Number of siblings</th> <th>Frequency</th> </tr> </thead> <tbody> <tr> <td>0</td> <td>3</td> </tr> <tr> <td>1</td> <td>4</td> </tr> <tr> <td>2</td> <td>2</td> </tr> <tr> <td>3</td> <td>1</td> </tr> </tbody> </table>	Number of siblings	Frequency	0	3	1	4	2	2	3	1	<input type="checkbox"/>			
Number of siblings	Frequency														
0	3														
1	4														
2	2														
3	1														
<p>8D</p>	<p><b>5. I can find the mean and mode for a set of numerical data.</b> e.g. Find the mean and mode for the set of numbers: 10, 2, 15, 1, 15, 5, 11, 19, 4, 8.</p>	<input type="checkbox"/>													
<p>8D</p>	<p><b>6. I can find the median for a set of numerical data with an odd or even number of values.</b> e.g. Find the median of 16, 18, 1, 13, 14, 2, 11 and of the set 7, 9, 12, 3, 15, 10, 19, 3, 19, 1.</p>	<input type="checkbox"/>													
<p>8E</p>	<p><b>7. I can find the range of a set of numerical data.</b> e.g. Find the range of 1, 5, 2, 3, 8, 12, 4.</p>	<input type="checkbox"/>													
<p>8E</p>	<p><b>8. I can find the interquartile range for a set of numerical data with an odd or even number of values.</b> e.g. Find the IQR of 1, 15, 8, 2, 13, 10, 4, 14.</p>	<input type="checkbox"/>													
<p>8F</p>	<p><b>9. I can interpret survey results.</b> e.g. A survey is conducted and the results are shown. Assuming it is a representative sample, what proportion of the population has 2 or more children?</p>	<table border="1"> <caption>Frequency of Children</caption> <thead> <tr> <th>Number of children</th> <th>Frequency</th> </tr> </thead> <tbody> <tr> <td>0</td> <td>50</td> </tr> <tr> <td>1</td> <td>20</td> </tr> <tr> <td>2</td> <td>15</td> </tr> <tr> <td>3</td> <td>10</td> </tr> <tr> <td>4</td> <td>5</td> </tr> </tbody> </table>	Number of children	Frequency	0	50	1	20	2	15	3	10	4	5	<input type="checkbox"/>
Number of children	Frequency														
0	50														
1	20														
2	15														
3	10														
4	5														

		✓																
8F	<p><b>10. I can decide whether a method of data collection is likely to lead to biased samples.</b> e.g. In conducting a survey to determine how many children adults generally have, explain why randomly selecting people outside a childcare centre is likely to lead to bias.</p>	<input type="checkbox"/>																
8G	<p><b>11. I can find the probability of a simple event.</b> e.g. The letters of the word PRINCE are written out on cards and one is chosen at random. Find the probability that a vowel will be chosen.</p>	<input type="checkbox"/>																
8H	<p><b>12. I can use a table to find probabilities in two-step experiments.</b> e.g. A spinner with the numbers 1, 2, and 3 is spun, and then a card is chosen at random from the letters ATHS written on four cards. Find the probability of an odd number being spun and the letter H being chosen.</p>	<input type="checkbox"/>																
8I	<p><b>13. I can use a tree diagram to find probabilities in multi-step experiments.</b> e.g. Three fair coins are flipped. Use a tree diagram to find the probability that exactly two of the coins show heads.</p>	<input type="checkbox"/>																
8J	<p><b>14. I can construct a Venn diagram from a situation.</b> e.g. Of 50 people it was found that 20 people liked both coffee and tea, 15 liked coffee but not tea and 10 people like tea but not coffee. Draw a Venn diagram and use it to find the number of people who like coffee or tea or both.</p>	<input type="checkbox"/>																
8J	<p><b>15. I can construct a two-way table from a situation.</b> e.g. Of 50 people it was found that 20 people liked both coffee and tea, 15 liked coffee but not tea and 10 people liked tea but not coffee. Draw a two-way table of this situation.</p>	<input type="checkbox"/>																
8J	<p><b>16. I can use a two-way table to calculate probabilities.</b> e.g. The eating and sleeping preferences of zoo animals are shown below. Find the probability that an animal that sleeps during the day does not eat meat.</p> <table border="1" style="margin: 10px auto;"> <thead> <tr> <th></th> <th>Eats meat</th> <th>No meat</th> <th>Total</th> </tr> </thead> <tbody> <tr> <th>Sleeps during day</th> <td style="text-align: center;">20</td> <td style="text-align: center;">12</td> <td style="text-align: center;">32</td> </tr> <tr> <th>Only sleeps at night</th> <td style="text-align: center;">40</td> <td style="text-align: center;">28</td> <td style="text-align: center;">68</td> </tr> <tr> <th>Total</th> <td style="text-align: center;">60</td> <td style="text-align: center;">40</td> <td style="text-align: center;">100</td> </tr> </tbody> </table>		Eats meat	No meat	Total	Sleeps during day	20	12	32	Only sleeps at night	40	28	68	Total	60	40	100	<input type="checkbox"/>
	Eats meat	No meat	Total															
Sleeps during day	20	12	32															
Only sleeps at night	40	28	68															
Total	60	40	100															
8K	<p><b>17. I can find the experimental probability of an event.</b> e.g. Red, white and orange marbles are in a jar. Repeatedly, a marble is taken out, its colour noted and then it is placed back in the jar. Given that 8 times the marble was red, 12 times it was white and 10 times it was orange, state the experimental probability of a red marble being chosen.</p>	<input type="checkbox"/>																
8K	<p><b>18. I can find the expected number of times an event will occur.</b> e.g. If the probability of selecting an orange marble is <math>\frac{1}{3}</math>, what is the expected number of times an orange marble would be chosen over 600 trials?</p>	<input type="checkbox"/>																
8K	<p><b>19. I can design and run a simulation.</b> e.g. A tennis player has a 1 in 2 chance of getting his first serve in. If it goes in he has a 1 in 6 chance of losing the point. Design and run a simulation to estimate the probability that he gets his first serve in and wins the point.</p>	<input type="checkbox"/>																

## Short-answer questions

8A

1 The pie chart shows the mode of transport office workers use to get to work every day.

- Which mode of transport is the most popular?
- Which mode of transport is the least popular?
- What angle of the  $360^\circ$  sector graph is represented by 'private buses'?
- If 20 000 workers were surveyed, how many people travelled to work each day by train?
- The year after this survey was taken, it was found that the number of people using government buses had decreased. Give a reason why this could have occurred.

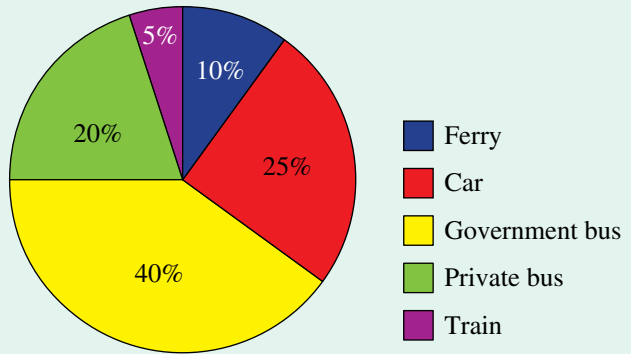

8B/C

2 Some students were asked how many hours of study they did before their half-yearly Maths exam. Their responses are represented in a tally.

0 hours	1 hour	2 hours	3 hours	4 hours
	###			###

- How many students are in the class?
- Convert the tally above into a frequency table.
- Draw a graph to represent the results of the survey.
- What proportion of the class did no study for the exam?
- Calculate the mean number of hours the students in the class spent studying for the exam, giving the answer correct to one decimal place.

8D/E

3 a Rewrite the following data in ascending order:

56 52 61 63 43 44 44 72 70 38 55  
60 62 59 68 69 74 84 66 53 71 64

- What is the mode?
- What is the median for these scores?
- Calculate the interquartile range.

Ext

8C/D

4 The ages of boys in an after-school athletics squad are shown in the table below.

- State the total number of boys in the squad.
- Display their ages in a graph.
- Calculate the mean age of the squad, correct to two decimal places.
- What is the median age of the boys in the squad?

Age	Frequency
10	3
11	8
12	12
13	4
14	3

8B/F

- 5 A group of teenagers were weighed and their weights recorded to the nearest kilogram. The results are as follows:

56 64 72 81 84 51 69 69 63 57 59 68 72 73 72 80 78 61 61 70  
57 53 54 65 61 80 73 52 64 66 66 56 50 64 60 51 59 69 70 85

- Find the highest and lowest weights.
- Create a grouped frequency distribution table using the groups 50–54, 55–59, 60–64 etc.
- Find:
  - the range
  - the weight group with the most people.
- Why is this sample not representative of the whole human population?

8D/E

- 6 a Consider the data 5, 1, 7, 9, 1, 6, 4, 10, 12, 14, 6, 3. Find:

- the mean
- the median
- the lower quartile
- the upper quartile
- the interquartile range (IQR).

Ext

Ext

Ext

- b Repeat for the data 6, 2, 8, 10, 2, 7, 5, 11, 13, 15, 7, 4. What do you notice?

8F

- 7 In an attempt to find the average number of hours of homework that a Year 8 student completes, Samantha asks 10 of her friends in Year 8 how much homework they do.

- Explain two ways in which Samantha's sampling is inadequate to get the population average.
- If Samantha wished to convey to her parents that she did more than the average, how could she choose 10 people to bias the results in this way?

8G/H

- 8 An eight-sided die has the numbers 1, 2, 3, 4, 5, 6, 7, 8 on its faces.

- Find the probability that the number 4 is rolled.
- What is the probability that the number rolled is odd?
- What is the probability that the number rolled is both even and greater than 5?
- If  $P$  is the event that a prime number is rolled, state the sample space of  $P'$ , the complement of  $P$ .
- If the die is rolled twice, what is the probability that the total of the two rolls is 20?

8G

- 9 The letters of the name MATHEMATICIAN are written on 13 cards. The letters are placed in a bag and one card is drawn at random.

- State the sample space.
- Find the probability of choosing the letter M.
- Find the probability of a vowel being drawn.
- What is the probability of a consonant being drawn?
- What is the probability that the letter chosen will be a letter in the word THEMATIC?

8H

- 10 A die is rolled and then a coin is flipped.

- Draw a table to list the sample space of this experiment.
- Find the probability that the die shows an even number and the coin shows tails.
- Find the probability of obtaining the pair (3, heads).

8I

- 11 A two-digit number is to be made from the digits 3, 4 and 5.
- Draw a tree diagram to show all outcomes. The digits are chosen randomly and can be used more than once (e.g. 44 is possible).
  - What is the probability of creating an even number?
  - Find the probability that the number is divisible by 3.
  - What is the probability that the sum of the two digits is greater than 8?
  - Find the probability that the number starts with 3 or 5.
  - If the numbers cannot be used more than once, what is the probability of creating an even number?

8J

- 12 The Venn diagram on the right shows which numbers between 1 and 100 are odd and which are prime. Consider the numbers 1–100.

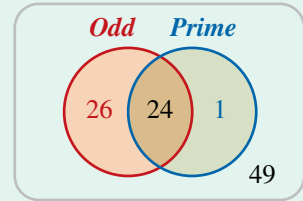

- How many are odd?
- How many prime numbers are there?
- What is the probability that a randomly selected number will be odd and prime?
- What is the probability that a randomly selected number will be prime but not odd?
- If an odd number is chosen, what is the probability that it is prime?
- If a prime number is chosen, what is the probability that it is odd?

## Multiple-choice questions

8A

- 1 Using the information in the column graph, how many students don't walk to school?
- A 75                      B 150                      C 300  
D 375                      E 100

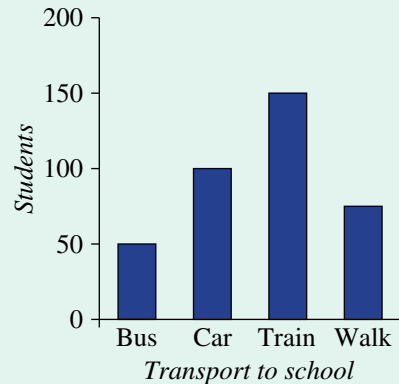

8A

- 2 The lollies in a bag are grouped by colour and the proportions shown in the pie chart. If there are equal numbers of blue and brown lollies, how many are blue, given that the bag contains 28 green ones?
- A 112                      B 7                      C 56  
D 14                      E 28

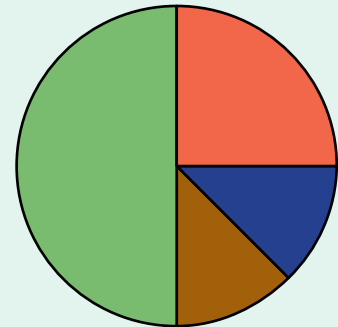

8B

- 3 The tally below shows the number of goals scored by a soccer team over a season.

Goals	0	1	2	3	4
Tally	####	###			

Which one of the following statements is true?

8D

- A In the first game the team scored 5 goals.  
 B In four of the games the team scored two goals.  
 C In most of their games they did not score any goals.  
 D They had five games in which they scored one goal.  
 E The total number of goals scored for the season was 10.

- 4 The median number of goals scored by the soccer team above is:

A 0                      B 1                      C 2                      D 3                      E 4

8D

- 5 Which is the best description of the mode in a set of test scores?

- A The average of the scores  
 B The score in the middle  
 C The score with the highest frequency  
 D The difference between the highest and lowest score  
 E The lowest score

8E

- 6 For the set of data 1, 5, 10, 12, 14, 20, the interquartile range is:

A 1                      B 19                      C 4                      D 11                      E 9

Ext

8G

- 7 The letters of the word STATISTICS are placed on 10 different cards and placed into a hat. If a card is drawn at random, the probability that it will show a vowel is:

A 0.2                      B 0.3                      C 0.4                      D 0.5                      E 0.7

8H

- 8 A fair die is rolled and then the spinner to the right is spun. The probability that the die will display the same number as the spinner is:

A  $\frac{1}{36}$                       B  $\frac{1}{18}$                       C  $\frac{1}{6}$   
 D  $\frac{1}{2}$                       E 1

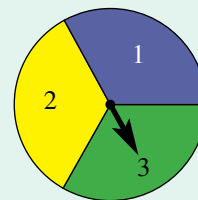

8I

- 9 A coin is tossed three times. The probability of obtaining at least 2 tails is:

A  $\frac{2}{3}$                       B 4                      C  $\frac{1}{2}$                       D  $\frac{3}{8}$                       E  $\frac{1}{8}$

8K

- 10 An experiment is conducted in which three dice are rolled and the sum of the faces is added. In 12 of the 100 trials, the sum of the faces was 11. Based on this, the experimental probability of having three faces add to 11 is:

A  $\frac{11}{100}$                       B  $\frac{12}{111}$                       C  $\frac{3}{25}$                       D 12                      E  $\frac{1}{2}$



## Extended-response questions

- 1 The two-way table below shows the results of a survey on car ownership and public transport usage. You can assume the sample is representative of the population.

	Uses public transport	Does not use public transport	Total
Own a car	20	80	
Do not own a car	65	35	
Total			

- Copy and complete the table.
  - How many people were surveyed in total?
  - What is the probability that a randomly selected person will have a car?
  - What is the probability that a randomly selected person will use public transport and also own a car?
  - What is the probability that someone owns a car given that they use public transport?
  - If a car owner is selected, what is the probability that they will catch public transport?
  - In what ways could the survey produce biased results if it had been conducted:
    - outside a train station?
    - in regional New South Wales?
- 2 A spinner is made using the numbers 1, 3, 5 and 10 in four sectors. The spinner is spun 80 times, and the results obtained are shown in the table.

Number on spinner	Frequency
1	30
3	18
5	11
10	21
Total	80

- Display the data as a frequency graph.
- Which sector on the spinner occupies the largest area? Explain.
- Two sectors of the spinner have the same area. Which two numbers do you think have equal areas, and why?
- What is the experimental probability of obtaining a 1 on the next spin?
- Draw an example of what you think the spinner might look like, in terms of the area covered by each of the four numbers.

# 9

## Linear relationships

### Maths in context: The Cartesian coordinate system

The French mathematician René Descartes was lying in bed watching a fly crawl across the ceiling. To describe the fly's position in 2D, he used a ceiling corner as a reference point, with across and up/down distances. In 1637, Descartes published the Cartesian coordinate system he had created. This system linked geometry and algebra and revolutionised mathematics, laying the foundation for the invention of calculus.

When graphed, linear equations form straight lines of constant slope. They arise in many contexts, such as farming: fertiliser weight = kg/acre  $\times$  number of acres; nursing: medical dose = amount/kg  $\times$  patient's weight; accounting: wages = pay \$/hour  $\times$  hours

worked; science: mass = density (g/cm<sup>3</sup>)  $\times$  volume; measurement: unit conversions, e.g. temperature  $F = \frac{9}{5}C + 32$ .

The 2D Cartesian coordinate system is also the basis for 3D printing. Algorithms guide where the printer head moves on the  $x$ - $y$  number plane, printing a curve about 0.2 mm thick. Slowly, slice by slice, a 3D object is printed. Examples of 3D printing include: artificial replacement body parts (e.g. hands, legs and ears); models for engineering projects; engine parts; 3D geology landscape models; and anatomy structures for a surgeon, e.g. a patient's skull or heart.

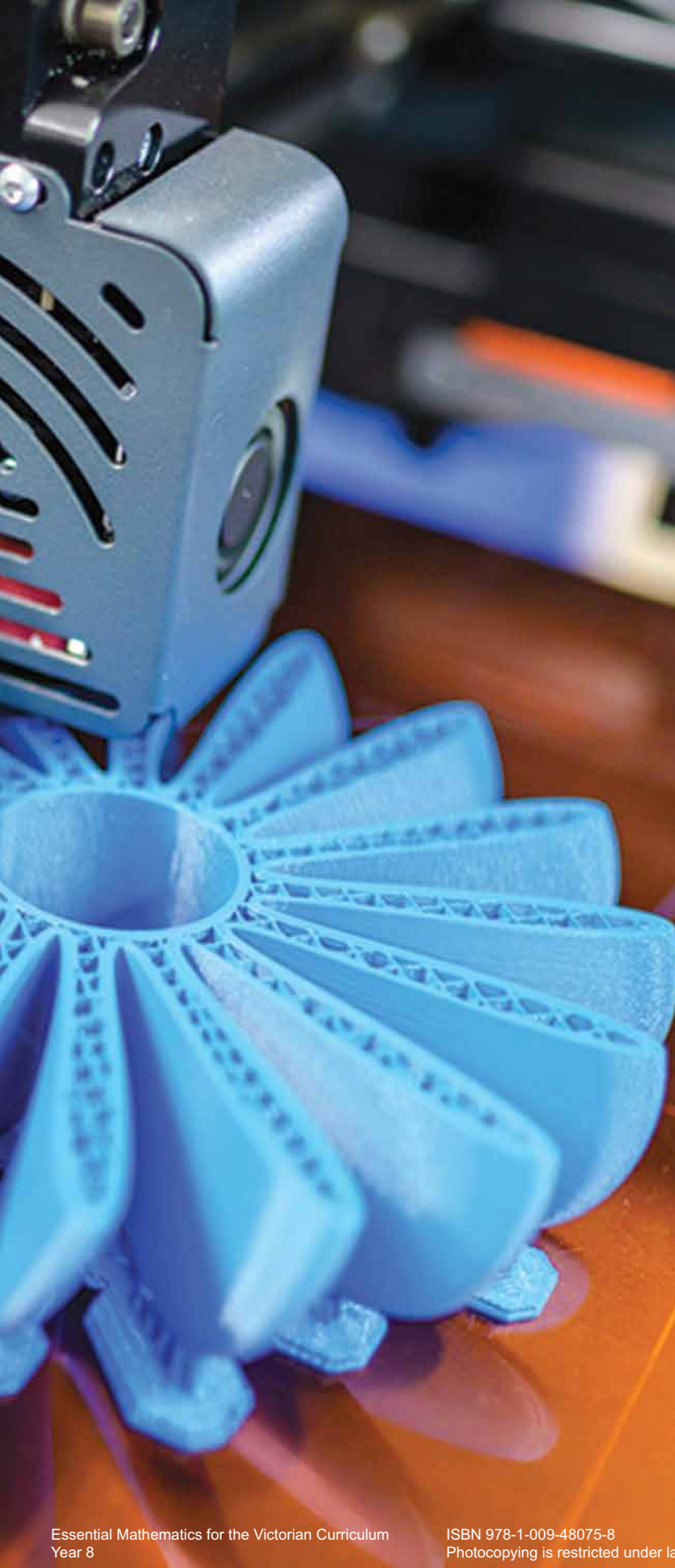

## Chapter contents

- 9A The Cartesian plane (CONSOLIDATING)
- 9B Using rules, tables and graphs to explore linear relationships
- 9C Finding the rule using a table of values
- 9D Using graphs to solve linear equations
- 9E Using graphs to solve linear inequalities
- 9F The  $x$ - and  $y$ -intercepts
- 9G Gradient (EXTENDING)
- 9H Gradient–intercept form (EXTENDING)
- 9I Applications of straight line graphs
- 9J Non-linear graphs (EXTENDING)

## Victorian Curriculum 2.0

This chapter covers the following content descriptors in the Victorian Curriculum 2.0:

### ALGEBRA

VC2M8A02, VC2M8A03, VC2M8A05

Please refer to the curriculum support documentation in the teacher resources for a full and comprehensive mapping of this chapter to the related curriculum content descriptors.

© VCAA

## Online resources

A host of additional online resources are included as part of your Interactive Textbook, including HOTmaths content, video demonstrations of all worked examples, auto-marked quizzes and much more.

## 9A The Cartesian plane CONSOLIDATING

### LEARNING INTENTIONS

- To understand that coordinates can be used to describe locations in two-dimensional space on a number plane
- To know the location of the four quadrants of a number plane
- To be able to plot points at given coordinates

On a number plane, a pair of coordinates gives the exact position of a point. The number plane is also called the Cartesian plane after its inventor, René Descartes, who lived in France in the 17th century. The number plane extends both a horizontal axis ( $x$ ) and vertical axis ( $y$ ) to include negative numbers. The point where these axes cross over is called the ‘origin’ and it provides a reference point for all other points on the plane.



CAD (computer-aided design) software uses a number plane with points located by their coordinates and straight lines modelled with linear equations. Architects, surveyors, engineers and industrial designers all use CAD.

### Lesson starter: Make the shape

In groups or as a class, see if you can remember how to plot points on a number plane. Then decide what type of shape is formed by each set.

- $A(0, 0)$ ,  $B(3, 1)$ ,  $C(0, 4)$
- $A(-2, 3)$ ,  $B(-2, -1)$ ,  $C(-1, -1)$ ,  $D(-1, 3)$
- $A(-3, -4)$ ,  $B(2, -4)$ ,  $C(0, -1)$ ,  $D(-1, -1)$

Discuss the basic rules for plotting points on a number plane.

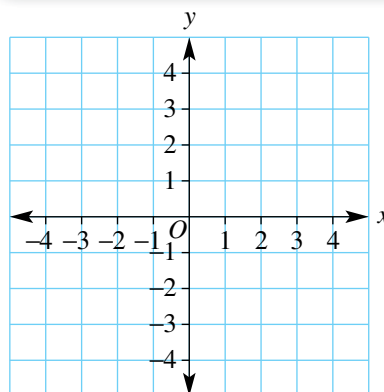

### KEY IDEAS

- A **number plane** (or **Cartesian plane**) includes a vertical  $y$ -axis and a horizontal  $x$ -axis intersecting at right angles.
  - There are 4 **quadrants** labelled as shown.
- A point on a number plane has **coordinates** ( $x, y$ ).
  - The  $x$ -coordinate is listed first followed by the  $y$ -coordinate.
- The point  $(0, 0)$  is called the **origin** ( $O$ ).

$$\blacksquare (x, y) = \left( \begin{array}{cc} \text{horizontal} & \text{vertical} \\ \text{units from} & \text{units from} \\ \text{origin} & \text{origin} \end{array} \right)$$

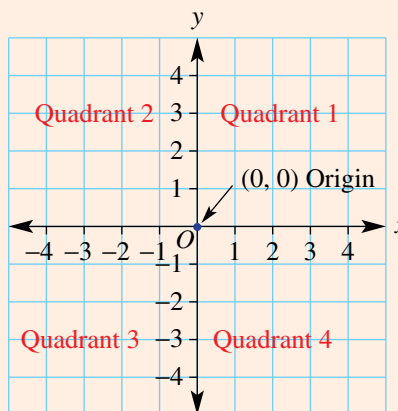

**BUILDING UNDERSTANDING**

- 1 State the missing parts to complete these sentences.
  - a The coordinates of the origin are \_\_\_\_\_.
  - b The vertical axis is called the \_\_\_-axis.
  - c The quadrant that has positive coordinates for both  $x$  and  $y$  is the \_\_\_\_\_ quadrant.
  - d The quadrant that has negative coordinates for both  $x$  and  $y$  is the \_\_\_\_\_ quadrant.
  - e The point  $(-2, 3)$  has  $x$ -coordinate \_\_\_\_\_.
  - f The point  $(1, -5)$  has  $y$ -coordinate \_\_\_\_\_.
  
- 2 State the missing number for the coordinates of the points **a-h**.

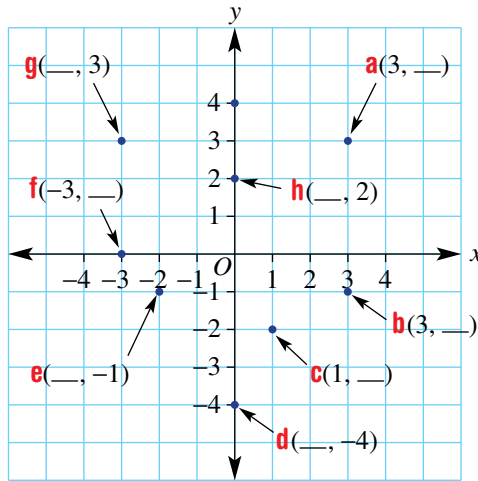

- 3 State the coordinates of the points labelled A to M.

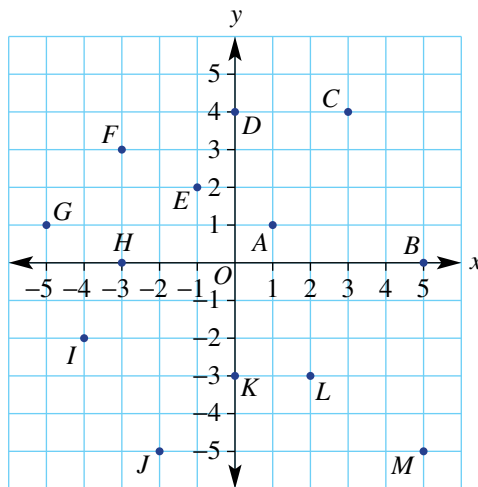



### Example 1 Plotting points on a number plane

Draw a number plane extending from  $-4$  to  $4$  on both axes, and then plot and label these points.

**a**  $A(2, 3)$

**b**  $B(0, 4)$

**c**  $C(-1, 2.5)$

**d**  $D(-3.5, 0)$

**e**  $E(-2, -2.5)$

**f**  $F(2, -4)$

#### SOLUTION

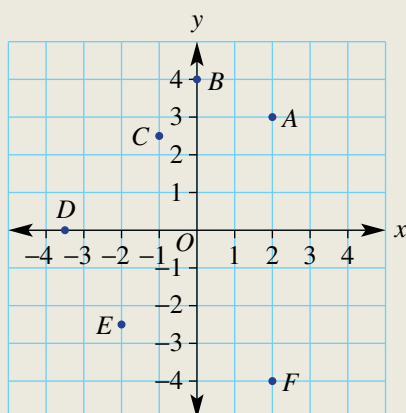

#### EXPLANATION

The  $x$ -coordinate is listed first followed by the  $y$ -coordinate.

For each point start at the origin  $(0, 0)$  and move left or right or up and down to suit both  $x$ - and  $y$ -coordinates. For point  $C(-1, 2.5)$ , for example, move 1 to the left and 2.5 up.

#### Now you try

Draw a number plane extending from  $-4$  to  $4$  on both axes, and then plot and label these points.

**a**  $A(4, 1)$

**b**  $B(0, 2)$

**c**  $C(-2, 3.5)$

**d**  $D(-2.5, 0)$

**e**  $E(-1, -3.5)$

**f**  $F(4, -3)$

## Exercise 9A

### FLUENCY

1, 2-3( $\frac{1}{2}$ )

2-3( $\frac{1}{2}$ )

2-3( $\frac{1}{2}$ )

**Example 1** 1 Draw a number plane extending from  $-4$  to  $4$  on both axes, and then plot and label these points.

**a**  $A(2, 3)$

**b**  $B(0, 1)$

**c**  $C(-2, 2)$

**d**  $D(-3, 0)$

**e**  $E(-3, -4)$

**f**  $F(4, -3)$

**Example 1** 2 Draw a number plane extending from  $-4$  to  $4$  on both axes, and then the plot and label these points.

**a**  $A(4, 1)$

**b**  $B(2, 3)$

**c**  $C(0, 1)$

**d**  $D(-1, 3)$

**e**  $E(-3, 3)$

**f**  $F(-2, 0)$

**g**  $G(-3, -1)$

**h**  $H(-1, -4)$

**i**  $I(0, -2.5)$

**j**  $J(3.5, 3.5)$

**k**  $K(3.5, -1)$

**l**  $L(1.5, -4)$

**m**  $M(-3.5, -3.5)$

**n**  $N(-3.5, 0.5)$

**o**  $O(0, 0)$

**p**  $P(2.5, -3.5)$



## 9B Using rules, tables and graphs to explore linear relationships

### LEARNING INTENTIONS

- To understand that a relationship between variables  $x$  and  $y$  can be shown as a table or as a graph
- To understand that a point lies on the graph of an equation if substituting the values for  $x$  and  $y$  makes the equation true
- To be able to construct a table of points for a rule
- To be able to construct a graph from a rule or a table of points

From our earlier study of formulas we know that two (or more) variables that have a relationship can be linked by a rule. A rule with two variables can be represented on a graph to illustrate this relationship. The rule can be used to generate a table that shows coordinate pairs  $(x, y)$ . The coordinates can be plotted to form the graph. Rules that give straight line graphs are described as being linear.

For example, the rule linking degrees Celsius ( $^{\circ}\text{C}$ ) with degrees Fahrenheit ( $^{\circ}\text{F}$ ) is given by  $C = \frac{5}{9}(F - 32)$  and gives a straight line graph.



Each country's currency is directly proportional to every other currency, forming linear relationships,  $y = mx$ , where  $m$  is the exchange rate. For example,

$$(\text{USD})y = 0.7x(\text{AUD});$$

$$(\text{EUR})y = 0.6x(\text{AUD});$$

$$(\text{JPY})y = 75x(\text{AUD}).$$

### Lesson starter: They're not all straight

Not all rules give a straight line graph. Here are three rules that can be graphed to give lines or curves.

1  $y = \frac{6}{x}$

2  $y = x^2$

3  $y = 2x + 1$

- In groups, discuss which rule(s) might give a straight line graph and which might give curves.
- Use the rules to complete the given table of values.
- Discuss how the table of values can help you decide which rule(s) give a straight line.
- Plot the points to see if you are correct.

$x$	1	2	3
$y = \frac{6}{x}$			
$y = x^2$			
$y = 2x + 1$			

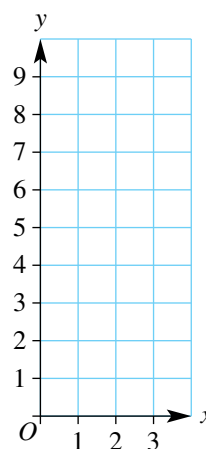



## KEY IDEAS

- A **rule** is an equation which describes the relationship between two or more variables.
- A **linear** relationship will result in a straight line graph.
- For two variables, a linear rule is often written with  $y$  as the subject.  
For example:  $y = 2x - 3$  or  $y = -x + 7$
- Special lines
  - Horizontal: All points will have the same  $y$ -value, for example,  $y = 4$ .
  - Vertical: All points will have the same  $x$ -value, for example,  $x = -2$ .
- One way to graph a linear relationship using a rule is to follow these steps.
  - Construct a table of values finding a  $y$ -coordinate for each given  $x$ -coordinate by substituting each  $x$ -coordinate into the rule.
  - Plot the points given in the table on a set of axes.
  - Draw a line through the points to complete the graph.

## BUILDING UNDERSTANDING

- 1 For the rule  $y = 2x + 3$ , find the  $y$ -coordinate for these  $x$ -coordinates.

a 1

b 0

c -5

d 11

- 2 State the missing number in these tables for the given rules.

a  $y = 2x$ 

$x$	0	1	2	3
$y$	0		4	6

b  $y = x - 3$ 

$x$	-1	0	1	2
$y$	-4	-3		-1

c  $y = 5x + 2$ 

$x$	-3	-2	-1	0
$y$		-8	-3	2

- 3 Complete the graph to form a straight line from the given rule and table.

Two points have been plotted for you.

 $y = 2x - 2$ 

$x$	-2	-1	0	1	2
$y$	-6	-4	-2	0	2

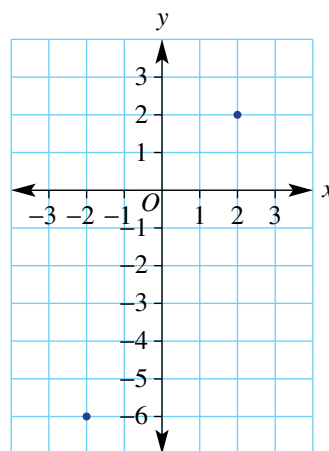



### Example 2 Plotting a graph from a rule

For the rule  $y = 2x - 1$ , construct a table and draw a graph.

#### SOLUTION

$x$	-3	-2	-1	0	1	2	3
$y$	-7	-5	-3	-1	1	3	5

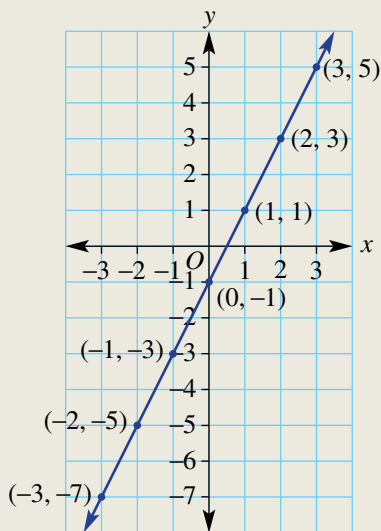

#### EXPLANATION

Substitute each  $x$ -coordinate in the table into the rule to find the  $y$ -coordinate. Plot each point  $(-3, -7)$ ,  $(-2, -5)$ , ... and join them to form the straight line graph.

#### Now you try

For the rule  $y = 3x + 1$ , construct a table and draw a graph.



### Example 3 Checking if a point lies on a line

Decide if the points  $(1, 3)$  and  $(-2, -4)$  lie on the graph of  $y = 3x$ .

#### SOLUTION

Substitute  $x = 1$  and  $y = 3$ .

$$y = 3x$$

$$3 = 3 \times 1 \text{ (True)}$$

$\therefore (1, 3)$  is on the line.

Substitute  $x = -2$  and  $y = -4$ .

$$y = 3x$$

$$-4 = 3 \times -2 \text{ (False)}$$

$\therefore (-2, -4)$  is not on the line.

#### EXPLANATION

Substitute  $(1, 3)$  into the rule for the line.

The equation is true, so the point is on the line.

Substitute  $(-2, -4)$  into the rule for the line.

The equation is not true, so the point is not on the line.

#### Now you try

Decide if the points  $(4, 12)$  and  $(-2, -8)$  lie on the graph of  $y = 4x$ .

## Exercise 9B

### FLUENCY

1, 2(1/2), 3, 4(1/2)

2(1/2), 3, 4(1/2)

2(1/4), 3, 4(1/2)

Example 2

- 1 For the rule  $y = 3x - 1$ , construct a table like the one shown here and draw a graph.

$x$	-2	-1	0	1	2
$y$					

Example 2

- 2 For each rule, construct a table like the one shown here and draw a graph.

$x$	-3	-2	-1	0	1	2	3
$y$							

a  $y = x + 1$

b  $y = x - 2$

c  $y = 2x - 3$

d  $y = 2x + 1$

e  $y = -2x + 3$

f  $y = -3x - 1$

g  $y = -x$

h  $y = -x + 4$

- 3 Plot the points given to draw these special lines.

- a Horizontal ( $y = 2$ )

$x$	-2	-1	0	1	2
$y$	2	2	2	2	2

- b Vertical ( $x = -3$ )

$x$	-3	-3	-3	-3	-3
$y$	-2	-1	0	1	2

Example 3

- 4 For each rule, decide if the given points lie on the graph of that rule.

a Rule:  $y = 2x$

Points: i (2, 4) and ii (3, 5)

b Rule:  $y = 3x - 1$

Points: i (1, 1) and ii (2, 5)

c Rule:  $y = 5x - 3$

Points: i (-1, 0) and ii (2, 12)

d Rule:  $y = -2x + 4$

Points: i (1, 2) and ii (2, 0)

e Rule:  $y = 3 - x$

Points: i (1, 2) and ii (4, 0)

f Rule:  $y = 10 - 2x$

Points: i (3, 4) and ii (0, 10)

g Rule:  $y = -1 - 2x$

Points: i (2, -3) and ii (-1, 1)

### PROBLEM-SOLVING

5

5-6(1/2)

6(1/2), 7, 8

- 5 For  $x$ -coordinates from  $-3$  to  $3$ , construct a table and draw a graph for these rules. For parts **c** and **d** remember that subtracting a negative number is the same as adding its opposite; for example, that  $3 - (-2) = 3 + 2$ .

a  $y = \frac{1}{2}x + 1$

b  $y = -\frac{1}{2}x - 2$

c  $y = 3 - x$

d  $y = 1 - 3x$

- 6 For the graphs of these rules, state the coordinates of the two points at which the line cuts the  $x$ - and  $y$ -axes. If possible, you can use graphing software to draw these graphs.

a  $y = x + 1$

b  $y = 2 - x$

c  $y = 2x + 4$

d  $y = 10 - 5x$

e  $y = 2x - 3$

f  $y = 7 - 3x$

- 7 The rules for two lines are  $y = x + 2$  and  $y = 5 - 2x$ . At what point do they intersect?

- 8 A straight line graph is to be drawn from a rule. The table is shown below with some values missing.

$x$	-2	-1	0	1	2	3
$y$			3		7	

- a Copy and complete the table.  
 b Decide whether the point (5, 13) would be on the graph.  
 c What would be the value of  $y$  when  $x = -10$ ?

## REASONING

9, 10

9-11

10-12

- 9 a What is the minimum number of points needed to draw a graph of a straight line?

- b Draw the graph of these rules by plotting only two points. Use  $x = 0$  and  $x = 1$ .

i  $y = \frac{1}{2}x$

ii  $y = 2x - 1$

- 10 A table of values is constructed for a rule.

$x$	-3	-2	-1	0	1	2	3
$y$	2	5	8	11	15	17	20

- a By looking at the difference between consecutive  $y$  values, explain why this would not form a straight line graph when these points are plotted.  
 b The rule is actually a linear relation and a mistake was made in calculating one of the  $y$ -values. Which point is the mistake, and what should the coordinates be?
- 11 a The graphs of  $y = x$ ,  $y = 3x$  and  $y = -2x$  all pass through the origin (0, 0). Explain why.  
 b The graphs of  $y = x - 1$ ,  $y = 3x - 2$  and  $y = 5 - 2x$  do not pass through the origin (0, 0). Explain why.
- 12 The  $y$ -coordinates of points on the graphs of the rules in Question 2 parts a to d increase as the  $x$ -coordinates increase. Also the  $y$ -coordinates of points on the graphs of the rules in Question 2 parts e to h decrease as the  $x$ -coordinates increase.
- a What do the rules in Question 2 parts a to d have in common?  
 b What do the rules in Question 2 parts e to h have in common?  
 c What feature of a rule tells you whether a graph increases or decreases as the  $x$ -coordinate increases?

## ENRICHMENT: Axes intercepts

-

-

13(1/2)

- 13 A sketch of a straight line graph can be achieved by finding only the  $x$ - and  $y$ -intercepts and labelling these on the graph. The  $y$ -intercept is the point where  $x = 0$  and the  $x$ -intercept is the point where  $y = 0$ .

For example:  $y = 4 - 2x$

$y$ -intercept ( $x = 0$ )

$$y = 4 - 2 \times 0$$

$$= 4$$

so (0, 4) is the  $y$ -intercept

$x$ -intercept ( $y = 0$ )

$$0 = 4 - 2x$$

$$-4 = -2x$$

$$2 = x$$

$$x = 2$$

so (2, 0) is the  $x$ -intercept

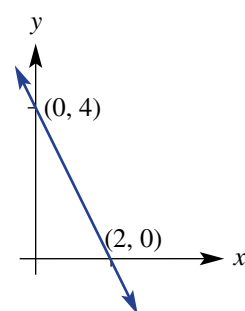

Sketch graphs of these rules using the method outlined above.

a  $y = x + 4$

b  $y = 2x - 4$

c  $y = 5 - x$

d  $y = -1 + 2x$

e  $y = 7x - 14$

f  $y = 5 - 3x$

g  $y = 3 - 2x$

h  $3y - 2x = 6$

i  $3x - 2y = 8$

## 9C Finding the rule using a table of values

### LEARNING INTENTIONS

- To understand that the rule for a linear equation can be determined from a table of values
- To be able to find the rule for a table of values
- To be able to find the rule from a linear graph when the coordinates are known for integer values of  $x$

A mathematical rule is an efficient way of describing a relationship between two variables. While a table and a graph are limited by the number of points they show, a rule can be used to find any value of  $y$  for any given  $x$ -value quickly. Finding such a rule from a collection of points on a graph or table is an important step in the development and application of mathematics.



Timber from plantation forests is used for house frames, furniture and paper. From tables and graphs of a tree's height and girth vs age, linear relationships can be found which help to calculate the best time for harvest and volume of harvest.

### Lesson starter: What's my rule?

Each of the tables here describes a linear relationship between  $y$  and  $x$ .

$x$	$y$
0	4
1	5
2	6
3	7
4	8

$x$	$y$
-3	-5
-2	-3
-1	-1
0	1
1	3

$x$	$y$
-2	5
-1	4
0	3
1	2
2	1

- For each table, write a rule making  $y$  the subject.
- Discuss your strategy for finding the three different rules. What patterns did you notice and how did these patterns help to determine the rule?

## KEY IDEAS

■ A **rule** is an equation that describes the relationship between the  $x$ -coordinate and  $y$ -coordinate in a table or graph.

- Examples of equations are:

$$y = 3x + 2 \quad y = 3x - 1 \quad y = 3x \quad y = x + 3$$

■ Consider a linear rule of the form  $y = \square \times x + \square$ .

$$y = \square \times x + \square$$

coefficient of  $x$

constant

- The **coefficient** of  $x$  will be the increase in  $y$  as  $x$  increases by 1. If there is a decrease in  $y$ , then the coefficient will be negative.

$x$	-2	-1	0	1	2
$y$	-1	1	3	5	7

+2   +2   +2   +2

$y = 2x + 3$

$x$	-2	-1	0	1	2
$y$	1	0	-1	-2	-3

-1   -1   -1   -1

$y = x - 1$

- The **constant** will be the value of  $y$  when  $x = 0$ .
- If the value of  $y$  when  $x = 0$  is not given in the table, substitute another pair of coordinates to find the value of the constant.

$x$	2	3	4	5
$y$	5	7	9	11

+2   +2   +2

$$y = 2x + \square$$

$$5 = 2 \times 2 + \square \quad \text{substituting } (2, 5)$$

$$\text{So } \square = 1$$

$$\therefore y = 2x + 1$$

### BUILDING UNDERSTANDING

1 By how much does  $y$  increase for each increase by 1 in  $x$ ? If  $y$  is decreasing give a negative answer.

a

$x$	-2	-1	0	1	2
$y$	-1	1	3	5	7

b

$x$	-3	-2	-1	0	1
$y$	4	3	2	1	0

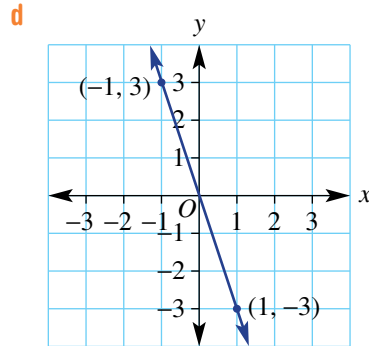
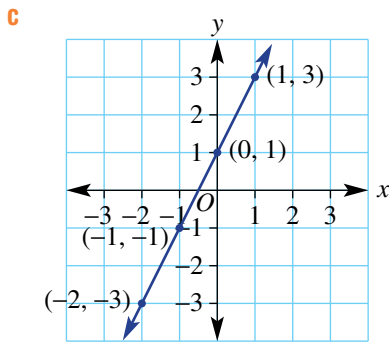

2 For each of the tables and graphs in Question 1, state the value of  $y$  when  $x = 0$ .

3 State the missing number in these equations.

a  $4 = 2 + \square$

b  $5 = 3 \times 2 + \square$

c  $-8 = -4 \times 2 + \square$

d  $16 = -4 \times (-3) + \square$



### Example 4 Finding a rule from a table of values

Find the rule for these tables of values.

a

$x$	-2	-1	0	1	2
$y$	-8	-5	-2	1	4

b

$x$	3	4	5	6	7
$y$	-5	-7	-9	-11	-13

#### SOLUTION

a Coefficient of  $x$  is 3.  
Constant is  $-2$ .  
 $y = 3x - 2$

#### EXPLANATION

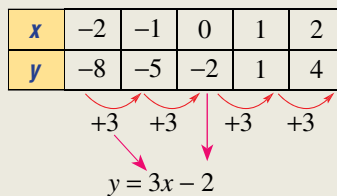

*Continued on next page*

**SOLUTION**

b Coefficient of  $x$  is  $-2$ .

$$y = -2x + \square$$

Substitute  $(3, -5)$ .

$$-5 = -2 \times 3 + \square$$

$$-5 = -6 + \square$$

$$\text{So } \square = 1.$$

$$y = -2x + 1$$

**EXPLANATION**

$x$	3	4	5	6	7
$y$	-5	-7	-9	11	-13

$\xrightarrow{-2}$   $\xrightarrow{-2}$   $\xrightarrow{-2}$   $\xrightarrow{-2}$

$$y = -2x + \square$$

To find the constant, substitute a point and choose the constant so that the equation is true.

This can be done mentally.

**Now you try**

Find the rule for these tables of values.

a

$x$	-2	-1	0	1	2
$y$	-1	1	3	5	7

b

$x$	2	3	4	5	6
$y$	10	7	4	1	-2

**Example 5 Finding a rule from a graph**

Find the rule for this graph by first constructing a table of  $(x, y)$  values.

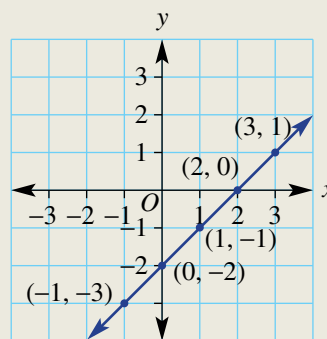
**SOLUTION**

$x$	-1	0	1	2	3
$y$	-3	-2	-1	0	1

Coefficient of  $x$  is 1.

$$\text{When } x = 0, y = -2$$

So the rule is  $y = 1x - 2$

$$\therefore y = x - 2$$

**EXPLANATION**

Construct a table using the points given on the graph. Change in  $y$  is 1 for each increase by 1 in  $x$ .

$x$	-1	0	1	2	3
$y$	-3	-2	-1	0	1

$\xrightarrow{+1}$   $\xrightarrow{+1}$   $\xrightarrow{+1}$   $\xrightarrow{+1}$

$$y = 1x + (-2) \text{ or } y = x - 2$$



**Now you try**

Find the rule for this graph by first constructing a table of  $(x, y)$  values.

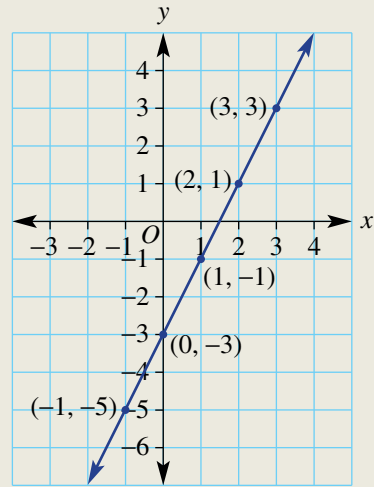

**Exercise 9C**

**FLUENCY**

1, 2-4(1/2)

2-4(1/2)

3-4(1/2)

Example 4a

1 Find the rule for these tables of values.

a

$x$	-2	-1	0	1	2
$y$	4	6	8	10	12

b

$x$	-2	-1	0	1	2
$y$	10	7	4	1	-2

Example 4a

2 Find the rule for these tables of values.

a

$x$	-2	-1	0	1	2
$y$	0	2	4	6	8

b

$x$	-2	-1	0	1	2
$y$	-7	-4	-1	2	5

c

$x$	-3	-2	-1	0	1
$y$	4	3	2	1	0

d

$x$	-1	0	1	2	3
$y$	8	6	4	2	0

Example 4b

3 Find the rule for these tables of values.

a

$x$	1	2	3	4	5
$y$	5	9	13	17	21

b

$x$	-5	-4	-3	-2	-1
$y$	-13	-11	-9	-7	-5

c

$x$	5	6	7	8	9
$y$	-12	-14	-16	-18	-20

d

$x$	-6	-5	-4	-3	-2
$y$	10	9	8	7	6

**Example 5** 4 Find the rule for these graphs by first constructing a table of  $(x, y)$  values.

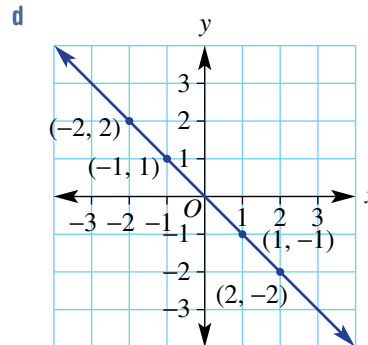
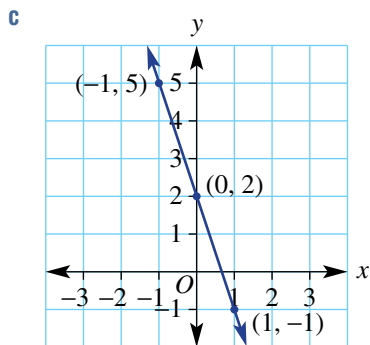
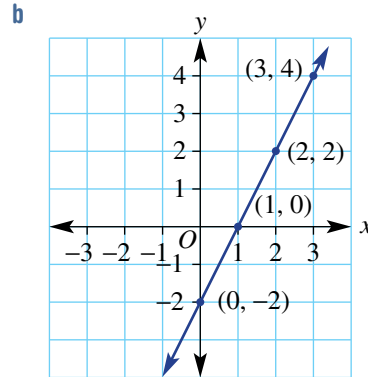
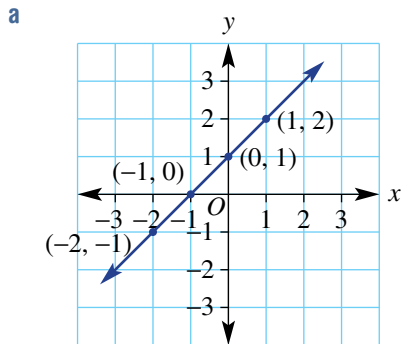

### PROBLEM-SOLVING

5, 6

5-7

6-8

5 Find the rule for these sets of points. Try to do it without drawing a graph or table.

- a**  $(1, 3), (2, 4), (3, 5), (4, 6)$   
**b**  $(-3, -7), (-2, -6), (-1, -5), (0, -4)$   
**c**  $(-1, -3), (0, -1), (1, 1), (2, 3)$   
**d**  $(-2, 3), (-1, 2), (0, 1), (1, 0)$

6 Write a rule for these matchstick patterns.

**a**  $x$  = number of squares,  $y$  = number of matchsticks

Shape 1



Shape 2



Shape 3



Shape 4



b  $x$  = number of hexagons,  $y$  = number of matchsticks

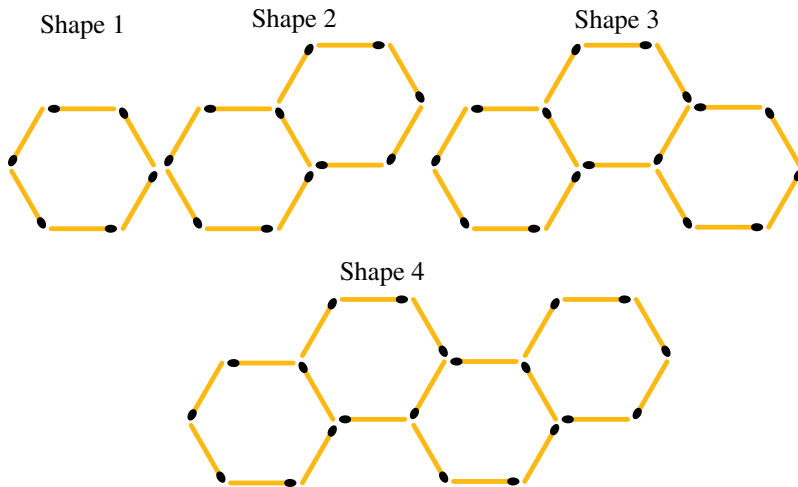

c  $x$  = number of matchsticks on top row,  $y$  = number of matchsticks

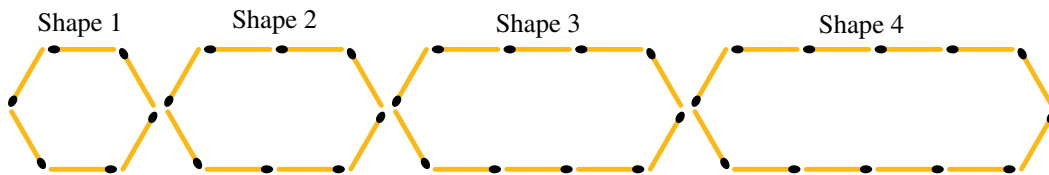

7 The table below shows two points on a straight line graph, (0, 2) and (2, 8).

$x$	-2	-1	0	1	2
$y$			2		8

- a Find the missing three numbers.
  - b State the rule for this graph.
- 8 a A straight line graph passes through the two points (0, -2) and (1, 6). What is the rule of the graph?  
 b A straight line graph passes through the two points (-2, 3) and (4, -3). What is the rule of the graph?

**REASONING** 9, 10 9-11 10-13

- 9 The rule  $y = -2x + 3$  can be written as  $y = 3 - 2x$ . Write these rules in a similar form.  
 a  $y = -2x + 5$       b  $y = -3x + 7$       c  $y = -x + 4$       d  $y = -4x + 1$
- 10 In Question 6a you can observe that 3 extra matchsticks are needed for each new shape and 1 matchstick is needed to complete the first square (so the rule is  $y = 3x + 1$ ). In a similar way, describe how many matchsticks are needed for the shapes in:  
 a Question 6b      b Question 6c.

- 11 A straight line graph passes through (40, 43) and (45, 50).

a Copy and complete the table.

$x$	40	41	42	43	44	45
$y$	43					50

- b What would the  $y$ -value be when  $x = 50$ ?  
 c Find the rule for this graph.  
 d Using your rule, or otherwise, find the  $y$ -value when  $x = 0$ .

- 12 A straight line has two points (0, 2) and (1,  $b$ ).

- a Write an expression for the coefficient of  $x$  in the rule linking  $y$  and  $x$ .  
 b Write the rule for the graph in terms of  $b$ .

- 13 A straight line has two points (0,  $a$ ) and (1,  $b$ ).

- a Write an expression for the coefficient of  $x$  in the rule linking  $y$  and  $x$ .  
 b Write the rule for the graph in terms of  $a$  and  $b$ .

**ENRICHMENT: Skipping  $x$ -values**

-

-

14

- 14 Consider this table of values.

$x$	-2	0	2	4
$y$	-4	-2	0	2

- a The increase in  $y$  for each unit increase in  $x$  is not 2. Explain why.  
 b If the pattern is linear, state the increase in  $y$  for each increase by 1 in  $x$ .  
 c Write the rule for the relationship.  
 d Find the rule for these tables.

i

$x$	-4	-2	0	2	4
$y$	-5	-1	3	7	11

ii

$x$	-3	-1	1	3	5
$y$	-10	-4	2	8	14

iii

$x$	-6	-3	0	3	6
$y$	15	9	3	-3	-9

iv

$x$	-10	-8	-6	-4	-2
$y$	20	12	4	-4	-12

## 9D Using graphs to solve linear equations

### LEARNING INTENTIONS

- To understand that each point on a graph represents a solution to an equation relating  $x$  and  $y$
- To understand that the point of intersection of two straight lines is the only solution that satisfies both equations
- To be able to solve a linear equation using a graph
- To be able to solve an equation with pronumerals on both sides using the intersection point of two linear graphs

The rule for a straight line shows the connection between the  $x$ - and  $y$ -coordinate of each point on the line. We can substitute a given  $x$ -coordinate into the rule to calculate the  $y$ -coordinate. When we substitute a  $y$ -coordinate into the rule, it makes an equation that can be solved to give the  $x$ -coordinate. So, for every point on a straight line, the value of the  $x$ -coordinate is the solution to a particular equation.

The point of intersection of two straight lines is the shared point where the lines cross over each other. This is the only point with coordinates that satisfy both equations; that is, makes both equations true (LHS = RHS).

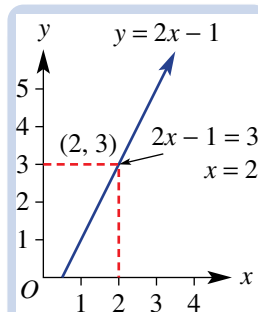

For example, the point  $(2, 3)$  on the line  $y = 2x - 1$  shows us that when  $2x - 1 = 3$  the solution is  $x = 2$ .

### Lesson starter: Matching equations and solutions

When a value is substituted into an equation and it makes the equation true (LHS = RHS), then that value is a solution to that equation.

- From the lists below, match each equation with a solution. Some equations have more than one solution.

Equations	
$2x - 4 = 8$	$y = x + 4$
$3x + 2 = 11$	$y = 2x - 5$
$y = 10 - 3x$	$5x - 3 = 2$

Possible solutions			
$x = 1$	$(1, 5)$	$x = 2$	$(3, 1)$
$x = -1$	$x = 6$	$(2, -1)$	$(2, 6)$
$(-2, -9)$	$(-2, 16)$	$x = 3$	$(2, 4)$

- Which two equations share the same solution and what is this solution?
- List the equations that have only one solution. What is a common feature of these equations?
- List the equations that have more than one solution. What is a common feature of these equations?

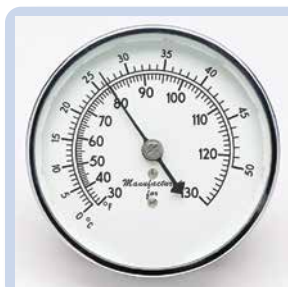

The rule linking degrees Fahrenheit,  $F$ , with degrees Celsius,  $C$ , is given by  $F = \frac{9}{5}C + 32$ ; a straight line graph joins the points with coordinates  $(C, F)$ . The point  $(35, 95)$  shows that  $C = 35$  is the solution of:  $95 = \frac{9}{5}C + 32$ .

## KEY IDEAS

■ The  $x$ -coordinate of each point on the graph of a straight line is a solution to a particular linear equation.

- A particular linear equation is formed by substituting a chosen  $y$ -coordinate into a linear relationship.

For example: If  $y = 2x - 1$  and  $y = 4$ , then the linear equation is  $2x - 1 = 4$ .

- The solution to this equation is the  $x$ -coordinate of the point with the chosen  $y$ -coordinate.

For example: The point  $(2.5, 4)$  shows that  $x = 2.5$  is the solution to  $2x - 1 = 4$ .

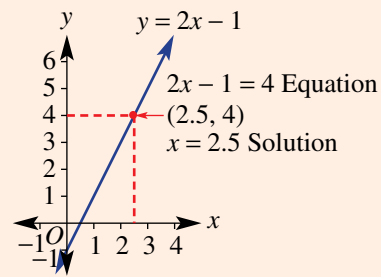

■ A point  $(x, y)$  is a solution to the equation for a line if its coordinates make the equation true.

- An equation is true when  $LHS = RHS$  after the coordinates are substituted.
- Every point on a straight line is a solution to the equation for that line.
- Every point that is not on a straight line is not a solution to the equation for that line.

■ The point of intersection of two straight lines is the only solution that satisfies both equations.

- The point of intersection is the shared point where two straight lines cross each other.
- This is the only point with coordinates that make both equations true.

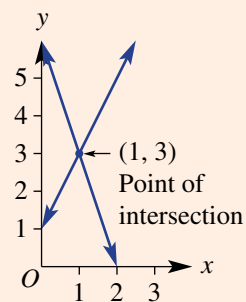

For example:  $(1, 3)$  is the only point that makes both  $y = 6 - 3x$  and  $y = 2x + 1$  true.

Substituting  $(1, 3)$

$$\begin{aligned} y &= 6 - 3x \\ 3 &= 6 - 3 \times 1 \\ 3 &= 3 \text{ (True)} \end{aligned}$$

$$\begin{aligned} y &= 2x + 1 \\ 3 &= 2 \times 1 + 1 \\ 3 &= 3 \text{ (True)} \end{aligned}$$

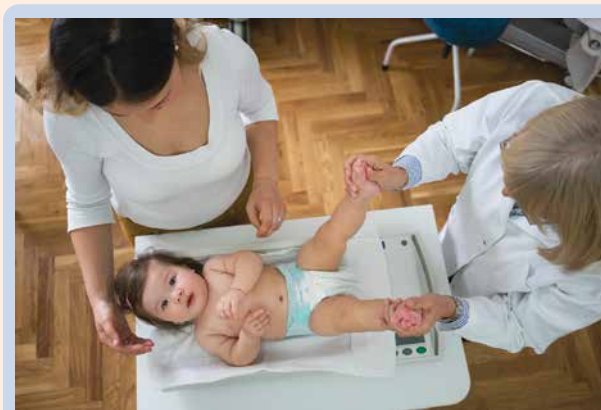

A straight line graph is used to model the relationship between height and weight for babies.

### BUILDING UNDERSTANDING

1 Substitute each given  $y$ -coordinate into the rule  $y = 2x - 3$ , and then solve the equation algebraically to find the  $x$ -coordinate.

a  $y = 7$

b  $y = -5$

2 State the coordinates  $(x, y)$  of the point on this graph of  $y = 2x$  where:

a  $2x = 4$  (i.e.  $y = 4$ )

b  $2x = 6.4$

c  $2x = -4.6$

d  $2x = 7$

e  $2x = -14$

f  $2x = 2000$

g  $2x = 62.84$

h  $2x = -48.602$

i  $2x = \text{any number}$  (worded answer)

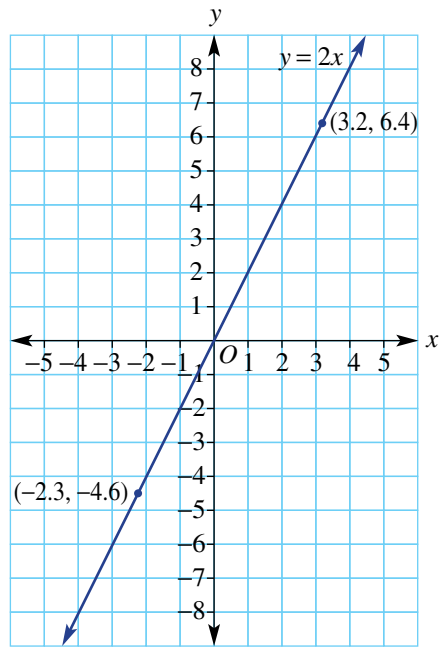

3 For each of these graphs state the coordinates of the point of intersection (i.e. the point where the lines cross over each other).

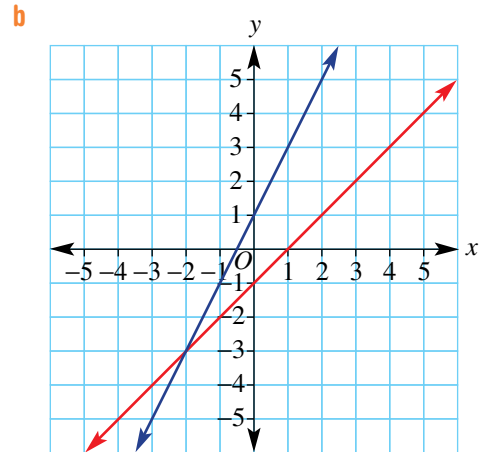
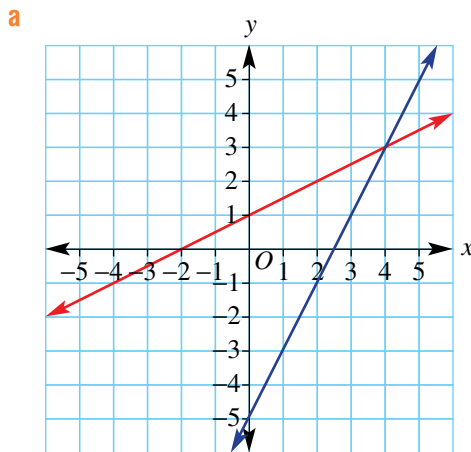



### Example 6 Using a linear graph to solve an equation

Use the graph of  $y = 2x + 1$ , shown here, to solve each of the following equations.

- a  $2x + 1 = 5$
- b  $2x + 1 = 0$
- c  $2x + 1 = -4$

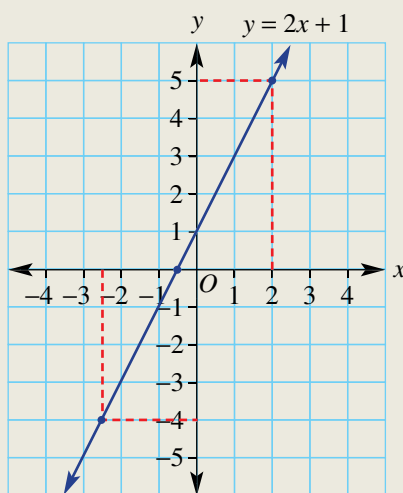

#### SOLUTION

- a  $x = 2$
- b  $x = -0.5$
- c  $x = -2.5$

#### EXPLANATION

Locate the point on the line with  $y$ -coordinate 5. The  $x$ -coordinate of this point is 2 so  $x = 2$  is the solution to  $2x + 1 = 5$ .

Locate the point on the line with  $y$ -coordinate 0. The  $x$ -coordinate of this point is  $-0.5$  so  $x = -0.5$  is the solution to  $2x + 1 = 0$ .

Locate the point on the line with  $y$ -coordinate  $-4$ . The  $x$ -coordinate of this point is  $-2.5$  so  $x = -2.5$  is the solution to  $2x + 1 = -4$ .

#### Now you try

Use the graph of  $y = 2x - 1$ , shown here, to solve each of the following equations.

- a  $2x - 1 = 3$
- b  $2x - 1 = 0$
- c  $2x - 1 = -4$

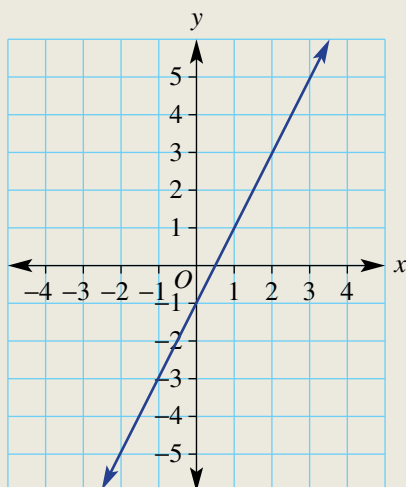





### Example 7 Using the point of intersection to solve two equations simultaneously

Use the graphs of  $y = 4 - x$  and  $y = 2x + 1$ , shown here, to answer these questions.

- a Write the coordinates of four points  $(x, y)$  on the line with equation  $y = 4 - x$ .
- b Write the coordinates of four points  $(x, y)$  on the line with equation  $y = 2x + 1$ .
- c Write the coordinates of the intersection point and show that it satisfies both equations.
- d Solve the equation  $4 - x = 2x + 1$  using the graphs.

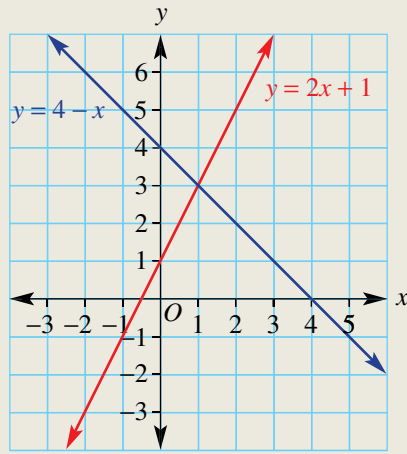

#### SOLUTION

- a  $(-2, 6), (-1, 5), (1, 3), (4, 0)$
- b  $(-2, -3), (0, 1), (1, 3), (2, 5)$
- c  $(1, 3)$        $(1, 3)$   
 $y = 4 - x$      $y = 2x + 1$   
 $3 = 4 - 1$      $3 = 2 \times 1 + 1$   
 $3 = 3$          $3 = 3$   
 True         True
- d  $x = 1$

#### EXPLANATION

Many correct answers. Each point on the line  $y = 4 - x$  is a solution to the equation for that line.

Many correct answers. Each point on the line  $y = 2x + 1$  is a solution to the equation for that line.

The point of intersection  $(1, 3)$  is the solution that satisfies both equations.

Substitute  $(1, 3)$  into each equation and show that it makes a true equation (LHS = RHS).

The solution to  $4 - x = 2x + 1$  is the  $x$ -coordinate at the point of intersection.

The value of both rules is equal for this  $x$ -coordinate.

#### Now you try

Use the graphs of  $y = 5 - x$  and  $y = 2x - 1$ , shown here, to answer these questions.

- a Write the coordinates of four points  $(x, y)$  on the line with equation  $y = 5 - x$ .
- b Write the coordinates of four points  $(x, y)$  on the line with equation  $y = 2x - 1$ .
- c Write the coordinates of the intersection point and show that it satisfies both equations.
- d Solve the equation  $5 - x = 2x - 1$ .

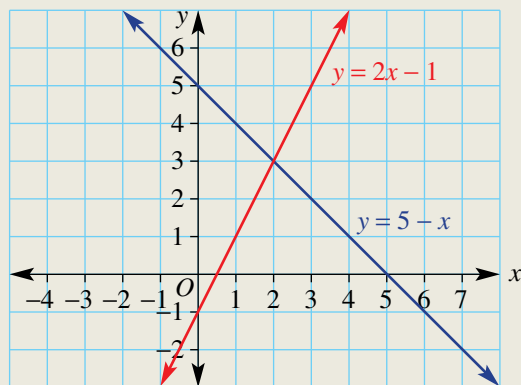

## Exercise 9D

## FLUENCY

1, 2-4(1/2), 5

2-4(1/2), 5

2-4(1/2), 6

Example 6

- 1 Use the graph of  $y = 2x - 1$ , shown here, to solve each of the following equations.

- a  $2x - 1 = 3$  (*Hint*: Find  $x$  for  $y = 3$ .)  
 b  $2x - 1 = 0$   
 c  $2x - 1 = 5$   
 d  $2x - 1 = -6$   
 e  $2x - 1 = -4$   
 f  $2x - 1 = -1$

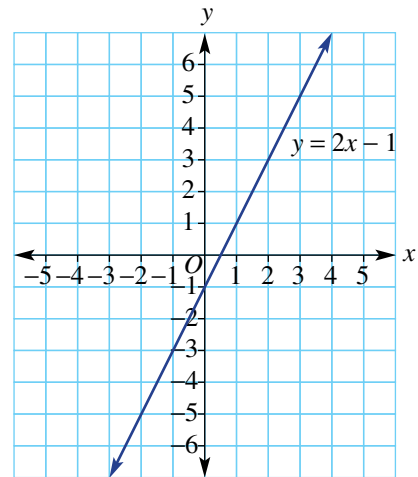

Example 6

- 2 Use the graph of  $y = 3 - x$ , shown here, to solve each of the following equations.

- a  $3 - x = 1$  (*Hint*: Find  $x$  for  $y = 1$ .)  
 b  $3 - x = 5.5$   
 c  $3 - x = 0$   
 d  $3 - x = 3.5$   
 e  $3 - x = -1$   
 f  $3 - x = -2$

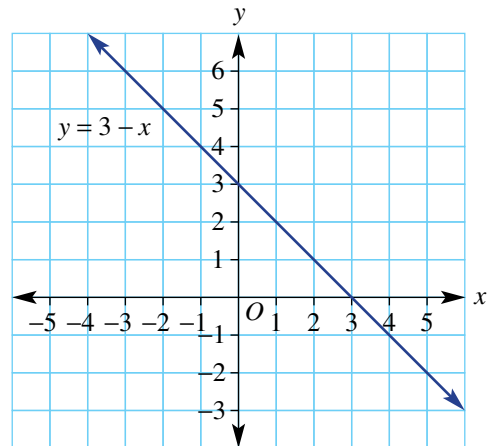

- 3 This graph shows the distance travelled by a cyclist over 4 hours. Use the graph to answer the following.

- a How far has the cyclist travelled after:  
 i 2 hours?            ii 3.5 hours?  
 b How long does it take for the cyclist to travel:  
 i 24 km?            ii 12 km?

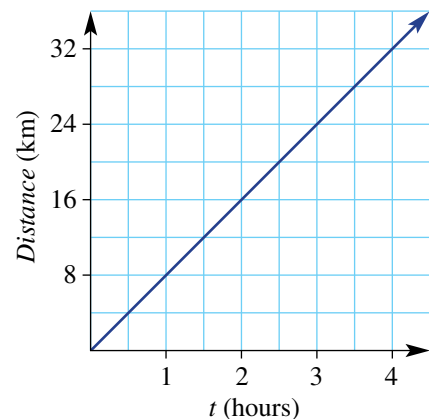

4 Graph each pair of lines on the same set of axes and read off the point of intersection.

a  $y = 2x - 1$

$x$	-2	-1	0	1	2	3
$y$						

$y = x + 1$

$x$	-2	-1	0	1	2	3
$y$						

b  $y = -x$

$x$	-2	-1	0	1	2	3
$y$						

$y = x + 2$

$x$	-2	-1	0	1	2	3
$y$						

5 Use digital technology to sketch a graph of  $y = 1.5x - 2.5$  for  $x$ - and  $y$ -values between  $-7$  and  $7$ . Use the graph to solve each of the following equations. Round answers to two decimal places.

a  $1.5x - 2.5 = 3$

b  $1.5x - 2.5 = -4.8$

c  $1.5x - 2.5 = 5.446$

6 Use digital technology to sketch a graph of each pair of lines and find the coordinates of the points of intersection. Round answers to two decimal places.

a  $y = 0.25x + 0.58$  and  $y = 1.5x - 5.4$

b  $y = 2 - 1.06x$  and  $y = 1.2x + 5$

**PROBLEM-SOLVING**

7, 8

7-9

8-10

7 This graph illustrates a journey over 5 hours.

a What total distance is travelled after:

- i 2 hours?
- ii 3 hours?
- iii 4 hours?
- iv 4.5 hours?

b How long does it take to travel:

- i 50 km?
- ii 75 km?
- iii 125 km?
- iv 200 km?

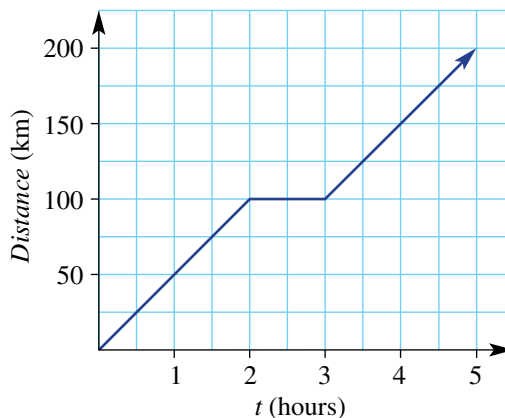

Example 7

8 Use the graphs of  $y = 5 - 2x$  and  $y = x + 2$ , shown here, to answer the following questions.

- a Write the coordinates of four points  $(x, y)$  on the line with equation  $y = 5 - 2x$ .
- b Write the coordinates of four points  $(x, y)$  on the line with equation  $y = x + 2$ .
- c Write the coordinates of the intersection point and show that it satisfies both equations.
- d Solve the equation  $5 - 2x = x + 2$  from the graph.

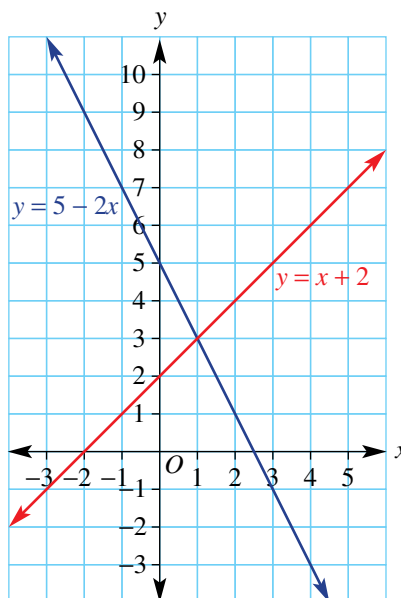

9 Jayden and Ruby are saving all their money for the school ski trip.

- Jayden has saved \$24 and earns \$6 per hour mowing lawns.
- Ruby has saved \$10 and earns \$8 per hour babysitting.

This graph shows the total amount ( $A$ ) in dollars of their savings for the number ( $n$ ) of hours worked.

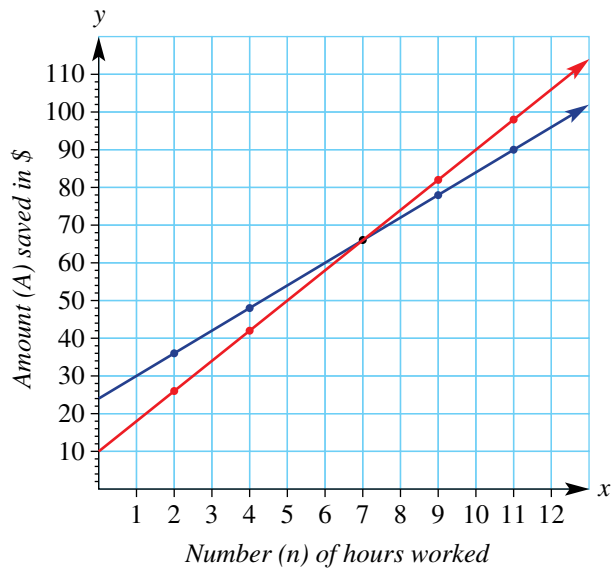

a Here are two rules for calculating the amount ( $A$ ) saved for working for  $n$  hours:

$$A = 10 + 8n \text{ and } A = 24 + 6n$$

Which rule applies to Ruby and which to Jayden? Explain why.

b Use the appropriate line on the graph to find the solution to the following equations.

i  $10 + 8n = 42$

ii  $24 + 6n = 48$

iii  $10 + 8n = 66$

iv  $24 + 6n = 66$

v  $10 + 8n = 98$

vi  $24 + 6n = 90$

c From the graph, write three solutions ( $n, A$ ) that satisfy  $A = 10 + 8n$ .

d From the graph, write three solutions ( $n, A$ ) that satisfy  $A = 24 + 6n$ .

e Write the solution ( $n, A$ ) that is true for both Ruby's and Jayden's equations and show that it satisfies both equations.

f From the graph, find the solution to the equation:  $10 + 8n = 24 + 6n$  (i.e. find the value of  $n$  that makes Ruby's and Jayden's savings equal to each other).

g Explain how many hours have been worked and what their savings are at the point of intersection of the two lines.

10 Jessica and Max have a 10-second running race.

- Max runs at 6 m/s.
- Jessica is given a 10m head-start and runs at 4 m/s.

a Copy and complete this table showing the distance run by each athlete.

Time ( $t$ ) in seconds	0	1	2	3	4	5	6	7	8	9	10
Max's distance ( $d$ ) in metres	0										
Jessica's distance ( $d$ ) in metres	10										

b Plot these points on a distance–time graph and join them to form two straight lines, labelling them 'Jessica' and 'Max'.

c Find the rule linking distance,  $d$ , and time,  $t$ , for Max.

d Using the rule for Max's race, write an equation that has the solution:

i  $t = 3$

ii  $t = 5$

iii  $t = 8$ .

e Find the rule linking distance,  $d$ , and time,  $t$ , for Jessica.

f Using the rule for Jessica's race, write an equation that has the solution:

i  $t = 3$

ii  $t = 5$

iii  $t = 8$ .

- g Write the solution  $(t, d)$  that is true for both distance equations and show that it satisfies both equations.
- h Explain what is happening in the race at the point of intersection and for each athlete state the distance from the starting line and time taken.

<b>REASONING</b>	11	11, 12	12, 13
------------------	----	--------	--------

11 This graph shows two lines with equations  $y = 11 - 3x$  and  $y = 2x + 1$ .

- a Copy and complete the coordinates of each point that is a solution for the given linear equation.
  - i  $y = 11 - 3x$   
 $(-2, ?), (-1, ?)(0, ?)(1, ?)(2, ?)(3, ?)(4, ?)(5, ?)$
  - ii  $y = 2x + 1$   
 $(-2, ?), (-1, ?)(0, ?)(1, ?)(2, ?)(3, ?)(4, ?)(5, ?)$
- b State the coordinates of the point of intersection and show it is a solution to both equations.
- c Explain why the point of intersection is the only solution that satisfies both equations.

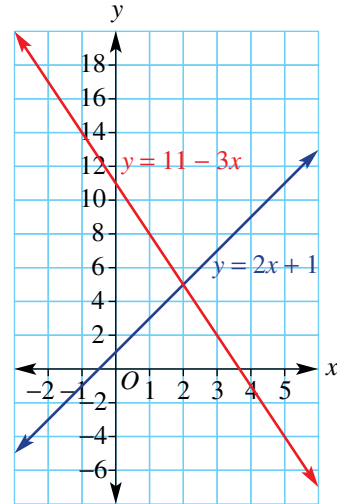

12 The graphs of  $y = 2x + 3$  and  $y = 5 + 2x$  are two parallel lines.

- a Explain how this tells you that  $2x + 3 = 5 + 2x$  has no solutions.
- b Try to solve  $2x + 3 = 5 + 2x$  algebraically, and explain why no solution exists.

13 Here is a table and graph for the line  $y = 2x - 1$ .

<b>x</b>	-1	-0.5	0	0.5	1	1.5	2
<b>y</b>	-3	-2	-1	0	1	2	3

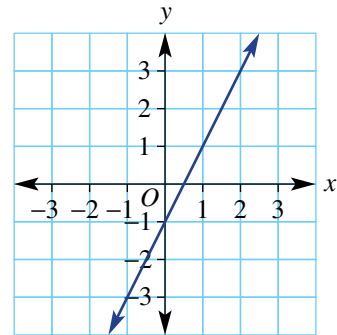

- a Luke says: ‘Only seven equations can be solved from points on this line because the y-values must be whole numbers.’
  - i What are three of the equations and their solutions that Luke could be thinking of?
  - ii Is Luke’s statement correct? Explain your conclusion with some examples.
- b Chloe says: ‘There are sixty equations that can be solved from points on this line because y-values can go to one decimal place.’
  - i What are three extra equations and their solutions that Chloe might have thought of?
  - ii Is Chloe’s statement correct? Explain your conclusion with some examples.
- c Jamie says: ‘There are an infinite number of equations that can be solved from points on a straight line.’
  - i Write the equations that can be solved from these two points:  $(1.52, 2.04)$  and  $(1.53, 2.06)$ .
  - ii Write the coordinates of two more points with x-coordinates between the first two points and write the equations that can be solved from these two points.
  - iii Is Jamie’s statement correct? Explain your reasons.

## ENRICHMENT: More than one solution

14

14 a Use this graph of  $y = x^2$  to solve the following equations.

i  $x^2 = 4$

ii  $x^2 = 9$

iii  $x^2 = 16$

iv  $x^2 = 25$

b Explain why there are two solutions to each of the equations in part a above.

 c Use digital technology to graph  $y = x^2$  and graphically solve the following equations, rounding answers to two decimal places.

i  $x^2 = 5$

ii  $x^2 = 6.8$

iii  $x^2 = 0.49$

iv  $x^2 = 12.75$

v  $x^2 = 18.795$

d Give one reason why the graph of  $y = x^2$  does *not* give a solution to the equation  $x^2 = -9$ .

e List three more equations of the form  $x^2 = \text{'a number'}$  that *cannot* be solved from the graph of  $y = x^2$ .

f List the categories of numbers that *will* give a solution to the equation:  $x^2 = \text{'a number'}$ .

g Graph  $y = x + 2$  and  $y = x^2$  on the same screen and graphically solve  $x^2 = x + 2$  by finding the  $x$ -values of the points of intersection.

h Use digital technology to solve the following equations using graphical techniques. Round answers to two decimal places.

i  $x^2 = 3x + 16$

ii  $x^2 = 27 - 5x$

iii  $x^2 = 2x - 10$

iv  $x^2 = 6x - 9$

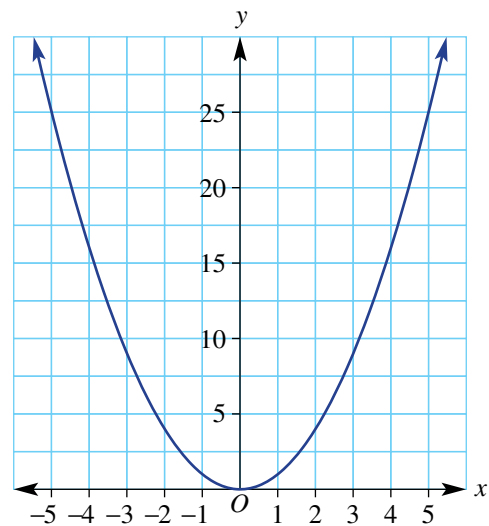

## 9E Using graphs to solve linear inequalities

### LEARNING INTENTIONS

- To understand that graphs can be used to solve inequalities
- To be able to sketch horizontal and vertical lines given their equation
- To be able to graph inequalities using horizontal and vertical lines as regions in the plane
- To be able to solve simple inequalities using graphs

We have already been introduced to inequalities, which are statements containing an inequality symbol  $<$ ,  $\leq$ ,  $>$  and  $\geq$ . For example:  $3x > 6$  or  $2x - 1 \leq 7$ . Such a statement might arise from a situation, for example, where you want to find out the possible number of hours you can hire a sports car if your budget is at most \$500 and the cost is \$80 up-front plus \$60 per hour. The inequality could be written as  $80 + 60t \leq 500$ , where  $t$  is the number of hours.

While it is possible to solve inequalities using algebraic techniques, it is also possible to solve them using graphs. To achieve this, we can use the graphs of horizontal and vertical lines.

### Lesson starter: Why are the equations of horizontal and vertical lines so simple?

The equation  $y = 3$  might not look like the equation of a straight line in two-dimensions. However, it does describe an infinite set of points which can be graphed on a Cartesian plane as a straight line.

Look at this Cartesian plane including the seven given points.

- Write down the coordinates of all seven points.
- What do the coordinates of all the points have in common?  
Now imagine a line passing through all seven points.
- Which of the following points would also sit on this line?  

<b>A</b> (4, 3)	<b>B</b> (-1.5, 3)
<b>C</b> (2, 2)	<b>D</b> (-3, 5)
- Give reasons why  $y = 3$  is the equation of the line described above and why the equation does not depend on the value of  $x$ .  
Now think about a set of points which are aligned vertically, all with  $x = 2$  as its  $x$ -coordinate.
- Give reasons why  $x = 2$  is the equation of the line joining the points and why the equation does not depend on the value of  $y$ .

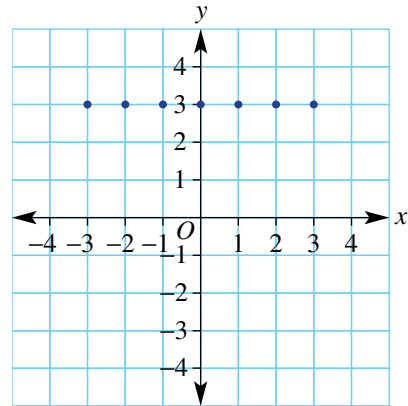

## KEY IDEAS

- A horizontal line (parallel to the  $x$ -axis) has a rule in the form  $y = c$ , where  $c$  is any number.

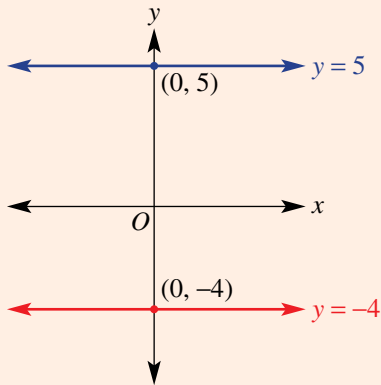

- A vertical line (parallel to the  $y$ -axis) has a rule in the form  $x = k$ , where  $k$  is any number.

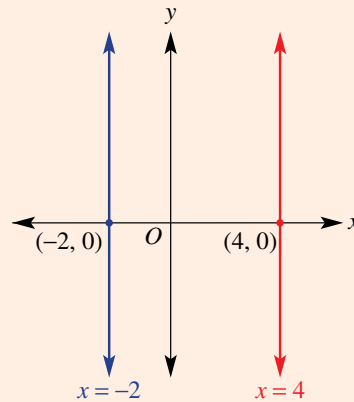

- A region in the plane is described using an inequality.
  - All the points that satisfy the inequality form the shaded region.
  - A dashed line is used to show that the points on the line are not included in the region. A dashed line is used when the  $<$  or  $>$  symbols are given.
  - A full line is used to show that the points on the line are included in the region. A full line is used when the  $\leq$  or  $\geq$  symbols are given.

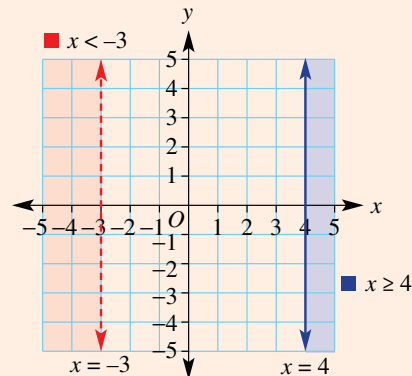
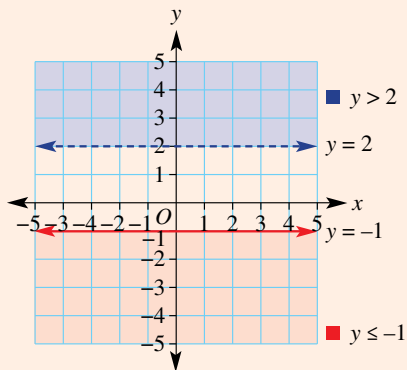

- Graphs can be used to solve inequalities. To solve  $2x + 1 \leq 5$  for example:

- Consider the graph of  $y = 2x + 1$  and the region  $y \leq 5$ .
- The solution to  $2x + 1 \leq 5$  will be all the  $x$  values of the points that are on the line  $y = 2x + 1$  and also in the region  $y \leq 5$ , shown in red. The solution is therefore  $x \leq 2$ .
- Alternatively, the solution to  $2x + 1 > 5$  will be  $x > 2$  where the line  $y = 5$  would be drawn as a dashed line.

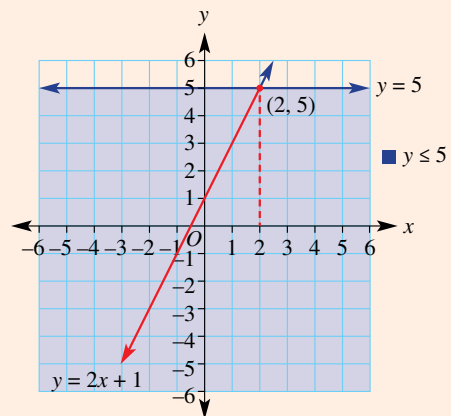



**BUILDING UNDERSTANDING**

- 1** This horizontal line has equation  $y = 4$ . Answer true or false to the following questions.
- a** All the points on the line have a  $y$ -coordinate of 4.
  - b** All the points on the line have an  $x$ -coordinate of 4.
  - c** The point  $(1, 3)$  is on the line.
  - d** The point  $(2, 4)$  is on the line.
  - e** When graphing the region  $y \leq 4$ , you would shade above the line.
  - f** When graphing the region  $y \leq 4$ , you would shade below the line.
  - g** When graphing the region  $y < 4$  or  $y > 4$ , a dashed line should be used.

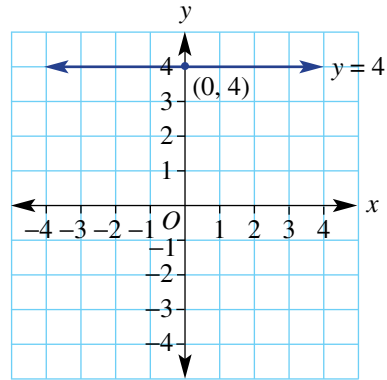

- 2** This vertical line has equation  $x = -2$ . Answer true or false to the following questions.
- a** All the points on the line have an  $x$ -coordinate of  $-2$ .
  - b** All the points on the line have a  $y$ -coordinate of  $-2$ .
  - c** The point  $(-2, 5)$  is on the line.
  - d** The point  $(-1, 3)$  is on the line.
  - e** When graphing the region  $x \leq -2$ , you would shade to the left of the line.
  - f** When graphing the region  $x \geq -2$ , you would shade to the right of the line.
  - g** When graphing the region  $x < -2$  or  $x > -2$ , a full line should be used.

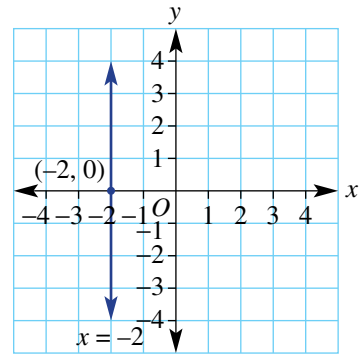

- 3** This graph shows the graph of the equation  $y = -x + 2$  and the region  $y \geq -1$ .
- a** True or false? The position of all the points that are on both the line  $y = -x + 2$  and in the region  $x \geq -1$  are shown in red.
  - b** Describe all the possible  $x$  coordinates of the points outlined in part **a**.
  - c** The values of  $x$  outlined in part **b** are the solution to the inequality  $-x + 2 \geq -1$ . Write this solution using an inequality symbol.

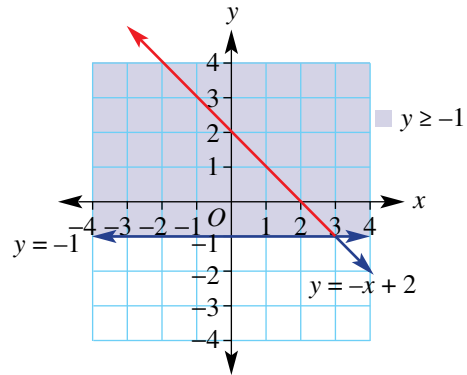



**Example 8 Finding rules for horizontal and vertical lines**

Write the rule for these horizontal and vertical lines.

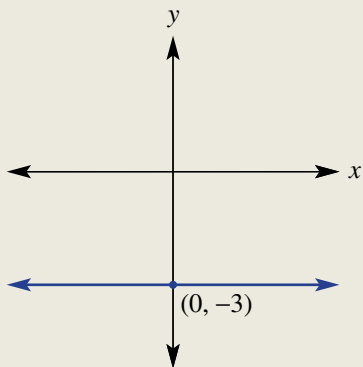
**a**

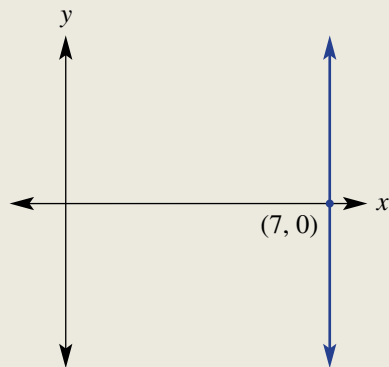

**b**



**SOLUTION**

**a**  $y = -3$

**b**  $x = 7$

**EXPLANATION**

All points on the line have a  $y$ -value of  $-3$ .

Vertical lines take the form  $x = k$ . Every point on the line has an  $x$ -value of  $7$ .

**Now you try**

Write the rule for these horizontal and vertical lines.

**a**

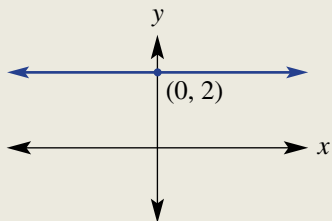

**b**

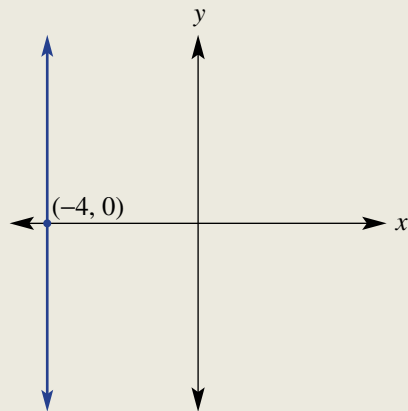



### Example 9 Sketching regions in the plane

Sketch the following regions.

**a**  $y \geq -2$

**b**  $x < 5$

#### SOLUTION

**a**

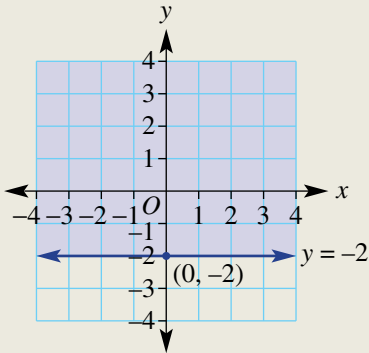

#### EXPLANATION

First, sketch  $y = -2$  using a full line and shade above the line since the  $\geq$  (greater than or equal to) symbol is used.

All the points on or above the line  $y = -2$  satisfy  $y \geq -2$ .

**b**

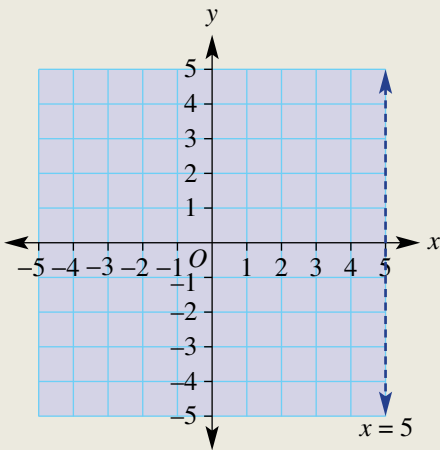

First, sketch  $x = 5$  using a dashed line and shade to the left of the line since the  $<$  (less than) symbol is used.

All the points left of the line  $x = 5$  satisfy  $x < 5$ .

#### Now you try

Sketch the following regions.

**a**  $y < 1$

**b**  $x \geq -4$



### Example 10 Solving inequalities using graphs

Solve the following inequalities using the given graphs.

**a**  $3x - 1 \leq 2$

**b**  $-x + 1 > 3$

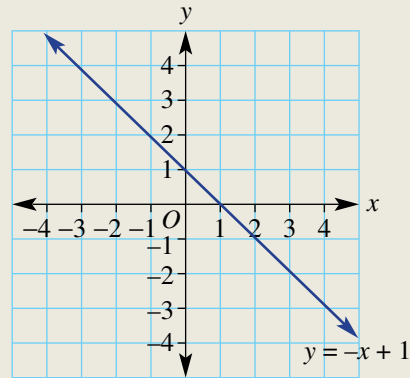
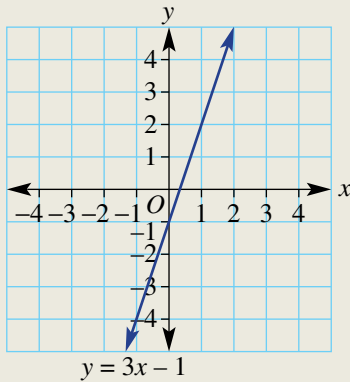

#### SOLUTION

**a**

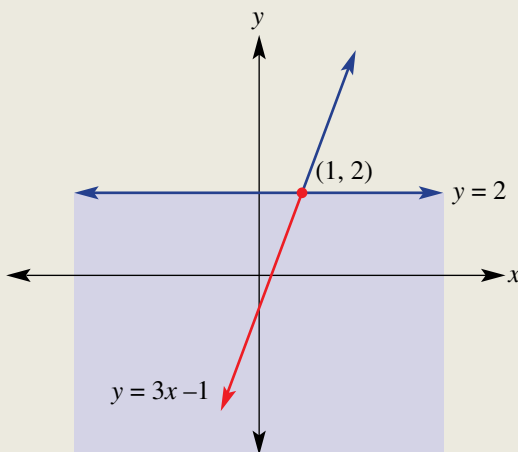

The solution is  $x \leq 1$ .

**b**

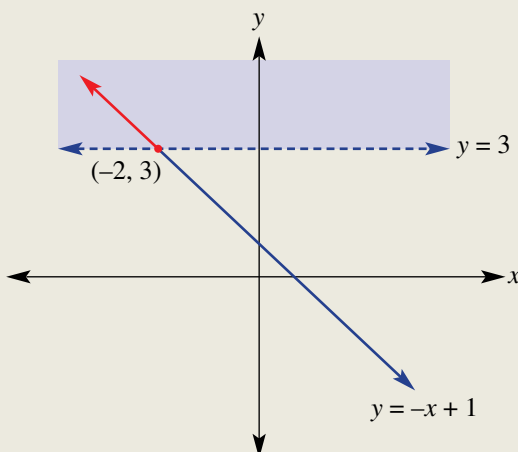

The solution is  $x < -2$ .

#### EXPLANATION

Sketch the region  $y \leq 2$  on the graph.

The solution to  $3x - 1 \leq 2$  will be all the  $x$  values of the points that are both on the line  $y = 3x - 1$  and in the region  $y \leq 2$ .

These points are highlighted in red where  $x \leq 1$ .

Sketch the region  $y > 3$  on the graph.

The solution to  $-x + 1 > 3$  will be all the  $x$  values of the points that are both on the line  $y = -x + 1$  and in the region  $y > 3$ .

These points are highlighted in red where  $x < -2$ .

**Now you try**

Solve the following inequalities using the given graphs.

**a**  $2x - 3 \geq 1$

**b**  $-x - 2 < 2$

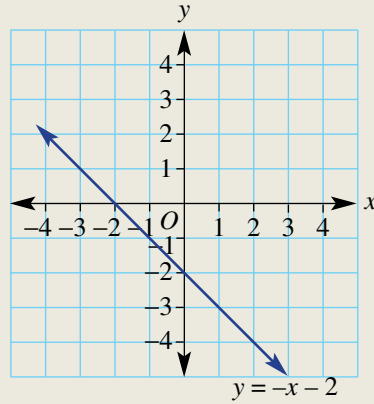
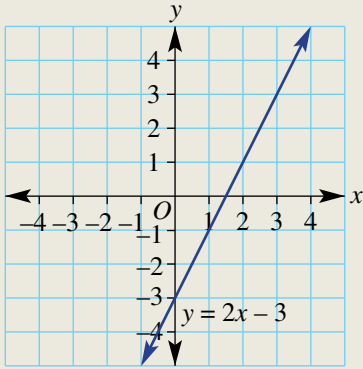

**Exercise 9E**

**FLUENCY**

1-4( $\frac{1}{2}$ ), 5, 6( $\frac{1}{2}$ )

1-4( $\frac{1}{2}$ ), 5, 6-7( $\frac{1}{2}$ )

2-4( $\frac{1}{2}$ ), 6-7( $\frac{1}{2}$ )

Example 8

1 Write the rule for these horizontal and vertical lines.

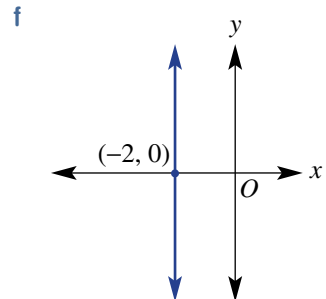
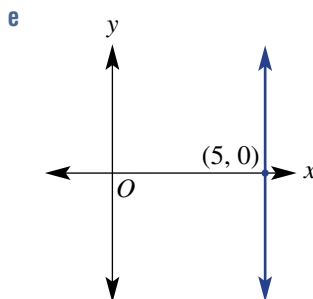
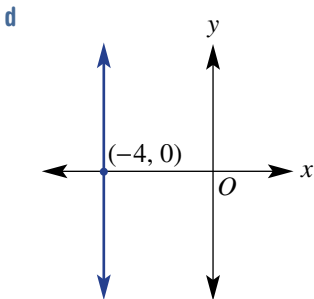
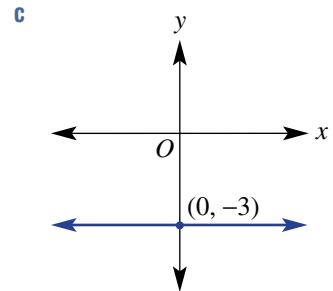
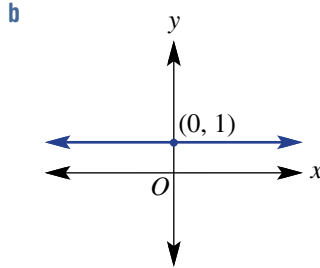
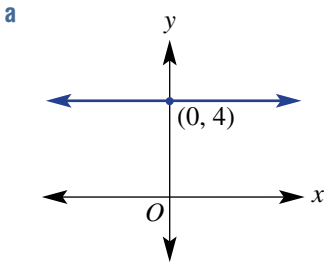

2 Sketch horizontal or vertical graphs for these rules.

a  $y = 2$

b  $y = -1$

c  $y = -4$

d  $y = 5$

e  $x = -3$

f  $x = 4$

g  $x = 1$

h  $x = -1$

Example 9

3 Sketch the following regions.

a  $y \geq 1$

b  $y > -2$

c  $y < 3$

d  $y \leq -4$

e  $x < 2$

f  $x \leq -4$

g  $x \geq 2$

h  $x > -1$

4 Write the inequalities matching these regions.

a

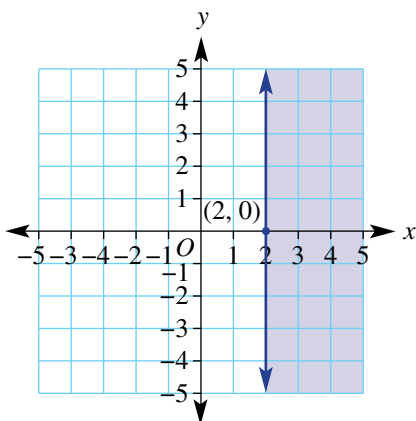

b

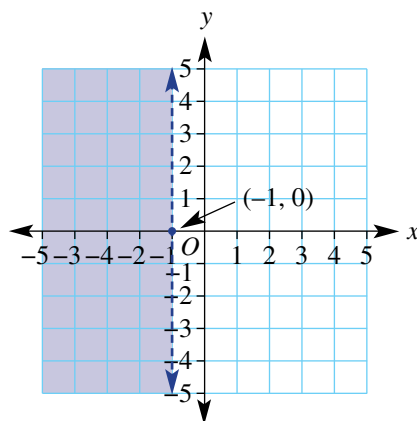

c

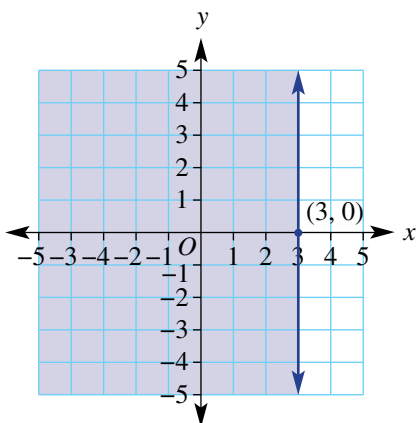

d

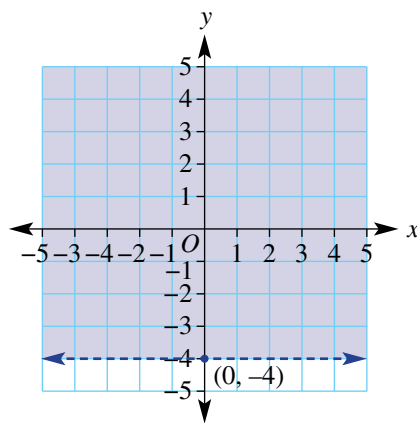

e

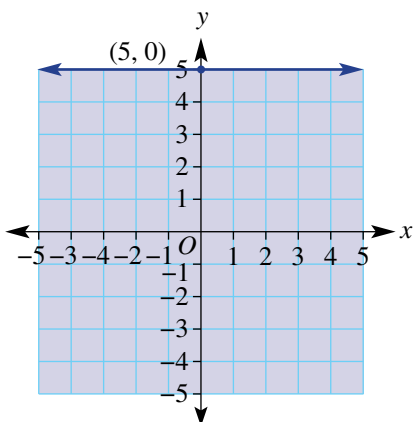

f

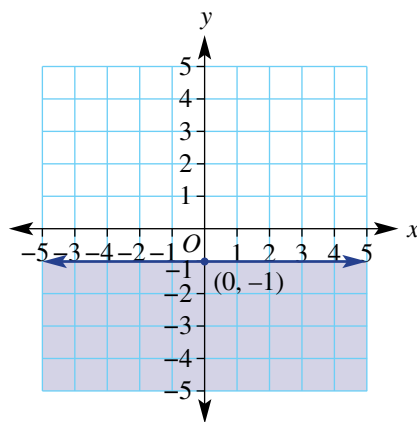

5 By locating the intersection of the given graphs, state the solution to the following equations.

a  $x + 2 = 3$

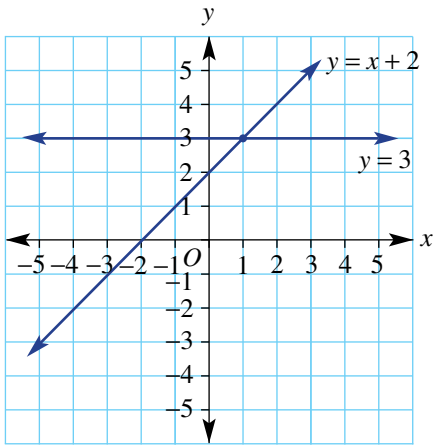

b  $-2x + 1 = 1$

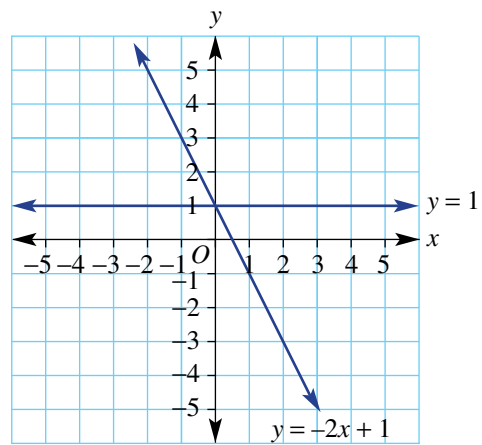

Example 10a

6 Solve the following inequalities using the given graphs.

a  $2x + 1 \leq 5$

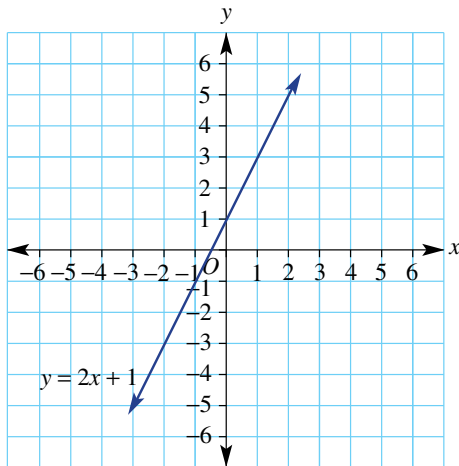

b  $x + 2 \leq 3$

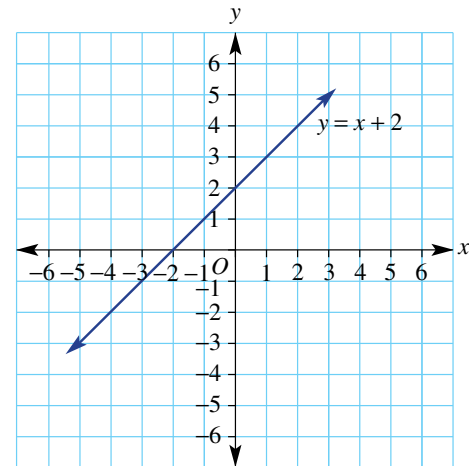

c  $x - 1 \geq 4$

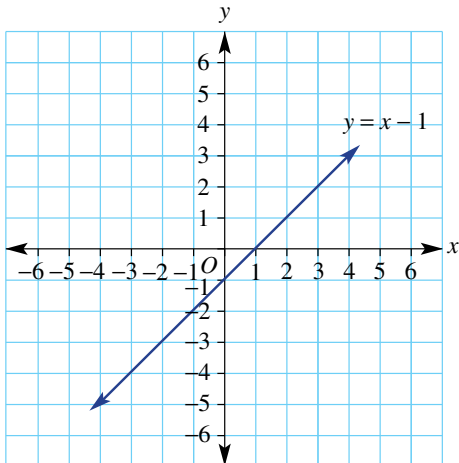

d  $3x - 2 > 4$

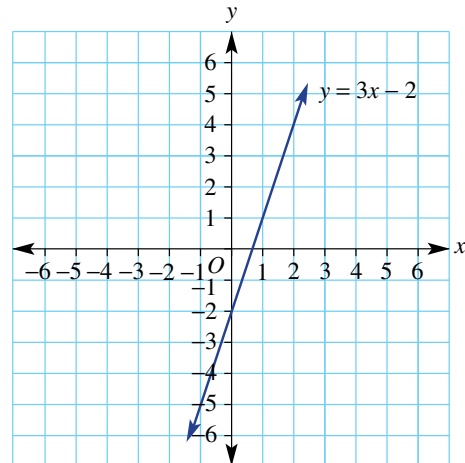

e  $2x - 3 < -1$

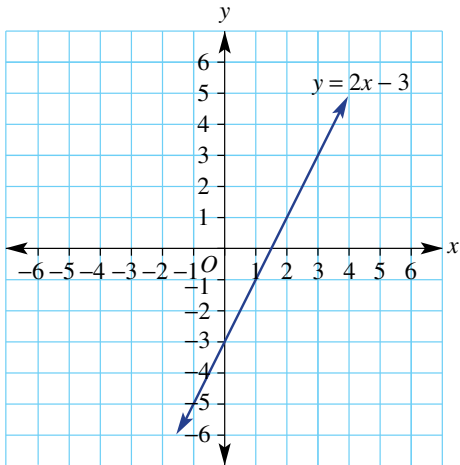

f  $4x + 1 > -3$

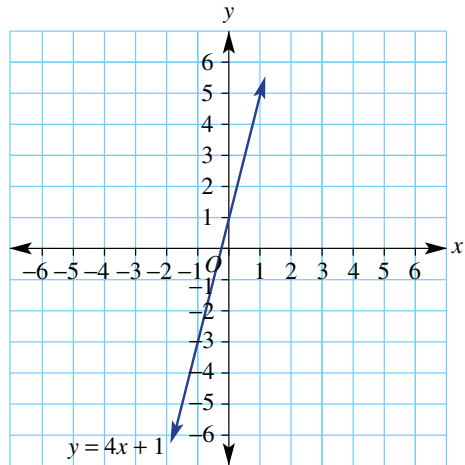

Example 10b

7 Solve the following inequalities using the given graphs.

a  $-x + 2 \geq 1$

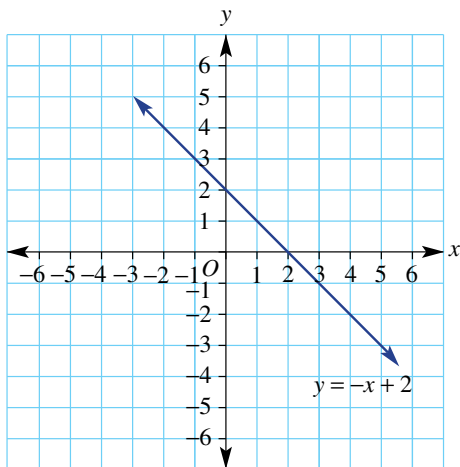

b  $-2x - 1 \leq 3$

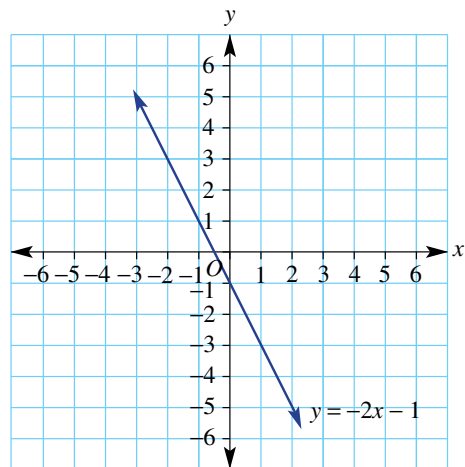



c  $-3x + 2 \geq 5$

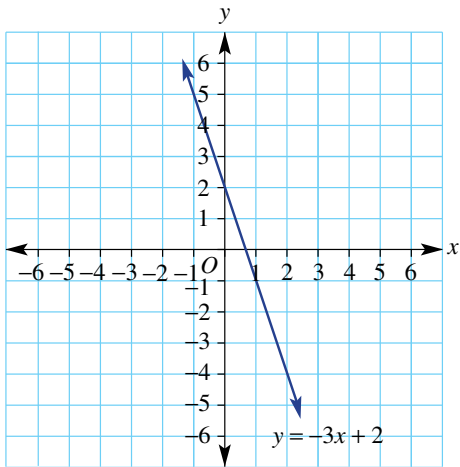

d  $-x - 2 > -3$

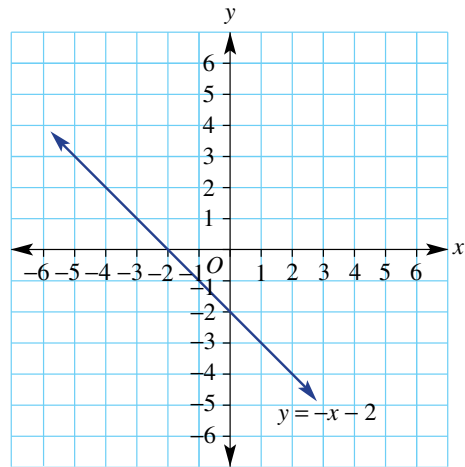

e  $-3x + 2 < -4$

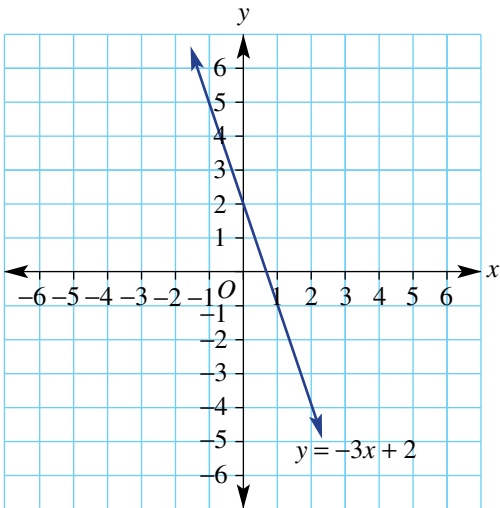

f  $-2x + 5 < 1$

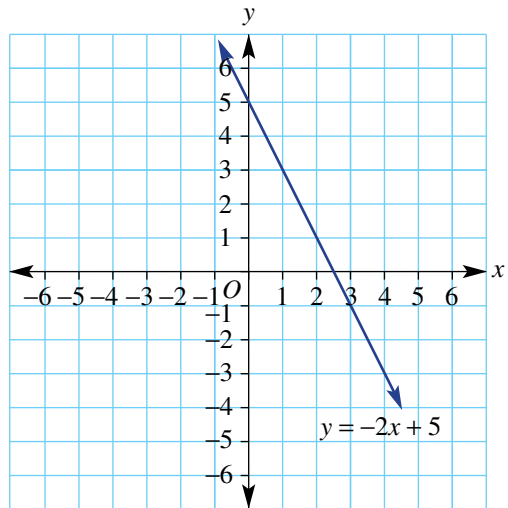

**PROBLEM SOLVING**

8, 9

8–10

9–11

8 Match the equations a–f with the graphs A–F.

- a  $x > 4$
- c  $x = 1$
- e  $y = -2$

- b  $y \leq 3$
- d  $x = -5$
- f  $y > -2$

**A**

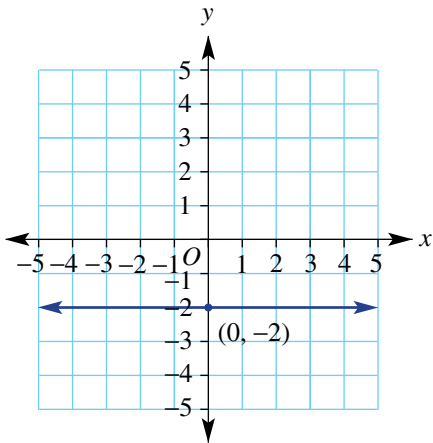

**B**

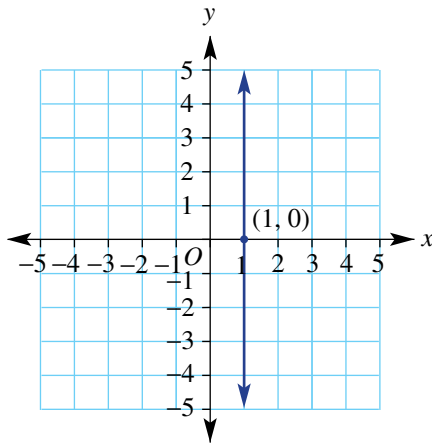

**C**

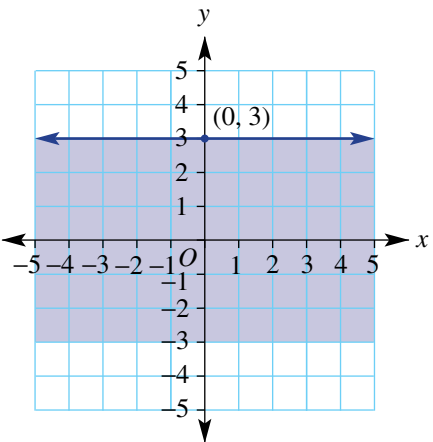

**D**

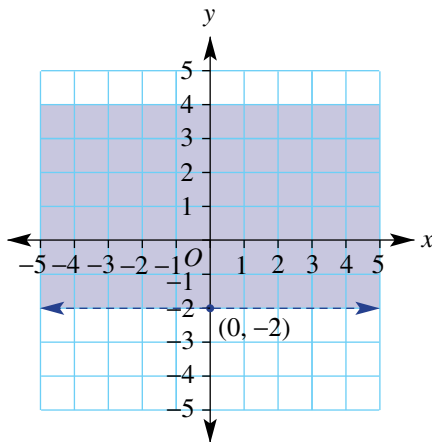

**E**

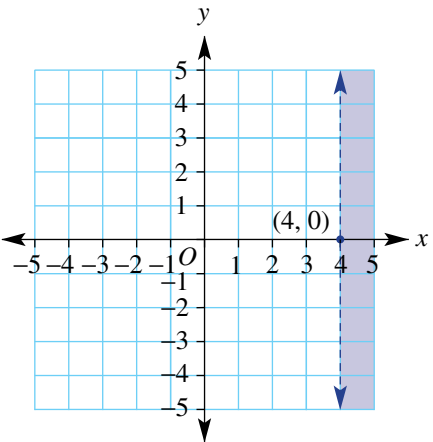

**F**

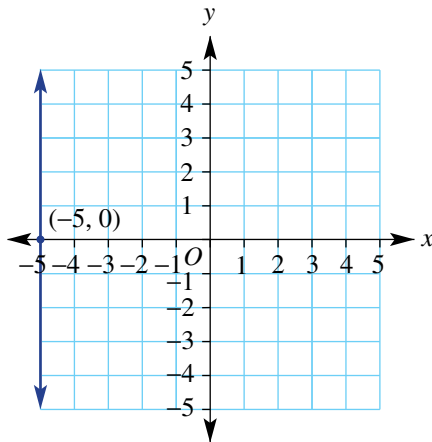

9 This diagram shows the graph of  $y = -2x + 3$ . Use the graph to solve the following equations and inequalities.

- a  $-2x + 3 = 5$
- b  $-2x + 3 = -1$
- c  $-2x + 3 = 0$
- d  $-2x + 3 < 0$
- e  $-2x + 3 \geq 0$
- f  $-2x + 3 \geq 1$

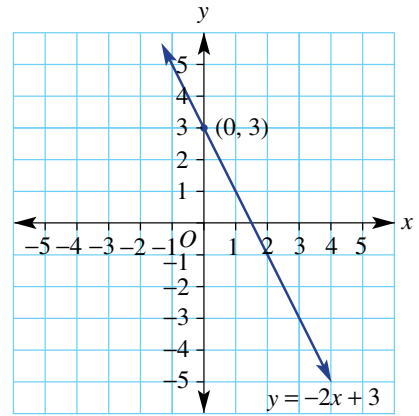

10 Decide if the point (1, 4) is on the given line or within the given region.

- a  $y = 4$
- b  $y > 4$
- c  $x = -1$
- d  $x = 1$
- e  $x = 4$
- f  $x \leq 1$
- g  $x > 1$
- h  $y \leq 4$
- i  $y < 1$
- j  $y < 6$
- k  $x > -2$
- l  $y \geq -7$

11 Find the rectangular area enclosed by these sets of lines.

- a  $x = 4, x = 1, y = 2, y = 7$
- b  $x = 5, x = -3, y = 0, y = 5$

**REASONING**

12

12,13

13,14

- 12 a Explain why the rule for the  $x$ -axis is given by  $y = 0$ .
- b Explain why the rule for the  $y$ -axis is given by  $x = 0$ .
- 13 To solve  $2x + 4 \geq 0$  using the graph of  $y = 2x + 4$  on the right, we would choose all the  $x$  values of the points on the line  $y = 2x + 4$  that are also in the region  $y \geq 0$ , highlighted in red here. So  $x \geq -2$  is the solution.

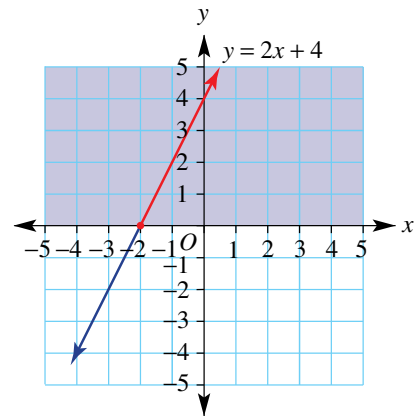

Use the given graphs to solve the following inequalities.

a  $x - 2 \geq 0$

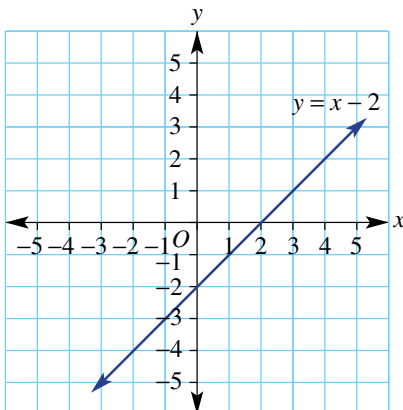

b  $-2x + 3 > 0$

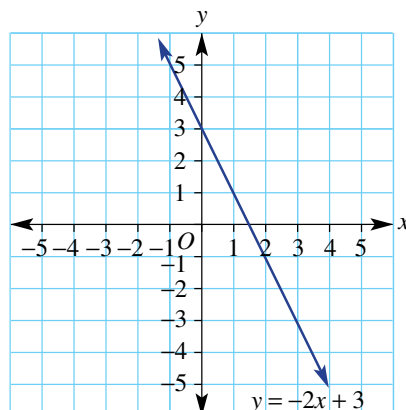

- 14 The given rectangular region could be described as all the points in common with the four inequalities:  $x \geq 1$ ,  $x \leq 4$ ,  $y \geq 1$  and  $y \leq 5$ .

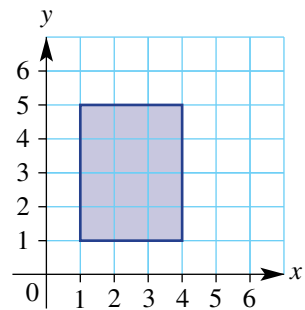

Give the four inequalities that describe the following rectangles.

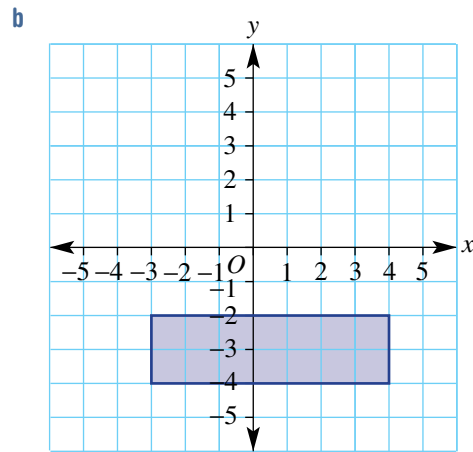
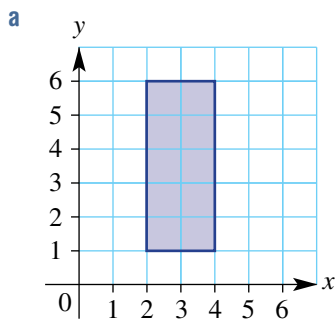

### ENRICHMENT: Half planes

15

- 15 We have seen that  $x \geq 2$  describes a region (half plane) including all the points to the right of and on the line  $x = 2$ . Half planes can also be formed using lines that are not horizontal or vertical. This graph, for example, shows the region  $y \geq x$ . You can see that for any point in the region, like  $(-1, 3)$  for example, the  $y$ -coordinate is greater than the  $x$ -coordinate.

Sketch the following regions.

- a**  $y \leq x$
- b**  $y > x$
- c**  $y > -x$
- d**  $y \leq 2x$
- e**  $y > -2x$
- f**  $y \leq x + 1$

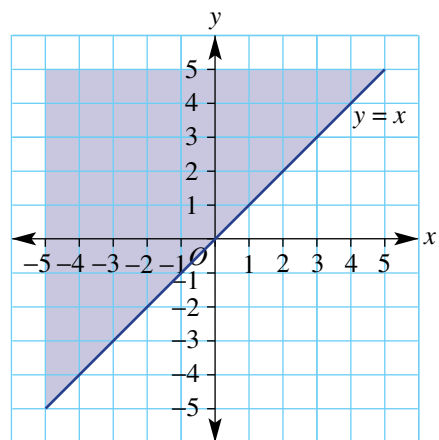

## 9F The $x$ - and $y$ -intercepts

### LEARNING INTENTIONS

- To understand that the  $x$ -intercept is the point on the graph where the  $y$ -coordinate is zero
- To understand that the  $y$ -intercept is the point on the graph where the  $x$ -coordinate is zero
- To be able to find the  $x$ -intercept of a rule by solving an equation
- To be able to find the  $y$ -intercept of a rule by substituting  $x = 0$
- To be able to sketch linear graphs by first finding the axes intercepts

We know that the  $y$ -intercept marks the point where a line cuts the  $y$ -axis. This is also the value of  $y$  for the rule where  $x = 0$ . Similarly, the  $x$ -intercept marks the point where  $y = 0$ . This can be viewed in a table of values or found using the algebraic method.

$x$ -intercept at  $(-2, 0)$   
 where  $y = 0$

$x$	-3	-2	-1	0	1	2
$y$	-1	0	1	2	3	4

$y$ -intercept at  $(0, 2)$   
 where  $x = 0$

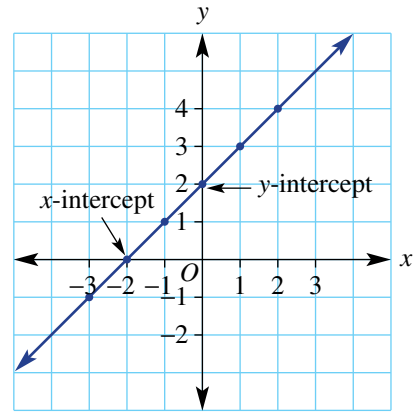

### Lesson starter: Discover the method

These rules all give graphs that have  $x$ -intercepts at which  $y = 0$ .

**A**  $y = 2x - 2$      
 **B**  $y = x - 5$      
 **C**  $y = 3x - 9$      
 **D**  $y = 4x + 3$

- First, try to guess the  $x$ -intercept by a trial and error (guess and check) method. Start by asking what value of  $x$  makes  $y = 0$ .
- Discuss why the rule for D is more difficult to work with than the others.
- Can you describe an algebraic method that will give the  $x$ -intercept for any rule? How would you show your working for such a method?



## KEY IDEAS

- The **y-intercept** is the point on a graph where  $x = 0$ .

For example:

$$y = 2x + 4$$

$$y = 2 \times 0 + 4$$

$$y = 4$$

$$\therefore \text{y-intercept is } (0, 4)$$

- The **x-intercept** is the point on a graph where  $y = 0$ .

Find the  $x$ -intercept by substituting  $y = 0$  into the rule.

Solve using algebraic steps. For example:

$$y = 2x + 4$$

$$0 = 2x + 4$$

$$-4 = 2x$$

$$-2 = x$$

$$\therefore \text{x-intercept is } (-2, 0)$$

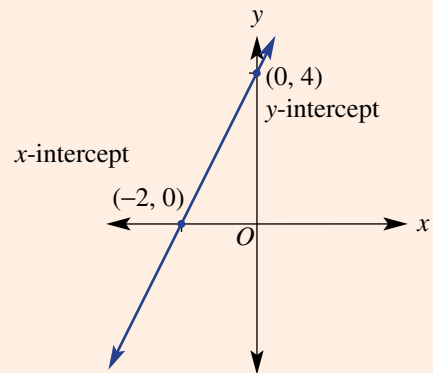

## BUILDING UNDERSTANDING

- 1 Look at these graphs and state the  $x$ - and  $y$ -intercepts.

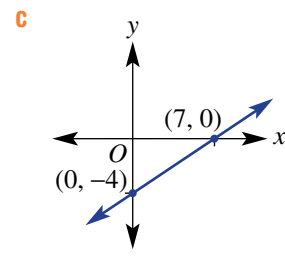
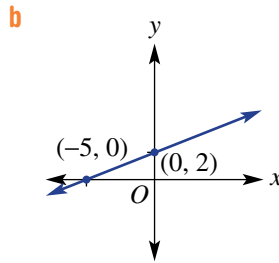
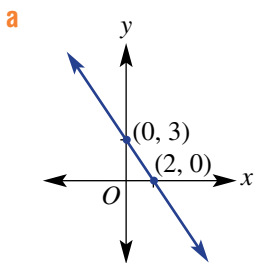

- 2 For each of these tables, state the  $x$ - and  $y$ -intercepts.

**a**

$x$	-2	-1	0	1	2
$y$	2	0	-2	-4	-6

**b**

$x$	0	1	2	3	4
$y$	4	3	2	1	0

- 3 Solve each of these equations for  $x$ .

**a**  $0 = x - 4$

**b**  $0 = x + 2$

**c**  $0 = 2x + 10$

**d**  $0 = 3x - 12$

**e**  $0 = 3x + 1$

**f**  $0 = -2x - 4$



### Example 11 Finding the $x$ - and $y$ -intercepts

For the graphs of these rules, find the  $x$ - and  $y$ -intercepts.

**a**  $y = 3x - 6$

**b**  $y = -2x + 1$

#### SOLUTION

**a**  $y = 3x - 6$

$y$ -intercept ( $x = 0$ )

$$y = 3(0) - 6$$

$$= -6$$

$$\therefore (0, -6)$$

$x$ -intercept ( $y = 0$ )

$$0 = 3x - 6$$

$$6 = 3x$$

$$2 = x$$

$$\therefore (2, 0)$$

**b**  $y = -2x + 1$

$y$ -intercept ( $x = 0$ )

$$y = -2(0) + 1$$

$$= 1$$

$$\therefore (0, 1)$$

$x$ -intercept ( $y = 0$ )

$$0 = -2x + 1$$

$$-1 = -2x$$

$$\frac{1}{2} = x$$

$$\therefore \left(\frac{1}{2}, 0\right)$$

#### EXPLANATION

Substitute  $x = 0$  into the rule.

Simplify.

Write the point's coordinates  $x = 0$  and  $y = -6$ .

Substitute  $y = 0$  into the rule.

Add 6 to both sides.

Divide both sides by 3.

Write the point's coordinates  $x = 2$  and  $y = 0$ .

Substitute  $x = 0$  into the rule.

Simplify.

Write the point's coordinates  $x = 0$  and  $y = 1$ .

Substitute  $y = 0$  into the rule.

Subtract 1 from both sides.

Divide both sides by  $-2$ .

Write the point's coordinates  $x = \frac{1}{2}$  and  $y = 0$ .

#### Now you try

For the graphs of these rules, find the  $x$ - and  $y$ -intercepts.

**a**  $y = 2x - 10$

**b**  $y = -5x + 2$



### Example 12 Sketching with intercepts

Find the  $x$ - and  $y$ -intercepts and then sketch the graph of the rule  $y = 2x - 8$ .

#### SOLUTION

$$y = 2x - 8$$

$$x\text{-intercept (y = 0)}$$

$$+8 \begin{matrix} \curvearrowleft \\ \curvearrowright \end{matrix} 0 = 2x - 8 \begin{matrix} \curvearrowright \\ \curvearrowleft \end{matrix} +8$$

$$+2 \begin{matrix} \curvearrowleft \\ \curvearrowright \end{matrix} 8 = 2x \begin{matrix} \curvearrowright \\ \curvearrowleft \end{matrix} +2$$

$$4 = x$$

$\therefore x$ -intercept is  $(4, 0)$

$$y\text{-intercept (x = 0)}$$

$$y = 2(0) - 8$$

$$y = -8$$

$\therefore y$ -intercept is  $(0, -8)$

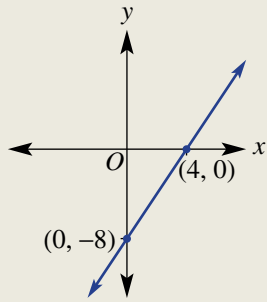

#### EXPLANATION

Substitute  $y = 0$  into the rule.

Add 8 to both sides.

Divide both sides by 2.

The  $y$ -intercept is found by substituting  $x = 0$  to get  $y = -8$ .

Sketch by showing the  $x$ - and  $y$ -intercepts.  
There is no need to show a grid.

### Now you try

Find the  $x$ - and  $y$ -intercepts and then sketch the graph of the rule  $y = 3x + 6$ .

## Exercise 9F

### FLUENCY

1, 2(1/2), 4, 5(1/2)

2-3(1/2), 4, 5(1/2)

2-3(1/3), 4, 5(1/3)

- |                   |   |
|-------------------|---|
| <b>Example 11</b> | <b>1</b> For the graph of $y = 5x - 15$ , find the:<br><b>a</b> $x$ -intercept <b>b</b> $y$ -intercept.   |
| <b>Example 11</b> | <b>2</b> For the graphs of these rules, find the $x$ - and $y$ -intercepts.<br><b>a</b> $y = x - 1$ <b>b</b> $y = x - 6$ <b>c</b> $y = x + 2$<br><b>d</b> $y = 2x - 8$ <b>e</b> $y = 4x - 12$ <b>f</b> $y = 3x + 6$   |
| <b>Example 11</b> | <b>3</b> Find the $x$ - and $y$ -intercepts for the following rules. Note that some coordinates will involve fractions.<br><b>a</b> $y = 2x - 5$ <b>b</b> $y = 3x - 7$ <b>c</b> $y = -2x + 4$<br><b>d</b> $y = -4x + 8$ <b>e</b> $y = -4x + 6$ <b>f</b> $y = -3x - 8$ |
| <b>Example 12</b> | <b>4</b> The rule $y = 2x + 6$ has an $x$ -intercept at $(-3, 0)$ and a $y$ -intercept at $(0, 6)$ . Sketch the graph of $y = 2x + 6$ .   |



Example 12

5 Find the  $x$ - and  $y$ -intercepts and then sketch the graphs of these rules.

a  $y = x + 1$

b  $y = x - 4$

c  $y = 2x - 10$

d  $y = 3x + 9$

e  $y = -2x - 4$

f  $y = -4x + 8$

g  $y = -x + 3$

h  $y = -x - 5$

i  $y = -3x - 15$

## PROBLEM-SOLVING

6-8

6-9

8-11

6 Find the area of the triangle enclosed by the  $x$ -axis, the  $y$ -axis and the given line. You will first need to find the  $x$ - and  $y$ -intercepts.

a  $y = 2x + 4$

b  $y = 3x - 3$

c  $y = -x + 5$

d  $y = -4x - 8$

7 Consider the rule  $y = 2x + 5$ .a Find the  $y$ -intercept.b Give an example of two other rules with the same  $y$ -intercept.8 Consider the rule  $y = 3x - 6$ .a Find the  $x$ -intercept.b Give an example of two other rules with the same  $x$ -intercept.9 A straight line graph passes through the points  $(2, 8)$  and  $(3, 10)$ . Find its  $x$ -intercept and its  $y$ -intercept.10 The height of water ( $H$  cm) in a tub is given by  $H = -2t + 20$ , where  $t$  is the time in seconds.a Find the height of water initially (i.e. at  $t = 0$ ).

b How long will it take for the tub to empty?

11 The amount of credit ( $C$  cents) on a phone card is given by the rule  $C = -t + 200$ , where  $t$  is time in seconds.a How much credit is on the card initially ( $t = 0$ )?

b For how long can you use the phone card before the money runs out?

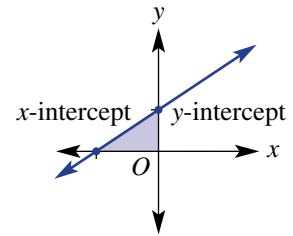

## REASONING

12

12, 13

13-15

12 Some lines have no  $x$ -intercept. What type of lines are they? Give two examples.13 Some lines have the  $x$ -intercept and  $y$ -intercept at the same point.a Show that this occurs for the rule  $y = 8x$ .

b Give an example of another rule where this occurs.

14 Write an expression for the  $x$ -intercept if  $y = mx + c$ . Your answer will include the pronumerals  $m$  and  $c$ .15 Use graphing software to describe the effect on the  $y$ -intercept and  $x$ -intercept when putting different numbers into the gap in  $y = 2x + \square$ ENRICHMENT: Using  $ax + by = d$ 

-

-

16( $\frac{1}{2}$ )16 The  $x$ -intercept can be found if the rule for the graph is given in any form. Substituting  $y = 0$  starts the process whatever the form of the rule. Find the  $x$ -intercept for the graphs of these rules.

a  $x + y = 6$

b  $3x - 2y = 12$

c  $y - 2x = 4$

d  $2y - 3x = -9$

e  $y - 3x = 2$

f  $3y + 4x = 6$

g  $5x - 4y = -10$

h  $2x + 3y = 3$

i  $y - 3x = -1$

9A

- 1 State the coordinates of the points labelled A to G.

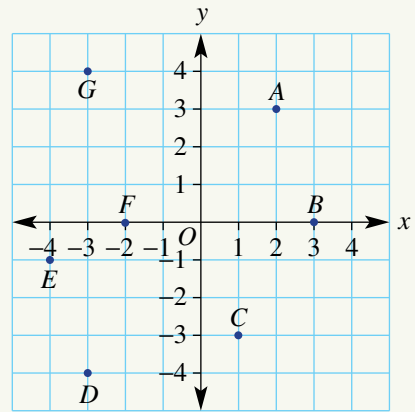

9B

- 2 For  $x$ -coordinates from  $-2$  to  $2$ , construct a table and draw a graph for the rule  $y = 2x + 1$ .

9B

- 3 Decide if the given points lie on the graph with the given rule.

a Rule:  $y = 3x$  Points: i (2, 6) ii (4, 7)

b Rule:  $y = 4 - x$  Points: i (5, 1) ii (-2, 6)

9C

- 4 Find the rule for these tables of values.

a

$x$	-2	-1	0	1	2
$y$	-7	-4	-1	2	5

b

$x$	2	3	4	5	6
$y$	-2	-4	-6	-8	-10

9C

- 5 Find the rule for this graph by first constructing a table of  $(x, y)$  values.

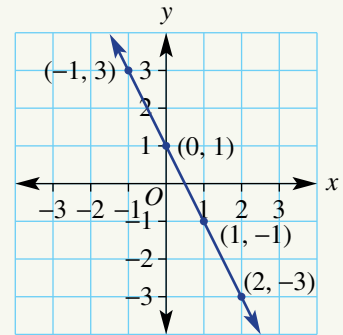

9D

- 6 Use the graph of  $y = 3x - 2$ , shown here, to solve the following equations.

a  $3x - 2 = 1$

b  $3x - 2 = -5$

c  $3x - 2 = -2$

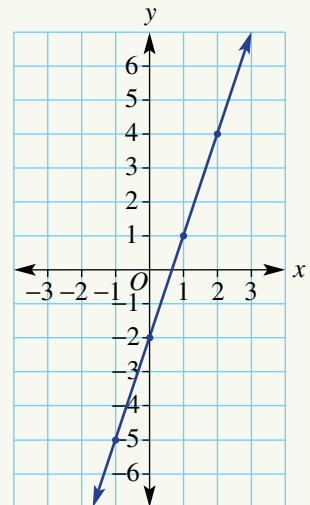

9D

7 Use the graphs of  $y = 2 - x$  and  $y = 2x + 5$ , shown here, to answer these questions.

- a Write the coordinates of four points  $(x, y)$  for the equation:
  - i  $y = 2 - x$
  - ii  $y = 2x + 5$
- b Write the coordinates of the intersection point and show that it satisfies both line equations.
- c Solve the equation  $2 - x = 2x + 5$ .

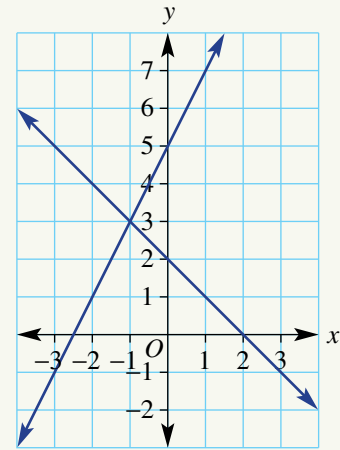

9E

8 Sketch the following regions.

- a  $y \leq 3$
- b  $x > -2$

9E

9 Solve the following using the given graphs.

- a  $2x + 1 > -1$
- b  $-x - 1 \leq 3$

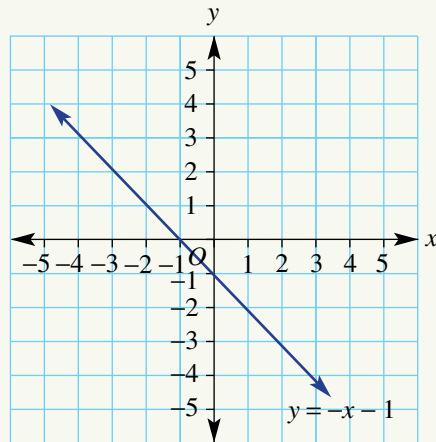
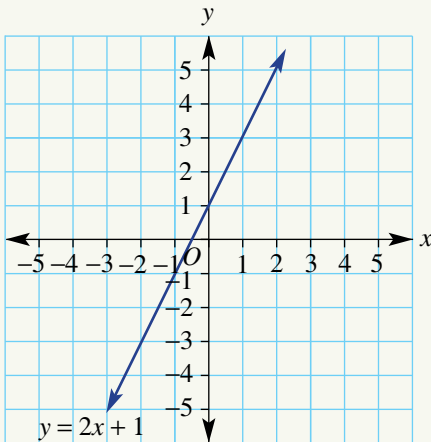

9F

10 For the graphs of these rules, find the  $x$ -intercept.

- a  $y = 4x - 12$
- b  $y = -3x + 1$

9F

11 Find the  $x$ - and  $y$ -intercepts and then sketch the graphs of the following rules.

- a  $y = 2x - 6$
- b  $y = -x + 4$

9F

12 The depth of water ( $d$  cm) in a leaking container is given by  $d = 30 - 2t$ , where  $t$  is in seconds.

- a Find the depth of water initially ( $t = 0$ ).
- b Find how long it takes for the container to empty.

## 9G Gradient EXTENDING

### LEARNING INTENTIONS

- To understand that gradient is a number measuring the slope of a line
- To understand that gradient can be positive, negative, zero or undefined
- To be able to find the gradient of a straight line

The gradient of a line is a measure of how steep the line is. The steepness or slope of a line depends on how far it rises or falls over a given horizontal distance. This is why the gradient is calculated by dividing the vertical rise by the horizontal run between two points. Lines that rise (from left to right) have a positive gradient and lines that fall (from left to right) have a negative gradient.

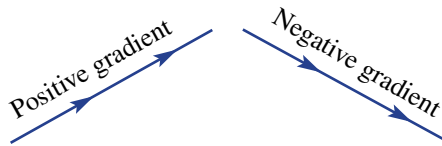

Engineers use gradients to measure the steepness of roller-coaster tracks.

### Lesson starter: Which is the steepest?

At a children's indoor climbing centre there are three types of sloping walls to climb. The blue wall rises 2 metres for each metre across. The red wall rises 3 metres for every 2 metres across and the yellow wall rises 7 metres for every 3 metres across.

- Draw a diagram showing the slope of each wall.
- Label your diagrams with the information given above.
- Discuss which wall might be the steepest, giving reasons.
- Discuss how it might be possible to accurately compare the slope of each wall.

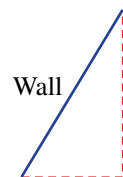

## KEY IDEAS

- The **gradient** is a measure of **slope**.
  - It is the increase in  $y$  as  $x$  increases by 1.
  - It is the ratio of the change in  $y$  over the change in  $x$ .

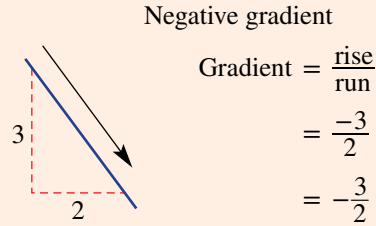
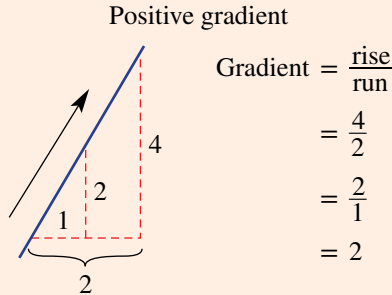

- **Gradient** =  $\frac{\text{rise}}{\text{run}}$
  - Rise = change in  $y$  as graph goes left to right (can be positive negative or zero)
  - Run = change in  $x$  as graph goes left to right (always positive)
- A gradient is negative if  $y$  decreases as  $x$  increases. The rise is considered to be negative.
  - The gradient of a horizontal line is 0. Gradient =  $\frac{0}{2} = 0$
  - The gradient of a vertical line is undefined. Gradient =  $\frac{2}{0}$  Which is undefined

## BUILDING UNDERSTANDING

- 1 Decide if these lines have a positive or negative gradient.

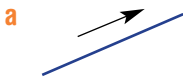

- 2 Simplify these fractions.

a  $\frac{4}{2}$

b  $\frac{6}{4}$

c  $-\frac{6}{3}$

d  $-\frac{16}{6}$

- 3 State the gradient, using  $\frac{\text{rise}}{\text{run}}$  for each of these slopes.

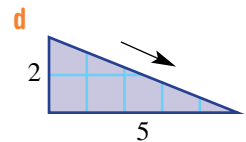
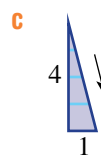
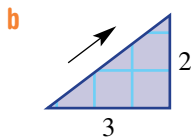
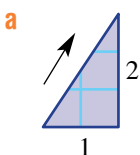



### Example 13 Defining a type of gradient

Decide if the lines labelled **a**, **b**, **c** and **d** on this graph have a positive, negative, zero or undefined gradient.

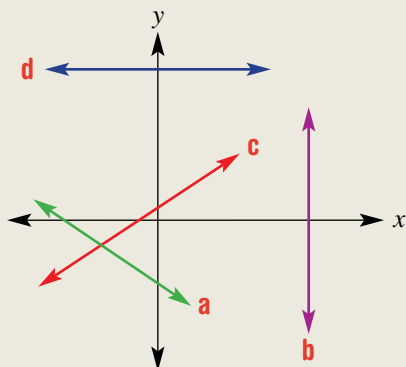

#### SOLUTION

- a** Negative gradient
- b** Undefined gradient
- c** Positive gradient
- d** Zero gradient

#### EXPLANATION

As  $x$  increases  $y$  decreases.

The line is vertical.

$y$  increases as  $x$  increases.

There is no increase or decrease in  $y$  as  $x$  increases.

#### Now you try

Decide if the lines labelled **a**, **b**, **c** and **d** on this graph have positive, negative, zero or undefined gradient.

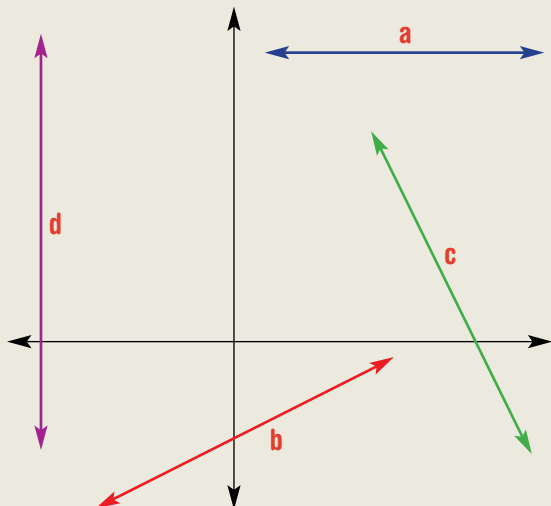



### Example 14 Finding the gradient from a graph

Find the gradient of these lines.

a

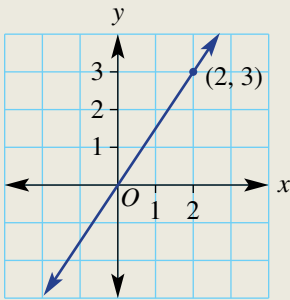

b

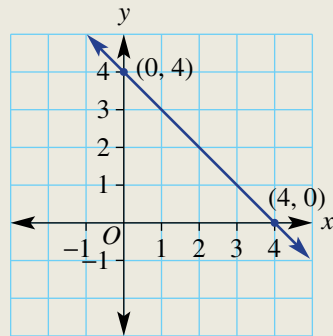

#### SOLUTION

$$\begin{aligned} \text{a Gradient} &= \frac{\text{rise}}{\text{run}} \\ &= \frac{3}{2} \text{ or } 1.5 \end{aligned}$$

$$\begin{aligned} \text{b Gradient} &= \frac{\text{rise}}{\text{run}} \\ &= \frac{-4}{4} \\ &= -1 \end{aligned}$$

#### EXPLANATION

The rise is 3 for every 2 across to the right.

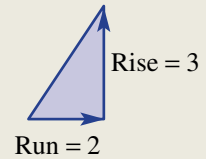

The y-value falls 4 units while the x-value increases by 4.

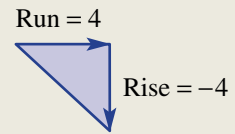

#### Now you try

Find the gradient of these lines.

a

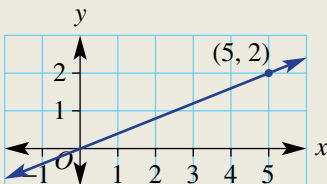

b

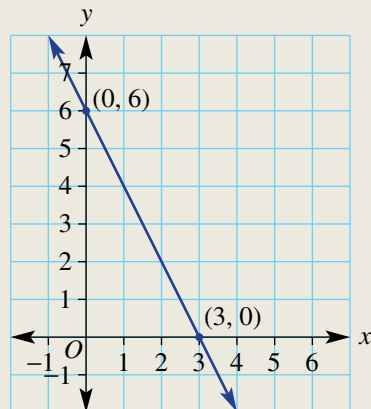

## Exercise 9G

## FLUENCY

1, 2, 3-4( $\frac{1}{2}$ )2, 3-4( $\frac{1}{2}$ )2, 3-4( $\frac{1}{3}$ )

Example 13

- 1 Decide if the lines labelled **a**, **b**, **c** and **d** on this graph have a positive, negative, zero or undefined gradient.

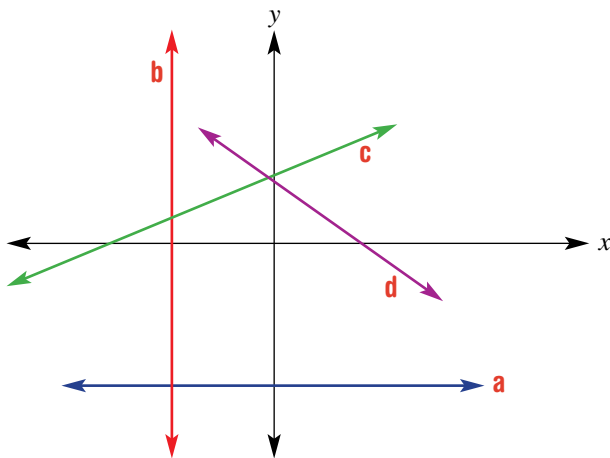

Example 13

- 2 Decide if the lines labelled **a**, **b**, **c** and **d** on this graph have a positive, negative, zero or undefined gradient.

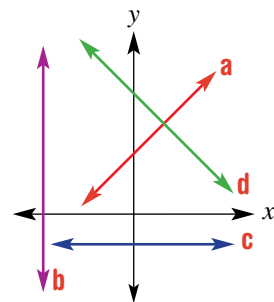

Example 14a

- 3 Find the gradient of these lines. Use gradient =  $\frac{\text{rise}}{\text{run}}$ .

a

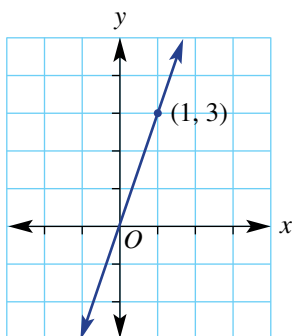

b

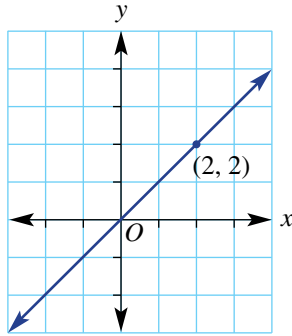

c

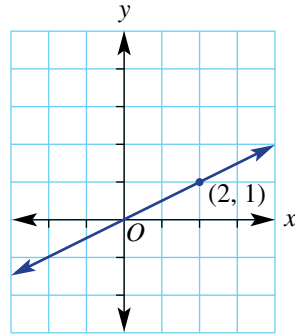



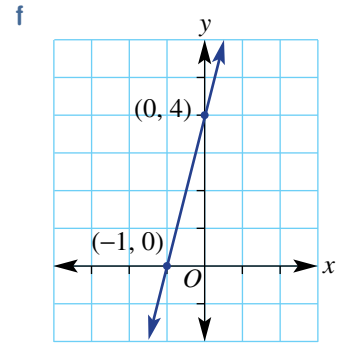
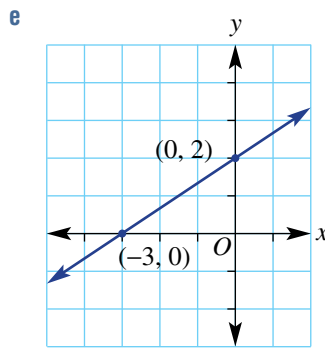
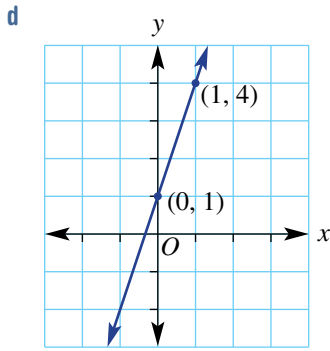

Example 14b

**4** Find the gradient of these lines.

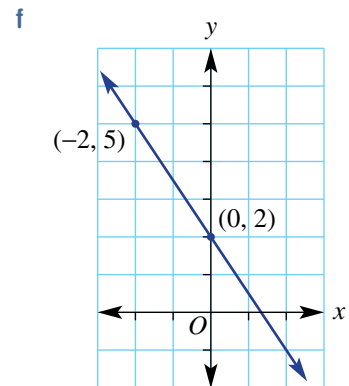
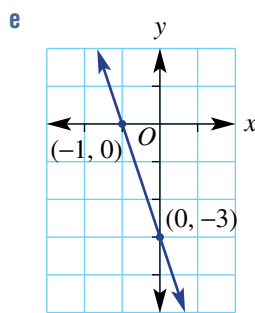
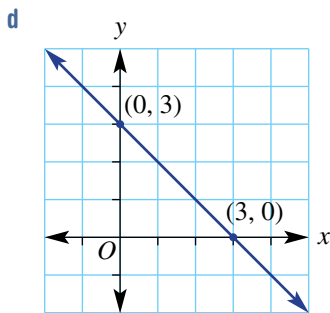
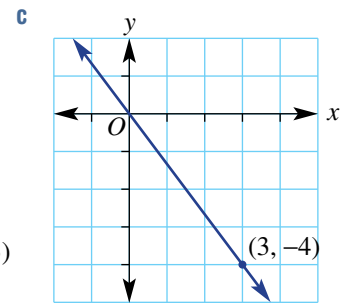
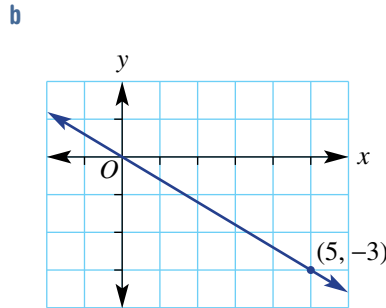
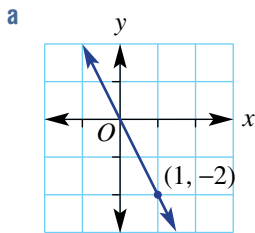

**PROBLEM-SOLVING**

5, 6

6, 7

6-8

- 5** Abdullah climbs a rocky slope that rises 12 m for each 6 metres across. His friend Jonathan climbs a nearby grassy slope that rises 25 m for each 12 m across. Which slope is steeper?
- 6** A submarine falls 200 m for each 40 m across and a torpedo falls 420 m for each 80 m across in pursuit of the submarine. Which has the steeper gradient, the submarine or torpedo?



7 Find the gradient of these lines. You will need to first calculate the rise and run.

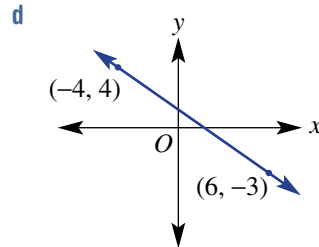
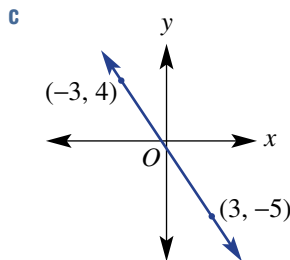
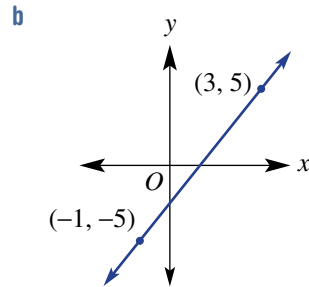
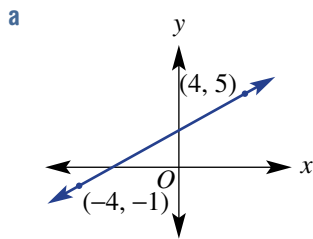

8 Find the gradient of the line joining these pairs of points.

- a  $(0, 2)$  and  $(2, 7)$
- b  $(0, -1)$  and  $(3, 4)$
- c  $(-3, 7)$  and  $(0, -1)$
- d  $(-5, 6)$  and  $(1, 2)$
- e  $(-2, -5)$  and  $(1, 3)$
- f  $(-5, 2)$  and  $(5, -1)$

### REASONING

9

9, 10

10–12

9 A line with gradient 3 joins  $(0, 0)$  with another point  $A$ .

- a Write the coordinates of three different positions for  $A$ , using positive integers for both the  $x$ - and  $y$ -coordinates.
- b Write the coordinates of three different positions for  $A$  using negative integers for both the  $x$ - and  $y$ -coordinates.

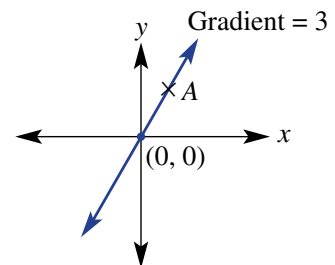

10 Use graphing software to look at graphs in the form  $y = \square x$

(e.g.  $y = 2x$ ,  $y = -11x$ ).

- a Give an example of a rule in this form whose graph has positive gradient.
- b Give an example of a rule in this form whose graph has negative gradient.
- c Describe how the coefficient of  $x$  affects the gradient of the graph.

11 A line joins the point  $(0, 0)$  with the point  $(a, b)$  with a gradient of 2.

- a If  $a = 1$ , find  $b$ .
- b If  $a = 5$ , find  $b$ .
- c Write an expression for  $b$  in terms of  $a$ .
- d Write an expression for  $a$  in terms of  $b$ .



# 9H Gradient–intercept form EXTENDING

### LEARNING INTENTIONS

- To be able to determine the gradient and  $y$ -intercept for the graph of a rule in the form  $y = mx + c$
- To be able to determine the rule for a graph where the  $y$ -intercept is visible and the gradient can be determined

From previous sections in this chapter, you may have noticed some connections between the numbers that make up a rule for a linear relationship and the numbers that are the gradient and  $y$ -coordinate with  $x = 0$  (the  $y$ -intercept). This is no coincidence. Once the gradient and  $y$ -intercept of a graph are known, the rule can be written down without further analysis.

### Lesson starter: What's the connection?

To explore the connection between the rule for a linear relationship and the numbers that are the gradient and the  $y$ -intercept, complete the missing details for the graph and table below.

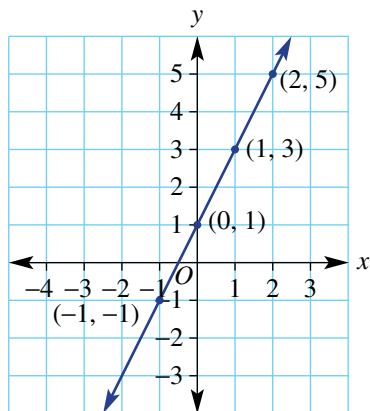

$x$	-1	0	1	2
$y$	-1	1		

+2

$y = \square \times x + \square$

Gradient =  $\frac{\text{rise}}{\text{run}}$   
 = \_\_\_\_\_  
 $y$ -intercept = \_\_\_\_\_

- What do you notice about the numbers in the rule including the coefficient of  $x$  and the constant (below the table) and the numbers for the gradient and  $y$ -intercept?
- Complete the details for this new example below to see if your observations are the same.

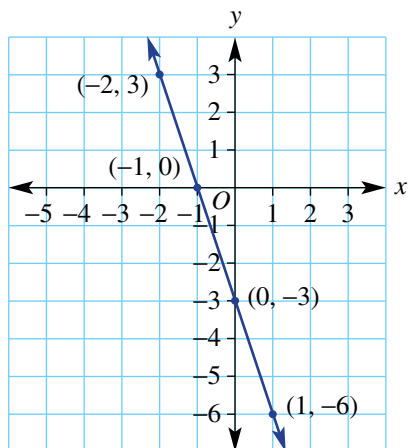

$x$	-2	-1	0	1
$y$				

$y = \square \times x + \square$

Gradient =  $\frac{\text{rise}}{\text{run}}$   
 = \_\_\_\_\_  
 $y$ -intercept = \_\_\_\_\_

## KEY IDEAS

■ The rule for a straight line graph is given by  $y = mx + c$  where:

- $m$  is the gradient
- $(0, c)$  is the  $y$ -intercept.

For example:

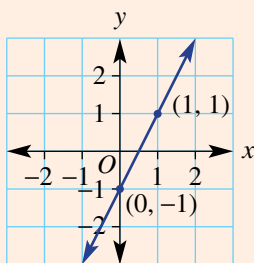

$$m = \frac{2}{1} = 2$$

$$c = -1$$

So  $y = mx + c$  becomes

$$y = 2x - 1$$

## BUILDING UNDERSTANDING

1 Substitute the given value of  $m$  and  $c$  into  $y = mx + c$  to find a rule.

a  $m = 2$  and  $c = 3$

b  $m = -3$  and  $c = 1$

c  $m = -5$  and  $c = -3$

2 For these graphs, state the  $y$ -intercept and find the gradient using  $\frac{\text{rise}}{\text{run}}$ .

a

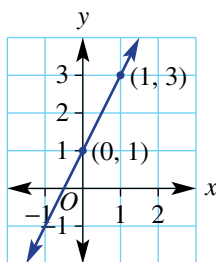

b

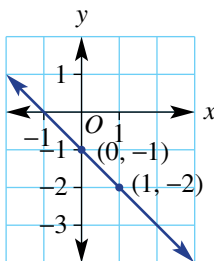

c

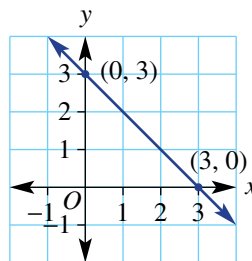

### Example 15 Stating the gradient and $y$ -intercept from a rule

State the gradient and  $y$ -intercept for the graphs of these rules.

a  $y = 2x + 3$

b  $y = \frac{1}{3}x - 4$

#### SOLUTION

a  $y = 2x + 3$   
 gradient = 2  
 $y$ -intercept is  $(0, 3)$

#### EXPLANATION

The coefficient of  $x$  is 2 and this number is the gradient.

The  $y$ -intercept is given by the constant 3, combined with  $x = 0$ .

*Continued on next page*

$$\text{b } y = \frac{1}{3}x - 4$$

$$\text{gradient} = \frac{1}{3}$$

y-intercept is  $(0, -4)$

The gradient ( $m$ ) is the coefficient of  $x$ .

Remember that  $y = \frac{1}{3}x - 4$  is the same as

$$y = \frac{1}{3}x + (-4) \text{ so the constant is } -4.$$

### Now you try

State the gradient and y-intercept for the graphs of these rules.

$$\text{a } y = 5x + 2$$

$$\text{b } y = \frac{2}{7}x - 5$$



### Example 16 Finding a rule from a graph

Find the rule for these graphs by first finding the values of  $m$  and  $c$ .

a

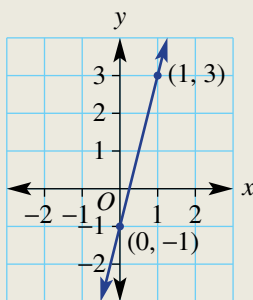

b

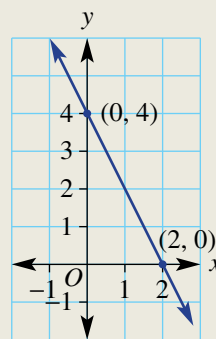

### SOLUTION

$$\text{a } m = \frac{\text{rise}}{\text{run}}$$

$$= \frac{4}{1}$$

$$= 4$$

$$c = -1$$

$$y = 4x - 1$$

$$\text{b } m = \frac{\text{rise}}{\text{run}}$$

$$= \frac{-4}{2}$$

$$= -2$$

$$c = 4$$

$$y = -2x + 4$$

### EXPLANATION

Between  $(0, -1)$  and  $(1, 3)$  the rise is 4 and the run is 1.

The line cuts the y-axis at  $-1$ .

Substitute the values of  $m$  and  $c$  into  $y = mx + c$ .

Between  $(0, 4)$  and  $(2, 0)$   $y$  falls by 4 units as  $x$  increases by 2.

The line cuts the y-axis at 4.

Substitute the values of  $m$  and  $c$  into  $y = mx + c$ .

**Now you try**

Find the rule for these graphs by first finding the values of  $m$  and  $c$ .

**a**

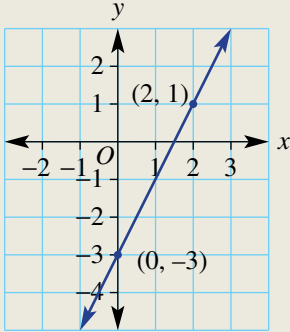

**b**

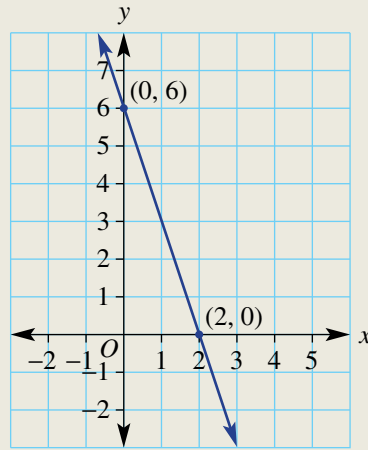

**Exercise 9H**

**FLUENCY**

1, 2-4(1/2), 5

2-4(1/2), 5

2-4(1/3), 5

1 State the gradient and y-intercept for the graphs of these rules.

Example 15a

**a i**  $y = 4x + 3$

**ii**  $y = 6x - 1$

Example 15b

**b i**  $y = \frac{1}{2}x - 3$

**ii**  $y = -\frac{2}{3}x + 1$

2 State the gradient and y-intercept for the graphs of these rules.

Example 15

**a**  $y = 4x + 2$

**b**  $y = 3x + 7$

**c**  $y = \frac{1}{2}x + 1$

**d**  $y = \frac{2}{3}x + \frac{1}{2}$

**e**  $y = -2x + 3$

**f**  $y = -4x + 4$

**g**  $y = -x - 6$

**h**  $y = -\frac{2}{3}x - \frac{1}{2}$

Example 16a

3 Find the rule for these graphs by first finding the gradient ( $m$ ) and the y-intercept ( $c$ ).

**a**

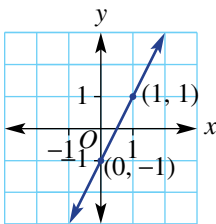

**b**

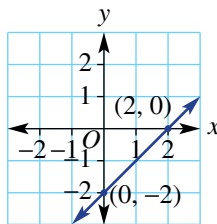

**c**

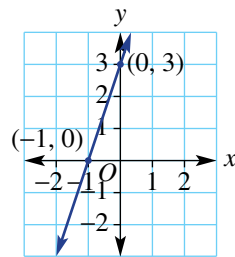

**d**

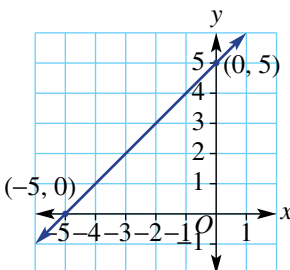

**e**

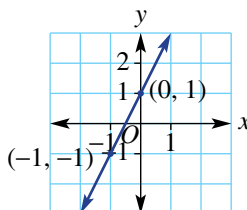

**f**

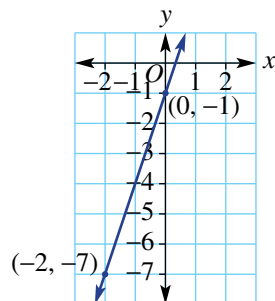

Example 16b

4 Find the rule for these graphs by first finding the values of  $m$  and  $c$ .

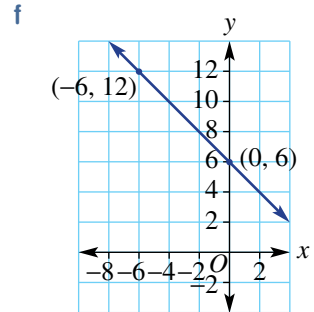
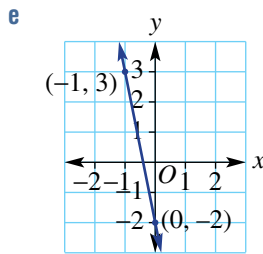
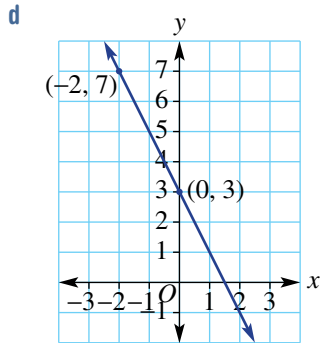
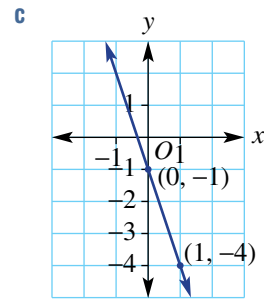
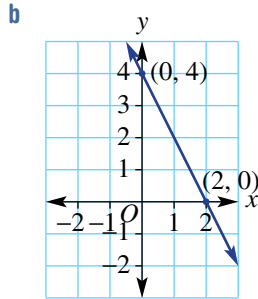
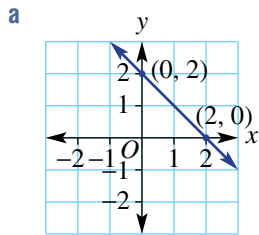

5 These graphs have rules that involve fractions. Find  $m$  and  $c$  and write the rule.

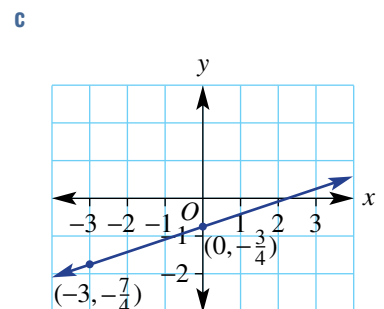
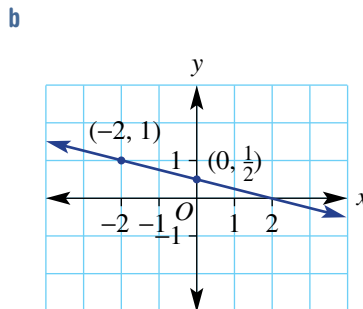
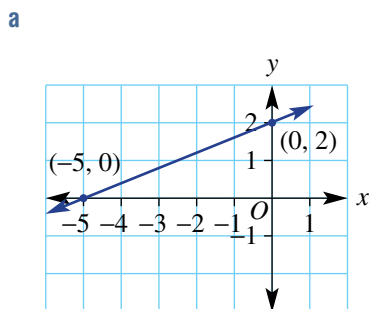

6 Order the graphs of these rules from steepest to least steep:

$$y = 2x + 5 \quad y = 4x + 1 \quad y = x + 10 \quad y = 3x - 11$$



Engineers can use the equation  $y = mx + c$  to represent the path of each straight section of water pipe.



## PROBLEM-SOLVING

6

6, 7, 8( $\frac{1}{2}$ )7, 8–9( $\frac{1}{2}$ )

- 7 The graphs below are shown without any numbers. The  $x$ -axis and  $y$ -axis do not necessarily have the same scale. Choose the correct rule for each from the choices:

$$y = x - 4, \quad y = -2x + 3, \quad y = 3x + 4, \quad y = -4x - 1$$

a

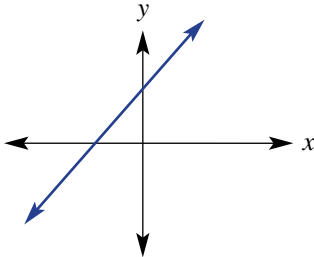

b

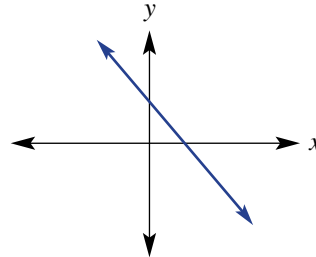

c

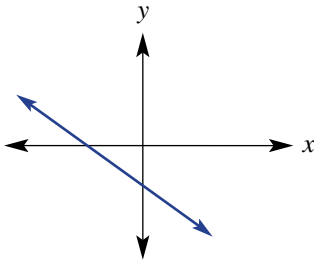

d

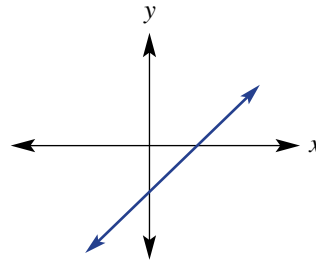

- 8 Find the rule for the graph of the lines connecting these pairs of points.

a  $(0, 0)$  and  $(2, 6)$

b  $(-1, 5)$  and  $(0, 0)$

c  $(-2, 5)$  and  $(0, 3)$

d  $(0, -4)$  and  $(3, 1)$

- 9 A line passes through the given points. Note that the  $y$ -intercept is not given. Find  $m$  and  $c$  and write the linear rule. A graph may be helpful.

a  $(-1, 1)$  and  $(1, 5)$

b  $(-2, 6)$  and  $(2, 4)$

c  $(-2, 4)$  and  $(3, -1)$

d  $(-5, 0)$  and  $(2, 14)$



## REASONING

10, 11

10–12

11–13

- 10** Lines are parallel if they have the same gradient.
- Show that  $y = 2x + 3$  and  $y = 2x - 5$  are parallel by stating their gradient.
  - Give the rule of a line that is parallel to  $y = 3x + 2$ , which passes through  $(0, 8)$ .
- 11** Consider a graph that passes through  $(0, 4)$  and  $(5, 4)$ .
- Sketch this graph on a set of axes, labelling the two points listed.
  - Find the gradient using  $\frac{\text{rise}}{\text{run}}$ .
  - State the  $y$ -intercept.
  - Write the rule in the form  $y = \square x + \square$
  - Explain how this rule would usually be written, and why.
- 12** Write the rule for these graphs. Your rule should include the pronumerals  $a$  and/or  $b$ .

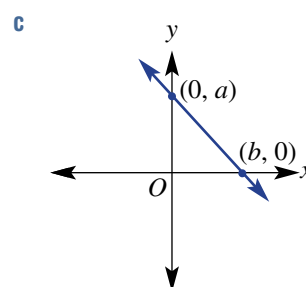
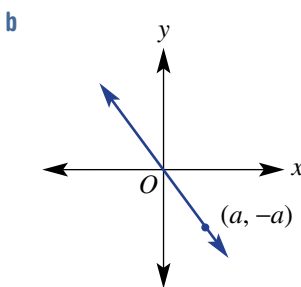
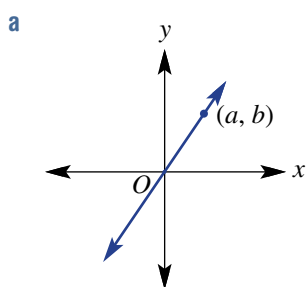

- 13** Some rules for straight lines may not be written in the form  $y = mx + c$ . The rule  $2y + 4x = 6$ , for example, can be rearranged to  $2y = -4x + 6$  then to  $y = -2x + 3$ . So clearly  $m = -2$  and  $c = 3$ . Use this idea to find  $m$  and  $c$  for these rules.

**a**  $2y + 6x = 10$

**b**  $3y - 6x = 9$

**c**  $2y - 3x = 8$

**d**  $x - 2y = -6$

ENRICHMENT: Sketching with  $m$  and  $c$ 

-

-

14(1/2)

- 14** The gradient and  $y$ -intercept can be used to sketch a graph without the need to plot more than two points.
- For example, the graph of the rule  $y = 2x - 1$  has  $m = 2$  ( $= \frac{2}{1}$ ) and  $c = -1$ . By plotting the point  $(0, -1)$  for the  $y$ -intercept and moving 1 to the right and 2 up for the gradient, a second point  $(1, 1)$  can be found.

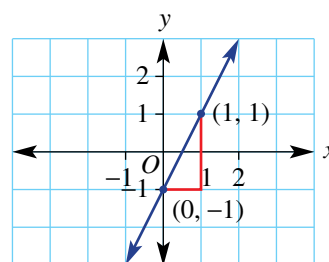

Use this idea to sketch the graphs of these rules.

**a**  $y = 3x - 1$

**b**  $y = 2x - 3$

**c**  $y = -x + 2$

**d**  $y = -3x - 1$

**e**  $y = 4x$

**f**  $y = -5x$

**g**  $y = \frac{1}{2}x - 2$

**h**  $y = -\frac{3}{2}x + 1$

The following problems will investigate practical situations drawing upon knowledge and skills developed throughout the chapter. In attempting to solve these problems, aim to identify the key information, use diagrams, formulate ideas, apply strategies, make calculations and check and communicate your solutions.

## Battered walls

- 1 Valerie is an architect who has been employed by a national civil engineering company to assist with the construction of a major new highway in Western Australia.

The highway will need to go through several mountain ranges where the company will blast and excavate rock. Establishing safe sloping road sides is a critical element in highway design. The slope gradient influences the stability of the slope and determines the degree to which gravity acts upon the soil mass.

*In the architecture industry, this is known as preparing 'battered walls' and Valerie needs to specify the slope for various sections of the proposed highway.*

For natural battered walls, where no other materials are used to support the wall, Valerie specifies a slope modelled by  $y = \frac{x}{4}$ , where  $x$  metres is the horizontal distance of the battered wall and  $y$  metres is the vertical distance.

- a If the horizontal distance of a stone reinforced battered wall is 30 m, what is the vertical height of the wall?

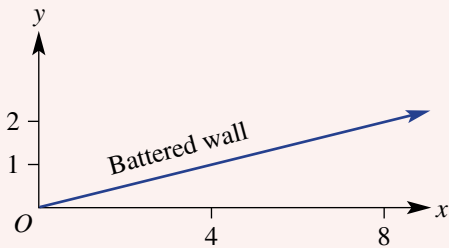

A road under construction featuring a battered (sloped) wall on the left side

Through using additional materials, such as bricks or stone, the slope of the battered wall can increase. Valerie specifies stone reinforced battered walls to have a slope modelled by  $y = \frac{7x}{10}$ .

- b If the vertical distance is 35 m, what is the horizontal distance of a stone reinforced battered wall?  
 c If the maximum horizontal distance that can be excavated for one battered wall is only 85 m, what is the maximum vertical depth the road can be excavated if using stone battered walls?  
 d A stone reinforced battered wall has a vertical distance of 30 m and a horizontal distance of 54 m. Does this meet Valerie's specifications?  
 e What is the horizontal distance saved in excavating for a 25 m vertical distance if using a stone battered wall compared with a natural battered wall? Give your answer correct to the nearest metre.

## Arriving at school

- 2 Pete and Novak are close friends who like to arrive at school at the same time. Pete lives farther away from school but rides his bike. Novak lives closer to school and walks each day. Pete lives 6 km from school and Novak lives 2 km from school. Pete rides his bike at a speed of 15 km/h, and Novak walks at a speed of 6 km/h.

*Pete and Novak are interested in using linear equations to determine when they should leave home so that they arrive together at school at 8:15 a.m.*

Pete determines his linear equation for the distance,  $d$ , he is from school at any given time,  $t$ , during his bike ride to be  $d = 6 - 15t$ .

- Sketch the graph of distance vs time for Pete's bike ride to school. Sketch for  $t$  between 0 and 0.5 hours.
- Determine Novak's linear equation for the distance he is from school at any given time,  $t$ .
- Sketch the graph of distance vs time for Novak's walk to school on the same axes as Pete's bike ride.
- If Pete and Novak left home at the same time, when and where would they meet? Find this solution algebraically and confirm graphically as the point of intersection of your two graphs.
- What does the  $t$ -intercept represent for Pete and Novak's graphs?
- How long does it take Pete to ride to school? How long does it take Novak to walk to school?
- If the two boys want to arrive at school together at 8:15 a.m., when should Pete leave his home and when should Novak leave his home?
- If Pete wants to leave home at the same time as Novak, how fast would Pete need to ride to arrive at school at the same time as Novak? Draw Pete's new linear equation on your axes to confirm they arrive at school together.

## The Golden Arrowhead

- 3 Phillip is a flag manufacturer and he has just been asked by a special client to print Guyana's national flag. For Phillip to print the flag on his machine, he must first write the appropriate equations of the straight lines into the machine.

*Phillip wants to determine the four linear equations required to print Guyana's flag, which is known as The Golden Arrowhead.*

The size of the flag is to be 6 m long and 4 m high.

- If Phillip sets  $(0, 0)$  as the coordinates of the bottom-left corner of the flag, what are the coordinates of the other three corners of the flag?
- What is the coordinate of the point of intersection of the two white lines?
- Determine the equations of the two white lines.
- What is the coordinate of the point of intersection of the two black lines?
- Determine the equations of the two black lines.
- Sketch the four linear equations, over appropriate values of  $x$ , required to print the national flag of Guyana.
- What do the five colours of Guyana's flag symbolise?
- Sketch another country's national flag that involves straight lines.



## 91 Applications of straight line graphs

### LEARNING INTENTIONS

- To understand that linear graphs can be applied to situations where there is a constant rate of change
- To be able to apply linear graphs to model and solve problems arising in real-world situations

Rules and graphs can be used to help analyse many situations in which there is a relationship between two variables.

If the rate of change of one variable with respect to another is constant, then the relationship will be linear and a graph will give a straight line. For example, if a pile of dirt being emptied out of a pit increases at a rate of 12 tonnes per hour, then the graph of the mass of dirt over time would be a straight line. For every hour, the mass of dirt increases by 12 tonnes.



The total cost,  $C$ , of renting aircraft includes the operating cost per hour plus an insurance fee. For example, the cost of hiring a fire-fighting helicopter could be expressed as:  $C = 5000n + 10000$ , for  $n$  hours of use.

### Lesson starter: Water storage

The volume of water in a tank starts at 1000 litres, and with constant rainfall the volume of water increases by 2000 litres per hour for 5 hours.

- Describe the two related variables in this situation.
- Discuss whether or not the relationship between the two variables is linear.
- Use a table and a graph to illustrate the relationship.
- Find a rule that links the two variables and discuss how your rule might be used to find the volume of water in the tank at a given time.

### KEY IDEAS

- If the rate of change of one variable with respect to another is constant, then the relationship between the two variables is **linear**.
- When applying straight line graphs, choose letters to replace  $x$  and  $y$  to suit the variables. For example,  $V$  for volume and  $t$  for time.

$$V = -25t + 200$$

The rate of change

The value of  $V$  when  $t = 0$

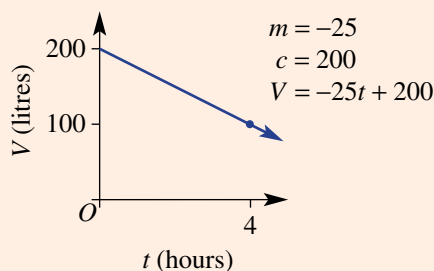

## BUILDING UNDERSTANDING

- 1 A rule linking distance  $d$  and time  $t$  is given by  $d = 10t + 5$ . Use this rule to find the value of  $d$  for the given values of  $t$ .
- a  $t = 1$                       b  $t = 4$                       c  $t = 0$                       d  $t = 12$
- 2 The height (in cm) of fluid in a flask increases at a rate of 30 cm every minute starting at 0 cm. Find the height of fluid in the flask at these times.
- a 2 minutes                      b 5 minutes                      c 11 minutes
- 3 The volume of gas in a tank decreases from 30L by 2L every second. Find the volume of gas in the tank at these times.
- a 1 second                      b 3 seconds                      c 10 seconds



## Example 17 Linking distance with time

A hiker walks at a constant rate of 4 kilometres per hour for 4 hours.

- a Draw a table of values using  $t$  for time in hours and  $d$  for distance in kilometres. Use  $t$  between 0 and 4.
- b Draw a graph by plotting the points given in the table in part a.
- c Write a rule linking  $d$  with  $t$ .
- d Use your rule to find the distance travelled for 2.5 hours of walking.
- e Use your rule to find the time taken to travel 8 km.

## SOLUTION

a

$t$	0	1	2	3	4
$d$	0	4	8	12	16

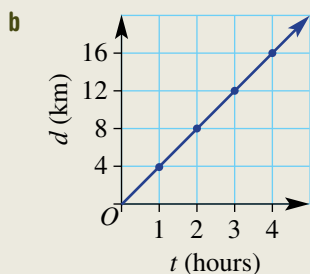

c  $d = 4t$

## EXPLANATION

$d$  increases by 4 for every increase in  $t$  by 1.

Plot the points on a graph using a scale that matches the numbers in the table.

The rate of change is 4 km per hour and the initial distance covered is 0 km, so  $d = 4t + 0$  or  $d = 4t$ .

**SOLUTION**

$$\begin{aligned} \text{d } d &= 4t \\ &= 4 \times 2.5 \\ &= 10 \end{aligned}$$

The distance is 10 km after 2.5 hours of walking.

$$\begin{aligned} \text{e } d &= 4t \\ 8 &= 4t \\ +4 \quad \swarrow \quad \searrow \quad +4 \\ 2 &= t \end{aligned}$$

The time taken to walk 8 km is 2 hours.

**EXPLANATION**

Substitute  $t = 2.5$  into your rule and find the value for  $d$ .

Answer the original question.

Substitute  $d = 8$  into your rule then divide both sides by 4.

Answer the original question.

**Now you try**

A cyclist rides at a constant rate of 20 kilometres per hour for 4 hours.

- Draw a table of values using  $t$  for time in hours and  $d$  for distance in kilometres. Use  $t$  values between 0 and 4.
- Draw a graph by plotting the points given in the table in part **a**.
- Write a rule linking  $d$  with  $t$ .
- Use your rule to find the distance travelled for 2.5 hours of cycling.
- Use your rule to find the time taken to ride 60 km.

**Example 18 Applying graphs when the rate is negative**

The initial volume of water in a dish in the sun is 300 mL. The water evaporates and the volume decreases by 50 mL per hour for 6 hours.

- Draw a table of values using  $t$  for time in hours and  $V$  for volume in millilitres.
- Draw a graph by plotting the points given in the table in part **a**.
- Write a rule linking  $V$  with  $t$ .
- Use your rule to find the volume of water in the dish after 4.2 hours in the sun.
- Use your rule to find the time taken for the volume to reach 75 mL.

**SOLUTION**

<b>a</b>	$t$	0	1	2	3	4	5	6
	$V$	300	250	200	150	100	50	0

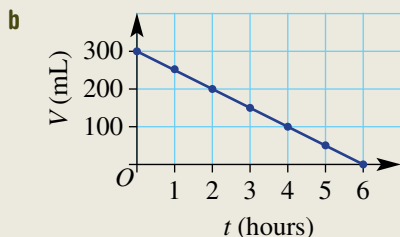
**EXPLANATION**

The volume starts at 300 millilitres and decreases by 50 millilitres every hour.

Use numbers from 0 to 300 on the  $V$ -axis and 0 to 6 on the  $t$ -axis to accommodate all the numbers in the table.

*Continued on next page*

**SOLUTION**

**c**  $V = -50t + 300$

**d**  $V = -50t + 300$   
 $= -50 \times 4.2 + 300$   
 $= 90$

The volume of water in the dish is 90 millilitres after 4.2 hours.

**e**

$$\begin{array}{r} v = -50t + 300 \\ 75 = -50t + 300 \\ -300 \quad \swarrow \quad \quad \quad \searrow -300 \\ -225 = -50t \\ +(-50) \quad \swarrow \quad \quad \quad \searrow +(-50) \\ 4.5 = t \end{array}$$

**EXPLANATION**

The rate of change is  $-50$  mL per hour and the initial volume is 300 mL, so  $V = 300 - 50t$  or  $V = -50t + 300$ .

Substitute  $t = 4.2$  into your rule to find  $V$ .

Substitute  $V = 75$  into your rule.  
 Subtract 300 from both sides.  
 Divide both sides by  $-50$ .

**Now you try**

A vat initially contains 60 litres of milk. It is drained at 10 litres per minute for the next 6 minutes.

- Draw a table of values using  $t$  for time in minutes and  $V$  for volume in litres.
- Draw a graph by plotting the points given in the table in part **a**.
- Write a rule linking  $V$  with  $t$ .
- Use your rule to find the volume of milk in the vat after 3.5 minutes.
- Use your rule to find the time taken for the volume to reach 5 litres.

**Exercise 9I****FLUENCY**

1-3

1-4

2-4

Example 17

- A jogger runs at a constant rate of 6 kilometres per hour for 3 hours.
  - Draw a table of values using  $t$  for time in hours and  $d$  for distance in kilometres. Use  $t$  between 0 and 3.
  - Draw a graph by plotting the points given in the table in part **a**.
  - Write a rule linking  $d$  with  $t$ .
  - Use your rule to find the distance travelled for 1.5 hours of jogging.
  - Use your rule to find how long it takes to travel 12 km.

Example 17

- A paddle steamer moves up the Murray River at a constant rate of 5 kilometres per hour for 8 hours.
  - Draw a table of values using  $t$  for time in hours and  $d$  for distance in kilometres. Use  $t$  values between 0 and 8.
  - Draw a graph by plotting the points given in the table in part **a**.
  - Write a rule linking  $d$  with  $t$ .
  - Use your rule to find the distance travelled after 4.5 hours.
  - Use your rule to find how long it takes to travel 20 km.



Example 18

- 3 The volume of water in a sink is 20 L. The plug is pulled out and the volume decreases by 4 L per second for 5 seconds.
- Draw a table of values using  $t$  for time in seconds and  $V$  for volume in litres.
  - Draw a graph by plotting the points given in the table in part a.
  - Write a rule linking  $V$  with  $t$ .
  - Use your rule to find the volume of water in the sink 2.2 seconds after the plug is pulled.
  - Use your rule to find how long it takes for the volume to fall to 8 L.
- 4 A weather balloon at a height of 500 m starts to descend at a rate of 125 m per minute for 4 minutes.
- Draw a table of values using  $t$  for time in minutes and  $h$  for height in metres.
  - Draw a graph by plotting the points given in the table in part a.
  - Write a rule linking  $h$  with  $t$ .
  - Use your rule to find the height of the balloon after 1.8 minutes.
  - Use your rule to find how long it takes for the balloon to fall to a height of 125 m.

## PROBLEM-SOLVING

5, 6

5, 6

6, 7

- 5 A BBQ gas bottle starts with 3.5 kg of gas. Gas is used at a rate of 0.5 kg per hour for a long lunch.
- Write a rule for the mass of gas  $M$  in terms of time  $t$ .
  - How long will it take for the gas bottle to empty?
  - How long will it take for the mass of the gas in the bottle to reduce to 1.25 kg?
- 6 A cyclist races 50 km at an average speed of 15 km per hour.
- Write a rule for the distance travelled  $d$  in terms of time  $t$ .
  - How long will it take the cyclist to travel 45 km?
  - How long will the cyclist take to complete the 50-km race? Give your answer in hours and minutes.
- 7 An oil well starts to leak and the area of an oil slick increases by  $8 \text{ km}^2$  per day. How long will it take the slick to increase to  $21 \text{ km}^2$ ? Give your answer in days and hours.

## REASONING

8

8, 9

9, 10

- 8 The volume of water in a tank (in litres) is given by  $V = 2000 - 300t$  where  $t$  is in hours.
- What is the initial volume?
  - Is the volume of water in the tank increasing or decreasing? Explain your answer.
  - At what rate is the volume of water changing?



- 9 A balloon's height (in metres) above the ground after  $t$  seconds is given by the rule  $h = 10 - 2t$ .
- State the initial height of the balloon.
  - Is the balloon going up or down? Explain your answer.
  - Find the height of the balloon after 3 seconds (using  $t = 3$ ).
  - Explain what would be wrong with substituting  $t = 7$  to find the balloon's height after 7 seconds.
  - If the balloon had been dropped from a height of 20 metres and fell at the same rate, write a rule relating  $h$  and  $t$ .
- 10 The cost of a phone call is 10 cents plus 0.5 cents per second.
- Explain why the cost  $c$  cents of the phone call for  $t$  seconds is given by  $c = 0.5t + 10$ .
  - Explain why the cost  $C$  dollars of the phone call for  $t$  seconds is given by  $C = 0.005t + 0.1$ .

**ENRICHMENT: Danger zone**

-

-

11

- 11 Two small planes take off and land at the same airfield. One plane takes off from the runway and gains altitude at a rate of 15 metres per second. At the same time, the second plane flies near the runway and reduces its altitude from 100 metres at rate of 10 metres per second.
- Draw a table of values using  $t$  between 0 and 10 seconds and  $h$  for height in metres of both planes.
- |                 |   |   |   |   |   |   |   |   |   |   |    |
|-----------------|---|---|---|---|---|---|---|---|---|---|----|
| $t(\text{s})$   | 0 | 1 | 2 | 3 | 4 | 5 | 6 | 7 | 8 | 9 | 10 |
| $h_1(\text{m})$ |   |   |   |   |   |   |   |   |   |   |    |
| $h_2(\text{m})$ |   |   |   |   |   |   |   |   |   |   |    |
- On one set of axes, draw a graph of the height of each plane during the 10-second period.
  - How long does it take for the second plane to touch the ground?
  - Write a rule for the height of each plane.
  - At what time are the planes at the same height?
  - At what time is the first plane at a height of 37.5 m?
  - At what time is the second plane at a height of 65 m?
  - At the same time, a third plane at an altitude of 150 m descends at a rate of 25 m per second. Will all three planes ever be at the same height at the same time? What are the heights of the three planes at the 4-second mark?



## 9J Non-linear graphs EXTENDING

### LEARNING INTENTIONS

- To understand that some rules relating  $x$  and  $y$  can result in graphs where the points do not lie on a line
- To be able to plot a non-linear relationship by creating a table of values

Not all relationships between two variables are linear. The amount of money invested in a compound interest account, for example, will not increase at a constant rate. Over time, the account balance will increase more rapidly, meaning that the graph of the relationship between *Amount* and *Time* will be a curve and not a straight line.

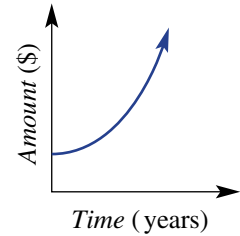

The cables on a suspension bridge form a shape similar to a parabola. Engineers model these curves using equations that include an  $x^2$  term.

### Lesson starter: The fixed perimeter play-pen

Imagine you have 10 metres of fencing material to make a rectangular play-pen.

- List some possible dimensions of your rectangle.
- What is the area of the play-pen for some of your listed dimensions?
- Complete this table showing all the positive integer dimensions of the play-pen.

<i>Width (m)</i>	1	2	3	4
<i>Length (m)</i>		3		
<i>Area (m<sup>2</sup>)</i>		6		

- Plot the *Area* against *Width* to form a graph.
- Discuss the shape of your graph.
- Discuss the situation and graphical points when the width is 1 m or 4 m.
- What dimensions would deliver a maximum area? Explain how your graph helps determine this.

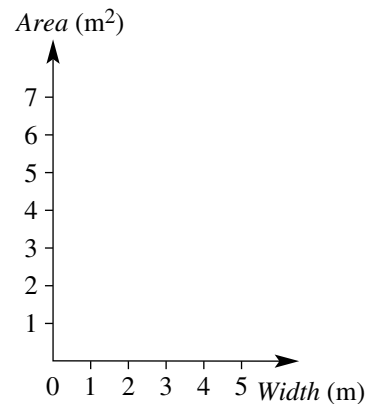

## KEY IDEAS

■ To plot **non-linear** curves given their rule, follow these steps.

- Construct a table of values using the rule.
- Plot the points on a set of axes.
- Join the plotted points to form a smooth curve.

■ The graph of  $y = x^2$  is an example of a non-linear graph called a **parabola**.

- The table shows five points that lie on the parabola. At each point, the  $y$ -value is the square of the  $x$ -value.

$x$	-2	-1	0	1	2
$y$	4	1	0	1	4

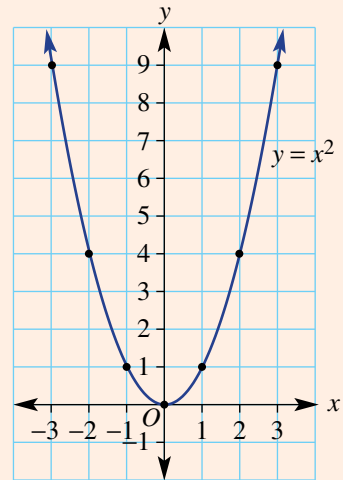

## BUILDING UNDERSTANDING

1 Copy these graphs then join the points to form smooth curves.

a

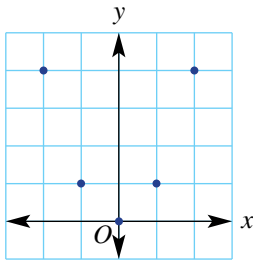

b

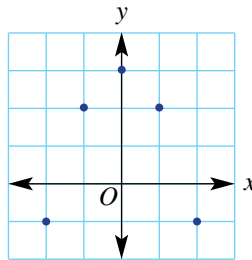

c

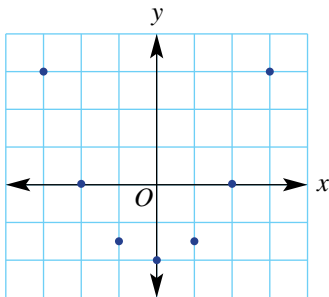

d

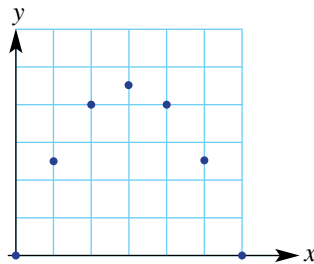

2 If  $y = x^2 - 1$ , find the value of  $y$  for these  $x$ -values.

a  $x = 0$

b  $x = 3$

c  $x = -4$

3 Decide if the following rules would give a non-linear graph.

a  $y = x^2$

b  $y = x$

c  $y = 2x$

d  $y = x^2 - 1$



### Example 19 Plotting a non-linear relationship

Plot points to draw the graph of  $y = x^2 - 2$  using a table.

#### SOLUTION

$x$	-3	-2	-1	0	1	2	3
$y$	7	2	-1	-2	-1	2	7

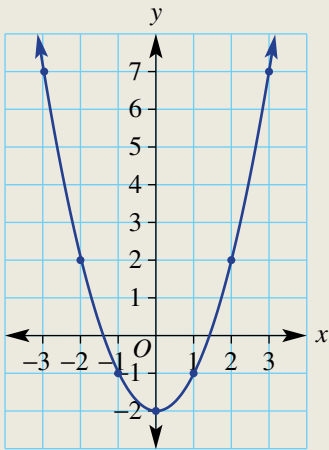

#### EXPLANATION

Find the value of  $y$  by substituting each value of  $x$  into the rule.

Plot the points and join with a smooth curve. The curve is called a parabola.

#### Now you try

Plot points to draw the graph of  $y = x^2 + 1$  using a table.

## Exercise 9J

### FLUENCY

1,  $2\frac{1}{2}$ , 3

2, 3

 $2\frac{1}{2}$ , 3

Example 19

- 1 Plot points to draw the graph of  $x^2 - 1$  using the given table and set of axes.

$x$	-3	-2	-1	0	1	2	3
$y$							

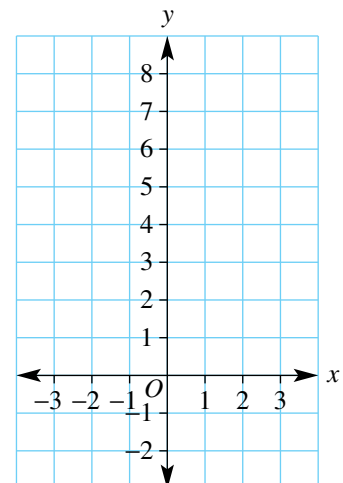

**Example 19** 2 Plot points to draw the graph of each of the given rules. Use the table and set of axes as a guide.

**a**  $y = x^2$

$x$	-3	-2	-1	0	1	2	3
$y$	9						

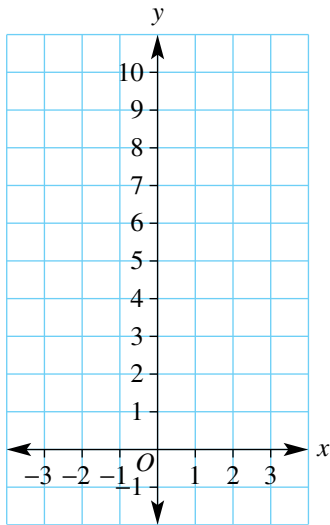

**b**  $y = x^2 - 4$

$x$	-2	-1	0	1	2
$y$	5				

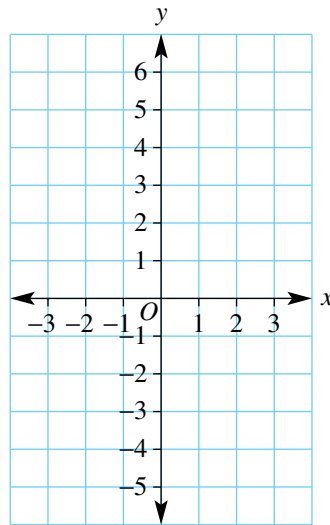

**c**  $y = x(4 - x)$

$x$	0	1	2	3	4
$y$					

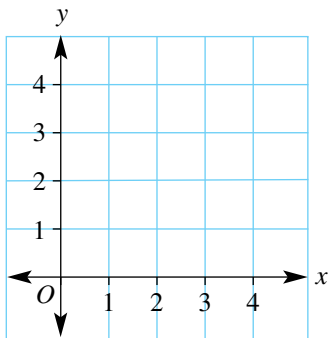

**d**  $y = 5 - x^2$

$x$	-3	-2	-1	0	1	2	3
$y$		1					

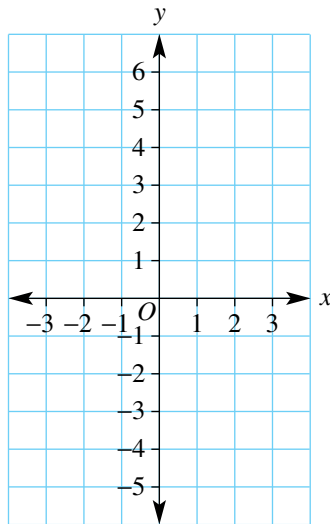

- 3 The behaviour of the Australian dollar against the British pound over a 6-month period is summarised by the data in this table.

<i>Time</i>	0	1	2	3	4	5	6
<i>AUD</i>	0.69	0.64	0.61	0.6	0.61	0.64	0.69

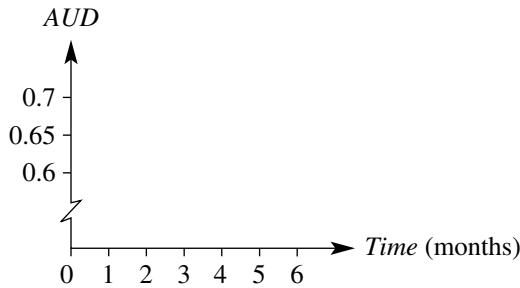

- Plot the data on the given graph and join to form a smooth curve.
- Describe the shape of your graph.
- By how much has the Australian dollar:
  - decreased in the first month?
  - increased in the fifth month?
- Estimate the value of the Australian dollar after 7 months.

**PROBLEM-SOLVING** 4      4, 5      4-6

- 4 James has 8 cm of string to form a rectangular space.

<i>Width (cm)</i>	0	1	2	3	4
<i>Length (cm<sup>2</sup>)</i>			2		
<i>Area (cm<sup>2</sup>)</i>			4		

- For the given width values, complete this table of values.
- Plot the *Area* against the *Width* to form a graph.

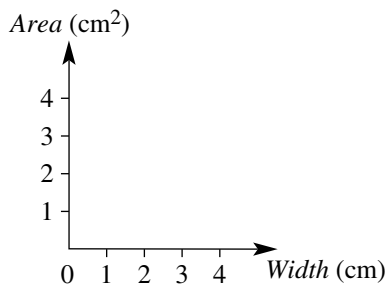

- Describe the shape of your graph.
- What rectangle dimensions appear to provide the maximum area?





## Fidget spinners

Sarayan thinks that there is money to be made by importing and selling fidget spinners to children and their parents.

He considers three models of spinners.

Model	Cost price (\$)	Selling price (\$)
Simple	5.50	9.10
Super	7.20	12.60
Luxury	10.80	15.90

His other fixed costs for running the business each month total to \$200.

*Present a report for the following tasks and ensure that you show clear mathematical workings and explanations where appropriate.*

### Preliminary task

- If Sarayan only buys and sells the Simple fidget spinners, find the total cost and the total revenue from buying and selling the following numbers of spinners over one month. Include the fixed costs of \$200.
  - 20
  - 50
  - 80
- Explain why the cost (\$ $C$ ) of buying  $n$  Simple spinners in one month is given by the rule  $C = 5.5n + 200$ .
- Explain why the revenue (\$ $R$ ) from selling  $n$  Simple spinners in one month is given by the rule  $R = 9.1n$ .
- Draw a graph of the rules for  $C$  and  $R$  on the same set of axes using  $n$  on the horizontal axis ranging from 0 through to 80.
- Use your graph to estimate the number of Simple spinners that need to be bought and sold so that the cost of buying  $n$  spinners in one month equals the revenue from selling  $n$  spinners.

### Modelling task

#### Formulate

- The problem is to determine the number of spinners that Sarayan should purchase and sell so that a profit is made. Within a month he only buys and sells one type of spinner (e.g. he just buys and sells 40 Super fidget spinners). Write down all the relevant information that will help solve this problem.
- Construct rules for the monthly cost (\$ $C$ ) and revenue (\$ $R$ ) in terms of  $n$  for the Super fidget spinners, factoring in the fixed \$200 cost he pays each month.
- Construct rules for the monthly cost (\$ $C$ ) and revenue (\$ $R$ ) in terms of  $n$  for the Luxury fidget spinners, factoring in the fixed \$200 cost he pays each month.

## Solve

- d Sketch graphs of the cost and revenue on the same set of axes (using  $n$  ranging from 0 to 80) for the Super fidget spinners.
- e Use the graph to estimate the number of Super fidget spinners that need to be bought and sold in one month so that Saranyan makes a profit.
- f Repeat the process above, using two graphs on the same set of axes, to estimate the number of Luxury fidget spinners that need to be bought and sold in one month to make a profit.

## Evaluate and verify

- g Decide which type of spinner delivers a profit for the least number of spinners bought and sold in a month. Justify your response.
- h For each spinner, solve an equation to determine algebraically the number of that type required to make a profit. Interpret your answers if they are not integers.
- i Compare the answers you found graphically with the answers you found algebraically. Describe how similar they were.

## Communicate

- j Summarise your results and describe any key findings.

## Extension questions

- a Saranyan can sell different types of spinners within the same month. For instance, if he buys and sells 20 Simple spinners, 40 Super spinners and 10 Luxury spinners, his total cost will be \$706 ( $\$200 + 20 \times \$5.50 + 40 \times \$7.20 + 10 \times \$10.80$ ) and his revenue will be \$845 ( $20 \times \$9.10 + 40 \times \$12.60 + 10 \times \$15.90$ ), giving a \$139 profit.
  - i Find the amount of profit Saranyan will make if he sells 30 of each type of spinner.
  - ii Investigate which combinations of Simple, Super and Luxury spinners will result in a profit.
  - iii Explain why the total number of possible combinations resulting in a loss is limited.
- b Saranyan decides just to sell the Luxury models of fidget spinner, because the cost of running the business for a month is set to change from \$200. He calculates that he will make a profit if he sells more than 50 Luxury spinners in a month, but he will make a loss if he sells fewer than 45 Luxury spinners in a month. Investigate what the new fixed cost could be.



## Sausages and drinks

### Key technology: Graphing

Marissa has a certain amount of money to spend on sausages and drinks at a community fair for her son's friends. Each drink costs \$2 and each sausage costs \$3.

We will use the following variables.

- $x$  is the number of drinks purchased.
- $y$  is the number of sausages purchased.



### 1 Getting started

We will first consider the case where Marissa has \$48 to spend.

- Find the total cost of purchasing the following.
  - 7 drinks and 6 sausages
  - 10 drinks and 8 sausages
- Will Marissa be able to afford 9 drinks and 11 sausages? Give a reason.
- If Marissa aims to spend exactly \$48, write an equation using the variables  $x$  and  $y$ .
- Using your equation in part **c**, find:
  - the value of  $x$  if  $y = 0$
  - the value of  $y$  if  $x = 0$ .
- Sketch a graph of your rule in part **c** using  $x$  values between 0 and 24 inclusive.

### 2 Using technology

- Use graphing software like Desmos to draw a graph of your equation found in part **1c** above. Add a restriction to the range of  $x$  values so that both  $x$  and  $y$  are greater than or equal to zero.
- Add the points representing the different purchases in parts **1a** and **b** above. What do you notice about the positions of these points in relation to the line?
- Plot and label the point  $(15, 6)$ . What does this point represent in terms of the number of drinks and sausages purchased and the total amount spent?

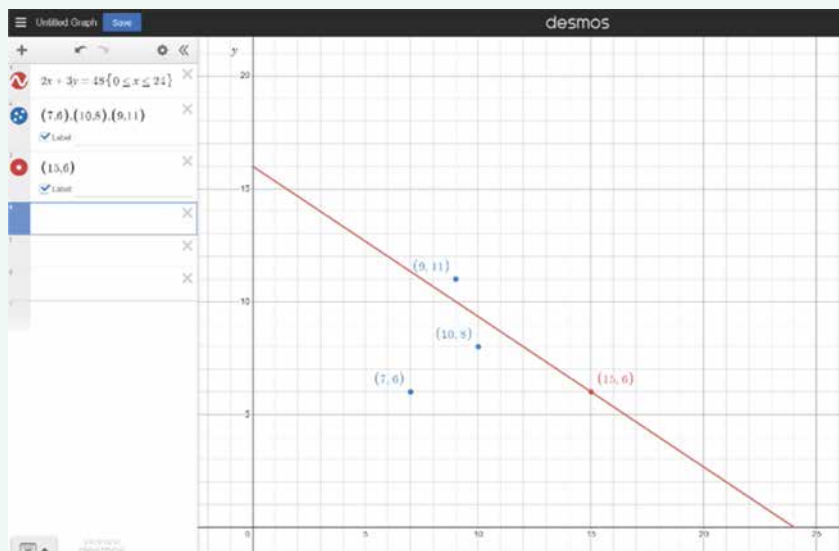

- d Find two other points using integer values of  $x$  and  $y$  which result in Marissa spending exactly \$48.
- e Which region on the graph represents the points where Marissa spends less than or equal to \$48? Write an inequality that describes this region.
- f Which region on the graph represents the points where Marissa spends more than \$48? Write an inequality that describes this region.
- g If Marissa must buy 10 sausages, what is the maximum number of drinks that she can buy?

### 3 Applying an algorithm

Marissa realises that to feed all her son's friends she will need to spend more than \$48. She also needs to buy 15 sausages and at least 14 drinks.

- a Use your graphing package to sketch the region given by  $2x + 3y \leq d$ , where  $d$  represents Marissa's maximum spend. Add a slider for  $d$  and change the range of possible values of  $d$  from 0 to 80 as shown.
 
- b Investigate the possible number of drinks that Marissa can buy if her maximum spend is between \$50 and \$80 by following this algorithm.
  - Step 1: Adjust the  $d$  value to 50.
  - Step 2: Find a point that describes the situation where Marissa buys 15 sausages and a maximum number of drinks with the remaining change.
  - Step 3: Add your result into this table including the actual amount spent for your chosen values of  $x$ . The first column is completed for you.

$\$d$ (Maximum spend)	\$50	\$55	\$60	\$65	\$70	\$75	\$80
Number of drinks $x$	2						
Number of sausages $y$	15	15					
\$Actual total spent	\$49						

- Step 4: Increase the  $d$  value by 5 and repeat from Step 2 until you reach  $d = 80$ .
- c What was the smallest value of  $d$  listed in your table above where Marissa can buy 15 sausages and 14 drinks?
- d Now adjust the value of  $d$  using your graphing package to find the smallest value of  $d$  such that Marissa buys 15 sausages and at least 14 drinks.

### 4 Extension

Now consider a similar situation where the price of a drink in dollars and sausage can vary. Let  $\$a$  be the price of a drink and  $\$b$  be the price of a sausage in dollars.

- a Use your graphing package to draw a graph using sliders for  $a$ ,  $b$  and  $d$ . Allow the sliders for  $a$  and  $b$  to vary by 0.5.
- b Drag the sliders to explore the different graphs for the varying costs. For each set of values of  $a$ ,  $b$  and  $d$ , find a point which represents Marissa buying 15 sausages and at least 14 drinks.
- c For a fixed value of  $d$ , investigate how the values of  $a$  and  $b$  impact on Marissa's ability to buy 15 sausages and at least 14 drinks. Write a conclusion, giving examples to justify your ideas.



## Families of straight lines

A set of lines are said to be in the same family if the lines have something in common; for example, four lines that pass through the point (1, 2).

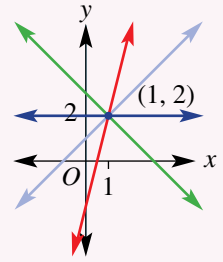

### The parallel family

1 Complete the table for these rules.

a  $y_1 = 2x - 5$

b  $y_2 = 2x - 2$

c  $y_3 = 2x$

d  $y_4 = 2x + 3$

$x$	-3	-2	-1	0	1	2	3
$y_1$							
$y_2$							
$y_3$							
$y_4$							

2 Plot the points given in your table to draw graphs of the four rules in Question 1 on one set of axes. Label each line with its rule.

3 What do you notice about the graphs of the four rules? Describe how the numbers in the rule relate to its graph.

4 How would the graphs for the rules  $y = 2x + 10$  and  $y = 2x - 7$  compare with the graphs you have drawn above? Explain.

### The point family

5 Complete the table for these rules.

a  $y_1 = x + 1$

b  $y_2 = 2x + 1$

c  $y_3 = 1$

d  $y_4 = -x + 1$

e  $y_5 = -\frac{1}{2}x + 1$

$x$	-3	-2	-1	0	1	2	3
$y_1$							
$y_2$							
$y_3$							
$y_4$							
$y_5$							

6 Plot the points given in your table to draw graphs of the five rules in Question 5 on one set of axes. Label each line with its rule.

7 What do you notice about the graphs of the five rules? Describe how the numbers in the rule relate to its graph.

8 How would the graphs for the rules  $y = 3x + 1$  and  $y = -\frac{1}{3}x + 1$  compare with the graphs you have drawn above? Explain.

## Exploring families with technology

Graphing software and spreadsheets are useful tools to explore families of straight lines. Here are some screenshots showing the use of technology.

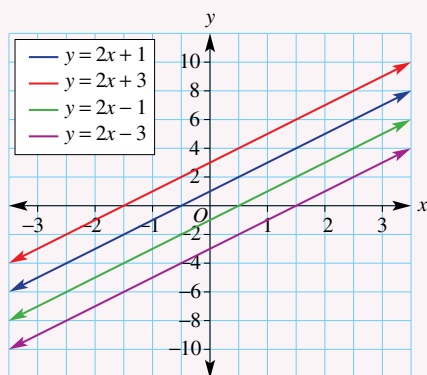
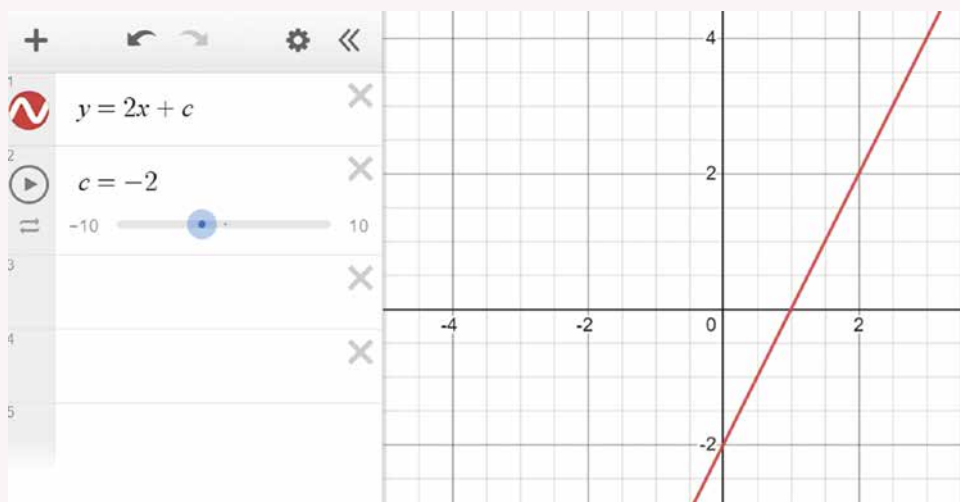

	A	B	C	D	E
1	x	$y = 2x + 1$	$y = 2x + 3$	$y = 2x - 1$	$y = 2x - 3$
2	-3	-5	-3	-7	-9
3	-2	-3	-1	-5	-7
4	-1	-1	1	-3	-5
5	0	1	3	-1	-3
6	1	3	5	1	-1
7	2	5	7	3	1
8	3	7	9	5	3

- Choose one type of technology and sketch the graphs for the two families of straight lines shown in the previous two sections: the 'parallel family' and the 'point family'.
- Use your chosen technology to help design a family of graphs that produces the patterns shown. Write down the rules used and explain your choices.

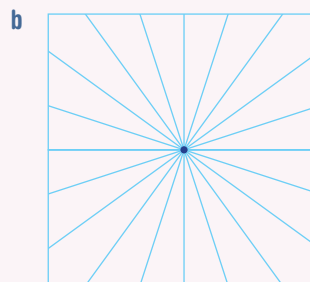
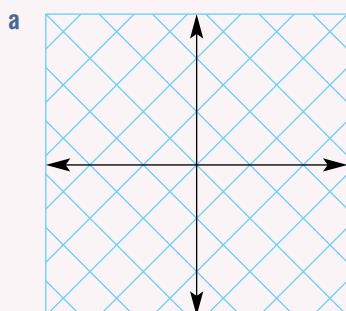

- Make up your own design and use technology to produce it. Explain how your design is built and give the rules that make up the design.



Up for a challenge? If you get stuck on a question, check out the 'Working with unfamiliar problems' poster at the end of the book to help you.

1 A trekker hikes down a track at 3 km per hour. Two hours later, a second trekker sets off on the same track at 5 km per hour. How long is it before the second trekker catches up with the first?

2 Find the rules for the non-linear relations with these tables.

a

$x$	-2	-1	0	1	2
$y$	1	-2	-3	-2	1

b

$x$	-2	-1	0	1	2
$y$	6	9	10	9	6

c

$x$	0	1	4	9	16
$y$	1	2	3	4	5

d

$x$	-3	-2	-1	0	1
$y$	-30	-11	-4	-3	-2

- 3 A line with a gradient of 3 intersects another line at right angles. Find the gradient of the other line.
- 4 Two cars travel towards each other on a 100 km stretch of road. One car travels at 80 km per hour and the other at 70 km per hour. If they set off at the same time, how long will it be before the cars meet?
- 5 Find the  $y$ -intercept of a line joining the two points  $(-1, 5)$  and  $(2, 4)$ .
- 6 Find the rule of a line that passes through the two points  $(-3, -1)$  and  $(5, 3)$ .
- 7 Find the number of matchsticks needed in the 100th diagram in the pattern given below. The first three diagrams in the pattern are given.

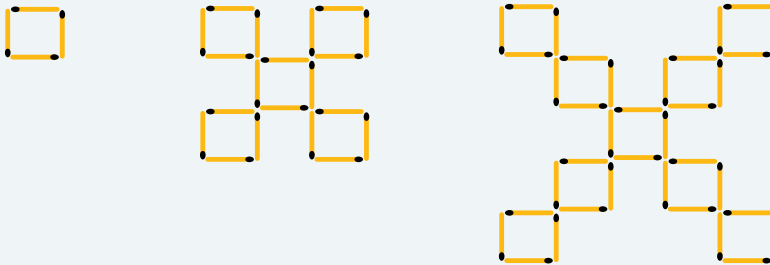

- 8 At a luxury car hire shop, a Ferrari costs \$300 plus \$40 per hour. A Porsche costs \$205 plus \$60 per hour. What hire time makes both cars the same cost? Give the answer in hours and minutes.
- 9 Find the area of the figure enclosed by the four lines:  $x = 6$ ,  $y = 4$ ,  $y = -2$  and  $y = x + 5$ .
- 10 A rectangle  $ABCD$  is rotated about  $A$  by  $90^\circ$  clockwise.
- a In two different ways, explain why the diagonal  $AC$  is perpendicular to its image  $A'C'$ .
- b If  $AB = p$  and  $BC = q$ , find the simplified product of the gradients of  $AC$  and  $A'C'$ .

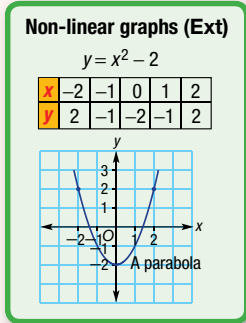
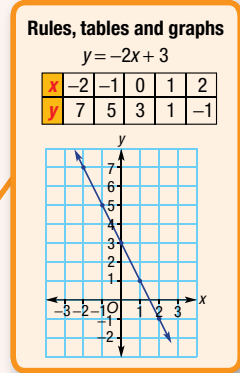
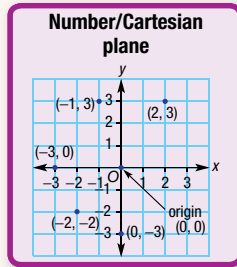
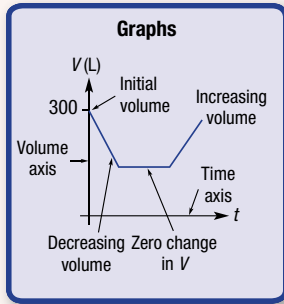

## Straight line graphs

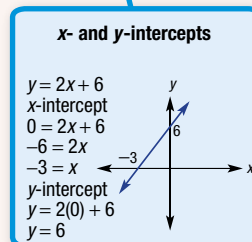
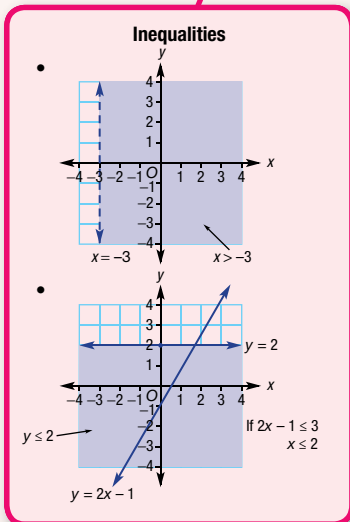
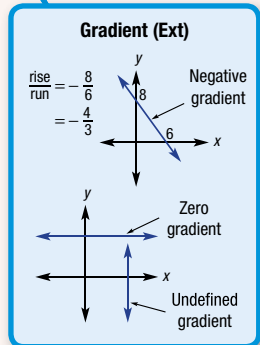
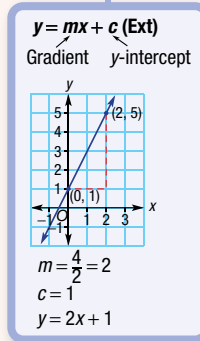
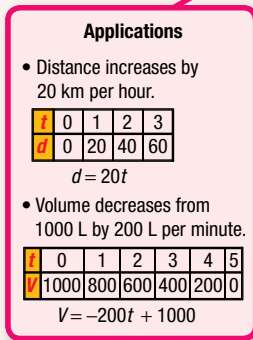
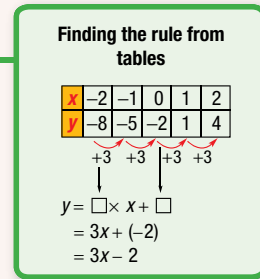



# Chapter checklist with success criteria

A printable version of this checklist is available in the Interactive Textbook 

9A

**1. I can plot points at a given location.**

e.g. Draw a number plane extending from  $-4$  to  $4$  on both axes then plot and label the points  $A(2, 3)$ ,  $C(-1, 2.5)$  and  $F(2, -4)$ .

9B

**2. I can create a table of values for a rule.**

e.g. For the rule  $y = 2x - 1$  construct a table using values of  $x$  between  $-3$  and  $3$ .

9B

**3. I can draw a graph of a rule.**

e.g. Draw a graph of  $y = 2x - 1$  using values of  $x$  between  $-3$  and  $3$ .

9B

**4. I can decide whether a point lies on the graph of a given rule.**

e.g. Decide if the  $(1, 3)$  and  $(-2, -4)$  lie on the graph of  $y = 3x$ .

9C

**5. I can find the rule from a table of values.**

e.g. Find the rule for this table of values.

$x$	3	4	5	6	7
$y$	$-5$	$-7$	$-9$	$-11$	$-13$

9C

**6. I can find the rule from a graph where coordinates are shown for the integer values of  $x$ .**

e.g. Find the rule for this graph by first constructing a table of  $(x, y)$  values.

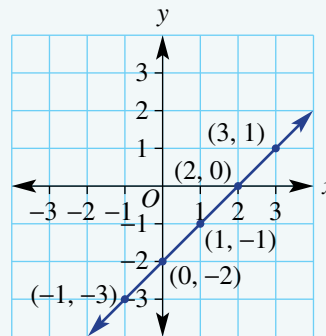

9D

**7. I can use a linear graph to solve an equation.**

e.g. Use a graph of  $y = 2x + 1$  to solve the equation  $2x + 1 = 5$ .

9D

**8. I can use the point of intersection of two lines to solve an equation.**

e.g. Use the graphs of  $y = 4 - x$  and  $y = 2x + 1$  to solve the equation  $4 - x = 2x + 1$ .

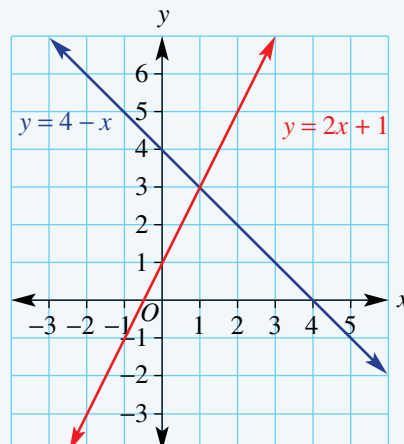

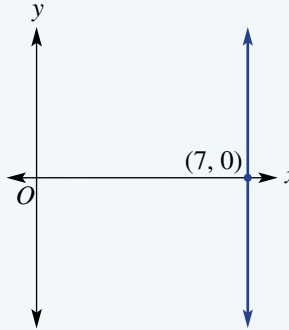
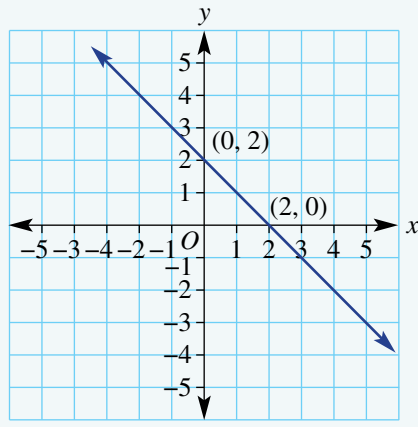
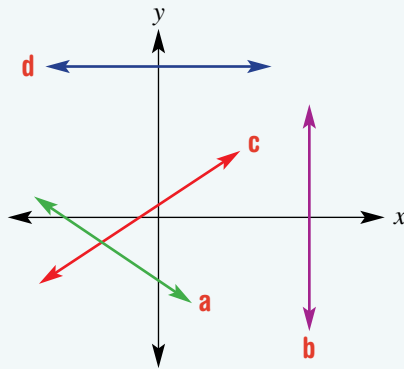
9E	<p><b>9. I can find the rule for horizontal and vertical lines.</b> e.g. Find the rule for this vertical line.</p> 	<input checked="" type="checkbox"/>
9E	<p><b>10. I can sketch a region using horizontal or vertical lines.</b> e.g. Sketch the region <math>y &lt; 4</math>.</p>	<input type="checkbox"/>
9E	<p><b>11. I can use graphs to solve a linear inequality.</b> e.g. Use the given graph to solve <math>-x + 2 &gt; -1</math>.</p> 	<input type="checkbox"/>
9F	<p><b>12. I can find the x-intercept and y-intercept for the graph of a rule.</b> e.g. Find the x-intercept and y-intercept for the graph of <math>y = -2x + 1</math>.</p>	<input type="checkbox"/>
9F	<p><b>13. I can sketch the graph of a rule by finding the axes intercepts.</b> e.g. Find the x- and y-intercepts and then sketch the graph of the rule <math>y = 2x - 8</math>.</p>	<input type="checkbox"/>
9G	<p><b>14. I can decide if a gradient is positive, negative, zero or undefined.</b> Decide for each line whether the gradient is positive, negative, zero or undefined.</p> 	<input type="checkbox"/>

9G

- 15. I can calculate the gradient of a line.**  
e.g. Find the gradient of this line.

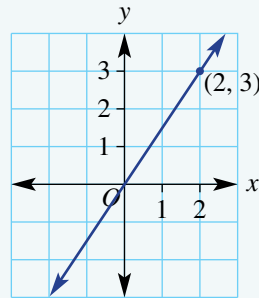

Ext

9H

- 16. I can state the gradient and  $y$ -intercept from a rule.**  
e.g. Write down the gradient and  $y$ -intercept of the rule  $y = \frac{1}{3}x - 4$ .

Ext

9H

- 17. I can find the rule from a graph.**  
e.g. Find the rule for this graph by first finding the values of  $m$  and  $c$ .

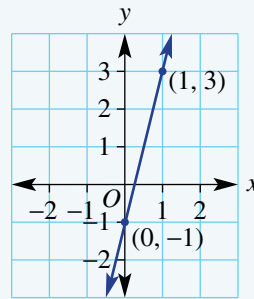

Ext

9I

- 18. I can apply linear graphs to model real-world situations.**  
e.g. The volume of water in a dish is 300 mL initially and decreases by 50 mL per hour for 6 hours. Draw a graph of the relationship between volume ( $V$  mL) and time ( $t$  hours) and determine a rule linking  $V$  and  $t$ . Then find the time taken for the volume to reach 75 mL.

9J

- 19. I can plot a non-linear relationship.**  
e.g. Plot points to draw the graph of  $y = x^2 - 2$  using a table.

Ext

## Short-answer questions

9A

- 1 The graph shows how far a bird is from its nest.

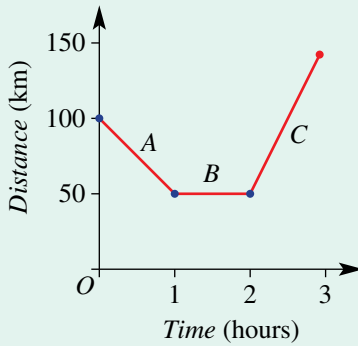

- a How far was the bird from its nest initially (at the start)?
- b For how long did the bird rest?
- c How far did the bird travel in:
  - i section A?
  - ii section C?
- d During which section did the bird fly the fastest?

9A

- 2 Write the coordinates of all the points A–J in the graph below.

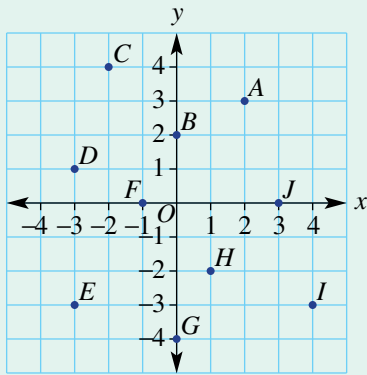

9B

- 3 For each rule, create a table using
- $x$
- values from
- $-3$
- to
- $3$
- and plot to draw a straight line graph.

- a  $y = 2x$
- b  $y = 3x - 1$
- c  $y = 2x + 2$
- d  $y = -x + 1$
- e  $y = -2x + 3$
- f  $y = 3 - x$

9C

- 4 Write the rule for these tables of values.

a

$x$	-2	-1	0	1	2
$y$	-3	-1	1	3	5

b

$x$	-2	-1	0	1	2
$y$	-4	-1	2	5	8

c

$x$	3	4	5	6	7
$y$	6	7	8	9	10

d

$x$	-3	-2	-1	0	1
$y$	4	3	2	1	0

e

$x$	-1	0	1	2	3
$y$	3	-1	-5	-9	-13

f

$x$	-6	-5	-4	-3	-2
$y$	8	7	6	5	4

9D

5 Use this graph of  $y = 2x - 1$ , shown here, to solve each of the following equations.

a  $2x - 1 = 3$

b  $2x - 1 = -5$

c  $2x - 1 = 0$

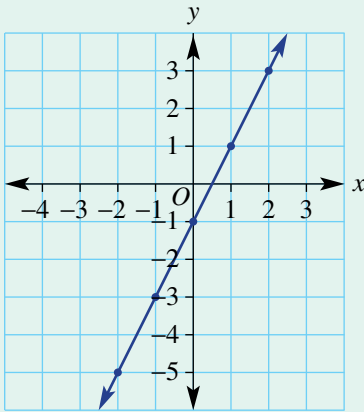

9E

6 Write the rule for each of these horizontal and vertical lines.

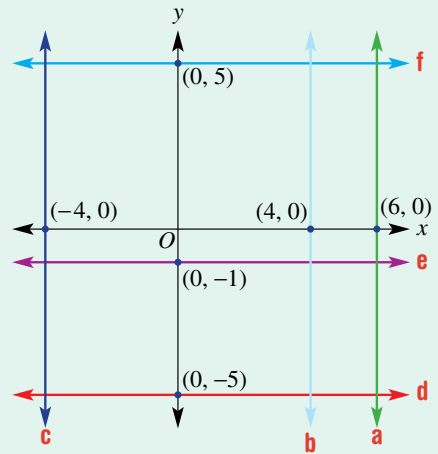

9E

7 Sketch the following regions.

a  $x < 2$

b  $y \geq -3$

9E

8 Use the given graphs to solve the following inequalities.

a  $x - 1 < 1$

b  $-2x + 1 \geq 3$

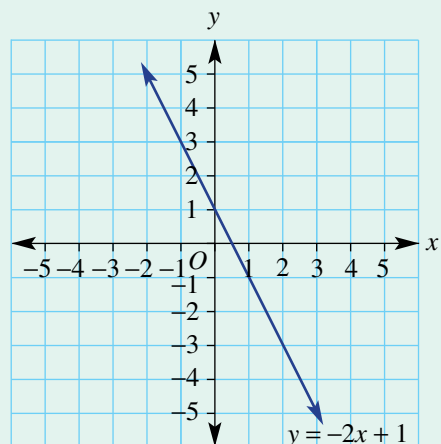
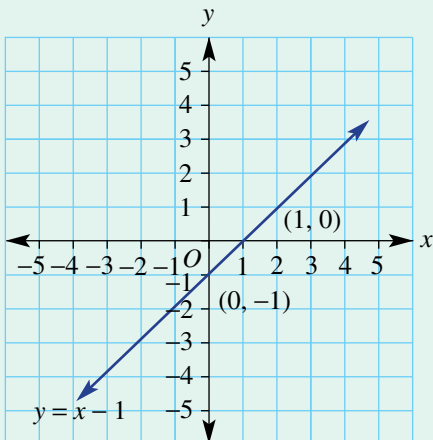

9F

- 9 Find the
- $x$
- and
- $y$
- intercepts for the graphs of the following rules.

a  $y = 2x - 12$

b  $y = 3x + 9$

c  $y = -x - 4$

d  $y = -4x + 8$

9F

- 10 Find the
- $x$
- and
- $y$
- intercepts for the graphs of these rules and then sketch the graphs.

a  $y = x + 3$

b  $y = 2x - 10$

c  $y = -4x + 8$

9G

- 11 Find the gradient of each of these lines.

Ext

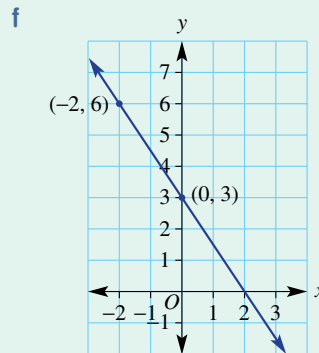
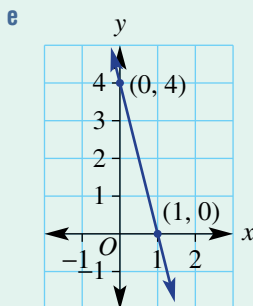
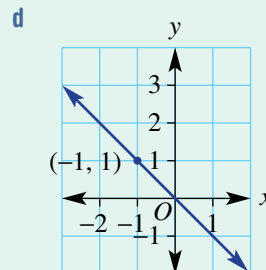
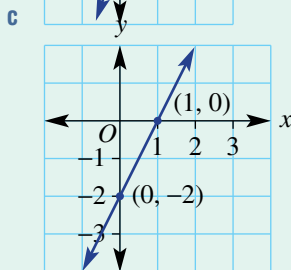
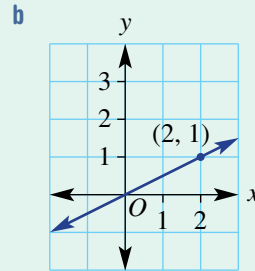
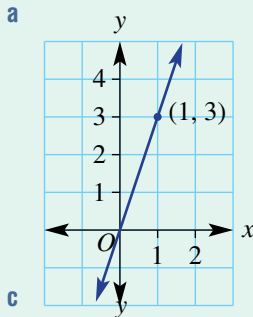

9G

- 12 Find the gradient of the line joining these pairs of points.

a  $(0, 0)$  and  $(3, -12)$

b  $(-4, 2)$  and  $(0, 0)$

c  $(1, 1)$  and  $(4, 4)$

d  $(-5, 3)$  and  $(1, -9)$

Ext

9H

- 13 Write the gradient (
- $m$
- ) and
- $y$
- intercept for the graphs of these rules.

a  $y = 5x + 2$

b  $y = 2x - 4$

c  $y = -3x + 7$

d  $y = -x - \frac{1}{2}$

Ext

9H

14 Write the rule for these graphs by first finding the values of  $m$  and  $c$ .

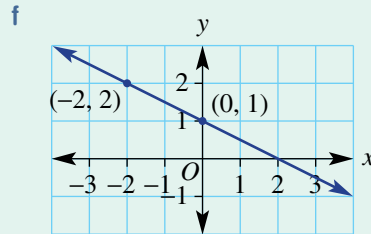
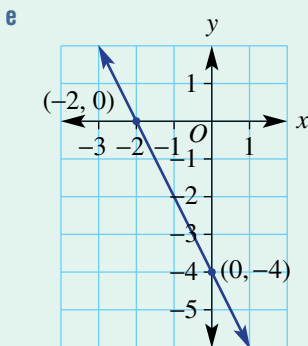
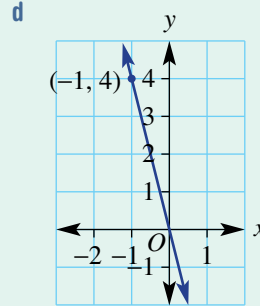
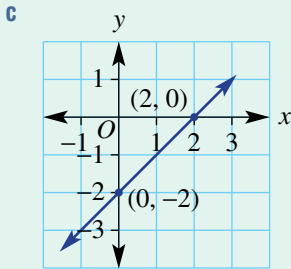
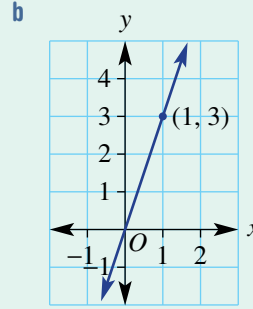
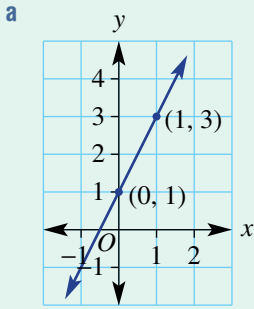

9H

15 Find the rule for the graphs of the lines connecting these points by first finding the value of  $m$  and  $c$ .

Ext

a (0, 0) and (1, 6)

b (-1, 4) and (0, 0)

c (-2, 3) and (0, 1)

d (0, -2) and (6, 1)

9J

16 Using a table with  $x$ -values between  $-2$  and  $2$ , draw a smooth curve for the non-linear graphs of these rules.

Ext

a  $y = x^2$

b  $y = x^2 - 2$

### Multiple-choice questions

9A

1 This graph shows the relationship between the height and age of three people. Who is the tallest person?

- A Ralph
- B Lucy
- C Kevin
- D Lucy and Ralph together
- E Kevin and Lucy together

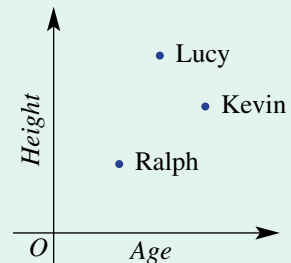

9A 2 The name of the point  $(0, 0)$  on a number (Cartesian) plane is:  
 A  $y$ -intercept    B gradient    C origin    D axis    E  $x$ -intercept

9A 3 Which point is not in line with the other points?  $A(-2, 3)$ ,  $B(-1, 2)$ ,  $C(0, 0)$ ,  $D(1, 0)$ ,  $E(2, -1)$   
 A  $A$     B  $B$     C  $C$     D  $D$     E  $E$

9B 4 Which of the points  $A(1, 2)$ ,  $B(2, -1)$  or  $C(3, -4)$  lie on the line  $y = -x + 1$ ?  
 A  $C$  only    B  $A$  and  $C$     C  $A$     D  $B$     E None

9C 5 The rule for this table of values is:

$x$	-2	-1	0	1	2
$y$	3	2	1	0	-1

A  $y = x + 5$     B  $y = -x + 1$     C  $y = x + 1$   
 D  $y = 2x - 1$     E  $y = 2x + 1$

9E 6 The coordinates of the point of intersection of the graphs of  $y = 3$  and  $x = -2$  are:

A  $(0, 3)$   
 B  $(2, -3)$   
 C  $(-2, -3)$   
 D  $(-2, 3)$   
 E  $(2, 3)$

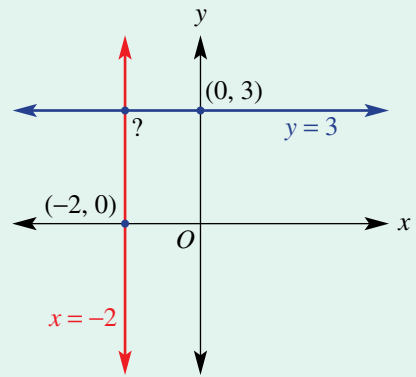

9G 7 The gradient of a line joining the two points  $(0, 0)$  and  $(1, -6)$  is:  
 (Ext) A 3    B 6    C 1    D -6    E -3

9H 8 The gradient of a line is  $-1$  and its  $y$ -intercept is  $-3$ . The rule for the line is:  
 (Ext) A  $y = -x - 3$     B  $y = x - 3$     C  $y = -x + 3$   
 D  $y = x + 3$     E  $-(x - 1)$

9H 9 The rule for a horizontal line passing through  $(0, 6)$  is:  
 (Ext) A  $y = 6x + 1$     B  $y = 6x$     C  $y = x + 6$   
 D  $y = x - 6$     E  $y = 6$

9I 10 The water level ( $h$  centimetres) in a dam starts at  $300$  cm and decreases by  $5$  cm every day for  $10$  days. The rule for this relationship is:  
 A  $h = 5t + 300$     B  $h = 300t$     C  $h = 300t - 5$   
 D  $h = -60t$     E  $h = -5t + 300$



## Extended-response questions

- 1 A seed sprouts and the plant grows 3 millimetres per day in height for 6 days.
  - a Construct a table of values using  $t$  for time in days and  $h$  for height in millimetres.
  - b Draw a graph using the points from your table. Use  $t$  on the horizontal axis.
  - c Find a rule linking  $h$  with  $t$ .
  - d Use your rule to find the height of the plant after 3.5 days.
  - e If the linear pattern continued, what would be the height of the plant after 10 days?
  - f How long will it be before the plant grows to 15 mm in height?
  
- 2 A speed boat at sea is initially 12 km from a distant buoy. The boat travels towards the buoy at a rate of 2 km per minute. The distance between the boat and the buoy will therefore decrease over time.
  - a Construct a table showing  $t$  for time in minutes and  $d$  for distance to the buoy in kilometres.
  - b Draw a graph using the points from your table. Use  $t$  on the horizontal axis.
  - c How long does it take the speed boat to reach the buoy?
  - d What is the gradient of the line drawn in part **b**?
  - e Find a rule linking  $d$  with  $t$ .
  - f Use your rule to find the distance from the buoy at the 2.5 minute mark.
  - g How long does it take for the distance to reduce to 3.5 km?



# 10

## Transformations and congruence

### Maths in context: The Eiffel tower

Geometrical transformations, triangle congruence and similarity are applied in architecture, animation and digital gaming, engineering, graphic design, robot algorithms, surveying and urban planning.

Animators and digital game creators need to create the illusion of 3D movement on a 2D screen. To do this, they apply geometrical translation, reflection, enlargement and rotation to move characters, change viewpoints, adjust aspect ratios, and alter light effects on digital scenery.

Architects, engineers and builders apply the geometry of triangles to design safe structures, as a triangle's two sloping sides halve a downward force and redirect it to a horizontal tension in the

triangle's base. Engineers create truss supports for bridges using a series of congruent triangles. Trusses provide stability and strength, symmetrically distributing a bridge's weight.

The Eiffel tower was constructed as the entrance arch to the 1889 World Fair in Paris. Its engineers utilised hundreds of triangles and parallelograms, with four massive arches at its base. The 330 m tall tower used over 7000 tonnes of iron, with millions of rivets joining over 18000 separate pieces, each accurate to 0.01 mm. Elevators that move inside the four 'legs' are today powered by underground hydraulic motors. It has around 7 million visitors annually, enjoying the views over Paris.



## Chapter contents

- 10A Reflection
- 10B Translation
- 10C Rotation
- 10D Congruent figures
- 10E Congruent triangles
- 10F Tessellations (EXTENDING)
- 10G Congruence and quadrilaterals (EXTENDING)
- 10H Similar figures
- 10I Similar triangles

## Victorian Curriculum 2.0

This chapter covers the following content descriptors in the Victorian Curriculum 2.0:

### SPACE

VC2M8SP01, VC2M8SP02, VC2M8SP04

### ALGEBRA

VC2M8A04

Please refer to the curriculum support documentation in the teacher resources for a full and comprehensive mapping of this chapter to the related curriculum content descriptors.

© VCAA

## Online resources

A host of additional online resources are included as part of your Interactive Textbook, including HOTmaths content, video demonstrations of all worked examples, auto-marked quizzes and much more.

## 10A Reflection

### LEARNING INTENTIONS

- To know the meaning of the terms: transformation, reflection, symmetry and image
- To understand that an object can be reflected over a line and that this is an isometric transformation (that is, the geometric properties are unchanged)
- To be able to draw the image of a point or shape that is reflected in a mirror line
- To understand that lines of symmetry are the mirror lines that reflect a shape directly onto itself

When an object is shifted from one position to another, rotated about a point, reflected over a line or enlarged by a scale factor, we say the object has been **transformed**. The names of these types of transformations are **reflection, translation, rotation, and dilation**.

The first three of these transformations are called **isometric transformations** because the object's geometric properties are unchanged and the transformed object will be congruent to the original object. The word 'isometric' comes from the Greek words *isos* meaning 'equal' and *metron* meaning 'measure'. Dilation (or enlargement) results in a change in the size of an object to produce a 'similar' figure and this will be studied later in this chapter. The first listed transformation, reflection, can be thought of as the creation of an image over a mirror line.



The transformation of lines and shapes occurs in architecture, engineering, surveying, physics, and urban and graphic design. To design these twin towers in Bahrain, architects reflected the first design across a vertical line, creating a mirror image.

### Lesson starter: Visualising the image

This activity could be done individually by hand on a page, in a group using a white board or using interactive geometry projected onto a white board.

- Draw any shape with straight sides.
- Draw a vertical or horizontal mirror line outside the shape.
- Try to draw the reflected image of the shape in the mirror line.
- If interactive geometry is used, reveal the precise image (the answer) using the Reflection tool to check your result.
- For a further challenge, redraw or drag the mirror line so it is not horizontal or vertical. Then try to draw the image.

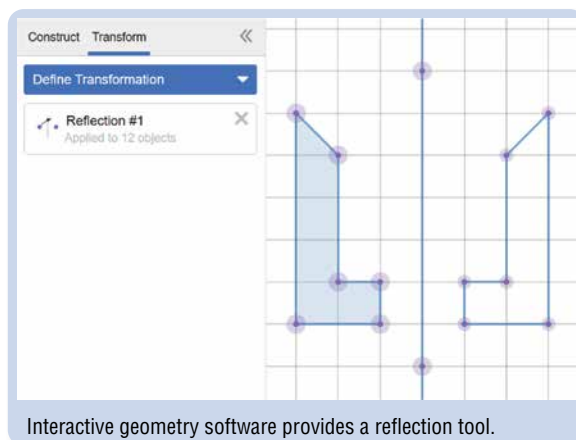

Interactive geometry software provides a reflection tool.

## KEY IDEAS

- **Reflection** is an **isometric transformation** in which the size of the object is unchanged.
- The **image** of a point  $A$  is denoted  $A'$ .
- Each point is reflected at right angles to the **mirror line**.
- The distance from a point  $A$  to the mirror line is equal to the distance from the image point  $A'$  to the mirror line.
- **Lines of symmetry** are mirror lines that result in an image being reflected onto itself. For example: A square has four lines of symmetry.
- When a point is reflected across the  $x$ -axis:
  - the  $x$ -coordinate remains unchanged
  - the  $y$ -coordinate undergoes a sign change.
 For example,  $(5, 3)$  becomes  $(5, -3)$ ; that is, the  $y$  values are equal in magnitude but opposite in sign.
- When a point is reflected across the  $y$ -axis:
  - the  $x$ -coordinate undergoes a sign change
  - the  $y$ -coordinate remains unchanged.
 For example,  $(5, 3)$  becomes  $(-5, 3)$ .

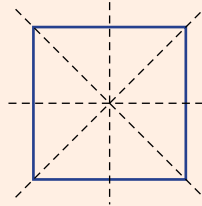
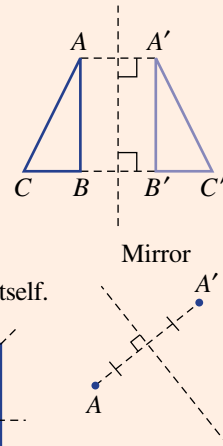

## BUILDING UNDERSTANDING

- 1 Use the grid to precisely reflect each shape in the given mirror line.

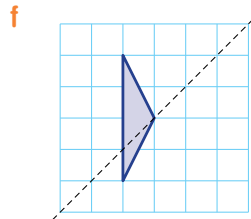
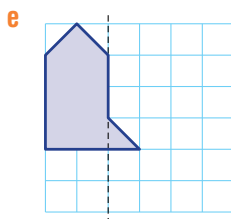
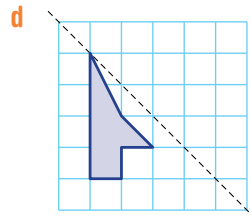
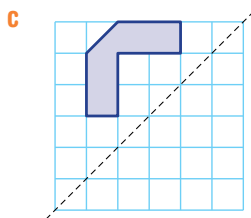
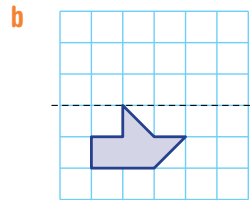
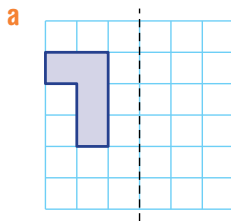



### Example 1 Drawing reflected images

Copy the diagram and draw the reflected image over the given mirror line.

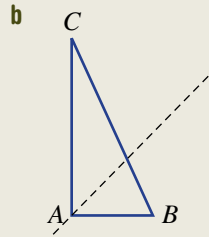
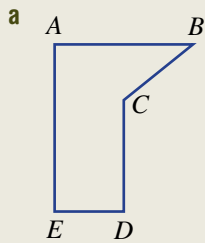

#### SOLUTION

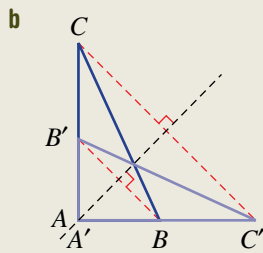
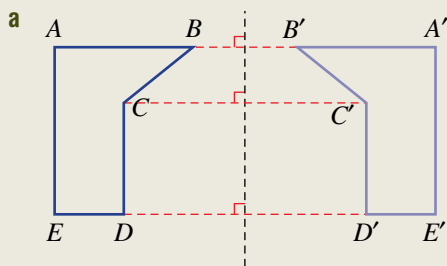

#### EXPLANATION

Reflect each vertex point at right angles to the mirror line. Each image vertex point is the same distance on the other side of the mirror. Join the image points to form the final image.

Reflect points  $A$ ,  $B$  and  $C$  at right angles to the mirror line to form  $A'$ ,  $B'$  and  $C'$ .

Note that  $A'$  is in the same position as  $A$  since it is on the mirror line. Join the image points to form the image triangle.

#### Now you try

Copy the diagram and draw the reflected image over the given mirror line.

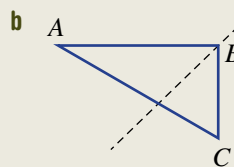
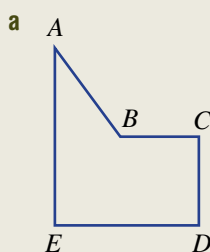



## Example 2 Using coordinates to draw reflections

State the coordinates of the vertices  $A'$ ,  $B'$  and  $C'$  after this triangle is reflected in the given axes.

- a**  $x$ -axis
- b**  $y$ -axis

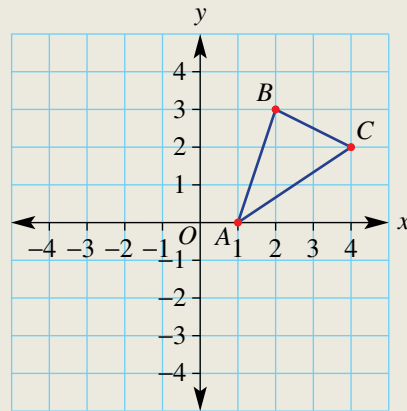

### SOLUTION

- a**  $A' = (1, 0)$   
 $B' = (2, -3)$   
 $C' = (4, -2)$
- b**  $A' = (-1, 0)$   
 $B' = (-2, 3)$   
 $C' = (-4, 2)$

### EXPLANATION

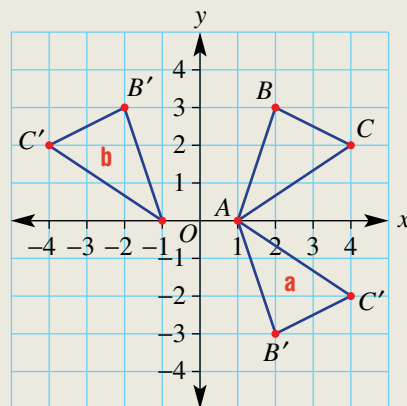

### Now you try

State the coordinates of the vertices  $A'$ ,  $B'$  and  $C'$  after this triangle is reflected in the given axes.

- a**  $x$ -axis
- b**  $y$ -axis

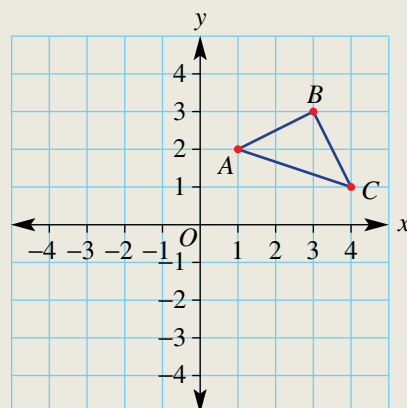

## Exercise 10A

### FLUENCY

1–5

2, 3, 4(1/2), 5, 6

3–4(1/2), 5, 6

Example 1a

1 Copy the diagram and draw the reflected image over the given mirror line.

a

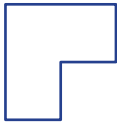

b

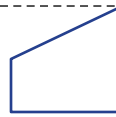

Example 1a

2 Copy the diagram and draw the reflected image over the given mirror line.

a



b

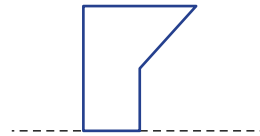

c

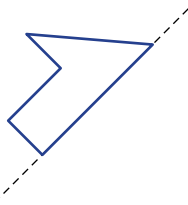

d

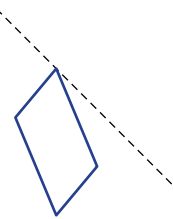

Example 1b

3 Copy the diagram and draw the reflected image over the given mirror line.

a

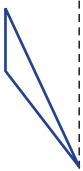

b

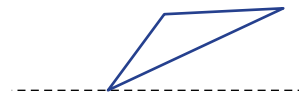

c

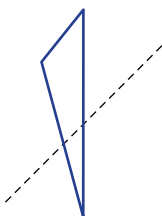

d

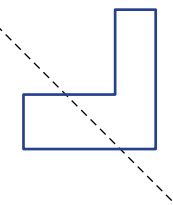



4 Copy the diagram and accurately locate and draw the mirror line.

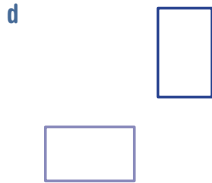
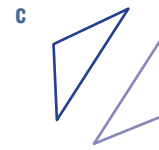
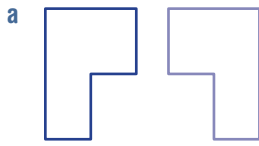

**Example 2** 5 State the coordinates of the vertices  $A'$ ,  $B'$  and  $C'$  after this triangle is reflected in the given axes.

- a  $x$ -axis
- b  $y$ -axis

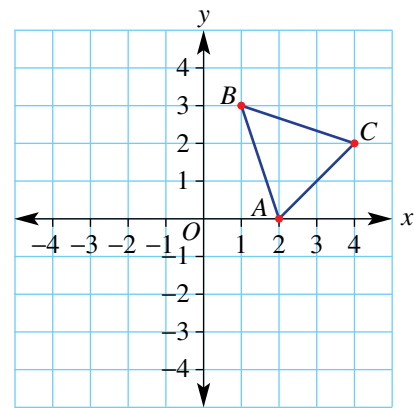

**Example 2** 6 State the coordinates of the vertices  $A'$ ,  $B'$ ,  $C'$  and  $D'$  after this rectangle is reflected in the given axes.

- a  $x$ -axis
- b  $y$ -axis

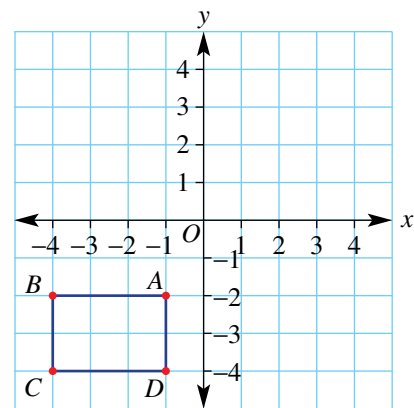

## PROBLEM-SOLVING

7

7, 8( $\frac{1}{2}$ )7, 8( $\frac{1}{2}$ )

7 How many lines of symmetry do these shapes have?

a Square



b Rectangle



c Rhombus



d Kite

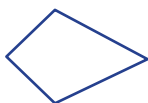

e Trapezium



f Parallelogram



g Isosceles triangle



h Equilateral triangle



i Regular octagon



8 A point  $(2, 4)$  is reflected in the given horizontal or vertical line. State the coordinates of the image point. As an example, the graph of the mirror lines  $x = 1$  and  $y = -2$  are shown here.

The mirror lines are:

a  $x = 1$

b  $x = 3$

c  $x = 0$

d  $x = -1$

e  $x = -4$

f  $x = -20$

g  $y = 3$

h  $y = -2$

i  $y = 0$

j  $y = 1$

k  $y = -5$

l  $y = -37$

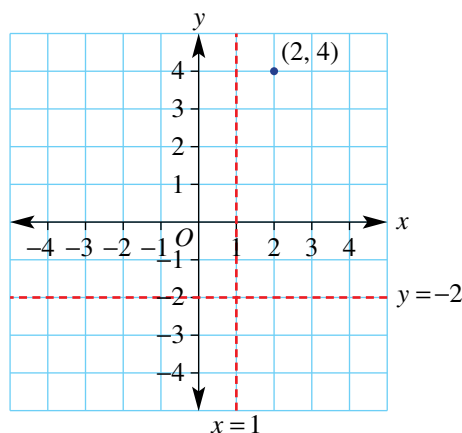

## REASONING

9, 11

9-11

11-13

- 9 A shape with area  $10\text{ m}^2$  is reflected in a line. What is the area of the image shape? Give a reason for your answer.
- 10 How many lines of symmetry does a regular polygon with  $n$  sides have? Write an expression.
- 11 A point is reflected in the  $x$ -axis then in the  $y$ -axis and finally in the  $x$ -axis again. What single reflection could replace all three reflections?

12 Two important lines of reflection on the coordinate plane are the line  $y = x$  and the line  $y = -x$  as shown.

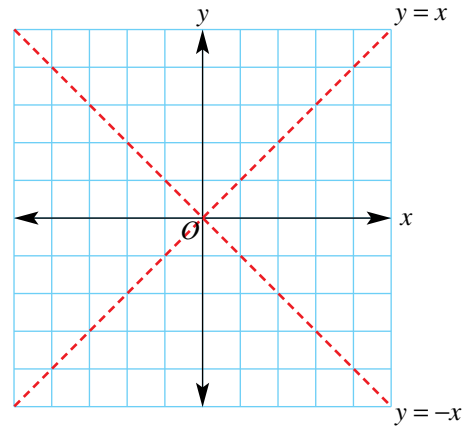

- a Draw the coordinate plane shown here. Draw a triangle with vertices  $A(-1, 1)$ ,  $B(-1, 3)$  and  $C(0, 3)$ . Then complete these reflections.
  - i Reflect triangle  $ABC$  in the  $y$ -axis.
  - ii Reflect triangle  $ABC$  in the  $x$ -axis.
  - iii Reflect triangle  $ABC$  in the line  $y = x$ .
  - iv Reflect triangle  $ABC$  in the line  $y = -x$ .
- b Draw a coordinate plane and a rectangle with vertices  $A(-2, 0)$ ,  $B(-1, 0)$ ,  $C(-1, -3)$  and  $D(-2, -3)$ . Then complete these reflections.
  - i Reflect rectangle  $ABCD$  in the  $y$ -axis.
  - ii Reflect rectangle  $ABCD$  in the  $x$ -axis.
  - iii Reflect rectangle  $ABCD$  in the line  $y = x$ .
  - iv Reflect rectangle  $ABCD$  in the line  $y = -x$ .

13 Some points are reflected in a mirror line but do not change position. Describe the position of these points in relation to the mirror line.

**ENRICHMENT: Reflection through a point**

14 Rather than completing a reflection in a line, it is possible to reflect an object through a point. An example of a reflection through point  $P$  is shown here.  $A$  goes to  $A'$ ,  $B$  goes to  $B'$  and  $C$  goes to  $C'$  all through  $P$ .

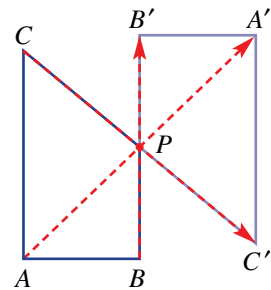

- a Draw and reflect these shapes through the point  $P$ .
  - i
  - ii
  - iii

b Like line symmetry, shapes can have point symmetry if they can be reflected onto themselves through a point. Decide if these shapes have any point symmetry.

- i
- ii
- iii

c How many special quadrilaterals can you name that have point symmetry?

## 10B Translation

### LEARNING INTENTIONS

- To understand that an object can be translated (moved) up, down, left or right
- To be able to determine the vector that moves a given point to its image
- To be able to draw the image of an object after it has been translated by a vector

Translation is a shift of every point on an object in a given direction and by the same distance. The direction and distance is best described by the use of a translation vector. This vector describes the overall direction using a horizontal component (for shifts left and right) and a vertical component (for shifts up and down). Negative numbers are used for translations to the left and down.

Designers of animated movies translate images in many of their scenes. Computer software is used and translation vectors help to define the specific movement of the objects and characters on the screen.



Surveyors map the precise placement of each house for legal ownership records. A certain house plan can be reflected or translated or rotated onto various blocks, making congruent houses, with matching sides and angles equal.

### Lesson starter: Which is further?

Consider this shape on the grid. The shape is translated by the vector  $(3, -2)$ , which moves it 3 to the right and down 2.

Now consider the shape being translated by these different vectors.

- a**  $(3, -3)$   
**c**  $(5, 0)$

- b**  $(-1, -4)$   
**d**  $(-2, 4)$

- By drawing and looking at the image from each translation, which vector do you think takes the shape furthest from its original position?
- Is there a way that you can calculate the exact distance? How?

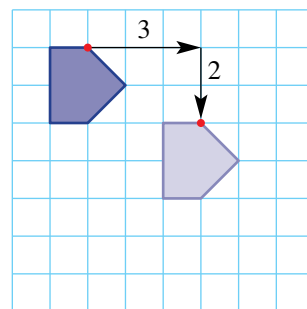

### KEY IDEAS

- **Translation** is an isometric transformation that involves a shift by a given distance in a given direction.
- A **vector**  $(x, y)$  is used to describe the distance and direction of a translation. For example:

Vector  $(2, -3)$   
  
 Right 2    Down 3

Vector  $(-1, 4)$   
  
 Left 1    Up 4

- If  $x$  is positive you shift to the right.
- If  $x$  is negative you shift to the left.
- If  $y$  is positive you shift up.
- If  $y$  is negative you shift down.

■ The image of a point  $A$  is denoted  $A'$ .

## BUILDING UNDERSTANDING

- Choose one of the words *left*, *right*, *up* or *down* to complete these sentences.
  - The vector  $(2, 4)$  means to move 2 units to the \_\_\_\_\_ and 4 units \_\_\_\_\_.
  - The vector  $(-5, 6)$  means to move 5 units to the \_\_\_\_\_ and 6 units \_\_\_\_\_.
  - The vector  $(3, -1)$  means to move 3 units to the \_\_\_\_\_ and 1 unit \_\_\_\_\_.
  - The vector  $(-10, -12)$  means to move 10 units to the \_\_\_\_\_ and 12 units \_\_\_\_\_.
- Give the vector  $(x, y)$  that describes these transformations.
  - 5 units to the right and 2 units down
  - 2 units to the left and 6 units down
  - 7 units to the left and 4 units up
  - 9 units to the right and 17 units up
- Decide if these vectors describe a vertical translation or a horizontal translation.
  - $(2, 0)$
  - $(0, 7)$
  - $(0, -4)$
  - $(-6, 0)$



### Example 3 Finding the translation vector

State the translation vector that moves the point  $A(-1, 3)$  to  $A'(2, 0)$ .

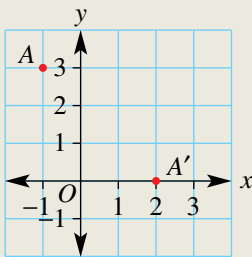

#### SOLUTION

$(3, -3)$

#### EXPLANATION

To shift  $A$  to  $A'$ , move 3 units to the right and 3 units down.

*Continued on next page*

**Now you try**

State the translation vector that moves the point  $A(1, 3)$  to  $A'(-2, 1)$ .

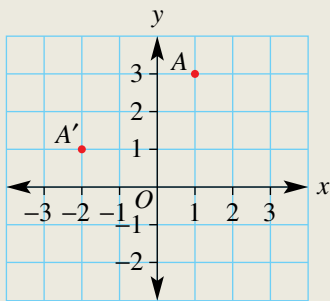
**Example 4 Drawing images using translation**

Draw the image of the triangle  $ABC$  after a translation by the vector  $(-3, 2)$ .

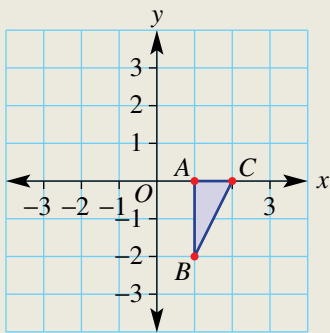
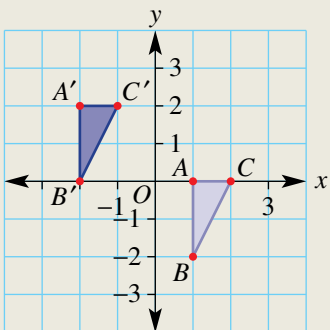
**SOLUTION****EXPLANATION**

First translate each vertex  $A$ ,  $B$  and  $C$ , 3 spaces to the left, and then 2 spaces up.

**Now you try**

Draw the image of the triangle  $ABC$  (shown in the Example above) after a translation by the vector  $(2, 1)$ .

# Exercise 10B

## FLUENCY

1, 2-3(1/2)

2-4(1/2)

2-4(1/3)

Example 3

1 State the translation vector that moves:

- a  $A$  to  $A'$
- b  $B$  to  $B'$

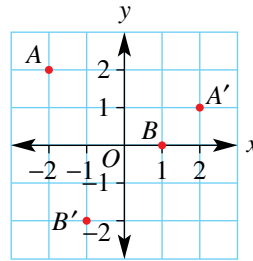

Example 3

2 Write the vector that takes each point to its image. Use a grid to help you.

- a  $A(2, 3)$  to  $A'(3, 2)$
- b  $B(1, 4)$  to  $B'(4, 3)$
- c  $C(-2, 4)$  to  $C'(0, 2)$
- d  $D(-3, 1)$  to  $D'(-1, -3)$
- e  $E(-2, -4)$  to  $E'(1, 3)$
- f  $F(1, -3)$  to  $F'(-2, 2)$
- g  $G(0, 3)$  to  $G'(2, 0)$
- h  $H(-3, 5)$  to  $H'(0, 0)$
- i  $I(5, 2)$  to  $I'(-15, 10)$

Example 4

3 Copy the diagrams and draw the image of the shapes translated by the given vectors.

- a Vector  $(2, 3)$
- b Vector  $(4, -2)$
- c Vector

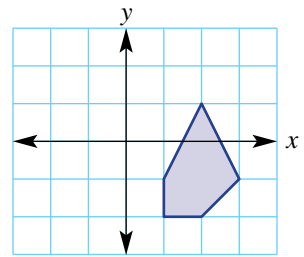
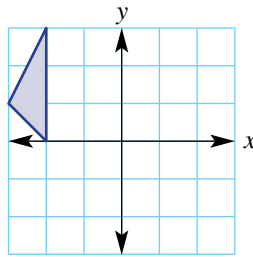
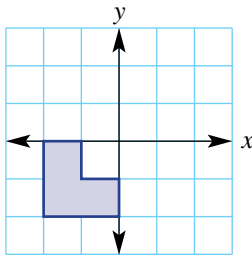

- d Vector  $(0, -3)$
- e Vector  $(-4, -1)$
- f Vector  $(-3, 0)$

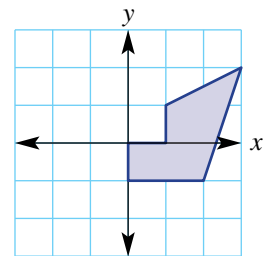
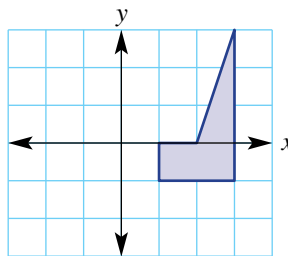
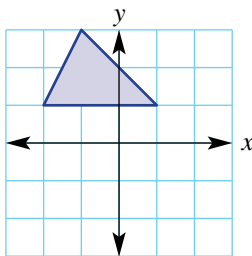

4 Write the coordinates of the image of the point  $A(13, -1)$  after a translation by the given vectors.

- a  $(2, 3)$
- b  $(8, 0)$
- c  $(0, 7)$
- d  $(-4, 3)$
- e  $(-2, -1)$
- f  $(-10, 5)$
- g  $(-2, -8)$
- h  $(6, -9)$
- i  $(12, -3)$
- j  $(-26, 14)$
- k  $(-4, 18)$
- l  $(-21, -38)$

## PROBLEM-SOLVING

5, 6

5, 6

6, 7

- 5 Which vector from each set takes an object the greatest distance from its original position? You may need to draw diagrams to help, but you should not need to calculate distances.
- a**  $(-1, 3), (0, 3), (7, 0)$                       **b**  $(-1, -4), (4, 0), (0, 3)$
- 6 A car makes its way around city streets following these vectors:  
 $(2, 3), (-5, 1), (3, -3)$  and  $(-2, -4)$
- a** What single vector would describe all these vectors combined?  
**b** What vector takes the car back to the origin  $(0, 0)$ , assuming it started at the origin?
- 7 A point undergoes the following multiple translations with these given vectors. State the value of  $x$  and  $y$  of the vector that would take the image back to its original position.
- a**  $(3, 4), (-1, -2), (x, y)$                       **b**  $(2, 5), (-7, 2), (-1, -3), (x, y)$   
**c**  $(0, 4), (7, 0), (-4, -6), (x, y)$                       **d**  $(-4, 20), (12, 0), (-36, 40), (x, y)$

## REASONING

8

8, 9

9, 10

- 8 A reverse vector takes a point in the reverse direction by the same distance. Write the reverse vectors of these vectors.
- a**  $(3, -2)$                       **b**  $(-5, 0)$                       **c**  $(x, y)$                       **d**  $(-x, -y)$
- 9 These translation vectors are performed on a shape in succession (one after the other). What is a single vector that would complete all transformations for each part in one go?
- a**  $(2, 1), (-3, -4), (0, 3)$                       **b**  $(6, 4), (6, -2), (-11, 0)$                       **c**  $(a, b), (c, -a), (-a, a - c)$
- 10 A rectangle  $ABCD$  has corners at  $A(-2, -4)$ ,  $B(-2, 7)$ ,  $C(3, 7)$  and  $D(3, -4)$ . It is translated right and up by a vector.
- a** If the translation vector is  $(4, 3)$ , then  $ABCD$  and  $A'B'C'D'$  have an overlapping rectangle with an area of  $8 \text{ units}^2$ . Show this rectangle on a diagram.  
**b** Explain why the overlapping area would be zero units if the translation vector is  $(6, 3)$ .  
**c** Find the smallest translation vector that would mean the overlapping area is  $0 \text{ units}^2$ .

## ENRICHMENT: How many options for the rabbit?

-

-

11



- 11 Hunters spot a rabbit on open ground and the rabbit has 1 second to find a hole before getting into big trouble with the hunter's gun. It can run a maximum of 5 metres in one second.
- a** Use Pythagoras' theorem to check that the distance  $x \text{ m}$  in this diagram is less than 5 m.  
**b** The rabbit runs a distance and direction described by the translation vector  $(-4, 3)$ . Is the rabbit in trouble?  
**c** The rabbit's initial position is  $(0, 0)$  and there are rabbit holes at every point that has integers as its coordinates, for example,  $(2, 3)$  and  $(-4, 1)$ . How many rabbit holes can it choose from to avoid the hunter before its 1 second is up? Draw a diagram to help illustrate your working.

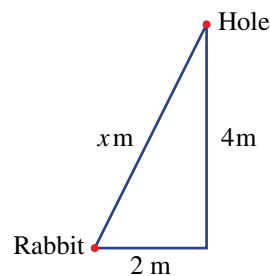



## 10C Rotation

### LEARNING INTENTIONS

- To understand that an object can be rotated about a given centre point by an angle in a clockwise or anticlockwise direction
- To understand that the order of rotational symmetry is the number of times that the shape's image will be an exact copy of the shape in a  $360^\circ$  rotation
- To be able to find the order of rotational symmetry of a given shape
- To be able to draw the result of a rotation

When the arm of a crane moves left, right, up or down, it undergoes a rotation about a fixed point. This type of movement is a transformation called a **rotation**. The pivot point on a crane represents the **centre of rotation** and all other points on the crane's arm move around this point by the same angle in a circular arc.

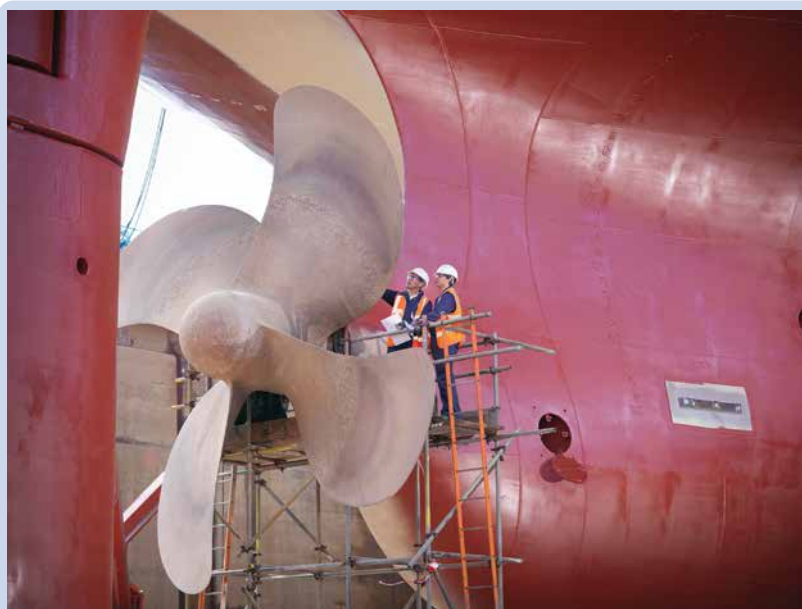

Marine engineers use rotation to design and build ship propellers. In a 4-blade propeller, each blade is rotated  $90^\circ$  about the centre, from adjacent blades. In operation, rotational forces cause the water to propel the ship forward.

### Lesson starter: Parallelogram centre of rotation

This activity will need a pencil, paper, ruler and scissors.

- Accurately draw a large parallelogram on a piece of paper and cut it out.
- Place the tip of a pencil at any point on the parallelogram and spin the shape around the pencil.
- At what position do you put the pencil tip to produce the largest circular arc?
- At what position do you put the pencil tip to produce the smallest circular arc?
- Can you rotate the shape by an angle of less than  $360^\circ$  so that it exactly covers the area of the shape in its original position? Where would you put the pencil to illustrate this?

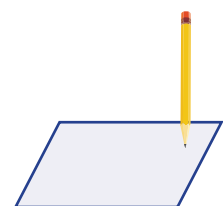

### KEY IDEAS

■ **Rotation** is an isometric transformation about a centre point and by a given angle.

■ An object can be rotated clockwise or anticlockwise .

■ Each point is rotated on a circular arc about the **centre of rotation C**.

For example: This diagram shows a  $90^\circ$  anticlockwise rotation about the point C.

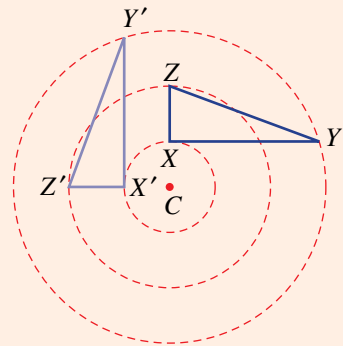

■ A shape has **rotational symmetry** if it can be rotated about a centre point to produce an exact copy covering the entire area of the original shape.

- The number of times the shape can make an exact copy in a  $360^\circ$  rotation is called the **order of rotational symmetry**. If the order of rotational symmetry is 1, then it is said that the shape has no rotational symmetry.

For example: This equilateral triangle has rotational symmetry of order 3.

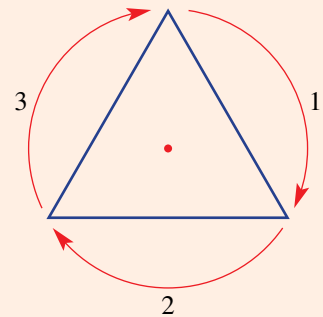

### BUILDING UNDERSTANDING

1 Point A has been rotated to its image point A'. For each part state whether the point has been rotated clockwise or anticlockwise and by how many degrees it has been rotated.

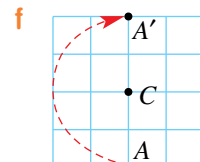
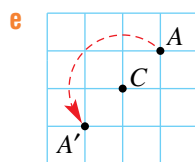
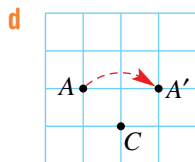
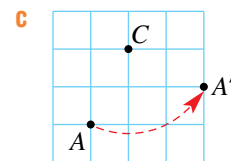
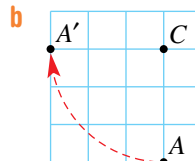
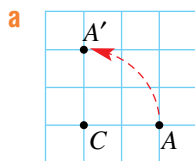

2 Give the missing angle to complete these sentences.

- a A rotation clockwise by  $90^\circ$  is the same as a rotation anticlockwise by \_\_\_\_\_.
- b A rotation anticlockwise by  $180^\circ$  is the same as a rotation clockwise by \_\_\_\_\_.
- c A rotation anticlockwise by \_\_\_\_\_ is the same as a rotation clockwise by  $58^\circ$ .
- d A rotation clockwise by \_\_\_\_\_ is the same as a rotation anticlockwise by  $296^\circ$ .



### Example 5 Finding the order of rotational symmetry

Find the order of rotational symmetry for these shapes.

a



b

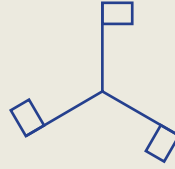

#### SOLUTION

a Order of rotational symmetry = 2

#### EXPLANATION

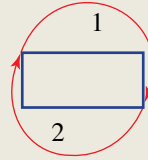

b Order of rotational symmetry = 3

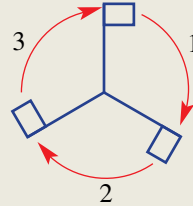

#### Now you try

Find the order of rotational symmetry for these shapes.

a

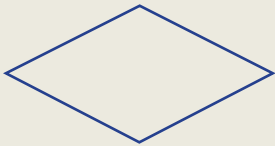

b

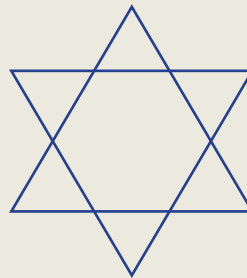



### Example 6 Drawing a rotated image

Rotate these shapes about the point  $C$  by the given angle and direction.

**a** Clockwise by  $90^\circ$

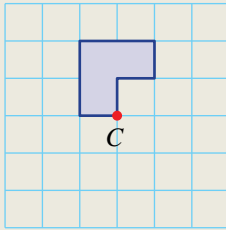

**b** Clockwise by  $180^\circ$

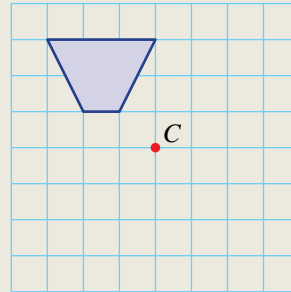

### SOLUTION

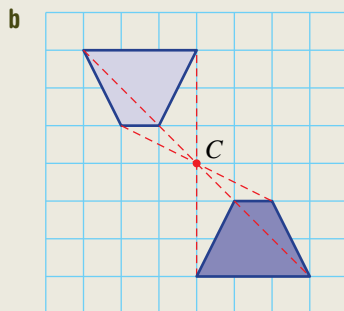
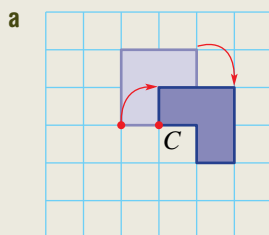

### EXPLANATION

Take each vertex point and rotate about  $C$  by  $90^\circ$ , but it may be easier to visualise a rotation of some of the sides first. Horizontal sides will rotate to vertical sides in the image and vertical sides will rotate to horizontal sides in the image.

You can draw a dashed line from each vertex through  $C$  to a point at an equal distance on the opposite side.

### Now you try

Rotate these shapes about the point  $C$  by the given angle and direction.

**a** Anticlockwise by  $90^\circ$

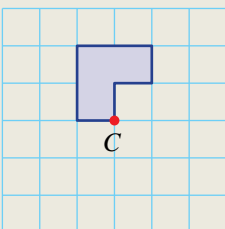

**b** Clockwise by  $180^\circ$

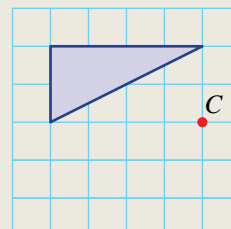

# Exercise 10C

## FLUENCY

1–4, 5(1/2)

2–3(1/2), 4, 5(1/2), 6

2–3(1/2), 4, 5(1/2), 6

Example 5

1 Find the order of rotational symmetry for these shapes.

a

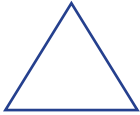

b



Example 5

2 Find the order of rotational symmetry for these shapes.

a



b



c

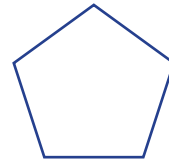

d

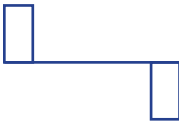

e

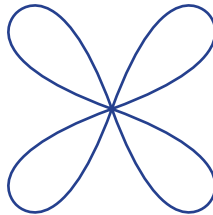

f

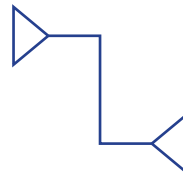

Example 6a

3 Rotate these shapes about the point  $C$  by the given angle and direction.

a Clockwise by  $90^\circ$

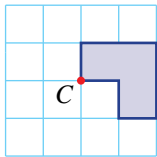

b Anticlockwise by  $90^\circ$

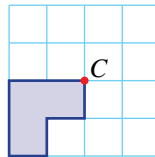

c Anticlockwise by  $180^\circ$

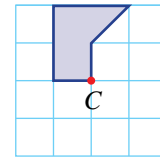

d Clockwise by  $90^\circ$

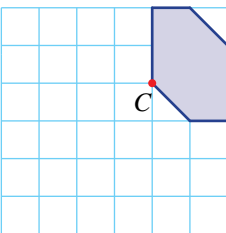

e Anticlockwise by  $180^\circ$

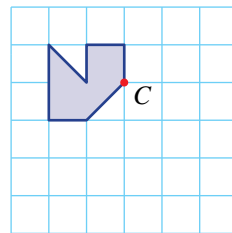

f Clockwise by  $180^\circ$

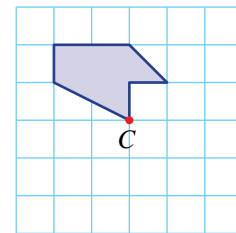

Example 6b

4 Rotate these shapes about the point  $C$  by the given angle and direction.

a Clockwise by  $90^\circ$

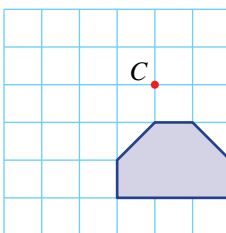

b Anticlockwise by  $90^\circ$

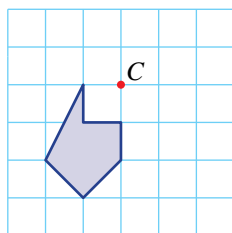

c Anticlockwise by  $180^\circ$

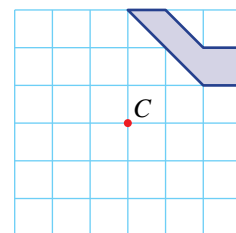

- 5 The point  $A(4, 3)$  is rotated about the origin  $C(0, 0)$  by the given angle and direction. Give the coordinates of  $A'$ .
- $180^\circ$  clockwise
  - $180^\circ$  anticlockwise
  - $90^\circ$  clockwise
  - $90^\circ$  anticlockwise
  - $270^\circ$  clockwise
  - $270^\circ$  anticlockwise
  - $360^\circ$  clockwise

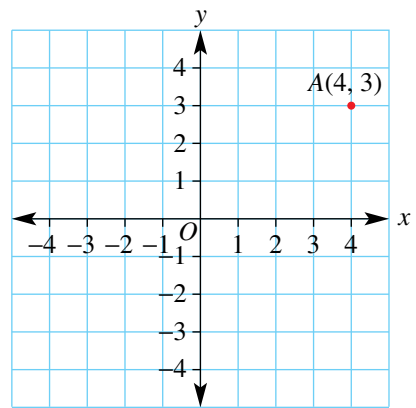

- 6 The triangle shown here is rotated about  $(0, 0)$  by the given angle and direction. Give the coordinates of the image points  $A'$ ,  $B'$  and  $C'$ .
- $180^\circ$  clockwise
  - $90^\circ$  clockwise
  - $90^\circ$  anticlockwise

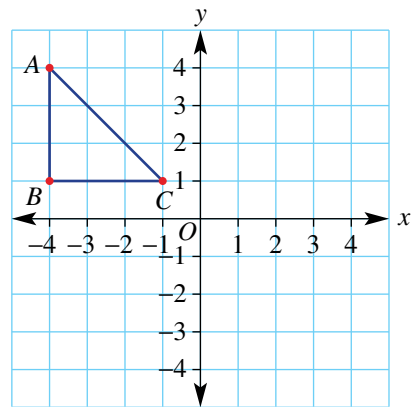

**PROBLEM-SOLVING** 7, 8      7, 8      8, 9

7 By how many degrees have these shapes been rotated?

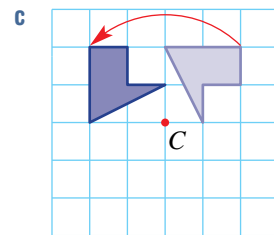
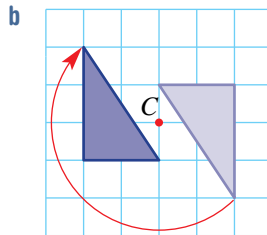
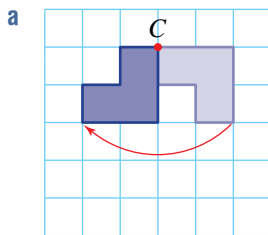

8 Which capital letters of the alphabet, as written below, have rotational symmetry of order 2 or more?

A B C D E F G H I J K L M N O P Q R S T U V W X Y Z

9 Draw an example of a shape that has these properties.

- Rotational symmetry of order 2 with no line symmetry
- Rotational symmetry of order 6 with 6 lines of symmetry
- Rotational symmetry of order 4 with no line symmetry

## REASONING

10

10, 11

11, 12

- 10 What value of  $x$  makes these sentences true?
- Rotating  $x$  degrees clockwise has the same effect as rotating  $x$  degrees anticlockwise.
  - Rotating  $x$  degrees clockwise has the same effect as rotating  $3x$  degrees anticlockwise.

- 11 When working without a grid or without  $90^\circ$  angles, a protractor and compasses are needed to accurately draw images under rotation. This example shows a rotation of  $120^\circ$  about  $C$ .

- a Copy this triangle with centre of rotation  $C$  onto a sheet of paper.

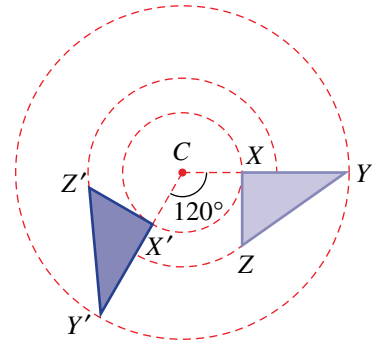
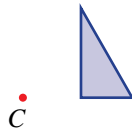

- b Construct three circles with centre  $C$  and passing through the vertices of the triangle.
- c Use a protractor to draw an image after these rotations.
- $120^\circ$  anticlockwise
  - $100^\circ$  clockwise

- 12 Make a copy of this diagram and rotate the shape anticlockwise by  $135^\circ$  around point  $C$ . You will need to use compasses and a protractor as shown in Question 11.

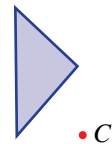

## ENRICHMENT: Finding the centre of rotation

-

-

13

- 13 Finding the centre of rotation if the angle is known involves the calculation of an angle inside an isosceles triangle. For the rotation shown, the angle of rotation is  $50^\circ$ . The steps are given:

- Calculate  $\angle CAA'$  and  $\angle CA'A$ . ( $2x + 50 = 180$ , so  $x = 65$ )
- Draw the angles  $\angle AA'C$  and  $\angle A'AC$  at  $65^\circ$  using a protractor.
- Locate the centre of rotation  $C$  at the point of intersection of  $AC$  and  $A'C$ .

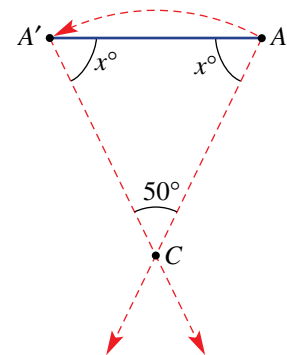

- On a sheet of paper, draw two points  $A$  and  $A'$  about 4 cm apart. Follow the steps above to locate the centre of rotation if the angle of rotation is  $40^\circ$ .
- Repeat part a using an angle of rotation of  $100^\circ$ .
- When a shape is rotated and the angle is unknown, there is a special method for accurately pinpointing the centre of rotation. Research this method and illustrate the procedure using an example.

## 10D Congruent figures

### LEARNING INTENTIONS

- To understand that two figures are congruent (have the same size and shape) if one can be transformed to the other using a combination of reflections, translations and rotations
- To be able to name corresponding pairs of vertices, sides and angles in congruent shapes

In mathematics, if two objects are identical we say they are congruent. If you ordered 10 copies of a poster from a printer, you would expect that the image on one poster would be congruent to the image on the next. Even if one poster was flipped over, shifted or rotated, you would still say the images on the posters were congruent.



Architects regularly use congruent shapes. This glass dome has congruent triangles and trapeziums; each shape could be rotated about the circle centre, or reflected over a circle radius, to exactly cover a congruent shape.

### Lesson starter: Are they congruent?

Here are two shapes. To be congruent they need to be exactly the same shape and size.



- Do you think they look congruent? Give reasons.
- What measurements could be taken to help establish whether or not they are congruent?
- Can you just measure lengths or do you need to measure angles as well? Discuss.

### KEY IDEAS

- A **figure** is a shape, diagram or illustration.
- Congruent figures** have the same size and shape. They also have the same area.

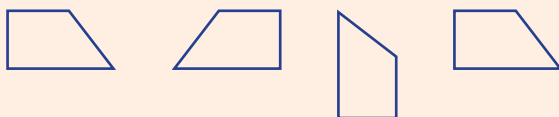

- The image of a figure that is reflected, translated or rotated is congruent to the original figure.



■ Corresponding (matching) parts of a figure have the same geometric properties.

- Vertex  $C$  corresponds to vertex  $E$ .
- Side  $AB$  corresponds to side  $FD$ .
- $\angle B$  corresponds to  $\angle D$ .

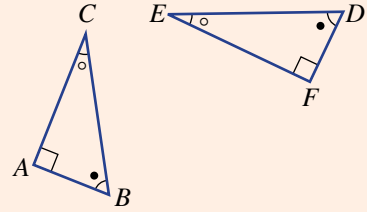

■ A congruence statement can be written using the symbol  $\equiv$ .

For example:  $\triangle ABC \equiv \triangle FDE$ .

- The symbol  $\cong$  can also be used for congruence.
- The symbol for triangle is  $\triangle$ .
- Vertices are usually listed in matching order.

■ Two circles are congruent if they have equal radii.

### BUILDING UNDERSTANDING

1 In this diagram,  $\triangle ABC$  has been reflected to give the image  $\triangle DEF$ .

a Is  $\triangle DEF$  congruent to  $\triangle ABC$ , i.e. is  $\triangle DEF \equiv \triangle ABC$ ?

b Name the vertex on  $\triangle DEF$  which corresponds to:

- i vertex  $A$
- ii vertex  $B$

c Name the side on  $\triangle DEF$  which corresponds to:

- i side  $AB$
- ii side  $BC$

d Name the angle in  $\triangle DEF$  which corresponds to:

- i  $\angle B$
- ii  $\angle C$

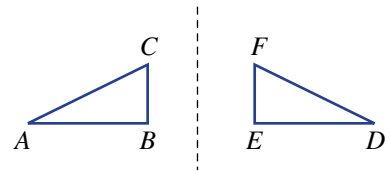

iii vertex  $C$ .

iii side  $AC$ .

iii  $\angle A$ .

2 In this diagram,  $\triangle ABC$  has been translated (shifted) to give the image  $\triangle DEF$ .

a Is  $\triangle DEF$  congruent to  $\triangle ABC$ , i.e. is  $\triangle DEF \equiv \triangle ABC$ ?

b Name the vertex on  $\triangle DEF$  which corresponds to:

- i vertex  $A$
- ii vertex  $B$

c Name the side on  $\triangle DEF$  which corresponds to:

- i side  $AB$
- ii side  $BC$

d Name the angle in  $\triangle DEF$  which corresponds to:

- i  $\angle B$
- ii  $\angle C$

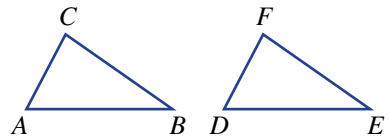

iii vertex  $C$ .

iii side  $AC$ .

iii  $\angle A$ .

3 In this diagram,  $\triangle ABC$  has been rotated to give the image  $\triangle DEF$ .

a Is  $\triangle DEF$  congruent to  $\triangle ABC$ , i.e. is  $\triangle DEF \equiv \triangle ABC$ ?

b Name the vertex on  $\triangle DEF$  which corresponds to:

- i vertex  $A$
- ii vertex  $B$

c Name the side on  $\triangle DEF$  which corresponds to:

- i side  $AB$
- ii side  $BC$

d Name the angle in  $\triangle DEF$  which corresponds to:

- i  $\angle B$
- ii  $\angle C$

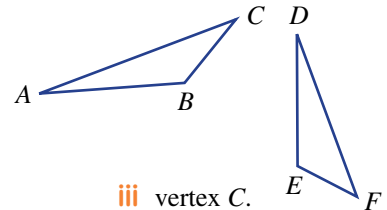

iii vertex  $C$ .

iii side  $AC$ .

iii  $\angle A$ .

**Example 7** Naming corresponding pairs in congruent shapes

These two quadrilaterals are congruent. Name the objects in quadrilateral  $EFGH$  that correspond to these objects in quadrilateral  $ABCD$ .

- a Vertex  $C$
- b Side  $AB$
- c  $\angle C$

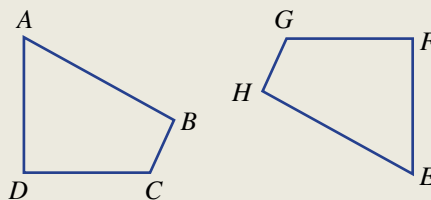
**SOLUTION**

- a Vertex  $G$
- b Side  $EH$
- c  $\angle G$

**EXPLANATION**

$C$  sits opposite  $A$  and  $\angle A$  is the smallest angle.  $G$  sits opposite  $E$  and  $\angle E$  is also the smallest angle.

Sides  $AB$  and  $EH$  are both the longest sides of their respective shapes.  $A$  corresponds to  $E$  and  $B$  corresponds to  $H$ .

$\angle C$  and  $\angle G$  are both the largest angles in their corresponding quadrilateral.

**Now you try**

These two quadrilaterals are congruent. Name the objects in quadrilateral  $EFGH$  that correspond to these objects in quadrilateral  $ABCD$ .

- a Vertex  $A$
- b Side  $BC$
- c  $\angle D$

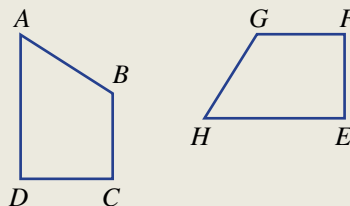
**Exercise 10D****FLUENCY**

1-3

2, 3

2, 3

Example 7

- 1 These two quadrilaterals are congruent. Name the object in quadrilateral  $EFGH$  which corresponds to these objects in quadrilateral  $ABCD$ .

- a i Vertex  $A$
- b i Side  $AD$
- c i  $\angle C$
- ii Vertex  $D$
- ii Side  $CD$
- ii  $\angle A$

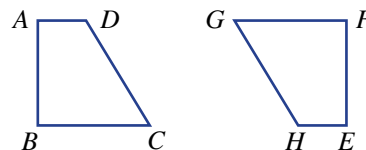

Example 7

2 These two pentagons are congruent. Name the object in pentagon  $FGHIJ$  which corresponds to these objects in pentagon  $ABCDE$ .

- |   |   |            |    |            |
|---|---|------------|----|------------|
| a | i | Vertex $A$ | ii | Vertex $D$ |
| b | i | Side $AE$  | ii | Side $CD$  |
| c | i | $\angle C$ | ii | $\angle E$ |

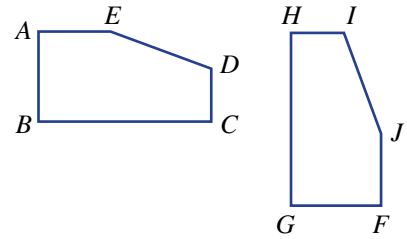

3 From all the shapes shown here, find three pairs that look congruent.

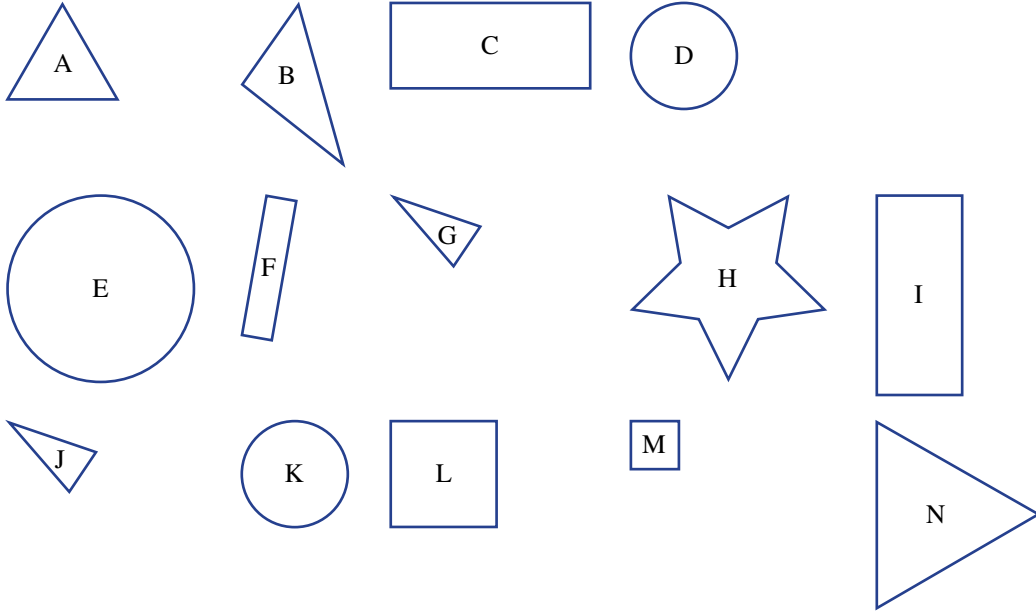

**PROBLEM-SOLVING** 4, 5 4, 5 5, 6

4 List the pairs of the triangles below that look congruent.

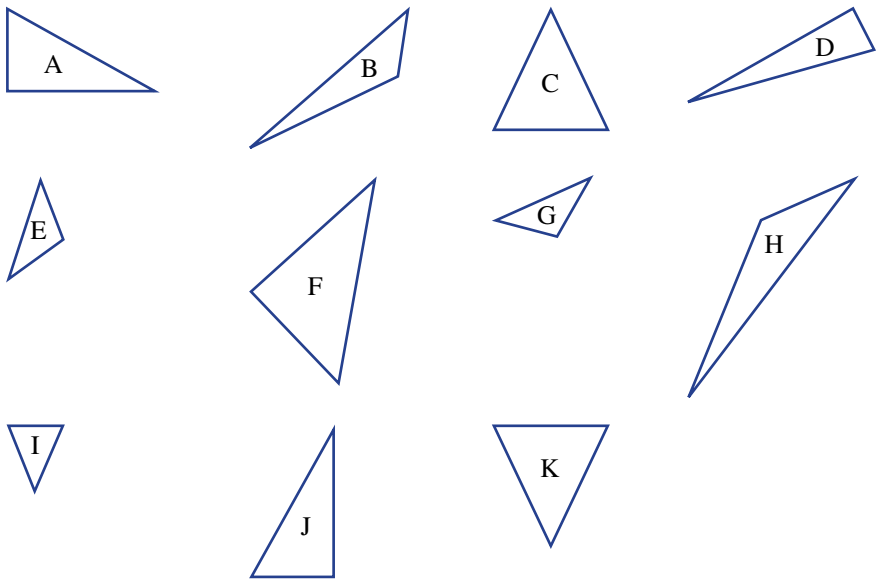

- 5 How many congruent triangles are there in this diagram with:  
 a area  $\frac{1}{2}$ ?                      b area 1?                      c area 2?  
 d area 4?                      e area 8?

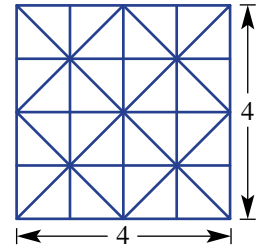

- 6 Write the pairs of corresponding vertices for these congruent shapes, e.g. (A, E), (B, D).

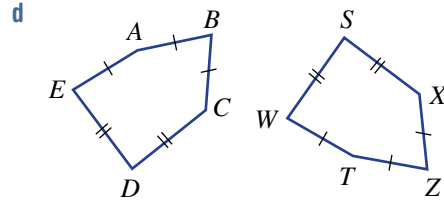
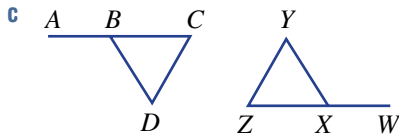
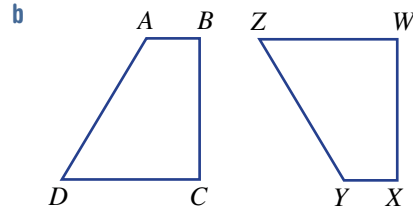
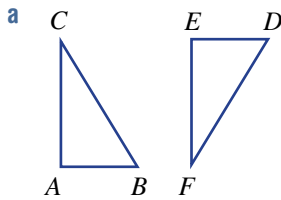

**REASONING**

7

7, 8

8, 9

- 7 An isosceles triangle is cut as shown, with  $M$  as the midpoint of  $AB$ .

- a Name the two triangles formed.  
 b Will the two triangles be congruent? Give reasons.

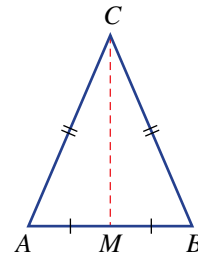

- 8 A kite  $ABCD$  has diagonals  $AC$  and  $BD$ .

- a The kite is cut using the diagonal  $BD$ .  
 i Name the two triangles formed.  
 ii Will the two triangles be congruent? Give reasons.  
 b The kite is cut using the diagonal  $AC$ .  
 i Name the two triangles formed.  
 ii Will the two triangles be congruent? Give reasons.

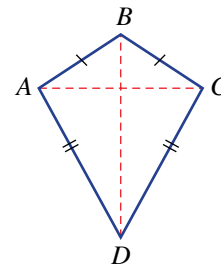

- 9 If a parallelogram  $ABCD$  is cut by the diagonal  $AC$  will the two triangles be congruent? Explain your answer.

## ENRICHMENT: Combining isometric transformations

-

-

10

- 10 Describe the combination of transformations (reflections, translations and/or rotations) that map each shape to its image under the given conditions. The reflections that are allowed include only those in the  $x$ - and  $y$ -axes, and rotations will use  $(0, 0)$  as its centre.
- $A$  to  $A'$  with a reflection and then a translation
  - $A$  to  $A'$  with a rotation and then a translation
  - $B$  to  $B'$  with a rotation and then a translation
  - $B$  to  $B'$  with two reflections and then a translation
  - $C$  to  $C'$  with two reflections and then a translation
  - $C$  to  $C'$  with a rotation and then a translation

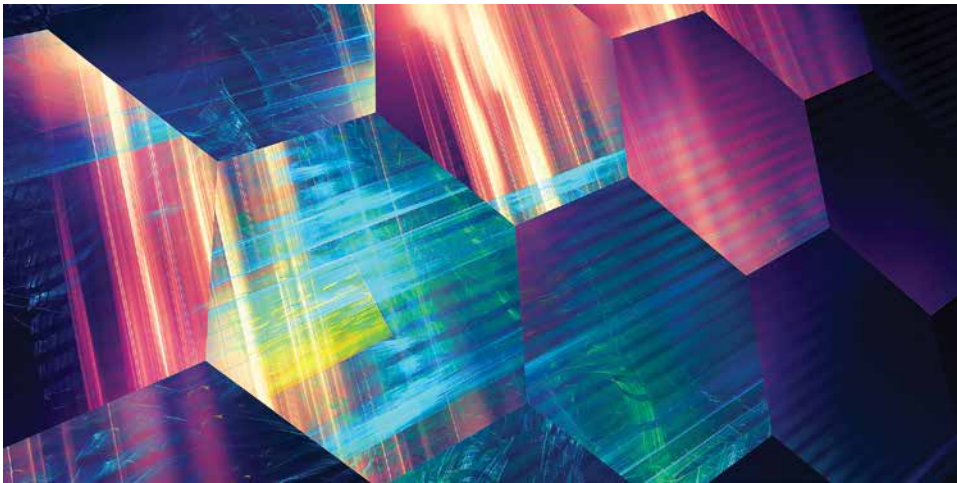
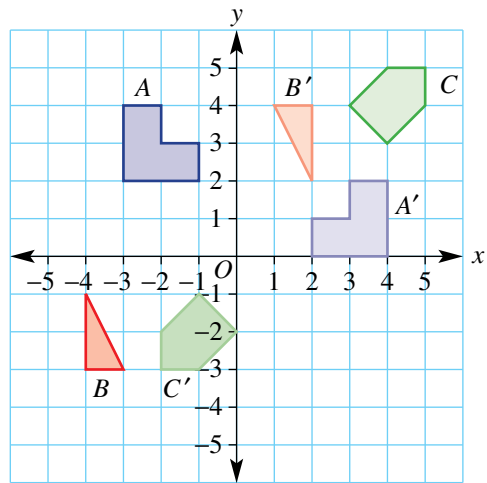

## 10E Congruent triangles

### LEARNING INTENTIONS

- To understand that determining whether triangles are congruent can be done using the congruence tests SSS, SAS, AAS and RHS
- To understand that a triangle based on a description is called unique if any two triangles matching the description are congruent
- To be able to determine which congruence test should be used to determine if two triangles are congruent
- To be able to construct a triangle from a description and decide if the result is unique

Imagine the sorts of design and engineering problems we would face if we could not guarantee that two objects such as window panes or roof truss frames were the same size or shape. Further, it might not be possible or practical to measure every length and angle to test for congruence. In the case of triangles, it is possible to consider only a number of pairs of sides or angles to test whether or not they are congruent.



Engineers use congruent triangles on truss bridges to achieve stability and strength by the symmetrical distribution of weight. The Tokyo Gate Bridge has pairs of congruent steel triangles supporting its central span.

### Lesson starter: How much information is enough?

Given one corresponding angle (say  $30^\circ$ ) and one corresponding equal side length (say 3 cm), it is clearly not enough information to say that two triangles are congruent. This is because more than one triangle can be drawn with the given information; that is, you cannot draw a unique triangle with this given information.

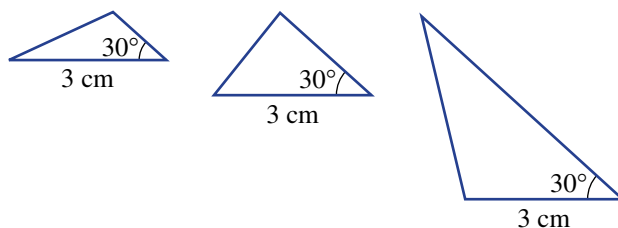

Decide if the following information is enough to determine if two triangles are congruent. If you can draw two non-identical triangles, then there is not enough information. If you can only draw one unique triangle, then you have the conditions for congruence.

- $\triangle ABC$  with  $AC = 4$  cm and  $\angle C = 40^\circ$
- $\triangle ABC$  with  $AB = 5$  cm and  $AC = 4$  cm
- $\triangle ABC$  with  $AB = 5$  cm,  $AC = 4$  cm and  $\angle = 45^\circ$
- $\triangle ABC$  with  $AB = 5$  cm,  $AC = 4$  cm and  $BC = 3$  cm
- $\triangle ABC$  with  $AB = 4$  cm,  $\angle A = 40^\circ$  and  $\angle B = 60^\circ$

### KEY IDEAS

Two triangles are congruent if one of these four sets of conditions is satisfied.

- **SSS**

3 equal corresponding sides.

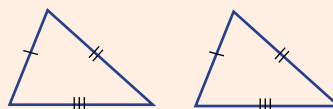

- **SAS**

2 equal corresponding sides and 1 equal corresponding angle between them.

This angle is called the **included angle**.

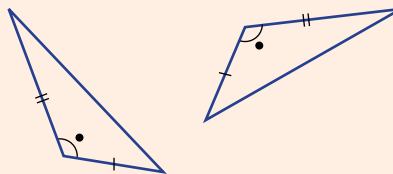

- **AAS**

2 equal corresponding angles and 1 equal corresponding side. Any order is accepted AAS, ASA, SAA.

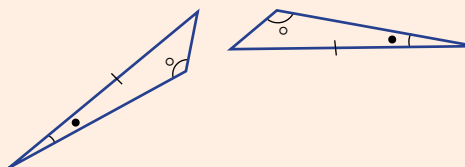

- **RHS**

2 right-angled triangles with equal hypotenuse lengths and 1 other pair of equal corresponding sides.

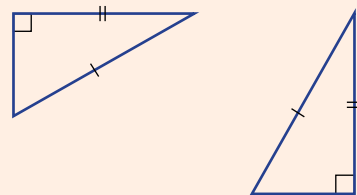

If triangle  $ABC$  is congruent to triangle  $DEF$ , we write  $\triangle ABC \equiv \triangle DEF$ .

- This is called a congruence statement.

- In a congruence statement, vertices are usually named in matching order

■ A **unique triangle** is one where any triangles matching the description are congruent to each other.

### BUILDING UNDERSTANDING

1 Pick the congruence test (SSS, SAS, AAS or RHS) that matches each pair of congruent triangles.

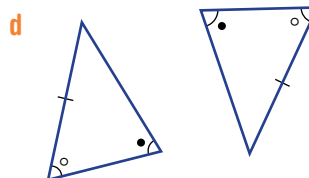
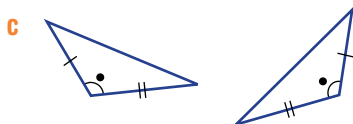
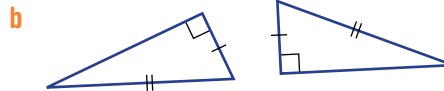
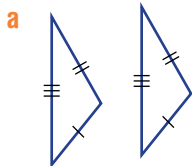

- 2 Give the congruence statement (e.g.  $\triangle ABC \equiv \triangle DEF$ ) for these pairs of congruent triangles. Try to match vertices by stating them in corresponding positions.

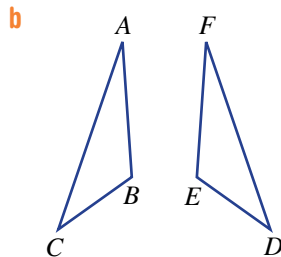
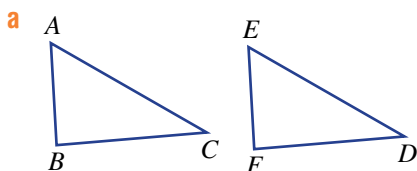

### Example 8 Deciding on a test for congruence

Which of the tests (SSS, SAS, AAS or RHS) would you choose to test the congruence of these pairs of triangles?

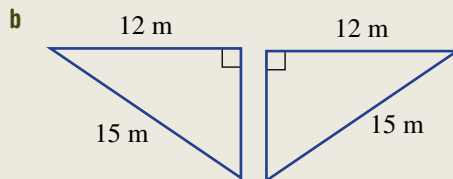
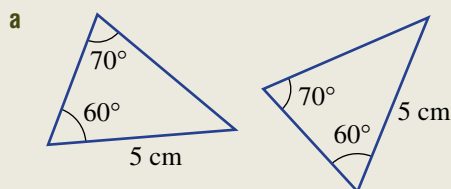

#### SOLUTION

a AAS

b RHS

#### EXPLANATION

There are two equal angles and 1 pair of equal corresponding sides. The side that is 5 cm is adjacent to the  $60^\circ$  angle on both triangles.

There is a pair of right angles with equal hypotenuse lengths. A second pair of corresponding sides are also of equal length.

#### Now you try

Which of the tests (SSS, SAS, AAS or RHS) would you choose to test the congruence of these pairs of triangles?

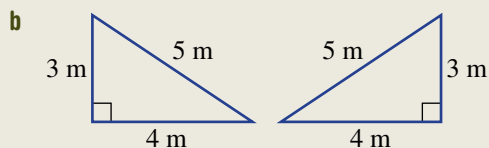
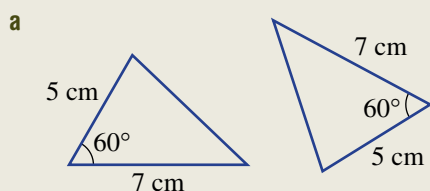





### Example 9 Constructing unique triangles

Use a ruler and a pair of compasses to construct these triangles. Decide if the triangle is unique and give a reason.

- a  $\triangle ABC$  with  $AB = 5$  cm,  $BC = 7$  cm and  $AC = 4$  cm  
 b  $\triangle DEF$  with  $\angle D = 70^\circ$ ,  $\angle E = 50^\circ$  and  $EF = 4$  cm

#### SOLUTION

a

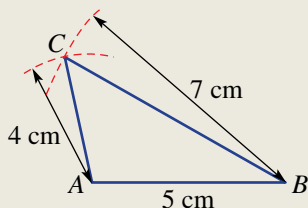

$\triangle ABC$  is unique (SSS)

b

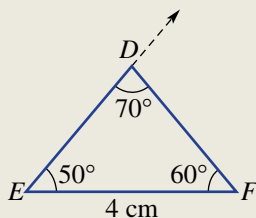

$\triangle DEF$  is unique (AAS)

#### EXPLANATION

Draw  $AB$  with length 5 cm. Construct two arcs with radii 4 cm and 7 cm centred at  $A$  and  $B$  respectively. Place point  $C$  at the intersection point of two arcs.

The triangle is unique since three sides are given (SSS).

Draw  $EF$  with length 4 cm and the ray  $ED$  so that  $\angle E = 50^\circ$  using a protractor. Calculate  $\angle F$  ( $180^\circ - 70^\circ - 50^\circ = 60^\circ$ ). Measure  $\angle F$  and draw in  $FD$ .

The triangle is unique since two angles and a side are given (AAS).

#### Now you try

Use a ruler and a pair of compasses to construct these triangles. Decide if the triangle is unique and give a reason.

- a  $\triangle ABC$  with  $AB = 6$  cm,  $\angle A = 45^\circ$ ,  $\angle B = 45^\circ$   
 b  $\triangle DEF$  with  $DE = 8$  cm,  $DF = 5$  cm,  $EF = 4$  cm

## Exercise 10E

### FLUENCY

1, 2,  $3(\frac{1}{2})$ , 4

2,  $3(\frac{1}{2})$ , 4

2,  $3-4(\frac{1}{2})$ , 5

Example 8

- 1 Which of the tests (SSS, SAS, AAS or RHS) would you choose to test the congruence of these pairs of triangles?

a

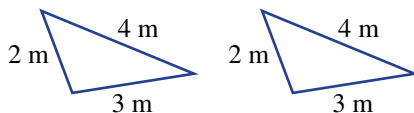

b

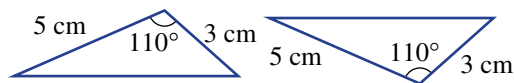

**Example 8** 2 Which of the tests (SSS, SAS, AAS or RHS) would you choose to test the congruence of these triangles?

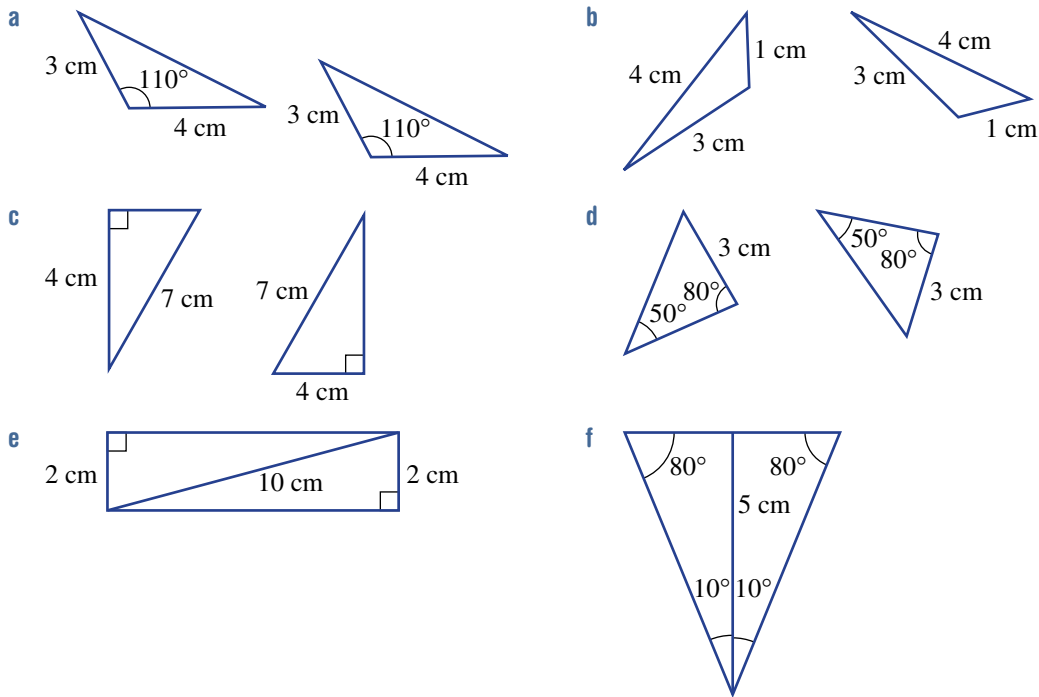

**Example 9** 3 For each of the following, state which test (SSS, SAS, AAS or RHS) can be used to show that the triangle is unique. Then construct it using either dynamic geometry software or a ruler and pair of compasses.

- a  $\triangle ABC$  with  $\angle A = 60^\circ$ ,  $AB = 5$  cm and  $\angle B = 40^\circ$
- b  $\triangle DEF$  with  $DE = 5$  cm,  $EF = 6$  cm and  $DF = 7$  cm
- c  $\triangle STU$  with  $\angle S = 90^\circ$ ,  $ST = 4$  cm and  $TU = 5$  cm
- d  $\triangle XYZ$  with  $XY = 6$  cm,  $\angle Y = 40^\circ$  and  $YZ = 4$  cm
- e  $\triangle ABC$  with  $AB = 4$  cm,  $BC = 6$  cm and  $AC = 3$  cm
- f  $\triangle STU$  with  $ST = 4$  cm,  $\angle S = 65^\circ$  and  $\angle T = 45^\circ$
- g  $\triangle PQR$  with  $PQ = 5$  cm,  $\angle P = 60^\circ$  and  $PR = 4$  cm
- h  $\triangle DEF$  with  $\angle D = 40^\circ$ ,  $\angle E = 60^\circ$  and  $EF = 5$  cm
- i  $\triangle ABC$  with  $\angle B = 55^\circ$ ,  $BC = 6$  cm and  $\angle A = 35^\circ$
- j  $\triangle ABC$  with  $\angle B = 90^\circ$ ,  $BC = 5$  cm and  $AC = 8$  cm

4 These pairs of triangles are congruent. Find the values of the pronumerals.

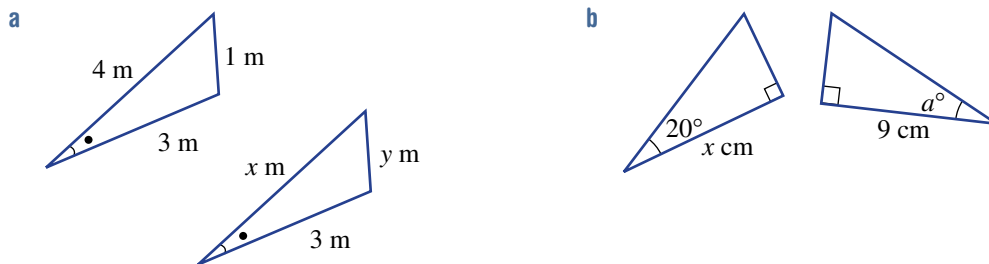

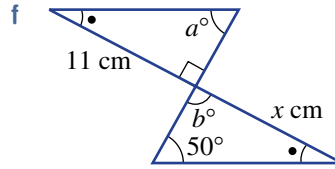
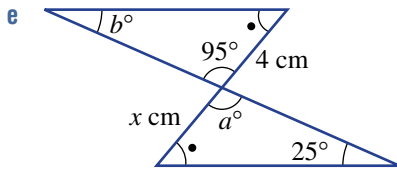
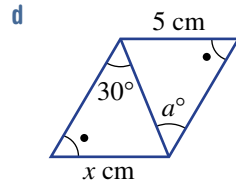
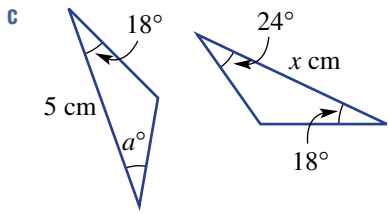

5 Decide if these pairs of triangles are congruent. If they are, give a reason.

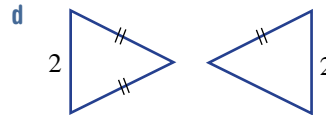
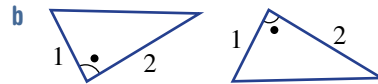
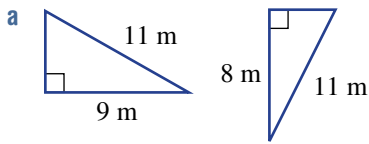

**PROBLEM-SOLVING**

6

6, 7

7, 8

6 Decide which piece of information from the given list needs to be added to the diagram if the two triangles are to be congruent.

$\angle B = 30^\circ$ ,  $\angle C = 20^\circ$ ,  $EF = 3\text{ m}$ ,  $FD = 3\text{ m}$ ,  $AB = 6\text{ cm}$ ,  $AC = 6\text{ cm}$ ,  $\angle C = 20^\circ$ ,  $\angle A = 20^\circ$

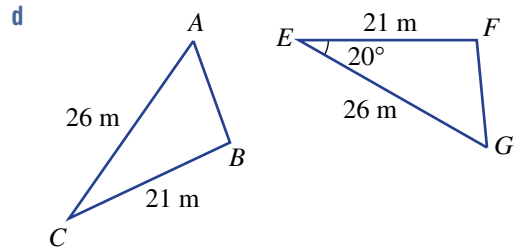
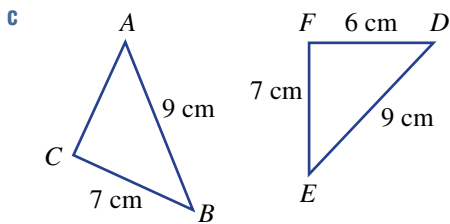
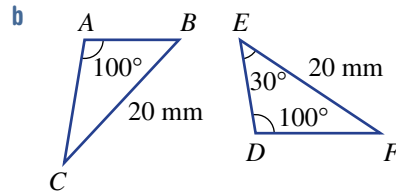
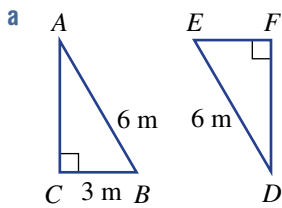

7 Decide if each pair of triangles is congruent. You may first need to use the angle sum of a triangle to help calculate some of the angles.

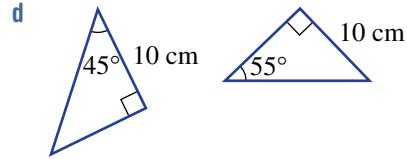
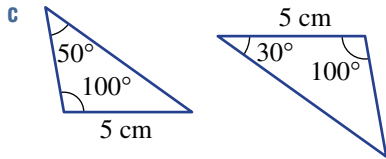
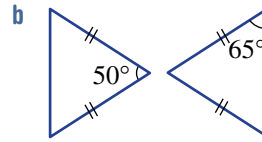
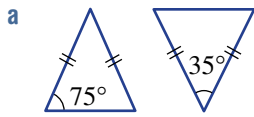

8 Two adjoining triangular regions of land have the dimensions shown. Use Pythagoras' theorem to help decide if the two regions of land are congruent.

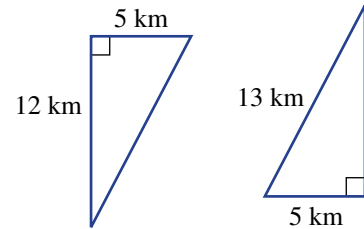

**REASONING** 9 9, 10 (1/2) 9, 10

9 a Explain why SSA is not a sufficient test to prove that two triangles are congruent. Draw diagrams to show your reasoning.

b Explain why AAA is not a sufficient test to prove that two triangles are congruent. Draw diagrams to show your reasoning.

10 Here is a suggested proof showing that the two triangles in this diagram are congruent.

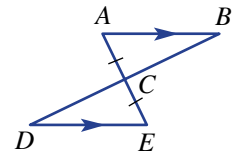

In  $\triangle ABC$  and  $\triangle EDC$ :  
 $\angle CAB = \angle CED$  (alternate angles in parallel lines)  
 $\angle ACB = \angle ECD$  (vertically opposite angles)  
 $AC = EC$  (given equal and corresponding sides)  
 $\triangle ABC \equiv \triangle EDC$  (AAS)

Write a proof (similar to the above) for these pairs of congruent triangles. Any of the four tests (SSS, SAS, AAS or RHS) may be used.

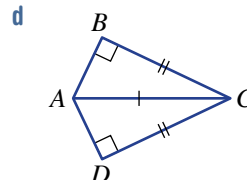
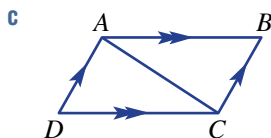
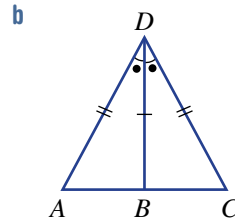
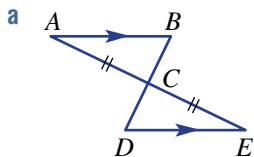

**ENRICHMENT: Proof challenge**      -      -      11

11 Write a logical set of reasons (proof) as to why the following are true. Refer to Question 10 for an example of how to set out a simple proof.

- a The segment joining the apex of an isosceles triangle to the midpoint  $M$  of the base  $BC$  is at right angles to the base, i.e. prove  $\angle AMB = \angle AMC = 90^\circ$ .

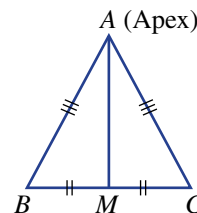

- b The segment  $AC = 2AB$  in this diagram.

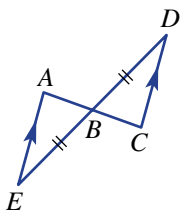

- c A kite has one pair of equal opposite angles.

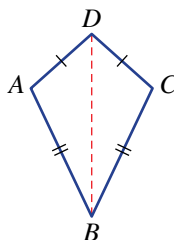

- d The diagonals of a rhombus intersect at right angles.

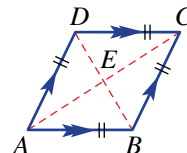

10A

- 1 Consider the triangle  $ABC$ .
- Copy the diagram and draw the reflected image using the  $y$ -axis as the mirror line.
  - State the coordinates of the vertices  $A'B'C'$  after the triangle is reflected in the  $x$ -axis.

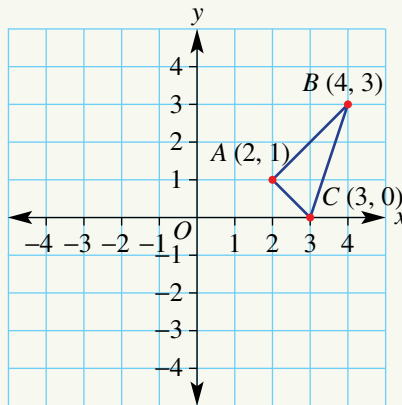

10B

- 2 State the translation vector that moves the point.
- $A(2, 1)$  to  $A'(5, 6)$
  - $B(-1, 0)$  to  $B'(3, -2)$

10B

- 3 Draw the image of the triangle  $ABC$  after a translation by the vector  $(-4, 1)$ .

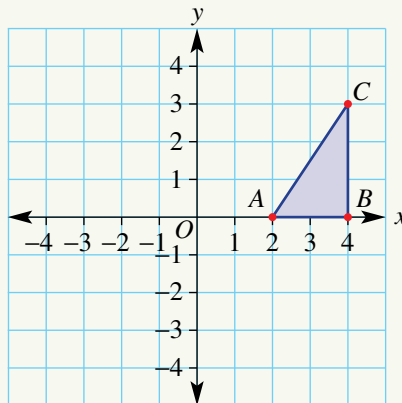

10C

- 4 State the order of rotational symmetry for the diagram below.

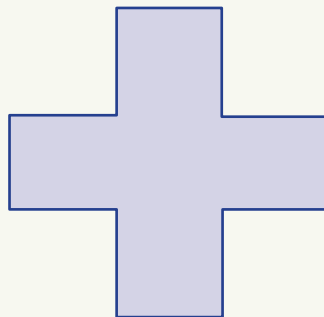

10C

5 Rotate the following shape clockwise  $90^\circ$  about the point  $O$ .

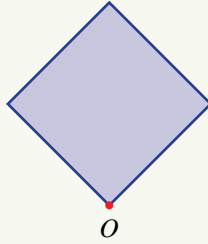

10C

6 Refer to the triangle in Question 3. Give the coordinates of  $A'$ ,  $B'$  and  $C'$  after the original triangle  $ABC$  has been rotated about the origin  $90^\circ$ , anticlockwise.

10D/E

7 Consider the triangles  $ABC$  and  $PQR$ .

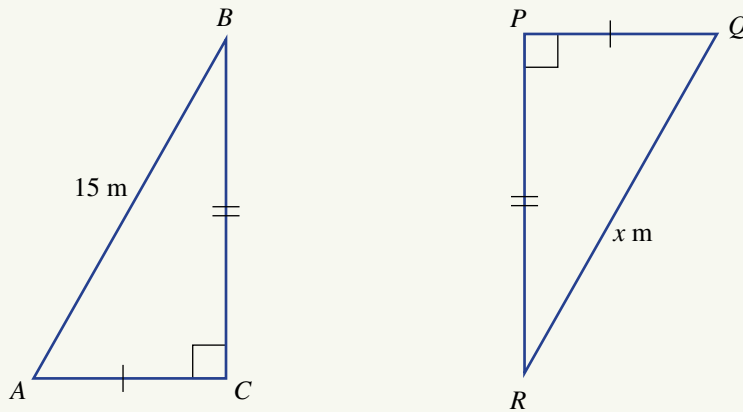

- a Which congruence test would you choose for this pair of triangles?
- b Write a congruence statement.
- c Which side of triangle  $PQR$  corresponds to the side  $AB$ ?
- d Which angle in triangle  $ABC$  corresponds to angle  $RPQ$ ?

10E

8 Explain why triangle  $ABE$  is congruent to triangle  $CBD$ .

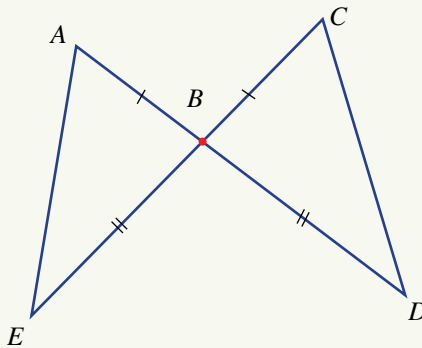

## 10F Tessellations EXTENDING

### LEARNING INTENTIONS

- To know the meaning of the terms tessellation, regular tessellation and semi-regular tessellation
- To be able to tessellate a basic shape
- To be able to name a regular or semi-regular tessellation based on a picture

Architects, builders and interior designers have great interest in arranging basic congruent shapes to create interesting patterns within a new home. These patterns are often formed using tiles or pavers and can be found on bathroom walls, interior floors or exterior courtyards.

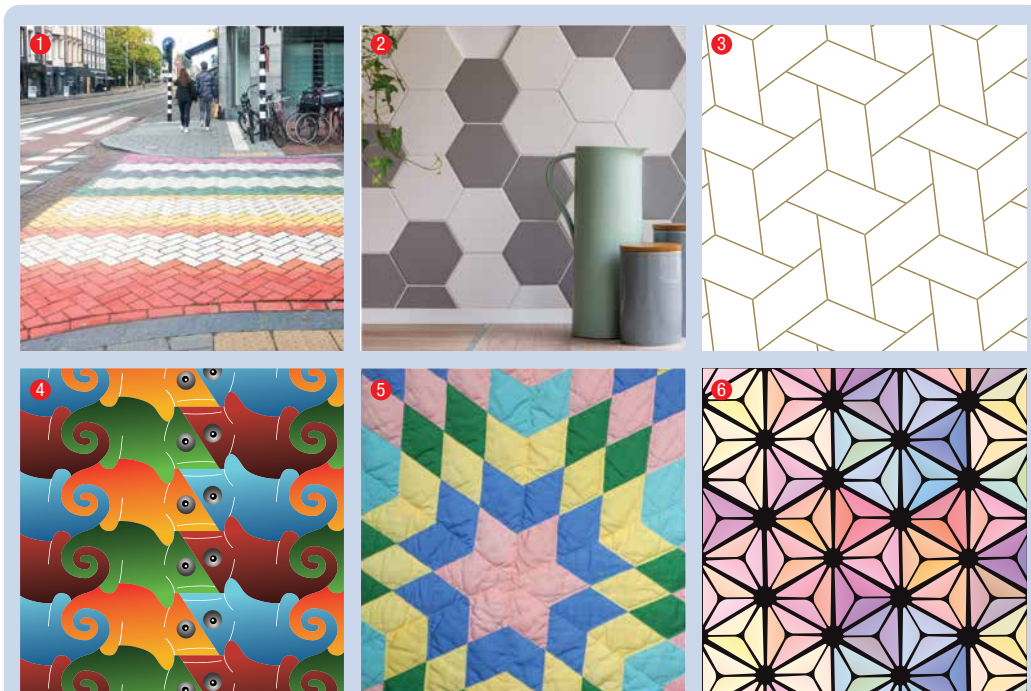

These tessellated patterns use many shapes including: (1) rectangular pavers on a pedestrian crossing; (2) hexagonal wall tiles; (3) parallelogram and hexagonal floor tiles; (4) chameleon lizards on curtain material; (5) quilt pattern of rhombuses; (6) triangular pieces of stained-glass.

The words *tessellate* and *tessellation* originate from the Latin noun, *tessera*, referring to a small tile used in the construction of a mosaic. Tessellated tile designs were commonly used throughout history in the fields of Art and Design and continue to be extensively employed today. It is most likely that various tessellations exist within your home and school.



## Lesson starter: To tessellate or not to tessellate?

In **Section 2E** you were introduced to the concept of *regular polygons* as shapes with sides of equal length and equal interior angles. Can you remember the name given to the first ten polygons?

Johann Kepler, back in 1619, was the first mathematician to prove that there are only three regular polygons that will tessellate by themselves. Working with a partner, can you determine which regular polygons these are?

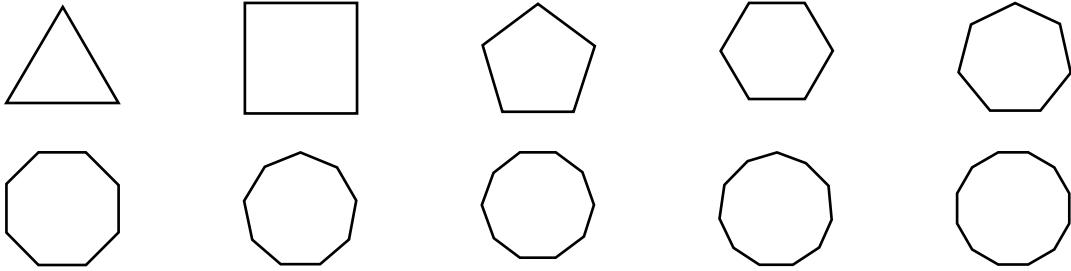

### KEY IDEAS

- A **tessellation** is a pattern made up of shapes that fit together without any gaps and without any overlaps.
- Isometric transformations, such as **reflections**, **translations** and **rotations**, are used with appropriate shapes to produce tessellated patterns.
- **Regular tessellations** are formed by arranging multiple copies of one regular polygon. There are only three regular polygons that tessellate by themselves: triangle, square and hexagon.
- **Semi-regular tessellations** are formed by arranging multiple copies of two or more regular polygons. There are eight distinct semi-regular tessellations.
- Regular and semi-regular tessellations can be **named** by counting the number of sides each regular polygon has at any of the identical vertices.  
For example: The semi-regular tessellation shown on the right consists of squares, hexagons and dodecagons. It can be named as a 4.6.4.12 tessellation.
- Other tessellated patterns can be formed by any combination of shapes (regular, irregular, composite). Curved shapes and images can also be used to form tessellated patterns, like the one shown.

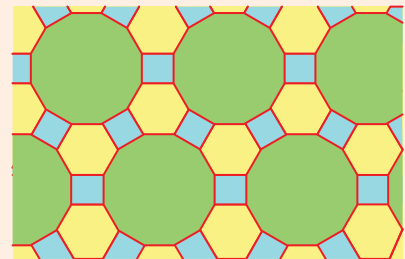

## BUILDING UNDERSTANDING

- Which of the following phrases best describes what a *tessellation* is?
  - A group of shapes joined together
  - A group of shapes all stacked on top of one another to form a totem pole
  - A group of shapes arranged together without any overlaps or any gaps
  - A group of shapes positioned in such a way as to form an attractive pattern
- Which of the following words best matches the mathematical term *congruence*?
  - Parallel
  - Similar
  - Related
  - Identical
- Provide a reason why the following pattern cannot be called a tessellation.

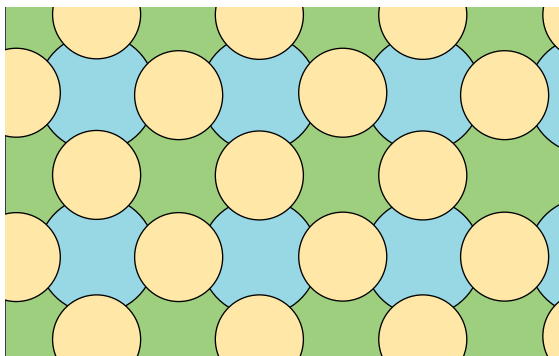

## Example 10 Tessellating shapes

Using the following 'plus sign' shape  draw ten identical plus signs to show that this shape will tessellate.

## SOLUTION

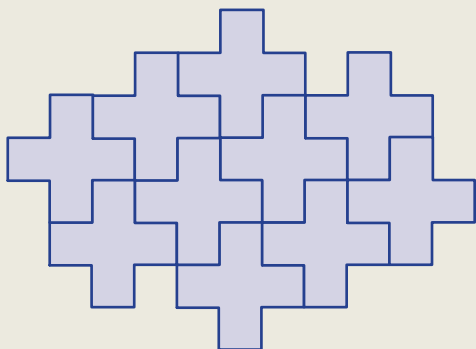

## EXPLANATION

Translate each identical plus sign to make sure it fits without leaving any gaps and without any overlaps.

Note that the final shape does not need to be a neat rectangle to be classified as a tessellation. The only requirement is that the pattern can continue to grow without leaving any holes.

## Now you try

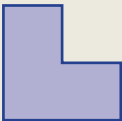
Using the following 'L' sign shape  draw eight identical L signs to show that this shape will tessellate.



### Example 11 Naming tessellations

By considering any vertex, name the following semi-regular tessellation.

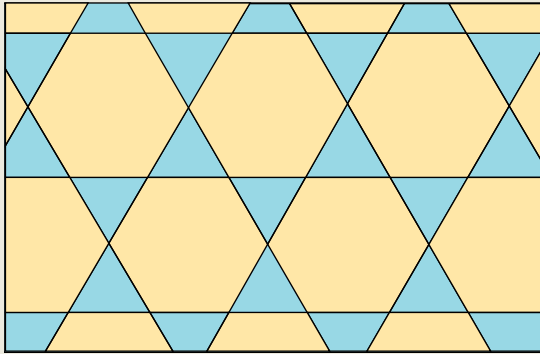

#### SOLUTION

3.6.3.6

#### EXPLANATION

Select any vertex and as you go around the vertex count the number of sides each polygon has.

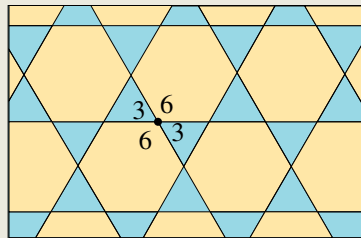

#### Now you try

By considering any vertex, name the following semi-regular tessellation.

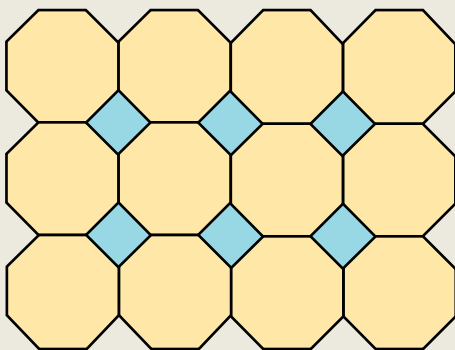

## Exercise 10F

### FLUENCY

1–5

2–6

2, 4–6

Example 10

- 1 Using the following trapezium shape  draw ten identical shapes to show that this trapezium will tessellate. You can translate, rotate or reflect this shape to form your tessellation.

Example 10

- 2 Draw regular tessellations using only:  
 a triangles                      b squares                      c hexagons.
- 3 Which of the following shapes tessellate by themselves? Reflections, rotations and translations of the original shape can be used.

a

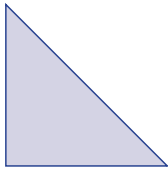

b

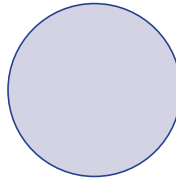

c

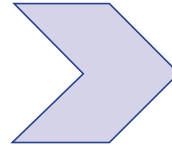

d

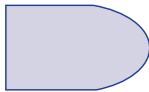

e



f



Example 11

- 4 By considering any vertex, name the following semi-regular tessellations.

a

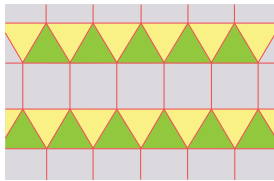

b

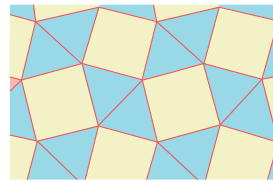

c

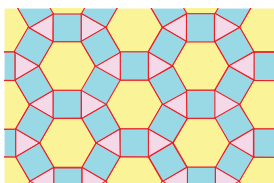

d

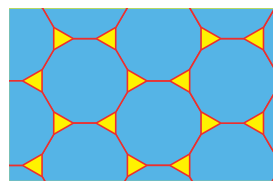

- 5 Design a tessellation using the following. Use rotations, reflections and translations if needed.

a Only the following shape.



b Only the following shape.

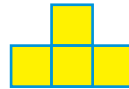

c Any combination of the above two shapes.

- 6 By looking at vertices, label each of the tessellations drawn in Question 2.

**PROBLEM-SOLVING**

7

7, 8

8, 9

- 7 A landscaper is required to pave an outside entertaining area with the dimensions 10 m × 12 m. She must use rectangular pavers measuring 25 cm × 50 cm.

- a How many pavers will be required to complete the job?  
 b Show the start of two possible tessellation patterns that could be used for the entertaining area.

- 8 Produce a tessellation using only regular octagons and squares.

- 9 a Shade in one unit shape within each of the following tessellations.

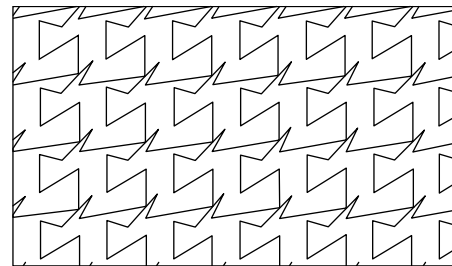
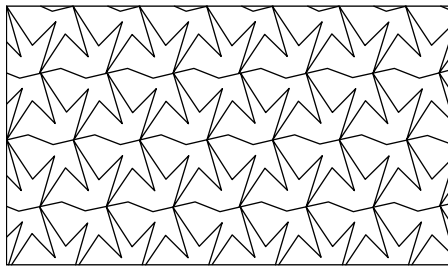

b Taking inspiration from the designs above, create your own irregular tessellation.

**REASONING**

10

10, 11

10–12

- 10 The object of the game *Tetris* is to produce rows with no gaps, or in other words to produce a tessellation with the tiles as they appear. Using 1 cm grid paper, draw a large rectangle of width = 10 cm and height = 20 cm.

The following image shows the seven different *Tetris* pieces, with each small cube representing a 1 cm × 1 cm square.

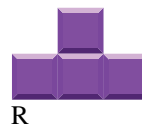
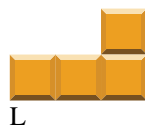
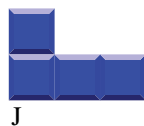
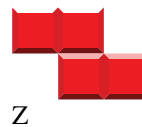
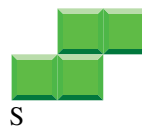

- a How many *Tetris* pieces will be needed to completely fill the 10 cm × 20 cm rectangle?  
 b Using at least three of each piece, design a tessellated pattern to fill the 10 cm × 20 cm rectangle.

- 11 Explain why a circle can or cannot be used within a tessellation.
- 12 Using your knowledge of the interior angle of regular polygons, the angle size of a revolution and the vertex naming technique of tessellations, justify why there are only three regular polygons which tessellate by themselves.

**ENRICHMENT: Ancient, modern or cutting edge tessellations**

-

-

13–15

**13 Ancient tessellations**

During the Middle Ages the Moorish people, particularly of Spain, were well known for their distinctive and elaborate tile designs. Several images are shown on the right.

- a Carry out research on Moorish tile designs and print two of your favourite tessellations.
- b Using grid paper, design your own intricate  $10 \times 10$  tile, consisting of a range of simple coloured shapes which tessellate and completely cover the tile.
- c Either by hand, or using appropriate geometry software, repeatedly draw your intricate tile to show how it tessellates and see how effective it looks as a design that could go in a modern home.



**14 Modern tessellations**

The Dutch artist M.C. Escher (1898–1972) is famous for making irregular tessellations involving repeated images which gradually change form. An example of Escher-like tessellation art is shown on the right.

- a Carry out research on M.C. Escher and print two of your favourite Escher designs.
- b Either by hand, or using appropriate geometry software, design your own irregular tessellation consisting of the one repeated image.

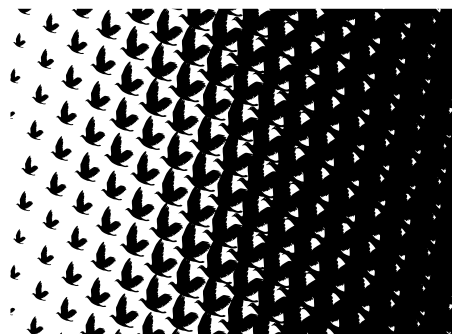

**15 Cutting-edge tessellations**

In 2015, Dr Casey Mann, Associate Professor of Mathematics at the University of Washington, and his colleagues discovered a new irregular pentagon which tessellates. Reportedly, it is only the fifteenth such pentagon ever found and was the first new tessellating pentagon to be found in thirty years.

The image shows a tessellation involving only the new irregular pentagon.

- a Carry out research on irregular pentagons which can tessellate by themselves.

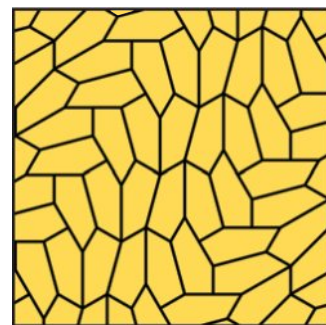

- b** Either by hand, or using appropriate geometry software, replicate the newly identified pentagon using the information provided below.

$$A = 60^\circ \quad D = 90^\circ \quad a = 1 \quad d = \frac{1}{2}$$

$$B = 135^\circ \quad E = 150^\circ \quad b = \frac{1}{2} \quad e = \frac{1}{2}$$

$$C = 105^\circ \quad c = \frac{1}{\sqrt{2}(\sqrt{3} - 1)}$$

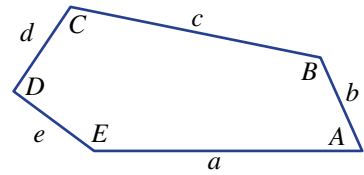

- c** Create a tessellation using only the newly identified pentagon.
- d** An even newer tessellation was discovered in 2023 involving a 13-sided polygon. Research this tessellation to find out why it was considered a ground breaking discovery.



## 10G Congruence and quadrilaterals EXTENDING

### LEARNING INTENTIONS

- To understand that properties of special quadrilaterals (e.g. kites, parallelograms) can be proved using congruent triangles
- To be able to prove properties of special quadrilaterals using facts about congruent triangles

The properties of special quadrilaterals, including the parallelogram, rhombus, rectangle, square, trapezium and kite, can be examined more closely using congruence. By drawing the diagonals and using the tests for the congruence of triangles, we can prove many of the properties of these special quadrilaterals.

### Lesson starter: Do the diagonals bisect each other?

Here is a parallelogram with two pairs of parallel sides. Let's assume also that opposite sides are equal (a basic property of a parallelogram which we prove later in this exercise).

- First locate  $\triangle ABE$  and  $\triangle CDE$ .
- What can be said about the angles  $\angle BAE$  and  $\angle DCE$ ?
- What can be said about the angles  $\angle ABE$  and  $\angle CDE$ ?
- What can be said about the sides  $AB$  and  $DC$ ?
- Now what can be said about  $\angle ABE$  and  $\angle CDE$ ? Discuss the reasons.
- What does this tell us about where the diagonals intersect? Do they **bisect** each other and why? (To bisect means to cut in half.)

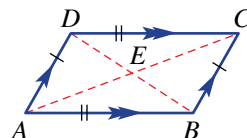

### KEY IDEAS

This is a summary of the properties of the special quadrilaterals.

- Kite:** A quadrilateral with two pairs of adjacent sides equal
  - Two pairs of adjacent sides of a kite are equal
  - One diagonal of a kite bisects the other diagonal
  - One diagonal of a kite bisects the opposite angles
  - The diagonals of a kite are perpendicular
- Trapezium:** A quadrilateral with at least one pair of parallel sides
  - At least one pair of sides of a trapezium are parallel
- Parallelogram:** A quadrilateral with both pairs of opposite sides parallel
  - The opposite sides of a parallelogram are parallel
  - The opposite sides of a parallelogram are equal
  - The opposite angles of a parallelogram are equal
  - The diagonals of a parallelogram bisect each other

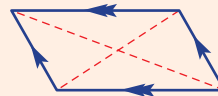
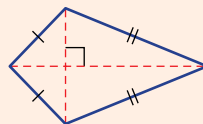



■ Rhombus: A parallelogram with all sides equal in length

- The opposite sides of a rhombus are parallel
- All sides of a rhombus are equal
- The opposite angles of a rhombus are equal
- The diagonals of a rhombus bisect the angles
- The diagonals of a rhombus bisect each other
- The diagonals of a rhombus are perpendicular

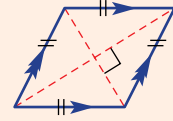

■ Rectangle: A parallelogram with a right angle

- The opposite sides of a rectangle are parallel
- The opposite sides of a rectangle are equal
- All angles at the vertices of a rectangle are  $90^\circ$
- The diagonals of a rectangle are equal
- The diagonals of a rectangle bisect each other

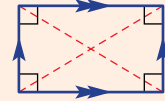

■ Square: A rectangle with two adjacent sides equal

- Opposite sides of a square are parallel
- All sides of a square are equal
- All angles at the vertices of a square are  $90^\circ$
- The diagonals of a square bisect the vertex angles
- The diagonals of a square bisect each other
- The diagonals of a square are perpendicular

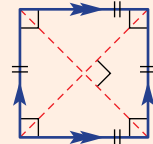

**BUILDING UNDERSTANDING**

1 Give the reason why the two marked angles are equal.

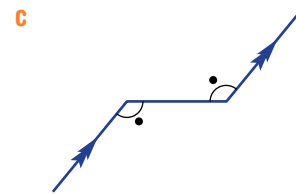
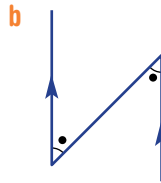
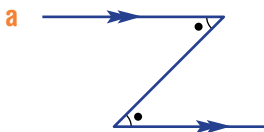

2 Give the reason why the two marked angles add to  $180^\circ$  and then state the value of  $a$ .

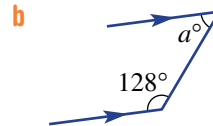
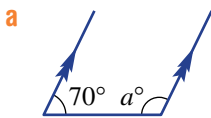

3 SSS is one test for congruence of triangles. State the other three.

4 Name the side (e.g.  $AB$ ) that is common to both triangles in each diagram.

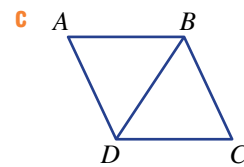
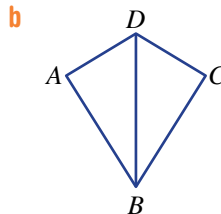
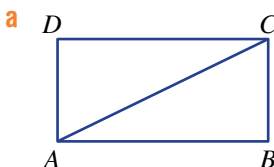



### Example 12 Proving properties of special quadrilaterals using congruent triangles

Prove that the diagonals of a parallelogram bisect each other and give reasons.

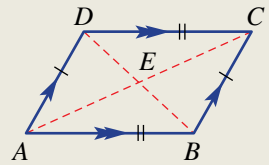

#### SOLUTION

$\angle BAE = \angle DCE$  (alternate angles in parallel lines)

$\angle ABE = \angle CDE$  (alternate angles in parallel lines)

$AB = CD$  (given equal side lengths)

$\therefore \triangle ABE = \triangle CDE$  (AAS)

$\therefore BE = DE$  and  $AE = CE$

$\therefore$  Diagonals bisect each other.

#### EXPLANATION

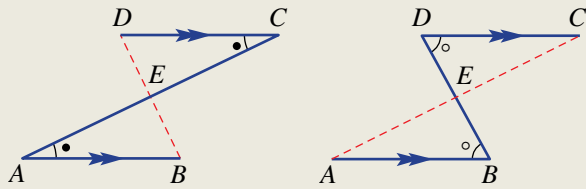

The two triangles are congruent using the AAS test. Since  $\triangle ABE$  and  $\triangle CDE$  are congruent, the corresponding sides are equal.

#### Now you try

Prove that in a kite there is a pair of angles that have the same size ( $\angle B$  and  $\angle D$  in the diagram). Start by drawing  $AC$  on your diagram.

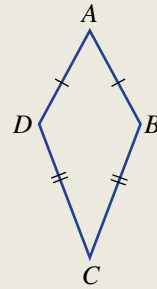

## Exercise 10G

### FLUENCY

1–3

2–4

2–4

Example 12

- 1 Prove (as in **Example 12**) that the diagonals in a square  $EFGH$  bisect each other.

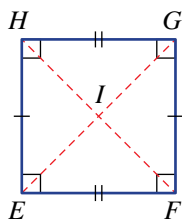

**Example 12** 2 Prove by giving reasons that the diagonals in a parallelogram bisect each other. You may assume here that opposite sides are equal, so use  $AB = CD$ . Complete the proof by following these steps.

Step 1: List the pairs of equal angles in  $\triangle ABE$  and  $\triangle CDE$  giving reasons why they are equal.

Step 2: List the pairs of equal sides in  $\triangle ABE$  and  $\triangle CDE$  giving reasons why they are equal.

Step 3: Write  $\triangle ABE \equiv \triangle CDE$  and give the reason SSS, SAS, AAS or RHS.

Step 4: State that  $BE = DE$  and  $AE = CE$  and give a reason.

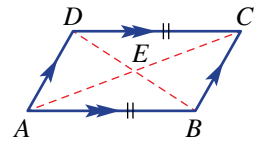

3 Which of the four tests for congruence of triangles would be used to prove that the triangles in each pair are congruent?

a

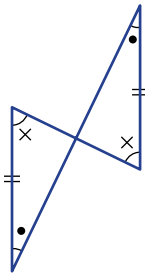

b

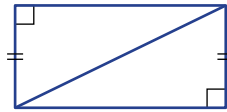

c

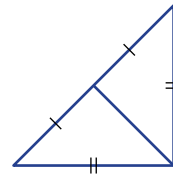

d

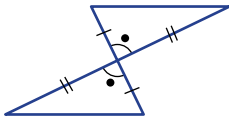

e

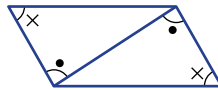

f

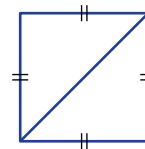

4 A parallelogram  $ABCD$  has two pairs of parallel sides.

- What can be said about  $\angle ABD$  and  $\angle CDB$ ? Give a reason.
- What can be said about  $\angle BDA$  and  $\angle DBC$ ? Give a reason.
- Which side is common to both  $\triangle ABD$  and  $\triangle CDB$ ?
- Which congruence test would be used to show that  $\triangle ABD \equiv \triangle CDB$ ?
- If  $\triangle ABD \equiv \triangle CDB$ , what can be said about the opposite sides of a parallelogram?

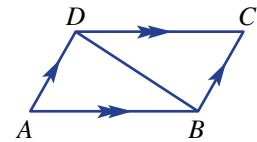

**PROBLEM-SOLVING**

5

5, 6

5-7

5 For this rhombus assume that  $VW = WT$ .

- Give reasons why  $\triangle VWU \equiv \triangle TWU$ .
- Give reasons why  $\angle VWU = \angle TWU = 90^\circ$ .

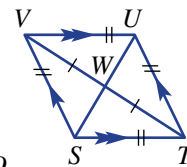

6 For this square assume that  $MQ = QO$  and  $NQ = PQ$ .

- Give reasons why  $\triangle MNQ \equiv \triangle ONQ$ .
- Give reasons why  $\angle MQN = \angle OQN = 90^\circ$ .
- Give reasons why  $\angle QMN = 45^\circ$ .

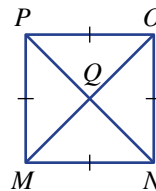

7 Use the information in this kite to prove these results.

- $\triangle ABD \equiv \triangle CBD$
- $\angle DAB = \angle DCB$
- $\angle ADB = \angle CDB$

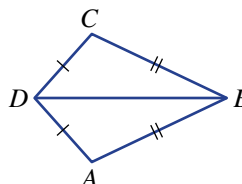

REASONING

8

8, 9

9–11

- 8 Use Pythagoras' theorem to prove that the diagonals in a rectangle are equal in length. You may assume that opposite sides are equal.

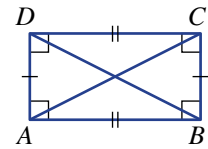

- 9 Use the steps outlined in Question 2 to show that opposite sides of a rectangle  $ABCD$  are equal. Give all reasons.

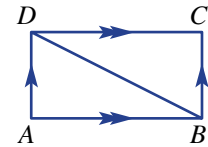

- 10 A trapezium  $ABCD$  has one pair of parallel sides.  
 a Which angle is equal to  $\angle BAE$ ?  
 b Which angle is equal to  $\angle ABE$ ?  
 c Explain why  $\triangle ABE$  is not congruent to  $\triangle CDE$ .

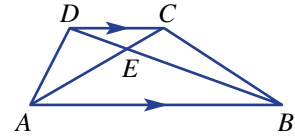

- 11 Use the information given for this kite to give reasons for the following properties. You may assume that  $\angle ADE = \angle CDE$  as marked.  
 a  $\angle DAE = \angle DCE$   
 b  $\triangle AED \equiv \triangle CED$   
 c  $\angle AED = \angle CED = 90^\circ$

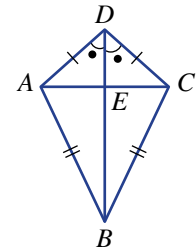

ENRICHMENT: Prove the converse

-

-

12

- 12 Prove the following results, which are the converse (reverse) of some of the proofs completed earlier in this exercise.

- a If the opposite sides of a quadrilateral are equal, then the quadrilateral is a parallelogram, i.e. show that the quadrilateral has two pairs of parallel sides.

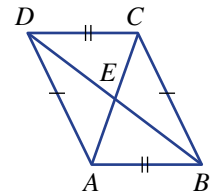

- b If the diagonals of a quadrilateral bisect each other, then the quadrilateral is a parallelogram.

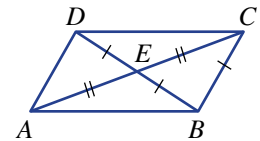

- c If the diagonals of a parallelogram are equal, then the parallelogram is a rectangle.

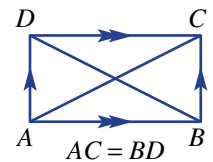

The following problems will investigate practical situations drawing upon knowledge and skills developed throughout the chapter. In attempting to solve these problems, aim to identify the key information, use diagrams, formulate ideas, apply strategies, make calculations and check and communicate your solutions.

## Designing a logo using reflections

- 1 Creating logo designs from simple shapes and then using a combination of rotations and reflections is Miranda's expertise.

*Miranda works as a creative designer and for a particular project she is interested in working on designs where two reflections produce the same result as one rotation.*

An example of one of Miranda's ideas is shown below, where a triangle ( $ABC$ ) has undergone two different reflections (firstly in reflection line 1 and secondly in reflection line 2) and the result is the same as a direct rotation.

- What do you notice about the two reflection lines?
- What is the angle between the two reflection lines?
- The triangle  $ABC$  has been rotated about which point?
- What overall angle has the triangle been rotated?
- By hand, reconstruct the image shown on the right, or create your own comparable design.

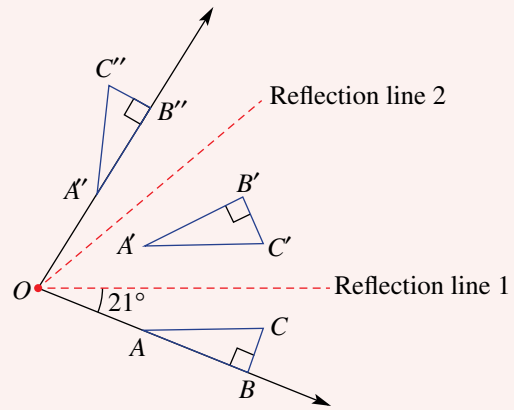

This pattern could continue indefinitely, and each second reflection would equal another rotation. If the angle between reflection lines is a multiple of  $360^\circ$ , then the pattern will be completed after one full revolution. If the angle between reflection lines is not a multiple of  $360^\circ$ , then each successive revolution will have a slight overlapping effect, which could make an interesting design.

- Using a geometry software package, such as Desmos Geometry or GeoGebra, start with a simple shape and create an interesting logo design where you repeatedly reflect, or reflect and rotate, the shape around a centre point.

## Making a necklace for a celebrity

- 2 Trevor is a jeweller and is currently working on a necklace with a pendant which involves three similar circles, or rings.

*Trevor has been commissioned by a well-known celebrity to make each of the rings a particular size.*

- One circle is to have an area of  $36\pi \text{ cm}^2$ , as 36 is the celebrity's current age and also the age of her partner.
  - One circle is to have a circumference of  $9.6\pi \text{ cm}$ , as their son was born on June 9.
  - One circle is to have a diameter of 6.4 cm, as the couple were married on April 6.
- Determine the length of the radius for each of the three similar circles.
  - State the scale factors for:
    - small to medium ring
    - medium to large ring
    - small to large ring.

- c Trevor suggests to the celebrity that it can be effective to have a consistent scale factor between the rings, and he suggests repeating the small to medium ring scale factor for the medium to large ring. If this were accepted, what would be the new radius of the largest circle?

## Voronoi diagrams

- 3 Claire is fascinated by modern architecture and in particular has taken a real interest in Voronoi tessellations, which are also known as Voronoi diagrams. These are named after George Voronoi, a Russian mathematician who lived in the early 1900s. A Voronoi tessellation is a way of dividing an area into regions based on distances to nearby points. The result is a honeycomb-like, mesh shape, which is being increasingly used as modern intricate designs for buildings, wall panels, furniture and more. An example is shown.

*Claire wishes to create her own unique Voronoi diagram and needs to use a particular algorithm.*

Materials required: pens/pencils/textas; paper; ruler; square or protractor

There are four key steps.

Step 1: Take an A4 piece of paper and begin by drawing random dots. Tighter spacing of your dots will produce smaller shapes in your final pattern and looser spacing of the dots will produce larger shapes. The more dots, the more complex and the more time your diagram will take.

Step 2: You need to connect each random dot to its nearest neighbours, forming a network of triangles. The idea is to connect each dot with the two closest dots that make up a triangle with the smallest possible area.

Step 3: Once all the dots are connected, the next task is to draw perpendicular bisectors for each line. Measure the midpoint of each line and then draw the perpendicular bisector. This is best done using a different colour pencil. The perpendicular bisection lines for each side of each triangle will intersect at a single point, the centre of the circumcircle for that triangle.

Step 4: The final step to reveal your own Voronoi diagram. Connect each of the points where the three bisectors intersect (the circumcircle centre points). The lines you draw to connect them will follow the paths of the perpendicular bisectors which you drew in the last step. Another new colour, or thicker pen or texta, will help to bring out your pattern. Well done!

There are many excellent video tutorials on the internet showing how to draw Voronoi diagrams. Research 'hand drawn Voronoi diagram' to see the method listed above in action, and 'SketchUp Voronoi diagram' to see how these diagrams are created using computer software.

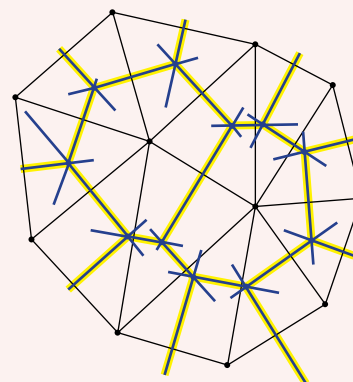
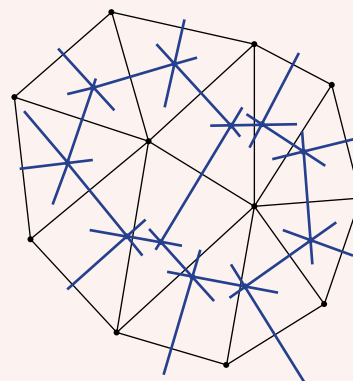
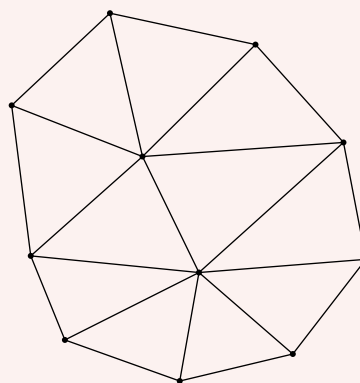

## 10H Similar figures

### LEARNING INTENTIONS

- To understand that similar figures have the same shape (angles, ratios of sides) but can be of a different size
- To be able to identify corresponding features of a pair of similar figures
- To be able to find the scale factor in a pair of similar figures
- To be able to decide if shapes are similar by considering angles and side ratios

When you look at an object through a telescope or a pair of binoculars, you expect the image to be much larger than the one you would see with the naked eye. Both images would be the same in every way except for their size. Such images in mathematics are called similar figures.

Images that have resulted in a reduction in size (rather than an enlargement in size) are also considered to be similar figures.



An item through a telescope is 'similar' to how it appears to the naked eye.

### Lesson starter: Are they similar?

Here are two quadrilaterals.

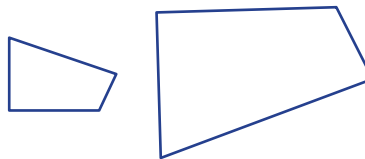

- Do they look similar in shape? Why?
- How could you use a protractor to help decide if they are similar in shape? What would you measure and check? Try it.
- How could you use a ruler to help decide if they are similar in shape? What would you measure and check? Try it.
- Describe the geometrical properties that similar shapes have. Are these types of properties present in all pairs of shapes that are 'similar'?

### KEY IDEAS

- **Similar figures** have the same shape but can be of different size.
- For similar figures, all corresponding angles are equal.
- For similar figures, all corresponding sides are in the same ratio.

- The ratio of sides is often written as a fraction, shown here. It is often called the **scale factor**. Unless specified, the scale factor will be from the smaller shape to the larger shape, so will be larger than 1.

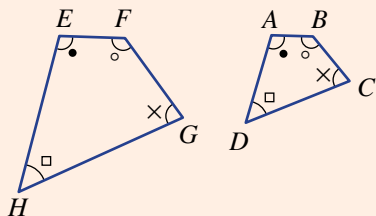

$$\text{Scale factor} = \frac{EF}{AB} = \frac{FG}{BC} = \frac{GH}{CD} = \frac{HE}{DA}$$

- If the scale factor is 1, the figures are congruent.

### BUILDING UNDERSTANDING

- State any pairs of shapes that look similar (i.e. same shape but different size).

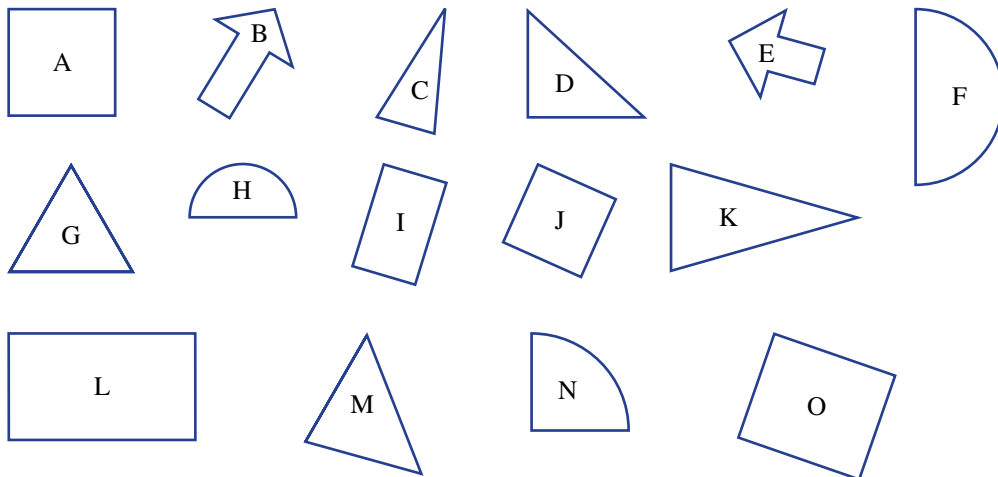

- Consider these two triangles.

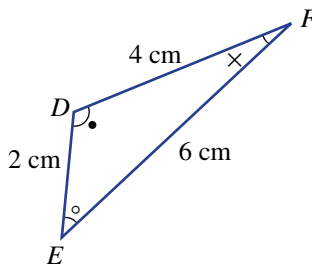
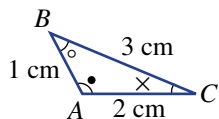

- Name the angle on the larger triangle which corresponds to:
  - $\angle A$
  - $\angle B$
  - $\angle C$ .
- Name the side on the smaller triangle which corresponds to:
  - $DE$
  - $EF$
  - $FD$ .
- Find these scale factors.
  - $\frac{DE}{AB}$
  - $\frac{EF}{BC}$
  - $\frac{FD}{CA}$
- Would you say that the two triangles are similar? Why or why not?





### Example 13 Identifying corresponding features

For the pair of similar figures shown on the right, complete these tasks.

- List the pairs of corresponding sides.
- List the pairs of corresponding angles.
- Find the scale factor.
- Find the values of the pronumerals.

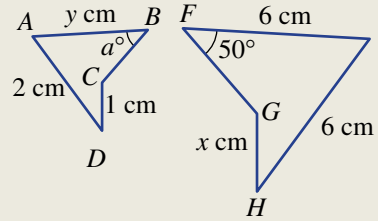

#### SOLUTION

a  $(AB, EF), (BC, FG), (CD, GH), (DA, HE)$

b  $(\angle A, \angle E), (\angle B, \angle F), (\angle C, \angle G), (\angle D, \angle H)$

c  $\frac{HE}{DA} = \frac{6}{2} = 3$

d  $a = 50$   
 $x = 3 \times 1 = 3 \text{ cm}$   
 $y = 6 \div 3 = 2 \text{ cm}$

#### EXPLANATION

Pair up each vertex, noticing that  $G$  corresponds with  $C$ ,  $H$  corresponds with  $D$  and so on.

$\angle G$  and  $\angle C$  are clearly the largest angles in their respective shapes. Match the other angles in reference to these angles.

$HE$  and  $DA$  are corresponding sides both with given measurements. Divide the larger by the smaller.

$\angle B$  and  $\angle F$  are equal corresponding angles. The scale factor  $\frac{HE}{DA} = 3$  so  $\frac{GH}{CD}$  should also equal 3.

Alternatively, say that  $GH$  is 3 times the length  $CD$ . Similarly,  $EF$  should be 3 times the length  $AB$  ( $y \text{ cm}$ ).

#### Now you try

For the following pair of figures complete these tasks.

- List the pairs of corresponding sides.
- List the pairs of corresponding angles.
- Find the scale factor.
- Find the values of the pronumerals.

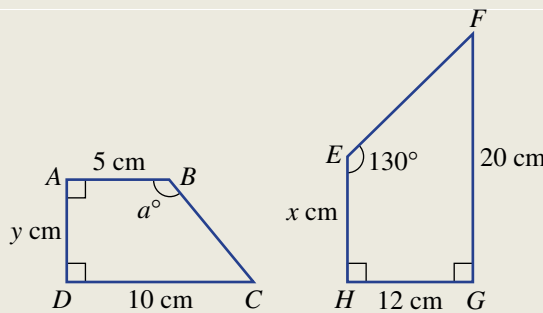



### Example 14 Deciding if shapes are similar

Decide if these shapes are similar by considering corresponding angles and the ratio of sides.

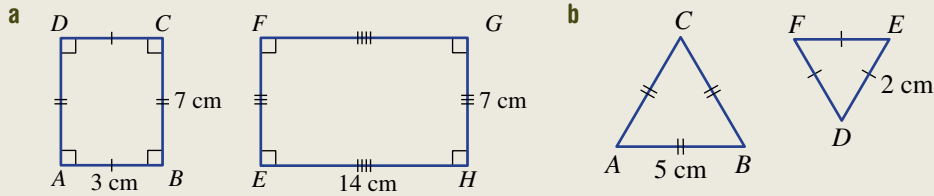

#### SOLUTION

**a** All corresponding angles are equal.

$$\frac{EH}{BC} = \frac{14}{7} = 2$$

$$\frac{GH}{AB} = \frac{7}{3} = 2.\bar{3}$$

Scale factors are not equal.

Shapes are not similar.

**b** All angles are  $60^\circ$

$$\frac{AB}{DE} = \frac{5}{2} = 2.5$$

$$\frac{BC}{EF} = \frac{5}{2} = 2.5$$

$$\frac{CA}{FD} = \frac{5}{2} = 2.5$$

Triangles are similar.

#### EXPLANATION

All angles are  $90^\circ$  and so corresponding angles are equal.

Match pairs of sides to find scale factors.

The scale factor needs to be equal if the shapes are to be similar.

All angles in an equilateral triangle are  $60^\circ$ .

All scale factors are equal so the triangles are similar.

#### Now you try

Decide if these shapes are similar by considering corresponding angles and the ratio of sides.

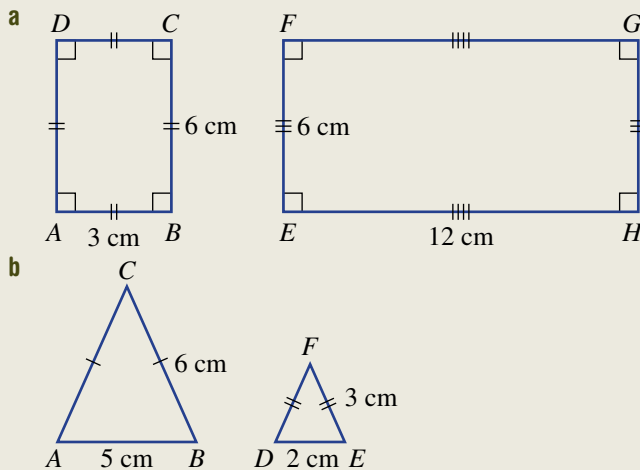

## Exercise 10H

### FLUENCY

1–3

2–4

2, 3(1/2), 4

Example 13

1 For the following pairs of similar figures, complete these tasks.

- i List the pairs of corresponding sides.
- ii List the pairs of corresponding angles.
- iii Find the scale factor.
- iv Find the values of the pronumerals.

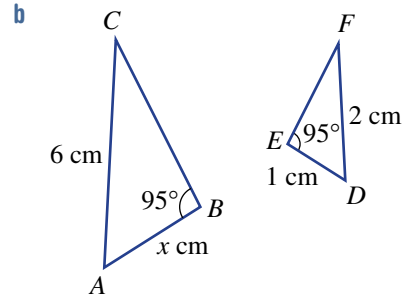
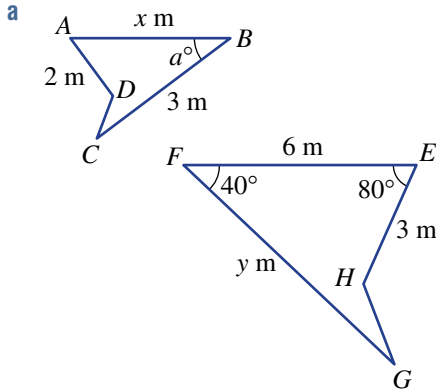

Example 13

2 For the following pairs of similar figures, complete these tasks.

- i List the pairs of corresponding sides.
- ii List the pairs of corresponding angles.
- iii Find the scale factor.
- iv Find the values of the pronumerals.

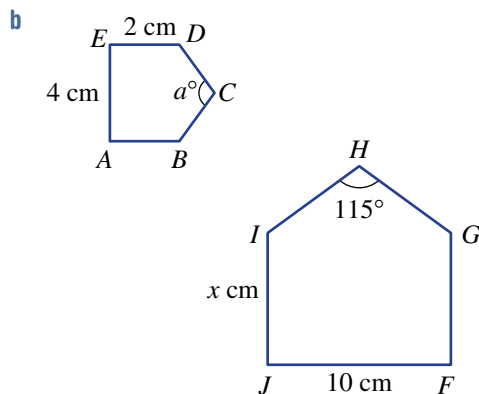
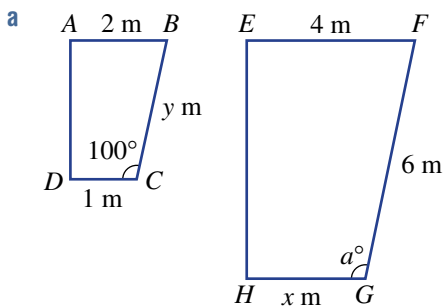

3 Decide if the pairs of shapes on these grids are similar. If so, state the scale factor.

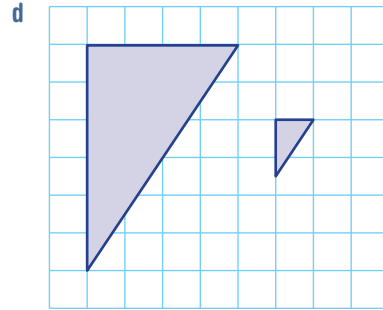
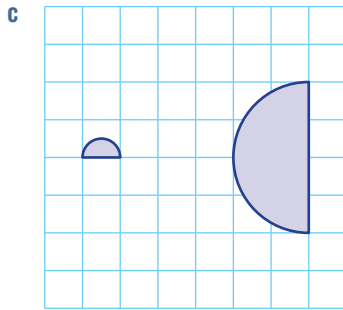
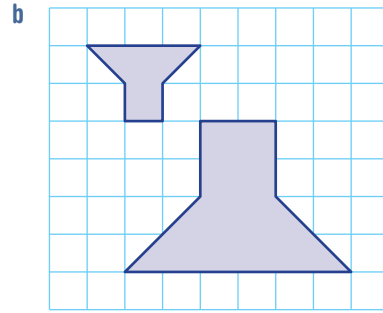
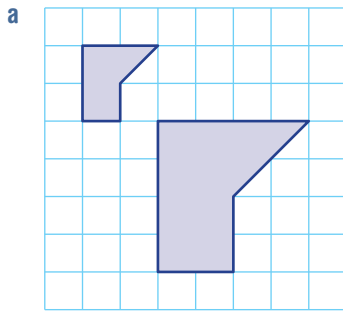

**Example 14** 4 Decide if these shapes are similar by considering corresponding angles and the ratios of sides.

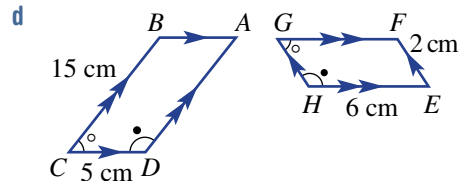
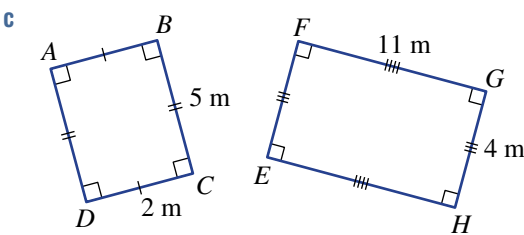
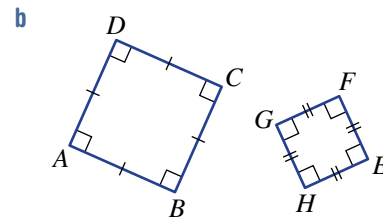
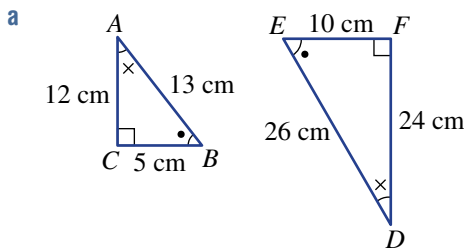

**PROBLEM-SOLVING**

5, 6

5-7

6-8

- Two rectangular picture frames are similar in shape. A corresponding pair of sides are of length 50 cm and 75 cm. The other side length on the smaller frame is 70 cm. Find the perimeter of the larger frame.
- Two similar triangles have a scale factor of  $\frac{7}{3}$ . If the larger triangle has a side length of 35 cm, find the length of the corresponding side on the smaller triangle.
- One circle has a perimeter of  $10\pi$  cm and another has an area of  $16\pi$  cm<sup>2</sup>. Find the scale factor of the diameters of the two circles.
- A square photo of area 100 cm<sup>2</sup> is enlarged to an area of 900 cm<sup>2</sup>. Find the scale factor of the side lengths of the two photos.

## REASONING

9

9, 10

9, 11

- 9 Are the following statements true or false? Give reasons for your answers.
- |  |  |
|--|--|
| a All squares are similar.               | b All rectangles are similar.          |
| c All equilateral triangles are similar. | d All isosceles triangles are similar. |
| e All rhombuses are similar.             | f All parallelograms are similar.      |
| g All kites are similar.                 | h All trapeziums are similar.          |
| i All circles are similar.               |  |
- 10 a If a regular polygon such as this regular octagon is enlarged, do the interior angles change?  
b Are all polygons with the same number of sides similar? Give reasons.

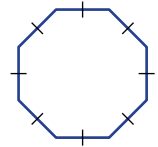

- 11 If a square is similar to another by a scale factor of 4, what is the ratio of the area of the small square to the area of the large square?

## ENRICHMENT: Square designs

-

-

12



- 12 A square design consists of a series of squares as shown. An inner square is formed by joining the midpoints of the sides of the next largest square.

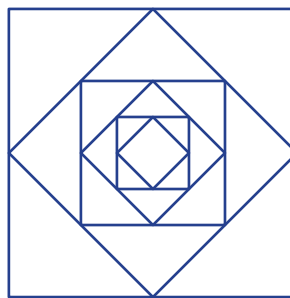

4 cm

- a Use Pythagoras' theorem to find the side length of:
- the second largest square
  - the third largest square.
- b Find the scale factor of a pair of consecutive squares, e.g. first and second or second and third.
- c If the side length of the outside square was  $x$  cm, show that the scale factor of consecutive squares is equal to the result found in part b.
- d What is the scale factor of a pair of alternate squares, e.g. first and third or second and fourth?

## 10I Similar triangles

### LEARNING INTENTIONS

- To understand that determining whether triangles are similar can be done using the similarity tests AAA, SSS, SAS and RHS
- To be able to decide if two triangles are similar
- To be able to find missing lengths using a pair of similar triangles

Finding the approximate height of a tree or the width of a gorge using only simple equipment is possible without actually measuring the distance directly. Similar triangles can be used to calculate distances without the need to climb the tree or cross the gorge. It is important, however, to ensure that if the mathematics of similar triangles is going to be used, then the two triangles are in fact similar. We learned earlier that there were four tests that help to determine if two triangles are congruent. Similarly, there are four tests that help establish whether or not triangles are similar. Not all side lengths or angles are required to prove that two triangles are similar.



Before building the Landwasser Viaduct, Switzerland, surveyors could use similar triangles to calculate the width of this 70 m deep gorge. Then, using algebra, geometry and trigonometry, engineers designed a suitable bridge.

### Lesson starter: How much information is enough?

Given a certain amount of information, it may be possible to draw two triangles that are guaranteed to be similar in shape.

Decide if the information given is enough to guarantee that the two triangles will always be similar. If you can draw two triangles ( $\triangle ABC$  and  $\triangle DEF$ ) that are not similar, then there is not enough information provided.

- $\angle A = 30^\circ$  and  $\angle D = 30^\circ$
- $\angle A = 30^\circ$ ,  $\angle B = 80^\circ$  and  $\angle D = 30^\circ$ ,  $\angle E = 80^\circ$
- $AB = 3$  cm,  $BC = 4$  cm and  $DE = 6$  cm,  $EF = 8$  cm
- $AB = 3$  cm,  $BC = 4$  cm,  $AC = 5$  cm and  $DE = 6$  cm,  $EF = 8$  cm,  $DF = 10$  cm
- $AB = 3$  cm,  $\angle A = 30^\circ$  and  $DE = 3$  cm,  $\angle D = 30^\circ$
- $AB = 3$  cm,  $AC = 5$  cm,  $\angle A = 30^\circ$  and  $DE = 6$  cm,  $DF = 10$  cm,  $\angle D = 30^\circ$

## KEY IDEAS

- Two triangles are similar if:

**AAA**

- Three pairs of corresponding angles are equal. If two pairs are known, then the angle sum of a triangle can be used to show that the third pair of angles are also equal.

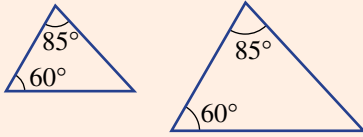

$$\begin{aligned}\text{Missing angle} &= 180^\circ - (60^\circ + 85^\circ) \\ &= 35^\circ\end{aligned}$$

**SSS**

- All pairs of corresponding sides are in the same ratio.

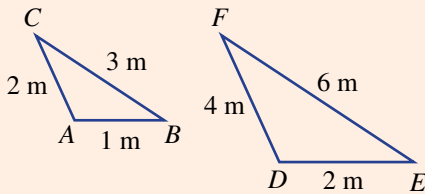

$$\frac{DE}{AB} = \frac{EF}{BC} = \frac{DF}{AC} = 2$$

**SAS**

- Two pairs of corresponding sides are in the same ratio and the included angles are equal.

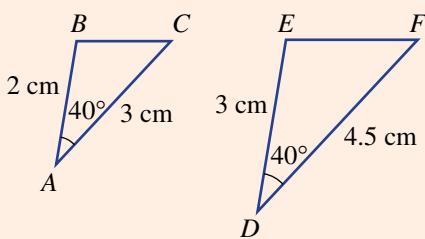

$$\frac{DE}{AB} = \frac{DF}{AC} = 1.5$$

**RHS**

- A pair of right angles, the pair of hypotenuse lengths and another pair of corresponding sides are in the same ratio.

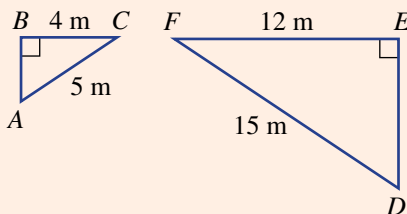

$$\frac{DF}{AC} = \frac{DE}{AB} = 3$$

- If two triangles  $\triangle ABC$  and  $\triangle DEF$  are similar, we write  $\triangle ABC \sim \triangle DEF$  or  $\triangle ABC \parallel \triangle DEF$ .
  - This is called a similarity statement.
  - Letters are usually written in matching order.

### BUILDING UNDERSTANDING

1 Give a similarity statement for these pairs of similar triangles, e.g.  $\triangle ABC \sim \triangle FED$  or  $\triangle ABC \parallel \triangle DEF$ . Be careful with the order of letters and make sure each letter matches the corresponding vertex.

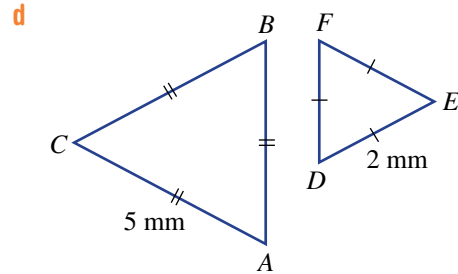
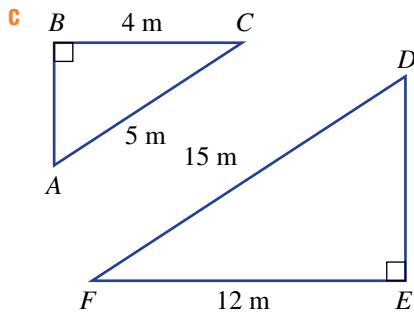
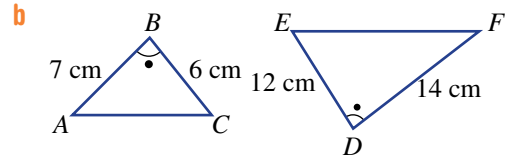
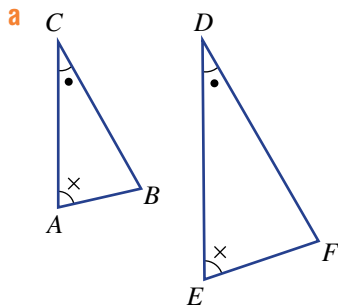

2 For the pairs of triangles in Question 1, which of the four similar triangle tests (AAA, SSS, SAS or RHS) would be used to show their similarity? See the **Key ideas** for a description of each test. There is one pair for each test.



### Example 15 Explaining why two triangles are similar

Explain, with reasons, why these pairs of triangles are similar.

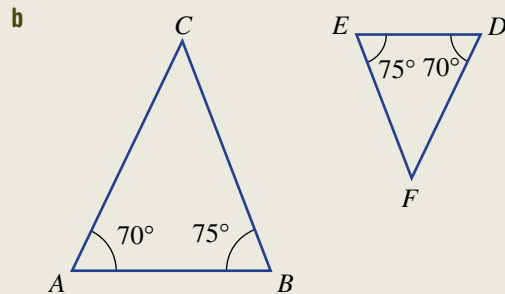
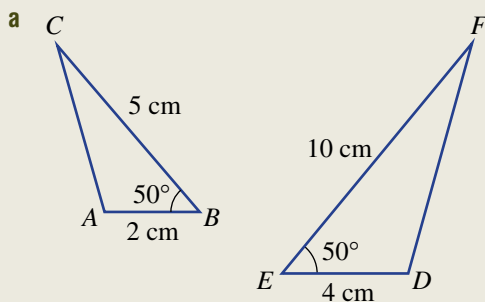



**SOLUTION**

$$\text{a } \frac{ED}{AB} = \frac{4}{2} = 2$$

$$\angle B = \angle E = 50^\circ$$

$$\frac{EF}{BC} = \frac{10}{5} = 2$$

$\therefore \triangle ABC$  is similar to  $\triangle DEF$

Using SAS

$$\text{b } \angle A = \angle D$$

$$\angle B = \angle E$$

$\therefore \triangle ABC$  is similar to  $\triangle DEF$

Using AAA

**EXPLANATION**

Work out the ratio of the two pairs of corresponding sides to see if they are equal. Note that the angle given is the included angle between the two given pairs of corresponding sides.

Two pairs of equal angles are given. This implies that the third pair of angles are also equal and that the triangles are similar.

**Now you try**

Explain, with reasons, why these pairs of triangles are similar.

a

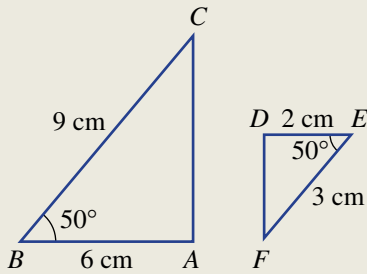

b

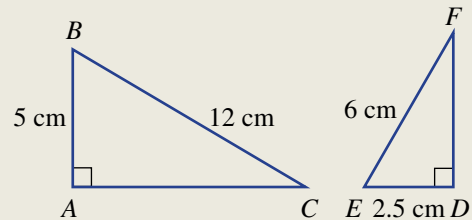
**Example 16 Finding a missing length**

Given that these pairs of triangles are similar, find the value of the pronumerals.

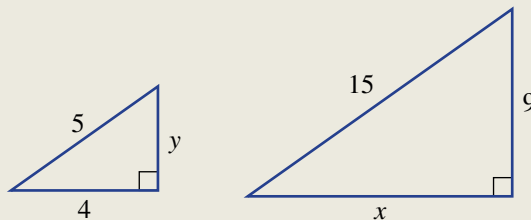
**SOLUTION**

$$\text{Scale factor} = \frac{15}{5} = 3$$

$$4 \xrightarrow{\times 3} x \quad \therefore x = 12$$

$$y \xrightarrow{\times 3} 9 \quad \therefore y = 3$$

**EXPLANATION**

First find the scale factor.

Multiply or divide by the scale factor to find the values of the pronumerals.

**Now you try**

Given that this pair of triangles are similar, find the value of the pronumerals.

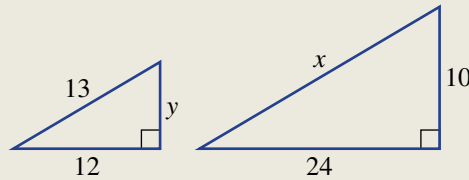

**Exercise 10I**

**FLUENCY**

1, 2(1/2), 3

2(1/2), 3

2(1/2), 3

Example 15

1 Explain, with reasons, why these pairs of triangles are similar.

a

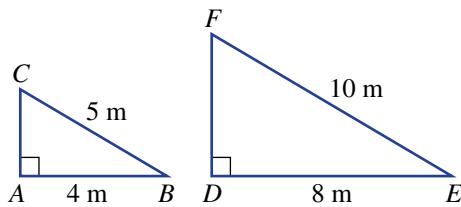

b

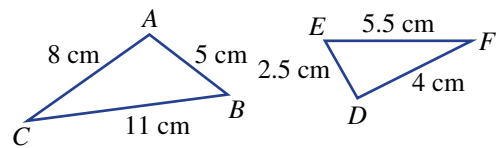

Example 15

2 Explain, with reasons, why these pairs of triangles are similar. State which of the four tests (AAA, SSS, SAS or RHS) applies.

a

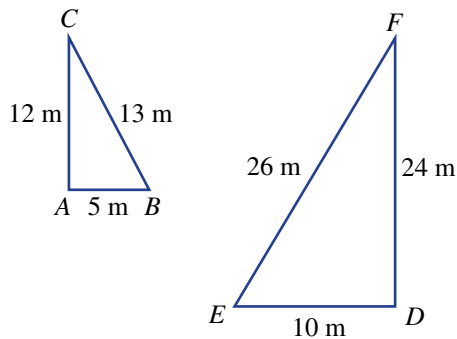

b

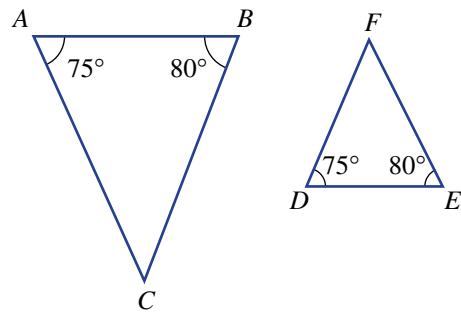

c

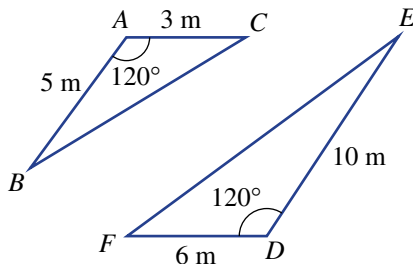

d

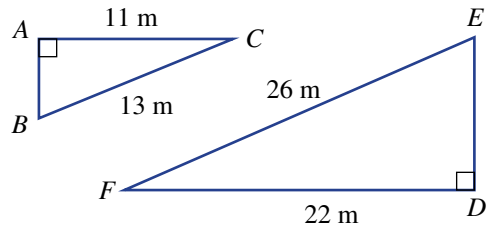

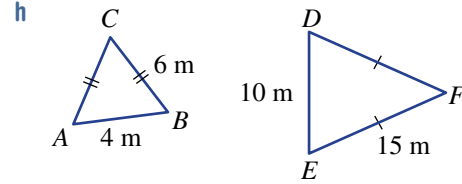
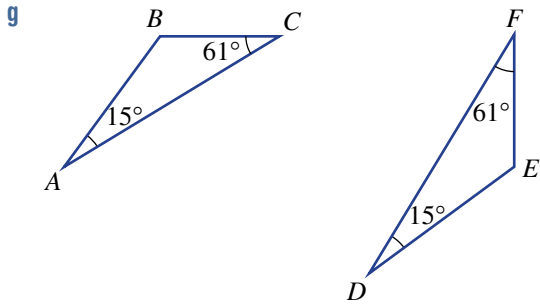
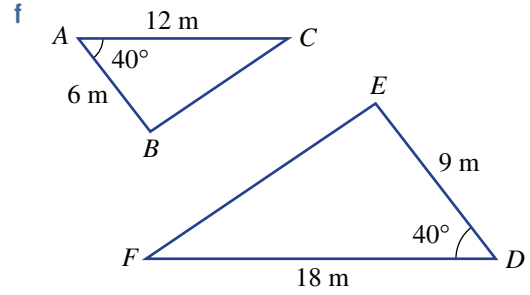
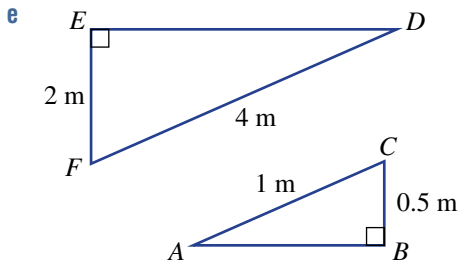

Example 16

3 Given that these pairs of triangles are similar, find the value of the pronumerals.

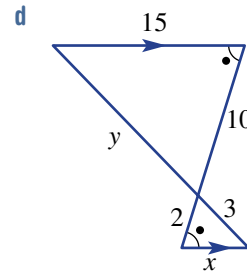
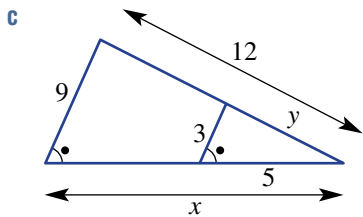
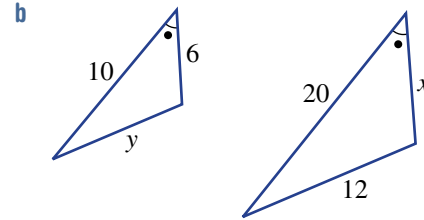
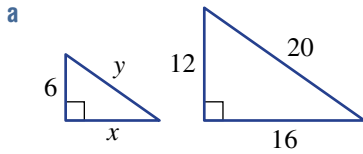

PROBLEM-SOLVING

4-6

4-6

5-7

4 Two triangular tracks are to be used for the junior and open divisions for a school event.

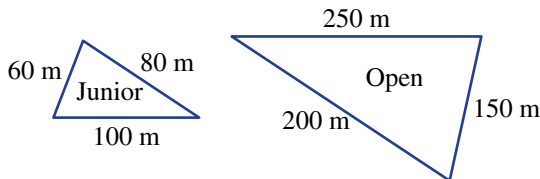

- Work out the scale factor for each of the three corresponding pairs of sides.
- Are the two tracks similar in shape? Give a reason.
- How many times would a student need to run around the junior track to cover the same distance as running one lap of the senior track?

5 By using the angle sum of a triangle, decide if the given pairs of triangles are similar.

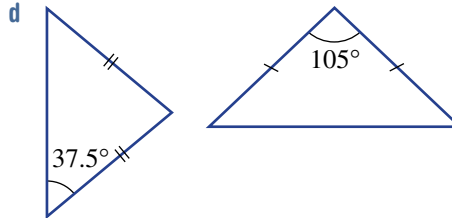
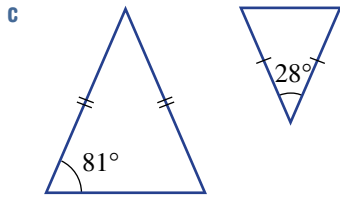
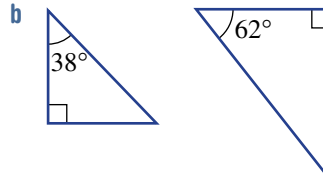
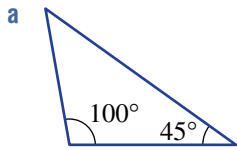

6 In a game of minigolf, a ball bounces off a wall as shown. The ball proceeds and hits another wall at point A. How far down the right side wall does the ball hit?

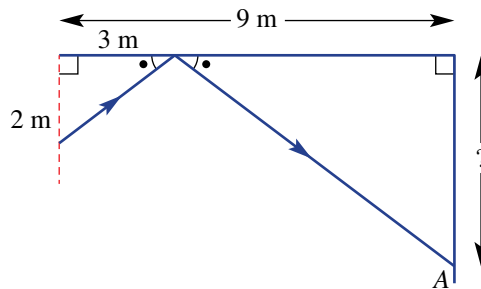

7 Trees on a river bank are to be used as markers to form two triangular shapes. Each tree is marked by a red dot as shown in the diagram.

- Are the two triangles similar? Explain why.
- Calculate the scale factor.
- Calculate how far it is across the river.

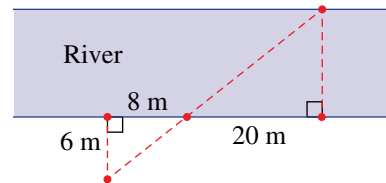

**REASONING**

8, 9

8–10

9–11

- Explain why only two pairs of angles are required to prove that two triangles are similar.
- Describe a set of instructions (an algorithm) that could be used to decide if a pair of triangles is congruent (C), similar but not congruent (S), or not similar or congruent (N). The first step should involve measuring two angles in each triangle before going on to measure side lengths if necessary.

10 Give reasons why the pairs of triangles in these diagrams are similar. If an angle or side is common to both triangles, use the word 'common' in your reasoning.

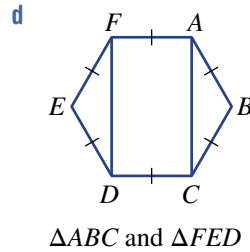
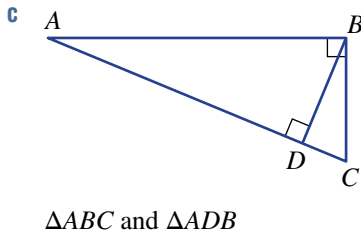
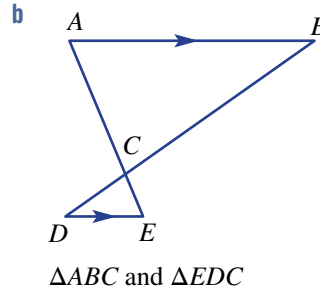
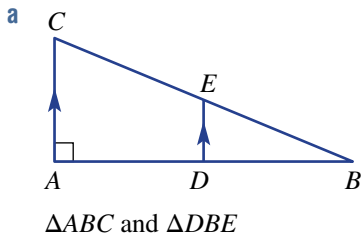

11 Show how Pythagoras' theorem can be used to prove that these two triangles are similar.

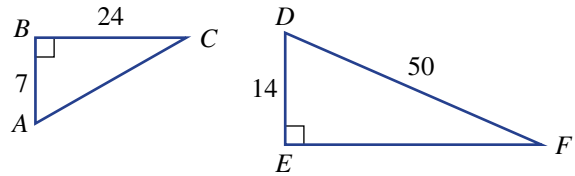

**ENRICHMENT: Tricky unknowns**

-

-

12

12 The pairs of triangles here show a length  $x$  cm, which is not the length of a full side of the triangle. Find the value of  $x$  in each case.

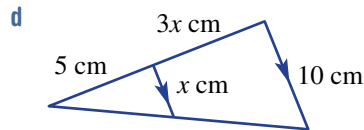
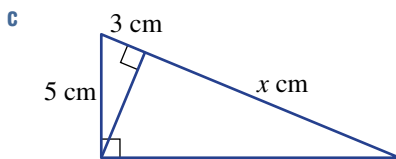
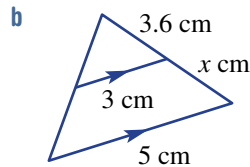
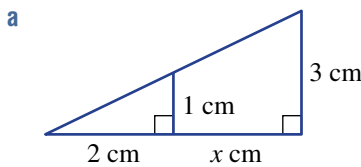

## Restoring old tiles

Isaac is in the business of cutting new tiles to replace broken tiles in old houses. The old tiles are mostly regular polygons, so he focuses on these types of shapes for his new cuts.

*Present a report for the following tasks and ensure that you show clear mathematical workings and explanations where appropriate.*

### Preliminary task

- a Isaac cuts a number of equilateral triangles of equal size for a tiling job.
  - i Make a drawing to show how such tiles can join together without gaps (tessellate).
  - ii At one vertex point inside your tessellation, determine all the angles surrounding that point.
- b Repeat part a if square tiles are used.

### Modelling task

- |                            |   |
|----------------------------|---|
| <b>Formulate</b>           | <ol style="list-style-type: none"> <li>a The problem is to determine the types of shapes that Isaac can use to form tessellations for the purposes of tiling. Write down all the relevant information that will help solve this problem.</li> <li>b Describe what it means for a shape to tessellate, illustrating your description with one or more diagrams.</li> </ol>   |
| <b>Solve</b>               | <ol style="list-style-type: none"> <li>c Apart from an equilateral triangle and a square, there is only one other regular polygon that Isaac can use that tessellates by itself. State the shape and illustrate how it tessellates.</li> <li>d Try to construct a tessellation using only octagons of equal size. Explain why Isaac cannot use only octagons for a tessellating tile pattern. Justify your response using a diagram.</li> <li>e Isaac decides to use two different regular polygon shapes to make a tile pattern.           <ol style="list-style-type: none"> <li>i If he uses an octagon as one of the shapes, determine what other shape is required to form the tessellation. Justify using a drawing.</li> <li>ii If he uses only equilateral triangles and squares, determine how a tessellation can be formed. Justify using a drawing.</li> </ol> </li> </ol> |
| <b>Evaluate and verify</b> | <ol style="list-style-type: none"> <li>f Isaac's favourite three regular polygon tiles are the hexagon, square and equilateral triangle. Explore if it is possible for Isaac to combine all three shapes to form a tile tessellation. Illustrate your solution using a drawing and also determine the angles at one of the vertices inside the tessellation.</li> </ol>   |
| <b>Communicate</b>         | <ol style="list-style-type: none"> <li>g Summarise your results and describe any key findings.</li> </ol>   |

### Extension questions

- a We know that there are only three regular polygons that tessellate by themselves. If two or more different regular polygons tessellate together, these are called semi-regular tessellations. Draw some examples of how semi-regular tessellations could be used to tile a region.
- b Find out how many possible tessellations exist if:
  - i two regular polygons are used
  - ii any number of regular polygons can be used.



# Flowchart geometric proofs

## Key technology: Dynamic geometry

A proof in mathematics involves a sequence of ordered and logical steps which show that a given statement is true. An example of this in geometry is an argument that two triangles are congruent where observations about pairs of angles and side lengths are listed and connected to one of the tests for congruence, namely: SSS, SAS, AAS or RHS.



### 1 Getting started

- a Consider this pair of triangles.
  - i List the corresponding pairs of equal length sides.
  - ii List any pairs of corresponding equal angles.
  - iii Which of the reasons (SSS, SAS, AAS or RHS) would you choose to show that the pair of triangles are equal?

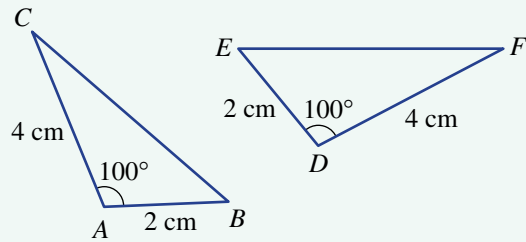

- b By following the steps in part a, complete a proof showing that the following pairs of triangles are congruent.

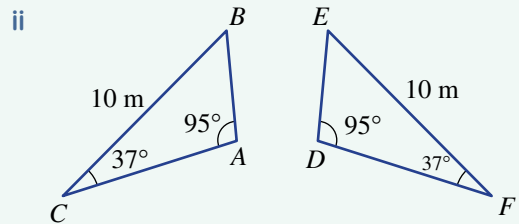
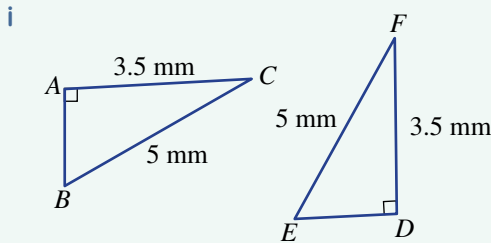

## 2 Using technology

We will explore congruent shapes using transformations and a dynamic geometry package like Desmos Geometry, or Geogebra.

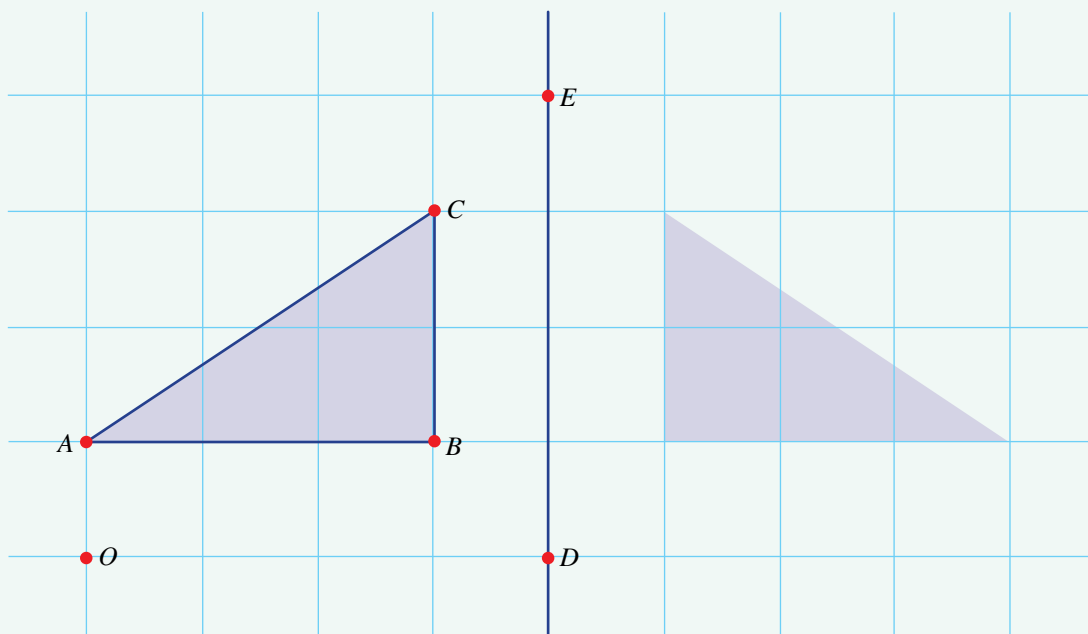

- Construct a triangle using the Polygon tool. Remember to finish the construction by selecting the first point again. Move each vertex so that it snaps onto the grid. Label your triangle  $ABC$ .
- Construct the line  $DE$  and point  $O$  as shown.
- Reflect triangle  $ABC$  in the mirror line  $DE$  by using the Reflection tool in the Transform and Define Transformation menu.
- Decide if the image created in part **c** is congruent to triangle  $ABC$ . Give reasons.
- Drag one of the points  $A$ ,  $B$ ,  $C$ ,  $D$  or  $E$  and describe what you notice. Is the image always congruent to triangle  $ABC$ ?
- Now rotate triangle  $ABC$  about the point  $O$ . Use the Rotation tool in the Transform and Define Transformation menu. Experiment by changing the angle of rotation or by altering the positions of points  $A$ ,  $B$ ,  $C$  or  $O$ . Is the image always congruent to triangle  $ABC$ ? Give reasons.
- Now translate triangle  $ABC$  using two points  $F$  and  $G$ . Use the Translation tool in the Transform and Define Transformation menu. Experiment by changing the positions of points  $F$  and  $G$  or by altering the positions of points  $A$ ,  $B$  or  $C$ . Is the image always congruent to triangle  $ABC$ ? Give reasons.



### 3 Applying an algorithm

Here is a flow chart that decides if two triangles are congruent and gives the abbreviated reason.

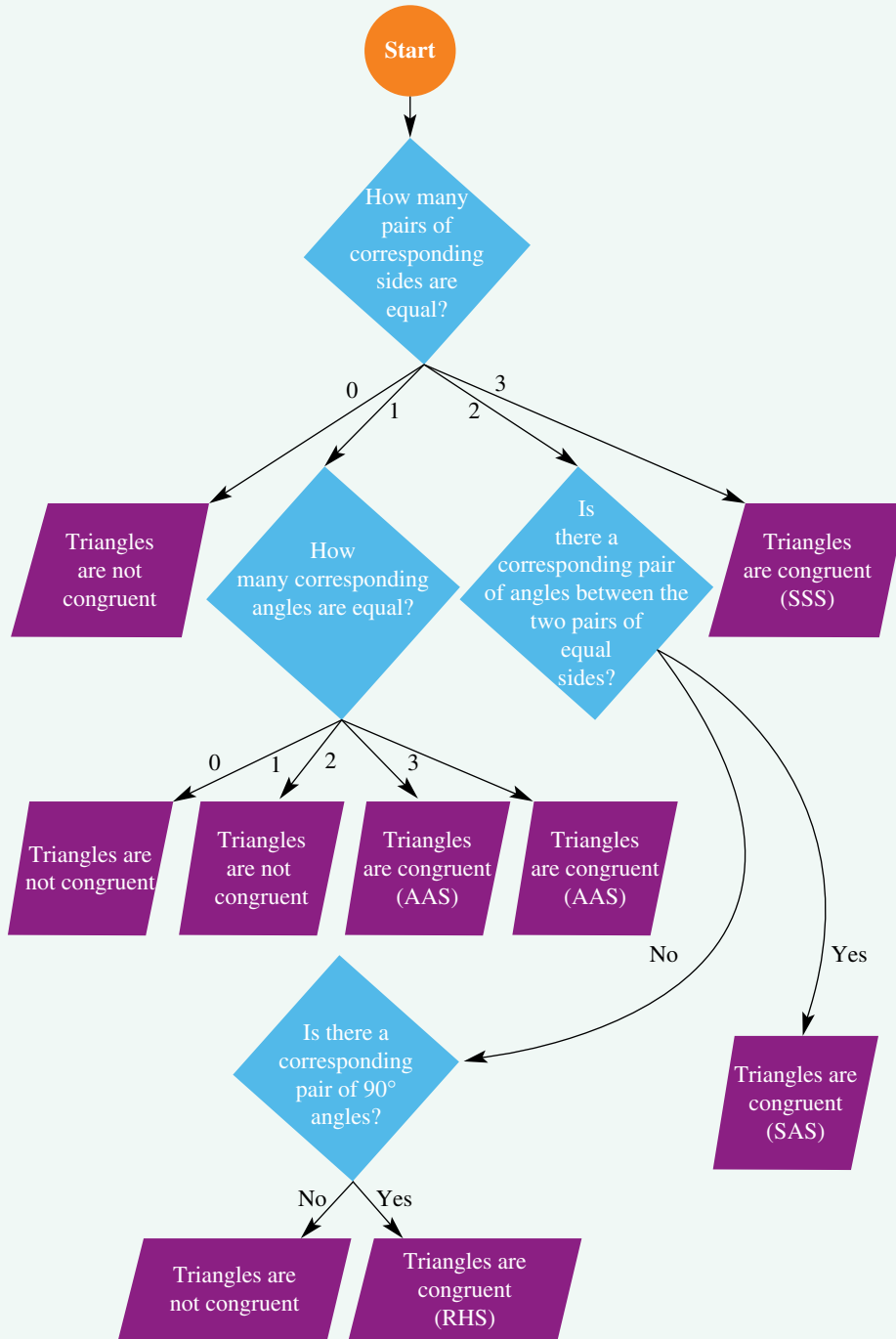

- a Run through the flow chart for the three pairs of triangles outlined in parts 1 a and b above. Does the result agree with the outcome from part 1?

- b** Run through the algorithm in the flow chart for this pair of triangles. Decide if the flow chart delivers the correct result.

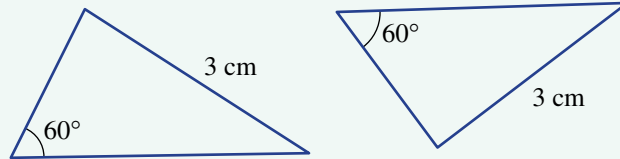

- c** One of the reasons out of SSS, SAS, AAS and RHS was not used on part 1 earlier. Decide which one was not used and draw a set of triangles which would use this remaining reason to prove that they are congruent. Check your drawings and conclusions by running through the flow chart.

#### 4 Extension

- a** Draw a flow chart which decides whether or not two triangles are similar. Remember that the abbreviated reasons for checking that two triangles are similar are: SSS, SAS, AAA and RHS.
- b** Draw at least one set of similar triangles for each of the reasons SSS, SAS, AAA and RHS. Use your flow chart to check that each pair of triangles is similar.

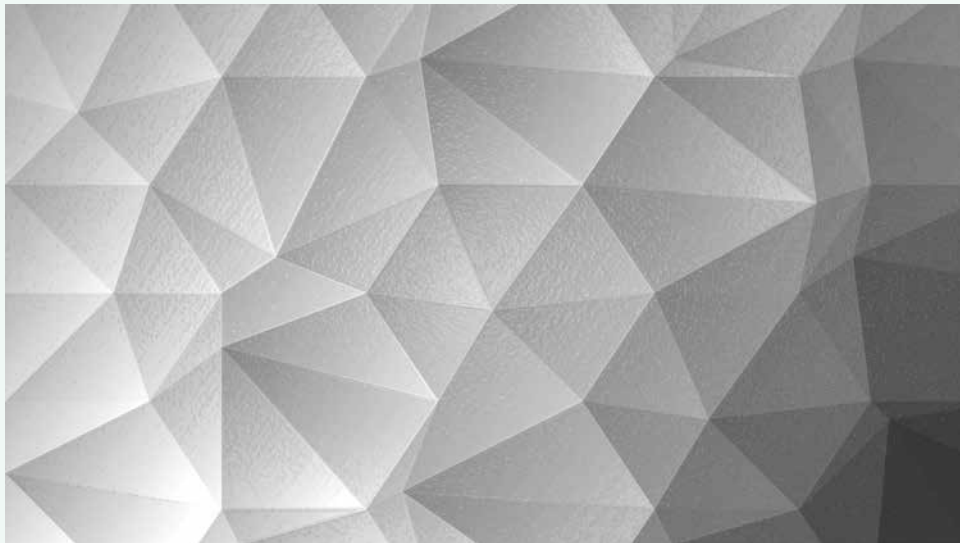

## Applying similar triangles

Similar triangles can be applied to situations where distances cannot be measured directly.

### Height of a vertical object in the sun

- Here is an illustration (not to scale) of a tall building with a shadow of 30 m. A 1-metre-long stick is placed vertically near the end of the shadow so that the top of the stick is just touched by the sun's rays. The distance from the base of the stick to the end of the shadow is 60 cm.
  - Give reasons why this illustration contains two similar triangles.
  - Show how the height of the building can be estimated using the scale factor for the pair of similar triangles.

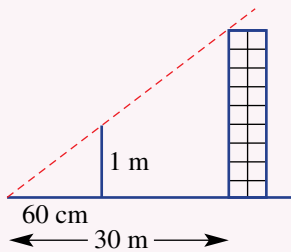

- Use the technique outlined in Question 1 to help estimate the height of a tall object in the school grounds, at home or in a town or city. Show your workings and include diagrams.

### Width of a gorge or river

- Trees located on both sides of this gorge are chosen to create similar triangles. The distances between some of the trees on one side of the gorge are also recorded.
  - Explain how the positions of the trees must be chosen to create a pair of similar triangles. (See **Exercise 10I** Question 7 for suggestions.)
  - Show how the similar triangles can be used to estimate the distance across the gorge. Show your diagrams and workings.
- Use the technique outlined in Question 3 to help estimate the distance across an open space such as a gorge, river or area in the school ground or at home. Show your workings and include diagrams.



- 1 How many similar triangles are there in this figure? Give reasons.

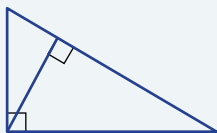

Up for a challenge? If you get stuck on a question, check out the 'Working with unfamiliar problems' poster at the end of the book to help you.

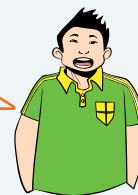

- 2 Consider the capital letters of the alphabet shown below.

A B C D E F G H I J K L M N O P Q R S T U V W X Y Z

Which of the letters have:

- a horizontal line symmetry only?
  - b only vertical line symmetry?
  - c both vertical and horizontal line symmetry?
- 3 A strip of paper is folded 5 times in one direction only. How many creases will there be in the original strip when it is folded out?

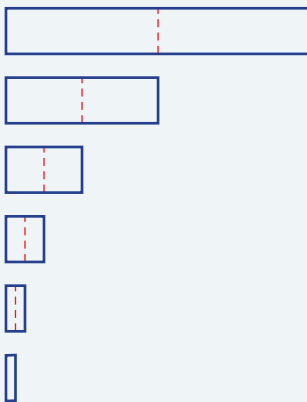

- 4 Use congruent triangles to find the radius  $r$  in these diagrams.

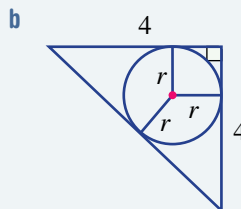
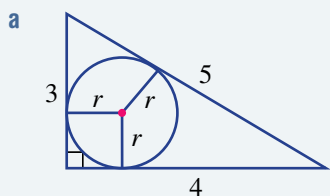

- 5 What is the side length of the largest square that can be cut out of this triangle? Use similar triangles.

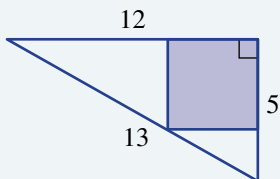

**Transformations and congruence**

**Reflection**

**Translation**  
Vector (2, -1)

**Rotation**  
Clockwise by 90°

**Similar triangles**

$\triangle ABC \sim \triangle DEF$   
or  $\triangle ABC \sim \triangle DEF$

$$\frac{DE}{AB} = \frac{EF}{BC} = \frac{FD}{CA}$$

$\angle A = \angle D, \angle B = \angle E, \angle C = \angle F$

Tests: AAA, SSS, SAS or RHS  
(see **Key ideas**)

**Congruent figures**

$ABCD \cong EFGH$        $x = y$

$AB = EF$

$\angle C = \angle G$

**Similar figures**

Ratio =  $\frac{FG}{AB} = \frac{6}{3} = 2$

$\angle A = \angle F$  etc.

$GH = AE \times 2$

**Tessellation (Ext)**

A tessellation is a pattern with no gaps made from shapes. Reflections, translations and rotations can be used.

**Naming a tessellation**

Name (3.6.3.6)

**Congruent triangles**

$\triangle ABC \cong \triangle DEF$

$AB = DE, BC = EF, AC = DF$

$\angle A = \angle D, \angle B = \angle E, \angle C = \angle F$

Tests: SSS, SAS, AAS, RHS

## Chapter checklist with success criteria

A printable version of this checklist is available in the Interactive Textbook



10A

**1. I can draw reflected images.**

e.g. Copy the diagram and draw the reflected image over the given mirror line.

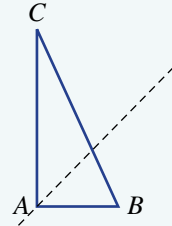

10A

**2. I can state the coordinates of an image point that has been reflected in a horizontal or vertical line.**

e.g. Consider the point  $B(2, 3)$ . State the image  $B'$  after it is reflected in the  $x$ -axis.



10B

**3. I can find a translation vector given a source and image point.**

e.g. State the translation vector that moves the point  $A(-1, 3)$  to  $A'(2, 0)$ .



10B

**4. I can draw the result of a translation.**

e.g. Draw the image of the triangle  $ABC$  after a translation by the vector  $(-3, 2)$ .

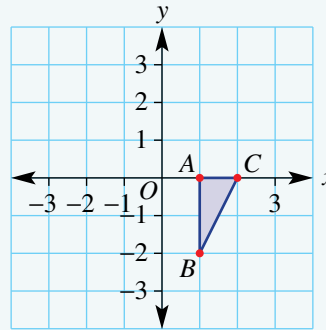

10C

**5. I can find the order of rotational symmetry of a shape.**

e.g. Find the order of rotational symmetry for this shape.

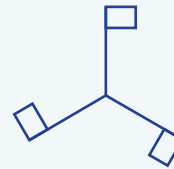

10C

**6. I can draw a rotated image.**

e.g. Rotate this shape  $90^\circ$  clockwise about the point  $C$ .

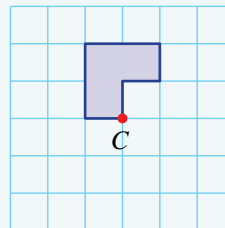

10D

**7. I can name corresponding pairs in congruent figures.**  
 e.g. These two quadrilaterals are congruent. Name the objects in quadrilateral  $EFGH$  that correspond to Vertex  $C$  and side  $AB$ .

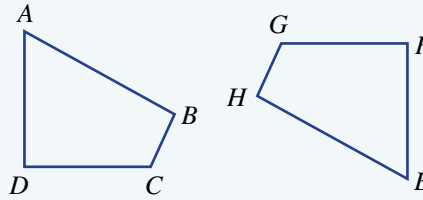

10E

**8. I can decide on an appropriate test for congruence of two triangles.**  
 e.g. Which test (SSS, SAS, AAS or RHS) could be used to test the congruence of this pair of triangles?

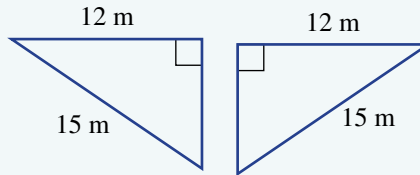

10E

**9. I can construct a triangle from a description and decide if it is unique.**  
 e.g. Use a ruler and a pair of compasses to construct a triangle  $\triangle ABC$  with  $AB = 5$  cm,  $BC = 7$  cm and  $AC = 4$  cm. Decide if it is unique, based on the description.



10F

**10. I can tessellate a basic shape.**  
 e.g. Use the 'plus sign' shape on the right to draw ten identical plus signs to show that this shape will tessellate.

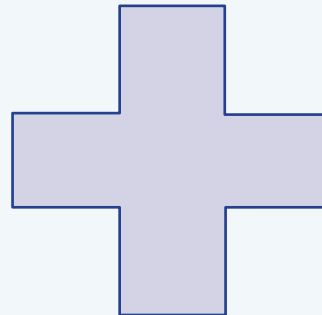

Ext



10F

**11. I can name a tessellation.**  
 e.g. By considering any vertex, name the semi-regular tessellation shown on the right.

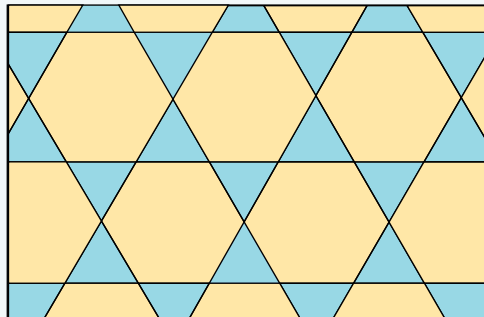

Ext



10G

**12. I can prove facts about quadrilaterals using congruent triangles.**  
 e.g. Prove that the diagonals of a parallelogram bisect each other (that is, cut each other into two equal length segments).

Ext



10H

**13. I can identify corresponding features in similar figures.**

e.g. These figures are similar. List the pairs of corresponding sides and the pairs of corresponding angles.

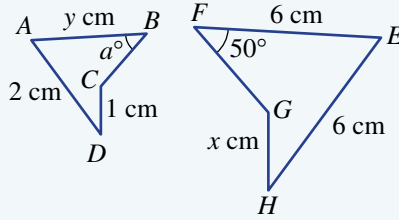

10H

**14. I can find the scale factors and unknown sides and angles in similar figures.**

e.g. These figures are similar. State the scale factor and hence find the values of the pronumerals.

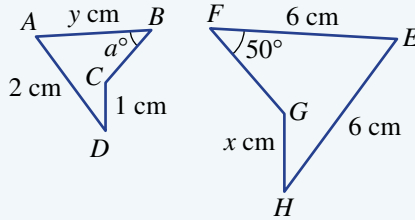

10H

**15. I can decide if shapes are similar.**

e.g. Decide if these shapes are similar by considering corresponding angles and the ratio of sides.

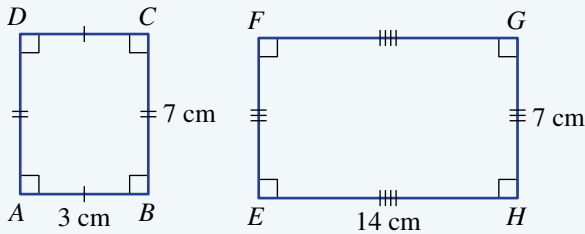

10I

**16. I can decide if triangles are similar using a similarity test.**

e.g. Decide, with reasons, whether these triangles are similar.

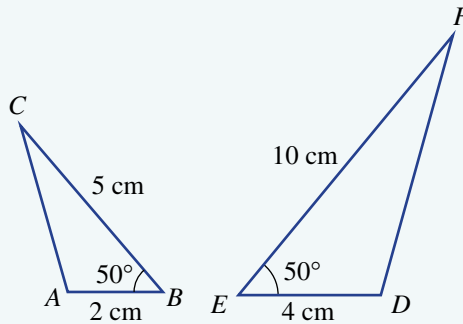

10I

**17. I can find missing lengths in similar triangles.**

e.g. Given that these triangles are similar, find the value of the pronumerals.

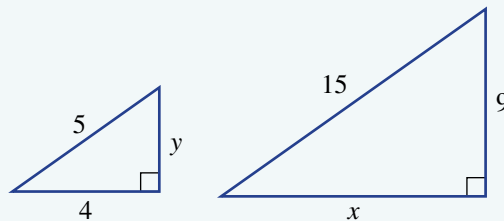



## Short-answer questions

10A

- 1 Copy these shapes and draw the reflected image over the mirror line.

a



b

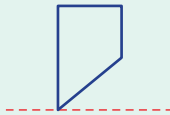

c

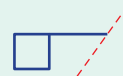

d

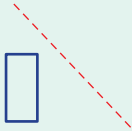

e



f

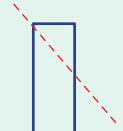

10A

- 2 The triangle
- $A(1, 2)$
- ,
- $B(3, 4)$
- ,
- $C(0, 2)$
- is reflected in the given axis. State the coordinates of the image points
- $A'$
- ,
- $B'$
- and
- $C'$
- .

- a  $x$ -axis  
b  $y$ -axis

10A

- 3 How many lines of symmetry do these shapes have?

- a square  
b isosceles triangle  
c rectangle  
d kite  
e regular hexagon  
f parallelogram

10B

- 4 Write the vectors that translate each point
- $A$
- to its image
- $A'$
- .

- a  $A(2, 5)$  to  $A'(3, 9)$   
b  $A(-1, 4)$  to  $A'(2, -2)$   
c  $A(0, 7)$  to  $A'(-3, 0)$   
d  $A(-4, -6)$  to  $A'(0, 0)$

10B

- 5 Copy these shapes and draw the translated image using the given translation vector.

- a
- $(3, -1)$

- b
- $(-2, 2)$

- c
- $(0, -3)$

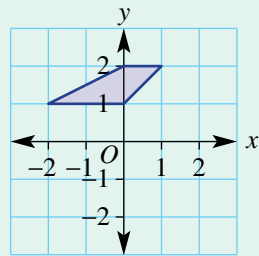
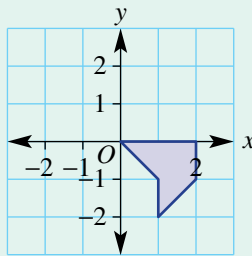
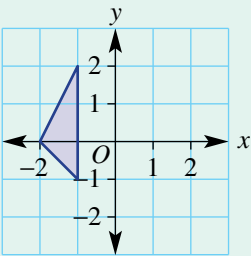

10C

- 6 What is the order of rotational symmetry of these shapes?

- a equilateral triangle  
b parallelogram  
c isosceles triangle

10C

7 Rotate these shapes about the point  $C$  by the given angle.

a clockwise  $90^\circ$

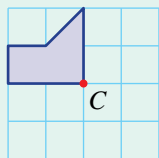

b clockwise  $180^\circ$

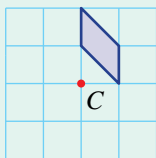

c anticlockwise  $270^\circ$

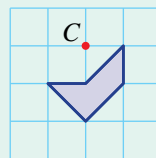

10D

8 For these congruent quadrilaterals, name the object in quadrilateral  $EFGH$  that corresponds to the given object in quadrilateral  $ABCD$ .

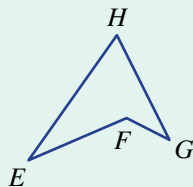
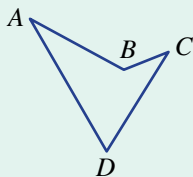

a i vertex  $B$

b i side  $AD$

c i  $\angle C$

ii vertex  $C$

ii side  $BC$

ii  $\angle A$

10E

9 Which of the tests SSS, SAS, AAS or RHS would you choose to explain the congruence of these pairs of triangles?

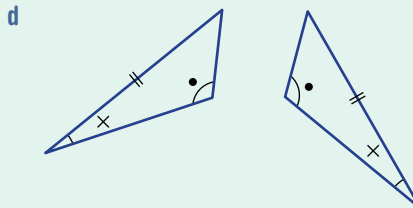
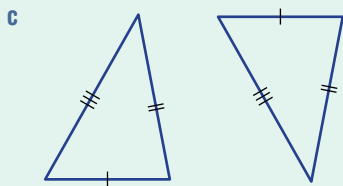
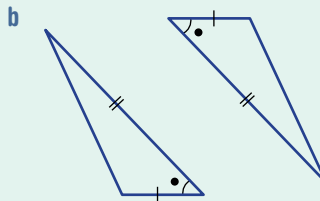
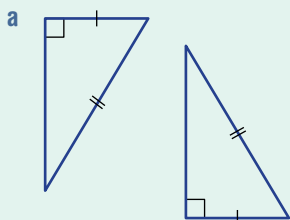

10E

10 Find the values of the pronumerals for these congruent triangles.

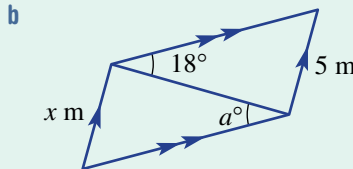
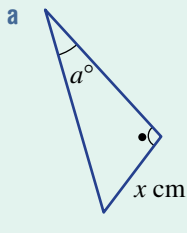

10F

11 Name the three regular polygons that tessellate.

Ext

10G

12 This quadrilateral is a parallelogram with two pairs of parallel sides. You can assume that  $AB = DC$  as shown.

Ext

- a Prove that  $\triangle ABE \equiv \triangle CDE$ .
- b Explain why  $BD$  and  $AC$  bisect each other.

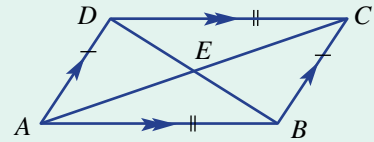

10G

13 This quadrilateral is a square with  $AE = EC$ .

Ext

- a Prove that  $\triangle ABE \equiv \triangle CBE$ .
- b Explain why the diagonals intersect at right angles.

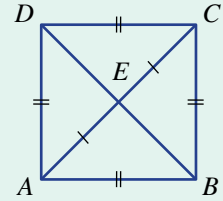

10H

14 For these similar shapes, complete the following tasks.

- a List the pairs of corresponding sides.
- b List the pairs of corresponding angles.
- c Find the scale factor.
- d Find the value of the pronumerals.

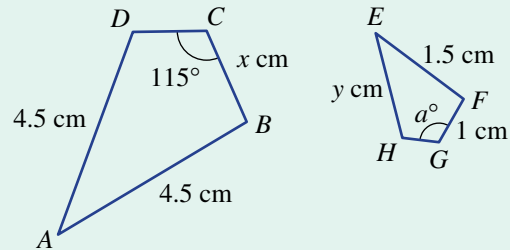

10I

15 Decide, with reasons, if these pairs of triangles are similar. State which tests (AAA, SSS, SAS or RHS) is used.

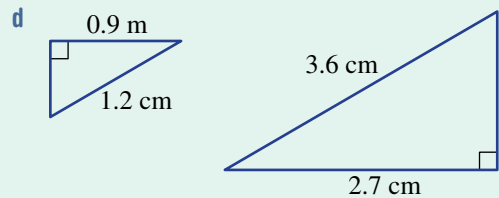
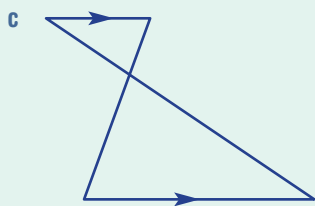
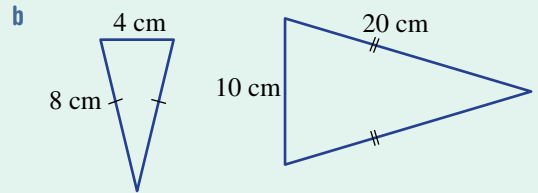
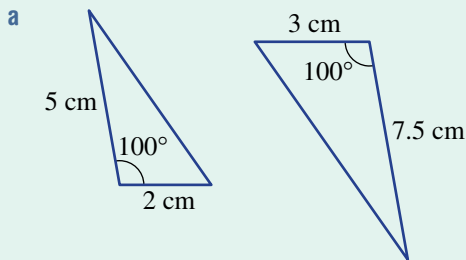

10I

- 16 Given that the triangles are similar, find the values of the pronumerals.

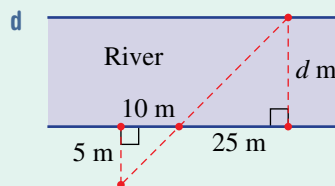
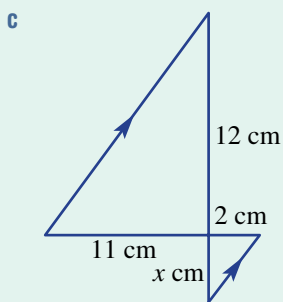
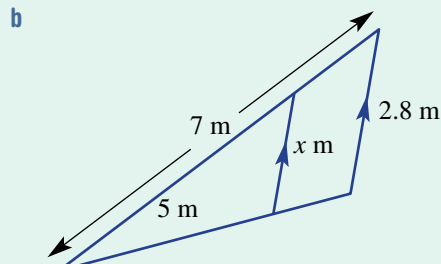
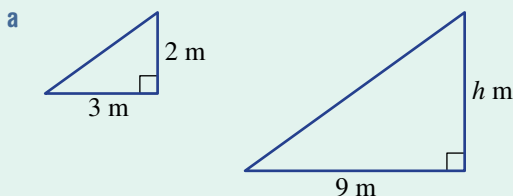

## Multiple-choice questions

10A

- 1 The number of lines of symmetry in a regular pentagon is:

A 10      B 5      C 2      D 1      E 0

10B

- 2 Which vector describes a translation of 5 units to the left and 3 units up?

A (3, -5)      B (-3, 5)      C (5, -3)      D (-5, 3)      E (-5, -3)

10B

- 3 The point
- $A(-3, 4)$
- is translated to the point
- $A'$
- by the vector
- $(6, -4)$
- . The coordinates of point
- $A'$
- are:

A (3, 8)      B (-9, 8)      C (3, 0)      D (0, 3)      E (-9, 0)

10C

- 4 An anticlockwise rotation of
- $125^\circ$
- about a point is the same as a clockwise rotation about the same point of:

A  $235^\circ$       B  $65^\circ$       C  $55^\circ$       D  $135^\circ$       E  $245^\circ$ 

10C

- 5 Point
- $A(1, 3)$
- is rotated clockwise about
- $C$
- by
- $90^\circ$
- to
- $A'$
- . The coordinates of
- $A'$
- are:

A (3, 0)      B (3, -1)      C (-3, 1)      D (-1, 3)      E (3, 1)

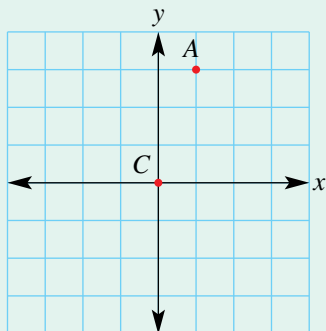

Questions 6, 7, and 8 relate to this pair of congruent triangles.

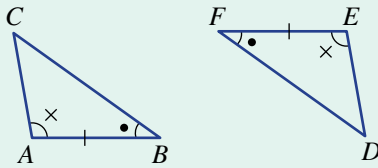

- 10D/E** 6 The angle on  $\triangle DEF$  that corresponds to  $\angle A$  is:  
**A**  $\angle C$       **B**  $\angle B$       **C**  $\angle F$       **D**  $\angle D$       **E**  $\angle E$
- 10D/E** 7 If  $AC = 5$  cm then  $ED$  is equal to:  
**A** 5 cm      **B** 10 cm      **C** 2.5 cm      **D** 15 cm      **E** 1 cm
- 10D/E** 8 A congruent statement with ordered vertices for the triangles is:  
**A**  $\triangle ABC \equiv \triangle FED$       **B**  $\triangle ABC \equiv \triangle EDF$       **C**  $\triangle ABC \equiv \triangle DFE$   
**D**  $\triangle ABC \equiv \triangle DEF$       **E**  $\triangle ABC \equiv \triangle EFD$
- 10I** 9 Which of the four tests (see **Section 10H**) would be chosen to show that these two triangles are similar?  
**A** AAS      **B** RHS      **C** SAS  
**D** AAA      **E** SSS
- 10H** 10 Two similar figures have a scale factor of 2.5 and the larger figure has a side length of 15 m. The length of the corresponding side on the smaller figure is:  
**A** 5 m      **B** 10 m      **C** 37.5 m      **D** 9 m      **E** 6 m

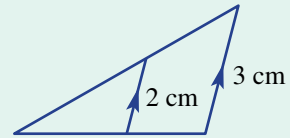

## Extended-response questions

- 1 The shape on this set of axes is to be transformed by a succession of transformations. The image of the first transformation is used to start the next transformation. For each set of transformations, write down the coordinates of the vertices  $A'$ ,  $B'$  and  $C'$  of the final image.
- Parts **a**, **b** and **c** are to be treated as separate questions.
- a** Set 1
- Reflection in the  $x$ -axis.
  - Translation by the vector  $(-2, 1)$ .
  - Rotation about  $(0, 0)$  by  $180^\circ$ .
- b** Set 2
- Rotation about  $(0, 0)$  clockwise by  $90^\circ$ .
  - Reflection in the  $y$ -axis.
  - Translation by the vector  $(5, 3)$ .

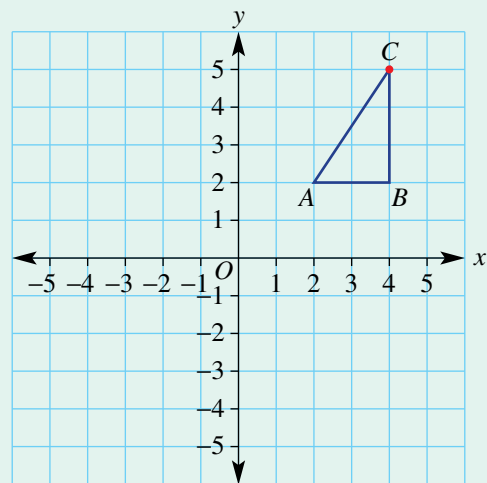

- c** Set 3
- Reflection in the line  $y = -x$ .
  - Translation by the vector  $(4, 2)$ .
  - Rotation about  $(1, 0)$  by  $90^\circ$  clockwise.

- 2 Three explorers come to a deep ice crevasse and wonder if they can jump across it. They notice a mound of snow on the other side of the crevasse ( $E$ ) and decided to build four other mounds ( $A$ ,  $B$ ,  $C$  and  $D$ ) on their side as shown.

- Why do you think the explorers built mounds  $B$  and  $D$  to be in line with the mound on the other side of the crevasse?
- What reasons are there to explain why the two triangles are similar?
- What is the scale factor?
- Can you help the explorers find the distance across the crevasse? What is the distance?

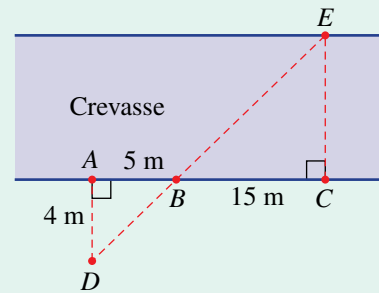

## Ratios and rates

### Short-answer questions

- Simplify these ratios.
 

a 24 to 36	b 15:30:45	c 0.6 m to 70 cm
d 15 cents to \$2	e $\frac{3}{4}$ to 2	f 60 cm to 2 m
- |                                      |                                      |
|--------------------------------------|--------------------------------------|
| a Divide 960 cm in the ratio of 3:2. | b Divide \$4000 in the ratio of 3:5. |
| c Divide \$8 in the ratio of 2:5:3.  |                                      |
- A 20-metre length of wire is used to fence a rectangular field with dimensions in the ratio 3:1. Calculate the area of the field.
- A business has a ratio of profit to costs of 5:8. If the costs were \$12 400, how much profit was made?
- Complete these rates.
 

a 5 g/min = _____ g/h	b \$240 in 8 hours = \$_____/h
c 450 km in $4\frac{1}{2}$ h = _____ km/h	
-  A shop sells  $1\frac{1}{2}$  kg bags of apples for \$3.40. Find the cost of one kilogram at this rate.
- A car travels the 1035 km from southern Sydney to Melbourne in 11.5 hours. Calculate its average speed.

### Multiple-choice questions

- The ratio of the length to the width of this rectangle is:
 

A 12:80	B 3:20
C 3:2	D 20:3

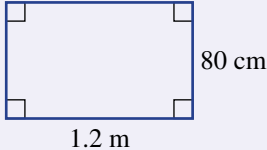
- Simplify the ratio 500 cm to  $\frac{3}{4}$  km.
 

A 2:3	B 1:150	C 3:2	D 150:1
-------	---------	-------	---------
- \$18 is divided in the ratio 2:3. The larger part is:
 

A \$3.60	B \$7.20	C \$10.80	D \$12
----------	----------	-----------	--------
- Calvin spent \$3 on his mobile phone card for every \$4 he spent on his email account. Calvin spent \$420 on his phone last year. How much did he spend on his email account for the same year?
 

A \$140	B \$315	C \$560	D \$240
---------	---------	---------	---------
- A boat sailed 30 kilometres in 90 minutes. What was the average speed of the boat?
 

A 15 km/h	B 45 km/h	C 3 km/h	D 20 km/h
-----------	-----------	----------	-----------

**Extended-response question**

A small car uses 30 litres of petrol to travel 495 km.

- a** At this rate, what is the maximum distance a small car can travel on 45 litres of petrol?  
**b** What is the average distance travelled per litre?  
**c** Find the number of litres used to travel 100 km, correct to one decimal place.  
**d** Petrol costs 117.9 cents/litre. Find the cost of petrol for the 495 km trip.  
**e** A larger car uses 42 litres of petrol to travel 378 km. The smaller car holds 36 litres of petrol while the larger car holds 68 litres. How much further can the larger car travel on a full tank of petrol?

**Equations and inequalities****Short-answer questions**

1 Solve each of these equations.

**a**  $3w = 27$

**b**  $12 = \frac{m}{6}$

**c**  $4 - x = 3$

**d**  $4a + 2 = 10$

**e**  $2w + 6 = 0$

**f**  $\frac{x}{5} - 1 = 6$

2 Solve each of these equations.

**a**  $6 = 4 - 4m$

**b**  $3a + 4 = 7a + 8$

**c**  $3(x + 5) = 15$

**d**  $\frac{x}{5} + \frac{x}{3} = 1$

**e**  $2(5 - a) = 3(2a - 1)$

**f**  $\frac{a + 7}{2a} = 3$

3 Double a number less three is the same as 9. What is the number?

4 A father is currently six times as old as his son. In 10 years' time his son will be 20 years younger than his dad. How old is the son now?

5 Write the inequality shown by each number line below.



6 Solve each of these inequalities.

**a**  $2x > -16$

**b**  $3x + 8 \leq 17$

**c**  $\frac{x}{5} - 6 \leq 0$

**Multiple-choice questions**

1 The sum of a number and three is doubled. The result is 12. This can be written as:

**A**  $x + 3 \times 2 = 12$

**B**  $2x + 6 = 12$

**C**  $2x + 3 = 12$

**D**  $x + 3 = 24$

2 The solution to the equation  $2m - 4 = 48$  is:

**A**  $m = 8$

**B**  $m = 22$

**C**  $m = 20$

**D**  $m = 26$

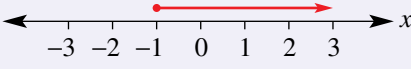

- 3 The solution to the equation  $-5(m - 4) = 30$  is:  
 A  $m = -10$                       B  $m = -2$                       C  $m = 2$                       D  $m = \frac{-34}{5}$
- 4 If  $\Delta < -5$ , then  $\Delta$  can have the value:  
 A 0                      B  $-\frac{1}{5}$                       C  $-6$                       D  $-4$
- 5 Which of the following inequalities is represented by the number line below?
- 
- A  $x \leq -1$                       B  $x \geq -1$                       C  $x > -1$                       D  $x < -1$

### Extended-response question

EM Publishing has fixed costs of \$1500 and production costs of \$5 per book. Each book has a retail price of \$17.

- Write an equation for the cost ( $C$ ) of producing  $n$  books.
- Write an equation for the revenue ( $R$ ) for selling  $n$  books.
- A company 'breaks even' when the cost of production equals the revenue from sales. How many books must the company sell to break even?
- Write an equation for the profit ( $P$ ) of selling  $n$  books.
- Calculate the profit if 200 books are sold.
- What is the profit if 100 books are sold? Explain the significance of this answer.

## Probability and statistics

### Short-answer questions

- 1 Find: **i** the mean, **ii** the median and **iii** the range of these data sets.
- 10, 15, 11, 14, 14, 16, 18, 12
  - 1, 8, 7, 29, 36, 57
  - 1.5, 6, 17.2, 16.4, 8.5, 10.4
- 2 For the data set 1, 1, 3, 5, 8, 8, 9, 10, 12, 17, 24, 30, find the:
- median score
  - lower quartile
  - upper quartile
  - interquartile range.
- 3 The mean mark for a Chemistry quiz for a class of 20 students was 16 out of 20. On the same quiz, another class of 15 students had a mean of 18 out of 20. What is the combined mean of all the students? Give your answer correct to one decimal place.
- 4 Calculate the mean and median for:
- 1, 2, 5, 10, 10, 13, 13, 18, 19, 24, 25, 28, 28, 30, 35

Score	Frequency
10	15
11	29
12	11
13	5

- 5 Draw a graph for the frequency table in Question 4b.
- 6 A six-sided die and a coin are tossed together. Write down all the outcomes using a table.
- 7 A bag contains 16 balls of equal size and shape. Of these balls, 7 are yellow, 1 is blue and the rest are black. If one ball is chosen from the bag at random, find the probability that it is:
- a yellow    b blue    c not blue  
d black    e pink.
- 8 The ages of 50 people at a party are shown in the table below.

Ages	0–9	10–19	20–29	30–39	40–49	50–59	60+
Frequency	3	7	1	28	6	2	3

If one person is chosen at random to a prepare a speech, find the probability that the person is aged:

- a 0–9    b 30 or older  
c in their twenties    d not in their fifties.

### Multiple-choice questions

- 1 For the set of numbers 3, 2, 1, 3, 5, 1, 3, 9, 3, 5 the mode is:  
A 3    B 3.5    C 8    D 35
- 2 Consider the data 8, 9, 10, 10, 16, 19, 20, 20. Which of the following statements is true?  
A Median = 13    B Mean = 13    C Mode = 13    D Range = 13
- 3 In a box there are 75 blue marbles and 25 pink marbles of the same size. If 12 marbles are drawn from the box, one at a time, at random and replaced each time, the most likely number of pink marbles is:  
A 6    B 3    C 12    D 9
- 4 A coin and a six-sided die are tossed together. The number of elements in the sample space is:  
A 2    B 6    C 12    D 8
- 5 A die is rolled 60 times. The number 4 appears exactly 24 times. The experimental probability of obtaining the number 4 is:  
A 0    B  $\frac{2}{5}$     C  $\frac{2}{3}$     D  $\frac{1}{6}$

### Extended-response question

Two groups of students have their pulse rates recorded as beats per minute. The results are listed here:

Group A: 65, 70, 82, 81, 67, 74, , 81, 88, 84, 72, 65, 66, 81, 72, 68, 86, 86

Group B: 83, 88, 78, 60, 81, 89, 91, 76, 78, 72, 86, 80, 64, 77, 62, 74, 87, 78

- a How many students are in group B?  
b If the median pulse rate for group A is 76, what number belongs in the ?  
c What is the median pulse rate for group B?  
d Which group has the largest interquartile range?

Ext

## Linear relationships

### Short-answer questions

1 In which quadrant does each point lie?

a (5, 1)

b (-3, 4)

c (-5, -1)

d (8, -3)

2 a Complete these tables of values.

i  $y = 2x + 1$

$x$	0	1	2	3
$y$				

ii  $y = 4 - x$

$x$	0	1	2	3
$y$				

b Sketch each line on the same number plane and state the point of intersection of the two lines.

3 a Give the equation of each line shown on this grid.

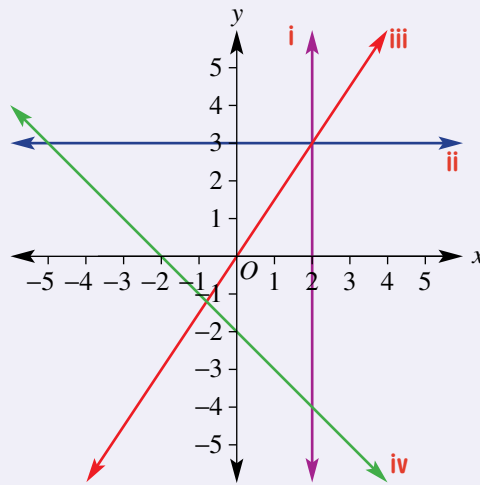

b Solve the inequality  $x - 1 > 2$  using this graph.

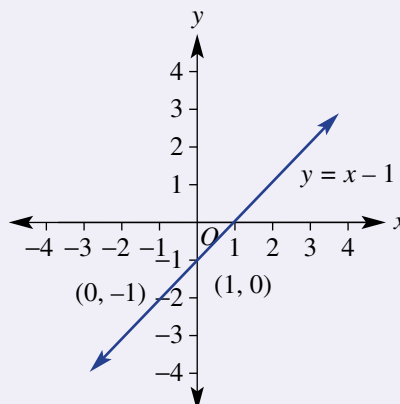

- Ext** 4 Consider the Cartesian plane shown in Question 3.
- Which line(s) has/have:
    - a positive gradient?
    - a negative gradient?
    - a zero gradient?
    - a gradient of 1.5?
  - Which lines intersect at the point  $(2, -4)$ ?
- Ext** 5 Sketch the curves  $y = x^2$  and  $y = 2x$  on the same number plane, by first completing a table of values with  $x$  from  $-2$  to 3. Write down the point of intersection of the two graphs in the first quadrant.

### Multiple-choice questions

- The point  $(2, -1)$  lies on the line with equation:
 

A  $y = 3x - 1$       B  $y = 3 - x$       C  $x + y = 3$       D  $y = 1 - x$
- The coordinates of the point 3 units directly above the origin is:
 

A  $(0, 0)$       B  $(0, 3)$       C  $(0, -3)$       D  $(3, 0)$
- The rule for the table of values shown is:
 

A  $y = 2x$       C  $y = 2(x + 2)$   
 B  $y = 2x + 2$       D  $y = x + 4$

$x$	0	2	4
$y$	4	8	12

- Ext** 4 The gradient of the line through  $A(4, 7)$  and  $B(8, -1)$  is:
- A  $-\frac{1}{2}$       B 2      C  $\frac{1}{2}$       D  $-2$
- Ext** 5 The equation of the line shown is:
- A  $y = 6x - 2$   
 B  $y = 3x - 2$   
 C  $y = x - 2$   
 D  $3y = x - 6$

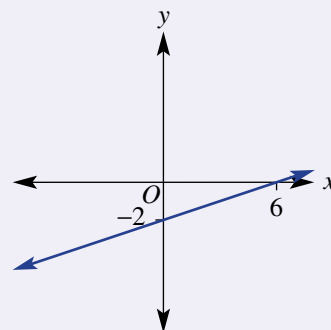

### Extended-response question

The cost ( $\$C$ ) of running a coffee shop is given by the rule  $C = 400 + 5n$ , where  $n$  is the number of customers on any given day. On average, a customer spends \$13.

- Write a rule for the coffee shop's expected daily revenue (income from customers).
- What is the fixed cost for the coffee shop on any given day? What could this be?
- Show the graphs of the rules for the cost and the revenue on the same set of axes by first completing two tables of values for  $n = 0, 5, 10, 15, \dots, 60$ .
- What is the 'break even' point for the coffee shop?
- If they are particularly busy on a Saturday and serve 100 people, calculate the shop's profit.

# Transformations and congruence

## Short-answer questions

- How many lines of symmetry does each of these shapes have?
  - scalene triangle
  - rhombus
  - rectangle
  - semicircle
- Write the vectors that translate each point  $P$  to its image  $P'$ .
  - $P(1, 1)$  to  $P'(3, 3)$
  - $P(-1, 4)$  to  $P'(-2, 2)$
- Triangle  $ABC$  is on a Cartesian plane as shown. List the coordinates of the image points  $A'$ ,  $B'$  and  $C'$  after:
  - a rotation  $90^\circ$  clockwise about  $(0, 0)$
  - a rotation  $180^\circ$  about  $(0, 0)$ .

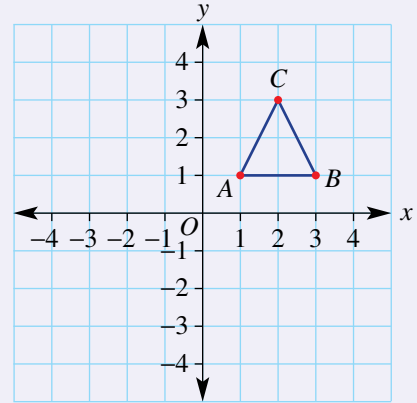

- Write the congruency test that would be used to prove that the following pairs of triangles are congruent.

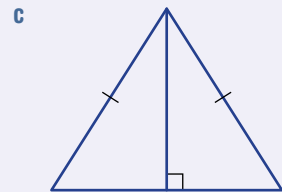
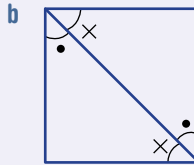
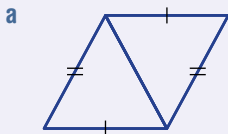

- Which two triangles are congruent?

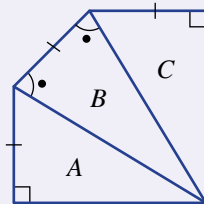

- Which two shapes in the diagram below are similar, and why?
  - Which vertex in  $\triangle AEC$  corresponds to vertex  $C$  in  $\triangle BDC$ ?
  - Find the value of  $x$ .

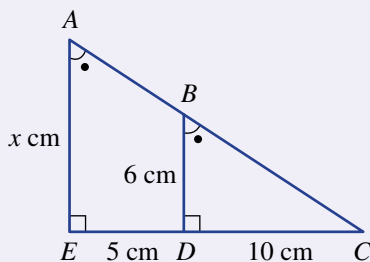

## Multiple-choice questions

1 The number of lines of symmetry in a square is:

- A 0                                      B 2                                      C 4                                      D 6

2 The side  $AC$  corresponds to:

- A  $XZ$                                       B  $XY$   
C  $ZY$                                       D  $BC$

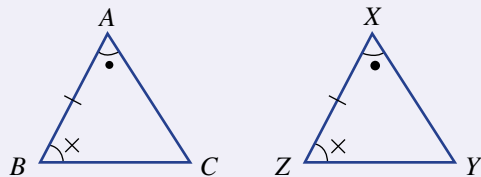

3 A congruence statement for these triangles is:

- A  $\triangle ABC \equiv \triangle CED$                       B  $\triangle ABC \equiv \triangle CDE$   
C  $\triangle ABC \equiv \triangle ECD$                       D  $\triangle ABC \equiv \triangle EDC$

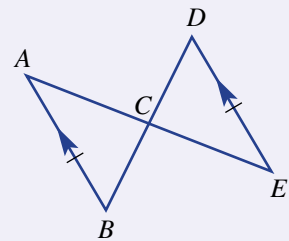

4 Which test is used to show triangle  $ABC$  congruent to triangle  $ADC$ ?

- A SSS                                      B SAS  
C AAS                                      D RHS

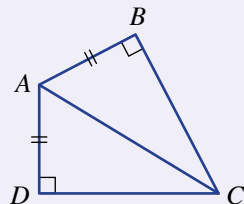

5 Which of the following codes is not enough to prove congruence for triangles?

- A SSS                                      B AAS                                      C AAA                                      D SAS

## Extended-response question

A circle of radius 3 cm is enlarged so that the ratio of old radius to new radius is 2:5.

- What is the diameter of the enlarged image?
- What is the ratio of the circumference of the original circle to its image?
- What is the ratio of their areas?
- If the ratio of a circle's area to its image becomes 9:100, what is the radius of the image?

# 11

## Algorithmic thinking

### Maths in context: Algorithms and elevators

The electronic controller for a building lift runs an algorithm which delivers people to their destination based on which buttons are pressed both inside the lift car and in lift waiting areas. The algorithm must accept the requests (inputs: which buttons are pressed) and deliver a result (output: the action of the lift car) so that passengers travel to where they want to go in an efficient manner. A basic algorithm for a lift is as follows:

- Continue travelling in the same direction if at least one request exists in that direction
- Remain stationary until new requests are made in either direction.

For multi-elevator systems, more complex algorithms are used. Requests are analysed and grouped so that requests for nearby building levels are serviced by one lift car, while other cars are left to service other levels. If lift waiting areas have two buttons (up or down), then this delivers more input

## Chapter contents

### Activity 1: Divisibility tests

### Activity 2: Working with lists of data

- 2.1 Sorting data
- 2.2 Searching in data
- 2.3 Generating lists of data  
(using simulation)

### Activity 3: Minimising and maximising in rectangles

- 3.1 Minimising perimeter
- 3.2 Maximising area

## Victorian Curriculum 2.0

This chapter covers the following content descriptors in the Victorian Curriculum 2.0:

VC2M8SP04

Please refer to the curriculum support documentation in the teacher resources for a full and comprehensive mapping of this chapter to the related curriculum content descriptors.

© VCAA

## Online resources

A host of additional online resources are included as part of your Interactive Textbook, including HOTmaths content, video demonstrations of all worked examples, auto-marked quizzes and much more.

to the algorithm. The algorithm can assess the direction of the request as well as the floor that the request was made. Further programming enhancements might cater for when a lift, stopping at multiple floors in one direction, is likely to be full. This may be the case early in the morning when many people head to work at a similar time.

An efficient lift algorithm will reduce waiting time for passengers and minimise wear and tear on the mechanics of the lift.



## Introduction

An **algorithm** is a procedure involving a number of steps that eventually leads to the answer of a problem. There should be clearly defined inputs and outputs.

For example:

- The highest common factor (HCF) algorithm has two inputs like 36 and 54, and gives the output 18.
- The fraction division algorithm has two inputs like  $\frac{2}{5}$  and  $\frac{3}{4}$  and gives the output  $\frac{8}{15}$ .

Algorithms occur in mathematics and computing, as well as in simple areas of daily life such as following a recipe. Algorithmic thinking is a type of thinking that involves designing algorithms to solve problems. The algorithms we design can then be written in a way that a computer program will understand, so that the computer does the hard computational work.

In the following activities you will carry out some algorithms as well as think about the design, analysis and implementation of your own algorithms.

The algorithms in these activities will be described through the use of spreadsheets, flow charts (a way of writing an algorithm in the form of a diagram), programming languages and simulations. The following symbols will be used in the flow charts with arrows to connect each stage:



for input/output stages



for process stages

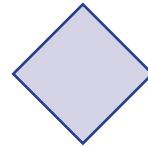

for decision stages



# Activity 1: Divisibility tests

STRANDS: NUMBER, ALGEBRA

a The flow chart below takes a number and tells you whether it is divisible by 10 or not.

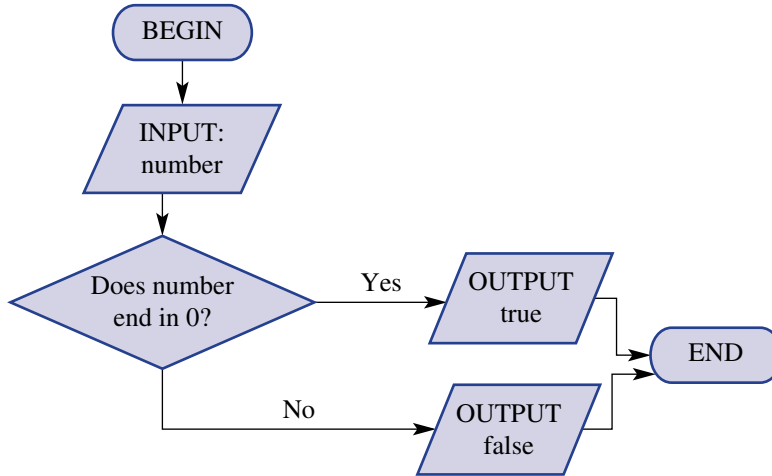

- i What changes are required to the original flow chart to test if a number is divisible by 5?
  - ii What changes are required to the original flow chart to test if a number is divisible by 2?
  - iii Jonty has attempted to test if a number is divisible by 4, so he has changed the conditional step to the following test: 'Does number end in 0, 4 or 8?' Explain what is wrong with this, giving examples of numbers that it incorrectly classifies as divisible by 4 and numbers that it incorrectly classifies as not divisible by 4.
- b i Testing for divisibility by 3 involves looping. Describe what happens if the input number is 831 in the flow chart below.

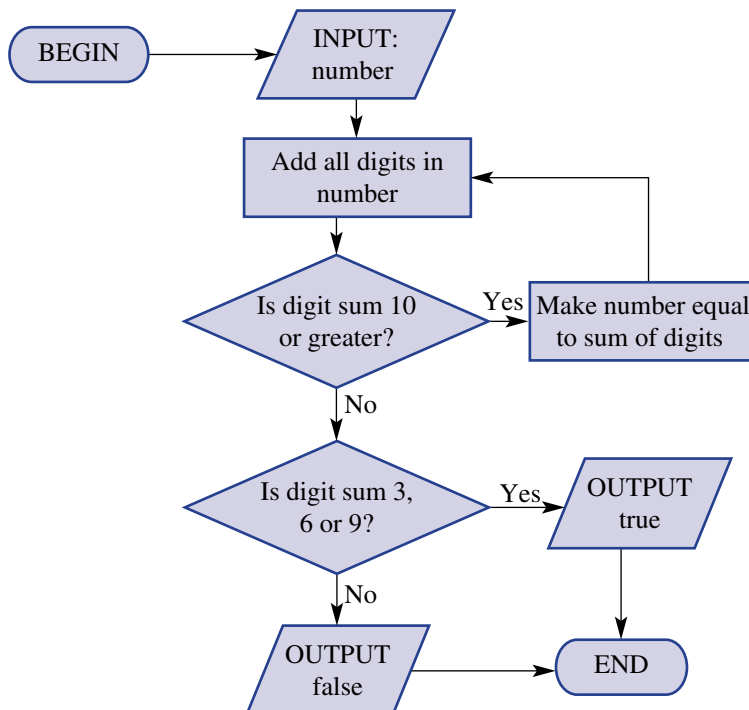

- ii Teale has simplified the flow chart to remove the test for numbers whose digits sum to 10 or greater. This algorithm works on some numbers (for instance, 195) but not on other numbers (for instance, 196). Explain clearly what is wrong with it and why it does not always work.

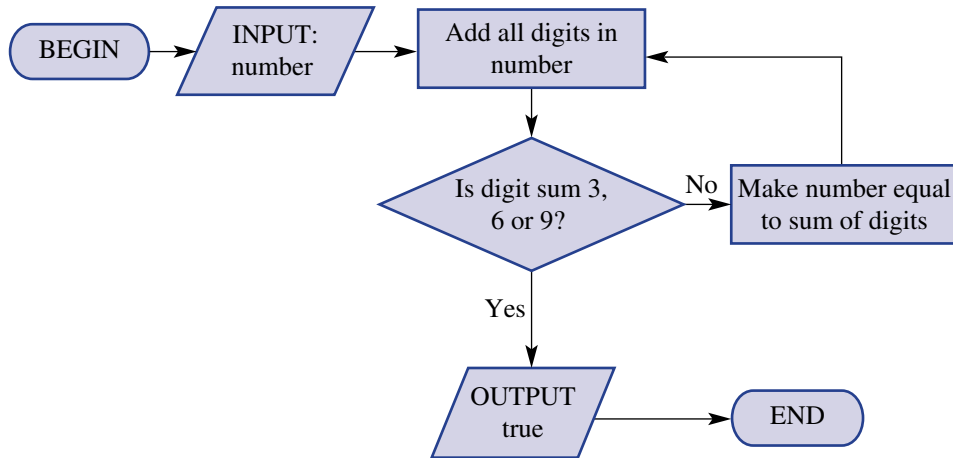

- iii Draw a flow chart for the algorithm that tests to see if a number is divisible by 9. Recall that divisibility by 9 involves adding up the digits to see if the sum is divisible by 9. Remember to make sure that your flow chart will not loop around forever.
- c You can assume now that you have algorithms to test if a number is divisible by the numbers 2, 3, 5, 9 and 10.
- Describe how you could combine these algorithms to test if a number is divisible by 6.
  - Describe how you could combine these algorithms to test if a number is divisible by 45.
  - Describe how you could combine these algorithms to test if a number is divisible by 9 but not by 18.
  - What other numbers can you test for divisibility by combining these algorithms?



## Activity 2: Working with lists of data

STRANDS: STATISTICS, PROBABILITY

### 2.1 Sorting data

In order to find the median or interquartile range of a list of numbers we first need to sort the list in ascending order.

Sample input: [12, 1, 3, 8, 2, 7]

Sample output: [1, 2, 3, 7, 8, 12]

One algorithm, called ‘Selection Sort’, is as follows:

Step 1. Make a new (empty) output list.

Step 2. Find the smallest number in the input list.

Step 3. Remove it from the input list and put it at the end of the output list.

Step 4. Repeat steps 2 and 3 until the input list is empty.

In a high-level programming language, it might look something like the following.

Line	Command	Explanation
1	<code>output ← []</code>	Set the output list to be empty
2	<code>loop:</code>	Perform lines 3 to 6 forever (until you hit <code>break</code> )
3	<code>current ← min(input)</code>	Find the minimum value in the input list
4	<code>input.remove(current)</code>	Remove one copy of current minimum from input
5	<code>output.append(current)</code>	Put current minimum at the end of the output list
6	<code>if input = []: break</code>	If we reach an empty input list, we leave this loop
7	<code>display output</code>	At the end we need to display the output

A computer can run this program line by line. The execution is shown below on the input list [7, 1, 5] and takes 15 steps.

Line	Command	Result
1	<code>output ← []</code>	output is set to the be the empty list
2	<code>loop:</code>	Get ready to repeat lines 3 to 6
3	<code>current ← min(input)</code>	current is now 1
4	<code>input.remove(current)</code>	input is now [7, 5]
5	<code>output.append(current)</code>	output is now [1]
6	<code>if input = []: break</code>	No effect, because input is not empty.
3	<code>current ← min(input)</code>	current is now 5
4	<code>input.remove(current)</code>	input is now [7]
5	<code>output.append(current)</code>	output is now [1, 5]
6	<code>if input = []: break</code>	No effect, because input is not empty.
3	<code>current ← min(input)</code>	current is now 7
4	<code>input.remove(current)</code>	input is now []
5	<code>output.append(current)</code>	output is now [1, 5, 7]
6	<code>if input = []: break</code>	Exit the loop, because input is empty.
7	<code>display output</code>	Displays the list output which is [1, 5, 7]

- a Show the step-by-step result of running the program on the input list [5, 8, 2]. Your results should be shown in a table like the one below.

Line	Result
1	output is []
2	Begin loop
3	current is 2
4	input is [5, 8]
5	output is [2]
6	No action
3	current is 5
...	...

- b Estimate how many execution steps would be required on an input list with 100 numbers in it.
- c A ‘bug’ in a program or algorithm is a step that means the algorithm no longer gives the desired results. For each of the following bugs, explain the effect of it by first demonstrating what the algorithm will do with a sample input list like [5, 8, 2].
- Describe the effect of changing the algorithm so that it puts the current minimum at the *start* of the output list rather than at the *end*.
  - Describe the effect of changing the algorithm so that it does not remove the current minimum from the input list.
  - Describe the effect of changing the variable `input` in line 6 to `output`.

## 2.2 Searching in data

In a set of data, it is sometimes necessary to search through for a particular value.

- a Consider the following algorithm to search for the number 100 in the input list.
- Step 1: Look at the first item in the list.  
 Step 2: If it is 100 then output the value ‘Found’.  
 Step 3: Look at the next item in the list.  
 Step 4: Repeat steps 2 and 3 until you get to the end of the list or until you find 100.  
 Step 5: Output ‘Not Found’ if you have not found the number 100.
- If the input list is [3, 9, 100, 2, 17, 52], describe what this algorithm does.
  - If the input list is [2, 6, 1, 7, 3, 5], describe what this algorithm does.
  - What will be the output if the input list is [100, 3, 50, 100, 75]?
- b With a large set of data, it is usually helpful to have the data sorted first in ascending order. For instance, a dictionary or a large phone list is sorted alphabetically to allow people to find values quickly. Page numbers in a book are also sorted, which can help you find a page easily. Describe how you could quickly find page 381 in a book that was 1000 pages long.

c Here is an algorithm to find page 381 in a book.

Line	Command	Explanation
1	<code>lower ← 0</code>	The page must be greater than 0
2	<code>upper ← 1000</code>	The page is at most 1000
3	<code>loop:</code>	Performs lines 4 to 7 indefinitely (until you hit <code>break</code> )
4	<code>page ← round((lower + upper) / 2)</code>	Find the middle page in the range
5	<code>if page = 381: break</code>	If we find the page, leave the loop
6	<code>if page &gt; 381: upper ← page</code>	If we are too high then this becomes the new upper bound
7	<code>if page &lt; 381: lower ← page</code>	If we are too low then this becomes the new lower bound
8	<code>display contents of page</code>	Outside the loop, display the contents of the page we found

i Construct a table like the one below to show how the bounds change each loop.

Loop number	lower	upper
0	0	1000
1	0	500
2	250	500
...	...	...

ii Describe how this algorithm performs compared to an algorithm that looks at each page from 1 to 381. You should include a comparison of roughly how many steps each takes.

d Emily has written an algorithm to search for page 210 in a 400 page book.

Line	Command
1	<code>lower ← 0</code>
2	<code>upper ← 400</code>
3	<code>loop:</code>
4	<code>item ← round((lower + upper) / 2)</code>
5	<code>if page = 210: break</code>
6	<code>if page &lt; 210: upper ← page</code>
7	<code>if page &gt; 210: lower ← page</code>
8	<code>display contents of page</code>

i Construct a table like the one below to show how the bounds change each loop.

Loop number	lower	upper
0	0	400
...	...	...

ii Explain what the error is in Emily's algorithm and how to fix it.

## 2.3 Generating lists of data (using simulation)

When investigating the probability of an event occurring, it is often helpful to use a simulation. For example, if two dice are rolled, we might want to know the probability of obtaining a sum of 10. An algorithm to do this is:

- Step 1: Roll two dice 500 times.
- Step 2: For each pair of dice, find the sum of the faces.
- Step 3: Count how many times the number 10 occurs.
- Step 4: Divide this by 500 to estimate the probability.

This algorithm could be implemented in programming code like the following.

Line	Command
1	trials $\leftarrow$ 0
2	successes $\leftarrow$ 0
3	loop:
4	trials $\leftarrow$ trials + 1
5	die1 $\leftarrow$ randint(1,6)
6	die2 $\leftarrow$ randint(1,6)
7	if die1 + die2 = 10 : successes $\leftarrow$ successes + 1
8	if trials = 500: break
9	display successes/trials

An alternative way to explore the experimental probability is with a spreadsheet.

- a Set up a table in a spreadsheet to randomly generate 500 outcomes for tossing two dice like the one below.

	A	B	C	D	E
1	Rolling two dice				
2					
3	Die 1	Die 2	Sum	Possible Sum	Count
4	=RANDBETWEEN(1,6)	=RANDBETWEEN(1,6)	=A4+B4	2	=COUNTIF(C\$4:C\$503,D4)
5	=RANDBETWEEN(1,6)	=RANDBETWEEN(1,6)	=A5+B5	3	=COUNTIF(C\$4:C\$503,D5)
6	=RANDBETWEEN(1,6)	=RANDBETWEEN(1,6)	=A5+B6	4	=COUNTIF(C\$4:C\$503,D6)
7	=RANDBETWEEN(1,6)	=RANDBETWEEN(1,6)	=A5+B7	5	=COUNTIF(C\$4:C\$503,D7)
8	=RANDBETWEEN(1,6)	=RANDBETWEEN(1,6)	=A5+B8	6	=COUNTIF(C\$4:C\$503,D8)
9	=RANDBETWEEN(1,6)	=RANDBETWEEN(1,6)	=A5+B9	7	=COUNTIF(C\$4:C\$503,D9)
10	=RANDBETWEEN(1,6)	=RANDBETWEEN(1,6)	=A5+B10	8	=COUNTIF(C\$4:C\$503,D10)
11	=RANDBETWEEN(1,6)	=RANDBETWEEN(1,6)	=A5+B11	9	=COUNTIF(C\$4:C\$503,D11)
12	=RANDBETWEEN(1,6)	=RANDBETWEEN(1,6)	=A5+B12	10	=COUNTIF(C\$4:C\$503,D12)
13	=RANDBETWEEN(1,6)	=RANDBETWEEN(1,6)	=A5+B13	11	=COUNTIF(C\$4:C\$503,D13)
14	=RANDBETWEEN(1,6)	=RANDBETWEEN(1,6)	=A5+B14	12	=COUNTIF(C\$4:C\$503,D14)
15	=RANDBETWEEN(1,6)	=RANDBETWEEN(1,6)	=A5+B15		

- b Using spreadsheet software, plot the number of times each sum from 2 to 12 is achieved as a 2D column graph. Comment on the shape of the graph that is produced.
- c Comment on the number of times different sums occurred. For instance, which sums are most likely and which sums are least likely? Why do you think this is?

- d Add a column to calculate the experimental probability by dividing the count by the number of trials. To count the number of trials you could use a formula like = COUNT(A:A)
- e Describe an algorithm that you could use to find the theoretical probability of two dice adding up to 10.
- Ext** f Modify your spreadsheet to conduct a large simulation (1000 or more rows) of rolling three dice and noting the sums; it should show the experimental probability of each sum from 3 to 18. Use the spreadsheet software to generate a frequency column graph of these experimental probabilities and comment on what you notice about these probabilities.





## Activity 3: Minimising and maximising in rectangles

STRANDS: MEASUREMENT, SPACE

### 3.1 Minimising perimeter

If a rectangle has an area of  $60 \text{ metres}^2$ , what is the smallest perimeter it can have?

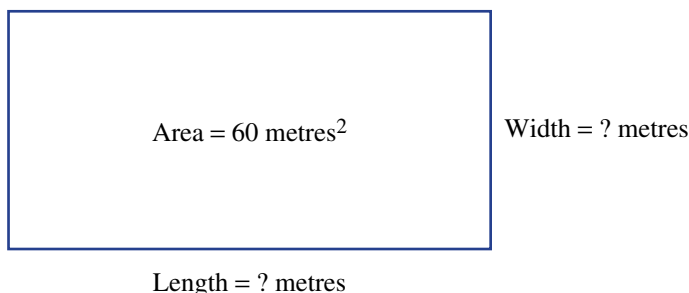

One algorithm that could be used to solve this problem is:

Step 1: Guess a value for the width.

Step 2: Calculate the length by dividing 60 by the width.

Step 3: Calculate the perimeter of this rectangle ( $2 \times \text{width} + 2 \times \text{length}$ ).

Step 4: If this perimeter is smaller than the best answer found so far (or if this is the first time completing Step 4), make this the new 'best answer'.

Step 5: Reduce or increase the value for width by a small amount and repeat. When the perimeter cannot get smaller when you change the value of width in either direction, stop looping and give this as the minimum perimeter.

**a** Copy and complete the following table, which reflects a few iterations of this algorithm.

Width	Length	Perimeter
20	3	46
10	6	
2		
5		
7.5		

Because a spreadsheet includes dynamic and interactive calculation abilities, it is a good tool to implement this algorithm.

**b** Fill out the following in a spreadsheet, using the initial guess of the width of 20. Change the width value to check your answer(s) in part **a**.

	A	B	C
1	Width	Length	Perimeter
2	20	=60/A2	=A2*2+B2*2

- c Using trial and error, find the minimum perimeter. Draw a picture of this rectangle roughly to scale. (Remember, you are allowed to have a width and length that are decimals; keep going until you get the minimum possible perimeter.)
- Ext** d Design another algorithm that takes as input a value for the area (like 60) and outputs the minimum perimeter without performing any loops/trial and error. Check that your algorithm gives the same result as part c when the input is 60, and explain why it works in general.

### 3.2 Maximising area

If a rectangle has a perimeter of 60 metres, what is the maximum area it can have?

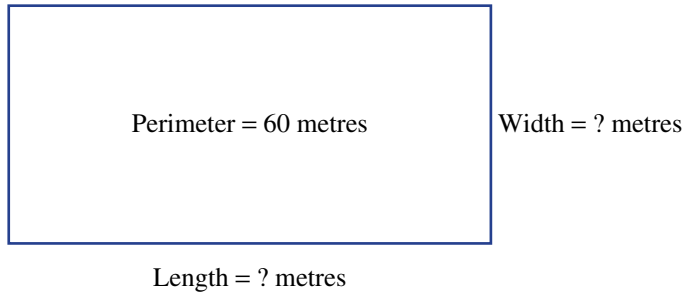

- a i If the width is 20 metres, what is the length of the rectangle? Remember that the perimeter includes two lots of the length and two lots of the width.
- ii Describe an algorithm for calculating the length of the rectangle once its width is known.
- iii Describe an algorithm for calculating the area of the rectangle once its width is known.
- b Set up a spreadsheet as follows. What is the formula that needs to go in E2 to calculate the area of the rectangle?

	A	B	C	D	E
1	Width	Double Width	Double Length	Length	Area
2	20	=A2*2	=60-B2	=C2/2	????

- c Using trial and error, find the maximum value of the area of a rectangle with perimeter 60 metres. Draw a diagram of the rectangle that is formed.
- Ext** d Design another algorithm that takes as input a value for the perimeter (like 60) and outputs the maximum area without performing any loops/trial and error. Check that your algorithm gives the same result as part c, and explain why it works in general.

# Index

- AAS 765–6, 797  
 acute angles 65, 78  
 addition 4, 6, 27–8, 32–4, 44, 142, 144–6,  
 153, 164–6, 241, 244, 263, 347, 356  
 algebra 336–9, 376–7  
 algebraic expressions 344, 376, 381, 384,  
 516, 518  
 algebraic fractions 355–7, 360–2  
 algebraic method 485–7, 492–3, 683–6  
 algorithms 5–6, 9, 11  
 alternate angles 70–2  
 angle sum 65, 71, 77–9, 85–6, 94, 96  
 angles 64, 66, 72–3, 96, 100, 262, 751,  
 783, 789, 792  
 apex 103  
 appreciation 193  
 approximation 172, 234, 257, 307  
 arcs 751–2, 767  
 area 240–1, 243, 249–51, 255–7, 262–5,  
 269–70, 501–3, 511, 787  
 arithmetic 6, 20, 342–3, 366  
 ascending order 136, 303–4, 491, 577  
 associative law 5, 10, 343  
 average 572  
 average rates 439–40  
 average speed 449–52  
 axes 108, 563, 566, 642  
 axioms 64, 70  
  
 base angles 79  
 bases 103, 241, 384  
 bearings 65  
 biased samples 584  
 bi-modal data 572, 584  
 bisecting diagonals 782, 784  
 brackets 44–5, 366–8, 372, 501–3  
  
 calculators 235–6, 256–7, 293  
 cancelling 137, 143, 147, 181, 188–9,  
 194–5, 360, 385  
 capacity 277–9  
 cartesian planes 642–4, 669  
 categorical data 548  
 census 584  
 centimetre 227, 240–1  
 central tendency 572  
 centre, measures of 571–2  
 centre of rotation 751–2  
 change 200–1, 439, 444, 457, 707, 709–10  
 circles 64, 234–5, 255–7, 283, 523  
 circular arcs 751–2  
 circumference 234–6  
 cluster of points 563  
 coefficients 337, 652  
 co-interior angles 70–2  
 column graphs 549–50  
 common factors 351–2, 360, 418  
 common multiples 15, 143  
  
 commutative law 4–5, 10, 343, 347  
 comparison 158–9, 186, 383, 438–9  
 compensating 5  
 complement 593–5  
 complementary angles 65  
 composite numbers 14–15, 136  
 composite shapes 241, 244–5, 262–5  
 concave shapes 86, 95  
 congruence 738, 766, 782–4  
 congruent ends 103, 269  
 congruent figures 758–60, 790  
 congruent triangles 764–5, 784  
 constant cross-section 269  
 constant speed 450  
 constant terms 337  
 constants 652  
 continuous data 548  
 convenience samples 584  
 convention 41, 171, 419, 439  
 conversion 139, 143, 146–7, 157–60, 171,  
 173, 178–81, 187–8, 228, 243, 278,  
 293–4, 366, 419, 421, 432–4, 450,  
 460–1  
 convex shapes 86, 95  
 coordinates 108–9, 111–12, 646–8, 663,  
 669, 741  
 corresponding angles 70–2, 764, 789,  
 791–2  
 corresponding pairs 760  
 corresponding parts 759, 789, 791  
 critical digits 172, 174  
 cross-section 103, 269, 283, 291  
 cube (of numbers) 15, 17  
 cube roots 15, 17  
 cubes/cuboids 103, 278  
 cubic units 278  
 curved surfaces 103  
 curves 646, 713  
 cylinders 103, 283–6  
  
 dashed lines 670  
 data/collection 548, 558, 607  
 day 292  
 decimal places/points 157–60, 164–7, 171,  
 174, 182, 192, 234–6, 256, 258, 264,  
 286, 290, 314  
 decimal system 4  
 decimals 157–60, 164–5, 167–8, 178–9,  
 181–2, 198, 308, 593  
 denominators 136–7, 143–4, 158, 178,  
 187, 355–7, 360, 421, 491  
 depreciation 192–3  
 descending order 136  
 description 72, 111, 341, 377, 480, 670  
 diagonals 86, 782–4  
 diameter 234–5  
 difference 4–6, 37–8, 201, 337  
 dilation 738  
  
 dimension 431  
 direction 746  
 discount 192–3, 195, 200, 208  
 discrete data 548  
 distance 227, 431, 433–4, 449, 451–2, 690,  
 705–7, 710, 739, 746, 796–9  
 distributive law 10, 366–8, 503  
 divided bar graphs 549  
 dividend 10  
 divisibility/tests 20–3  
 division 9, 39, 41, 45, 137, 144, 148, 154,  
 165, 167–8, 179, 351–2, 360–2, 385,  
 427–8  
 division algorithm 11  
 divisors 10, 165  
 dot plots 562, 564–5  
 dots 172  
 doubling 5, 10  
  
 edges 102  
 equal angles 71–2  
 equality 478, 518, 789  
 equations 307, 478–80, 491–2, 496–8,  
 501–3, 518–20  
 equilateral triangles 77  
 equivalence 342–4, 347, 372, 496, 523  
 equivalent equations 484–7, 498–8, 501  
 equivalent fractions 136–8, 158, 179  
 equivalent ratios 419–20, 426–8  
 error 201, 255, 584  
 estimation 5, 37–8, 178, 255, 444, 592, 621–2  
 Euler's formula 102, 104  
 evaluation 44–6, 342  
 events 592–5, 614  
 expanded form 383–4, 388  
 expanding brackets 366–8, 502–3  
 expected number 621  
 experiment 592, 599–601, 621  
 experimental probability 621–3  
 expressions 20, 44, 336, 342–4, 355, 377,  
 478, 511  
 exterior angle theorem 78, 80  
  
 faces 102, 104–5, 270  
 factor trees 20, 22  
 factorising 372–4  
 factors 14–15, 136, 351  
 false equations 478–9  
 figures 758  
 fluid 278  
 formulas 249, 262, 450, 511–12  
 fractions 139, 142–5, 147–8, 157, 159–60,  
 173, 178–81, 187, 198, 234, 263, 421,  
 426, 491–3, 593  
 frequency graphs 565–6  
 frequency tables 556, 558,  
 562–6  
 full lines 670

- gas 278  
 geometry 64  
 gradient 690–3, 705  
 gradient–intercept form 698–700  
 graphs 548–51, 562–6, 646–8, 654, 659–60, 669, 674, 700, 707–10  
 grid spaces 110–11  
 groups/grouping 563, 577  
 GST 193
- halves 355  
 halving 5, 10  
 hectares 240–1  
 hexagonal prisms 103  
 hidden transversals 70  
 highest common factor (HCF) 15–16, 21, 23, 136, 139, 181, 372–4, 418–19  
 Hindu-Arabic number system 4  
 horizontal lines 669–70, 672  
 hour 292  
 hypotenuse 301–2, 308–9, 313, 765
- images 738–40, 748, 754, 789  
 improper fractions 136, 145, 181, 421  
 increase 193  
 independence 599–601  
 index (indices) 384, 388–9  
 index laws 383, 385, 389  
 index notation 384  
 inequality 523–5, 528–30, 669–70, 672–4  
 integers 41, 46  
 intercepts 698–700  
 interior angles 78, 85, 94–5, 97, 100  
 interpretation 548–50, 557, 566–7, 585–6  
 interquartile range (IQR) 577, 579  
 intersection 65, 70, 642, 659, 663  
 intervals 556, 566  
 irrational numbers 234, 307  
 isometric transformation 738–9  
 isosceles triangles 77
- kilometre 227, 240–1  
 kites 86, 249–50, 782
- left-hand side (LHS) 479–80, 485–6, 498, 511, 523, 528–9, 659–60  
 length 226, 228, 250, 302, 308–9, 313, 449, 511, 799  
 letters 709  
 like terms 347–8, 357, 368, 501, 520  
 limits 255  
 line graphs 549  
 linear equations 706  
 linear graphs 662  
 linear relationships 646–8, 660, 709  
 lines 648, 669, 672  
 lines of symmetry 739  
 location, measures of 572  
 loss 193, 200–2  
 lower quartile 577–9
- lowest common denominator (LCD) 136, 143, 153, 355–7, 419, 421  
 lowest common multiple (LCM) 15–16, 20, 23, 136, 143, 153
- mark-ups 192–3, 195  
 mean 571–3, 606  
 measurement errors 584  
 measures of centre 571–2  
 measures of spread 577–9  
 median 571–3  
 mental strategies 9, 11  
 metre 226–7, 240–1  
 metric system 226, 277  
 millimetre 227, 240–1  
 minute 292  
 mirror line 738–40  
 mixed numerals 136, 145–6, 180–1  
 mode 571–3  
 modelling 376  
 motion 746  
 multiples 14–15, 136, 355–7  
 multiplication 9, 11, 39, 41, 45, 137, 143–4, 147, 154, 164–5, 167, 179, 187, 206, 250, 351–2, 360–1, 384, 459  
 mutual exclusion 614
- negative fractions 151–4  
 negative gradient 691  
 negative integers 26–7, 32–4, 39–40, 746  
 nets 269–70  
 non-convex polygons 95  
 non-convex quadrilaterals 86  
 non-linear graphs 713–15  
 notation 384  
 number lines 27, 137, 151, 524  
 number planes 642, 644  
 numbers/properties 14, 20, 342  
 numerators 136, 144, 158, 187, 355–7, 360  
 numerical data 548, 578
- observed probability 621–2  
 obtuse angles 65, 78  
 ‘one unit’ 206, 458  
 operations 5, 44–6, 136, 142–4, 151–2, 164–5, 347, 351, 484, 528  
 opposite numbers 33, 152  
 ‘or’ 614  
 order of operations 44–6, 136, 158, 347, 351, 577  
 order of rotational symmetry 752–3  
 origin 642, 644  
 outcome 592, 599–600, 608–10  
 outliers 563, 572, 578
- pairs 70–1, 348, 523  
 parabola 714  
 parallel lines 70–3  
 parallel sides 782  
 parallelograms 86, 103, 241, 249, 269, 283, 751, 782–3
- partitioning 5  
 parts 136, 157, 426, 458  
 patterns 39, 171, 173, 562  
 percentage profit/loss/error/change 200–2  
 percentages 178–82, 186–9, 192, 194, 198, 206–7, 593  
 perfect squares 15  
 perimeter 226–9, 511  
 perpendicular height 250  
 perpendicular lines 65, 241, 244  
 pi 234  
 pie charts 549–50  
 place value 157  
 plots 562–6, 642, 644, 648, 710, 715  
 points 64, 66, 111–12, 226, 563, 642, 644, 648, 714  
 points of intersection 659, 663  
 polygons 94–6  
 polyhedrons 102–3, 105  
 population 583–4  
 position 108, 642  
 positive fractions 152  
 positive gradient 691  
 positive integers 4, 9, 15, 27–8, 39–40, 523  
 powers 20, 44, 46, 158, 165, 167, 347, 384–5, 388–9  
 price decrease/increase 192–4, 198  
 prime factor 20–2  
 prime factorisation 20, 23  
 prime numbers 14–15, 20  
 prisms 103, 269–71, 278–9, 283–5  
 probability 592–5, 600, 610, 613, 616, 621–3  
 problem solving 14, 37–8, 100–1, 198–9, 202, 206, 290–1, 380–1, 425–8, 444–6, 455–7, 485, 492–3, 507–8, 516–17, 519–20, 528–30, 605–7, 659–60, 662–3, 669, 674, 705–6, 787–8  
 product 9, 20, 39–40, 152, 337  
 profit 193, 200–2  
 pronumerals 45, 64, 336, 342, 347–8, 496–8, 519  
 proper fractions 136  
 proportion 136, 186  
 pyramids 103  
 Pythagoras’ theorem 301–3, 307–8, 313–15  
 Pythagorean triples 301–3
- quadrants 256, 258, 642  
 quadratic equations 507–8  
 quadrilaterals 85–8, 249–51, 782–4  
 quantity 88, 186–9, 229, 313–14, 336, 427, 439  
 quotient 10, 39–40, 152, 165, 337
- radii 64, 235, 255–6, 262, 759  
 range 523, 556, 577, 579  
 rates 438–40, 444–6, 451, 457–61, 707, 709

- ratios 256, 418–22, 425–8, 431–5, 438, 455, 458–61, 789
- real-world situations 518, 525
- reciprocals 136, 144, 154, 360–1
- rectangles 86, 241, 249, 255, 501–3, 713, 782–3
- rectangular prisms 278–9
- recurring decimals 158, 171–4
- reduction 193
- reference points 642
- reflection 738–41
- reflection translation 738
- reflex angles 65
- reflex interior angle 95
- regions 673–4
- regular polygon 775
- regular polygons 95, 97
- regular tessellations 775
- related angles 72
- relationships 511–12, 516, 520, 646–8, 660, 707, 713
- relative frequency 621
- remainder 10
- repeated addition 39
- repeated multiplication 384
- repeating decimals 171
- representative information 583–4
- results 548
- revolution 65
- rhombus 86, 249–50, 782–3
- RHS 765–6, 797
- right angles 64–5, 78, 108, 241, 642
- right prisms 103, 269
- right-angled triangles 301, 307–9, 313–15
- right-hand side (RHS) 479–80, 485–6, 498, 511, 523, 528–9, 659–60
- rise 690, 693
- rotation 738, 751–2, 754, 787
- rotational symmetry 752–3
- rounding 5, 171–2, 174, 192, 236, 307
- rule(s) 44, 94, 103, 151, 262, 376, 511, 517, 528, 646–8, 651–4, 672, 683, 698–700, 714
- run 690, 693
- sale 193
- sample space 593–4, 599
- samples/sampling 583–6
- SAS 765–6, 797
- scale 566
- scale drawings 431–5, 456
- scale factors 432, 434–5, 788, 790, 792, 799
- scale ratio 432
- scalene triangles 77
- second 292
- sectors 255, 263–4
- segments 64, 523
- semicircles 256, 258
- semi-regular tessellations 775, 777
- shapes 77, 85, 227, 241, 243, 758, 760, 792
- sign 32–3, 39, 148, 151, 154, 159, 179, 307, 347, 478, 511, 528–9, 739, 776
- similar figures 789, 792
- similar triangles 796–9
- simple random samples 584
- simplifying (simplest form) 20, 137, 139, 144, 147, 160, 180, 188–9, 194–5, 348, 351–2, 356, 385, 389, 418–22, 439–40, 485, 501
- simulation 621, 623
- simultaneous equations 663
- sketching 673, 686
- skewed data 584
- slope 690–1, 705
- solids 102–4, 269, 283
- solving/solutions 479–80, 484, 507–8, 516–17, 528–30, 659, 663, 669–70, 672–4
- space 108–11, 240, 269, 277, 563, 593
- special quadrilaterals 249–51, 784
- speed 449–52
- spheres 103
- spread 577–9
- square 86, 103, 241, 337, 782–3
- square (of numbers) 15, 17
- square pyramids 103
- square roots 15, 17, 309, 314
- square units 240–1
- SSS 765–6, 797
- statistics 605–7
- straight lines 64–5, 646, 660, 707, 713
- stratified samples 584
- subject 313, 450, 452, 511
- substitution 44–6, 314, 342–3, 355, 376, 484–7, 511–12, 648, 652, 660, 683, 685–6, 709–10
- subtraction 4, 6, 27–8, 32–4, 44, 142, 144–6, 151–3, 164, 166, 241, 244, 263, 313–14, 347, 356
- sum 4–6, 337
- sum of squares 301
- summary statistics 572
- supplementary angles 65, 71–2
- surds 307–8
- surface area 269–71
- surveys 583–6
- symbols 15, 669–70, 759
- symmetric data 584
- tables 548, 556–8, 601, 646–8, 651–4
- tally 556–8, 613
- terminating decimals 171–3
- terminology 136
- terms 336, 347, 351–2, 428, 491, 497
- tessellation naming 775
- tessellations 774–7, 788
- tests 20, 766
- thirds 355
- three-dimensional (3D) coordinate systems 108–9, 111–12
- three-dimensional (3D) objects 102, 277
- time 292–4, 444, 449, 452, 706–7, 710
- time zones 292–3, 295–7
- total change 439
- translation 746–8
- transversal lines 70–1
- trapezium 86, 249–50, 782
- tree diagrams 608–10
- trial 592, 621–2
- triangles 77–80, 241, 301–4, 764–5, 784, 796, 798–9
- true equations 478–9, 659–60
- 24-hour time 293–4
- two-dimensional (2D) space 240, 269
- two-step experiments 599–601, 609
- two-way tables 613–17
- unique triangles 765, 767
- unitary method 206–8, 426, 458–61
- units 188, 206, 240, 243, 277–8, 292–4, 419, 421, 427, 432, 438–9, 444, 449–50, 460–1, 518, 520
- unknown values/quantity 88, 229, 313–14, 336, 427, 450, 479, 511, 520, 525
- unlike terms 348
- upper quartile 577–9
- values 136–7, 186, 192, 201, 206, 342–3, 458, 484, 511, 518, 523, 572, 651–4, 683
- variables 336, 376, 479, 511, 647, 707
- vectors 746–8
- Venn diagrams 607, 613–17
- vertical lines 669–70, 672
- vertically opposite angles 65
- vertices 77, 86, 95, 101–2, 740–1, 754, 759, 777, 783
- volume 277–9, 283–5
- week 292
- whole numbers 136–7, 143, 206, 301, 307, 418–19, 523, 606
- width 511
- working left to right 41
- x-axis 642
- x-coordinates 644, 647–8, 659–60, 663, 739
- x-intercepts 683–6
- y-axis 563, 642, 683
- y-coordinates 644, 647, 659, 662, 698, 739
- year 292
- y-intercepts 683–6, 698–700
- zero 27, 100, 158, 167, 171, 173
- zero index 388–9
- zero powers 389

## Working with unfamiliar problems: Part 1

- 1 5050  
 2 Almost 20  
 3 1111111101  
 4 12144  
 5  $245 \times 13 = 3185$   
 6

16	3	2	13
5	10	11	8
9	6	7	12
4	15	14	1

- $10 + 11 + 6 + 7 = 34$   
 7 10 cm,  $6.25 \text{ cm}^2$   
 8 5070  
 9 Answers may vary.  
 10  $1058 \text{ cm}^2$   
 11  $70^\circ$   
 12 16896  
 13 A square of side 24 cm  
 14 66  
 15 1 h

## Working with unfamiliar problems: Part 2

- 1 5242880  
 2  $F = 2, O = 9, U = 7, R = 0, I = 1, V = 8, N = 5, E = 4, \text{ i.e.}$   
 $2970 + 2184 = 5154$   
 3  $\frac{5}{16}$   
 4 a 1868  
 b 1565  
 c 2454, 3666  
 d 2151, 3969  
 5 34%  
 6 Side 16 cm, 8 blocks left over  
 7  $10a - 15, 5(2a - 3)$   
 8 22.5 cm  
 9 a  $(1) + (3 + 5) + (7 + 9 + 11) + (13 + 15 + 17 + 19)$   
 $= 1^3 + 2^3 + 3^3 + 4^3$   
 b  $1 = 1^2$   
 $1 + 3 = 2^2$   
 $1 + 3 + 5 = 3^2$   
 $1 + 3 + 5 + 7 = 4^2$   
 $1 + 3 + 5 + 7 + 9 = 5^2$   
 c 28  
 d i 28                      ii 1275  
 10 a 15, 17, 21, 23, 27, 29  
 b 19, 25, 31, 37, 43, 49  
 c Dominic  
 d Beau  
 e 205 numbers

## Chapter 1

## 1A

## Building understanding

- 1 a 43                      b 34                      c 111                      d 501  
          e 347                      f 16                      g 44                      h 131  
 2 a 7                      b 6                      c 9                      d 6

## Now you try

- Example 1  
 a 214                      b 473  
 Example 2  
 a 913                      b 176

## Exercise 1A

- 1 a i 125                      ii 733  
          b i 239                      ii 653  
 2 a 32                      b 387                      c 1143                      d 55  
          e 163                      f 216                      g 79                      h 391  
          i 701                      j 229                      k 39                      l 161  
 3 a 174                      b 431                      c 10362                      d 2579  
          e 58                      f 217                      g 27                      h 13744  
          i 888                      j 23021                      k 75                      l 9088  
 4 a \$5                      b \$8                      c \$11  
          d \$6                      e \$19                      f \$3  
 5 a 110                      b 20                      c 2300  
          d 1800                      e 2                      f 43000  
 6 678 km  
 7 22  
 8 Answers given from top row down and from left to right.  
 a 7, 3, 3                      b 1, 7, 8                      c 2, 5, 3  
 d 5, 4                      e 4, 2, 8                      f 0, 0, 7, 1  
 9 43 marbles  
 10 a 100                      b 50  
 11 a The sum of two 3-digit numbers cannot be bigger than 1998.  
 b Subtracting  $32\_$  from  $3\_6$  will give a maximum of  $76(396 - 320)$ .  
 12 a  $x + y + z = z + x + y$   
 b  $x - y + z = z - y + x = x + z - y$   
 13 a The third number is always 3 and others are (9, 3), (8, 4), (7, 5), (6, 6), (5, 7), (4, 8), (3, 9), giving 7 combinations. A1 has to be carried from the middle column.  
 b The second number is always 7 and others are (0, 6), (1, 7), (2, 8), (3, 9), giving 4 combinations. A1 has to be used from the left column.

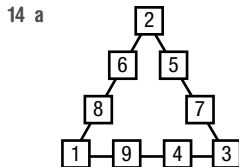

- b 5 totals, 17, 19, 20, 21 and 23
- c 17 in 2 ways, 19 in 4 ways, 20 in 6 ways, 21 in 4 ways and 23 in 2 ways

**1B**

**Building understanding**

- 1 a 56 b 1 c 3
- 2 a 99 b 42 c 72 d 132  
e 32 f 63 g 11 h 11  
i 12 j 8 k 11 l 13
- 3 a True b True c False d True  
e False f True g True h True  
i True j False

**Now you try**

- Example 3  
a 1200 b 728 c 208
- Example 4  
a 13280 b 118 rem.7

**Exercise 1B**

- 1 a 600 b 180 c 400 d 700
- 2 a 153 b 147 c 114 d 116
- 3 a 35 b 20 c 243 d 213
- 4 a 603 b 516 c 3822 d 90360  
e 9660 f 413 090 g 34 194 h 344 223
- 5 a 28 rem. 1 b 30 rem. 4 c 416 rem. 7  
d 13 rem. 0 e 13 rem. 12 f 166 rem. 8  
g 7 rem. 0 h 1054 rem. 16
- 6 a 130 b 260 c 140 d 68  
e 17 000 f 13 600 g 413 h 714  
i 459 j 366 k 1008 l 5988  
m 16 n 63 o 41 p 127  
q 16 r 127 s 420 t 38
- 7 a \$15 b \$70 c \$400  
d \$5 e \$24 f \$50
- 8 \$25
- 9 2358 packets
- 10 Option B by \$88
- 11 58 loads
- 12 Numbers are given from top down and left to right.  
a 3, 6, 3 b 3, 4, 5, 7, 3, 2  
c 6 d 3, 2
- 13 a 1 b  $a$  c 0 d 25
- 14 a 34 b 18 c 29 d 17
- 15 a 1700 b 560 c 12 000 d 300
- 16 a 10 (8 child and 2 adult)  
b 15 (14 child and 1 adult)  
c Take the maximum number of child tickets that leaves a multiple of the adult price remaining.

**1C**

**Building understanding**

- 1 a 14 b 45 c 43 d 40
- 2 a 6 b 3
- 3 a Prime b Composite c Prime  
d Composite e Composite f Composite  
g Composite h Composite
- 4 a True b False c False d True  
e True f False g True h False

**Now you try**

- Example 5  
a 40 b 14
- Example 6  
a 49 b 8 c 27 d 10

**Exercise 1C**

- 1 a 6 b 45 c 24  
d 8 e 50 f 36
- 2 a 2 b 9 c 8  
d 6 e 1 f 1
- 3 a 16 b 100 c 169  
d 225 e 10 000 f 400
- 4 a 5 b 7 c 2  
d 11 e 6 f 10
- 5 a 8 b 64 c 343  
d 125 e 216 f 1000
- 6 a 2 b 5 c 3  
d 6 e 1 f 8
- 7 a 24 b 105 c 5 d 4
- 8 4 ways
- 9 15 minutes
- 10 30 minutes
- 11 25
- 12 a 55  
b They are square numbers.
- 13 The number one (1) does not have two or more factors, it just has one factor, being itself, so it is not composite. Further, it is not considered a prime, by definition.
- 14 All pairs of factors form groups of 2 except for the repeated factor with a square number, e.g. 9 has 1, 3 and 9 where 3 is the repeated factor.
- 15 a False, LCM of 4 and 8 is 8 not 32.  
b True  
c True
- 16 a i  $28 = 23 + 5$  ii  $62 = 43 + 19$   
iii  $116 = 97 + 19$   
b 11 and 17
- 17 (3, 5), (5, 7), (11, 13), (17, 19), (29, 31), (41, 43), (59, 61), (71, 73)

1D

Building understanding

- 1 a 1, 3, 5, 15  
 b 1, 2, 3, 4, 6, 8, 12, 24  
 c 1, 2, 4, 5, 8, 10, 20, 40  
 d 1, 2, 3, 4, 6, 7, 12, 14, 21, 28, 42, 84
- 2 2, 3, 5, 7, 11, 13, 17, 19, 23, 29
- 3 a True                      b False                      c True  
 d False                      e True                      f True

Now you try

Example 7

$$140 = 2^2 \times 5 \times 7$$

Example 8

Divisible by 2, 3, 6 and 9; not divisible by 4, 5 or 8.

Example 9

- a LCM = 189                      b HCF = 9

Exercise 1D

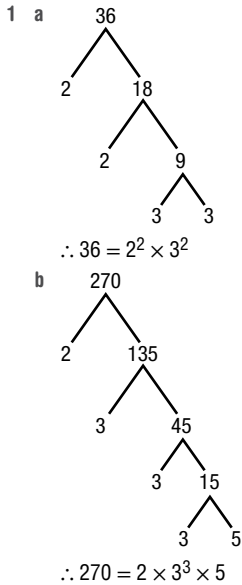

- 2 a  $2^2 \times 5$                       b  $2^2 \times 7$   
 c  $2^3 \times 5$                       d  $2 \times 3^2 \times 5$   
 e  $2^3 \times 5 \times 7$                       f  $2^2 \times 7^2$   
 g  $2^3 \times 3^2 \times 5$                       h  $2^2 \times 3 \times 5 \times 11$
- 3 a 3:2, 3, 5                      b 2:3, 7  
 c 3:2, 3, 5                      d 3:5, 7, 11
- 4 a Divisible by 3                      b Divisible by 2, 3, 6, 9  
 c Divisible by 2, 4, 8                      d Divisible by 3, 9  
 e Divide by 3, 5, 9                      f None  
 g 2, 3, 6                      h None
- 5 a 5                      b 3                      c 2                      d 7
- 6 a 60, 2                      b 28, 14                      c 120, 3                      d 60, 3  
 e 140, 4                      f 390, 1                      g 126, 3                      h 630, 21
- 7 210 days

- 8 61 soldiers
- 9 a True                      b False, 12  
 c True                      d False, 12
- 10 a 2 and 7                      b 2 and 11  
 c 3 and 5                      d 7 and 11
- 11 a  $2 \times 3^4$                       b  $2^5 \times 3$   
 c  $3^2 \times 5^4$                       d  $2^8 \times 7$
- 12 a i 2                      ii 8                      iii 11                      iv 15  
 v 28                      vi 39                      vii 94                      viii 820  
 b i 5                      ii 5                      iii Result is 0  
 c Result is 11  
 d i 11                      ii 11                      iii 0                      iv 0  
 e The difference between the sum of the alternating digits is 0 or a multiple of 11.

1E

Building understanding

- 1 a >                      b <                      c <                      d >  
 e >                      f <                      g >                      h <
- 2 a -1, 2                      b -1, -4                      c -4, -2                      d 0, -10
- 3 a  $-2^\circ\text{C}$                       b  $-1^\circ\text{C}$                       c  $-9^\circ\text{C}$                       d  $3^\circ\text{C}$

Now you try

Example 10

- a -5                      b 7                      c -6                      d -8

Exercise 1E

- 1 a -4                      b -6                      c 3                      d 4
- 2 a 1                      b 4                      c 1                      d 8  
 e 15                      f 102                      g -5                      h -7  
 i -7                      j -14                      k -94                      l -12
- 3 a -1                      b -5                      c -26                      d -17  
 e -91                      f -74                      g -11                      h -31  
 i -29                      j -110                      k -437                      l -564
- 4 a  $1 - 4 = -3$                       b  $-9 + 3 = -6$   
 c  $-1 + 5 = 4$                       d  $-15 - 5 = -20$
- 5 a 6                      b -4                      c -14                      d 11  
 e 15                      f 5                      g -3                      h 12
- 6 a -1                      b 8                      c -7                      d -1
- 7 Ground floor
- 8 a -                      b -, +                      c -, -
- 9 \$7
- 10  $-23^\circ\text{C}$
- 11 Many examples are possible; for example,  $-3 + 5$  is positive,  $-3 + 1$  is negative and  $-3 + 3$  is zero.
- 12 a Always true                      b Not always true  
 c Not always true                      d Always true  
 e Not always true                      f Not always true
- 13 0. If  $a = -a$ , then  $2a = 0$  (by adding  $a$  to both sides), which only has the solution  $a = 0$ .
- 14 500, pair to give 500 pairs each with a total of 1.
- 15 a  $a = 1, b = 4$                       b  $a = -7, b = 3$   
 c  $a = -5, b = 2$                       d  $a = -10, b = 2$



Progress quiz

- 1 a 33      b 42      c 358      d 392  
 2 a 323      b 37      c 543      d 2067  
 3 a 700      b 294      c 16      d 423  
 4 a 222      b 67233      c 61      d 23 rem. 2  
 5 a 24      b 6  
 6 a 36      b 900      c 8      d 50  
 7 a 8      b 1 000 000  
 c 3      d 5  
 8  $2^3 \times 3^2 \times 5$   
 9 Divisible by: 2 (last digit 6 is even); 3 ( $1 + 2 + 6 = 9$ , which is divisible by 3); 6 (divisible by both 2 and 3); 9 ( $1 + 2 + 6 = 9$  which is divisible by 9)  
 Not divisible by: 4 (26 not divisible by 4); 5 (last digit not 0 or 5); 8 (last 3 digits not divisible by 8)  
 10 a HCF = 6; LCM = 126  
 b HCF = 15; LCM = 630  
 11 a 14      b -17      c -74  
 d -452      e -13      f -70  
 12 a Each team has 18 students  
 b 9 teams with green uniform; 6 teams with red uniform;  
 8 teams with blue uniform

1F

Building understanding

- 1 a 6      b -38      c -88      d 349  
 2 a Subtract      b Add  
 3 a False      b True      c True  
 d False      e True      f False  
 g False      h True      i False

Now you try

- Example 11  
 a 2      b -6      c 8      d -3

Exercise 1F

- 1 a 3      b 4      c 1      d 8  
 2 a 4      b 3      c -5      d 15  
 e -2      f -14      g -9      h -21  
 i -38      j -86      k -105      l -259  
 3 a 8      b 23      c 9      d 11  
 4 a 5      b 8      c 21      d 38  
 e 72      f 467      g -2      h 2  
 i 3      j 32      k -57      l 76  
 5 a -3      b -6      c 1      d 10  
 e 2      f -14      g -2      h -4  
 i -30      j -5      k -6      l 65

6 a

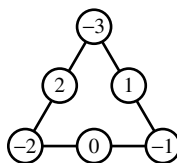

b

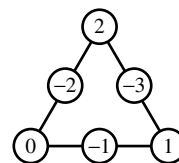

7 a

-1	-6	1
0	-2	-4
-5	2	-3

b

-12	-19	-14
-17	-15	-13
-16	-11	-18

8 -\$40

- 9 a  $a = -3, b = -5$       b  $a = -15, b = -9$   
 10 a 3 and -8      b 15 and -4  
 11 a Should be 5 + 2.      b Left off negative on the 2.  
 12 a  $10 - 4 = 6$  and  $10 - 6 = 4$   
 b  $5 - 7 = -2$  and  $5 - (-2) = 7$   
 c  $1 + (-5) = -4$ , so this can be arranged to get  
 $1 = -4 - (-5)$ . Alternatively, start with  $-5 + 1 = -4$ .  
 13 a Always  $< 0$       b Always  $< 0$   
 c Not always  $< 0$       d Always  $< 0$   
 14 a No      b Yes      c Yes      d No

15 a

x	-2	-1	0	1	2	3
y	7	6	5	4	3	2

- b 18  
 c -45

16 a

x	-3	-2	-1	0	1	2	3
y	0	1	2	3	4	5	6

- b 15  
 c -9

1G

Building understanding

1 a

$\square$	$\triangle$	$\square \times \triangle$
3	5	15
2	5	10
1	5	5
0	5	0
-1	5	-5
-2	5	-10
-3	5	-15

b	$\square$	$\triangle$	$\square \times \triangle$
	3	-5	-15
	2	-5	-10
	1	-5	-5
	0	-5	0
	-1	-5	5
	-2	-5	10
	-3	-5	15

- 2 a 15, 3                                      b -15, -3  
 c -15, -3                                    d 15, -3  
 3 a True                                      b False                                      c True  
 d True                                        e False

**Now you try**

Example 12

- a -24                    b 10                    c -3                    d 4

Example 13

100

**Exercise 1G**

- 1 a -20                                      b -30  
 c 21                                        d 77  
 2 a -20                                      b -54                                      c -40                                      d -99  
 e 6                                         f 15                                        g 40                                        h 300  
 i -28                                        j -120                                      k 60                                        l 400  
 3 a -5                                        b -4                                        c -2                                        d -3  
 e -2                                        f -26                                        g -45                                        h -4  
 i 3    j 3    k 9    l 6  
 4 a -3                                        b -5                                        c 7  
 d 6                                         e -3                                         f -72  
 g -252                                      h -5                                         i -30  
 5 a 1                                         b 14                                        c 160  
 d -29                                        e -120                                      f 20  
 6 a  $\times, \div$                                       b  $\times, \div$                                       c  $\div, \times$   
 d  $\div, \div$                                         e  $\times, \div$                                       f  $\times, \div$   
 7 -6  
 8 -1  
 9 -8 and 3  
 10 8 and -2 or -8 and 2  
 11 a No, e.g. -3 and 5 have a negative product (-15) but a positive sum (2).  
 b No, e.g. -3 and -5 have a negative sum (-8) but a positive product of (15)  
 c Yes, one of the numbers must be positive and the other must be negative, so the quotient is negative.  
 12 a i 4                                        ii -27                                      iii -64                                      iv 25  
 b Yes, it will be a product of 2 numbers of the same sign.  
 c Yes, the product of 3 negative numbers will be negative.  
 13 a  $(-1)^2 = 1, (-1)^3 = -1,$   
 $(-1)^4 = 1, (-1)^5 = -1,$   
 $(-1)^6 = 1$

b Even, odd

c -1

14 If  $\sqrt{-9}$  were to exist, then you could find a value of  $a$  for which  $a^2 = -9$ . But if  $a$  is positive, so  $13a^2$ ; if  $a$  is negative then  $a \times a$  is positive; if  $a = 0$ , then  $a^2 = 0$ , not 9. So no value of  $a$  on a number line could solve  $a^2 = -9$ . (All real numbers are positive, negative or zero.)

15 Yes, a cube of a negative number gives a negative number.

$$(-3)^3 = -27 \text{ so } \sqrt[3]{-27} = -3$$

16 a  $y = -3x - 1$                     b  $y = -7x - 3$                     c  $y = x^2 + 1$ **1H****Building understanding**

- 1 a Equal                                      b Equal  
 c Not equal                                d Not equal  
 e Not equal                                f Equal  
 2 Missing numbers are:  
 a 4, -3                                      b -6, 18  
 c -3, -3, 1                                d -6, -36, -4  
 3 Missing numbers are:  
 a -3, 8, 5                                    b 6, 18

**Now you try**

Example 14

- a 17                    b -24                    c 18

Example 15

- a -16                    b -7                    c -17

**Exercise 1H**

- 1 a 2    b 1    c 14    d 15  
 2 a -30                                        b -12                                        c 12  
 d -11                                        e -10                                        f 5  
 g 24                                         h -60                                        i 40  
 3 a -6                                        b 24                                        c 2    d 7  
 e 0    f 3    g -11                                        h 2  
 i -44                                        j 1    k -12                                        l 1  
 4 a 2    b 25    c 20    d -3  
 e -5                                         f 4    g -30                                        h -7  
 5 a -1    b -3    c -5  
 d 3    e -6    f 7  
 g 0    h -2    i -5  
 6 a -15                                        b -15                                        c 2    d -8  
 e 8    f 1    g -4    h 10  
 7 a 22                                        b 4    c 28                                        d 122  
 e -32                                        f -16                                        g 152                                        h 16  
 8 a -15                                        b 5    c 16                                        d 14  
 e 9    f 28                                        g -1                                        h 0  
 i -12                                        j 19                                        k 7    l 37  
 9 a 12                                        b 16                                        c 2    d 1  
 e 3    f -23                                        g 0    h 3  
 i 28                                         j 26                                        k 0    l -22  
 10  $-3^\circ\text{C}$

- 11 a  $(-2 + 1) \times 3 = -3$   
 b  $-10 \div (3 - (-2)) = -2$   
 c  $-8 \div (-1 + 5) = -2$   
 d  $(-1 - 4) \times (2 + (-3)) = 5$   
 e  $(-4 + -2) \div (10 + (-7)) = -2$   
 f  $20 + ((2 - 8) \times (-3)) = 38$   
 g  $(1 - (-7) \times 3) \times 2 = 44$   
 h  $(4 + -5 \div 5) \times (-2) = -6$
- 12 a Always true                                b Not always true  
 c Always true                                 d Not always true  
 e Not always true                            f Always true
- 13 a 4    b 1    c -7    d -4
- 14 a -18    b 4    c -1
- 15 a  $(1 - 3 \times (-4)) \div (-13) = -1$   
 b  $4 \div (3 + (-7)) \times (-5) = 5$   
 c  $6 - (7 \div (-7) + 6) = 1$  or  $(6 - 7) \div ((-7) + 6) = 1$   
 d  $-1 - (5 + (-2)) \times (1 - 4) = 8$
- 16 There are 5 answers.  
 17 Answers may vary.

**Problems and challenges**

- 1 4, 6, 9, 10, 14, 15, 21, 22, 25, 26, 33, 34, 35, 38, 39, 46, 49
- 2 a 13 cm    b 9 cm
- 3 2520
- 4 a -105    b 16    c -39
- 5 a  $-5 \times (3 \div (-3) + 2) - (4 + (-3)) = -6$   
 b  $-100 \div (4 \times (-2) - 2) \times 3 - (-2) = 32$
- 6 a 6    b 1000    c 210    d 96
- 7 a  $y = 3 - x$     b  $y = x^2 - 3$   
 c  $y = x^3 + 4$     d  $y = y = 2^{\sqrt{x}} - 1$
- 8 a 0    b 2
- 9  $a = 7, b = 3$ ; HCF = 63

**Chapter checklist with success criteria**

- 1 308; 252  
 2 1155; 55  
 3 800; 58  
 4 10 300; 72 remainder 2  
 5 24; 12  
 6 36; 8  
 7 9; 4  
 8  $540 = 2^2 \times 3^3 \times 5$   
 9 Only divisible by 3 (not 2, 4, 5, 6, 8 or 9)  
 10 LCM = 630; HCF = 15  
 11 -3; -5  
 12 -8; -5  
 13 -21; 11  
 14 -30  
 15 -3  
 16 31

**Chapter review**

**Short-answer questions**

- 1 a 497    b 412    c 129    d 67  
 e 112    f 139    g 1999    h 5675
- 2 a 539    b 2030    c 61    d 3074
- 3 a 170    b 297    c 336    d 423  
 e 41    f 119    g 103    h 201
- 4 a 1668    b 21294    c 281    d 122
- 5 a 3    b 1    c 1    d 7
- 6 a 9    b 11    c 49    d 400  
 e 3    f 4    g 125    h 1000
- 7 a 1, 2, 3, 4, 5, 6, 10, 12, 15, 20, 30, 60  
 b 112, 119, 126, 133, 140, 147  
 c 31, 37, 41, 43, 47, 53, 59  
 d 24  
 e 6
- 8 a  $2^2 \times 3^2$     b  $2^2 \times 3 \times 7$     c  $2 \times 3^2 \times 11$
- 9 a Divisible by 2, 3, 4, 6    b Divisible by 5  
 c Divisible by 2, 4    d Divisible by 3, 9
- 10 a 380  
 b 2
- 11 a 3    b -5    c -8    d -31  
 e -76    f -330    g -1    h 98
- 12 a 2    b -8    c -64    d -39  
 e 16    f 12    g -20    h 92
- 13 a True    b False    c False    d True
- 14 a -10    b 88    c -63    d 200  
 e 2    f -3    g -4    h 3
- 15 a -4    b -1    c -8    d 26  
 e -10    f -1    g -1    h -20
- 16 a -11    b 1    c 7    d 30  
 e 7    f -128    g -5    h 145

**Multiple-choice questions**

- 1 B    2 C    3 E    4 E    5 E  
 6 C    7 A    8 E    9 B    10 D

**Extended-response questions**

- 1 a  $a = \$112, b = -\$208, c = \$323, d = -\$275, e = \$240$   
 b \$228  
 c \$160
- 2 a 72  
 b  $30 = 2 \times 3 \times 5, 42 = 2 \times 3 \times 7$   
 c LCM = 210, HCF = 6  
 d 6  
 e 210

## Chapter 2

## 2A

## Building understanding

- 1 a Complementary  
c Revolution
- 2 a 45  
d 240
- 3 a  $40^\circ$
- b Supplementary
- b 130  
e 90  
b  $110^\circ$
- c 120  
f 100  
c  $220^\circ$

## Now you try

## Example 1

- a  $a = 50, b = 180$
- b  $a = 125, b = 55$

## Exercise 2A

- 1 a  $a = 63$   
c  $a = 25$   
g  $a = 120$   
i  $a = 140$   
k  $a = 148$
- 2 a  $a = 70, b = 270$   
c  $a = 128, b = 52$   
e  $a = 25$   
g  $a = 120$   
i  $a = 140$   
k  $a = 148$
- 3 a  $\angle DOE$   
c  $\angle DOE$  or  $\angle AOB$
- 4 a  $270^\circ$   
d  $180^\circ$   
g  $225^\circ$
- 5 a S  
d E  
g SW
- 6 a  $40^\circ$   
c  $120^\circ$
- 7 a 60  
d 15
- 8 a  $105^\circ$   
d  $170^\circ$   
g  $144^\circ$
- 9 a Supplementary angles should add to  $180^\circ$ .  
b Angles in a revolution should add to  $360^\circ$ .  
c Angles on straight line should add to  $180^\circ$ .
- 10 a  $a + 3b = 360$   
c  $a + b = 90$
- 11 a  $a = 110$   
b  $(a + 50)^\circ$  should be the larger looking angle.
- 12 a 30  
d 34
- b  $a = 58$   
e 315  
h  $45^\circ$   
b N  
e NE  
h SE
- c  $a = 39$   
f  $a = 40$   
h  $a = 50, b = 90$   
j  $a = 110, b = 70$   
l  $a = 90, b = 41, c = 139$   
b  $\angle AOB$   
d  $\angle COD$
- c  $0^\circ$  (or  $360^\circ$ )  
f  $135^\circ$
- b 135  
e 36  
b 97.5  
e 132.5  
h 151.5
- c 35  
f 45  
c 170  
f 27.5
- b  $72^\circ$   
d  $200^\circ$
- b 135  
e 36  
b 97.5  
e 132.5  
h 151.5
- c 35  
f 45  
c 170  
f 27.5
- b  $a + 2b = 180$
- b 54  
e 30

## 2B

## Building understanding

- 1 a equal  
c equal
- 2 a  $\angle BCH$   
d  $\angle BCH$   
g  $\angle FBC$
- b supplementary
- b  $\angle ABE$   
e  $\angle FBC$   
h  $\angle DCG$
- c  $\angle GCB$   
f  $\angle GCB$

## Now you try

## Example 2

- a Corresponding, equal ( $a = b$ )  
b Alternate, equal ( $a = b$ )  
c Co-interior, supplementary ( $a + b = 180$ )

## Example 3

- a  $a = 70$  (corresponding to  $70^\circ$  angle),  $b = 70$  (vertically opposite to  $70^\circ$ ) and  $c = 110$  (co-interior to  $\angle b^\circ$ ) (other combinations of reasons are possible)  
b  $a = 65$  (co-interior to  $115^\circ$  angle),  $b = 115$  (co-interior to  $\angle a^\circ$ )

## Exercise 2B

- 1 a Alternate, equal  
b Corresponding, equal  
c Co-interior, supplementary  
d Corresponding, equal  
e Co-interior, supplementary  
f Alternate, equal
- 2 All reasons assume that lines are parallel.  
a  $a = 110$  (corresponding to  $110^\circ$ ),  $b = 70$  (supplementary to  $a^\circ$ )  
b  $a = 120$  (alternate to  $120^\circ$ ),  $b = 60$  (co-interior to  $a^\circ$ ),  $c = 120$  (corresponding to  $120^\circ$ )  
c  $a = 74$  (alternate to  $74^\circ$ ),  $b = 106$  (co-interior to  $74^\circ$ ),  $c = 106$  (supplementary to  $a^\circ$ )  
d  $a = 100$  (supplementary to  $80^\circ$ ),  $b = 100$  (co-interior to  $80^\circ$ )  
e  $a = 95$  (corresponding to  $95^\circ$ ),  $b = 85$  (supplementary to  $a^\circ$ )  
f  $a = 40$  (alternate to  $40^\circ$ ),  $b = 140$  (co-interior to  $40^\circ$ )
- 3 a  $a = 58, b = 58$  (both co-interior to  $122^\circ$ )  
b  $a = 141, b = 141$  (both co-interior to  $39^\circ$ )  
c  $a = 100$  (co-interior to  $80^\circ$ ),  $b = 80$  (co-interior to  $a^\circ$ )  
d  $a = 62$  (co-interior to  $118^\circ$ ),  $b = 119$  (co-interior to  $61^\circ$ )  
e  $a = 105$  (co-interior to  $75^\circ$ ),  $b = 64$  (corresponding to  $64^\circ$ )  
f  $a = 25$  (alternate to  $25^\circ$ ),  $b = 30$  (alternate to  $30^\circ$ )
- 4 a Alternate  
c Co-interior  
e Corresponding
- b Alternate  
d Corresponding  
f Co-interior

- 5 a No, the alternate angles are not equal.  
 b Yes, the co-interior angles are supplementary.  
 c No, the corresponding angles are not equal.
- 6 a 250                      b 320                      c 52  
 d 40                        e 31                        f 63  
 g 110                       h 145                      i 33
- 7 a  $130^\circ$                   b  $95^\circ$                       c  $90^\circ$   
 d  $97^\circ$                     e  $65^\circ$                       f  $86^\circ$
- 8 a  $\angle AOB = (180 - a)^\circ$                   b  $\angle AOB = (360 - a)^\circ$   
 c  $\angle AOB = (180 - a - b)^\circ$
- 9  $a = 36, b = 276, c = 155, d = 85, e = 130, f = 155, g = 15$

2C

Building understanding

- 1 a Right-angled triangle                  b Isosceles triangle  
 c Acute-angled triangle                  d Equilateral triangle  
 e Obtuse-angled triangle                  f Equilateral triangle  
 g Isosceles triangle                      h Scalene triangle
- 2 a Scalene                      b Isosceles                      c Isosceles  
 d Equilateral                  e Scalene                      f Isosceles
- 3 a Right                        b Obtuse                        c Acute

Now you try

- Example 4  
 a  $a = 47$                       b  $a = 136$                       c  $a = 66$

- Example 5  
 $a = 55$

Exercise 2C

- 1 a 35                              b 60  
 2 a 80                              b 40                              c 58  
 d 19                              e 34                              f 36  
 3 a 44                              b 106                              c 20  
 4 a 65                              b 40                              c 76  
 5 a 160                              b 150                              c 80  
 d 50                              e 140                              f 55  
 6 a Yes                              b No                              c Yes  
 d Yes                              e Yes                              f Yes  
 7 a 55                              b 60                              c 25  
 8 a 60                              b 231                              c 18  
 d 91                              e 65.5                              f 60
- 9 a Isosceles, the two radii are of equal length.  
 b  $\angle OAB, \angle OBA$   
 c  $30^\circ$   
 d  $108^\circ$   
 e  $40^\circ$
- 10 a i  $a$ , alternate angles in parallel lines  
 ii  $c$ , alternate angles in parallel lines  
 b They add to  $180^\circ$ , they are on a straight line.  
 c  $a + b + c = 180$ , angles in a triangle add to  $180^\circ$ .
- 11 Hint: Let  $a^\circ$  be the third angle.
- 12 Hint: Let  $a^\circ$  be the size of each angle.
- 13 a Alternate to  $\angle ABC$  in parallel lines  
 b Supplementary, co-interior angles in parallel lines  
 c  $a + b + c = 180$ , angles in a triangle add to  $180^\circ$

- 14 a  $a = 30, b = 60, c = 60$   
 b  $a + c = 90$   
 c  $a = 60, b = 120, c = 30, a + c = 90$   
 d  $a = 16, b = 32, c = 74, a + c = 90$   
 e  $a + c = 90$   
 f i  $a = x, b = 2x, c = 90 - x$                   ii 90  
 g  $a + a + c + c = 180$   
 $\therefore 2a + 2c = 180$   
 $\therefore a + c = 90$

2D

Building understanding

- 1 a Non-convex                  b Non-convex                  c Convex
- 2 a i True                      ii False                      iii False                      iv True  
 b i False                      ii True                      iii False                      iv True  
 c i False                      ii True                      iii True  
 d i True                      ii False                      iii False  
 e i True                      ii False                      iii True  
 f i False                      ii False

Now you try

- Example 6  
 a  $a = 70$                       b  $a = 110, b = 55$

Exercise 2D

- 1 a  $a = 120$     b  $a = 95$   
 2 a 90    b 61    c 105  
 d 170    e 70    f 70  
 3 a  $a = 104, b = 76$   
 b  $a = 72, b = 72$   
 c  $a = 128$   
 4 a  $a = 100, b = 3, c = 110$   
 b  $a = 2, b = 90$   
 c  $a = 5, b = 70$   
 5 a 152    b 69    c 145  
 d 74    e 59    f 30  
 6 a 19    b 60    c 36  
 7 a Square, rectangle, rhombus and parallelogram  
 b Square, rhombus  
 8 a True    b False    c True  
 d True    e False    f True  
 9 No, the two reflex angles would sum to more than  $360^\circ$  on their own.  
 10 a Angle sum  $= a^\circ + b^\circ + c^\circ + d^\circ + e^\circ + f^\circ = 180^\circ + 180^\circ$  (angle sum of a triangle)  $= 360^\circ$   
 b  $\angle ADC = 360^\circ - (a + b + c)^\circ$  (angle sum of a quadrilateral) reflex  
 $\angle ADC = 360^\circ - \angle ADC$   
 $= 360^\circ - (360^\circ - (a + b + c)^\circ)$   
 $= (a + b + c)^\circ$

Progress quiz

- 1 a  $a = 25, b = 232$   
 b  $x = 72, y = 108$   
 c  $a = 65, b = 115$   
 d  $a = 92, b = 88, c = 272$

- 2 a  $\angle POT$                                 b  $\angle ROS$   
 c  $\angle TOS$  or  $\angle POR$
- 3 a 260                                        b 105                                        c 44
- 4 Isosceles, acute
- 5 a 60                                        b 30                                        c 46  
 d 62                                        e 60                                        f 84
- 6 a 60                                        b 71                                        c 137  
 d 72                                        e 90

**2E**

**Building understanding**

- 1 a 6                                        b 4                                        c 10  
 d 7                                        e 5                                        f 12
- 2 a  $720^\circ$                                         b  $1440^\circ$                                         c  $3600^\circ$
- 3 a Square                                        b Equilateral triangle
- 4 a  $108^\circ$                                         b  $144^\circ$                                         c  $135^\circ$

**Now you try**

Example 7  
 $1080^\circ$

Example 8  
 $a = 140$

Example 9  
 $120^\circ$

**Exercise 2E**

- 1  $540^\circ$
- 2 a  $720^\circ$                                         b  $1260^\circ$                                         c  $2340^\circ$
- 3 a 130                                        b 155                                        c 105  
 d 250                                        e 40                                        f 265
- 4 a  $108^\circ$                                         b  $128.6^\circ$                                         c  $147.3^\circ$                                         d  $168.75^\circ$
- 5 a 9                                        b 15                                        c 21                                        d 167
- 6 a 127.5                                        b 240                                        c 60  
 d 60                                        e 79                                        f 72
- 7 a Circle                                        b Increases to infinity  
 c  $180^\circ$
- 8 a  $3 \times 180^\circ = 540^\circ$

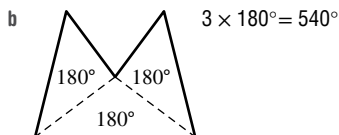
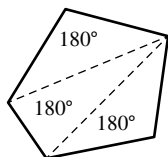

c This way of splitting includes some angles that are not at the vertices  $A, B, C, D$ . In fact, a revolution ( $360^\circ$ ) is formed in the middle, so the sum of the internal angles is  $4 \times 180^\circ - 360^\circ = 360^\circ$ .

- 9 a  $\frac{S}{n}$                                         b  $\frac{180(n-2)}{n}$   
 c i  $150^\circ$                                         ii  $175.61^\circ$
- 10 a 6                                        b 20                                        c 11
- 11 a 150                                        b 130                                        c 270

**2F**

**Building understanding**

- 1 a Vertices                                        b Seven                                        c Congruent  
 d Seven                                        e Octagonal
- 2 a 24                                        b 7                                        c 8
- 3 a 6, 8, 12                                        b 5, 6, 9                                        c 7, 7, 12
- 4 A, cube; B, pyramid; F, rectangular prism; G, tetrahedron; H, hexahedron

**Now you try**

Example 10

- a i Pentahedron                                        ii Octahedron  
 iii Tetrahedron (4 faces)
- b i Triangular prism                                        ii Hexagonal prism  
 iii Triangular pyramid

Example 11  
 $V = 8$

**Exercise 2F**

- 1 a i Pentahedron                                        ii Hexahedron  
 b i Triangular prism                                        ii Pentagonal pyramid
- 2 a Hexahedron                                        b Tetrahedron  
 c Pentahedron                                        d Heptahedron  
 e Nonahedron                                        f Decahedron  
 g Undecahedron                                        h Dodecahedron
- 3 a 8                                        b 6                                        c 4                                        d 5  
 e 7                                        f 9                                        g 10                                        h 11
- 4 a Triangular prism                                        b Pentagonal prism  
 c Square prism
- 5 a Rectangular pyramid                                        b Heptagonal pyramid  
 c Triangular pyramid

6 a

Solid	Faces ( $F$ )	Vertices ( $V$ )	Edges ( $E$ )	$F + V$
Cube	6	8	12	14
Square pyramid	5	5	8	10
Tetrahedron	4	4	6	8
Octahedron	8	6	12	14

b  $F + V$  is 2 more than  $E$ .

7

Faces ( $F$ )	Vertices ( $V$ )	Edges ( $E$ )
6	8	12
5	5	8
5	6	9
7	7	12
4	4	6
11	11	20

- 8 a 26                                        b 11                                        c 28
- 9 a True                                        b False                                        c True  
 d True                                        e False (sphere)                                        f True  
 g False

- 10 a Yes                      b Yes                      c No  
 d Yes                        e Yes
- 11  $F = 12, V = 12$  and  $E = 24$  so Euler's rule does not apply.
- 12 a Hexahedron, rectangular prism  
 b Undecahedron, decagonal pyramid
- 13 a  $V = E - F + 2$                       b  $F = E - V + 2$
- 14 a  $V = 8, E = 14, F = 8$  and  $V + F - 2 = E$   
 b  $V = 16, E = 24, F = 10$  and  $V + F - 2 = E$   
 c  $V = 6, E = 12, F = 8$  and  $V + F - 2 = E$
- 15 a True                                      b True
- 16 a i Convex                      ii Non-convex                      iii Non-convex  
 b Answers may vary.

**2G**

**Building understanding**

- 1 a B  
 b D  
 c 6
- 2 a C  
 b i (2, 3, 0)  
 ii (0, 3, 0)  
 iii (2, 3, 4)  
 c

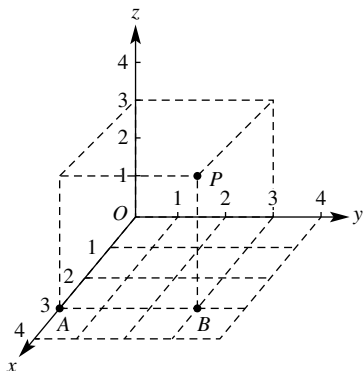

**Now you try**

- Example 12  
 a (B, b, 4)  
 b (D, a, 2)  
 c (A, d, 3)
- Example 13  
 a (2, 0, 0)  
 b (2, 4, 0)  
 c (0, 4, 3)  
 d (2, 4, 3)

**Exercise 2G**

- 1 a (A, a, 2)  
 b (D, c, 1)  
 c (B, d, 4)
- 2 a (A, b, 2)  
 b (D, d, 1)  
 c (D, a, 4)
- 3 Square i
- 4 a (2, 0, 0)  
 b (2, 4, 0)  
 c (0, 4, 3)  
 d (2, 4, 3)
- 5 a (4, 0, 0)  
 b (4, 1, 0)  
 c (0, 1, 3)  
 d (4, 1, 3)
- 6 a

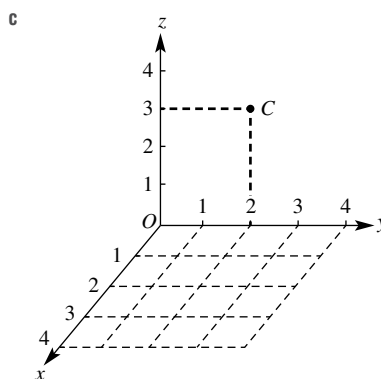
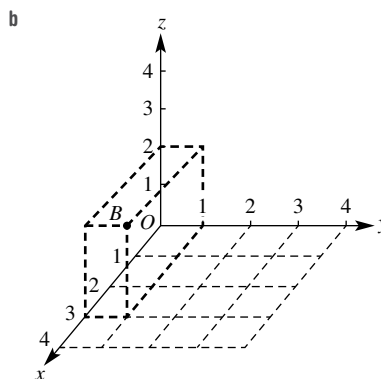
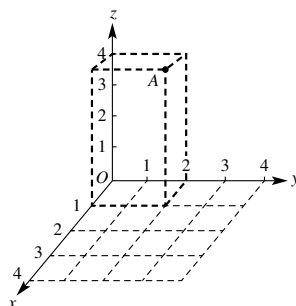

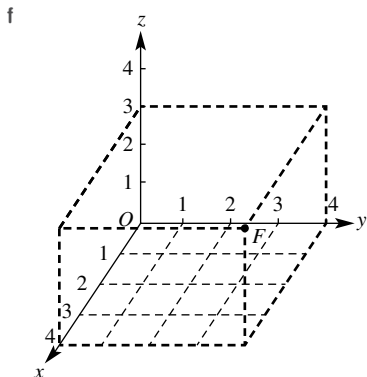
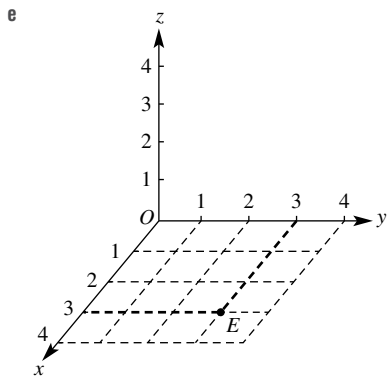
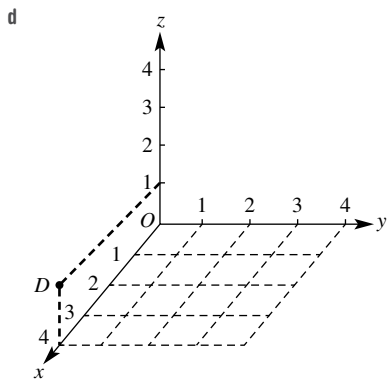

- 7 a 5  
 b 3  
 c 5  
 d 5  
 e 8  
 f 3
- 8 a i (C, b, 4)  
 b (A, d, 5)  
 c (C, b, 2)
- 9 a i 22 m  
 ii 95 m  
 iii 59 m  
 b i 16 m  
 ii 31 m  
 iii 32 m

ii (B, c, 3)

- c i 25 m  
 ii 53 m  
 iii 91 m

10 A drone can travel in three-dimensions, two for the horizontal plane and one for the altitude.

- 11 a 6  
 b 16  
 c 30  
 d 56
- 12 a A hill (or knoll)  
 b A hill (or knoll)  
 c A valley or gully  
 d A hollow  
 e A ridge line

13 Answers will vary.

Problems and challenges

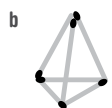
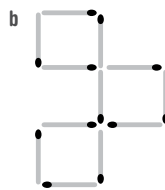
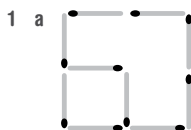

- 3 a 30  
 b 150

4 125°

5

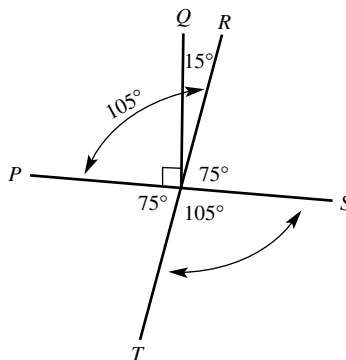



- 6 180. Find each angle in the interior pentagon in terms of  $a, b, c, d$  and/or  $e$ . Then solve the sum equal to  $540^\circ$  for a pentagon.

**Chapter checklist with success criteria**

- 1  $a = 60, b = 270$
- 2  $a = 120, b = 120, c = 60$
- 3  $a = 77$
- 4  $a = 71$
- 5  $a = 103, b = 77; a = 55$
- 6 Angle sum =  $540^\circ; a = 105$
- 7  $135^\circ$
- 8 The solid has 7 faces (hepta- for 7); it is a pentagonal prism
- 9 It has 6 faces
- 10 (B, c, 4)
- 11  $A(2, 0, 0), B(2, 4, 0), C(0, 4, 3), P(2, 4, 3)$

**Chapter review**

**Short-answer questions**

- 1 a 50  
b 65  
c 240  
d 36  
e 61  
f 138
- 2 a 132  
b 99  
c 77  
d 51  
e 146  
f 41
- 3  $95^\circ$
- 4 a Scalene, 35  
b Isosceles, 30  
c Equilateral, 60  
d Right angle, 19  
e Scalene, 27  
f Scalene, 132
- 5 a 67  
b 141  
c 105
- 6 a  $a = 98, b = 82$   
b  $a = 85, b = 106$   
c  $a = 231, b = 129$
- 7 a  $900^\circ$   
b  $1260^\circ$   
c  $10800^\circ$

- 8 a  $108^\circ$   
b  $150^\circ$
- 9 a 71  
b 25  
c 67.5
- 10 a Hexahedron  
b Decahedron  
c Undecahedron
- 11 a Triangular prism  
b Octagonal prism  
c Rectangular pyramid

12	<i>F</i>	<i>V</i>	<i>E</i>
	5	5	8
	9	14	21
	7	10	15

- 13 (B, c, 3)
- 14 a (1, 0, 0)  
b (1, 2, 0)  
c (0, 2, 4)  
d (1, 2, 4)
- 15 40

**Multiple-choice questions**

- 1 D
- 2 A
- 3 E
- 4 B
- 5 C
- 6 D
- 7 E
- 8 A
- 9 C
- 10 D

**Extended-response questions**

- 1 a Triangle, quadrilateral, pentagon, hexagon  
b  $a = 90, b = 119, c = 29, d = 121, e = 270, f = 230$
- 2 a  $4320^\circ$   
b  $166^\circ$   
c  $14^\circ$   
d  $360^\circ$   
e i 28  
ii 52  
iii 78

## Chapter 3

## 3A

## Building understanding

- 1 a 6, 20, 200                      b 14, 40, 140  
c 1, 6, 42                              d 8, 3, 20

2  $\frac{4}{6}, \frac{20}{30}, \frac{10}{15}$

- 3 a False                              b True                              c True  
d False                              e True                              f True

## Now you try

Example 1

- a  $\frac{40}{50}$                       b  $\frac{25}{50}$                       c  $\frac{55}{50}$                       d  $\frac{20}{50}$

Example 2

- a  $\frac{5}{12}$                       b  $\frac{8}{5}$

## Exercise 3A

- 1 a  $\frac{8}{24}$                       b  $\frac{6}{24}$                       c  $\frac{12}{24}$                       d  $\frac{10}{24}$   
e  $\frac{72}{24}$                       f  $\frac{120}{24}$                       g  $\frac{18}{24}$                       h  $\frac{21}{24}$
- 2 a  $\frac{6}{30}$                       b  $\frac{10}{30}$                       c  $\frac{15}{30}$                       d  $\frac{90}{30}$   
e  $\frac{20}{30}$                       f  $\frac{11}{30}$                       g  $\frac{75}{30}$                       h  $\frac{15}{30}$
- 3 a 6                      b 18                      c 2                      d 7  
e 28                      f 50                      g 15                      h 44
- 4 a 2, 3, 5, 10, 16, 25                      b 4, 6, 8, 14, 20, 30  
c 6, 12, 24, 30, 75, 300                      d 8, 12, 28, 44, 80, 400
- 5 a  $\frac{1}{3}$                       b  $\frac{1}{2}$                       c  $\frac{5}{6}$                       d  $\frac{5}{6}$   
e  $\frac{1}{4}$                       f  $\frac{3}{5}$                       g  $\frac{8}{9}$                       h  $\frac{5}{7}$   
i  $\frac{5}{3}$                       j  $\frac{11}{10}$                       k  $\frac{6}{5}$                       l  $\frac{4}{3}$
- 6 a  $\frac{1}{4}$                       b  $\frac{2}{5}$                       c  $\frac{3}{7}$                       d  $\frac{5}{9}$   
e  $\frac{13}{11}$                       f  $\frac{7}{4}$                       g  $\frac{21}{17}$                       h  $\frac{81}{50}$

7  $\frac{14}{42} = \frac{1}{3}, \frac{51}{68} = \frac{3}{4}, \frac{15}{95} = \frac{3}{19}$

8  $\frac{5}{11} = \frac{15}{33}, \frac{3}{5} = \frac{9}{15}, \frac{7}{21} = \frac{1}{3}, \frac{8}{22} = \frac{4}{11}, \frac{16}{44}, \frac{2}{7} = \frac{6}{21}, \frac{20}{50} = \frac{4}{10}$

9 a  $\frac{3}{4}$

b  $\frac{2}{3}$

- c No,  $\frac{3}{4} = \frac{9}{12}$  of time complete. However, only  $\frac{2}{3} = \frac{8}{12}$  of laps completed.

- 10 a Cannot be simplified, e.g.  $\frac{3}{5}, \frac{7}{11}$ ... The HCF of the numerator and denominator is 1.

- b Possibly. e.g.  $\frac{15}{16}$ : both are composite numbers, but HCF is 1 and therefore the fraction cannot be simplified. However, in  $\frac{15}{18}$ , both numbers are composite, HCF is 3 and therefore the fraction can be simplified to  $\frac{5}{6}$ .

- 11 a No                              b Yes                              c 10

- 12 Infinite: provided the denominator is twice the numerator then the fraction will be equivalent to  $\frac{1}{2}$ .

- 13 a i 6b                      ii 5x                      iii 80                      iv 12de  
v bc                      vi 3km                      vii 16ac                      viii xy

b i  $\frac{3b}{4}$                       ii  $\frac{1}{2y}$                       iii  $\frac{3}{5}$                       iv  $\frac{5}{8x}$

v  $\frac{2}{3q}$                       vi  $\frac{10}{x}$                       vii  $\frac{a}{q}$                       viii  $\frac{3}{x}$

c Yes,  $\frac{5x}{15x} = \frac{1}{3}$ .

d Yes,  $\frac{1}{3} = \frac{a}{3a}$ .

## 3B

## Building understanding

- 1 a +, -                              b ×, ÷
- 2 a ×, ÷                              b +, -
- 3 a 20                      b 9                      c 50                      d 24
- 4 a 3, 12                              b 14, 5  
c 11, 33                              d ×, 14, 1, 1
- 5 a  $\frac{8}{5}$                       b  $\frac{2}{3}$                       c  $\frac{4}{13}$                       d  $\frac{11}{12}$

## Now you try

Example 3

a  $1\frac{3}{7}$                       b  $\frac{9}{10}$

Example 4

a  $5\frac{5}{6}$                       b  $\frac{5}{6}$

Example 5

a  $\frac{21}{40}$                       b  $4\frac{2}{3}$                       c  $6\frac{3}{10}$

Example 6

a  $\frac{24}{35}$                       b  $\frac{3}{4}$                       c  $1\frac{1}{3}$

## Exercise 3B

1 a  $\frac{4}{7}$                       b  $\frac{5}{9}$                       c  $\frac{4}{5}$                       d  $\frac{3}{8}$

2 a  $\frac{3}{5}$                       b  $\frac{1}{2}$                       c  $\frac{5}{9}$                       d  $\frac{2}{5}$

e  $1\frac{3}{20}$                       f  $1\frac{1}{10}$                       g  $\frac{1}{21}$                       h  $\frac{4}{9}$

- 3 a  $4\frac{4}{7}$       b  $9\frac{3}{5}$       c  $2\frac{3}{8}$       d  $1\frac{2}{11}$   
 e  $9\frac{1}{2}$       f  $22\frac{3}{14}$       g  $3\frac{3}{4}$       h  $1\frac{17}{30}$   
 4 a  $\frac{3}{20}$       b  $\frac{10}{63}$       c  $1\frac{17}{25}$       d  $1\frac{13}{27}$   
 e  $\frac{1}{6}$       f  $\frac{3}{8}$       g  $\frac{8}{15}$       h 5  
 5 a  $3\frac{2}{3}$       b  $1\frac{2}{21}$       c 15      d 35  
 6 a  $\frac{10}{27}$       b  $\frac{5}{6}$       c  $\frac{16}{77}$       d  $1\frac{7}{15}$   
 e  $\frac{7}{8}$       f 2      g  $1\frac{1}{3}$       h  $3\frac{3}{5}$   
 7 a  $\frac{33}{35}$       b  $\frac{48}{125}$       c  $1\frac{2}{5}$       d 3  
 8 a  $\frac{15}{16}$       b  $\frac{1}{12}$       c  $1\frac{1}{6}$       d  $1\frac{1}{2}$   
 9 a  $\frac{3}{14}$       b  $\frac{1}{5}$       c  $\frac{29}{70}$       d  $\frac{41}{70}$   
 10  $\frac{3}{5}$   
 11 7 kg  
 12 112 glasses  
 13 Answers may vary.  
 a 5, 5      b 4      c 5, 2      d 1, 1  
 14 Answers may vary.  
 a 2, 5      b 18      c 10, 1      d  $3\frac{4}{15}$   
 15 a  $\frac{3}{16}$       b  $\frac{4}{3}$       c 5      d  $4\frac{1}{2}$   
 16 a  $\frac{3}{4}$       b  $\frac{7}{8}$       c  $\frac{1023}{1024}$

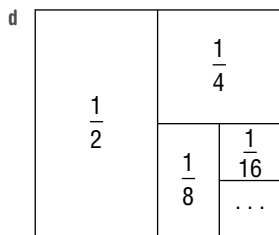

If you start with a whole (1) and only ever add in half the remaining space, you'll always have a total less than 1.

- 17 a  $(\frac{1}{6} + \frac{1}{5} - \frac{1}{3}) \times (\frac{1}{4}) \div (\frac{1}{2}) = \frac{1}{60}$   
 b  $(\frac{1}{2} \div \frac{1}{6} - \frac{1}{5} + \frac{1}{4}) \times \frac{1}{3} = 1\frac{1}{60}$   
 c  $\frac{1}{4} \div (\frac{1}{5} - \frac{1}{6}) \times (\frac{1}{3} + \frac{1}{2}) = 6\frac{1}{4}$

**3C**

**Building understanding**

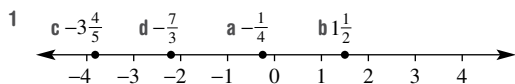

- 2 a  $\frac{1}{4}$       b  $-\frac{1}{3}$       c  $\frac{3}{5}$       d  $-\frac{2}{7}$   
 3 a Positive      b Negative  
 c Negative      d Positive

**Now you try**

Example 7

- a  $-\frac{3}{11}$       b  $1\frac{2}{5}$       c  $-\frac{2}{15}$       d  $1\frac{2}{5}$

Example 8

- a  $-\frac{18}{35}$       b  $\frac{1}{6}$

Example 9

- a  $\frac{4}{5}$       b  $-\frac{7}{12}$

**Exercise 3C**

- 1 a  $\frac{4}{9}$       b  $\frac{9}{20}$       c  $\frac{3}{5}$       d  $\frac{2}{7}$   
 2 a  $-\frac{4}{7}$       b  $\frac{1}{5}$       c  $-\frac{7}{9}$       d  $-5\frac{1}{3}$   
 e  $-\frac{1}{3}$       f  $-\frac{2}{5}$       g  $\frac{3}{2}$       h  $\frac{7}{11}$   
 3 a  $-\frac{1}{12}$       b  $-\frac{13}{35}$       c  $1\frac{1}{10}$       d  $\frac{8}{9}$   
 e  $-\frac{1}{4}$       f  $\frac{1}{8}$       g  $-\frac{3}{20}$       h  $-\frac{4}{15}$   
 4 a  $-\frac{12}{35}$       b  $-\frac{16}{55}$       c  $\frac{4}{15}$       d  $\frac{5}{6}$   
 e  $-\frac{4}{21}$       f  $-\frac{1}{8}$       g  $\frac{3}{7}$       h  $-1\frac{1}{5}$   
 5 a  $-\frac{20}{21}$       b  $-\frac{9}{20}$       c  $\frac{8}{15}$       d  $1\frac{1}{3}$   
 e  $-\frac{2}{7}$       f  $-\frac{3}{20}$       g  $\frac{3}{4}$       h  $2\frac{2}{5}$

- 6  $-\frac{5}{3}, -1\frac{1}{2}, -\frac{3}{4}, -\frac{1}{2}, -\frac{1}{5}, \frac{1}{16}, \frac{3}{4}, 3\frac{1}{10}$

- 7  $16\frac{3}{4}^{\circ}\text{C}$

- 8 a Mon =  $-1\frac{2}{3}$ , Tue =  $-\frac{1}{2}$ , Wed =  $-2\frac{1}{4}$ , Thur =  $\frac{1}{4}$

- b  $-4\frac{1}{6}$       c  $12\frac{1}{6}$  hours

- 9  $1\frac{7}{20}$  metres

- 10 a >      b <      c >      d <  
 e >      f >      g <      h >

- 11 a  $\frac{4}{5} \times \frac{-5}{2} = -2$  (Other answers possible)

- b  $-\frac{1}{5} + \frac{6}{5} = 1$  (Other answers possible)

- c  $\frac{1}{5} + (-\frac{6}{5}) = -1$  (Other answers possible)

- d Not possible, neg  $\times$  neg = pos, so  
 neg  $\times$  neg  $\times$  neg = pos  $\times$  neg = neg, so the product must be negative.

- 12 a Negative    b Negative    c Negative    d Positive  
 13 a <    b >    c >    d <  
 14 a i  $1\frac{1}{2}$     ii  $\frac{1}{15}$   
       iii  $-\frac{21}{25}$     iv  $-4\frac{23}{40}$   
 b Answers may vary:  $-\frac{5}{8}, -\frac{3}{8}, -\frac{2}{8}, -\frac{1}{8}, \frac{11}{8}$   
 c Answers may vary:  $-\frac{7}{4}, -\frac{5}{4}, -\frac{3}{4}, -\frac{1}{4}, \frac{1}{4}$

**3D****Building understanding**

- 1 E  
 2 C  
 3 a 10.6    b 55.5

**Now you try**

Example 10  
 $32.152498 < 32.15253$

Example 11

- a  $\frac{9}{40}$     b  $3\frac{13}{20}$

Example 12

- a 4.07    b 0.14

**Exercise 3D**

- 1 a >    b <  
 2 a <    b >    c <  
       d <    e >    f >  
 3 a 3.6521, 3.625, 3.256, 3.229, 2.814, 2.653  
    b 1.326, 1.305, 0.802, 0.765, 0.043, 0.039  
 4 a  $\frac{31}{100}$     b  $\frac{537}{1000}$     c  $\frac{163}{200}$   
    d  $\frac{24}{25}$     e  $5\frac{7}{20}$     f  $8\frac{11}{50}$   
    g  $26\frac{4}{5}$     h  $8\frac{64}{125}$     i  $\frac{13}{250}$   
    j  $6\frac{1}{8}$     k  $317\frac{3}{50}$     l  $\frac{53}{125}$   
 5 a 0.17    b 0.301  
    c 4.05    d 7.6  
 6 a 0.12    b 0.35    c 2.5  
    d 1.75    e 0.275    f 0.68  
    g 0.375    h 0.232  
 7 2.175, 2.18, 2.25, 2.3, 2.375, 2.4  
 8 A1, B5, C07, P9, BW Theatre, gym  
 9 Opposition leader is ahead by 0.025.  
 10 a D, C, E, F, B, A    b C, D, A, E, F, B

- 11 a 2.655    b  $\frac{179}{200}$   
       c 4.61525    d  $2\frac{1109}{2000}$   
 12

2.6	4.6	$1\frac{4}{5}$
2.2	$\frac{6}{2}$	3.8
4.2	1.4	$3\frac{2}{5}$

- 13 a €59.15    b A\$183.23    c Canada  
 d £35  
 e 91.4c  
 f AUD, CAD, USD, EUR, GBP  
 g Cheaper to buy car in GB and freight to Australia.  
 h Answers may vary.

**3E****Building understanding**

- 1 B    2 E    3 C    4 B

**Now you try**

Example 13

- a 125.459    b 4.85

Example 14

- a 0.27135    b 15 900

Example 15

- a 13.16    b 22.113

Example 16

- a 12.42    b 134.8

**Exercise 3E**

- 1 a 62.71    b 277.99  
    c 23.963    d 94.172  
 2 a 14.41    b 23.12  
    c 84.59    d 4.77  
 3 a 179.716    b 50.3192    c 1025.656  
    d 18.3087  
 4 d 11.589    c 9.784  
    b 19.828    a 4.58  
 5 a 3651.73    b 81.55    c 0.75  
    d 0.03812    e 6 348 000    f 0.0010615  
    g 30    h 0.000452  
 6 a 99.6    b 12.405    c 107.42  
    d 1.8272    e 0.01863    f 660.88  
    g 89.0375    h 292.226

- 7 a 12.27      b 5.88      c 0.0097  
 d 49.65      e 11.12      f 446.6  
 g 0.322655      h 3.462
- 8 a 203.8      b 0.38      c 2 011 500  
 d 11.63      e 0.335      f 13.69  
 g 0.630625      h 1353.275
- 9 a 16.29      b 15.52      c 66.22  
 d 1.963      e 13.3084      f 3.617  
 g 97      h 42.7123
- 10 7.12 m  
 11 12 200 skis  
 12 1200 km  
 13 1807 mm, 1.807 m
- 14 a  $\frac{21}{100} = 0.21$       b  $\frac{307}{1000} = 0.307$   
 c  $\frac{1}{100} = 0.01$
- 15  $x \div 0.2$   
 $= x \div \frac{1}{5}$   
 $= x \times \frac{5}{1}$   
 $= 5x$ , so you get the same as if multiplying by 5.
- 16 D  
 17 Answers may vary.

**3F**

**Building understanding**

- 1 a T      b R      c R      d T  
 e T      f R      g T      h R
- 2 a 0.3      b  $6.\overline{21}$  or  $6.\overline{21}$   
 c 8.5764      d 2.1356 or  $2.\overline{1356}$
- 3 a 4      b 9      c 7      d 6

**Now you try**

- Example 17  
 a 0.4      b 0.375
- Example 18  
 a 0.5      b  $2.42857\overline{1}$  or  $2.\overline{428571}$
- Example 19  
 a 12.54      b 4.2900
- Example 20  
 0.7143

**Exercise 3F**

- 1 a 0.2      b 0.625  
 2 a 0.6      b 0.75  
 c 0.125      d 0.55
- 3 a 0.3      b 0.5      c 0.83  
 d  $0.\overline{72}$       e  $0.42857\overline{1}$       f  $0.38461\overline{5}$   
 g 3.13      h  $4.85714\overline{2}$

- 4 a 0.766      b 9.5      c 7.0  
 d 21.5134      e 0.95      f 17  
 g 8.60      h 8.106
- 5 a 17.01      b 5.20      c 79.00      d 0.00  
 6 a 65      b 9      c 30      d 4563  
 7 a 0.86      b 0.22      c 0.36      d 0.42
- 8 a 9.1      b 11.8      c 21.3  
 d 11.6      e 2.3      f 3
- 9 a 7.7000      b 5.0      c 0.00700  
 10 a 0 seconds      b 0 seconds      c 0.06 seconds  
 d 12.765      e 47 cm
- 11 4  
 12  $0.\overline{0588235294117647}$
- 13 Frieda is correct. Infinite, non-recurring decimals do exist. Examples include pi ( $\pi = 3.1415926535 \dots$ ) and surds such as  $\sqrt{3} = 1.73205080 \dots$
- 14 Student A: When dealing with a critical digit of 5 they incorrectly round down rather than round up.  
 Student B: When rounding down, student B incorrectly replaces final digit with 0.
- 15 a i T      ii R  
 iii R      iv R  
 v T      vi R  
 b  $8 = 2^3$ ,  $12 = 2^2 \times 3$ ,  $14 = 2 \times 7$ ,  $15 = 3 \times 5$ ,  $20 = 2^2 \times 5$ ,  $60 = 2^2 \times 3 \times 5$   
 c Only denominators which have factors that are only powers of 2 and/or 5 terminate.
- d i T      ii R      iii R      iv T  
 v R      vi R      vii T      viii T

**Progress quiz**

- 1 a  $\frac{1}{3} = \frac{2}{6} = \frac{7}{21} = \frac{15}{45}$       b  $\frac{5}{2} = \frac{20}{8} = \frac{35}{14} = \frac{125}{50}$
- 2 a  $\frac{1}{3}$       b  $\frac{3}{5}$   
 c  $\frac{7}{9}$       d  $\frac{3}{2}$
- 3 a  $\frac{3}{5}$       b  $\frac{1}{10}$   
 c  $-\frac{7}{12}$       d  $1\frac{1}{5}$
- 4 a  $\frac{6}{35}$       b  $\frac{2}{3}$   
 c  $-2\frac{1}{4}$       d  $4\frac{2}{3}$
- 5 a  $2\frac{2}{5}$       b  $-1\frac{1}{3}$   
 c  $1\frac{1}{8}$       d  $\frac{1}{3}$
- 6 a  $0.2531 > 0.24876$       b  $17.3568 < 17.3572$
- 7 a  $\frac{9}{20}$       b  $6\frac{64}{125}$
- 8 a 0.28      b 0.043  
 c 1.75      d 0.45  
 9 a 48.347      b 177.75  
 10 a 2.3      b 0.00937      c 36.61  
 d 18.328      e 18.26      f 22.05  
 11 a 0.5      b 0.72      c 6.13  
 12 a 23.67      b 2.740  
 13 a 0.33      b 0.42

## 3G

## Building understanding

1 B      2 B      3 C      4 A

## Now you try

Example 21

a  $2\frac{2}{5}$

b  $\frac{3}{40}$

Example 22

a 5.3

b 0.1243

Example 23

a 75%

b  $87\frac{1}{2}\%$

c 350%

d  $16\frac{2}{3}\%$

Example 24

a 52.3%

b 820%

## Exercise 3G

1 a  $\frac{39}{100}$

b  $\frac{11}{100}$

c  $\frac{1}{5}$

d  $\frac{3}{4}$

e  $1\frac{1}{4}$

f  $\frac{7}{10}$

g  $2\frac{1}{20}$

h  $6\frac{1}{5}$

2 a  $\frac{3}{8}$

b  $\frac{31}{200}$

c  $\frac{1}{3}$

d  $\frac{2}{3}$

e  $\frac{9}{400}$

f  $\frac{9}{200}$

g  $\frac{51}{500}$

h  $\frac{7}{8}$

3 a 0.65

b 0.37

c 1.58

d 3.19

e 0.0635

f 0.0012

g 40.51

h 1.0005

4 a 40%

b 25%

c 55%

d 26%

e 22.5%

f 68%

g 75%

h 41.5%

5 a 275%

b 520%

c 175%

d 450%

e 348%

f 194%

g 770%

h 915%

6 a  $33\frac{1}{3}\%$ b  $12\frac{1}{2}\%$ c  $8\frac{1}{3}\%$ d  $6\frac{2}{3}\%$ e  $37\frac{1}{2}\%$ f  $28\frac{4}{7}\%$ g  $18\frac{3}{4}\%$ 

h 75%

7 a 42%

b 17%

c 354.1%

d 1122%

e 0.35%

f 4.17%

g 1%

h 101%

8 A

9 a

Fraction	Decimal	%
$\frac{1}{4}$	0.25	25%
$\frac{2}{4}$	0.5	50%
$\frac{3}{4}$	0.75	75%
$\frac{4}{4}$	1	100%

b

Fraction	Decimal	%
$\frac{1}{3}$	0.3	$33\frac{1}{3}\%$
$\frac{2}{3}$	0.6	$66\frac{2}{3}\%$
$\frac{3}{3}$	0.9	100%

c

Fraction	Decimal	%
$\frac{1}{5}$	0.2	20%
$\frac{2}{5}$	0.4	40%
$\frac{3}{5}$	0.6	60%
$\frac{4}{5}$	0.8	80%
$\frac{5}{5}$	1	100%

10 a

Fraction	Decimal	%
$\frac{3}{20}$	0.15	15%
$\frac{6}{25}$	0.24	24%
$\frac{3}{8}$	0.375	37.5%
$\frac{5}{40}$	0.125	12.5%
$\frac{7}{10}$	0.7	70%
$\frac{31}{50}$	0.62	62%

Fraction	Decimal	%
$\frac{11}{5}$	2.2	220%
$\frac{3}{1000}$	0.003	0.3%
$\frac{13}{200}$	0.065	6.5%
$1\frac{19}{100}$	1.19	119%
$4\frac{1}{5}$	4.2	420%
$\frac{5}{6}$	0.8 $\dot{3}$	83 $\frac{1}{3}$ %

11  $\frac{1}{8}$ , 12.5%, 0.125

12 65%, 80%

13  $\frac{0.5}{2 \times 1.10}$  and  $\frac{1}{2} = \frac{5}{10} = 0.5$

14 a  $\times 100\% = \times \frac{100}{100} = \times 1$

b  $\div 100\% = \div \frac{100}{100} = \div 1$

15 a  $\frac{BC}{100}$       b 0.CDB      c ABC%  
 d  $DDB.CC\%$       e  $\frac{100A}{D}\%$       f  $\frac{100(BA + C)}{A}\%$

16 a  $\frac{1}{4} = 25\% = 0.25$

$\frac{1}{4} = 25\% = 0.25$

$\frac{1}{2} \times \frac{1}{2} \times \frac{1}{2} = \frac{1}{8} = 12\frac{1}{2}\% = 0.125$

$\frac{1}{2} \times \frac{1}{2} \times \frac{1}{2} = \frac{1}{8} = 12\frac{1}{2}\% = 0.125$

$\frac{1}{2} \times \frac{1}{2} \times \frac{1}{2} = \frac{1}{8} = 12\frac{1}{2}\% = 0.125$

$\frac{1}{2} \times \frac{1}{8} = \frac{1}{16} = 6\frac{1}{4}\% = 0.0625$

$\frac{1}{2} \times \frac{1}{8} = \frac{1}{16} = 6\frac{1}{4}\% = 0.0625$

b–e Answers may vary.

**3H**

**Building understanding**

- 1 D  
 2 A  
 3 a 100      b 10  
 c 5      d 2

**Now you try**

Example 25

- a 70%  
 b  $18\frac{1}{3}\%$

Example 26

- a 15%      b 500%

Example 27

- a 21      b 42

**Exercise 3H**

- 1 a 70%      b 80%  
 c 30%      d 60%
- 2 a 80%      b 65%  
 d 40%      f  $70\frac{5}{6}\%$   
 e  $36\frac{2}{3}\%$   
 g  $70\frac{5}{6}\%$   
 h  $94\frac{4}{9}\%$
- 3 a 30%      b 45%      c  $31\frac{1}{4}\%$   
 d  $83\frac{1}{3}\%$       e 160%      f  $683\frac{1}{3}\%$   
 g  $133\frac{1}{3}\%$   
 h  $266\frac{2}{3}\%$
- 4 a 8.33%      b 66.67%      c 42.86%  
 d 37.5%      e 160%      f 125%  
 g 112.5%      h 233.33%
- 5 a 56%      b 75%      c 86%  
 d 25%      e 40%      f  $33\frac{1}{3}\%$   
 6 a 5%      b 25%      c 5%  
 d 25%      e 4%      f 4000%  
 g 300%      h 600%
- 7 a 18      b 9      c 17  
 d 16      e 3      f 3  
 g 5.6      h 175      i 132  
 j 39.6      k 44.8      l 36.8
- 8 a 13      b 80      c 100  
 d 217      e 67.5      f 51.2  
 g 36.75      h 70.8
- 9 a 18 minutes      b \$0.75      c 45 kg  
 d 62.5 mL      e 5.6 days      f 3.3 km
- 10 a  $5\frac{1}{3}$  L  
 b 2000 marbles  
 c \$8      d 45 doughnuts
- 11 540  
 12 Murray, Maeheala, Francesca, Wasim  
 13  $61\frac{1}{9}\%$ , 61.1%  
 14 68.75%  
 15 22  
 16 \$24, \$24, They are the same.  $\frac{40}{100} \times 60 = \frac{60}{100} \times 40$  as multiplication is commutative.  
 17 B  
 18 D  
 19 a 240 cm<sup>2</sup>  
 b Area will increase by more than 25%  
 c 15 cm by 25 cm

- d  $375 \text{ cm}^2$   
 e  $135 \text{ cm}^2$   
 f 56.25%  
 g 56.25% increase in area  
 h Multiply the percentage increase in each dimension.  
 $1.25 \times 1.25 = 1.5625 = 56.25\%$  increase  
 i i 21% ii 44%  
 iii  $77\frac{7}{9}\%$  iv 125%  
 j 41.42% increase ( $\sqrt{2}$ )  
 k Answers may vary.

**3I****Building understanding**

- 1 a \$12 b \$33.99  
 c \$14.50 d \$225  
 2 a \$40 b \$36  
 c \$40.50 d \$15  
 3 a \$12 b \$108

**Now you try**

Example 28

- a \$260 b \$45

Example 29

- a \$540 b \$1475

**Exercise 3I**

- 1 a \$88 b \$70  
 c \$144 d \$300  
 2 a \$440 b \$276 c \$64  
 d \$41 160 e \$5400 f \$96.96  
 g \$13.50 h \$50.40  
 3 a \$480 b \$127.50 c \$39  
 d \$104 e \$15.40 f \$630  
 4 a \$12 b \$24 c \$37.50  
 d \$63.75 e \$97.50 f \$4.95  
 5 a \$38.50 b \$82.50 c \$46.20  
 d \$91.30 e \$57.75 f \$164.99  
 6 Shop C: \$80, shop D: \$75  
 7 Premier rug: \$250, luxury rug: \$375  
 8 Cash: \$44.90, credit card: \$44.91  
 9 \$265.60  
 10 \$84  
 11 a 1.24 b 0.65  
 c 1.04 d 0.91

- 12 a \$198. It is less than \$200 because the amount increased (\$20) is less than the amount decreased (\$22).  
 b 1%. If the original value is  $x$ , then increasing by 10% gives  $1.1x$ . Decreasing by 10% is the same as multiplying by 0.9, so that gives  $0.9 \times 1.1x = 0.99x$ , which is a 1% decrease.

13 Eastern Bikers, \$2320

- 14 a i \$85 ii \$630  
 iii \$275 iv \$350  
 b \$106.50  
 c Sam: \$720, Jack: \$680, Justin: \$700  
 d Sold: \$3200, Wage: \$960

**3J****Building understanding**

- 1 a \$7 b \$436  
 2 a \$45 b \$25.90  
 3 D  
 4 A

**Now you try**

Example 30

- a 24% profit b 15% loss

Example 31

55% profit

**Exercise 3J**

- 1 a 50%  
 b 40%  
 c 25%  
 2 a 80% profit  
 b 30% profit  
 c 25% loss  
 d 16% loss  
 e  $66\frac{2}{3}\%$  profit  
 f 37.5% profit  
 3 a 20% increase  
 b  $16\frac{2}{3}\%$  decrease  
 c 500% increase  
 d 150% increase  
 4 a 25% increase  
 b 20% increase  
 c 140% increase  
 d 25% decrease  
 5 a 4%  
 b 6.25%  
 c 0.6%  
 d 0.5%



- 6 20% loss
- 7 650% profit
- 8 a \$36  
b 75% profit
- 9 a \$350  
b 87.5% profit
- 10 a \$2200  
b 44% loss
- 11 \$10 out of \$40 is a higher percentage (25%) than \$10 out of \$50 (20%).
- 12 Store A
- 13 a i 100%                      ii  $66\frac{2}{3}\%$                       iii 80%  
b Term 2  
c 500% growth
- 14 a 396 071  
b i 22 803 197  
ii 24 056 867  
iii 26 301 345  
c 2.0%  
d-h Answers may vary.

**3K**

**Building understanding**

- 1 B                                      2 D                                      3 B

**Now you try**

- Example 32  
\$700
- Example 33  
\$50
- Example 34  
\$300

**Exercise 3K**

- 1 \$500
- 2 a \$900  
b \$800  
c \$1100  
d \$500  
e \$550  
f \$250
- 3 \$90
- 4 a \$120  
b \$240  
c \$15  
d \$21
- 5 1100 litres
- 6 600 kg
- 7 \$300
- 8 a \$50  
b \$150  
c \$600  
d \$30  
e \$10  
f \$2000

- 9 200
- 10 \$40
- 11 D
- 12  $\frac{800}{y}$
- 13  $\frac{D}{C} \times F$  or  $\frac{FD}{C}$
- 14 a i \$70  
ii \$110  
iii \$50  
iv \$450  
v \$650  
b Answers may vary.

**Problems and challenges**

- 1 72.8%
- 2 96%
- 3  $\frac{1}{1000}$
- 4 \$48
- 5 53% (rounded)
- 6  $\frac{5}{12}$
- 7 30%
- 8 49 years
- 9 6:33 a.m.
- 10 a  $b = -\frac{5}{6}, c = -\frac{1}{3}$                       b  $b = 1\frac{13}{15}, c = 2\frac{1}{30}$

**Chapter checklist with success criteria**

- 1  $\frac{24}{40}$
- 2  $\frac{2}{5}$
- 3  $\frac{11}{12}, \frac{51}{8} = 6\frac{3}{8}$
- 4  $\frac{6}{35}, 8$
- 5  $\frac{14}{15}, \frac{27}{16} = 1\frac{11}{16}$
- 6 2;  $-\frac{1}{20}$
- 7  $\frac{9}{10}, -\frac{4}{9}$
- 8  $57.89342 < 57.89631$
- 9  $\frac{128}{25} = 5\frac{3}{25}$
- 10 0.36
- 11 6.84
- 12 0.09753; 275 800
- 13 39.648
- 14 2137.9
- 15 0.875;  $3.\overline{714285}$  or  $3.71428\bar{5}$
- 16 4.8620
- 17 0.43
- 18  $1\frac{3}{5}$
- 19 0.1345
- 20 17.5%

- 21 45.8%  
 22 85%; 12%  
 23 93  
 24 \$224  
 25 \$645  
 26 20%  
 27 \$600  
 28 \$175  
 29 \$150

**Chapter review****Short-answer questions**

- 1 a 21  
 b 8  
 c 10  
 2 a  $\frac{5}{9}$   
 b 3  
 c  $\frac{17}{2}$   
 3 a  $\frac{7}{11}$   
 b  $\frac{1}{8}$   
 c  $1\frac{3}{4}$   
 d  $1\frac{7}{12}$   
 e  $5\frac{13}{20}$   
 f  $3\frac{17}{30}$   
 4 a 8  
 b  $\frac{13}{28}$   
 c 14  
 d 6  
 e  $\frac{1}{18}$   
 f 2  
 5 a  $-\frac{7}{15}$   
 b  $-\frac{3}{20}$   
 c  $\frac{9}{25}$   
 d  $\frac{19}{20}$   
 e -5  
 f  $-7\frac{7}{12}$   
 6 a =  
 b <  
 c >  
 7 a 30.38  
 b 12.803  
 c 56 974  
 d 50 280  
 e 74 000  
 f 2.9037

- 8 a 10.68  
 b 0.1068  
 c 14.4  
 d 0.255  
 e 3.6  
 f 197.12  
 9 a 0.667  
 b 3.580  
 c 0.005  
 10

0.1	0.01	0.05	0.5	0.25	0.75	0.3	0.125
$\frac{1}{10}$	$\frac{1}{100}$	$\frac{1}{20}$	$\frac{1}{2}$	$\frac{1}{4}$	$\frac{3}{4}$	$\frac{1}{3}$	$\frac{1}{8}$
10%	1%	5%	50%	25%	75%	$33\frac{1}{3}\%$	12.5%

- 11 a 87.5%  
 b 25%  
 c 150%  
 d 4%  
 e 6%  
 12 a 24  
 b \$10.50  
 c 10.5  
 13 a \$616  
 b \$3280  
 c \$977.55, overall percentage loss is 0.25%  
 14 \$359.91, \$3639.09  
 15 29%  
 16 \$680  
 17 4%  
 18 1120  
 19 \$3.31

**Multiple-choice questions**

- 1 B  
 2 C  
 3 D  
 4 C  
 5 D  
 6 B  
 7 B  
 8 A  
 9 C  
 10 B

**Extended-response question**

- a 21 000 INR, 625 SGD, 15 000 THB, 3500 HKD  
 b \$30  
 c i 800  
 ii 3.8%  
 d i \$96.48  
 ii \$95.03, not enough to buy perfume.

Chapter 4

4A

Building understanding

- 1 a 10                      b 100                      c 1000  
 d 100 000                e 1000                    f 1 000 000  
 2 a 1000                    b 100 000                c 1 000 000  
 3 a 10                      b 10                      c 2

Now you try

Example 1  
 a 350 mm                      b 1.2 km

Example 2  
 36 cm

Example 3  
 $x = 8$

Exercise 4A

- 1 a i 36 mm                      ii 2.8 cm  
 b i 0.42 km                      ii 21 000 cm  
 2 a 30 mm                      b 610 cm                      c 8930 m  
 d 3000 mm                    e 2.1 m                      f 32 cm  
 g 9.62 km                      h 0.38 km                    i 4.3 mm  
 j 2040 cm                      k 23.098 m                    l 3.42 km  
 m 194.3 m                      n 0.01 km                      o 24.03 mm  
 p 0.994 m  
 3 a 19 m                      b 44 m                      c 13 cm  
 d 32 cm                      e 28 km                      f 18 cm  
 g 17.2 mm                    h 34.4 cm                    i 29.4 m  
 4 a 5                      b 2                      c 4  
 d 18                      e 9.5                      f 6.5  
 5 a m                      b mm                      c m  
 d km                      e m                      f mm

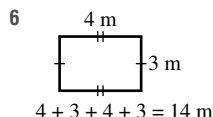

- 7 \$2392  
 8 a 40 cm                      b 17 cm                      c 7.8 cm  
 d 2000 cm                    e 46 cm                      f 17 600 cm  
 9 8 min  
 10 240 cm  
 11 a 2                      b 3                      c 9  
 12 a 152.5 cm to 153.5 cm  
 b 177.5 cm to 178.5 cm  
 c 159.5 cm to 160.5 cm  
 13 a 20 m, 2022 cm, 20 232 mm  
 b 232 mm  
 c 20 232 mm is most accurate.  
 14 a  $P = 2a + b$                       b  $P = 2a + 2b$   
 c  $P = 2a + 2b$                       d  $P = 2a + 2b$   
 e  $P = 8a + 2b$                       f  $P = 4a + 2b$

- 15 a  $x = P - 11$                       b  $x = P - 4$   
 c  $x = \frac{P-3}{2}$                       d  $x = \frac{P-8}{2}$   
 e  $x = \frac{P}{4}$                       f  $x = \frac{P}{8}$   
 16 a 6 squares                      b 8 squares

4B

Building understanding

- 1 a 15.71                      b 40.84                      c 18.85                      d 232.48  
 2 a 3.1                      b 3.14                      c 3.142  
 3 a Diameter                      b Radius  
 c Circumference  
 4 Answer is close to pi.

Now you try

Example 4  
 a 31.42 m                      b 50.27 cm

Example 5  
 a 157 cm                      b 132 m

Exercise 4B

- 1 a 18.85 m                      b 25.13 cm  
 2 a 113.10 m                      b 245.04 cm  
 c 21.99 km                      d 15.71 cm  
 3 a 314 cm                      b 62.8 m                      c 18.84 km  
 d 44 mm                      e 132 cm                      f 220 m  
 4 a 6.4 cm                      b 47.7 m  
 c 7.0 mm                      d 319.9 km  
 5 11.0 m  
 6 12 566 m  
 7 a 64.27 cm                      b 12.34 m  
 c 61.70 mm  
 8 a 28.57 cm                      b 93.97 m                      c 5.57 cm  
 9 a 25.13 cm                      b 56.55 m                      c 35.71 m  
 10 Svenya and Andre  
 11 a

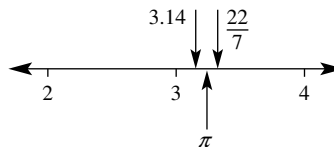

- b 3.14,  $\pi$ ,  $\frac{22}{7}$   
 c  $\frac{22}{7}$  will give a larger value, because  $\frac{22}{7} = 3.1428 \dots$  which is larger than  $\pi = 3.14159 \dots$   
 12  $d = 2r$ , so  $2\pi r$  is the same as  $\pi d$ .  
 13 a  $36\pi \text{ m}$                       b  $78\pi \text{ cm}$   
 c  $7\pi \text{ km}$                       d  $5\pi \text{ cm}$   
 14 a  $8\pi \text{ cm}$                       b  $18\pi \text{ cm}$                       c  $(5\pi + 20) \text{ m}$   
 15 a i  $r = \frac{C}{2\pi}$                       ii  $d = \frac{C}{\pi}$   
 b i 2.23 m                      ii 6.37 cm  
 16 Answers may vary.  
 17 Answers may vary.

## 4C

## Building understanding

- 1 a i 100                      ii 400                      iii 3  
 b i 10 000                    ii 70 000                    iii 4  
 c i 1 000 000                ii 5 000 000                iii 2.5  
 d i 10 000                    ii 30 000                    iii 7.5
- 2 a 7 m, 3 m  
 b 8 cm, 6 cm (or other way around)  
 c 2.4 mm, 1.7 mm
- 3 10 000

## Now you try

Example 6

- a 35 100 cm<sup>2</sup>                      b 1.5 cm<sup>2</sup>

Example 7

- a 21 cm<sup>2</sup>                      b 40 m<sup>2</sup>                      c 20 m<sup>2</sup>

Example 8

- a 65 m<sup>2</sup>                      b 36 mm<sup>2</sup>

## Exercise 4C

- 1 a 20 000 cm<sup>2</sup>                b 500 mm<sup>2</sup>                c 4 cm<sup>2</sup>  
 d 3 m<sup>2</sup>                      e 4 000 000 m<sup>2</sup>                f 8 km<sup>2</sup>
- 2 a 200 mm<sup>2</sup>                b 70 000 cm<sup>2</sup>                c 500 000 m<sup>2</sup>  
 d 30 000 m<sup>2</sup>                e 34 mm<sup>2</sup>                f 0.07 m<sup>2</sup>  
 g 30.9 cm<sup>2</sup>                h 4000 m<sup>2</sup>                i 0.2 m<sup>2</sup>  
 j 0.45 km<sup>2</sup>                k 0.4 ha                l 32.1 cm<sup>2</sup>  
 m 32 ha                      n 51 cm<sup>2</sup>                o 4.3 mm<sup>2</sup>  
 p 0.4802 m<sup>2</sup>                q 1.904 ha                r 0.2933 ha
- 3 a 9 cm<sup>2</sup>                      b 21 m<sup>2</sup>                      c 39 cm<sup>2</sup>  
 d 18 cm<sup>2</sup>                      e 33 m<sup>2</sup>                      f 144 mm<sup>2</sup>  
 g 50 m<sup>2</sup>                      h 4.5 cm<sup>2</sup>                      i 6 m<sup>2</sup>  
 j 63 m<sup>2</sup>                      k 3 m<sup>2</sup>                      l 6 km<sup>2</sup>
- 4 a 70 m<sup>2</sup>                      b 54 m<sup>2</sup>                      c 140 cm<sup>2</sup>  
 d 91 cm<sup>2</sup>                      e 46 km<sup>2</sup>                      f 64 mm<sup>2</sup>
- 5 a m<sup>2</sup>                      b cm<sup>2</sup>                      c km<sup>2</sup>  
 d m<sup>2</sup>                      e cm<sup>2</sup>
- 6 a 45 cm<sup>2</sup>                      b 168 m<sup>2</sup>                      c 120 km<sup>2</sup>
- 7 a 6 m                      b 1.5 cm
- 8 a 25 m<sup>2</sup>                      b 52 m
- 9 a i Approx. 15 m<sup>2</sup> (Answers may vary)  
 ii Approx. 10 cm<sup>2</sup> (Answers may vary)  
 b This would allow a more accurate estimate as you could count the shaded squares with higher precision.
- 10 a 10 cm                      b 2 m
- 11 \$48
- 12 A rectangular grid could be drawn on top of the scale diagram, and then you could count the number of little squares that cover the lake. The smaller the grid size, the better the estimate.
- 13 a  $A = 4b^2 + ab$  or  $A = b(4b + a)$   
 b  $A = 1.5ab$  or  $A = \frac{3ab}{2}$   
 c  $A = 2x^2$

- 14 a 16 m<sup>2</sup>, 156 816 m<sup>2</sup>, 15 657 849 mm<sup>2</sup>

b 342 151 mm<sup>2</sup>

15 a  $w = \frac{A}{l}$                       b  $l = \sqrt{A}$                       c  $h = \frac{2A}{b}$

- 16 a i 2.59 km<sup>2</sup>                      ii 2 589 988 m<sup>2</sup>  
 iii 259 ha                      iv 4047 m<sup>2</sup>  
 v 0.4 ha                      vi 2.5 acres  
 b 81 ha  
 c 62%

## 4D

## Building understanding

- 1 a 30                      b 13.5  
 2 a 90                      b Perpendicular  
 c Parallel, perpendicular                      d Rhombus, kite

## Now you try

Example 9

- a 12 m<sup>2</sup>                      b 30 cm<sup>2</sup>                      c 40 mm<sup>2</sup>

## Exercise 4D

- 1 a 40 cm<sup>2</sup>                      b 27.5 m<sup>2</sup>                      c 70 mm<sup>2</sup>
- 2 a Rhombus, 7.5 cm<sup>2</sup>                      b Rhombus, 121 km<sup>2</sup>  
 c Rhombus, 9.61 m<sup>2</sup>                      d Kite, 4 cm<sup>2</sup>  
 e Kite, 300 mm<sup>2</sup>                      f Trapezium, 96 cm  
 g Kite, 0.9 mm<sup>2</sup>                      h Trapezium, 32.5 m<sup>2</sup>  
 i Trapezium, 560 mm<sup>2</sup>
- 3 a 6 cm<sup>2</sup>                      b 35 m<sup>2</sup>                      c 84.5 cm<sup>2</sup>
- 4 0.27 m<sup>2</sup>
- 5 a 10 cm<sup>2</sup>                      b 31.5 m<sup>2</sup>
- 6 \$1160
- 7 3 cm and 9 cm
- 8 a 4 cm × 3 cm rectangle, area = 12 cm<sup>2</sup>  
 b 10 cm × 3 cm rectangle, area = 30 cm<sup>2</sup>  
 c Average = 21 cm<sup>2</sup> is the same as the trapezium's area.
- 9 a Trapezium                      b 19.5 cm<sup>2</sup>
- 10 a  $A = a^2$                       b  $A = 3ab$
- 11 No, use formula for parallelogram  $A = bh$ , as we already know these lengths. Area = 80 cm<sup>2</sup>
- 12 a  $A = 4$  triangle areas  
 $= 4 \times \frac{1}{2} \times \text{base} \times \text{height}$   
 $= 4 \times \frac{1}{2} \times \frac{1}{2}x \times \frac{1}{2}y$   
 $= \frac{1}{2}xy$
- b  $A = \text{Area (triangle 1)} + \text{Area (triangle 2)}$   
 $= \frac{1}{2} \times \text{base}_1 \times \text{height}_1 + \frac{1}{2} \times \text{base}_2 \times \text{height}_2$   
 $= \frac{1}{2} \times a \times h + \frac{1}{2} \times b \times h$   
 $= \frac{1}{2}ah + \frac{1}{2}bh$   
 $= \frac{1}{2}(a + b)h$

$$\begin{aligned}
 \text{c } A &= \text{Area (rectangle) + Area (triangle)} \\
 &= \text{length} \times \text{width} + \frac{1}{2} \times \text{base} \times \text{height} \\
 &= a \times h + \frac{1}{2} \times (b - a) \times h \\
 &= ah + \frac{1}{2}bh - \frac{1}{2}ah \\
 &= \frac{1}{2}ah + \frac{1}{2}bh \\
 &= \frac{1}{2}(a + b)h
 \end{aligned}$$

13 Answers may vary.

**4E**

**Building understanding**

- 1 a 31.4      b 12.56      c 22      d 154  
 2 a 78.54      b 530.93      c 30.19      d 301.72  
 3 a 5 m      b 2.3 mm      c 3.5 km

**Now you try**

Example 10  
 50.27 cm<sup>2</sup>

Example 11

a  $38\frac{1}{2}$  cm<sup>2</sup> ( $\frac{77}{2}$  cm<sup>2</sup>)      b 28.26 m<sup>2</sup>

Example 12

a 38.48 m<sup>2</sup>      b 56.55 km<sup>2</sup>

**Exercise 4E**

- 1 78.54 cm<sup>2</sup>  
 2 a 28.27 cm<sup>2</sup>      b 113.10 m<sup>2</sup>      c 7.07 mm<sup>2</sup>  
    d 78.54 km<sup>2</sup>      e 36.32 cm<sup>2</sup>      f 9.08 m<sup>2</sup>  
 3 a 154 cm<sup>2</sup>      b 154 km<sup>2</sup>      c 616 mm<sup>2</sup>  
    d 314 km<sup>2</sup>      e 12.56 m<sup>2</sup>      f 31 400 m<sup>2</sup>  
 4 a 3.14 cm<sup>2</sup>      b 201.06 cm<sup>2</sup>      c 226.98 mm<sup>2</sup>  
    d 39.27 cm<sup>2</sup>      e 5.09 mm<sup>2</sup>      f 100.53 m<sup>2</sup>  
 5 a 3.3 cm      b 3.2 m  
 6 707 cm<sup>2</sup>  
 7 Yes, by 1310 cm<sup>2</sup>  
 8 No ( $A = 0.79$  km<sup>2</sup>)  
 9 78.54 cm<sup>2</sup>  
 10 circle of radius 5 m  
 11 80 cm<sup>2</sup>  
 12 a Outer square contains 4 small squares of area  $r^2$  each; circle fits entirely within outer square.  
    b Inner square contains 4 small triangles of area  $\frac{1}{2}r^2$  each (so  $4 \times \frac{1}{2}r^2 = 2r^2$ ) and fits entirely within the circle.  
    c Actual area is bigger, since  $\pi > 3$ , so  $\pi r^2 > 3r^2$ , which is the average of  $2r^2$  and  $4r^2$ .  
 13 a 12.56 cm<sup>2</sup>      b 50.24 cm<sup>2</sup>  
    c Quadrupled ( $\times 4$ )      d Multiplied by 9  
    e Multiplied by 16      f Multiplied by  $\pi^2$   
 14 a  $81\pi$       b  $\frac{49\pi}{4}$       c  $72\pi$

- 15 a  $A = \frac{\pi d^2}{4}$   
    b True  
 16 a True  
    b i 2.33 m      ii 1.20 km      iii 10.09 mm  
    c  $r = \sqrt{\frac{A}{\pi}}$

**4F**

**Building understanding**

- 1 a  $\frac{1}{2}$       b  $\frac{1}{4}$       c  $\frac{1}{6}$       d  $\frac{1}{8}$   
 2 a 2.79      b 8.55      c 9.69  
 3 a  $\frac{1}{4}$       b  $\frac{1}{6}$       c  $\frac{1}{3}$

**Now you try**

Example 13

a 30.54 cm<sup>2</sup>      b 102.63 m<sup>2</sup>

Example 14

99.47 mm<sup>2</sup>

**Exercise 4F**

- 1 a 28.3 cm<sup>2</sup>      b 20.9 m<sup>2</sup>  
 2 a 88.49 mm<sup>2</sup>      b 104.72 mm<sup>2</sup>      c 4.91 cm<sup>2</sup>  
    d 61.28 m<sup>2</sup>      e 262.72 cm<sup>2</sup>      f 981.93 m<sup>2</sup>  
 3 a 37.70 m<sup>2</sup>      b 137.44 m<sup>2</sup>      c 437.21 km<sup>2</sup>  
 4 a 34.82 m<sup>2</sup>      b 9.14 m<sup>2</sup>      c 257.08 cm<sup>2</sup>  
    d 116.38 mm<sup>2</sup>      e 123.61 km<sup>2</sup>      f 53.70 m<sup>2</sup>  
    g 50.27 m<sup>2</sup>      h 75.40 mm<sup>2</sup>      i 12.57 cm<sup>2</sup>  
 5 1.26 m<sup>2</sup>  
 6 13 cm radius pizza by 0.13 cm<sup>2</sup>  
 7 16 965 cm<sup>2</sup>  
 8 a 78.5%      b 30.8%      c 21.5%  
 9 a Triangle area is  $\frac{1}{2} \times 10 \times 10 = 50$  cm<sup>2</sup>, and square's area is 100 cm<sup>2</sup>. The sector lies between the triangle and the square.  
    b Actual area of  $\frac{1}{4} \times \pi \times 10^2 \approx 78.5$  cm<sup>2</sup> is approximately 3.5 cm<sup>2</sup> bigger than 75 cm<sup>2</sup>.  
 10 a  $\pi$  cm<sup>2</sup>  
    b  $\frac{25\pi}{9}$  m<sup>2</sup>  
    c  $8\pi$  mm<sup>2</sup>  
    d  $\frac{75\pi}{2}$  m<sup>2</sup>  
    e  $(9\pi + 9)$  cm<sup>2</sup>  
    f  $(225 - \frac{225\pi}{4})$  km<sup>2</sup>  
 11 a 78.5%  
    b 78.5%, same answers as for part a.  
    c Percentage area =  $\frac{\pi r^2}{4} \div r^2 \times 100 = 25\pi \approx 78.5\%$   
 12 a 6.54 m<sup>2</sup>  
    b 2.26 m<sup>2</sup>  
    c 5.8%

## 4G

## Building understanding

- 1 a 6, squares  
b 6, squares and rectangles  
c 5, isosceles triangles and rectangles
- 2 a C                      b A                      c B
- 3 a 3                      b 6                      c 6                      d 5

## Now you try

- Example 15  
a  $108 \text{ cm}^2$                       b  $184 \text{ cm}^2$

## Exercise 4G

- 1  $220 \text{ cm}^2$   
2  $360 \text{ m}^2$   
3 a  $24 \text{ cm}^2$                       b  $403.44 \text{ m}^2$                       c  $22 \text{ cm}^2$   
d  $352 \text{ cm}^2$                       e  $84 \text{ m}^2$                       f  $612 \text{ cm}^2$   
g  $120 \text{ mm}^2$                       h  $114 \text{ m}^2$                       i  $29.7 \text{ m}^2$   
4 a  $18 \text{ cm}^2$   
b  $146 \text{ cm}^2$   
5  $2000 \text{ cm}^2$   
6 a  $810 \text{ cm}^2$                       b  $81 \text{ m}^2$   
7 a  $138 \text{ m}^2$                       b  $658 \text{ m}^2$                       c  $62 \text{ cm}^2$   
8  $\$107.25$   
9 a  $SA = 6l^2$   
b  $SA = 2w^2 + 4lw$   
c  $SA = 2wl + 2wh + 2lh$   
10 Each side length is a whole number, so each face's area is a whole number. The total surface area is found by doubling the top area, doubling the side area and doubling the front area; then these three values are added. The sum of three even numbers is also even. Alternatively, see  $SA = 2(wl + wh + lh)$ , which is double a whole number and therefore even.  
11 a i Quadrupled                      ii Multiplied by 9  
iii Multiplied by 16  
b Multiplied by  $n^2$   
12 a  $15\,072 \text{ cm}^2$                       b  $456 \text{ cm}^2$

## Progress quiz

- 1 a  $6400 \text{ mm}$                       b  $1.8 \text{ m}$   
c  $0.97 \text{ km}$                       d  $250 \text{ cm}$   
2 a  $78 \text{ cm}$                       b  $12.4 \text{ m}$                       c  $44 \text{ cm}$                       d  $84 \text{ mm}$   
3  $x = 9$   
4 a  $43.98 \text{ cm}$                       b  $81.68 \text{ mm}$   
5 a  $153.94 \text{ cm}^2$                       b  $530.93 \text{ mm}^2$   
6 a  $47\,000 \text{ cm}^2$                       b  $41 \text{ cm}^2$   
c  $0.5 \text{ ha}$                       d  $8000 \text{ m}^2$   
7 a  $51.84 \text{ cm}^2$                       b  $0.7 \text{ m}^2$                       c  $24 \text{ cm}^2$   
d  $164 \text{ m}^2$                       e  $20.48 \text{ m}^2$                       f  $16.5 \text{ m}^2$   
g  $3 \text{ cm}^2$   
8 a  $P = 11.49 \text{ cm}$      $A = 6.98 \text{ cm}^2$   
b  $P = 21.42 \text{ cm}$      $A = 28.27 \text{ cm}^2$   
c  $P = 18.09 \text{ cm}$      $A = 16.36 \text{ cm}^2$

- 9 a  $22.87 \text{ cm}^2$                       b  $63.27 \text{ cm}^2$   
10 a  $SA = 384 \text{ cm}^2$                       b  $SA = 288 \text{ cm}^2$   
c  $SA = 142.66 \text{ cm}^2$

## 4H

## Building understanding

- 1 a 24                      b 12                      c 72  
2 a 1000                      b 1                      c 1  
d 1                      e 1                      f 1000

## Now you try

- Example 16  
 $60 \text{ m}^3$

- Example 17  
 $2.5 \text{ L}$

## Exercise 4H

- 1  $150 \text{ m}^3$   
2 a  $36 \text{ cm}^3$                       b  $20 \text{ m}^3$                       c  $27 \text{ mm}^3$   
d  $64 \text{ km}^3$                       e  $320 \text{ mm}^3$                       f  $24 \text{ m}^3$   
3 a  $2000 \text{ mL}$                       b  $5000 \text{ L}$                       c  $500 \text{ kL}$   
d  $3 \text{ L}$                       e  $4 \text{ cm}^3$                       f  $50 \text{ mL}$   
g  $2.5 \text{ L}$                       h  $5100 \text{ cm}^3$   
4 a  $24 \text{ L}$                       b  $42 \text{ L}$                       c  $27 \text{ L}$   
d  $18\,000 \text{ L}$                       e  $24\,000 \text{ L}$                       f  $360 \text{ L}$   
5 a i  $60\,000\,000 \text{ L}$   
ii  $60\,000 \text{ kL}$   
iii  $60 \text{ ML}$   
b  $200 \text{ days}$   
6  $80 \text{ minutes}$   
7 a  $500\,000 \text{ m}^3$                       b  $500 \text{ ML}$   
8  $8000 \text{ kg}$   
9 a  $(1, 1, 12)$  or  $(1, 2, 6)$  or  $(1, 3, 4)$  or  $(2, 2, 3)$   
b  $(1, 1, 30)$  or  $(1, 2, 15)$  or  $(1, 3, 10)$  or  $(1, 5, 6)$  or  $(2, 3, 5)$   
c  $(1, 1, 47)$   
10 Factors greater than 1 include only 2, 23 and 46, but 23 is prime so you cannot find 3 whole numbers that multiply to 46.  
11 a  $1\,000\,000 \text{ cm}^3$                       b Multiply by  $1\,000\,000$ .  
12 9  
13 a 20  
b 20  
c Equal, the number of cubes on the base layer is the same as the number of squares on the base.  
d If the number of cubes on the base layer is the same as the number of squares on the base, then  $Ah$  gives  $h$  layers of  $A$  cubes, giving the total.  
e Yes, a rectangular prism could use 3 different bases.  
14 a i By joining two of the same prisms together a rectangular prism could be formed.  
ii  $12 \text{ units}^3$   
b i  $160 \text{ cm}^3$                       ii  $140 \text{ m}^3$                       iii  $2 \text{ cm}^3$   
iv  $112 \text{ m}^3$                       v  $48 \text{ mm}^3$                       vi  $171 \text{ cm}^3$

4I

Building understanding

- 1 a i Prism ii Rectangle  
 b i Prism ii Triangle  
 c i Not a prism (pyramid)  
 d i Not a prism (cone)  
 e i Prism ii Square  
 f i Not a prism (truncated pyramid)
- 2 a 8, 2 b 6, 1.5 c 12, 10

Now you try

Example 18

- a 44 cm<sup>3</sup> b 36 m<sup>3</sup>

Example 19

- a 339.29 cm<sup>3</sup> b 1922.65 m<sup>3</sup>

Exercise 4I

- 1 a 12 cm<sup>3</sup> b 32 m<sup>3</sup>  
 2 a 44 m<sup>3</sup> b 160 cm<sup>3</sup> c 352 mm<sup>3</sup>  
 3 a 200 cm<sup>3</sup> b 15 m<sup>3</sup> c 980 cm<sup>3</sup>  
 d 60 m<sup>3</sup> e 270 mm<sup>3</sup> f 60 m<sup>3</sup>  
 4 a 785.40 m<sup>3</sup> b 12 566.37 mm<sup>3</sup>  
 c 251.33 cm<sup>3</sup> d 7696.90 cm<sup>3</sup>  
 e 461.81 m<sup>3</sup> f 384.85 m<sup>3</sup>  
 g 1178.10 m<sup>3</sup> h 2.41 cm<sup>3</sup>  
 i 1733.96 km<sup>3</sup>  
 5 a 14.137 m<sup>3</sup>  
 b 14 137 L  
 6 a Cylindrical b 283 L  
 7 3 (almost 4 but not quite)  
 8 302.48 cm<sup>3</sup>  
 9 a 56 000 L b 56 hours  
 10 a 20π m<sup>3</sup> b 300π cm<sup>3</sup>  
 c 144π mm<sup>3</sup> d 245π m<sup>3</sup>  
 11 Answers may vary, an example is  $r = 5$  cm and  $h = 1.27$  cm.  
 12  $x = \pi h$   
 13 a 14.28 cm<sup>3</sup> b 98.17 mm<sup>3</sup>  
 c 1119.52 cm<sup>3</sup> d 8.90 m<sup>3</sup>  
 e 800 m<sup>3</sup> f 10 036.67 cm<sup>3</sup>

4J

Building understanding

- 1 a F b D c A  
 d E e B f C  
 2 a 120 s b 3 min c 2 h  
 d 240 min e 72 h f 5 weeks  
 3 a 6 h 30 min b 4 h 30 min

Now you try

Example 20

- a 264 h b 3½ years

Example 21

- a 2230 hours b 5:20 p.m.

Example 22

- a i 10 p.m. ii 3 p.m.  
 iii 8 a.m. iv 11 p.m.  
 b i 12:30 a.m. (the next day) ii 10:30 p.m.  
 iii 11:30 a.m. iv 5:30 a.m.

Exercise 4J

- 1 a i 120 min ii 4 min  
 b i 7200 min ii 2 days  
 2 a 180min b 630 s  
 c 4 min d 1.5 h  
 e 144 h f 3 days  
 g 168 h h 1440 min  
 i 4 h j 2 weeks  
 k 20 160 min l 86 400 s  
 m 5 s n 2.5 s  
 o 7 s p 400 milliseconds  
 q 2.7 microseconds r 3 nanoseconds  
 3 a 6:30 p.m. b 9 a.m. c 6:30 p.m.  
 d 4:30 p.m. e 5:30 p.m. f 11:40 a.m.  
 4 a 1330 h b 2015 h c 1023 h  
 d 2359 h e 6:30 a.m. f 1 p.m.  
 g 2:29 p.m. h 7:38 p.m. i 11:51 p.m.  
 5 a 2 p.m. b 5 a.m.  
 c 1200 hours d 1800 hours  
 6 a 2 h 50 min b 6 h 20 min c 2 h 44 min  
 d 8 h 50 min e 8 h 19 min f 10 h 49 min  
 7 a 11 a.m. b 12 p.m. c 8 p.m.  
 d 7:30 p.m. e 7 a.m. f 5 a.m.  
 g 1 a.m. h 10 a.m.  
 8 a 5:30 a.m. b 7:30 a.m. c 6:30 a.m.  
 d 1:30 p.m. e 2:30 p.m. f 2:30 a.m.  
 g 3 p.m. h 5:30 p.m.  
 9 a 5 h b 2.5 h c 8 h  
 d 6 h e 7 h  
 10 56 million years  
 11 17 min 28 s  
 12 7 h 28 min  
 13 a London 11 p.m., New York 6 p.m.  
 b Between 11 p.m. and 6 a.m. in Hobart  
 c There are no times where all three cities are between 8 a.m. and 8 p.m., so it cannot be conducted in normal business hours for everyone.  
 14 a \$900 b \$90 c \$1.50 d 2.5c  
 15 6:30 a.m.  
 16 3 a.m. 21 April  
 17 11:30 p.m. 25 October  
 18 52.14 weeks  
 19 a 3600 b 1440 c 3600 d 1440  
 20 Friday  
 21 a You have to turn your clock back.  
 b You have to turn your clock forward.  
 c You adjust the date back one day.  
 22 Students' reports will vary.

## 4K

## Building understanding

- 1 a 9  
b 2.25  
c 20  
d 58
- 2 a False                      b True                      c False
- 3 Hypotenuse, triangle
- 4 a  $c$                       b  $x$                       c  $u$

## Now you try

Example 23

- a Not a Pythagorean triple  
b This is a Pythagorean triple.

Example 24

- a Obtuse because  $7^2 > 4^2 + 5^2$   
b Right-angled because  $10^2 = 6^2 + 8^2$

## Exercise 4K

- 1 a No                      b No                      c Yes
- 2 a Yes                      b Yes                      c No  
d Yes                      e No                      f No
- 3 a  $3^2 + 4^2 = 5^2$                       b  $8^2 + 15^2 = 17^2$   
c  $9^2 + 12^2 = 15^2$                       d  $5^2 + 12^2 = 13^2$   
e  $9^2 + 40^2 = 41^2$                       f  $2.5^2 + 6^2 = 6.5^2$
- 4 a Obtuse                      b Obtuse  
c Right-angled                      d Obtuse  
e Right-angled                      f Obtuse
- 5 a  $a^2 + b^2 = x^2$                       b  $a^2 + b^2 = d^2$   
c  $d^2 + h^2 = x^2$
- 6 a No  
b No,  $a^2 + b^2 = c^2$  must be true for a right-angled triangle.
- 7 a Answers may vary. See answer to part **b** for the list of possible answers.  
b  $\{(6, 8, 10), (9, 12, 15), (12, 16, 20), (15, 20, 25), (18, 24, 30), (21, 28, 35), (24, 32, 40), (27, 36, 45), (30, 40, 50), (33, 44, 55), (36, 48, 60), (39, 52, 65), (42, 56, 70), (45, 60, 75), (48, 64, 80), (51, 68, 85), (54, 72, 90), (57, 76, 95)\}, \{(5, 12, 13), (10, 24, 26), (15, 36, 39), (20, 48, 52), (25, 60, 65), (30, 72, 78), (35, 84, 91)\}, \{(7, 24, 25), (14, 48, 50), (21, 72, 75)\}, \{(8, 15, 17), (16, 30, 34), (24, 45, 51), (32, 60, 68), (40, 75, 85)\}, \{(9, 40, 41), (18, 80, 82)\}, \{(11, 60, 61)\}, \{(20, 21, 29), (40, 42, 58), (60, 63, 87)\}, \{(12, 35, 37), (24, 70, 74)\}, \{(28, 45, 53)\}, \{(33, 56, 65)\}, \{(16, 63, 65)\}, \{(48, 55, 73)\}, \{(13, 84, 85)\}, \{(36, 77, 85)\}, \{(39, 80, 89)\}, \{(65, 72, 97)\}$
- 8 Max. perimeter =  $7 + 10 + 12$   
= 29 units.  
Note  $7^2 + 10^2 = 149$  so  $12^2 < 149$  (acute) but  $13^2 > 149$  (obtuse), so if the longest side were 13, then the triangle would be obtuse.

- 9 Given any one Pythagorean triple, e.g. (3, 4, 5), you can multiply it by any positive number other than 1 to generate a different Pythagorean triple. Since there are infinitely many positive numbers other than 1, there must be infinitely many Pythagorean triples.

10 a  $a^2$                       b  $b^2$                       c  $\sqrt{a^2 + b^2}$

11  $2x^2 = c^2$

12 a Area of inside square =  $c^2$

Area of 4 outside triangles =  $4 \times \frac{1}{2} \times \text{base} \times \text{height} = 2ab$

Total area of outside square =  $(a + b)^2 = a^2 + 2ab + b^2$

Area of inside square = Area (outside square)

– Area of 4 triangles

=  $a^2 + 2ab + b^2 - 2ab$

=  $a^2 + b^2$

Comparing results from the first and last steps gives

$c^2 = a^2 + b^2$ .

- b Answers may vary.

## 4L

## Building understanding

- 1 a Yes  
b No  
c No  
d Yes
- 2 a 3.16                      b 5.10                      c 8.06
- 3 a  $c^2 = a^2 + b^2$                       b  $c^2 = a^2 + b^2$   
=  $5^2 + 12^2$                       =  $9^2 + 40^2$   
= 169                      = 1681  
 $\therefore c = \sqrt{169}$                        $\therefore c = \sqrt{1681}$   
= 13                      = 41

## Now you try

Example 25

a  $c = 5$

b  $c = 6.71$  (to 2 d.p.)

Example 26

The length of the brace is 6.40 m or 640 cm.

## Exercise 4L

- 1 a 13                      b 15  
2 a 5                      b 25                      c 41  
d 20                      e 45                      f 61
- 3 a 9.22                      b 5.39                      c 5.66  
d 3.16                      e 4.30                      f 37.22
- 4 3.16 m or 316 cm  
5 139 cm  
6 5.5 km  
7 3.88 cm
- 8 a 2nd line is incorrect, cannot take the square root of each term.  
b 2nd line is incorrect, cannot add  $3^2 + 4^2$  to get  $7^2$ .  
c Last line should say  $\therefore c = \sqrt{29}$ .



- 9 a 5                                      b 16                                      c 66 cm  
 10 a  $1^2 + 2^2 \neq 3^2$                       b  $5^2 + 8^2 \neq 10^2$

c  $12^2 + 21^2 \neq 24^2$

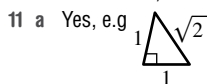

b No, because all angles must be  $60^\circ$ .

- 12 a 8.61 m                                  b 48.59 cm                                  c 18.56 cm  
 d 22.25 mm                                  e 14.93 m                                  f 12.25 m

**4M**

**Building understanding**

- 1 a 4    b 3    c 8  
 d 20    e 3    f 5  
 2 a  $15^2, 81, 144, 144, 12$                       b  $25^2, 49, 625, 576, 24$

**Now you try**

Example 27

$a = 6$

Example 28

The height of the wall is 6.32 m.

**Exercise 4M**

- 1 a 4    b 9  
 2 a 40    b 15    c 16    d 60  
 3 a 2.24    b 4.58    c 11.49  
 d 12.65    e 10.72    f 86.60  
 4 8.94 m  
 5 12 cm  
 6 12.12 cm  
 7 8.49  
 8 40 metres  
 9 a Should subtract not add 10.  
 b Should say  $a = 5$ .  
 c Can't take the square root of each term.  
 10  $x = 4$ , perimeter is 18  
 11 a  $\sqrt{13}$     b  $\sqrt{15}$     c  $\sqrt{17}$   
 12 a 3.54    b 7.07    c 43.13    d 24.04  
 13 a  $6^2 + 8^2 = 10^2$   
 b It is a multiple of (3, 4, 5).  
 c (9, 12, 15), (12, 16, 20), (15, 20, 25)  
 d (8, 15, 17)  
 e (3, 4, 5), (5, 12, 13), (8, 15, 17), (7, 24, 25), (9, 40, 41), etc.

**Problems and challenges**

- 1 10 cm each side                                  2 Yes, 1 L will overflow.  
 3  $\frac{1}{2}$     4  $\sqrt{3} \approx 1.73$  m  
 5  $\sqrt{2}$     6  $\sqrt{7}$   
 7  $72 \text{ cm}^2$     8 63.66%

**Chapter checklist with success criteria**

- |   |                                     |
|---|-------------------------------------|
| 1 52 mm; 0.85 km                                  | 2 20 cm                             |
| 3 $x = 7$   | 4 21.99 m                           |
| 5 31.4 m  | 6 2480 $\text{cm}^2$                |
| 7 $24 \text{ m}^2$ ; 45.5 $\text{m}^2$            | 8 $40 \text{ m}^2$                  |
| 9 $100 \text{ cm}^2$                              | 10 $35 \text{ mm}^2$                |
| 11 $12.57 \text{ cm}^2$                           | 12 $154 \text{ m}^2$                |
| 13 $9.82 \text{ km}^2$                            | 14 $63.27 \text{ m}^2$              |
| 15 $121 \text{ mm}^2$                             | 16 $408 \text{ cm}^2$               |
| 17 $48 \text{ m}^3$                               | 18 3 L                              |
| 19 $32 \text{ m}^3$                               | 20 $3078.76 \text{ m}^3$            |
| 21 4320 min                                       | 22 1630; 7:45 p.m.                  |
| 23 11:35 p.m.                                     | 24 6, 8, 10 is a Pythagorean triple |
| 25 $9^2 > 4^2 + 7^2$ , so the triangle is obtuse. | 26 $c = 11.40$                      |
| 27 6.71 m or 671 cm                               | 28 $a = 3$                          |

**Chapter review**

**Short-answer questions**

- |                           |                          |                         |
|---------------------------|--------------------------|-------------------------|
| 1 a 2000 mm               | b 0.5 km                 | c 300 $\text{mm}^2$     |
| d $0.4 \text{ m}^2$       | e 10 000 $\text{m}^2$    | f $3.5 \text{ cm}^2$    |
| g 0.4 L                   | h 200 L                  |                         |
| 2 a 13 m                  | b 28 cm                  | c 25.13 m               |
| d 51.42 mm                | e 48 m                   | f 20 cm                 |
| 3 a $55 \text{ cm}^2$     | b $63 \text{ m}^2$       | c $12 \text{ cm}^2$     |
| d $136 \text{ cm}^2$      | e $64 \text{ m}^2$       | f $20 \text{ cm}^2$     |
| g $28.27 \text{ cm}^2$    | h $12.57 \text{ m}^2$    | i $3.84 \text{ cm}^2$   |
| 4 a $70 \text{ cm}^2$     | b $50.14 \text{ cm}^2$   | c $74 \text{ cm}^2$     |
| 5 a $320 \text{ m}^2$     | b $408 \text{ mm}^2$     | c $138 \text{ cm}^2$    |
| 6 a 1000 L                | b 8 L                    | c 0.144 L               |
| 7 a $2513.27 \text{ m}^3$ | b $3078.76 \text{ cm}^3$ | c $212.06 \text{ mm}^3$ |
| 8 a i $287^\circ\text{C}$ | ii $239^\circ\text{C}$   |                         |
| b 1 h 39 min 18 s         |                          |                         |
| c 1 h 2 min 4 s           |                          |                         |
| 9 a 10 h 17 min           | b 9:45 p.m.              | c 2331 hours            |
| 10 a 6:30 p.m.            | b 6 p.m.                 | c 8:30 a.m.             |
| d 4:30 p.m.               | e 10:30 a.m.             | f 5:30 p.m.             |
| g 8:30 p.m.               | h 8:30 p.m.              |                         |
| 11 a 10                   | b 25                     | c 4.24                  |
| 12 a 15                   | b 6.24                   | c 11.36                 |

**Multiple-choice questions**

- |     |     |     |     |      |
|-----|-----|-----|-----|------|
| 1 E | 2 B | 3 A | 4 C | 5 B  |
| 6 E | 7 E | 8 B | 9 D | 10 D |

**Extended-response questions**

- |                          |                          |
|--------------------------|--------------------------|
| 1 a $12.86 \text{ cm}^2$ | b $57.72 \text{ cm}^2$   |
| c $57.72 \text{ m}^2$    | d $628 \text{ cm}^3$     |
| e $25.72 \text{ cm}^3$   | f 38 with some remainder |
| 2 a 2.8 m                | b $24 \text{ m}^2$       |
| c 23 m                   | d No, 4000 L short       |

## Chapter 5

## 5A

## Building understanding

- 1 a  $3a, 2b, 5c$   
 b i 3 ii 2 iii 5  
 c  $2x + 5y + 8z$  (Answers may vary.)
- 2 a 6  
 b i 5 ii 7 iii 1  
 c  $x + 2y + 3z + 4w + 91k$  (Answers may vary.)
- 3 a F b C c E  
 d D e A f B

## Now you try

Example 1

- a  $3x, y, 4, 12z$   
 b The coefficient of  $x$  is 3, the coefficient of  $y$  is 1, the coefficient of  $z$  is  $-12$  and the coefficient of  $w$  is 0.  
 c 4 d 6

Example 2

- a  $q + 7$  b  $3k$   
 c  $\frac{1}{4}p - 3$  or  $\frac{p}{4} - 3$  d  $(a + 2b) \times 3$  or  $3(a + 2b)$

## Exercise 5A

- 1 a  $3a, 2b, 5c, 2$  b 3, 2 and 5  
 2 a  $7a, 4b, 2c, 7$  b  $7, -4, -2, 0$   
 c  $-7$  d  $-3$   
 3 a i 3 ii  $7a, 2b, c$   
 b i 3 ii  $19y, 52x, 32$   
 c i 2 ii  $a, 2b$   
 d i 4 ii  $7u, 3v, 2a, 123c$   
 e i 2 ii  $10f, 2be$   
 f i 5 ii  $9, 2b, 4c, d, e$   
 g i 4 ii  $5, x^2y, 4abc, 2nk$   
 h i 4 ii  $ab, 2bc, 3cd, 4de$
- 4 a 2 b 1 c 9 d  $-2$   
 e 1 f 0 g 0 h  $-6$   
 i  $-1$  j  $-12$  k  $-1$  l  $-3$
- 5 a  $y + 7$  b  $x - 3$  c  $a + b$   
 d  $4p$  e  $4 - \frac{q}{2}$  f  $10 + \frac{r}{3}$   
 g  $2(b + c)$  h  $b + 2c$  i  $\frac{abc}{7}$   
 j  $\frac{a}{4} + \frac{b}{2}$  k  $\frac{x}{2y}$  l  $a - \frac{b}{2}$   
 m  $k^2$  n  $w^2$
- 6 a The sum of 3 and  $x$   
 b The sum of  $a$  and  $b$   
 c The product of 4,  $b$  and  $c$   
 d Double  $a$  is added to  $b$   
 e  $b$  is subtracted from 4 and the result is doubled.  
 f  $b$  is doubled and the result is subtracted from 4.
- 7 a  $7x$   
 b i  $x - 3$  ii  $7(x - 3)$
- 8 a  $2p$  b  $48p$   
 c  $30p + 18(p + 20)$

- 9 a  $4a$  b  $\frac{7b}{2}$   
 c  $5a + 5b$  d  $\frac{7a + 7b}{2}$   
 10  $70 + 90x$   
 11 a  $20 + 50t$  b  $0.2 + \frac{t}{2}$  c  $0.2 + 30t$   
 12 a True b True c False  
 d True e False f False  
 13 a True b True c False d True  
 14 In  $2a + 5$ , the number is doubled then 5 is added. In  $2(a + 5)$ , the number is increased by 5 and this result is doubled.  
 15 a 36 b 676 c  $t$   
 d  $121k$  e  $67\ 108\ 863$

## 5B

## Building understanding

- 1 15  
 2 8  
 3 30  
 4 a 14 b 30 c No

## Now you try

Example 3

- a 24 b 14

Example 4

- a Yes, addition is commutative (order is unimportant).  
 b No, e.g. if  $a = 1$  and  $b = 0$  they do not have the same value.

## Exercise 5B

- 1 a 5 b 1 c 8 d 5  
 2 a 30 b 37 c 16 d 58  
 3 a  $-2$  b  $-6$  c  $-6$  d 12  
 4 a 14 b 15 c 7  
 d 11 e 16 f 1  
 5 a 1 b  $-7$  c 100  
 d 13 e 45 f 16  
 6 a E b E c N  
 d E e N f N  
 g E h E i E  
 7 a  $3 + x$  b  $2 - a$  c  $4t - 2t$  d  $3u - 8$   
 8 a 96 b 122 c 24  
 d  $-38$  e 132 f 54  
 9  $4y + 2x + 5, 5 + 2x + 4y, 2(x + 2y) + 5$  (Answers may vary.)  
 10 The value of  $x$  must be greater than 5.

11

$x$	3	1	0.25	6	$-2$	2
$4x + 2$	14	6	3	26	$-6$	10
$4 - 3x$	$-5$	1	3.25	$-14$	10	$-2$
$2x - 4$	2	$-2$	$-3.5$	8	$-8$	0

- 12 a  $(a, b): (1, 10), (2, 5), (5, 2), (10, 1), (-1, -10), (-2, -5), (-5, -2), (-10, -1)$   
 b Answers may vary, e.g.  $a = -42, b = 52$   
 c  $a = 0, b = 0$  or  $a = 2, b = 2$   
 13 a Yes, only when  $y = 0$ .  
 b No, need to be equal for all values of  $x$  and  $y$ .

- 14 a  $24 \div (2 \times 3) = 4$  but  $(24 \div 2) \times 3 = 36$  (Answers may vary.)  
 b No, as there is a division rather than two multiplications  
 c No. For example,  $24 \div (6 \div 2) = 8$  but  $(24 \div 6) \div 2 = 4$ .
- 15 a  $5 - a$  and  $a - 5$  (Answers may vary.)  
 b  $17(a - b)$  and  $38(b - a)$  (Answers may vary.)  
 c  $x$  and  $x + 1$
- 16 a They are equivalent.  
 b No. For example,  $(2 + 3)^2 = 25$  but  $2^2 + 3^2 = 13$ .  
 c Yes  
 d No. For example,  $\sqrt{9 + 16} = 5$  but  $\sqrt{9} + \sqrt{16} = 7$   
 e For part **b**, if  $a = 0$  or  $b = 0$  they are equal. For part **d**, if  $a = 0$  or  $b = 0$  they are equal.
- 17 a Multiplication is commutative (order unimportant).  
 b Adding a number to itself is double the number.  
 c A number subtracted from itself always results in zero.  
 d Dividing by 2 and multiplying by  $\frac{1}{2}$  have the same effect.

18

<b>a</b>	5	8	2	3	-20	10	-9	-6
<b>b</b>	2	2	1	7	10	-3	10	-13
<b>a + b</b>	7	10	3	10	-10	7	1	-19
<b>a + 2b</b>	9	12	4	17	0	4	11	-32
<b>a - b</b>	3	6	1	-4	-30	13	-19	7
<b>a - 2b</b>	1	4	0	-11	-40	16	-29	20

### 5C

#### Building understanding

- 1 a 21                                  b 21                                  c True  
 2 a 23                                  b 84                                  c False  
 3 a 28  
    b i 12                                  ii 20                                  iii 28  
    c  $7x$

#### Now you try

Example 5

- a L                                  b N                                  c N

Example 6

- a  $7x$                                   b  $13a + 5b$                                   c  $4pq + 6p + 5q$

#### Exercise 5C

- 1 a N                                  b L                                  c N                                  d L  
 2 a L                                  b L                                  c L                                  d N  
    e N                                  f L                                  g N                                  h N  
 3 a L                                  b L                                  c N  
    d L                                  e N                                  f N  
 4 a  $5x$                                   b  $19a$                                   c  $9x$   
    d  $7xy$                                   e  $13uv$                                   f  $14ab$   
    g  $7ab$                                   h  $16k$                                   i  $10k$   
 5 a  $9f + 12$                                   b  $13x + 8y$   
    c  $7a + 11b$                                   d  $13a + 9b$   
    e  $12 + 12x$                                   f  $8a + 3b + 3$   
    g  $14x + 30y$                                   h  $21a + 4$

- i  $17x^2y + 5x$                                   j  $13xy$   
 k  $-x^2$                                   l  $2a + 4b - 7ab$   
 m  $10 + 9q - 4r$                                   n  $9b + 2b^2$
- 6 a C                                  b A                                  c D  
    d E                                  e B
- 7 a  $22x$                                   b  $6y + 6 + 2x$   
 8 a \$13c                                  b \$9nc  
 9 a 7, 2                                  b 6, 7                                  c 7, 9, 5                                  d 8, 6  
 10 From left to right, top to bottom:  $2x, 2y, 3y, 5x + y, 2x + 2y$   
 11 9 ways  
 12  $-50a$   
 13 Both are equivalent to  $17x + 7y$ .  
 14 a If  $a = 1, b = 2: 4a + 3b = 10, 7ab = 14$  (Answers may vary.)  
    b Yes. For example, if  $a = 0$  and  $b = 0$ .  
    c No. They are equivalent.  
 15 a Yes, both are equivalent to  $4x$ .  
    b  $-13, -3, -2$   
 16 a From top left to bottom right:  
     $a + 3, -a, 2b + 4, 2a, a + 1, 7a + 2b, 0$   
    b Answers may vary.

### 5D

#### Building understanding

- 1 B  
 2 a  $\frac{3}{5}$                                   b  $\frac{1}{3}$                                   c  $\frac{3}{2}$                                   d  $\frac{3}{5}$   
 3 B  
 4 a  $3xy$                                   b  $5abc$                                   c  $12ab^2$                                   d  $4ac^3$

#### Now you try

Example 7

- a  $24pqrs$                                   b  $12ab^2c$                                   c  $\frac{3p}{4r}$                                   d  $\frac{5ab}{6}$

#### Exercise 5D

- 1 a  $12a$                                   b  $10b$                                   c  $24c$                                   d  $30d$   
 2 a  $63d$                                   b  $10ab$                                   c  $36x$   
    d  $8abcd$                                   e  $60abcd$                                   f  $48abde$   
 3 a  $24abc$                                   b  $a^2$                                   c  $3d^2$   
    d  $10d^2e$                                   e  $14x^2y$                                   f  $10x^2y$   
    g  $8x^2yz$                                   h  $8a^2b^2cd$                                   i  $48x^3y$   
    j  $18a^3b$                                   k  $24x^3y^2$                                   l  $6xz^2$   
    m  $-10xy^2z$                                   n  $70a^2b^3$                                   o  $16xy^3$   
 4 a  $\frac{1}{2}$                                   b  $\frac{x}{2y}$                                   c  $\frac{5x}{6}$                                   d  $\frac{a}{4}$   
    e  $\frac{x}{3}$                                   f  $\frac{1}{6x}$                                   g  $-\frac{x}{2yz^2}$                                   h  $-\frac{2y}{3}$   
    i  $-\frac{a}{2b}$                                   j  $-\frac{7p}{q}$                                   k 7                                  l  $\frac{3}{4z}$   
 5 a  $4a, 5b$ , other answers possible.  
    b  $3b, 5ac$ , other answers possible.  
 6 a  $8b$                                   b  $24x$                                   c  $18xy$   
 7 a  $2y$                                   b  $3b^2$                                   c  $-2$   
    d  $28rs$                                   e  $8ab^2$                                   f  $-7x$

- 8 a  $17xy$       b  $13a^2$       c  $88xy$   
 9  $18x^3$   
 10 a  $x^2$   
     b  $4x$   
     c  $\frac{x^2}{4x} = \frac{x}{4}$  = one quarter of width  
 11  $5a \times 4b \times 5c = 100abc$ , which will always be a multiple of 100 if  $a, b, c$  are whole numbers.  
 12 a No      b  $\frac{2a}{5}$  and  $\frac{2}{5} \times a$   
     c  $a = 1, a = -1$   
 13 a  $3x^5$       b  $-3b^2c^3$   
     c Simplify  $\frac{(\text{term } 2)}{(\text{term } 1)}$   
 14 a  $bc$       b  $\frac{8a^2}{3}$       c  $\frac{x}{6}$   
     d  $16a$       e  $\frac{1}{2}$       f  $\frac{-2x}{y}$

## 5E

## Building understanding

- 1 a 7      b 4, 9  
     c algebraic      d 7  
 2 a 15      b 20      c 42      d 6  
 3 a 4      b 12      c 4      d 30  
 4 a  $\frac{7}{12}$       b  $\frac{17}{35}$       c  $\frac{3}{10}$       d  $\frac{3}{20}$

## Now you try

Example 8

- a 24      b  $\frac{12x}{20}$

Example 9

- a  $\frac{6x}{7}$       b  $\frac{29a}{21}$   
 c  $\frac{7k}{8}$       d  $\frac{3a - 2b}{12}$

## Exercise 5E

- 1 12  
 2 a 15      b 20      c 20      d 12  
 3 a  $2x$       b  $6a$       c  $16z$       d  $15k$   
 4 a  $\frac{3x}{4}$       b  $\frac{7a}{3}$       c  $\frac{3b}{5}$       d  $\frac{5k}{3}$   
     e  $\frac{5a}{6}$       f  $\frac{9a}{20}$       g  $\frac{7p}{10}$       h  $\frac{3q}{4}$   
     i  $\frac{29k}{35}$       j  $\frac{16m}{15}$       k  $\frac{47p}{30}$       l  $\frac{5x}{8}$   
 5 a  $\frac{2y}{5}$       b  $\frac{5p}{13}$       c  $\frac{8r}{7}$       d  $\frac{6q}{5}$   
     e  $\frac{p}{6}$       f  $\frac{t}{15}$       g  $\frac{7u}{22}$       h  $\frac{11y}{6}$   
     i  $-\frac{r}{6}$       j  $-\frac{13u}{42}$       k  $\frac{33u}{4}$       l  $-\frac{29p}{132}$   
 6 a  $\frac{13x}{3}$       b  $\frac{7x}{2}$       c  $\frac{11a}{5}$   
     d  $\frac{2p}{3}$       e  $\frac{100u + 9v}{30}$       f  $\frac{7y - 4x}{10}$   
     g  $\frac{4t + 7p}{2}$       h  $\frac{x - 3y}{3}$       i  $\frac{35 - 2x}{7}$   
 7 a  $\frac{x}{3}$       b  $\frac{x}{4}$       c  $\frac{7x}{12}$

- 8 a  $\frac{T}{4} + \frac{B}{2}$       b  $\frac{T + 2B}{4}$   
     c 251 litres  
 9  $\frac{A - 40}{2}$   
 10 a For example, if  $x = 12$ ,  $\frac{x}{2} + \frac{x}{3} = 10$  and  $\frac{5x}{6} = 10$ .  
     b For example, if  $x = 1$ ,  $\frac{1}{4} + \frac{1}{5} \neq \frac{2}{9}$ .  
     c No. If  $x = 1$  they are different.  
 11 a i  $\frac{x}{6}$       ii  $\frac{x}{12}$   
     iii  $\frac{x}{20}$       iv  $\frac{x}{30}$   
     b Denominator is product of initial denominators, numerator is always  $x$ .  
     c  $\frac{x}{10} - \frac{x}{11}$   
 12 a  $\frac{2z}{3}$       b  $\frac{7x}{10}$   
     c  $\frac{29u}{8}$       d  $\frac{29k}{12}$   
     e  $\frac{3p - 12}{4}$       f  $\frac{47u}{60}$   
     g  $\frac{24 + j}{12}$       h  $\frac{16t + 2r}{15}$

## 5F

## Building understanding

- 1 a 8      b 3  
     c 55      d 32  
 2 C  
 3 a  $\frac{7}{15}$       b  $\frac{3}{22}$   
     c  $\frac{5}{6}$       d  $\frac{12}{17}$

## Now you try

Example 10

- a  $\frac{10cd}{77}$       b  $\frac{6ab}{7}$

Example 11

- a  $\frac{14p}{15q}$       b  $\frac{2x}{7y}$

## Exercise 5F

- 1 a  $\frac{15ab}{28}$       b  $\frac{10xy}{21}$       c  $\frac{22ab}{35}$   
 2 a  $\frac{2x}{15}$       b  $\frac{a}{63}$       c  $\frac{8a}{15}$   
     d  $\frac{4c}{25}$       e  $\frac{8ab}{15}$       f  $\frac{21a^2}{10}$   
 3 a  $\frac{7xy}{5}$       b  $\frac{7bd}{15}$       c  $\frac{6ab}{5c}$   
     d  $\frac{18de}{7}$       e  $\frac{1}{4}$       f  $\frac{2}{3}$   
 4 a  $\frac{15a}{4}$       b  $\frac{14x}{15}$       c  $\frac{18a}{5}$       d  $\frac{7}{6x}$   
     e  $\frac{6}{5y}$       f  $\frac{x}{14}$       g  $\frac{10a}{7}$       h  $\frac{10b}{7c}$   
     i  $\frac{3x}{10y}$       j  $\frac{2y^2}{3x}$       k  $\frac{5}{42x^2}$       l  $\frac{14a^2}{5b}$

- 5 a  $\frac{12x}{5}$       b  $\frac{4x}{15}$       c  $\frac{10}{x}$   
 d  $\frac{4a}{3}$       e  $\frac{7}{2x}$       f  $\frac{2}{x}$
- 6 a  $\$ \frac{x}{2}$       b  $\$ \frac{x}{6}$
- 7 a  $xy \text{ m}^2$   
 b i  $\frac{x}{2} \text{ m}$   
 ii  $\frac{3y}{4} \text{ m}$   
 iii  $\frac{3xy}{8} \text{ m}^2$
- c  $\frac{3}{8}$
- 8 a  $\frac{3q}{2}$       b  $\frac{x}{2}$       c 1      d  $\frac{3x}{8}$
- 9 a 1  
 b  $x^2$   
 c Both are  $\frac{x}{3}$ .
- d  $\frac{a}{bc}$
- e  $\frac{ac}{b}$
- 10 a i  $\frac{11x}{30}$       ii  $\frac{x}{30}$       iii  $\frac{x^2}{30}$       iv  $\frac{6}{5}$
- b  $\frac{x}{5} \div \frac{x}{6}$
- 11 a  $1 \div \frac{a}{b} = \frac{1}{1} \times \frac{b}{a} = \text{reciprocal of } \frac{a}{b}$   
 b  $\frac{a}{b}$
- 12 a  $x^2$       b  $\frac{x^2}{4}$   
 c  $\frac{9x^2}{25}$ . Proportion is  $\frac{9}{25} < \frac{1}{2}$ .  
 d  $\frac{49x^2}{100}$  or  $0.49x^2$   
 e 0.707 (Exact answer is  $\frac{1}{\sqrt{2}}$ .)

**Progress quiz**

- 1 a 5      b 3a, 9b, ab, c, 8  
 c 3, -9, 1, 0      d 8  
 e -1
- 2 a  $5 + m$       b  $8k$       c  $p - 7$   
 d  $h + 12$       e  $2 \times (x + y)$       f  $\frac{a}{b}$   
 g  $\frac{k}{2} - \frac{m}{3}$       h  $\frac{ac}{5}$
- 3 a 6      b -27      c 54      d 4
- 4 a E      b N      c N      d E
- 5 a L      b L      c N      d L
- 6 a  $7h + 3$       b  $5a + 8$   
 c  $5xy + 3x$       d  $-gk - 5g^2k + 12$
- 7 a  $6ab$       b  $10d^2$       c  $30a^2bc^2d^2$   
 d  $12p^2q^2$       e  $\frac{1}{4}$       f  $\frac{2x}{5}$   
 g  $\frac{1}{3a}$       h  $-\frac{2m}{3t}$
- 8 a  $\frac{7m}{9}$       b  $\frac{13k}{6}$   
 c  $\frac{20a - 9b}{24}$       d  $\frac{13x}{3}$
- 9 a  $\frac{6ab}{35}$       b  $\frac{8m}{15}$   
 c  $\frac{4y}{3}$       d  $\frac{3}{2p}$

**5G**

**Building understanding**

- 1 a 10      b 5x      c  $10 + 5x$       d  $10 + 5x$   
 2  $6 + 21x$   
 3 D  
 4 a 10      b 12      c 10

**Now you try**

- Example 12  
 a  $15x + 20$       b  $28a - 7ab$       c  $-16 - 10b$
- Example 13  
 a  $14x + 8$       b  $2ab + 30a$

**Exercise 5G**

- 1 a  $15x + 10$       b  $14x + 7$   
 c  $18x + 30$       d  $40x + 30$
- 2 a  $6a + 15$       b  $15r + 20$   
 c  $16m + 32$       d  $3v + 18$   
 e  $12 - 8j$       f  $12k - 30$   
 g  $12m - 4$       h  $16 - 2c$
- 3 a  $-45 - 5g$       b  $-35b - 28$   
 c  $-9u + 81$       d  $-40 + 8h$   
 e  $8zk - 8zh$       f  $-6jk - 6ja$   
 g  $8ur - 4uq$       h  $20mw - 12ma$
- 4 a  $65f + 70$       b  $44x + 16$       c  $15a + 32$   
 d  $24v + 60$       e  $76a + 70$       f  $20q - 30$   
 g  $32m - 30$       h  $22m + 32$
- 5 a  $55d + 37$       b  $115f + 54$       c  $32j + 30$   
 d  $75d + 32$       e  $4j + 40$       f  $68g + 52$
- 6 a  $6x + 4y + 8z$       b  $14a - 21ab + 28ay$   
 c  $8qz + 4aq + 10q$       d  $-6 - 12k - 6p$   
 e  $-5 - 25q + 10r$       f  $-7kr - 7km - 7ks$
- 7 a  $3(t + 4) = 3t + 12$       b  $2(u - 3) = 2u - 6$   
 c  $3(2v + 5) = 6v + 15$       d  $2(3w - 2) = 6w - 4$
- 8 a D      b A      c B  
 d E      e C
- 9 a  $5s + 3t$       b  $2(5s + 3t) = 10s + 6t$   
 c  $14s + 10t$       d  $\$320$
- 10 a  $2(4a + 12b)$ ,  $8(a + 3b)$  (Answers may vary.)  
 b  $2(2x + 4y)$  (Answers may vary.)  
 c  $4(3a - 2b)$  (Answers may vary.)  
 d  $3a(6b + 4c)$  (Answers may vary.)
- 11 Both simplify to  $8a + 6ab$ .
- 12 a  $3a + 3b + ac + bc$   
 b  $15a + 20b + 18ac + 24bc$   
 c  $x^2 + 7x + 12$
- 13 a 1836  
 b 1836  
 c i 154      ii 352      iii 627      iv 869  
 d i 35      ii 399  
 iii 143      iv 39 999  
 e  $(D5)^2 = ?25$  where ? is  $D \times (D + 1)$
- 14  $\frac{1}{3}(6(x + 2) - 6) - 2$  simplifies to  $2x$ .

15 a  $\frac{5x+2}{6}$   
 c  $\frac{5x-2}{8}$   
 e  $\frac{7x+3}{10}$

b  $\frac{8x+15}{15}$   
 d  $\frac{7x+10}{12}$   
 f  $\frac{31x+9}{35}$

## 5H

## Building understanding

- 1 a 1, 2, 4, 5, 10, 20  
 c 1, 3, 5, 15  
 2 2  
 3 a 6  
 4 a 12
- b 5  
 b 12, 30
- c 20  
 c 7
- d 2  
 d 2,  $q$

## Now you try

Example 14

a 12  
 b  $5x$   
 c  $6a$

Example 15

a  $6(2x+5)$   
 b  $5a(3+5b)$   
 c  $3(6x-5y)$

## Exercise 5H

- 1 a 4  
 2 a 5  
 d  $7x$   
 g  $4r$   
 3 a  $3(x+2)$   
 d  $5(2z+5)$   
 g  $3(3b-5)$   
 4 a  $2n(5c+6)$   
 c  $2n(7j+5)$   
 e  $2(5h+2z)$   
 g  $8y(5+7a)$   
 i  $3m(7h-3x)$   
 k  $14u(2-3b)$   
 5 For example: length = 2, width =  $6x+8$  (Answers may vary.)  
 6 a 5  
 7 a  $6x+18$   
 d  $2x+6$   
 8 a  $7x+7$   
 c Student prediction  
 9  $(x+2)(y+3)$   
 10 a i I eat fruit and I eat vegetables.  
 ii Rohan likes Maths and Rohan likes English.  
 iii Petra has a computer and Petra has a television.  
 iv Hayden plays tennis and Hayden plays chess and Anthony plays tennis and Anthony plays chess.  
 b i I like sewing and cooking.  
 ii Olivia and Mary like ice-cream.  
 iii Brodrick eats chocolate and fruit.  
 iv Adrien and Ben like chocolate and soft drinks.
- 11 a  $\frac{2}{5}$   
 d  $\frac{2a+b}{4c+5d}$   
 g  $\frac{7}{2}$
- b  $\frac{7}{2}$   
 e  $\frac{5}{3}$   
 h  $\frac{6}{4+q}$
- c  $\frac{3c+5}{1+2b}$   
 f  $\frac{7}{9}$   
 i 5

## 5I

## Building understanding

- 1 a 35  
 2 a 50  
 3 a  $2x+y$
- b 41  
 b 20
- c 5  
 c 0  
 b 8

## Now you try

Example 16

- a  $12n$   
 c  $80n+35$
- b  $4x+6$  or  $2(2x+3)$

## Exercise 5I

- 1 a \$15  
 2 a  $3n$   
 3 a  $3(x+2)$  or  $3x+6$   
 4 C  
 5 a  $5x$   
 c  $5(x+3)$  or  $5x+15$   
 6 a  $30+40x$   
 7 a \$50  
 c 2 hours 30 minutes  
 8 a \$140  
 c i \$60  
 9 a  $10+4n$   
 d Deal 1  
 f i 3  
 10 a i  $2(x+2)$   
 b All expand to  $2x+4$ .  
 c Divide by 2.  
 11 a 6  
 c Both dimensions are negative, so the shape cannot exist.  
 12 a  $F+H$   
 b  $F+2H$   
 c  $F+\frac{H}{2}$   
 d  $F+tH$   
 13 3 buy deal F, 2 buy E, 1 buys D, 3 buy C, 5 buy B and 86 buy A.
- b \$50  
 c  $5k$   
 b \$36  
 b 33 units<sup>2</sup>  
 b  $10x$   
 b \$350  
 b \$60  
 b  $60+80x$   
 ii \$80  
 b  $20+n$   
 e Deal 3  
 ii 4, 10  
 iii 10  
 ii  $2x+4$   
 iii  $4\left(\frac{x}{2}+1\right)$

## 5J

## Building understanding

- 1 5, 7  
 2 B  
 3 a i 4  
 b  $2^5$   
 4 a  $5 \times 5 \times 5$   
 b  $5 \times 5 \times 5 \times 5$   
 c  $5 \times 5 \times 5 \times 5 \times 5 \times 5$   
 d C
- ii 8  
 iii 32  
 iv 64

Now you try

Example 17

a  $3^{11}$       b  $a^6$       c  $b^7$       d  $12x^7y^{16}$

Example 18

a  $5^4$       b  $x^9$       c  $\frac{3a^3}{2}$       d  $a^6b^5$

Exercise 5J

- 1 a  $4^5$       b  $5^4$       c  $3^7$       d  $10^8$   
 2 a  $4^8$       b  $3^{12}$       c  $2^{18}$       d  $7^6$   
 3 a  $m^7$       b  $x^6$       c  $q^{13}$       d  $r^9$   
    e  $m^9$       f  $a^9$       g  $r^9$       h  $z^{36}$   
    i  $k^4$       j  $j^3$       k  $m^8$       l  $x^4$   
 4 a  $20m^5$       b  $10k^7$       c  $28x^{14}$       d  $28y^{13}$   
    e  $m^6n^{10}$       f  $x^2y^3$       g  $3r^3s^7$       h  $2y^{15}z^5$   
    i  $110x^4$       j  $15a^6$       k  $8x^5y^7$       l  $14a^5b^4$   
    m  $-14x^7y^4$       n  $-4a^5b^3$       o  $-16c^6d$       p  $84x^4y^5$   
 5 a  $3^5$       b  $10^8$       c  $2^5$       d  $5^2$   
 6 a  $m^3$       b  $z^3$       c  $q^7$       d  $r^9$   
    e  $m^2n^5$       f  $a^5b^3$       g  $xy^6z^2$       h  $x^2y^3z^3$   
    i  $4k^3$       j  $2m^{13}$       k  $\frac{5x^{18}y^7}{3}$       l  $\frac{a^2}{2}$
- 7  $2^4 = 16$  is the missing number, since  $2^8 \times 2^4 = 2^{12}$ .  
 8 a  $2^3 = 8$       b  $5^4 = 625$       c 1  
 9  $a = 2, b = 4$  is the only solution.  
 10 a They are not equal.  
    b  $(3 \times 3) \times (3 \times 3 \times 3 \times 3) \neq 9^6$   
    c The student mistakenly multiplied the bases.
- 11 a i 4      ii -8      iii 16      iv -32  
    b i Positive      ii Negative  
    c 1024
- 12 a  $5^0$       b 1      c 1      d 1  
 13 a  $a - b = 2$       b 125  
 14 a i  $5 \times 10^4$       ii  $7 \times 10^9$       iii  $5 \times 10^{-3}$   
    iv  $2 \times 10^{-7}$   
    b i 2 000 000 hours  
    ii 40 000 000 days  
    iii 0.003 seconds  
    iv 0.000 000 003 seconds  
    c i 34.75 days      ii 250 hours  
    iii 0.72 seconds      iv 4.32 milliseconds

5K

Building understanding

- 1 A      2 B      3 C

Now you try

Example 19

a 3      b 2      c  $30c$

Example 20

a  $3^{12}$       b  $2^3a^{15}$       c  $4^2a^{22}$

Exercise 5K

- 1 a 1      b 2      c 0      d 3  
 2 a 1      b 1      c 5      d  $12y^2$   
    e 1      f 13      g  $2y^2$       h 4  
    i  $3a^2$   
 3 a  $2^{12}$       b  $5^{16}$       c  $6^{36}$       d  $d^9$   
    e  $k^{24}$       f  $m^{50}$   
 4 a  $9x^{10}$       b  $8u^{12}$       c  $5^4x^{20}$       d  $12^3x^{15}$   
    e  $16x^8$       f  $49x^4$       g  $9^{10}x^{70}$       h  $10^5x^{10}$   
 5 a  $x^{21}$       b  $y^{18}$       c  $500k^{23}$       d  $25m^{22}$   
    e  $8x^{18}$       f  $5^4p^{18}$       g  $y^{10}$       h  $p^8$   
    i  $2p^{13}$       j  $3^{10}x^{14}$       k  $8h^5$       l  $q^2$   
 6 a 5      b 3      c 5      d 2  
 7 a  $x^{24}$   
    b  $x^{60}$   
    c  $((2^3)^4)^5, (2^7)^{10}, 2^{100}, ((2^5)^6)^7$   
 8 a i 2      ii 5      iii 6  
    b 54  
 9 a  $x^7$   
    b  $x^{12}$   
    c For example, if  $x = 2$  they give different values (128 vs. 4096).  
    d  $x = 0, x = 1$
- 10 a 1  
    b  $5^2 - 2 = 5^0$   
    c  $3^0 = 3^2 - 2 = \frac{3^2}{3^2} = \frac{9}{9} = 1$   
    d  $100^0 = 100^2 - 2 = \frac{100^2}{100^2} = \frac{10\ 000}{10\ 000} = 1$   
    e  $\frac{0^2}{0^2}$  cannot be calculated (dividing by zero).
- 11 a Both equal  $2^{12}$ .  
    b A  $(2^4)^3, B (2^2)^6, C (4^2)^3$   
    c 3, 5 (Answers may vary.)
- 12 a 9      b 3      c 3      d 6  
 13 a 1  
    b Answers may vary.  
 14 a  $5^4$       b  $x^8$       c  $x^4y^9$   
    d  $a^7b^{12}c^{10}$       e  $x^{80}y^{10}$       f  $7^2 = 49$   
    g 1      h 25      i  $10^4 = 10\ 000$

Problems and challenges

- 1  $10m + 10 = 10(m + 1)$   
 2 Any list with  $6 - 2a$  central;  $2 - a, 6a - 5$  together;  $a - 7, 4(a + 1)$  together. e.g.  $2 - a, 6a - 5, 6 - 2a, a - 7, 4(a + 1)$   
 3  $4^{1999}, 16^{1000}, 2^{4001}, 8^{1334}$   
 4 a  $\frac{65}{4}$       b  $\frac{225}{4}$       c 0  
 5 a  $\frac{5 - 4a}{30}$       b  $\frac{9x + 4}{42}$   
 6 a 8      b 45      c 4  
 7 a All perimeters =  $4a$   
    Areas:  $a^2, \frac{3}{4}a^2, \frac{6}{9}a^2, \frac{10}{16}a^2, \frac{15}{25}a^2$   
    b  $P = 24, A = \frac{9009}{500}$  or approximately 18.  
 8  $V = 2^3 \times 3^3 \text{ cm}^3, TSA = 2^{2x+1} 3^{2y+1} \text{ cm}^2$

- 9 a  $x = 3$   
 b  $a = 4$   
 c  $b = 3, c = 2$   
 d  $x = \frac{1}{2}$   
 e  $k = \frac{5}{3}$

### Chapter checklist with success criteria

- 1 The coefficient of  $a$  is 4; the coefficient of  $b$  is 1; the coefficient of  $c$  is  $-12$ ; the coefficient of  $d$  is 0.  
 2  $2(a + b)$   
 3 60  
 4 No, they are not equivalent  
 5 No, they are not like terms  
 6  $3ac + 2b$   
 7  $42abcd$ ;  $15x^2yz$   
 8  $\frac{2a}{3c}, \frac{9xy}{4z}$   
 9  $\frac{6x}{21}$   
 10  $\frac{26a}{15}, \frac{3a - 2b}{18}$   
 11  $\frac{2xy}{5}, \frac{u}{30p}$   
 12  $6x + 15$ ;  $8x - 4xy$   
 13  $5xy + 14x$   
 14  $6a$   
 15  $6a(2 + 3b)$   
 16  $40 + 70n$   
 17  $a^9$   
 18  $\frac{5x^4}{2}$   
 19  $32x$   
 20  $49u^{14}$

### Chapter review

#### Short-answer questions

- 1 a False  
 b True  
 c True  
 d False  
 e True  
 2 a 2  
 b 3  
 c 4  
 d 6  
 3 a 11  
 b 14  
 c 29  
 d 8  
 4 a  $-3$   
 b 3  
 c  $-9$   
 d 14  
 e  $-3$   
 f 12

- 5 3  
 6 a  $16m$                       b  $2a + 5b$                       c  $2x^2 - x + 1$   
           d  $7x + 7y$                       e  $9x + x^2$                       f  $-m - 12n$   
 7 a  $36ab$                       b  $15xy$                       c  $16xy$   
 8 a  $5x$                       b  $-4c$                       c  $15x$                       d  $3ab$   
 9 a  $\frac{x}{4}$   
           b  $\frac{6a + b}{15}$   
           c  $\frac{9}{x}$   
           d  $\frac{3b}{2}$   
 10 a  $3x - 12$                       b  $-10 - 2x$   
           c  $3kl - 4km$                       d  $7x - 6y$   
           e  $13 - 3x$                       f  $10 - 20x$   
           g  $18x + 2$   
 11 a  $2(x + 3)$                       b  $8(3 - 2g)$   
           c  $3x(4 + y)$                       d  $7a(a + 2b)$   
 12 a 7                      b 3                      c 6                      d 1  
 13 a  $m^7$                       b  $12m^8$                       c  $m^2$   
           d  $2a^4$                       e  $x^{12}$                       f  $8a^6$   
 14 a  $-2x^4y^2z^2$                       b  $y^{10}$                       c 7  
           d 2                      e  $4y^{10}$                       f  $m^6$   
           g  $2b$                       h  $y^4$

### Multiple-choice questions

- 1 C  
 2 D  
 3 B  
 4 D  
 5 E  
 6 C  
 7 E  
 8 E  
 9 E  
 10 B

### Extended-response questions

- 1 a  $120 + 80n$   
 b  $80 + 100n$   
 c A costs \$360, B costs \$380.  
 d Any more than two hours  
 e  $520 + 440n$   
 f \$2720  
 2 a  $xy - \frac{x^2}{4}$   
 b  $33 \text{ m}^2$   
 c  $2x + 2y$   
 d 26 m  
 e Area =  $xy - \frac{x^2}{3}$ , Perimeter =  $2x + 2y$   
 f Area is reduced by  $\frac{x^2}{12}$  and perimeter remains the same.



### Semester review 1

#### Computation with integers

##### Short-answer questions

- 1 a 5169                      b 1350                      c -288  
 d 695                          e 1386                      f 2800  
 g 81                            h 64                          i -19  
 2 a -14                          b 30                          c 72  
 d -7                            e 54                          f -6  
 3 a 6                            b 7                            c 20                          d 3  
 4 a 168                          b 72                          c 300                          d 66 150  
 5 a -3                            b 40                          c 27                          d -55  
 e 25                            f -8                          g 19

##### Multiple-choice questions

- 1 B                      2 C                      3 C                      4 A                      5 B

##### Extended-response question

- a Hong Kong  
 b Moscow, New York  
 c Hong Kong  
 d 8.9°C  
 e 14.8°C  
 f Min. = 10.7°C, Max. = 16.5°C (correct to one decimal place)

#### Angle relationship and properties of geometrical figures

##### Short-answer questions

- 1 a 66                          b 25                          c 123  
 d 35                          e 70                          f 98  
 2 a  $x = 81, y = 99$   
 b  $a = 75$   
 c  $a = 62, b = 62$   
 d  $a = 65, b = 65$   
 e  $a = b = c = d = 100, e = 80$   
 f  $x = 95, y = 85$   
 3 a 48                          b 45                          c 60  
 d 75                          e 121                          f 75  
 4 a  $a = b = 90$   
 b  $a = 73, b = 95$   
 c  $a = 265, b = 30$   
 5 120°

##### Multiple-choice questions

- 1 B                      2 D                      3 C                      4 C                      5 D

##### Extended-response question

- $b = 65$  (supplementary to  $a$ )  
 $c = 65$  (alternate to  $b$ )  
 $d = e = 57.5$  (isosceles triangle)  
 $f = 122.5$  (supplementary to  $d$ )

- $g = 122.5$  (revolution angle 360)  
 $h = 180$  (straight angle)  
 $i = 295$  (revolution)

#### Fractions, decimals and percentages

##### Short-answer questions

- 1 a 18                          b 1                          c 5  
 2 a  $\frac{1}{4}$                           b  $\frac{7}{5}$                           c  $3\frac{1}{4}$   
 d  $-\frac{2}{21}$                           e  $\frac{1}{3}$                           f  $\frac{9}{10}$   
 3 a  $\frac{5}{2}$                           b  $\frac{1}{8}$                           c  $\frac{5}{21}$   
 4 a  $\frac{9}{2}$                           b  $\frac{3}{4}$                           c  $\frac{5}{8}$   
 5 a 6.93                          b 7.58                          c 4.03  
 d 6.51                          e 3854.8                          f 792  
 6 a 545.9                          b 1008                          c 0.614  
 7

Fraction	$\frac{1}{4}$	$\frac{1}{2}$	$\frac{1}{5}$	$\frac{1}{3}$	$\frac{2}{3}$	$\frac{4}{5}$	$\frac{19}{20}$	$\frac{99}{100}$	$\frac{1}{200}$
Decimal	0.25	0.5	0.2	0.3	0.6	0.8	0.95	0.99	0.005
Percentage	25%	50%	20%	33.3%	66.6%	80%	95%	99%	0.5%

- 8 a 5.6  
 b 11.76  
 c 85.5m  
 d \$1.98  
 e \$105  
 f 4930g  
 9 a \$700                          b \$862.4                          c \$0.9936  
 10 25

##### Multiple-choice questions

- 1 D  
 2 C  
 3 C  
 4 B  
 5 C

##### Extended-response question

- a i \$1784.15                          ii \$1516.53                          iii \$1289.05  
 b 6 years  
 c No. There will always be 85% of the previous value.

#### Measurement and Pythagoras' theorem

##### Short-answer questions

- 1 a 500 cm  
 b 180 cm  
 c 90000 cm<sup>2</sup>  
 d 1.8 m  
 e 4000 cm<sup>3</sup>  
 f 10000 m<sup>2</sup>

- 2 a 18.6 cm  
b 64 m  
c 40 m
- 3 a i 25.13 m  
ii 50.27 m<sup>2</sup>  
b i 47.12 cm  
ii 176.71 cm<sup>2</sup>
- 4 a i 25.71 m  
ii 39.27 m<sup>2</sup>  
b i 17.85 cm  
ii 19.63 cm<sup>2</sup>  
c i 54.85 mm  
ii 169.65 mm<sup>2</sup>
- 5 a 30 m<sup>2</sup>  
b 48 m<sup>2</sup>
- 6 a SA = 105.84 m<sup>2</sup>, V = 74.088 m<sup>3</sup>  
b SA = 85 m<sup>2</sup>, V = 50 m<sup>3</sup>  
c SA = 60 m<sup>2</sup>, V = 24 m<sup>3</sup>
- 7 a 615.75 m<sup>3</sup>  
b 392 699.08 cm<sup>3</sup>  
c 1.26 m<sup>3</sup> or 1 256 637.06 cm<sup>3</sup>
- 8 a 13  
b 14.42
- 9 a 1530 hours  
b 0735 hours

**Multiple-choice questions**

- 1 C  
2 B  
3 D  
4 B  
5 D

**Extended-response question**

- a 15 - 2x  
b x  
c x(15 - 2x)<sup>2</sup>  
d 169m<sup>3</sup>  
e x = 2.5

**Algebraic techniques and index laws****Short-answer questions**

- 1 a p + q  
b 3p  
c  $\frac{m^2}{2}$   
d  $\frac{x+y}{2}$
- 2 a 9  
b 25  
c 102  
d 116  
e -24  
f -24

- 3 a 24k  
b 3a  
c a<sup>3</sup>  
d  $\frac{p}{2}$   
e 7ab + 2  
f x - 1  
g 2y  
h 2n - 2m
- 4 a xy  
b  $\frac{x}{7}$   
c  $\frac{7w}{10}$   
d  $\frac{7a}{2}$
- 5 a  $\frac{m}{6}$   
b ab  
c  $\frac{2}{3}$
- 6 a 12m - 18  
b 4 + 2m  
c 9A + 6
- 7 a 6(3a - 2)  
b 6m(m + 1)  
c -8m(m + 2n)
- 8 a 8x + 20  
b 3x(x + 10)
- 9 a m<sup>9</sup>  
b 32a<sup>4</sup>  
c -48a<sup>6</sup>b<sup>9</sup>  
d a<sup>6</sup>  
e a<sup>4</sup>b<sup>2</sup>  
f  $\frac{1}{2}$
- 10 a x<sup>14</sup>  
b 16a<sup>12</sup>  
c 25a<sup>8</sup>b<sup>12</sup>  
d 1  
e 1  
f -5c<sup>2</sup>

**Multiple-choice questions**

- 1 C  
2 A  
3 D  
4 B  
5 D

**Extended-response question**

- a (7a + x) cm  
b 6a<sup>2</sup> cm<sup>2</sup>  
c x = 5a  
d 12a cm  
e 216 cm<sup>2</sup>

Chapter 6

6A

Building understanding

- 1 a 1:1                      b 1:2  
2 D                          3 B                          4 C

Now you try

- Example 1  
a 9:30                      b 6:4  
Example 2  
a 2:5                        b 7:8  
Example 3  
a 18:5                      b 16:21  
Example 4  
a 6:1                        b 1:3

Exercise 6A

- 1 a 12                                      b 14  
c 4  
2 a 1:5                                      b 1:3                                      c 4:5  
d 5:8                                      e 3:4                                      f 3:10  
g 9:7                                      h 2:1                                      i 9:7  
j 3:1                                      k 3:1                                      l 6:11  
m 12:1                                      n 1:6                                      o 8:5  
p 6:5  
3 a 1:2:3                                      b 4:7:11                                      c 7:10:2  
d 17:7:3                                      e 1:2:3                                      f 2:6:5  
g 9:14:2                                      h 2:4:7  
4 a 2:3                                      b 5:4                                      c 8:15  
d 10:7                                      e 3:2                                      f 7:8  
g 33:4                                      h 27:14                                      i 2:1  
j 11:3                                      k 50:21                                      l 52:45  
5 a 8:3                                      b 3:14                                      c 3:11  
d 8:6 or 4:3  
6 a 2:5                                      b 14:1                                      c 3:25  
d 1:35                                      e 20:3                                      f 2:25  
g 50:11                                      h 5:1                                      i 2:5  
j 1:6                                      k 12:1                                      l 9:1  
m 1:16                                      n 2:9                                      o 1:7  
p 14:3                                      q 1:8                                      r 30:1  
7 B  
8 a 2:11                                      b 9:11                                      c 2:9  
9 a 2:3:3                                      b 1:1                                      c 2:5                                      d 5:7  
10 a 5:5:2:4:3:1:20                                      b 20:20:8:16:12:4:80  
c i 1:4                                      ii 1:1  
11 Andrew did not convert the amounts to the same units.  
Correct ratio is 40:1.  
12 a 8:1                                      b 8:1, yes  
13 Answers may vary.  
a 24 minutes to 1 hour  
b 2 kilometres to 1500 metres

- 14 a  $a:2b$                                       b  $5x:y$                                       c  $1:a$   
d 5:24                                      e  $h:3$                                       f  $2x:5$   
15 a 4:3  
b 16:9  
c Squared.  $16:9 = 4^2:3^2$   
d 47:20  
e-g Answers may vary.

6B

Building understanding

- 1 a 12                                      b 20                                      c 6                                      d 15  
2 a 10                                      b 6                                      c 14                                      d 9  
3 a 1:3                                      b 1:1                                      c 2:5                                      d 1:4  
4 a  $\frac{1}{4}$                                       b  $\frac{1}{2}$                                       c  $\frac{2}{7}$                                       d  $\frac{1}{5}$

Now try this

- Example 5  
a 15 litres                                      b 24 litres  
Example 6  
12 m and 18 m  
Example 7  
\$100, \$40, \$60

Exercise 6B

- 1 a 6 cups                                      b 12 cups  
c 30 cups                                      d 150 cups  
2 a 15 litres                                      b 25 litres  
c 4 litres                                      d 12 litres  
3 a 8                                      b 40  
c 3                                      d 25  
4 a 30 walnuts, 10 cashews  
b 4 peanuts, 2 cashews  
c 16 peanuts, 24 cashews  
5 a 16 m and 24 m                                      b 8 kg and 6 kg  
c \$24 and \$36                                      d 8 kg and 40 kg  
e 24 m and 48 m                                      f \$70 and \$40  
6 a \$40, \$80, \$80  
b \$50, \$150, \$200  
c 2 kg, 4 kg, 6 kg  
d 22 kg, 11 kg, 55 kg  
e 96 kg, 104 kg, 120 kg  
f \$5000, \$10000, \$15000, \$20000  
7 a 24  
b 6  
c Eliana has 4, Madeleine has 8.  
8 48  
9 Trudy makes 24, Bella makes 16.  
10  $40^\circ, 60^\circ, 80^\circ$   
11 \$250  
12 120 pages  
13 Shirt costs \$160 and jacket costs \$400.  
14 Each person gets half the total money.  
15 a  $60 \div 10 = 6$ , so there would be 6 teachers,  
 $61 \div 10 = 6.1$  but there cannot be 6.1 teachers

- b Both numbers can be multiplied by 10 to get the number of students (600 or 610).  
 c 200 students, 20 teachers  
 d 900 students is the maximum
- 16 a 1:5  
 b 1:4  
 c Arthur was 6 and Ben was 18.  
 d Arthur was 12 and Ben was 24.  
 e That would require them to have the same age, but their age will always differ by 12.
- 17 a Ramshid: \$125, Tony: \$83.33, Maria: \$41.67  
 b 10:6:5  
 c Ramshid: \$119.05, Tony: \$71.43, Maria: \$59.52  
 d \$17.85  
 e \$11.90  
 f Original ratio, as he receives \$5.95 more.  
 g Ramshid: \$120, Tony: \$70, Maria: \$60

**6C****Building understanding**

- 1 50 000 cm  
 2 3 m  
 3 a 100 000 mm      b 100 m      c 0.1 km  
 4 a 0.56 km      b 56 000 cm      c 560 000 mm  
 5 a 1:10 000      b 1:1000      c 1:300

**Now you try**

Example 8

- a 600 m (or 0.6 km)      b 240 m (or 0.24 km)  
 c 3.66 km

Example 9

- a 5 cm      b 3 mm      c 6.5 mm

Example 10

- a 200  
 b  $\frac{1}{120}$

**Exercise 6C**

- 1 a 60 000 cm or 600 m  
 b 300 000 mm or 300 m  
 c 24 000 m or 24 km
- 2 Numbers and units may vary.
- |            |           |             |
|------------|-----------|-------------|
| a i 200 m  | ii 40 m   | iii 730 m   |
| b i 16 km  | ii 370 m  | iii 25 km   |
| c i 6.4 m  | ii 288 m  | iii 12 m    |
| d i 150 cm | ii 24.6 m | iii 2.13 km |
| e i 88 m   | ii 620 cm | iii 5 mm    |
| f i 6 cm   | ii 1.6 mm | iii 200 m   |
- 3 a 1 cm      b 0.5 cm  
 c 2 mm
- 4 a i 1 m      ii 20 m      iii 3 mm  
 b i 20 m      ii 2 m      iii 1.5 mm  
 c i 13.5 cm      ii 4.5 m      iii 7.365 cm

- |           |         |             |
|-----------|---------|-------------|
| d i 60 cm | ii 9 cm | iii 0.02 mm |
| e i 20 m  | ii 3 m  | iii 5 mm    |
| f i 3 m   | ii 5 cm | iii 2 mm    |
- 5 a 250      b 50 000  
 c 50 000      d 18 000  
 e  $\frac{1}{7}$       f  $\frac{1}{600}$
- 6 a 80 m      b 4.5 cm
- 7 8.5 km      b 4.8 m × 4.8 m
- 8 a 3.6 m × 2.6 m      b 4.8 m × 4.8 m  
 c 7.9 m × 2.2 m
- 9 Length 11 m, height 4 m
- 10 About 70 cm
- 11 a 24 km      b 160 km      c 12.5 cm
- 12 1:0.01 and 100:1, 25:1 and 50:2, 20:1 and 1:0.05
- 13 a Car: D, 1:10  
 b School grounds: B, 1:1000  
 c Mt Kosciuszko: A, 1:10 000
- 14 With chosen scale, the map will be 8 m wide by 8 m high, which is too big to be practical.
- 15 The ratio provided is the wrong way around. It should be 1000:1.
- 16 Answers may vary.
- 17 Answers may vary.

**6D****Building understanding**

- 1 B, C, E, F, H
- 2 Employee's wage: \$15/h  
 Speed of a car: 68 km/h  
 Cost of building new home: \$2100/m<sup>2</sup>  
 Population growth: 90 people/day  
 Resting heart rate: 64 beats/min
- 3 a \$/kg      b \$/L  
 c Words per minute      d Goals/shots on goal  
 e kJ/serve or kJ/100 g      f L/min  
 g mL/kg or mg/tablet      h Runs/over

**Now you try**

Example 11

- a 7 laps/hour      b \$6/kg

Example 12

8 cm/year

**Exercise 6D**

- |                 |                            |
|-----------------|----------------------------|
| 1 a 5 laps/hour | b 4 laps/hour              |
| c \$5/kg        | d \$20/kg                  |
| 2 a 3 km/year   | b 5 goals/game             |
| c \$30/h        | d \$3.50/kg                |
| e \$14 000/acre | f 4500 cans/hour           |
| g 1200 revs/min | h 16 mm rainfall/day       |
| i 4 min/km      | j 0.25 km/min or 250 m/min |

- 3 a 300 km/day  
c 6.5 runs/over  
e 1.5 kg/year
- 4 a 3L/hour
- 5 158 cm
- 6 a 1.5 rolls/person  
c \$4/roll
- 7 a i 5.8 hours/day  
iii 42 hours/week  
b 180 hours
- 8 Harvey: 3.75 min/km, Jacques: 3.33 min/km; Jacques
- 9 a 1200 members/year  
b 12 years
- 10 a i 9 km/L  
ii  $\frac{1}{9}$  L/km  
b Find the reciprocal.
- 11 It takes less time to run the same distance, so for example, a 2 km race will be finished in 10 minutes by Shohini and in 12 minutes by Marc.
- 12 a i \$4  
iii \$16.50  
b 75c/minute  
c Teleconnect  
d Connectplus  
e  $16\frac{2}{3}$  min or 16 min and 40 seconds
- 13 Answers may vary.

**Progress quiz**

- 1 a 6:15  
b 4:3  
c 12:4  
d 21:24:9
- 2 a 2:3  
b 6:9:10  
c 1:12  
d 3:40  
e 1:3
- 3 a 6 cups  
b 10 cups
- 4 a \$500, \$300  
b \$5000, \$1875, \$625  
c 400 m, 600 m
- 5 a \$1760  
b \$560
- 6 320 m
- 7 4.32 cm
- 8 2 000 000
- 9 a 60 students/bus  
c 74.4 km/h  
b \$1.40/kg
- 10 a 160 km/day  
b \$2500/year  
c 8 cm/year
- 11 Kelly earns the most by \$750/year  
Kelly earns \$96 570/year.  
Todd earns \$95 820/year.
- 12 \$15 for 1 kilogram (the other is \$20/kg)

**6E**

**Building understanding**

- 1 a 3 hours  
c  $\times 10$ , 30 minutes,  $\times 10$
- b 5 hours,  $\times 5$   
d  $\times 6$ , 720 litres,  $\times 6$
- 2 a \$12, \$60,  $\times 5$   
b  $\div 5$ , 30 rotations,  $\div 5$ ,  $\times 7$ , 210 rotations,  $\times 7$

**Now you try**

Example 13

- a 2000 words in 25 minutes  
b 70 minutes

Example 14

60 hours

**Exercise 6E**

- 1 a 120  
b 300
- 2 a 2400  
b 19200
- 3 80 litres
- 4 40 litres
- 5 150 days
- 6 a 22500  
c 10 minutes  
b 375  
d 6 seconds
- 7 a 3750 beats  
b 1380 beats  
c 80 minutes
- 8 \$2520
- 9 22.5 kg
- 10 Bionic woman wins by 4 seconds.
- 11 a  $7\frac{1}{2}$  days  
b 187 students
- 12 2.4 days
- 13 a  $2\frac{2}{3}$  days  
b Matric:  $\frac{1}{3}$ , Hugh:  $\frac{4}{9}$ , Ethan:  $\frac{2}{9}$
- 14 a 80 cans  
b 5 dogs  
c 15 days
- 15 12 hours
- 16 a Buddies: \$4.50/L, 1.25 L bottles: \$1.28/L, 2 L bottles: \$1.10/L, cans: \$1.60/L  
b Buddies: \$135, 1.25 L bottles: \$38.40, 2 L bottles: \$33, cans: \$48  
c Greatest amount = 54 L, least amount = 13.2 L  
Difference = 40.8 L  
d Answers may vary.

**6F**

**Building understanding**

- 1 D  
2 A  
3 B  
4 D

**Now you try**

Example 15

- a 65 km/h  
b 6 km/h

Example 16

255 km

Example 17

20 minutes

**Exercise 6F**

- 1 a 60 km/h  
c 120 km/h  
b 50 km/h  
d 600 km/h

- 2 a 10 m/s  
c 50 km/h
- 3 a 1080 m      b 450 m      c 36 km      d 50 km
- 4 a 8 hours  
c 11.5 hours
- 5 a 25 km/h      b 40s      c 60 km  
d 120 m/min      e 70 km      f 100s
- 6 2025 km
- 7 a 27 km/h  
b  $2\frac{1}{4}$  km
- 8 27 m/s
- 9 24 km/h
- 10 a 58.2 km/h      b 69.4 km/h
- 11 250 m
- 12 8:02:40; 2 minutes and 40 seconds after 8 a.m.
- 13 a 32 seconds  
b Slower than 4 m/s because if it were 4 m/s, then it would only take 30 seconds to run 120 m, not 32 seconds.
- 14 a 343 m/s      b 299 792 458 m/s  
c 0.29 s      d 0.0003 s  
e 874 030  
f How many times the speed of sound (mach 1 = speed of sound)  
g 40 000 km/h or 11.11 km/s  
h 107 218 km/h, 29.78 km/s  
i 29.78 km/s  
j-l Answers may vary.

**6G****Building understanding**

- 1 a \$1.55      b \$10.85  
2 a 5      b 15

**Now you try**

Example 18  
\$175

Example 19  
42

Example 20  
240 km

Example 21  
30 c/min

Example 22  
a 5 m/s  
b 36 km/h

**Exercise 6G**

- 1 91 km  
2 a \$27  
b \$17.60  
c \$43.30  
d \$36

- 3 a 75  
b 36  
c 7 m  
d 133 cm
- 4 a 520 mL  
b 11 goals  
c 350 mm  
d 1 875 000 kilobytes
- 5 Leonie \$600, Mackenzie \$300, total \$1350
- 6 a 25 c/min      b 4 c/s      c 210 L/h  
d 1.2 L/h      e 6 kg/year      f 0.84 kg/week  
g 6 kg/\$      h 3.8 c/mm      i 30 m/s  
j 50.4 km/h
- 7 a 10 m/s      b 50 m/s  
c 11 m/s      d 4000 m/s
- 8 a 54 km/h      b 7.2 km/h  
c 0.72 km/h      d 3600 km/h
- 9 a Small: \$1.25/100 g, medium; \$1.20/100 g,  
Large: \$1.10/100 g  
b 4 large, 1 medium, 1 small, \$45.20
- 10 10.4 m/s, 37.6 km/h
- 11 a 1.2 cm/month, 0.144 m/year  
b 25 months or 2 years and 1 month
- 12 a 45 m<sup>2</sup>/h      b 900 m<sup>2</sup>      c  $\frac{5}{6}$  m<sup>2</sup>/min
- 13 a  $\frac{\$y}{x}$       b  $\frac{\$12y}{x}$       c  $\frac{\$zy}{x}$
- 14 a 19 cm, 22 cm, perimeter = 58 cm  
b 21 cm, 28 cm, perimeter = 84 cm
- 15 50 pa/mD
- 16 a Perth      b 56 hours      c 40 hours  
d Phil is 1125 km from Perth, Werner is 1575 km from Sydney.  
e 2450 km from Sydney, 1750 km from Perth  
f 46 hours and 40 minutes  
g Answers may vary.

**Problems and challenges**

- 1 a 2  
b  $3\frac{1}{5}$   
c  $2\frac{2}{3}$
- 2 1:3
- 3 9 km/h
- 4 a 1 hour  
b 12 sets
- 5 12 sheep
- 6  $\frac{5}{9}$  hour
- 7 0.75 km
- 8 5 hours
- 9 12.57 a.m
- 10 68.57 km/h
- 11 A 20 km trip at 100 km/h takes  $\frac{1}{5}$  hour which Max has used to drive the first 10 km. The second 10 km cannot be travelled in zero time; hence it is impossible for Max to achieve a 100 km/h average speed.

**Chapter checklist with success criteria**

- 1 10
- 2 9:4
- 3 28:15
- 4 5:24
- 5 15 cups of water
- 6 24 m:30 m; \$100:\$50:\$150
- 7 100 m
- 8 1.5 mm
- 9  $\frac{1}{300}$
- 10 \$7/kg
- 11 6.5 cm/year
- 12 1110 words
- 13 12 km/h
- 14 1425 km
- 15 3 h 45 min
- 16 20 m/s
- 17 30
- 18 630 km
- 19 24 c/min

**Chapter review****Short-answer questions**

- 1 a 1:2  
b 2:1  
c 5:9
- 2 a False  
b False  
c True  
d False  
e True
- 3 a 25  
b 12  
c 6  
d 3
- 4 a 1:4  
b 3:2  
c 3:4  
d 1:8  
e 3:1  
f 1:5  
g 3:2  
h 2:1  
i 2:3  
j 2a:1  
k 2:5  
l 11:2  
m 10:3  
n 1:3:6
- 5 a 5:2  
b 1:3  
c 2:5  
d 1:2  
e 1:5  
f 1:4

- g 3:25  
h 3:10
- 6 a \$35:\$45  
b 160 kg:40 kg  
c 30 m:10 m  
d \$340:\$595:\$510  
e 60 c:20 c:20 c
- 7 a \$1152  
b 144 cm  
c 1.125 L
- 8 a 0.2 m  
b 27 m  
c 140 m
- 9 500 mm
- 10 a 1:1.5,  $x = 9$  cm  
b 1:3,  $x = 12$  cm
- 11 a 5 km/h  
b \$50/h  
c 140 km/day
- 12 a 12.5 km/L, 8 L/100 km  
b 2.5 g/min, 150 g/h  
c \$2400/day, \$100/h
- 13 a 301 km  
b \$39.20  
c  $6\frac{2}{3}$  hours
- 14 a 64 km/h  
b 108 min  
c 6.75 km
- 15 a 200 c/min  
b 21.6 km/h  
c 200 m/s

**Multiple-choice questions**

- 1 A
- 2 C
- 3 D
- 4 A
- 5 B
- 6 B
- 7 D
- 8 B
- 9 C
- 10 C

**Extended-response question**

- a 2:15 p.m.
- b 100 km/h
- c 11:30 a.m.
- d 467 km
- e 5 hours at 93.4 km/h
- f The Harrison's petrol cost \$282.15, the Nguyen's petrol cost \$313.50.

## Chapter 7

## 7A

## Building understanding

- 1 a 13                      b 9                      c 2                      d 2  
 2 a 7                      b 9                      c 15                      d 8  
 3 a 25  
    b 25  
    c Yes  
    d  $2 + x = 7$  (Answers may vary.)

## Now you try

Example 1

- a False                      b True                      c True

Example 2

- a
- $k = 32$
- b
- $q = 12$
- c
- $a = 7$

Example 3

- a
- $3q + 4 = 37$
- b
- $15n = 345$

## Exercise 7A

- 1 a False                      b True                      c True  
 2 a True                      b False                      c True  
    d False                      e True                      f True  
 3 a True                      b True                      c False  
    d False                      e True                      f False  
 4 a True                      b False                      c True  
    d True                      e False                      f True  
 5 a C                      b I                      c C                      d C  
 6 a  $x = 7$                       b  $x = 13$                       c  $v = 3$   
    d  $p = 19$                       e  $x = 2$                       f  $x = 8$   
    g  $u = 7$                       h  $k = 11$                       i  $a = 3$   
 7 a  $2x + 7 = 10$                       b  $x + \frac{x}{2} = 12$   
    c  $25 + a = 2a$                       d  $h + 30 = 147$   
    e  $4c + 3t = 21$                       f  $8c + 2000 = 3600$   
 8 a 7                      b 42                      c 13  
    d -8                      e 40                      f -13  
 9 a  $3.2x = 9.6$                       b  $x = 3$   
 10 a  $E + 10 = 3E$                       b  $E = 5$   
    c 5 years old                      d 15  
 11  $t = 3, t = 7$   
 12 a  $3 \times 3 = 9$   
    b  $-3 \times (-3) = 9$   
    c  $x = 8, x = -8$   
    d  $x = 0$  is the only solution as  $-0 = 0$ , but  $x = 1$  and  $x = -1$  are distinct solutions.  
    e Positive numbers square to give positives but so do negatives. (neg  $\times$  neg = pos)  
 13 a No number can equal 3 more than itself.  
    b Addition is commutative.  
    c If  $x = 7$  it is true, if  $x = 6$  it is false.  
    d i S                      ii S                      iii N                      iv S  
       v A                      vi S                      vii N                      viii S  
       ix A  
    e  $7 + x = x + 7$  (Answers may vary.)

- 14 a  $p = 1, p = -3$   
    b One  
    c Answers may vary, e.g.  $(p - 2) \times (p - 3) \times (p - 5) = 0$  has 3 solutions.  
 15 a  $a = 10, b = 6, c = 12, d = 20, e = 2$   
    b  $f = \frac{1}{2}$   
 16 a  $c = 4, d = 6$  (or  $c = 6, d = 4$ )  
    b  $c = 11, d = 3$   
    c  $c = 24, d = 6$   
    d  $c = 7, d = 0$  (or  $c = 0, d = -7$ )

## 7B

## Building understanding

- 1 a  $3x + 4 = 14$                       b  $11 + k = 18$                       c  $9 = 2x + 4$   
 2 a 12                      b 25                      c 16                      d  $4z$   
 3 a 8                      b  $x = 8$   
 4 B

## Now you try

Example 4

- a
- $p = 8$
- b
- $3p = 11$
- c
- $8m = 52$

Example 5

- a
- $w = 42$
- b
- $u = 4$
- c
- $x = 7$

## Exercise 7B

- 1 a  $x = 4$                       b  $3x = 6$                       c  $9a = 9$   
 2 a  $2x = 20$                       b  $q = 8$                       c  $1 = -q$   
    d  $x = 2$                       e  $10 = 2p$                       f  $3q = 2q$   
 3 a  $x = 3$   
    b  $q = -3$   
    c  $x = 5$   
    d  $p = 7$  (missing operation:  $\div 4$ )  
    e  $x = 3$   
    f  $p = 6$  (missing operation:  $\times 3$ )  
 4 a  $a = 3$                       b  $t = 7$                       c  $q = 9$   
    d  $k = 9$                       e  $x = 10$                       f  $h = -10$   
    g  $l = -4$                       h  $g = -9$                       i  $y = 2$   
 5 a  $h = 3$                       b  $u = 4$                       c  $s = 3$   
    d  $w = 8$                       e  $x = -4$                       f  $w = -5$   
    g  $a = 2$                       h  $y = -8$                       i  $x = -6$   
 6 a  $d = 3$                       b  $j = -6$                       c  $a = 2$   
    d  $y = 2$                       e  $k = -4$                       f  $n = -7$   
    g  $b = -3$                       h  $b = 4$                       i  $a = -2$   
 7 a  $x = \frac{7}{2}$                       b  $q = \frac{1}{3}$                       c  $b = \frac{1}{2}$   
    d  $x = \frac{5}{2}$                       e  $x = -\frac{5}{2}$                       f  $p = -\frac{23}{2}$   
    g  $y = \frac{13}{5}$                       h  $y = -\frac{3}{2}$                       i  $y = \frac{2}{3}$   
 8 a  $p + 8 = 15, p = 7$                       b  $q \times -3 = 12, q = -4$   
    c  $2k - 4 = 18, k = 11$                       d  $3r + 4 = 34, r = 10$   
    e  $10 - x = 6, x = 4$                       f  $10 - 3y = 16, y = -2$   
 9 a  $x = 2$                       b  $x = 2$                       c  $x = 6$



10 a  $x = 7, y = \frac{14}{5}$       b  $x = 2, y = 26$   
 c  $x = \frac{10}{3}$       d  $p = 15, q = \frac{13}{4}$

11  $10x + 6x = 194.88$ , hourly rate = \$12.18

12 a 
$$\begin{array}{l} 7x + 4 = 39 \\ -4 \\ \hline 7x = 35 \\ \div 7 \\ \hline x = 5 \\ \times -2 \\ \hline -2x = -10 \\ +13 \\ \hline -2x + 13 = 3 \end{array}$$

b 
$$\begin{array}{l} 10k + 4 = 24 \\ -4 \\ \hline 10k = 20 \\ \div 10 \\ \hline k = 2 \\ \times 3 \\ \hline 3k = 6 \\ -1 \\ \hline 3k - 1 = 5 \end{array}$$

13 a 
$$\begin{array}{l} 4x + 3 = 11 \\ -3 \\ \hline 4x = 8 \\ \div 2 \\ \hline 2x = 4 \end{array}$$

- b No  
 c The two equations have different solutions and so cannot be equivalent.

- 14 a  $x = 5$   
 b Opposite operations from bottom to top.  
 c For example,  $7 - 3x = -8$ .  
 d You can start with  $x = 5$  and perform any operation to get a new equivalent equation (e.g. multiply by 2, multiply by 3,....)

- 15 a  $x = 3$       b  $x = 1$       c  $x = 2$   
 d  $x = 4$       e  $x = 3$       f  $x = 1$   
 g  $x = \frac{3}{2}$       h  $x = 0$       i  $x = 1$

7C

Building understanding

- 1 a 8      b 5      c No  
 2 a 30      b 10  
 c  $\times 2, 22$       d  $\times 10, 70$   
 3 a C      b A  
 c B      d D

Now you try

Example 6

- a  $k = 8$       b  $y = 4$   
 c  $x = 6$       d  $x = 9$

Exercise 7C

- 1 a  $b = 20$       b  $g = 30$   
 c  $a = 15$       d  $k = 18$   
 2 a  $l = 20$       b  $v = 12$   
 c  $m = 14$       d  $n = 35$

- 3 a  $w = -10$       b  $s = -6$   
 c  $j = -5$       d  $f = 20$   
 4 a  $a = 8$       b  $b = 20$   
 c  $c = 12$       d  $d = 22$   
 5 a  $u = 5$       b  $x = 3$       c  $k = 4$   
 d  $c = 3$       e  $x = 9$       f  $a = 5$   
 g  $c = 12$       h  $g = 6$   
 6 a  $t = -12$       b  $h = 2$       c  $a = -2$   
 d  $c = -3$       e  $s = -6$       f  $j = 2$   
 g  $v = -12$       h  $n = 9$       i  $q = -6$   
 j  $f = 3$       k  $l = -6$       l  $r = 7$   
 m  $x = 10$       n  $u = 3$       o  $k = 4$   
 p  $b = -11$   
 7 a  $x = 35$       b  $y = -24$       c  $p = 14$   
 d  $x = 16$       e  $x = 12$       f  $k = -13$

- 8 a 19      b -13  
 c 12      d 26  
 9 a  $100 - \frac{b}{3} = 60$       b \$120  
 10 The first equation has the solution  $a = 10$  and the second equation has the solution  $a = 6$ . They are different because in one case we multiply by 3 first and in the other we subtract 2 first.  
 11 a  $x = 15$       b Yes  
 c i  $q = 130$       ii  $q = 130$   
 d Keeps numbers smaller, so can be done without a calculator.  
 e i  $p = 28$       ii  $q = -81$   
 iii  $p = -77$       iv  $r = 34$

- 12 a  $x = 6$       b  $x = 3$       c  $x = 1$   
 d  $x = 2$       e  $x = 8$       f  $x = -5$

- 13 a  $x = \frac{57}{4}$       b  $x = \frac{22}{3}$   
 c  $x = \frac{80}{3}$       d  $x = \frac{2}{3}$

- 14 a  $x = 24$       b  $x = 60$       c  $x = 12$   
 d  $x = 24$       e  $x = 15$       f  $x = 42$

7D

Building understanding

- 1 a True      b False      c True  
 2 a  $3x + 3$       b 5  
 c  $5p + 9 = 5$       d  $22k + 12 = 13$   
 3 B

Now you try

Example 7

- a  $m = 4$       b  $x = 3$       c  $p = 6$

Exercise 7D

- 1 a  $x = 4$       b  $f = 3$       c  $n = 5$   
 2 a  $s = 3$       b  $j = 2$       c  $t = -2$   
 d  $n = -5$       e  $y = -5$       f  $t = -4$   
 3 a  $t = 5$       b  $z = 3$       c  $t = 3$   
 d  $q = -2$       e  $x = 9$       f  $w = 9$

- 4 a  $n = -2$       b  $u = 7$       c  $h = -5$   
 d  $j = -5$       e  $c = 1$       f  $n = -1$   
 g  $a = -4$       h  $v = -7$       i  $c = -3$   
 j  $t = 3$       k  $n = 4$       l  $n = -3$
- 5 a  $x = \frac{1}{2}$       b  $k = \frac{2}{3}$       c  $m = -\frac{3}{2}$   
 d  $j = \frac{5}{2}$       e  $j = -\frac{1}{2}$       f  $z = \frac{11}{2}$
- 6 a  $2x + 3 = 3x + 1$  so  $x = 2$   
 b  $z + 9 = 2z$  so  $z = 9$   
 c  $7y = y + 12$  so  $y = 2$   
 d  $n + 10 = 3n - 6$  so  $n = 8$
- 7 a  $x = 6$  and  $y = 10$   
 b  $x = 4$  and  $y = 7$
- 8 Area =  $700 \text{ units}^2$ , perimeter =  $110$  units
- 9 a  $4p + 1.5 = 2p + 4.9$   
 b \$1.70  
 c 11
- 10 a  $x = 5$   
 b  $x = 5$   
 c Variable appears on RHS if you first subtract  $3x$ .
- 11  $x = 8$ ,  $y = 6$ , so length = width =  $29$ .
- 12 a No solutions.  
 b Subtract  $2x$ , then  $3 = 7$  (impossible).  
 c  $5x + 23 = 5x + 10$  (Answers may vary.)
- 13 a  $x = 20$   
 b  $x = 17$ ,  $y = 51$ ,  $z = 10$   
 c  $k = 12$   
 d  $b = 10$ ,  $a = 50$   
 e  $a = 60$ ,  $b = 30$ ,  $c = 20$   
 f  $x = 3.5$

## 7E

## Building understanding

- 1 a 12      b 14      c 8, 10
- 2 a B      b D  
 c A      d C
- 3 a
- | $x$        | 0  | 1  | 2  |
|------------|----|----|----|
| $4(x + 3)$ | 12 | 16 | 20 |
| $4x + 12$  | 12 | 16 | 20 |
| $4x + 3$   | 3  | 7  | 11 |
- b  $4x + 12$
- 4 a  $9p + 3$       b  $6x + 4$       c  $x + 6$

## Now you try

Example 8

- a  $k = 3$       b  $m = 4$   
 c  $x = 6$       d  $q = 7$

## Exercise 7E

- 1 a  $p = 2$       b  $q = 4$   
 c  $x = 3$       d  $k = 1$
- 2 a  $u = 6$       b  $j = 3$       c  $p = 6$   
 d  $m = 4$       e  $n = 5$       f  $a = 3$
- 3 a  $p = -2$       b  $u = -3$       c  $v = -5$   
 d  $r = -4$       e  $b = -7$       f  $d = 3$
- 4 a  $y = 3$       b  $l = 2$       c  $w = 2$   
 d  $c = 2$       e  $d = 2$       f  $w = 6$   
 g  $p = 4$       h  $k = 2$       i  $c = 10$
- 5 a  $x = 7$       b  $r = 5$       c  $f = 3$   
 d  $p = 2$       e  $h = 4$       f  $r = 5$   
 g  $r = 5$       h  $p = 6$       i  $a = 5$
- 6 a  $r = 7$       b  $l = 2$       c  $x = 7$   
 d  $s = 8$       e  $y = 7$       f  $h = 3$
- 7 a  $d + 4$       b  $2(d + 4)$   
 c  $2(d + 4) = 50$       d 21
- 8 a  $5w + 3(w + 4)$       b \$11.50
- 9 a  $2(k - 5) = 3(k - 10)$       b 20
- 10 a 3.5      b 80
- 11 a  $x + 4 = 6$  so  $x = 2$   
 b  $4(x + 2) = 24$ , so  $x + 2 = 6$ , so  $x = 4$   
 c No, as the like terms cannot be combined when brackets are there.
- 12 The equation is  $2(x + 3) = 4x - 11$ , which would mean 8.5 people next door.
- 13 Equation  $3(x - 5) = 9(x + 1)$  has solution  $x = -4$ . He cannot be  $-4$  years old.
- 14 a  $2n + 6 = 2n + 3$  implies  $6 = 3$ .  
 b  $8x + 12 = 8x + 3$  implies  $12 = 3$ , but if  $x = 0$  then  $4(2x + 3) = 4x + 12$  is true.
- 15 a  $x = \frac{3}{2}$       b  $p = \frac{36}{5}$       c  $n = -\frac{81}{10}$   
 d  $q = 0$       e  $x = \frac{8}{5}$       f  $m = \frac{1}{4}$

## Progress quiz

- 1 a T      b F      c T
- 2 a  $k = 16$       b  $c = 13$   
 c  $m = 8$       d  $t = 5$
- 3 a  $2n + 5 = 17$       b  $a + 26 = 3a$
- 4 a  $a = 7$       b  $k = -3$       c  $h = -7$   
 d  $y = 8$       e  $u = 12$       f  $j = 7$   
 g  $d = 5$       h  $m = -8$
- 5 a  $u = 40$       b  $h = 14$   
 c  $x = 9$       d  $w = 4$
- 6 a  $n = 7$       b  $w = -2$       c  $e = -9$
- 7 a  $a = 5$       b  $w = 11$   
 c  $q = 5$       d  $p = -4$
- 8 a  $-6q = 30$ ;  $q = -5$   
 b  $\frac{2m}{3} = 12$ ;  $m = 18$   
 c  $\frac{3k + 4}{2} = -13$ ;  $k = -10$   
 d  $\frac{3x + 10}{2} = 14$ ;  $x = 6$
- 9  $5(m - 8) = 3(m + 2)$ ;  $m = 23$

## 7F

## Building Understanding

- 1 a i 9 and 9                                  ii 36 and 36  
             iii 1 and 1                              iv 100 and 100  
 b They are equal.
- 2 a i 9                                  ii 49                                  iii 169                                  iv 64  
 b no
- 3 a 9, 3, -3                                  b 25, 5, -5                                  c 121, 11, -11

## Now you try

Example 9

- a
- $x = \pm 5$
- b
- $x = \pm 4.12$
- c
- $x = \pm 6$

Example 10

- a two solutions                                  b zero solutions                                  c one solution

## Exercise 7F

- 1 a  $\pm 2$                                   b  $\pm 7$                                   c  $\pm 10$                                   d  $\pm 8$   
 e  $\pm 1$                                   f  $\pm 12$                                   g  $\pm 6$                                   h  $\pm 11$   
 i  $\pm 13$                                   j  $\pm 16$                                   k  $\pm 30$                                   l  $\pm 100$
- 2 a  $\pm 2.45$                                   b  $\pm 3.46$                                   c  $\pm 6.08$                                   d  $\pm 6.40$   
 e  $\pm 10.20$                                   f  $\pm 17.80$                                   g  $\pm 19.75$                                   h  $\pm 26.34$
- 3 a  $\pm 2$                                   b  $\pm 4$                                   c  $\pm 3$                                   d  $\pm 10$   
 e  $\pm 12$                                   f  $\pm 5$                                   g  $\pm 11$                                   h  $\pm 9$
- 4 a 2                                  b 2                                  c 2                                  d 0  
 e 0                                  f 1                                  g 1                                  h 2
- 5 20m
- 6 4m
- 7 a  $\pm 2$                                   b  $\pm 1$                                   c  $\pm 3$                                   d  $\pm 2$   
 e  $\pm 5$                                   f 0                                  g  $\pm 6$                                   h  $\pm 10$
- 8 a  $x = 0$  is the only number that squares to give 0.  
 b  $x^2$  is positive for all values of  $x$ .
- 9 a 4                                  b -5                                  c -7                                  d 14
- 10 a  $\pm\sqrt{11}$                                   b  $\pm\sqrt{17}$                                   c  $\pm\sqrt{33}$                                   d  $\pm\sqrt{156}$
- 11 a i yes                                  ii yes                                  iii no  
             iv yes                                  v no                                  vi yes  
 b There are none.
- 12 a  $\pm 2$                                   b  $\pm 1$                                   c  $\pm 3$   
 d  $\pm 1$                                   e  $\pm 2$                                   f  $\pm 5$   
 g  $\pm 2$                                   h  $\pm 3$                                   i  $\pm 6$

## 7G

## Building understanding

- 1 a 11                                  b 7  
 2 B  
 3 A

## Now you try

Example 9

- a
- $P = 22$
- 
- b
- $l = 9$

## Exercise 7G

- 1 a  $A = 19$                                   b  $A = 31$   
             c  $A = 47$                                   d  $A = 7$
- 2 a  $P = 16$                                   b  $l = 8$
- 3 a  $a = 5$                                   b  $a = 11$                                   c  $a = -2$
- 4 a  $y = 10$                                   b  $x = 6$                                   c  $x = -2$
- 5  $m = 5.5$
- 6 a  $y = 4$                                   b  $y = 8$   
             c  $x = 4.5$                                   d  $x = 6$
- 7 a  $G = 43$                                   b  $a = 9$
- 8 a \$23  
             b i  $161 = 3 + 2d$   
                     ii  $d = 79$   
                     iii 79km
- 9 a  $F = 50$                                   b  $C = 35$                                   c  $37.8^\circ\text{C}$
- 10 a  $A = 60$                                   b  $h = 4$                                   c 11
- 11 a  $T = \frac{V}{2} + 5$  (Answers may vary.)  
 b 44 mL if using rule above (Answers may vary.)  
 c  $\frac{(10-10)^2}{20} + 10 = 10$  and  $\frac{(20-10)^2}{20} + 10 = 15$
- 12 a 92                                  b 24
- 13 A and C
- 14 a  $-40^\circ\text{C} = -40^\circ\text{F}$   
 b  $160^\circ\text{C} = 320^\circ\text{F}$   
 c  $1.8x = 1.8x + 32$  implies  $0 = 32$
- 15 a A charges \$14.80; B charges \$16.20.  
 b 45 minutes  
 c 2 minutes per call. (Answers may vary.)  
 d  $t = 50$  and  $c = 40$   
 e 40 minutes

## 7H

## Building understanding

- 1 a D                                  b A                                  c E  
             d C                                  e B
- 2 a B                                  b C  
             c A                                  d D
- 3 a  $p = 6$                                   b  $x = 9$   
             c  $k = 4$                                   d  $a = 3$

## Now you try

Example 10

The cost of one toy is \$3.

Example 11

A can of soft drink is \$1.70.

Example 12

Lisa is 36 and Jaime is 12.

## Exercise 7H

- 1 a  $3d = 12$                                   b  $d = 4$   
             c \$4
- 2 a Let  $c =$  cost of one cup.                                  b  $4c = 13.2$

- c  $c = 3.3$  d \$3.30
- 3 a Let  $c =$  cost of one chair.
- b  $6c + 1740 = 3000$
- c  $c = 210$
- d \$210
- 4 a  $2(4 + w) = 72$  or  $8 + 2w = 72$
- b  $w = 32$
- c 32 cm
- 5 a Let  $t =$  times spent (hours).
- b  $70 + 52t = 252$
- c  $t = 3.5$
- d 210 minutes
- 6 2
- 7 a  $4w = 26, w = 6.5$  b  $42.25\text{ cm}^2$
- 8 Alison is 18.
- 9  $x = 65, y = 115$
- 10 a 118 b 119 c 12688

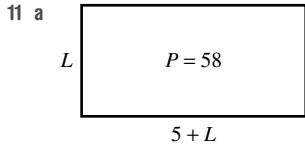

- b 12 m
- c  $204\text{ m}^2$
- 12 a 50
- b  $-6$
- c  $x = 2R - 10$
- 13 Answers will vary
- 14 a A, B and E
- b A, B and D
- c Impossible to have 0.8 people in a room but can have 8 mm insect.
- d The temperature this morning increased by  $10^\circ\text{C}$  and it is now  $8^\circ\text{C}$ . (Answers may vary.)
- 15 a 17 b  $-8$
- c  $\frac{2}{7}$  d  $\frac{4}{3}$
- e 25

**7I**

**Building understanding**

- |   |   |
|---|---|
| <ul style="list-style-type: none"> <li>1 a True</li> <li style="padding-left: 20px;">c False</li> <li>2 a D</li> <li style="padding-left: 20px;">c B</li> <li>3 a True</li> <li style="padding-left: 20px;">c False</li> <li>4 a True</li> <li style="padding-left: 20px;">c False</li> </ul> | <ul style="list-style-type: none"> <li>b False</li> <li style="padding-left: 20px;">d True</li> <li>b A</li> <li style="padding-left: 20px;">d C</li> <li>b False</li> <li style="padding-left: 20px;">d True</li> <li>b False</li> <li style="padding-left: 20px;">d True</li> </ul> |
|---|---|

**Now you try**

**Example 13**

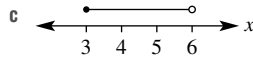
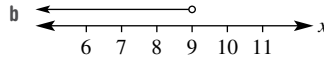
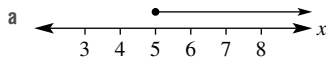

**Example 14**

- a  $x > 170$  b  $x \geq 100000$
- c  $3 < x < 4$

**Exercise 7I**

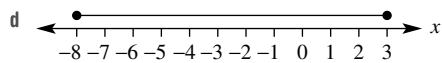
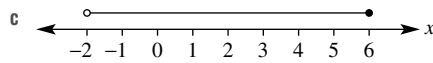
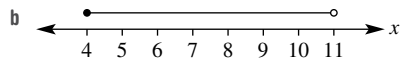
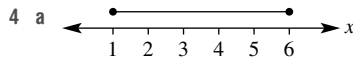
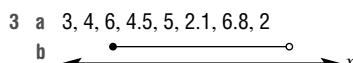
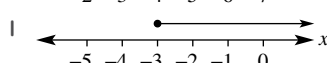
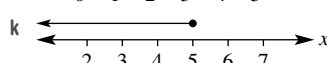
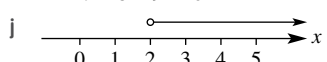
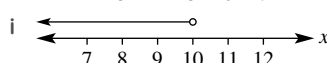
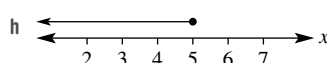
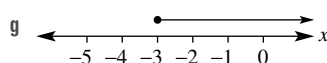
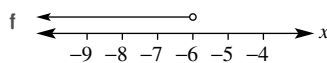
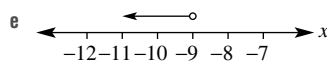
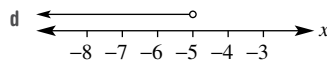
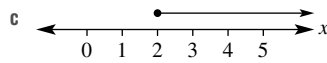
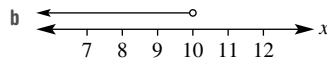
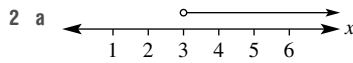
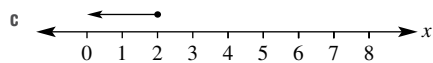
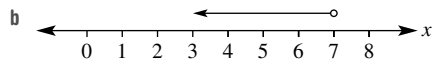
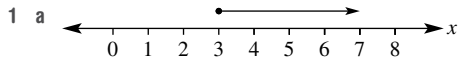

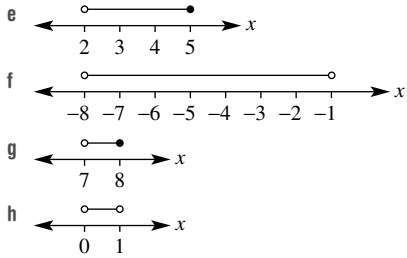

- 5 a C    b A  
 c G    d F

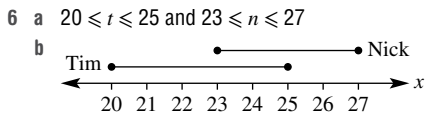

- 7 a i E    ii B    iii A  
 iv B    v D

- b  $73 \leq x < 80$   
 c D  
 d B or A  
 e C only

- 8 a  $8 \geq 2$     b  $4 < 6$   
 c  $x > 3$     d  $y \leq 8$
- 9 a If  $x$  is larger than 7, it must automatically be larger than 5.

- b i  $x > 5$     ii  $x < 3$   
 iii  $x > 1$     iv  $x < 10$   
 v  $3 < x < 10$     vi  $7 < x \leq 10$   
 c i  $3 < x < 5$     ii  $-2 < x < 4$   
 iii  $7 < x < 8$     iv  $9 \leq x < 10$

- 10 a 1    b  $\infty$     c  $\infty$   
 d 0    e 0    f 1  
 g  $\infty$     h 0

- 11 a Must be true.  
 b Must be true.  
 c Not necessarily (e.g.  $y = 0$ ).  
 d Must be true.  
 e Not necessarily (e.g.  $x = 3$  and  $y = 5$ ).  
 f Must be true.

- 12 a 30    b 110    c 200  
 d 1000    e 10    f 20  
 g 34    h 10

7J

Building understanding

- 1 a True    b True  
 c False    d False  
 2 a True    b False  
 c False    d True  
 3 a 4    b  $x < 4$   
 4 a 6, 3  
 b  $x \geq 3$   
 c True

Now you try

Example 15

- a  $x < 5$     b  $x \leq 1$     c  $x > 4$

Exercise 7J

- 1 a  $x < 4$     b  $x > 11$   
 c  $x \geq 2$     d  $x \leq 17$
- 2 a  $x > 3$     b  $l \geq 3$     c  $g > 5$   
 d  $r \leq 7$     e  $k > 2$     f  $s < 5$   
 g  $a > 4$     h  $n \geq 5$     i  $d \geq 7$   
 j  $h < 5$     k  $r \leq 2$     l  $y < 4$
- 3 a  $d > 29$     b  $y \leq 10$     c  $x > 11$   
 d  $q \leq 18$     e  $x > 7$     f  $h < 1$   
 g  $p \geq 2$     h  $j < 5$
- 4 a  $x > 1$     b  $s \leq 2$     c  $n < 5$   
 d  $j > 10$     e  $v \geq -2$     f  $j \geq -5$   
 g  $c \leq 2$     h  $h \geq 0$     i  $s < -3$   
 j  $v < -2$     k  $v \leq -2$     l  $v > -8$
- 5 a C    b A  
 c B    d D
- 6 a  $4c + 20 > 25$     b  $c > 1.25$     c \$1.30
- 7 a  $6g + 4 \leq 36$     b  $g \leq \frac{16}{3}$     c 5 goals
- 8 a  $C \geq 15$     b  $C \leq 20$   
 c  $15 \leq C \leq 20$     d  $47.7 \leq C \leq 57.7$
- 9 a  $x > 4$     b  $k > 3$   
 c  $a < -2$     d  $-3 < a < -2$
- 10 a If  $5x - 2 > 0$  then  $x > \frac{2}{5}$ , so  $x$  is positive.  
 b If  $2x + 6 > 0$  then  $x > -3$ , so  $x + 5 > 2$  is positive.  
 c Yes, for example if  $x = 4$ .  
 d No
- 11 a clues B and D    b  $x = 8$
- 12 a  $x > 2$     b  $a \leq -2$   
 c  $b < -3$     d  $c < -4$
- 13 a  $x \leq 3$     b  $a > -3$   
 c  $b \leq 8$     d  $c > 2$   
 e  $k > 20$     f  $g < -5$   
 g  $a > 8$     h  $k \leq 9$   
 i  $p > 4.5$

Problems and challenges

- 1 a 13    b 7.5  
 c 9 years    d \$44.44  
 e 15    f 150 units

2 a 2nd step or 3rd line (can't divide by 0)

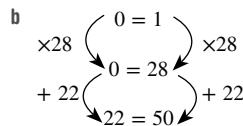

- 3  $6 \leq x \leq 7$
- 4  $2x = 2(3 + x) - 1$  or  $3x + 1 = 2 + 3(x + 1)$
- 5 a 65 kg, 62 kg, 55 kg  
 b 70 kg, 60 kg, 48 kg  
 c 35 kg, 42 kg, 45 kg, 48 kg
- 6 a 188 mm    b  $L = 8 + 36n$     c 195 links

**Chapter checklist with success criteria**

- 1 True
- 2  $2k + 3 = 52$
- 3  $5a = 15$
- 4  $u = 5$
- 5  $y = 3; x = 3$
- 6  $x = 2$
- 7  $x = 7$
- 8  $x = 3$  or  $x = -3; x = 2.65$  or  $x = -2.65$
- 9 one solution; zero solutions; two solutions
- 10  $l = 17$
- 11 0.2 kg or 200 g
- 12 Apples cost 90 cents each

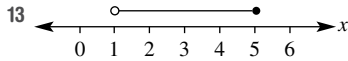

- 14  $x < 160$
- 15  $x < 7$

**Chapter review**

**Short-answer questions**

- 1 a False  
b True  
c True
- 2 a  $m = 4$   
b  $m = -12$   
c  $a = -1$   
d  $m = \frac{1}{5}$   
e  $m = 15$   
f  $a = 6$
- 3 a  $2m + 3 = 3m$   
b  $5(n + 4) = 20$   
c  $x + x + 2 = 74$
- 4 a Subtract 15  
b Add 5  
c Subtract  $2a$
- 5 a  $a = 4$   
b  $y = -9$   
c  $x = -4$   
d  $x = 4$   
e  $x = 2$   
f  $a = 1$
- 6 a  $m = -6$   
d  $k = -58$   
7 a  $x = 14$   
8 a  $a = 8$   
d  $a = 2$   
9 a  $x = 3$   
d  $a = 4$   
g  $a = -3$   
10 a 2 solutions,  $x = \pm 6$   
c 0 solutions  
11 a  $I = 21$   
c  $c = 4$   
12 a 12
- b  $x = 8$   
e  $w = -2$   
b  $x = 6$   
e  $x = -8$   
b  $x = -4$   
e  $a = -7$   
h  $x = 17$   
b 1 solutions,  $x = 0$   
d 2 solutions,  $x = \pm 3.2$   
b  $M = 3$   
d  $x = 3, y = 2$   
b 4
- c  $y = -18$   
f  $a = 43$   
c  $x = 40$   
c  $x = 4$   
f  $x = 9$   
c  $x = -4$   
f  $m = 4$   
i  $x = 1$   
c 8.5

- 13 a  $x \leq 4$
- b  $1 < x \leq 7$

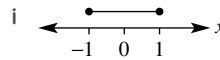
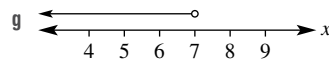
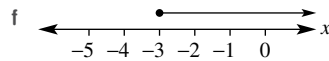
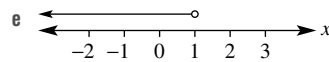
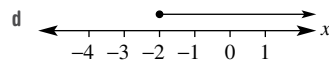
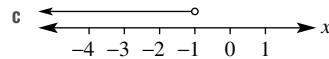
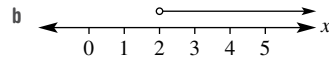
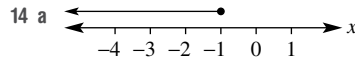

- 15 a  $x \geq 100\,000$   
b  $x \leq 6700$   
c  $1.54 \leq x \leq 1.9$
- 16 a  $x > 2$   
b  $x < 8$   
c  $x < -4$   
d  $x \geq 2$   
e  $x < -2$   
f  $x \geq 8$   
g  $x < -12$   
h  $x > 13$   
i  $x \geq 2$

**Multiple-choice questions**

- 1 A      2 D      3 C      4 C      5 B
- 6 B      7 D      8 E      9 A      10 A

**Extended-response questions**

- 1 a  $S = 20 + 0.12n$   
b 30 times  
c  $Y = 15 + 0.2n$   
d 25  
e  $20 + 0.12n = 15 + 0.2n, n = 62.5$ , so 63 is the minimum number.
- 2 a  $18x - 180$   
b i \$35.50  
ii \$41  
iii \$459  
c \$25  
d \$30  
e  $30 \leq x \leq 35$

### Chapter 8

#### 8A

##### Building understanding

- 1 a 320                      b 270                      c 300  
 d Expton                  e Calville

##### Now you try

Example 1

- a \$80 000                      b \$10 000  
 c Ashdev earns the least.

Example 2

- a Insurance                  b 50%                      c \$4800

##### Exercise 8A

- 1 a 2000                      b 1000                      c Funston  
 2 a 10                          b 6                              c Phillip  
 d Nyree                      e 4 years  
 3 a 9                              b Handball                  c 24  
 d 8F                              e Water polo  
 4 a Slesha                      b Ross  
 c 4 years old                  d Non-linear  
 5 a Rent                          b Charity  
 c 50%                              d \$2400

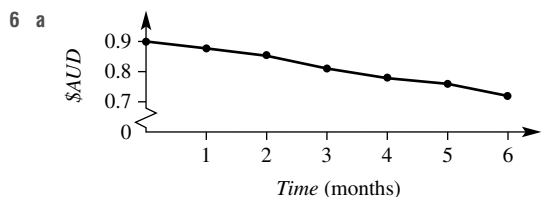

- b Linear  
 c i \$0.09                      ii \$0.02  
 d i \$0.69                      ii \$0.63  
 7 a 2 hours                  b 7 hours                  c Sleeping                  d  $\frac{1}{6}$   
 8 a 20°C                      b 12°C                      c Midday

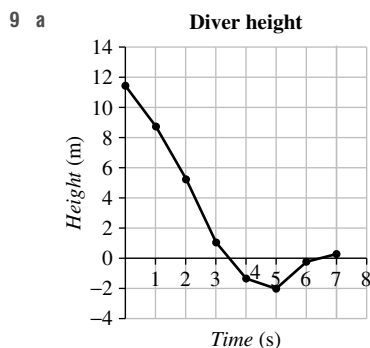

- b Non-linear  
 c 1.5 metres  
 d The fourth second

- e 2 metres below surface  
 f Answers may vary.  
 10 a Survey 2                  b Survey 1                  c Survey 3  
 11 a Town A population decreased then increased. Town B had steady increase. Town C population increased then decreased.

- b i To find the total combined population in the 3 towns.  
 ii To work out the average population per year (total  $\div$  10). Other answers are possible.

12 Need numbers for a meaningful axis but not for labels of each sector.

13 a Column graph – categorical data. (Pie chart is inappropriate as not measuring proportions of a whole.)

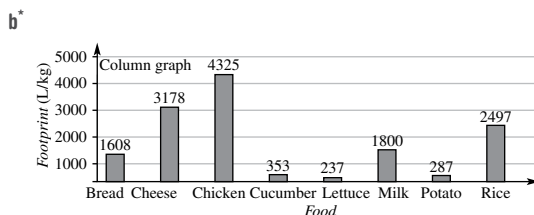

- c As water becomes scarcer it is more difficult to produce these foods.  
 d Answers may vary.

e

	Bread	Cheese	Chicken	Cucumber	Lettuce	Milk	Potato	Rice
Efficiency (g/kL)	622	315	231	2833	4219	556	3484	400

14 a 2 months underweight, 6 months normal weight, 4 months overweight

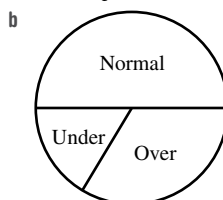

- c Can see how weight changes over time.  
 d Can see how much of the year the dog was underweight, overweight and normal weight.  
 e Answers may vary.

#### 8B

##### Building understanding

- 1 a True  
 b False  
 c True  
 d False  
 2 a 4  
 b 7  
 c II  
 d ### ## I

Now you try

Example 3

<b>Colour</b>	White	Black	Blue	Red	Yellow
<b>Frequency</b>	14	7	8	5	6

b 7 black cars were spotted.

Example 4

<b>Number</b>	1	2	3	4	5
<b>Tally</b>					
<b>Frequency</b>	3	6	1	3	2

Exercise 8B

1 a

	<b>Passes</b>	<b>Shots at goal</b>	<b>Shots that go in</b>	<b>Steals</b>
<b>Frequency</b>	3	12	8	2

b 12                      c 8                      d 4

2 a

<b>Number of hours</b>	0 – 1	2 – 4	5 – 9	10 – 14	15 – 19	20 – 24	25 – 168
<b>Tally</b>	5	3	12	15	9	4	2

b 50                      c 9                      d 8                      e 35

3 a

<b>People in family</b>	2	3	4	5	6	7	8
<b>Tally</b>							
<b>Frequency</b>	1	2	4	4	4	2	3

b 4                                      c 9

4 a

<b>Height (cm)</b>	<b>Tally</b>	<b>Frequency</b>
130 – 139		3
140 – 149		5
150 – 159		2
160 – 169		3
170 – 179		3
180 – 189		1
190+		4

b 2                      c 5                      d 10

5 a 10                      b 2                      c 4                      d 17

6 a B                      b D                      c A                      d C

7 a 28                      b 130                      c 19

d 13.1 years old                      e 14.4 years old

8 a

<b>Score</b>	0 – 19	20 – 39	40 – 59	60 – 79	80 – 100
<b>Frequency</b>	0	4	7	20	12

b

<b>Score</b>	0 – 29	30 – 59	60 – 89	90 – 100
<b>Frequency</b>	3	8	30	2

c It is unknown how many of the 3 people in the 20s got less than 25 and how many got more.

d

<b>Score</b>	0 – 24	25 – 49	50 – 74	75 – 100
<b>Frequency</b>	2	4	20	17

e 43. This tells you the number of students who sat the exam.

9 a

<b>Range</b>	10 – 19	20 – 29	30 – 39
<b>Frequency</b>	3	4	6

b Many possible answers.

c A stem-and-leaf plot

d When individual numbers are not required but an overview is more important

10 a Many possible answers.

b There are 5 possible values and it happened 6 times, so one value is repeated.

c Even if each score was achieved twice that would only account for 10 weeks (not 11).

d Yes

e Yes

11 a Monday 3, Tuesday 2, Wednesday 1, Thursday 3

b 2 hours

c 12 ways

d 3 ways

e 6 ways

f 30 ways

8C

Building understanding

1 a 2                                      b 9                                      c 11 years old

2 a 4                                      b 4                                      c 8

3 a 13                                      b 3                                      c 2

Example 5

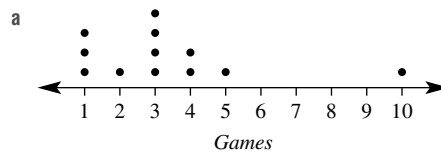

b 3

c 10



Now you try

Example 6

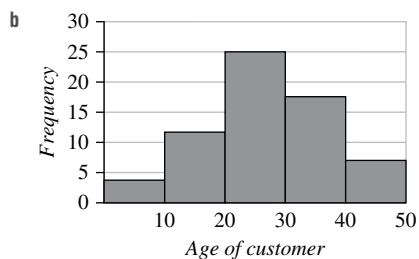
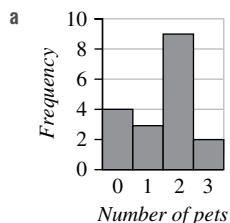

Exercise 8C

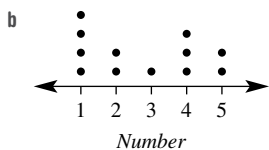
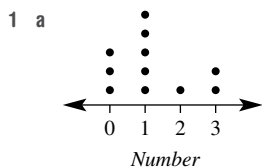

- b 4
- c 10

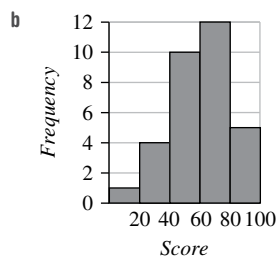
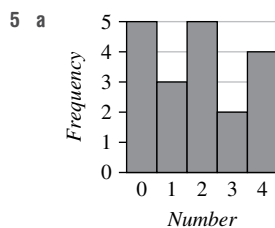
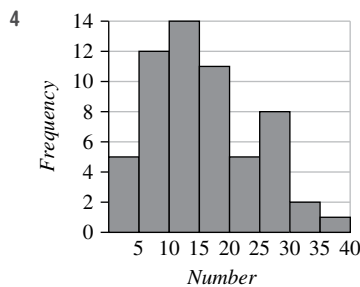
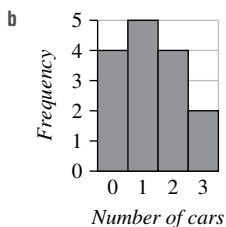
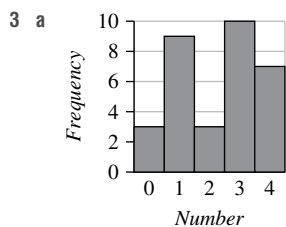

6 a

Score	Frequency
1	3
2	2
3	2
4	3
5	2
6	2
7	2
8	1
9	2
10	1

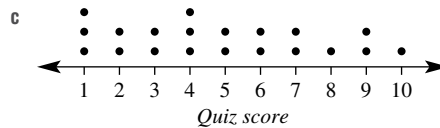
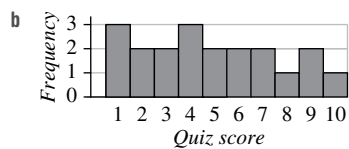



- 17 a Answers may vary.  
 b 40, 60, 80, 60, 60, 0, 20, 80  
 c 59, 79, 100, 79, 79, 19, 39, 100  
 d No  
 e between 50 and 69.25  
 f C or B  
 g When sorted from worst to best, she got E, D, C, B, B, B, A, A and the average of the two middle marks must be a B if they were both Bs.  
 h i 75 to 94.75  
 ii B or A

8E

Building understanding

- 1 a 8                                      b 1                                      c 7  
 2 a 4                                      b 9                                      c 5  
 3 a 5                                      b 12                                      c 7  
 4 a Lower quartile  
 b Lowest  
 c Sort (or order)  
 d Median  
 e Odd  
 f Spread

Now you try

- Example 9  
 a 15                                      b 23  
 Example 10  
 a 8.5                                      b 7

Exercise 8E

- 1 a 9                                      b 11  
 2 a 10                                      b 15                                      c 14  
    d 27                                      e 16.9                                      f 8.7  
 3 a 19                                      b 11                                      c 7  
    d 9.5                                      e 3.16                                      f 1.76  
 4 a 23                                      b 19                                      c 16.5  
    d 10.5                                      e 3.45                                      f 1.15  
 5 a 11                                      b 10.5                                      c 9  
    d 8                                      e 32                                      f 23  
    g 18                                      h 13  
 6 a 15                                      b 35  
    c Nathan                                      d Gary  
 7 a  $5 - 1 = 4$                                       b 7 years  
 8 a 1.7                                      b 1.8                                      c Max  
 9 a i 9                                      ii 10  
    b i 4.5                                      ii 4.0  
    c Sara  
    d Andy  
 10 a i 9, 10, 11 (Answers may vary.)  
       ii 0, 10, 20 (Answers may vary.)  
    b i 0, 20 (Answers may vary.)  
       ii -9, 11 (Answers may vary.)  
 11 a i 8                                      ii 4  
       b i 98                                      ii 4

- c A single outlier does not affect the IQR but the range is greatly affected.  
 12 a 10  
    b 4  
    c No, the range is the largest difference between two numbers.  
    d Yes, for instance, for a set like 2, 2, 2, 6, 6, 6.  
 13 a No effect  
    b Range is doubled  
 14 The lower quartile is the number above the bottom quarter of values and the upper quartile is the number below the top quarter of values.  
 15 a 4  
    b 3  
    c It would stay the same.  
    d It would stay the same.  
    e i It would double.  
       ii It would double.

8F

Building understanding

- 1 a Surveying 1000 randomly selected people  
    b Surveying 10 friends  
 2 a  $\frac{2}{5}$                                       b 2000                                      c 300

Now you try

- Example 11  
 a i  $\frac{9}{40}$  or 0.225  
    ii 800  
 b Symmetric  
 c Interviewing people only from one culture or religion. (Answers may vary.)

Exercise 8F

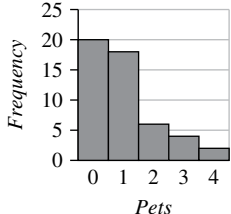
- 1 a  $\frac{1}{5}$  or 0.2  
    b 120  
 2 a Symmetric  
    b Negatively skewed  
    c Bi-modal  
    d Positively skewed  
    e Symmetric  
 3 a   
    b Positively skewed  
    c 400  
    d 1200  
    e More likely that people will have pets if near a vet clinic.



- 2 a {1, 2, 3, 4, 5, 6}  
 b  $\frac{1}{6}$   
 c  $\frac{1}{2}$   
 d {1, 2, 3, 4, 6}  
 e  $\frac{5}{6}$   
 f 0

- 3 a {1, 2, 3, 4, 5}  
 b i  $\frac{3}{5}$   
 iii  $\frac{4}{5}$   
 c i At most 2  
 iii At least 2

- ii  $\frac{1}{5}$   
 iv  $\frac{4}{5}$   
 ii At least 4  
 iv At most 4

- 4 a  $\frac{3}{4}$   
 b 0.7  
 c  $\frac{3}{7}$   
 d 0.05  
 e 0.6  
 f  $\frac{7}{11}$

- 5 a  $\frac{1}{2}$   
 c  $\frac{3}{10}$   
 e  $\frac{1}{2}$   
 g Choosing a purple marble

- b  $\frac{1}{5}$   
 d  $\frac{4}{5}$   
 f  $\frac{7}{10}$

- 6 a 8  
 b  $\frac{1}{8}$   
 c  $\frac{1}{4}$   
 d  $\frac{3}{8}$

- e {green, green, red, yellow, purple}  
 f  $\frac{5}{8}$   
 g  $\frac{3}{4}$

- h Spinning purple (or spinning yellow)  
 i Spinning orange

- 7 a {1, 2, 3, 4, 5, 6, 7, 8, 9, 10}  
 c  $\frac{1}{5}$   
 e  $\frac{1}{2}$

- b  $\frac{1}{10}$   
 d  $\frac{3}{10}$   
 f  $\frac{3}{5}$   
 b  $\frac{5}{6}$   
 d  $\frac{5}{6}$

- 8 a  $\frac{1}{3}$   
 c  $\frac{1}{3}$

9 1 -  $\frac{8}{20} = \frac{12}{20} = \frac{3}{5}$

- 10 a 0.7  
 c 0.45

- b 0.25  
 d 20

- 11 a No  
 b Yes  
 c Yes  
 d No  
 e Yes  
 f No  
 g Yes  
 h Yes

- 12 a 1 red, 2 orange, 3 purple  
 b  $\frac{1}{6}$   
 c  $\frac{1}{2}$   
 d  $\frac{2}{3}$

- 13 a  $\frac{1}{5}$   
 b  $\frac{1}{4}$   
 c 18  
 d It approaches  $\frac{1}{2}$  or 0.5.

- 14 a 0.8  
 b i 0.4  
 ii 0.8  
 iii 0.2  
 c  $2p$   
 d  $1 - 2(1 - p)$  or  $2p - 1$   
 e If  $\text{Pr}(\text{pass}) = 0.6$  then twice as likely to fail gives  $\text{Pr}(\text{other person pass}) = 0.2$ , which is not the same as half of 0.6.

- 15 a 2 red, 1 blue  
 c 5 green  
 e 1 green  
 g 6 blue, 5 green  
 b 2 blue, 1 green  
 d 6 blue, 1 red, 5 green  
 f 1 blue, 5 green

8H

Building understanding

- 1 a 10  
 c  $\frac{2}{5}$   
 e  $\frac{3}{10}$   
 b H2, H4, T2, T4  
 d T1, T3, T5  
 2 a  $\frac{1}{4}$   
 b HH, TT  
 c  $\frac{1}{2}$

Now you try

Example 14

a

	P	I	E
1	1P	1I	1E
2	2P	2I	2E
3	3P	3I	3E
4	4P	4I	4E

- b 12  
 c  $\text{Pr}(3P) = \frac{1}{12}$   
 d  $\text{Pr}(\text{even, vowel}) = \frac{1}{3}$

Exercise 8H

1 a

	1	2	3	4	5	6
H	H1	H2	H3	H4	H5	H6
T	T1	T2	T3	T4	T5	T6

- b 12  
 c  $\frac{1}{12}$   
 d  $\frac{1}{4}$

2 a

	<b>R</b>	<b>I</b>	<b>D</b>	<b>E</b>
<b>L</b>	LR	LI	LD	LE
<b>I</b>	IR	II	ID	IE
<b>N</b>	NR	NI	ND	NE
<b>E</b>	ER	EI	ED	EE

- b  $\frac{16}{16}$       d  $\frac{1}{16}$       f  $\frac{1}{4}$   
 c  $\frac{1}{16}$       e  $\frac{1}{4}$       g  $\frac{1}{8}$

3 a

	<b>R</b>	<b>P</b>	<b>B</b>
<b>R</b>	RR	RP	RB
<b>P</b>	PR	PP	PB
<b>G</b>	GR	GP	GB
<b>B</b>	BR	BP	BB

- b  $\frac{1}{12}$       d  $\frac{1}{12}$       f  $\frac{1}{4}$   
 c  $\frac{1}{12}$       e  $\frac{1}{6}$       g  $\frac{3}{4}$   
 4 a  $\frac{1}{12}$       b  $\frac{1}{6}$   
 c  $\frac{1}{12}$       d  $\frac{1}{2}$

5 a

	<b>1</b>	<b>2</b>	<b>3</b>	<b>4</b>	<b>5</b>	<b>6</b>
<b>1</b>	2	3	4	5	6	7
<b>2</b>	3	4	5	6	7	8
<b>3</b>	4	5	6	7	8	9
<b>4</b>	5	6	7	8	9	10
<b>5</b>	6	7	8	9	10	11
<b>6</b>	7	8	9	10	11	12

- b  $\frac{1}{9}$       d 7  
 c  $\frac{8}{9}$       e 2 and 12

6 a

	<b>Y</b>	<b>W</b>	<b>B</b>	<b>B</b>	<b>B</b>
<b>W</b>	WY	WW	WB	WB	WB
<b>O</b>	OY	OW	OB	OB	OB
<b>O</b>	OY	OW	OB	OB	OB

- b  $\frac{2}{15}$       e  $\frac{1}{5}$   
 c  $\frac{1}{15}$       f  $\frac{1}{15}$   
 d  $\frac{2}{15}$   
 7 a  $\frac{1}{8}$       b  $\frac{1}{3}$       c  $\frac{2}{3}$

8 63

- 9 a  $\frac{35}{36}$   
 b  $\frac{8}{9}$   
 c  $\frac{5}{36}$   
 d  $\frac{31}{36}$

- 10 a  $\frac{1}{52}$   
 b  $\frac{1}{26}$   
 c  $\frac{1}{16}$   
 d  $\frac{1}{4}$   
 e  $\frac{1}{2704}$

f The second card would then depend on the first card (e.g. if a red card was selected, it would be a little less likely that the next card would be red).

- 11 a i  $\frac{1}{4}$       ii  $\frac{1}{2}$   
 b i  $\frac{1}{16}$       ii  $\frac{1}{4}$   
 iii  $\frac{1}{16}$       iv  $\frac{1}{8}$   
 c OYYBBB (or some rearrangement of those letters)  
 d i  $\frac{1}{9}$       ii  $\frac{7}{18}$   
 iii  $\frac{1}{12}$       iv  $\frac{1}{6}$   
 v  $\frac{11}{36}$       vi  $\frac{3}{4}$   
 e i  $\frac{1}{24}$       ii  $\frac{1}{8}$   
 iii  $\frac{1}{12}$       iv  $\frac{1}{4}$   
 v  $\frac{1}{4}$       vi  $\frac{3}{4}$

81

Building understanding

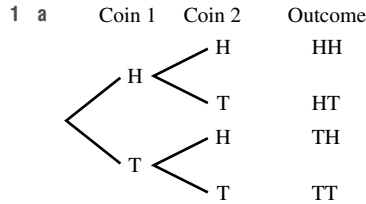

b 4

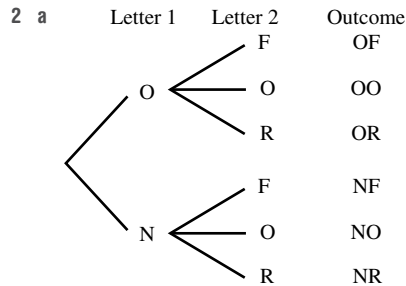

- b OR, NF, NO, NR  
 c 6  
 d 2

**Now you try**

Example 15

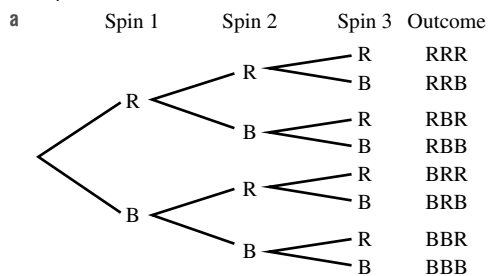

- b 8  
 c  $\Pr(BRR) = \frac{1}{8}$   
 d  $\Pr(RRR \text{ or } BBB) = \frac{1}{4}$

**Exercise 81**

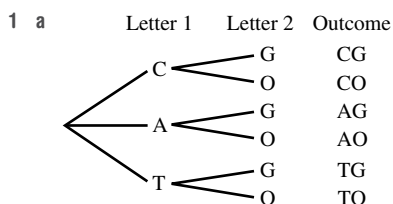

- b 6  
 c  $\frac{1}{6}$   
 d  $\frac{1}{6}$   
 e  $\frac{1}{3}$

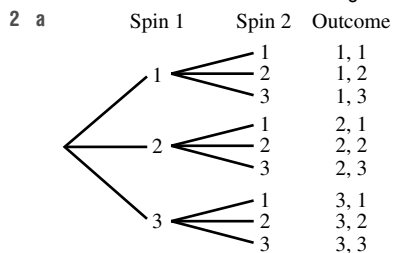

- b  $\frac{1}{9}$   
 c  $\frac{1}{9}$   
 d  $\frac{2}{9}$   
 e  $\frac{1}{3}$   
 f  $\frac{1}{3}$

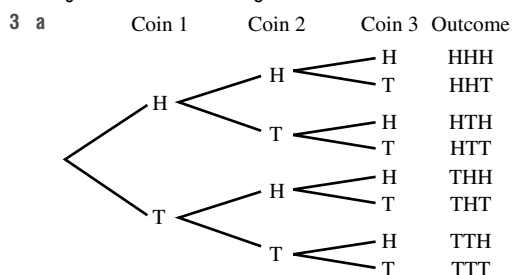

- b  $\frac{1}{8}$   
 c  $\frac{7}{8}$   
 d  $\frac{1}{8}$   
 e  $\frac{3}{8}$   
 f Exactly 2 tails  
 g  $\frac{1}{2}$

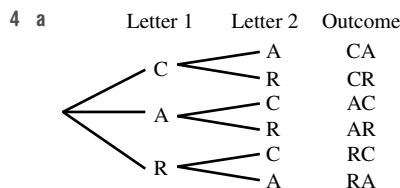

- b  $\frac{1}{3}$   
 c  $\frac{1}{3}$   
 d 0  
 e 1

5 a \$100  
 b

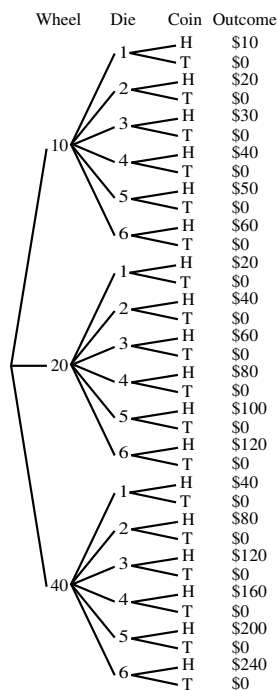

- c  $\frac{1}{18}$   
 d  $\frac{1}{6}$   
 e  $\frac{19}{36}$

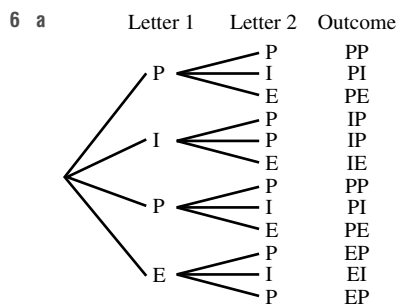

- b  $\frac{1}{6}$   
 c  $\frac{1}{6}$   
 d  $\frac{5}{6}$

7 32

- 8 a  $\frac{1}{16}$   
 b  $\frac{1}{16}$   
 c They are equally likely.

- d 3 heads
- e 3 heads could be HTHH or HTTH or THTH etc. but heads must be HHHH ( $\frac{1}{32}$ ).
- 9 a There are 12 outcomes when choosing from WORM and 30 when choosing from MORROW.
- b You can't select two letters that are the same.
- 10 a The first two coins are tails.
- b There are not exactly two tails.
- c The first and third coin are not both heads.
- d At least one tail
- e Four heads
- f At least one head or at least one tail
- 11 a 20
- b 120
- c  $\frac{1}{5}$
- d  $\frac{4}{5}$

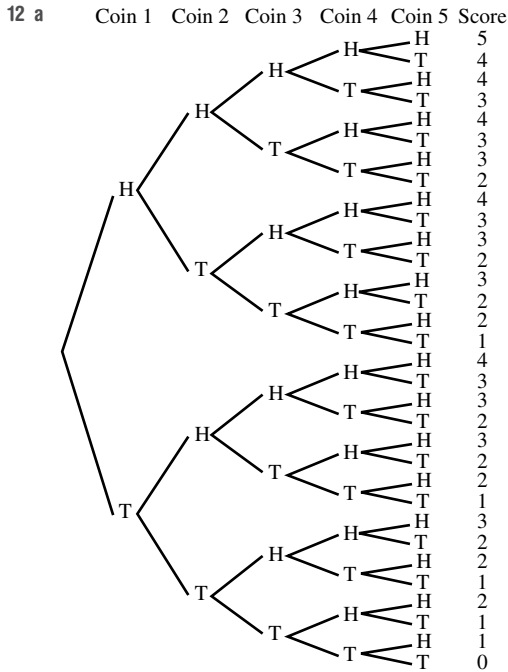

- b  $\frac{1}{32}$
- c  $\frac{1}{32}$
- d  $\frac{1}{2}$
- e  $\frac{5}{16}$
- f  $\frac{319}{512}$  (approximately 0.62)

8J

Building understanding

1 a

	Like bananas	Dislike bananas	Total
Like apples	30	15	45
Dislike apples	10	20	30
Total	40	35	75

- b 30
- c 20
- d 75
- 2 a 2
- b 4
- c 1
- d 3

Now you try

Example 16

a 3

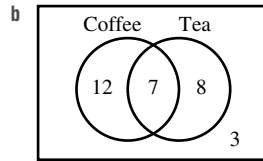

- c 15
- d 27
- e 20

f

	Like coffee	Dislike coffee	Total
Like tea	7	8	15
Dislike tea	12	3	15
Total	19	11	30

Example 17

- a i  $\frac{1}{4}$
- ii  $\frac{7}{12}$
- b  $\frac{4}{5}$
- c  $\frac{2}{3}$

Exercise 8J

1 a 8

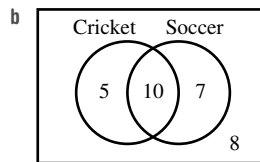

- c 15
- d 22
- e 12



f

	Plays cricket	Does not play cricket	Total
Plays soccer	10	7	17
Does not play soccer	5	8	13
Total	15	15	30

2 a 4

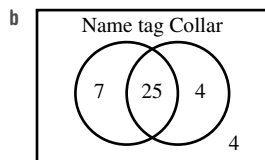

- c 32  
d 36  
e 11

f

	Name tag	No name tag	Total
Collar	25	4	29
No collar	7	4	11
Total	32	8	40

3 a 15

b

	Employed	Unemployed	Total
University degree	10	3	13
No university degree	5	2	7
Total	15	5	20

c The 10, 13, 15 and 20 would all increase by 1.

4 a 26                      b 12                      c 11

- d i  $\frac{2}{13}$                       ii  $\frac{7}{26}$   
iii  $\frac{7}{13}$                       iv  $\frac{15}{26}$

5 a

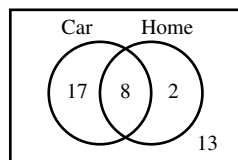

- b  $\frac{1}{5}$   
c  $\frac{17}{40}$   
d  $\frac{1}{4}$   
e  $\frac{8}{25}$   
f  $\frac{4}{5}$

6 a 3

- c i  $\frac{4}{5}$                       ii  $\frac{2}{25}$   
iii  $\frac{1}{5}$                       iv 0
- b Mutually exclusive

7 a 12

b  $\frac{2}{15}$

c  $\frac{13}{15}$

d  $\frac{4}{5}$

e  $\frac{1}{8}$

f No, there are 2 people who like both.

8 a

	B	Not B	Total
A	20	50	70
Not A	20	10	30
Total	40	60	100

b

	B	Not B	Total
A	6	5	11
Not A	4	3	7
Total	10	8	18

9 a

	Sports	Not sports	Total
Automatic	2	13	15
Not automatic	8	17	25
Total	10	30	40

b  $\frac{1}{5}$

c  $\frac{13}{40}$

d  $\frac{2}{15}$

10 a

	B	B'	Total
A	0	60	60
A'	30	10	40
Total	30	70	100

b i  $\frac{3}{5}$

ii  $\frac{2}{5}$

iii  $\frac{1}{10}$

11 a  $\frac{1}{5}$

b 45

c  $\frac{2}{9}$

d  $\frac{1}{3}$

12 a A inclusive or B is more likely since it also includes all the values in the middle of a Venn diagram.

b They have the same probability now, since there are no values in the middle.

13 a 4

b No, not if the 5 spots are in the last row/column.

c Filling it requires a negative number, which is impossible.

14 a The four numbers in the Venn diagram add to some total,  $T$ . The four possibilities listed are each equal to the numbers divided by  $T$ . So they add to 1.

b Since  $\Pr(A \text{ and } B) = 0$  for mutually exclusive events.

15 a  $\frac{x}{w + x + y + z}$

b  $\frac{w+x}{w+x+y+z}$

c

	B	Not B	Total
A	x	w	x + w
Not A	y	z	y + z
Total	x + y	w + z	w + x + y + z

d i  $\frac{a}{a+b+x}$

ii  $\frac{b}{a+b+x}$

iii  $\frac{b+x}{a+b+x}$  or  $1 - \frac{a}{a+b+x}$

iv  $\frac{a+b}{a+b+x}$

v  $\frac{x}{a+b+x}$

8K

Building understanding

- 1 a 2                      b 0.2                      c 0.6  
 2 a 0.19                  b  $\frac{1}{6}$                       c Experimental

Now you try

Example 18

- a  $\frac{1}{5}$                       b  $\frac{9}{20}$                       c 55

Example 19

Need one coin and one die.

Make a tally for the results

	Serve not in	Serve in but lose point	Serve in and win point
Tally			
Frequency			

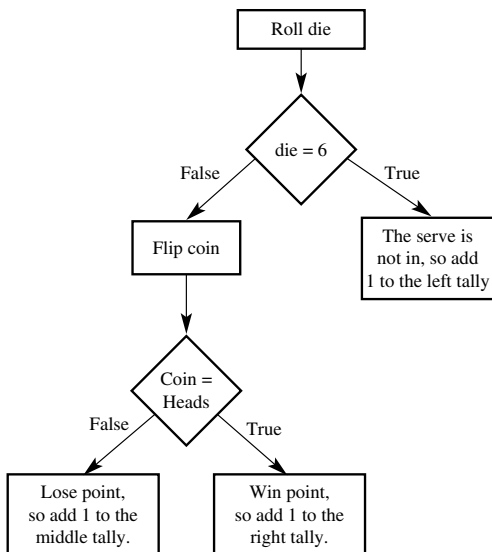

Exercise 8K

- 1 a  $\frac{4}{15}$                       b  $\frac{4}{5}$                       c 30  
 2 a 0.6                      b 0.1  
 c 0.86                      d 40  
 3 a

No. of cars	0	1	2	3	4
Frequency	12	37	41	8	2

- b 100  
 c 0.12  
 d 0.51  
 4 a 50                      b Yes                      c Yes (but very unlikely)  
 5 a  $\frac{1}{3}$                       b 200                      c 300  
 6 a i 0.35                      ii 0.25  
 iii 0.2                      iv 0.2  
 b 200  
 7 a Answers may vary.                      b Answers may vary.                      c 10  
 8 a Flip 5 coins. Heads = correct answer, tails = incorrect answer. Count number of heads for score out of 5.  
 b Answers may vary.  
 9 a 3                      b 2                      c 14  
 d 3                      e 19                      f 8  
 10 a i B                      ii D  
 iii A                      iv C  
 b Answers may vary.  
 c Answers may vary.  
 d Answers may vary, but should be approximately 60.  
 e 39  
 11 a Could be (Red: 1, 2, Blue: 3, 4, Green: 5, 6)  
 b Could be (Red: 1, 2, 3, 4 Blue: 5, Green: 6)  
 c Could not be; probability of  $\frac{1}{5}$  cannot be achieved with single die roll.  
 12 a If all three coins show heads, then count the event as happening.  
 b If tails is flipped and the number 5 is rolled.  
 c If two 'small' numbers are rolled (counting small as 1 or 2).  
 d If the sum of the dice is 12.  
 13 a 0                      b  $\frac{3}{11}$                       c  $\frac{1}{16}$   
 d False                      e True  
 14 a i 16 cm<sup>2</sup>                      ii 100 cm<sup>2</sup>  
 iii  $\frac{4}{25}$                       iv 84  
 b i 300                      ii 600                      iii 100  
 c Approximately 562.5 cm<sup>2</sup>  
 d 56 250 km<sup>2</sup>

Problems and challenges

- 1 5, 11, 14                      3 12  
 2 41                      4 0.25  
 5 a MOON                      b OFF                      c DING  
 d PROBABILITY                      e STUMBLE                      f TRY

- 6  $\frac{5}{9}$
- 7 0.000977
- 8 1 red, 3 blue, 4 yellow

**Chapter checklist with success criteria**

- 1 \$50 000
- 2

Colour	White	Black	Blue	Red	Yellow
Frequency	3	13	17	6	9

3

Number	1	2	3	4	5	6
Tally	###					
Frequency	6	2	1	3	1	1

4

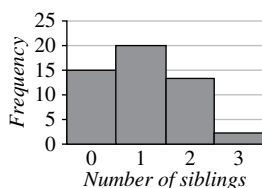

- 5 Mean = 9; mode = 15
- 6 13; 9.5
- 7 11
- 8 10.5
- 9  $\frac{3}{10}$
- 10 If someone is waiting outside a childcare centre they are more likely to have at least one child.
- 11  $\frac{1}{3}$
- 12  $\frac{1}{6}$
- 13  $\frac{3}{8}$

14

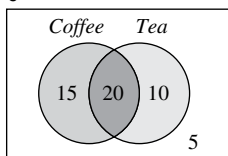

The number of people who like coffee or tea or both is 45.

15

	Like coffee	Dislike coffee	Total
Like tea	20	10	30
Dislike tea	15	5	20
Total	35	15	50

16

$\frac{3}{8}$

17

$\frac{4}{15}$

18

200

19

Create a tally for the results.

	Serve not serve in but lose point in	Serve in and win point
Tally		
Frequency		

Use one coin and one die.

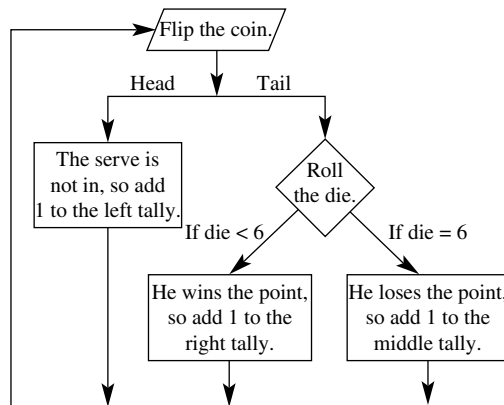

**Chapter review**

**Short-answer questions**

- 1 a Government bus  
b Train  
c 72°  
d 1000  
e Example: Prices went up for government buses.
- 2 a 22

b

Hours	0	1	2	3	4
Frequency	2	6	3	3	8

c

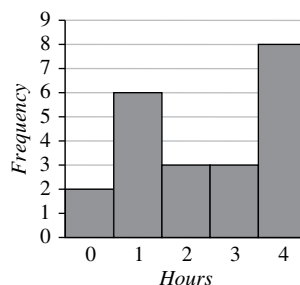

d

$\frac{1}{11}$

e

2.4

- 3 a 38, 43, 44, 44, 52, 53, 55, 56, 59, 60, 61, 62, 63, 64, 66, 68, 69, 70, 71, 72, 74, 84

b

44

c

61.5

d

16

4 a

30

b

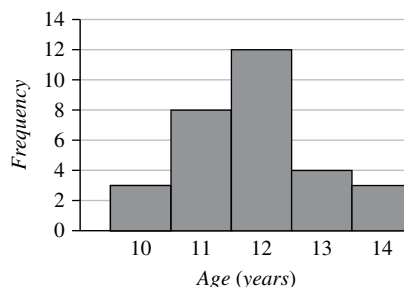

- c 11.87 years
- d 12

5 a Lowest: 50 kg, highest 85 kg

Weight	Frequency
50 – 54	6
55 – 59	6
60 – 64	8
65 – 69	7
70 – 74	7
75 – 79	1
80 – 85	5

- b
- c i 35 kg                                  ii 60 kg
- d Only teenagers were chosen, not including children or adults.
- 6 a i 6.5                                  ii 6                                  iii 3.5  
iv 9.5                                  v 6
- b Mean and median have increased by 1, but IQR is the same because all numbers have just increased by 1.
- 7 a Not enough people, and her friends might work harder (or less hard) than other students.
- b She could choose 10 people who worked less hard than her.
- 8 a  $\frac{1}{8}$                                   b  $\frac{1}{2}$                                   c  $\frac{1}{4}$   
d 1, 4, 6, 8                                  e 0
- 9 a M, A, T, H, E, M, A, T, I, C, I, A, N

- b  $\frac{2}{13}$
- c  $\frac{6}{13}$
- d  $\frac{7}{13}$
- e  $\frac{12}{13}$

10 a

	H	T
1	H1	T1
2	H2	T2
3	H3	T3
4	H4	T4
5	H5	T5
6	H6	T6

- b  $\frac{1}{4}$
- c  $\frac{1}{12}$
- 11 a

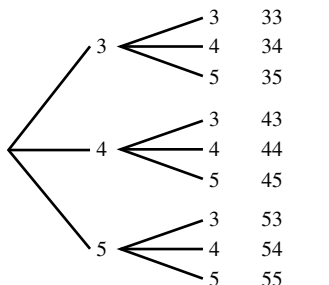

- b  $\frac{1}{3}$
- c  $\frac{1}{3}$
- d  $\frac{1}{3}$
- e  $\frac{2}{3}$
- f  $\frac{1}{3}$
- 12 a 50                                  b 25                                  c  $\frac{6}{25}$   
d  $\frac{1}{100}$                                   e  $\frac{12}{25}$                                   f  $\frac{24}{25}$

**Multiple-choice questions**

- 1 C                                  2 B                                  3 D                                  4 B                                  5 C  
6 E                                  7 B                                  8 C                                  9 C                                  10 C

**Extended-response questions**

1 a

	Uses public transport	Does not use public transport	Total
Own a car	20	80	100
Do not own a car	65	35	100
Total	85	115	200

- b 200                                  e  $\frac{4}{17}$
- c  $\frac{1}{2}$                                   f  $\frac{1}{5}$
- d  $\frac{1}{10}$
- g i More public transport users expected.  
ii People less likely to use public transport in regional area.

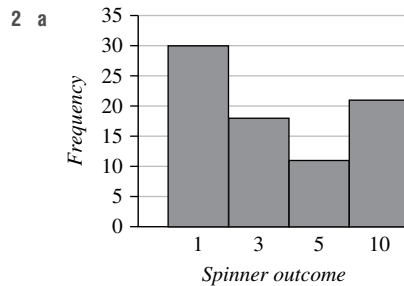

- b 1, it has the most occurrences.
- c 3 and 10, as they have the closest outcomes.

d  $\frac{3}{8}$

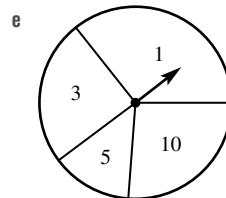

Chapter 9

9A

Building understanding

- 1 a (0, 0)                      b y                              c 1st  
     d 3rd                        e -2                              f -5  
 2 a 3                              b -1                              c -2  
     d 0                              e -2                              f 0  
     g -3                              h 0  
 3 A(1, 1), B(5, 0), C(3, 4), D(0, 4), E(-1, 2), F(-3, 3),  
    G(-5, 1), H(-3, 0), I(-4, -2), J(-2, -5), K(0, -3),  
    L(2, -3), M(5, -5)

Now you try

Example 1

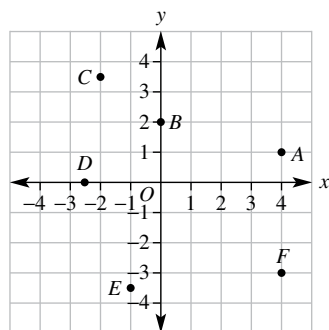

Exercise 9A

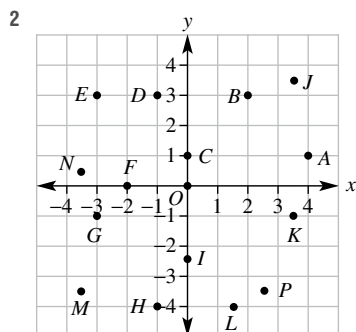
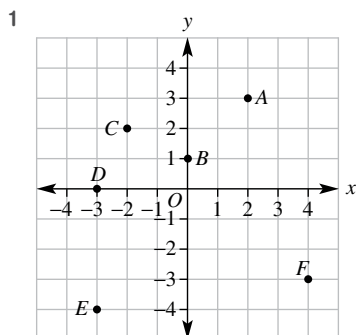

- 3 a House                              b Fish  
 4 a B                                      b C                                      c E                                      d D  
 5 a Triangle                              b Rectangle  
     c Parallelogram                      d Kite  
 6 a (2, 4)                                      b (-5, 2)  
     c (-1, -2.5)                              d (4.5, -4.5)  
 7 a (1, -2), (1, -1), (1, 0), (1, 1)  
     b (-1, 0), (0, 0), (1, 0), (2, 0)  
     c (-2, 3), (-1, 2), (0, 1), (1, 0)  
     d (-2, -3), (-1, 0), (0, 3), (1, 6), (2, 9)  
 8 a Quadrant 4                              b Quadrant 2  
     c Quadrants 2 and 3                      d Quadrants 3 and 4  
 9 A line on the y-axis  
 10 a 10                                      b 4                                      c 7  
     d 11                                      e 6                                      f 4  
 11 a 5                                      b 13                                      c 25  
     d  $\sqrt{13}$                                       e  $\sqrt{90}$                                       f  $\sqrt{61}$

9B

Building understanding

- 1 a 5                                      b 3                                      c -7                                      d 25  
 2 a 2                                      b -2                                      c -13  
 3

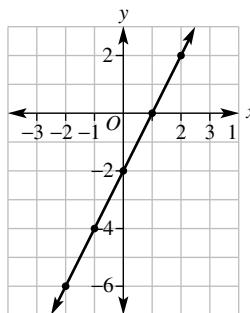

Now you try

Example 2

x	-3	-2	-1	0	1	2	3
y	-8	-5	-2	1	4	7	10

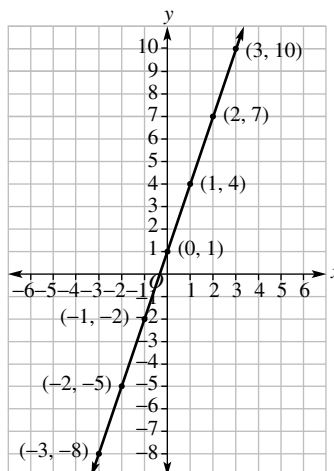

Example 3  
 (4, 12) is not on the line but (-2, -8) is on the line.

**Exercise 9B**

1 a

x	-2	-1	0	1	2
y	-7	-4	-1	2	5

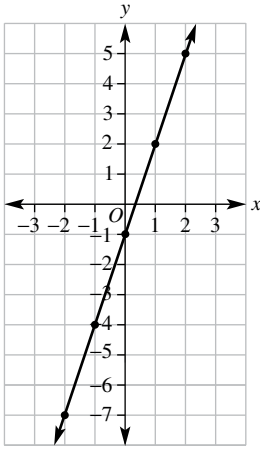

2 a

x	-3	-2	-1	0	1	2	3
y	-2	-1	0	1	2	3	4

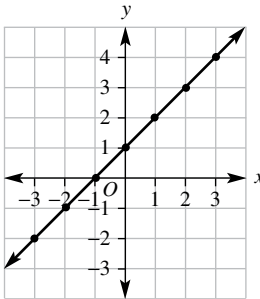

b

x	-3	-2	-1	0	1	2	3
y	-5	-4	-3	-2	-1	0	1

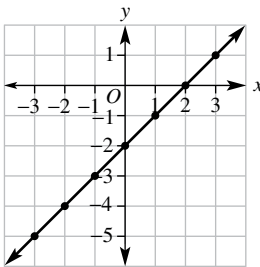

c

x	-3	-2	-1	0	1	2	3
y	-9	-7	-5	-3	-1	1	3

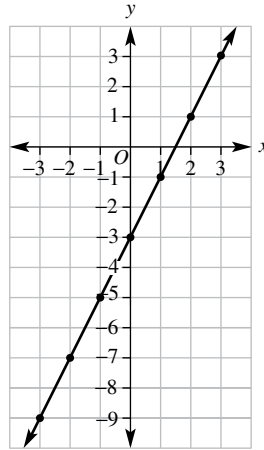

d

x	-3	-2	-1	0	1	2	3
y	-5	-3	-1	1	3	5	7

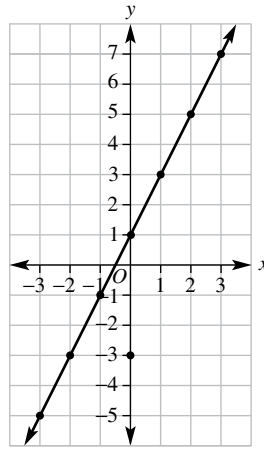

e

x	-3	-2	-1	0	1	2	3
y	9	7	5	3	1	-1	-3

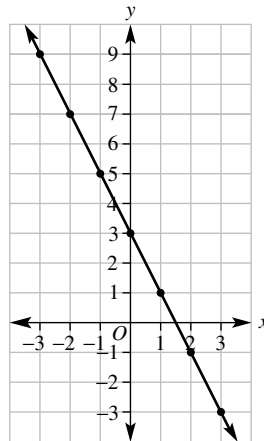

f

x	-3	-2	-1	0	1	2	3
y	8	5	2	-1	-4	-7	-10

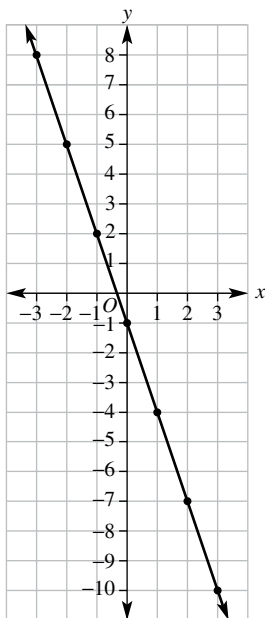

g

x	-3	-2	-1	0	1	2	3
y	3	2	1	0	-1	-2	-3

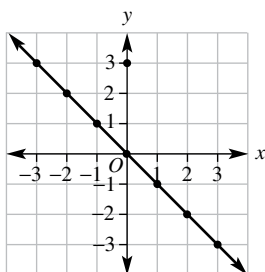

h

x	-3	-2	-1	0	1	2	3
y	7	6	5	4	3	2	1

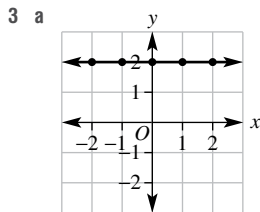
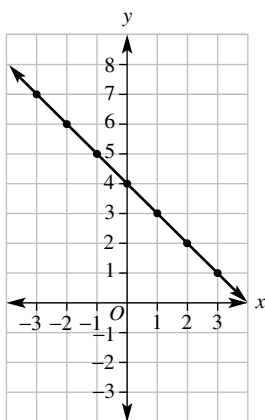

From  $y = 2$

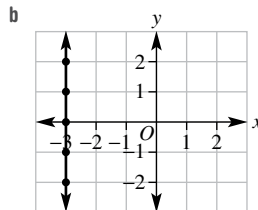

From  $x = -3$

- 4 a i Yes ii No  
 b i No ii Yes  
 c i No ii No  
 d i Yes ii Yes  
 e i Yes ii No  
 f i Yes ii Yes  
 g i No ii Yes

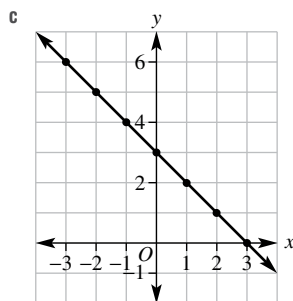
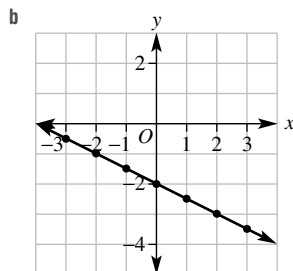
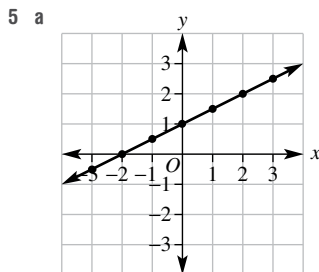

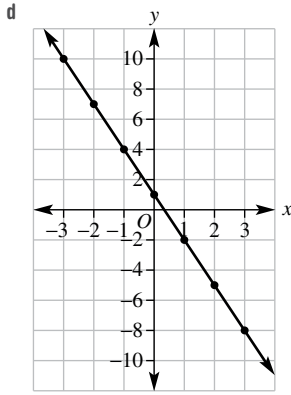

- 6 a  $(-1, 0), (0, 1)$       b  $(2, 0), (0, 2)$   
 c  $(-2, 0), (0, 4)$       d  $(2, 0), (0, 10)$   
 e  $(1.5, 0), (0, -3)$       f  $(\frac{7}{3}, 0), (0, 7)$

7  $(1, 3)$

8 a

x	-2	-1	0	1	2	3
y	-1	1	3	5	7	9

- b Yes, continuing the pattern of going up by 2  
 c  $-17$

9 a 2

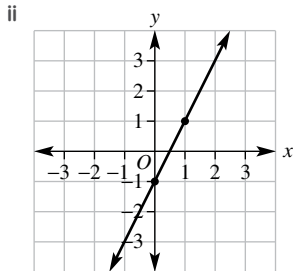
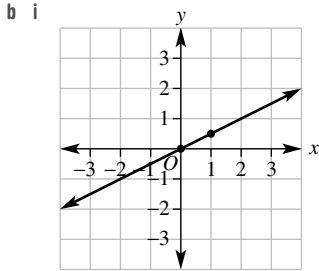

- 10 a The difference is 3 for the initial values but then changes to 4 (and then 2) from  $11 \rightarrow 15 \rightarrow 17$ .  
 b  $(1, 15)$  should be  $(1, 14)$ .  
 11 a Substituting  $x = 0$  and  $y = 0$  results in a true equation each time, e.g.  $0 = 3(0)$   
 b All the rules have a constant so when  $x = 0, y \neq 0$ .  
 12 a The coefficient of  $x$  is positive.  
 b The coefficient of  $x$  is negative.  
 c The coefficient of  $x$

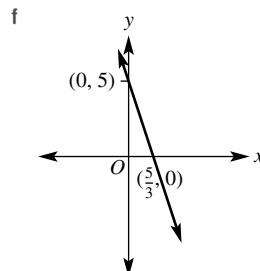
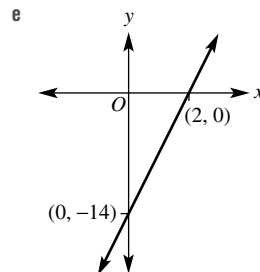
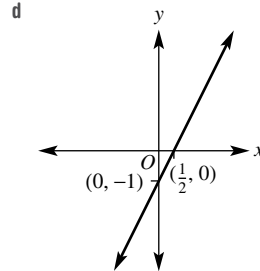
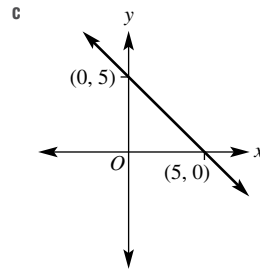
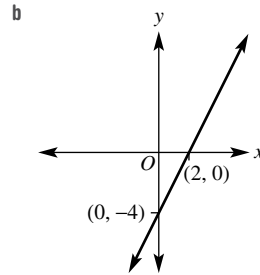
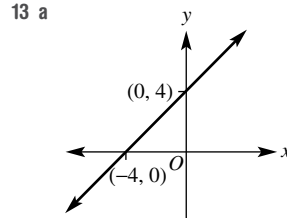



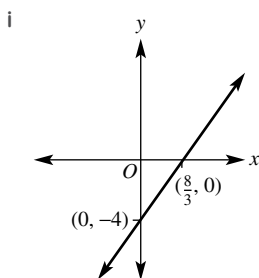
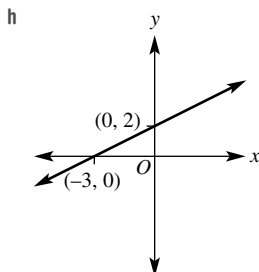
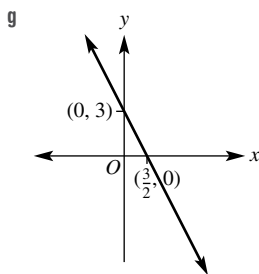

9C

Building understanding

- 1 a 2                      b -1                      c 2                      d -3  
 2 a 3                      b 1                      c 1                      d 0  
 3 a 2                      b -1                      c 0                      d 4

Now you try

Example 4

a  $y = 2x + 3$

b  $y = -3x + 16$

Example 5

$y = 2x - 3$

Exercise 9C

- 1 a  $y = 2x + 8$                       b  $y = -3x + 4$   
 2 a  $y = 2x + 4$                       b  $y = 3x - 1$   
    c  $y = -x + 1$                       d  $y = -2x + 6$   
 3 a  $y = 4x + 1$                       b  $y = 2x - 3$   
    c  $y = -2x - 2$                       d  $y = -x + 4$   
 4 a  $y = x + 1$                       b  $y = 2x - 2$   
    c  $y = -3x + 2$                       d  $y = -x$   
 5 a  $y = x + 2$                       b  $y = x - 4$   
    c  $y = 2x - 1$                       d  $y = -x + 1$   
 6 a  $y = 3x + 1$                       b  $y = 5x + 1$   
    c  $y = 2x + 4$

- 7 a  $-4, -1, 5$                       b  $y = 3x + 2$   
 8 a  $y = 8x - 2$                       b  $y = -x + 1$   
 9 a  $y = 5 - 2x$                       b  $y = 7 - 3x$   
    c  $y = 4 - x$                       d  $y = 1 - 4x$

- 10 a 5 extra matchsticks are needed for each new shape and 1 matchstick is needed for the first hexagon, so the rule is  $y = 5x + 1$ .  
 b 2 extra matchsticks are needed for each new shape and 4 matchsticks are needed for the sides, so the rule is  $y = 2x + 4$ .

11 a

x	40	41	42	43	44	45
y	43	44.4	45.8	47.2	48.6	50

- b 57  
 c  $y = 1.4x - 13$   
 d -13  
 12 a  $b - 2$                       b  $y = (b - 2)x + 2$   
 13 a  $b - a$                       b  $y = (b - a)x + a$   
 14 a x is not increasing by 1.  
    b 1  
    c  $y = x - 2$   
    d i  $y = 2x + 3$                       ii  $y = 3x - 1$   
       iii  $y = -2x + 3$                       iv  $y = -4x - 20$

9D

Building understanding

- 1 a  $x = 5$                       b  $x = -1$   
 2 a (2, 4)  
    b (3.2, 6, 4)  
    c (-2.3, -4, 6)  
    d (3.5, 7)  
    e (-7, -14)  
    f (1000, 2000)  
    g (31.42, 62.84)  
    h (-24, 301, -48.602)  
    i  $(\frac{\text{any number}}{2}, \text{any number})$   
 3 a (4, 3)                      b (-2, -3)

Now you try

Example 6

- a  $x = 2$                       b  $x = 0.5$                       c  $x = -1.5$

Example 7

- a (-1, 6), (0, 5), (1, 4), (2, 3) (Answers may vary.)  
 b (0, -1), (1, 1), (2, 3), (3, 5) (Answers may vary.)  
 c (2, 3) is true for both lines because  $5 - 2 = 3$  and  $2(2) - 1 = 3$ .  
 d  $x = 2$

Exercise 9D

- 1 a  $x = 2$                       b  $x = 0.5$                       c  $x = 3$   
    d  $x = -2.5$                       e  $x = -1.5$                       f  $x = 0$

- 2 a  $x = 2$                       b  $x = -2.5$                       c  $x = 3$   
 d  $x = -0.5$                       e  $x = 4$                                   f  $x = 5$
- 3 a i 16 km                                  ii 28 km  
 b i 3 h                                      ii 1.5 h
- 4 a (2, 3)                                  b (-1, 1)
- 5 a  $x = 3.67$                       b  $x = -1.53$                       c  $x = 5.30$
- 6 a (4.78, 1.78)                      b (-1.33, 3.41)
- 7 a i 100 km                              ii 100 km  
           iii 150 km                              iv 175 km  
 b i 1 hour                                  ii 1.5 hours  
           iii 3.5 hours                              iv 5 hours
- 8 a Any point that lies on the line is correct, e.g. (-2, 9)(0, 5)(1, 3)(2, 1)  
 b Any point that lies on the line is correct, e.g. (-2, 0)(0, 2)(1, 3)(3, 5)  
 c (1, 3)  
 $y = x + 2$      $y = 5 - 2x$   
 $3 = 1 + 2$      $3 = 5 - 2 \times 1$   
 $3 = 3$  True     $3 = 3$  True  
 d  $x = 1$
- 9 a  $A = 10 + 8n$  applies to Ruby as she has \$10 to start with and adds to her savings by \$8 times the number  $n$  of hours worked.  $A = 24 + 6n$  applies to Jayden as he has \$24 to start with and increases his savings by \$6 times the number  $n$  of hours worked.  
 b i  $n = 4$                                   ii  $n = 4$                                   iii  $n = 7$   
           iv  $n = 7$                                   v  $n = 11$                                   vi  $n = 11$   
 c Answers may vary, e.g. (2, 26)(4, 42)(7, 66)(9, 82)(11, 98)  
 d Answers may vary, e.g. (2, 36)(4, 48)(7, 66)(9, 78)(11, 90)  
 e (7, 66)                                  (7, 66)  
 $A = 10 + 8n$      $A = 24 + 6n$   
 $66 = 10 + 8 \times 7$      $66 = 24 + 6 \times 7$   
 $66 = 10 + 56$      $66 = 24 + 42$   
 $66 = 66$  True     $66 = 66$  True  
 f  $n = 7$   
 g Ruby and Jayden have both worked 7 hours and both have \$66 saved.

10 a

Time in seconds	0	1	2	3	4	5	6	7	8	9	10
Max's distance in metres	0	6	12	18	24	30	36	42	48	54	60
Jessica's distance in metres	10	14	18	22	26	30	34	38	42	46	50

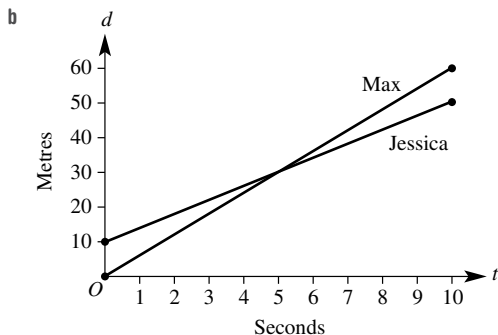

- c  $d = 6t$   
 d i  $6t = 18$                       ii  $6t = 30$                       iii  $6t = 48$   
 e  $d = 10 + 4t$   
 f i  $10 + 4t = 22$                       ii  $10 + 4t = 30$   
           iii  $10 + 4t = 42$   
 g (5, 30)                                  (5, 30)  
 $d = 6t$                                    $d = 10 + 4t$   
 $30 = 6 \times 5$      $30 = 10 + 4 \times 5$   
 $30 = 30$  True     $30 = 30$  True  
 h Max catches up to Jessica. They are both 30 m from the starting line and have each run for 5 seconds.
- 11 a i (-2, 17)(-1, 14)(0, 11)(1, 8)(2, 5)(3, 2)  
           (4, -1)(5, -4)  
           ii (-2, -3), (-1, -1)(0, 1)(1, 3)(2, 5)(3, 7)(4, 9)(5, 11)  
 b (2, 5)     $y = 11 - 3x$                        $y = 2x + 1$   
 $5 = 11 - 3 \times 2$      $5 = 2 \times 2 + 1$   
 $5 = 11 - 6$                        $5 = 4 + 1$   
 $5 = 5$  True                       $5 = 5$  True  
 c It is the only shared point.
- 12 a Parallel lines never intersect, so there is no solution to  $2x + 3 = 5 + 2x$ .  
 (If there were a solution, then this would give the  $x$ -value for where the lines intersect.)  
 b If  $2x + 3 = 5 + 2x$  then  $3 = 5$ , which is impossible.
- 13 a i Any answer with  $y$  as a whole number is correct:  
 $2x - 1 = -3$ ,  $2x - 1 = -1$ ,  $2x - 1 = 3$   
 ii No. Many possible correct examples, e.g.  $2x - 1 = 2.5$ ,  $2x - 1 = -1.75$ ,  $2x - 1 = 2.8$   
 b i Any answers with the  $y$ -value to one decimal place are correct, e.g.  $2x - 1 = -2.6$ ,  $2x - 1 = -1.8$ ,  $2x - 1 = 0.7$   
 ii No. Answers may vary, e.g.  $2x - 1 = 0.42$ ,  $2x - 1 = -1.68$ ,  $2x - 1 = 2.88$   
 c i  $2x - 1 = 2.04$ ,  $2x - 1 = 2.06$   
 ii Answers may vary, e.g. (1.521, 2.042)  
 (1.529, 2.058);  $2x - 1 = 2.042$ ,  $2x - 1 = 2.058$   
 iii Yes, for every two points on a line another point can be found in the between them so there are an infinite number of points on a line. Also an infinite number of equations can be solved from the points on a straight line if the graph has a suitable scale (digitally possible).
- 14 a i  $x = 2$ ,  $x = -2$                       ii  $x = 3$ ,  $x = -3$   
           iii  $x = 4$ ,  $x = -4$                       iv  $x = 5$ ,  $x = -5$   
 b For each  $y$ -coordinate, there are two different points so two different solutions.  
 c i  $x = 2.24$ ,  $x = -2.24$                       ii  $x = 2.61$ ,  $x = -2.61$   
           iii  $x = 0.7$ ,  $x = -0.7$                       iv  $x = 3.57$ ,  $x = -3.57$   
           v  $x = 4.34$ ,  $x = -4.34$   
 d The graph of  $y = x^2$  does not include a point where  $y = -9$ .  
 e Many correct answers, all with  $x^2$  equal to a negative number, e.g.  $x^2 = -5$ ,  $x^2 = -10$ ,  $x^2 = -20$   
 f Positive numbers or zero

g  $x = -1, x = 2$

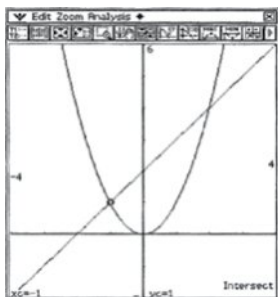

h i  $x = -2.77, x = 5.77$   
iii No solution

ii  $x = -8.27, x = 3.27$   
iv  $x = 3$

9E

Building understanding

- 1 a True                      b False                      c False  
 d True                      e False                      f True  
 g True  
 2 a True                      b False                      c True  
 d False                      e True                      f True  
 g False  
 3 a True  
 b All less than or equal to 3  
 c  $x \leq 3$

Now you try

Example 8

a  $y = 2$                       b  $x = -4$

Example 9

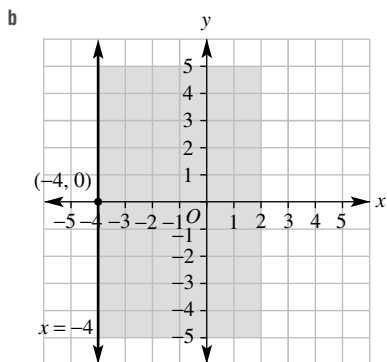
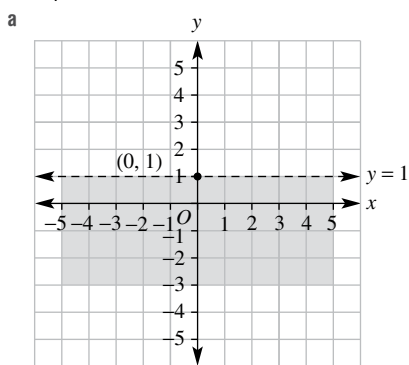

Example 10

a  $x \geq 2$                       b  $x > -4$

Exercise 9E

- 1 a  $y = 4$                       b  $y = 1$                       c  $y = -3$   
 d  $x = -4$                       e  $x = 5$                       f  $x = -2$   
 2 a, b, c and d

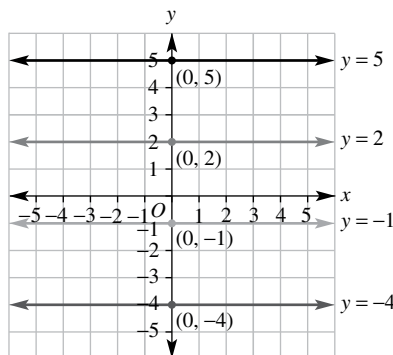

2 e, f, g and h

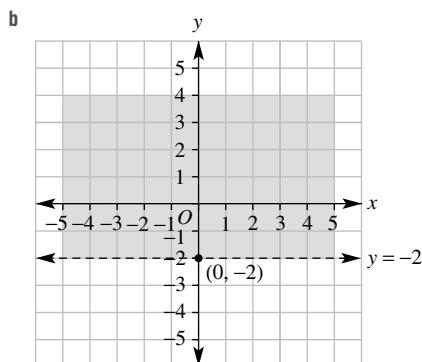
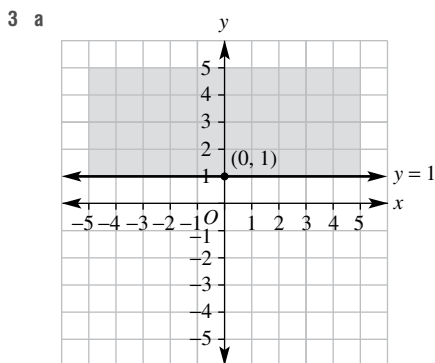
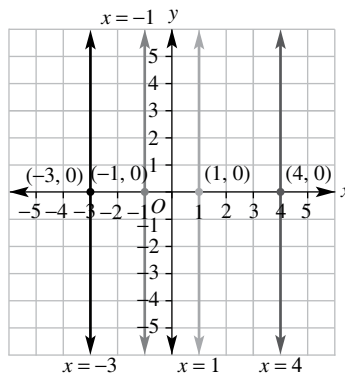

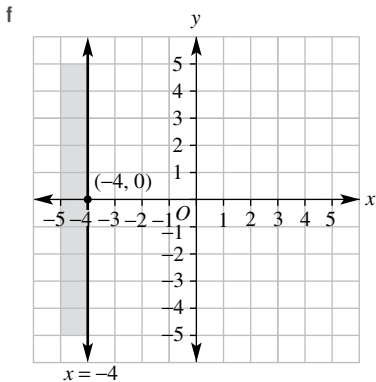
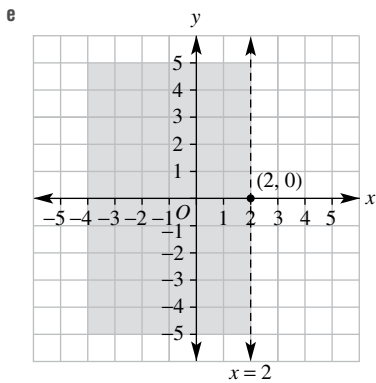
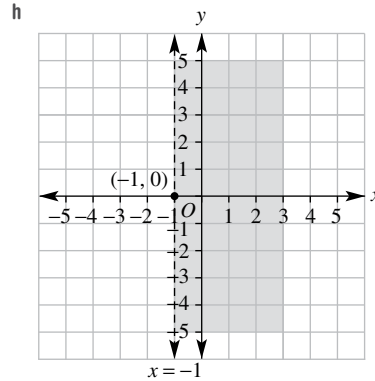
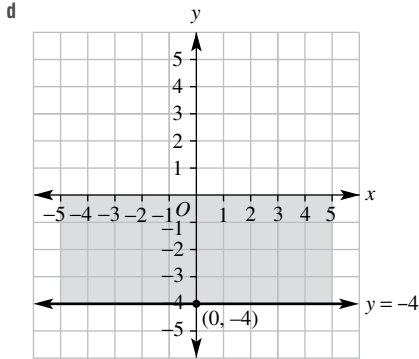
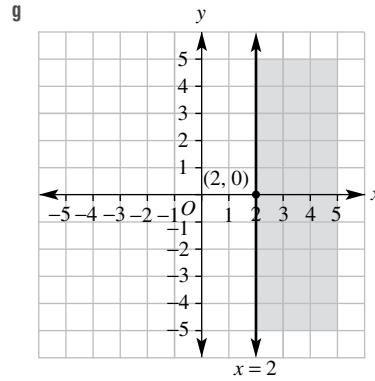
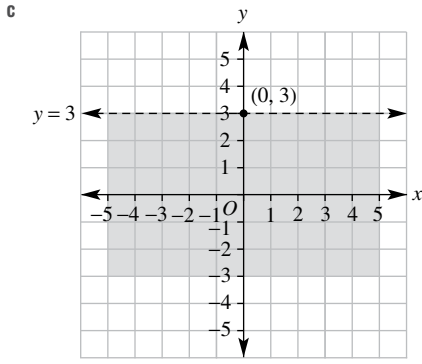

- 4 a  $x \geq 2$       b  $x < -1$       c  $x \leq 3$   
 d  $y > -4$       e  $y \leq 5$       f  $y \leq -1$
- 5 a  $x = 1$       b  $x = 0$
- 6 a  $x \leq 2$       b  $x \leq 1$       c  $x \geq 5$   
 d  $x > 2$       e  $x < 1$       f  $x > -1$
- 7 a  $x \leq 1$       b  $x \geq -2$       c  $x \leq -1$   
 d  $x < 1$       e  $x > 3$       f  $x > 2$
- 8 a E      b C      c B  
 d F      e A      f D
- 9 a  $x = -1$       b  $x = 2$       c  $x = 1.5$   
 d  $x > 1.5$       e  $x \leq 1.5$       f  $x \leq 1$
- 10 a Yes      b No      c No  
 d Yes      e No      f Yes  
 g No      h Yes      i No  
 j Yes      k Yes      l Yes
- 11 a 15 square units      b 40 square units
- 12 a It is a horizontal line passing through  $(0, 0)$ .  
 b It is a vertical line passing through  $(0, 0)$ .
- 13 a  $x \geq 2$       b  $x < 1.5$
- 14 a  $x \geq 2, x \leq 4, y \geq 1, y \leq 6$   
 b  $x \geq -3, x \leq 4, y \geq -4, y \leq -2$

15 a

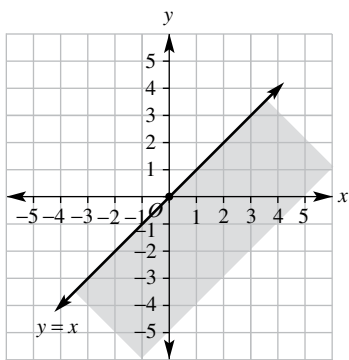

b

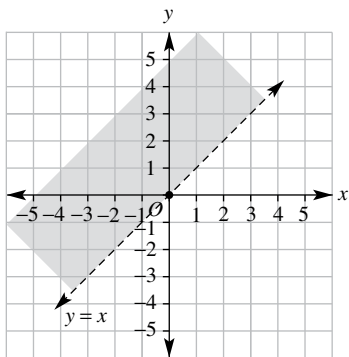

c

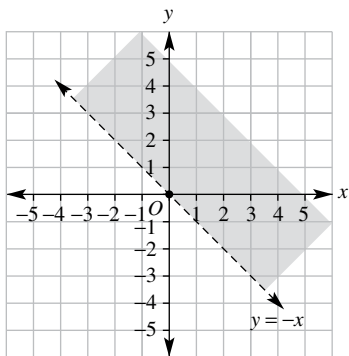

d

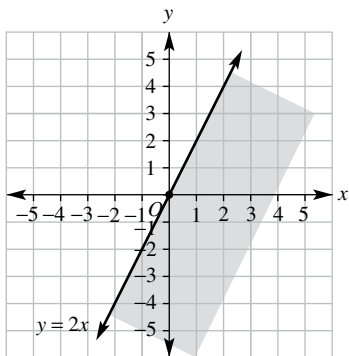

e

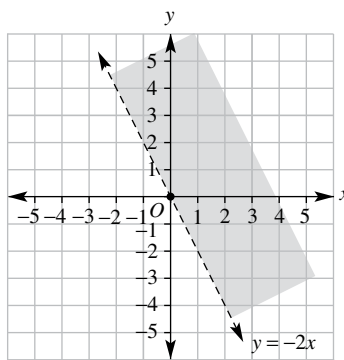

f

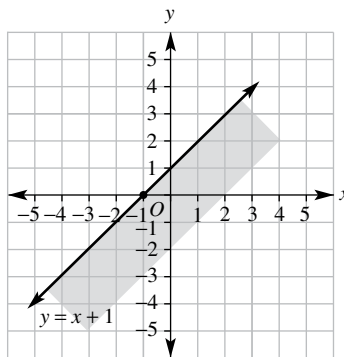

9F

Building understanding

- 1 a (2, 0) and (0, 3)
- c (7, 0) and (0, -4)
- 2 a  $x = -1, y = -2$
- 3 a 4
- b -2
- c -5
- d 4
- e  $-\frac{1}{3}$
- f -2
- b (-5, 0) and (0, 2)
- b  $x = 4, y = 4$

Now you try

Example 11

- a  $x = 5, y = -10$
- b  $x = \frac{2}{5}, y = 2$

Example 12

x-intercept is -2  
y-intercept is 6

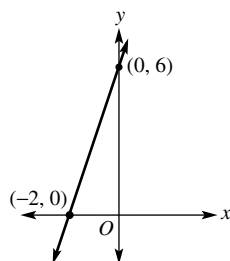

**Exercise 9F**

- 1 a (3, 0)                                  b (0, -15)  
 2 a (1, 0) and (0, 1)                    b (6, 0) and (0, -6)  
 c (-2, 0) and (0, 2)                    d (4, 0) and (0, -8)  
 e (3, 0) and (0, -12)                    f (-2, 0) and (6, 0)  
 3 a ( $\frac{5}{2}$ , 0) and (0, -5)                  b ( $\frac{7}{3}$ , 0) and (0, -7)  
 c (2, 0) and (0, 4)                      d (2, 0) and (0, 8)  
 e ( $\frac{3}{2}$ , 0) and (0, 6)                      f ( $-\frac{8}{3}$ , 0) and (0, -8)

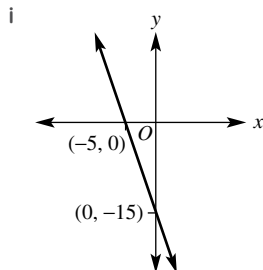
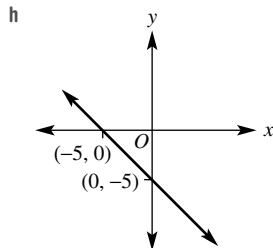
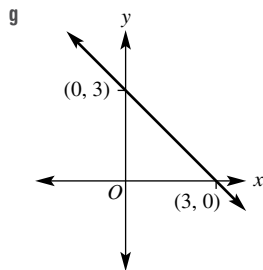
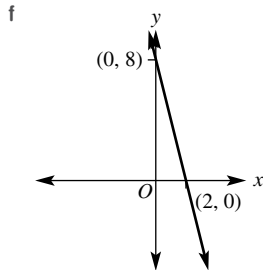
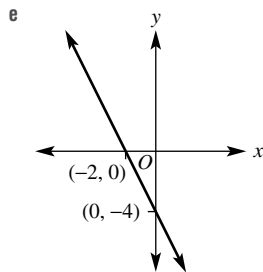
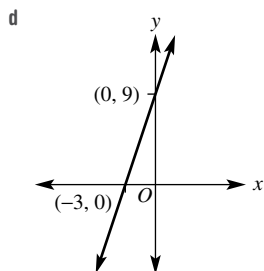
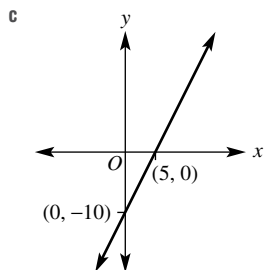
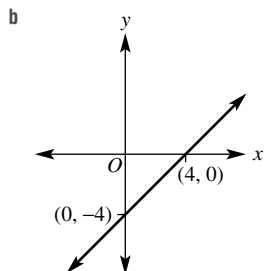
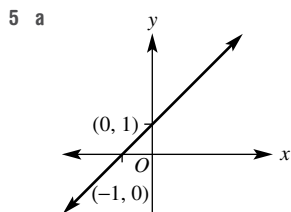
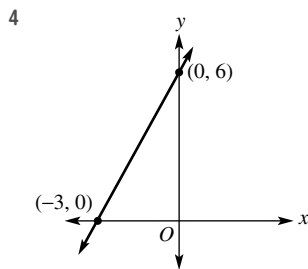

- 6 a 4 square units  
 b 1.5 square units  
 c 12.5 square units  
 d 8 square units  
 7 a (0, 5)  
 b  $y = 4x + 5$ ,  $y = -3x + 5$ , others possible.  
 8 a (2, 0)  
 b  $y = 4x - 8$ ,  $y = 5x - 10$ , others possible.  
 9 x-intercept is  $(-2, 0)$   
 y-intercept is  $(0, 4)$ .

- 10 a 20 cm                      b 10 seconds  
 11 a 200 cents                b 200 seconds  
 12 Horizontal lines; e.g.  $y = 2$ ,  $y = -5$   
 13 a  $x$ -int and  $y$ -int at  $(0, 0)$   
     b  $y = 5x$ ,  $y = -4x$ , others possible.  
 14  $(-\frac{c}{m}, 0)$

15 Answers may vary.

- 16 a 6                      b 4                      c -2  
     d 3                      e  $-\frac{2}{3}$                       f  $\frac{3}{2}$   
     g -2                      h  $\frac{3}{2}$                       i  $\frac{1}{3}$

**Progress quiz**

- 1 A(2, 3), B(3, 0)  
 C(1, -3), D(-3, -4)  
 E(-4, -1), F(-2, 0)  
 G(-3, 4)

2

x	-2	-1	0	1	2
y	-3	-1	1	3	5

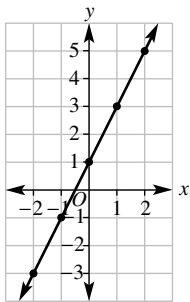

- 3 a i Yes                      ii No  
     b i No                      ii Yes  
 4 a  $y = 3x - 1$                       b  $y = -2x + 2$   
 5  $y = -2x + 1$

x	-1	0	1	2
y	3	1	-1	-3

- 6 a  $x = 1$                       b  $x = -1$                       c  $x = 0$   
 7 a Answers may vary.  
     i  $(-1, 3)$ ,  $(0, 2)$ ,  $(1, 1)$ ,  $(2, 0)$   
     ii  $(-2, 1)$ ,  $(-1, 3)$ ,  $(0, 5)$ ,  $(1, 7)$   
     b  $(-1, 3)$   
     c  $x = -1$

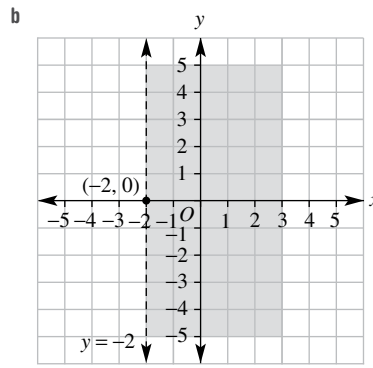
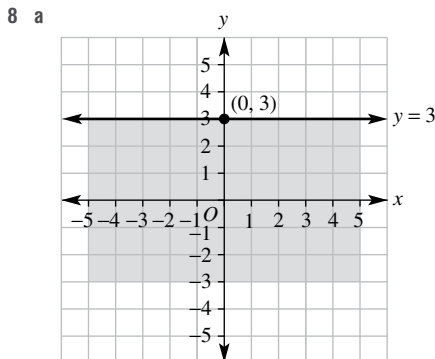

- 9 a  $x > -1$                       b  $x \geq -4$   
 10 a  $(3, 0)$                       b  $(\frac{1}{3}, 0)$

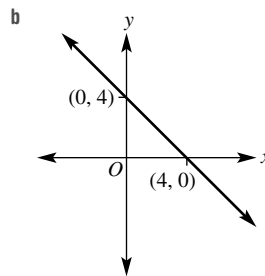
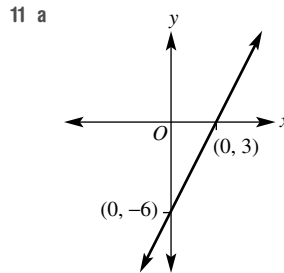

- 12 a 30 cm                      b 15 seconds

**9G**

**Building understanding**

- 1 a Positive                      b Negative  
     c Negative                      d Positive  
 2 a 2                      b  $\frac{3}{2}$   
     c -2                      d  $-\frac{8}{3}$   
 3 a 2                      b  $\frac{2}{3}$   
     c -4                      d  $-\frac{2}{5}$

**Now you try**

- Example 13  
 a Zero gradient                      b Positive gradient  
 c Negative gradient                      d Undefined gradient

Example 14

- a  $\frac{2}{5}$  or 0.4  
 b -2

**Exercise 9G**

- 1 a Zero  
c Positive  
2 a Positive  
c Zero  
3 a 3  
d 3  
4 a -2  
d -1  
5 Grassy slope  
6 Torpedo  
7 a  $\frac{3}{4}$   
c  $-\frac{3}{2}$   
8 a  $\frac{5}{2}$   
d  $-\frac{2}{3}$   
9 Answers may vary. Examples:  
a (1, 3), (2, 6), (3, 9)  
b (-1, -3), (-2, -6), (-3, -9)  
10 a Answers may vary, e.g.  $y = 7x$   
b Answers may vary, e.g.  $y = -2x$   
c The gradient is positive if the coefficient is positive and negative if it is negative (in fact, the gradient is equal to the coefficient).  
11 a 2  
c  $b = 2a$   
12 a  $-\frac{1}{2}$   
c  $b = -\frac{a}{2}$   
13 a  $\frac{2}{3}$   
d  $\frac{4}{3}$   
g  $-\frac{8}{9}$   
j  $-\frac{8}{33}$   
b 1  
e  $\frac{2}{3}$   
b  $\frac{5}{2}$   
d  $-\frac{7}{10}$   
b  $\frac{5}{3}$   
e  $\frac{8}{3}$   
c  $\frac{1}{2}$   
f 4  
c  $-\frac{4}{3}$   
f  $-\frac{3}{2}$   
c  $-\frac{8}{3}$   
f  $-\frac{3}{10}$   
b 10  
d  $a = \frac{b}{2}$   
b  $-\frac{3}{2}$   
d  $a = -2b$   
c  $\frac{8}{9}$   
f 4  
i  $-\frac{2}{7}$   
k  $-\frac{18}{25}$

**9H**

**Building understanding**

- 1 a  $y = 2x + 3$   
c  $y = -5x - 3$   
2 a  $c = 1, m = 2$   
c  $c = 3, m = -1$   
b  $y = -3x + 1$   
b  $c = -1, m = -1$

**Now you try**

Example 15

- a Gradient = 5, y-intercept = (0, 2)  
b Gradient =  $\frac{2}{7}$ , y-intercept = (0, -5)

Example 16

- a  $y = 2x - 3$   
b  $y = -3x + 6$

**Exercise 9H**

- 1 a i  $m = 4, (0, 3)$   
b i  $m = \frac{1}{2}, (0, -3)$   
ii  $m = 6, (0, -1)$   
ii  $m = -\frac{2}{3}, (0, 1)$   
2 a  $m = 4, (0, 2)$   
c  $m = \frac{1}{2}, (0, 1)$   
e  $m = -2, (0, 3)$   
g  $m = -1, (0, -6)$   
b  $m = 3, (0, 7)$   
d  $m = \frac{2}{3}, (0, \frac{1}{2})$   
f  $m = -4, (0, 4)$   
h  $m = -\frac{2}{3}, (0, -\frac{1}{2})$   
3 a  $y = 2x - 1$   
c  $y = 3x + 3$   
e  $y = 2x + 1$   
4 a  $y = -x + 2$   
c  $y = -3x - 1$   
e  $y = -5x - 2$   
5 a  $y = \frac{2}{5}x + 2$   
c  $y = \frac{1}{3}x - \frac{3}{4}$   
6  $y = 4x + 1, y = 3x - 11, y = 2x + 5, y = x + 10$ .  
7 a  $y = 3x + 4$   
c  $y = -4x - 1$   
8 a  $y = 3x$   
c  $y = -x + 3$   
9 a  $y = 2x + 3$   
c  $y = -x + 2$   
10 a Both have gradient = 2.  
b  $y = 3x + 8$   
11 a

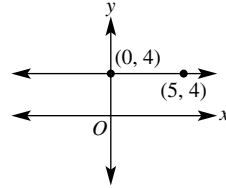

- b 0  
c (0, 4)  
d  $y = 0x + 4$   
e  $y = 4$ . It is a horizontal line.  
12 a  $y = \frac{b}{a}x$   
c  $y = -\frac{a}{b}x + a$   
b  $y = -x$   
13 a  $m = -3, c = 5$   
c  $m = \frac{3}{2}, c = 4$   
b  $m = 2, c = 3$   
d  $m = \frac{1}{2}, c = 3$

14 a

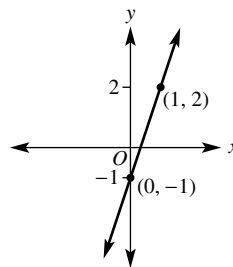

b

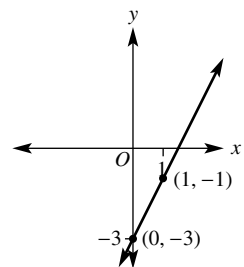



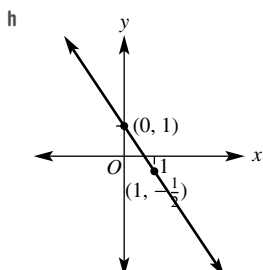
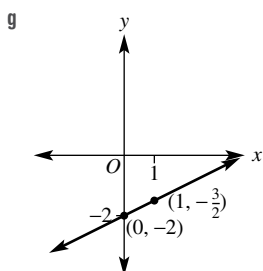
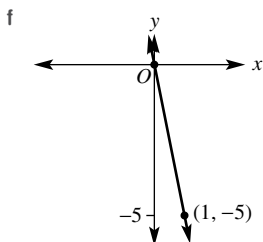
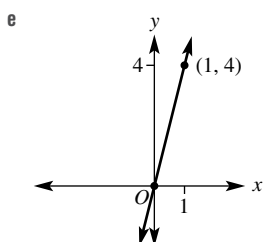
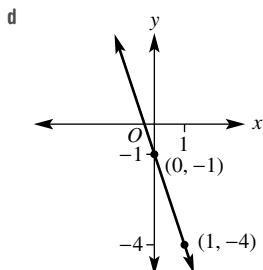
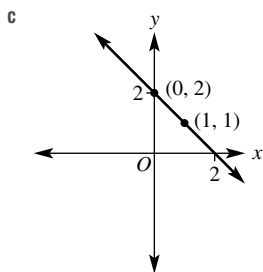

9I

Building understanding

- 1 a 15                      b 45                      c 5                      d 125  
 2 a 60 cm                b 150 cm              c 330 cm  
 3 a 28 L                    b 24 L                    c 10 L

Now you try

Example 17

a

$t$	0	1	2	3	4
$d$	0	20	40	60	80

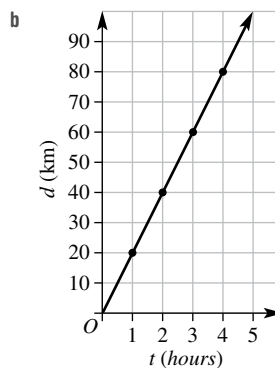

- c  $d = 20t$   
 d 50 km  
 e 3 hours

Example 18

a

$t$	0	1	2	3	4	5	6
$V$	60	50	40	30	20	10	0

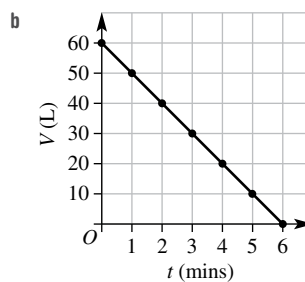

- c  $V = -10t + 60$  (or  $V = 60 - 10t$ )  
 d 25 L  
 e 5.5 minutes

Exercise 9I

1 a

$t$	0	1	2	3
$d$	0	6	12	18

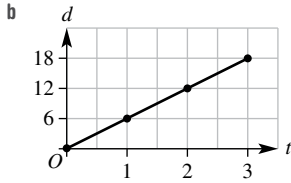

- c  $d = 6t$   
 d 9 km  
 e 2 hours

2 a

$t$	0	1	2	3	4	5	6	7	8
$d$	0	5	10	15	20	25	30	35	40

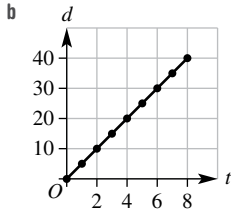

- c  $d = 5t$   
 d 22.5 km  
 e 4 hours

3 a

$t$	0	1	2	3	4	5
$v$	20	16	12	8	4	0

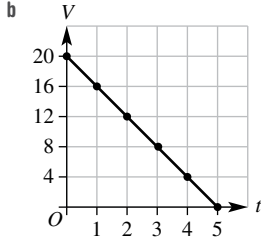

- c  $v = -4t + 20$   
 d 11.2 L  
 e 3 seconds

4 a

$t$	0	1	2	3	4
$h$	500	375	250	125	0

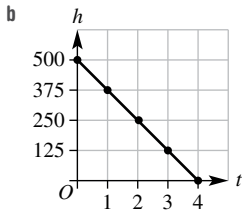

- c  $h = -125t + 500$   
 d 275 m  
 e 3 minutes
- 5 a  $M = -0.5t + 3.5$       b 7 hours  
 c 4.5 hours
- 6 a  $d = 15t$       b 3 hours  
 c 3 hours 20 minutes

- 7 2 days 15 hours
- 8 a 2000 L  
 b Decreasing; it has a negative gradient.  
 c 300 L/h
- 9 a 10 m  
 b Down, negative gradient (or sub  $t = 1$  to see  $h = 8$ )  
 c 4 metres  
 d Gives a negative answer, so the balloon probably stopped falling when height = 0  
 e  $h = 20 - 2t$ .
- 10 a Using cents,  $m = \frac{1}{2}$  and  $c = 10$ .  
 b Using dollars,  $m = 0.005$  and  $c = 0.1$ .

11 a

$t$	0	1	2	3	4	5	6	7	8	9	10
$h_1$	0	15	30	45	60	75	90	105	120	135	150
$h_2$	100	90	80	70	60	50	40	30	20	10	0

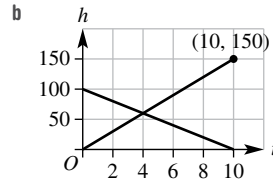

- c 10 seconds  
 d  $h = 15t$ ,  $h = -10t + 100$   
 e At 4 seconds  
 f At 2.5 seconds  
 g At 3.5 seconds  
 h No, 60 m, 60 m and 50 m

9J

Building understanding

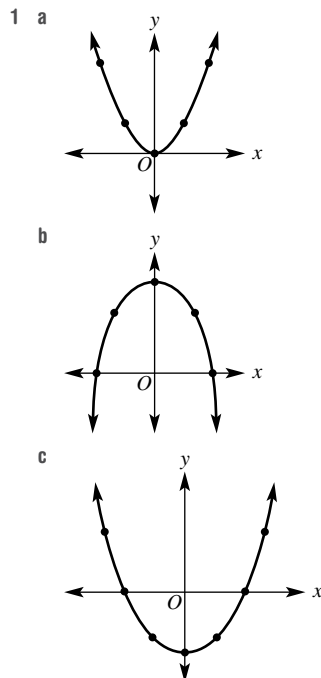

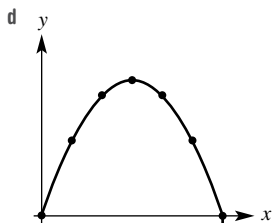

- 2 a -1                      b 8                      c 15  
 3 a Yes                    b No                    c No                    d Yes

**Now you try**

Example 17

<i>x</i>	-3	-2	-1	0	1	2	3
<i>y</i>	10	5	2	1	2	5	10

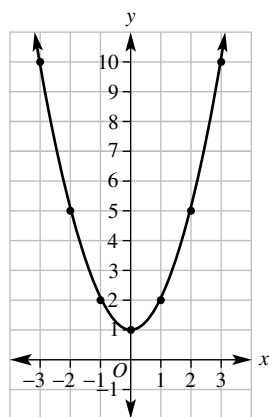

**Exercise 9J**

1

<i>x</i>	-3	-2	-1	0	1	2	3
<i>y</i>	8	3	0	-1	0	3	8

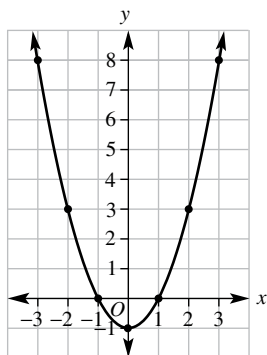

From  $y = x^2 - 1$

2 a  $y = x^2$

<i>x</i>	-3	-2	-1	0	1	2	3
<i>y</i>	9	4	1	0	1	4	9

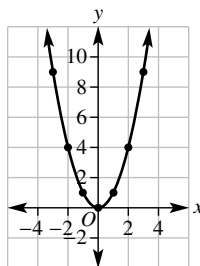

b  $y = x^2 - 4$

<i>x</i>	-3	-2	-1	0	1	2	3
<i>y</i>	5	0	-3	-4	-3	0	5

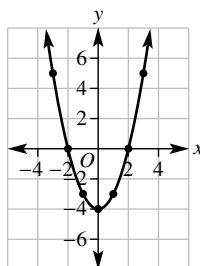

c  $y = x(4 - x)$

<i>x</i>	0	1	2	3	4
<i>y</i>	0	3	4	3	0

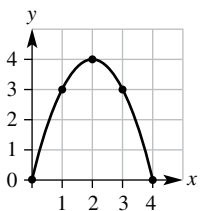

d  $y = 5 - x^2$

<i>x</i>	-3	-2	-1	0	1	2	3
<i>y</i>	-4	1	4	5	4	1	-4

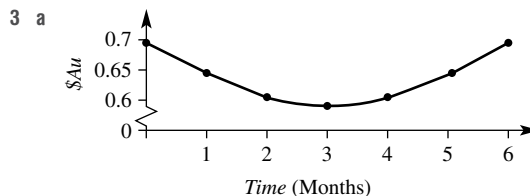
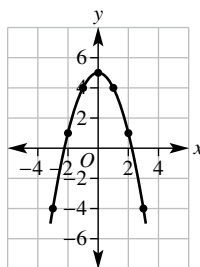

- b Non-linear (parabolic)  
 c i \$0.05                      ii \$0.03  
 d  $\approx 0.76$

4 a

<b>Width (cm)</b>	0	1	2	3	4
<b>Length (cm)</b>	4	3	2	1	0
<b>Area (cm<sup>2</sup>)</b>	0	3	4	3	0

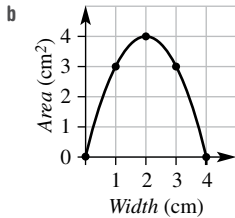

- c Non-linear (parabolic)  
 d 2 cm by 2 cm

5 a

<b>Width (cm)</b>	1	2	3	4	6	12
<b>Length (cm)</b>	12	6	4	3	2	1
<b>Perimeter (cm)</b>	26	16	14	14	16	26

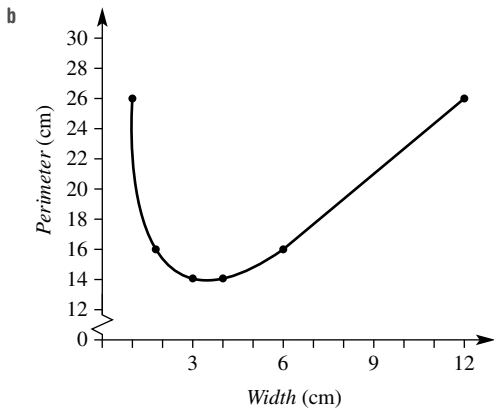

- c Non-linear  
 d i  $\approx 3.5$  cm                      ii  $\approx 13.9$  cm
- 6 a 0 and 9  
 b  $-10$  and  $-1$   
 c  $-3$  and  $6$
- 7 For each unit change in  $x$  there are variable changes in  $y$ .
- 8 a Linear  
 b Linear  
 c Non-linear  
 d Non-linear  
 e Non-linear  
 f Non-linear
- 9 16

- 10 a Upright parabolas, as  $a$  increases the graphs become narrower.  
 b Inverted (upside down) parabolas, as  $a$  increases the graphs become narrower.  
 c Parabolas, as  $a$  increases the graphs shift up.  
 d Parabolas, as  $a$  increases the graphs shift right.

**Problems and challenges**

- 1 3 hours  
 2 a  $y = x^2 - 3$   
 b  $y = 10 - x^2$   
 c  $y = \sqrt{x} + 1$   
 d  $y = x^3 - 3$
- 3  $-\frac{1}{3}$   
 4 40 min  
 5  $\frac{14}{3}$   
 6  $y = \frac{1}{2}x + \frac{1}{2}$   
 7 1588  
 8 4 hours 45 minutes  
 9 60 units<sup>2</sup>  
 10 a Diagonal  $AC$  has been rotated about  $A$  by  $90^\circ$  clockwise so the angle between  $AC$  and  $AC'$  is  $90^\circ$ .

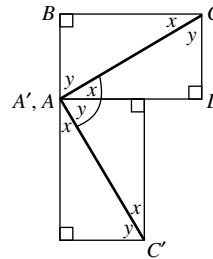

$$x + y + 90^\circ = 180^\circ$$

$$x + y = 90^\circ$$

b  $\frac{p}{q} \times \frac{-q}{p} = -1$

**Chapter checklist with success criteria**

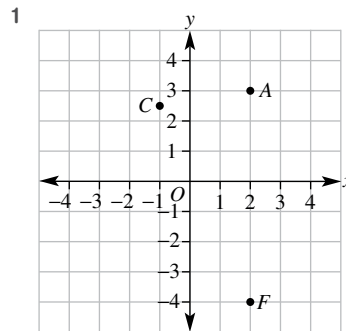

2	x	-3	-2	-1	0	1	2	3
	y	-7	-5	-3	-1	1	3	5

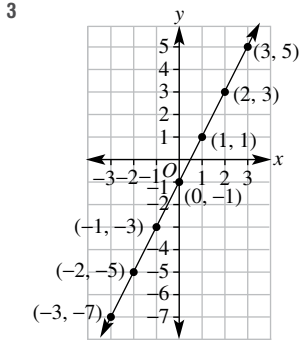

- 4 (1, 3) is on the graph; (-2, -4) is not on the graph  
 5  $y = -2x + 1$   
 6  $y = x - 2$   
 7  $x = 2$   
 8  $x = 1$   
 9  $x = 7$

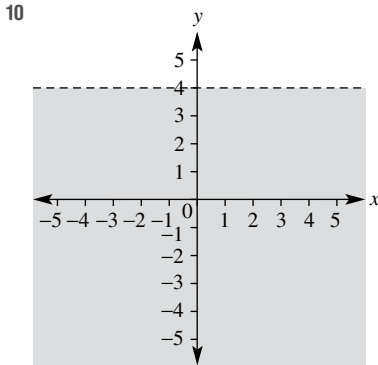

- 11  $x < 3$   
 12 x-intercept is  $(\frac{1}{2}, 0)$ ; y-intercept is (0, 1)  
 13 x-intercept is (4, 0); y-intercept is (0, -8)

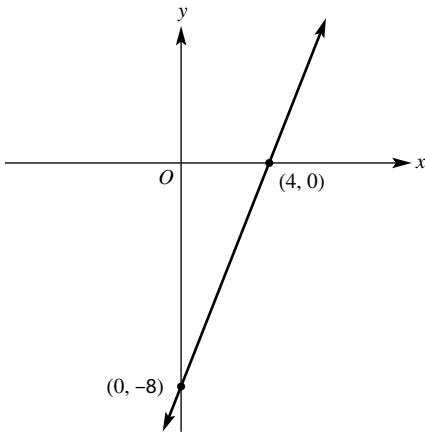

- 14 a negative gradient;  
 b undefined gradient;  
 c positive gradient;  
 d zero gradient

- 15  $\frac{3}{2}$   
 16 Gradient =  $\frac{1}{3}$ ; y-intercept = -4  
 17  $y = 4x - 1$

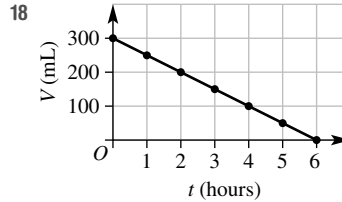

$V = -50t + 300$ ; 4.5 hours

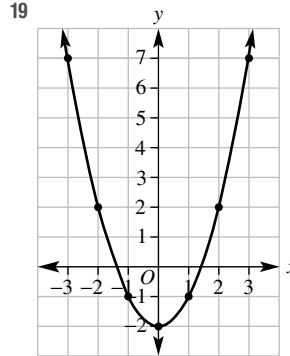

### Chapter review

#### Short-answer questions

- 1 a 100 km  
 c i 50 km  
 d Section C  
 b 1 hour  
 ii 100 km  
 2 A(2, 3), B(0, 2), C(-2, 4), D(-3, 1), E(-3, -3), F(-1, 0), G(0, -4), H(1, -2), I(4, -3), J(3, 0)  
 3 a

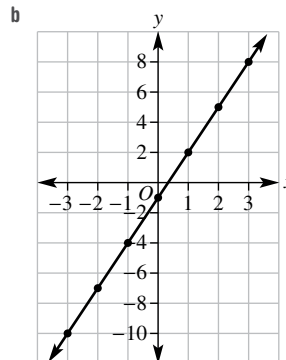
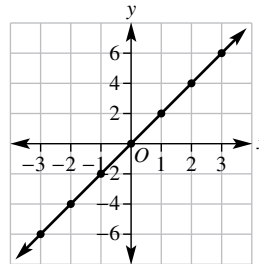

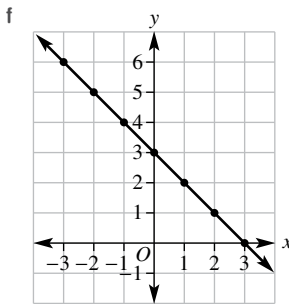
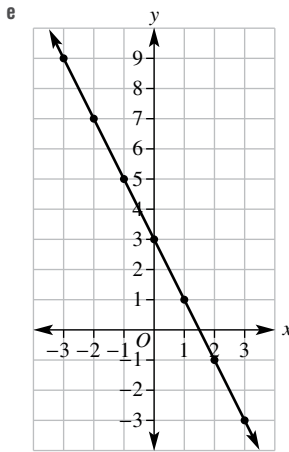
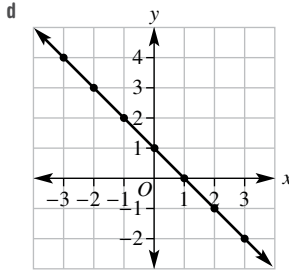
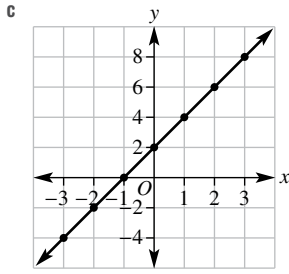

- 4 a  $y = 2x + 1$   
 b  $y = 3x + 2$   
 c  $y = x + 3$   
 d  $y = -x + 1$   
 e  $y = -4x - 1$   
 f  $y = -x + 2$
- 5 a  $x = 2$   
 b  $x = -2$   
 c  $x = \frac{1}{2}$

- 6 a  $x = 6$   
 b  $x = 4$   
 c  $x = -4$   
 d  $y = -5$   
 e  $y = -1$   
 f  $y = 5$

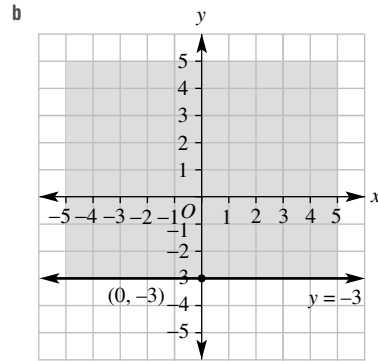
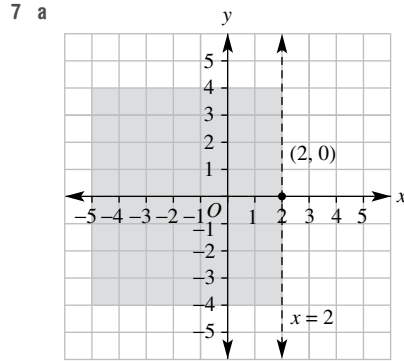

- 8 a  $x < 2$   
 b  $x \leq -1$
- 9 a (6, 0) and (0, -12)  
 b (-3, 0) and (0, 9)  
 c (-4, 0) and (0, -4)  
 d (2, 0) and (0, 8)

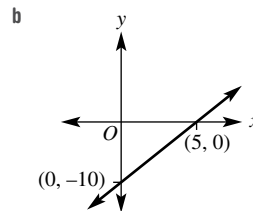
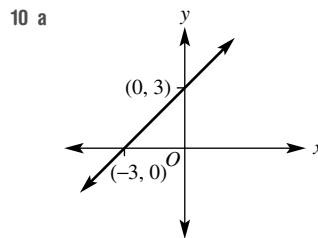

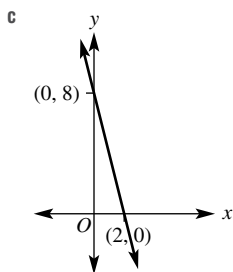

- 11 a 3  
 b  $\frac{1}{2}$   
 c 2  
 d -1  
 e -4  
 f  $-\frac{3}{2}$
- 12 a -4  
 b  $-\frac{1}{2}$   
 c 1  
 d -2
- 13 a  $m = 5, (0, 2)$   
 b  $m = 2, (0, -4)$   
 c  $m = -3, (0, 7)$   
 d  $m = -1, (0, -\frac{1}{2})$

- 14 a  $y = 2x + 1$   
 b  $y = 3x$   
 c  $y = x - 2$   
 d  $y = -4x$   
 e  $y = -2x - 4$   
 f  $y = -\frac{1}{2}x + 1$

- 15 a  $y = 6x$   
 b  $y = -4x$   
 c  $y = -x + 1$   
 d  $y = \frac{1}{2}x - 2$

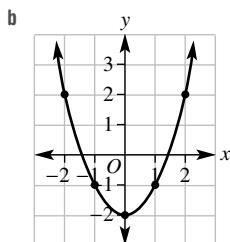
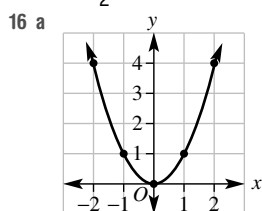

Multiple-choice questions

- 1 B  
 2 C  
 3 C  
 4 D  
 5 B  
 6 D  
 7 D  
 8 A  
 9 E  
 10 E

Extended-response questions

1 a

$t$	0	1	2	3	4	5	6
$h$	0	3	6	9	12	15	18

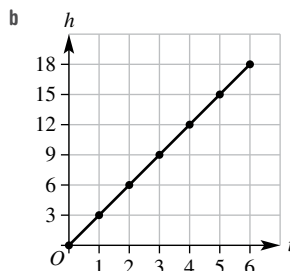

- c  $h = 3t$   
 d 10.5 mm  
 e 30 mm  
 f 5 days

2 a

$t$	0	1	2	3	4	5	6
$h$	12	10	8	6	4	2	0

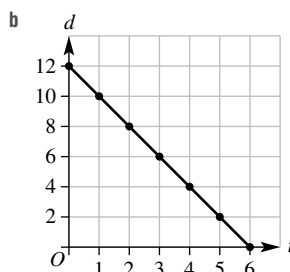

- c 6 minutes  
 d -2  
 e  $d = -2t + 12$   
 f 7 km  
 g 4 minutes 15 seconds

### Chapter 10

#### 10A

##### Building understanding

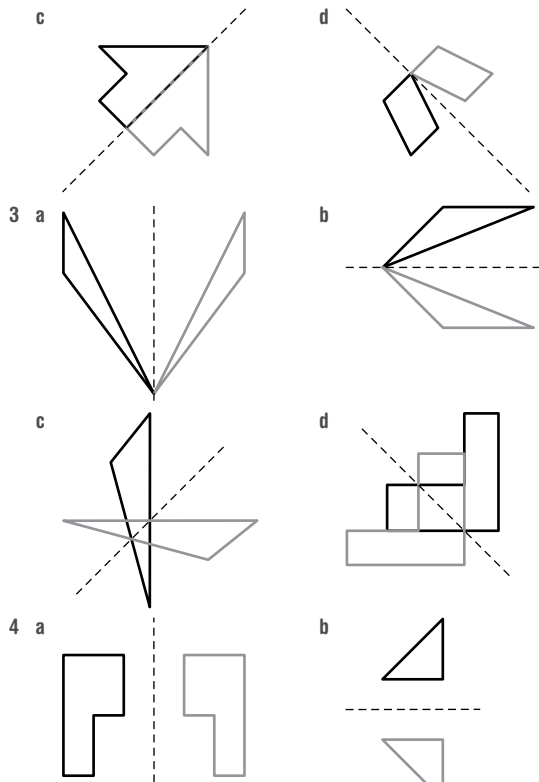
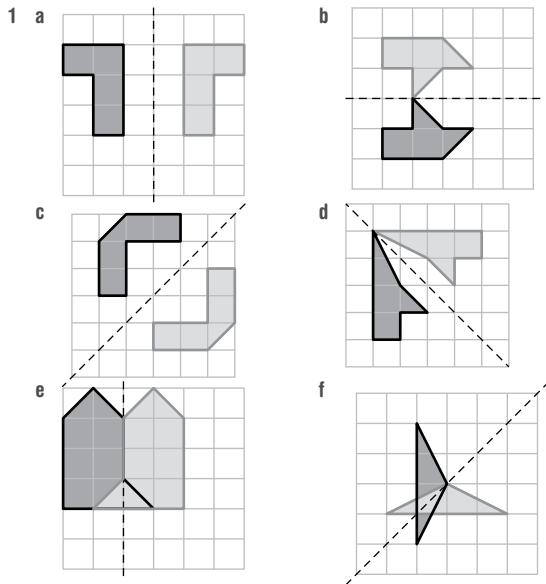

##### Now you try

###### Example 1

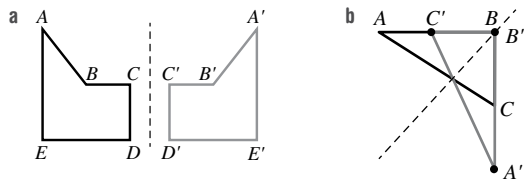

###### Example 2

- a  $A' = (1, -2), B' = (3, -3), C' = (4, -1)$
- b  $A' = (-1, 2), B' = (-3, 3), C' = (-4, 1)$

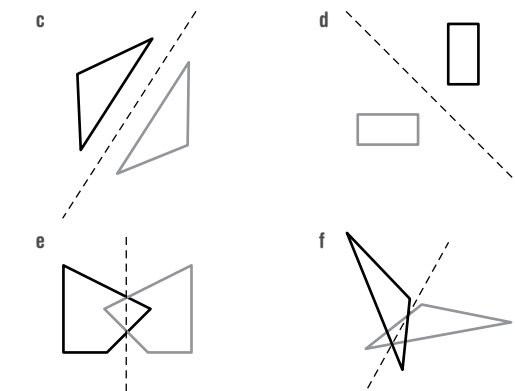

##### Exercise 10A

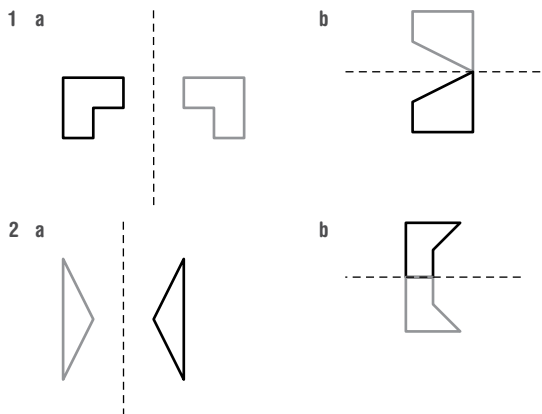

- 5 a  $A'(2, 0), B'(1, -3), C'(4, -2)$
- b  $A'(-2, 0), B'(-1, 3), C'(-4, 2)$
- 6 a  $A'(-1, 2), B'(-4, 2), C'(-4, 4), D'(-1, 4)$
- b  $A'(1, -2), B'(4, -2), C'(4, -4), D'(1, -4)$
- 7 a 4                                  b 2                                  c 2
- d 1                                  e 0                                  f 0
- g 1                                  h 3                                  i 8
- 8 a (0, 4)                              b (4, 4)                              c (-2, 4)
- d (-4, 4)                            e (-10, 4)                            f (-42, 4)
- g (2, 2)                              h (2, -8)                              i (2, -4)
- j (2, -2)                              k (2, -14)                              l (2, -78)
- 9 10 m<sup>2</sup>, the area is unchanged after reflection.
- 10 //



11 Reflection in the y-axis.

12 a

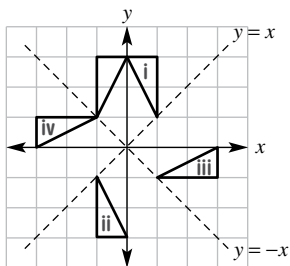

b

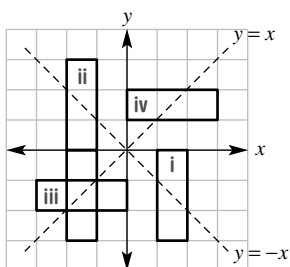

13 They are on the mirror line.

14 a i



ii

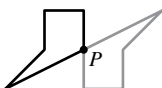

iii

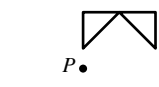

b i Yes

ii No

iii Yes

c Square, rectangle, rhombus, parallelogram

10B

Building understanding

- 1 a right, up                                      c right, down
- b left, up                                     d left, down
- 2 a (5, -2)                                      b (-2, -6)
- c (-7, 4)                                     d (9, 17)
- 3 a Horizontal                                  b Vertical
- c Vertical                                     d Horizontal

Now you try

Example 3  
(-3, -2)

Example 4

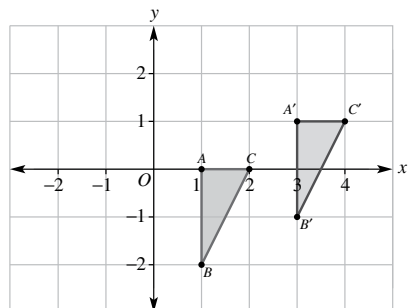

Exercise 10B

- 1 a (4, -1)                                      b (-2, -2)
- 2 a (1, -1)                                      b (3, -1)                                      c (2, -2)
- d (2, -4)                                      e (3, 7)                                        f (-3, 5)
- g (2, -3)                                      h (3, -5)                                      i (-20, 8)

3 a

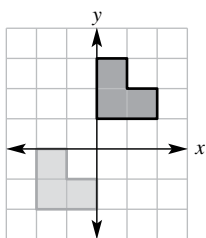

b

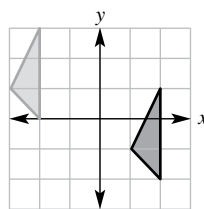

c

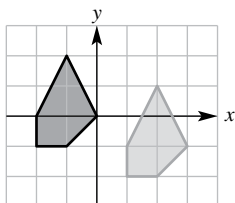

d

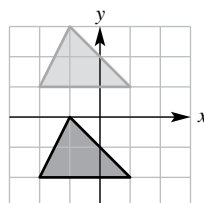

e

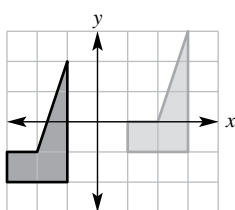

f

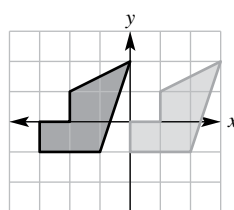

- 4 a (15, 2)                                      b (21, -1)                                      c (13, 6)
- d (9, 2)                                        e (11, -2)                                      f (3, 4)
- g (11, -9)                                     h (19, -10)                                    i (25, -4)
- j (-13, 13)                                    k (9, 17)                                        l (-8, -39)
- 5 a (7, 0)                                        b (-1, -4)
- 6 a (-2, -3)                                    b (2, 3)
- 7 a  $x = -2, y = -2$                               b  $x = 6, y = -4$
- c  $x = -3, y = 2$                               d  $x = 28, y = -60$
- 8 a (-3, 2)                                      b (5, 0)
- c  $(-x, -y)$                                     d  $(x, y)$
- 9 a (-1, 0)                                      b (1, 2)                                        c  $(c, b - c)$
- 10 a

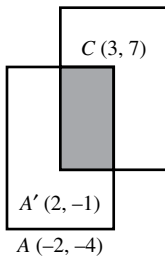

- b The original rectangle has width 5, so there is no overlap when it is shifted 6 units right.
- c Vector (5, 0) is the smallest vector to avoid overlap (the line in common from (3, -4) to (3, 7) has area 0.)
- 11 a  $x \approx 4.47$                                     b Just OK                                        c 80 holes

10C

Building understanding

- 1 a Anticlockwise,  $90^\circ$   
 c Anticlockwise,  $90^\circ$   
 e Anticlockwise,  $180^\circ$   
 2 a  $270^\circ$   
 c  $302^\circ$   
 b Clockwise,  $90^\circ$   
 d Clockwise,  $90^\circ$   
 f Clockwise,  $180^\circ$   
 b  $180^\circ$   
 d  $64^\circ$

Now you try

Example 5

- a 2

Example 6

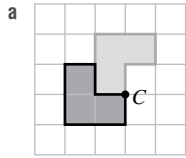

- b 6

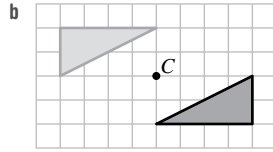

Exercise 10C

- 1 a 3  
 2 a 4  
 d 2  
 b 2  
 e 4

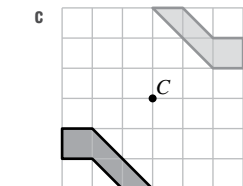
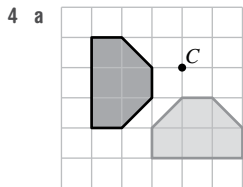
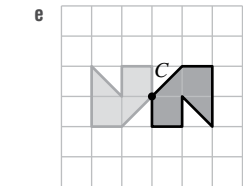
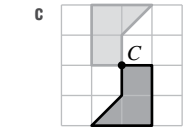
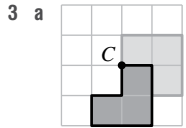

- b 4  
 c 5  
 f 2

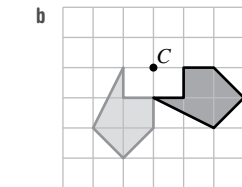
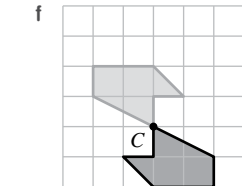
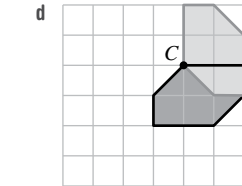
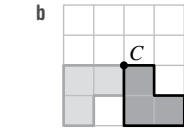

- 5 a  $(-4, -3)$  b  $(-4, -3)$  c  $(3, -4)$   
 d  $(-3, 4)$  e  $(-3, 4)$  f  $(3, -4)$   
 g  $(4, 3)$

- 6 a  $A'(4, -4), B'(4, -1), C'(1, -1)$   
 b  $A'(4, 4), B'(1, 4), C'(1, 1)$   
 c  $A'(-4, -4), B'(-1, -4), C'(-1, -1)$

- 7 a  $90^\circ$  b  $180^\circ$  c  $90^\circ$

8 H, I, N, O, S, X and Z

9 Answers may vary. Examples are:

- a Parallelogram  
 b Regular hexagon  
 c

- 10 a  $180^\circ$  b  $90^\circ$

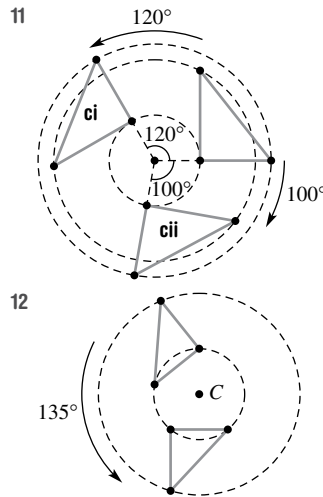

- 12  
 13 a Use  $x = 70^\circ$  b Use  $x = 40^\circ$   
 c Answers may vary.

10D

Building understanding

- 1 a Yes  
 b i D ii E iii F  
 c i DE ii EF iii DF  
 d i  $\angle E$  ii  $\angle F$  iii  $\angle D$   
 2 a Yes  
 b i D ii E iii F  
 c i DE ii EF iii DF  
 d i  $\angle E$  ii  $\angle F$  iii  $\angle D$   
 3 a Yes  
 b i D ii E iii F  
 c i DE ii EF iii DF  
 d i  $\angle E$  ii  $\angle F$  iii  $\angle D$

**Now you try**

Example 7

- a Vertex  $H$       b Side  $GF$       c  $\angle E$

**Exercise 10D**

- 1 a i  $E$       ii  $H$   
 b i  $EH$       ii  $GH$   
 c i  $\angle G$       ii  $\angle E$
- 2 a i  $F$       ii  $I$   
 b i  $FJ$       ii  $HI$   
 c i  $\angle H$       ii  $\angle J$
- 3  $(J, G), (D, K), (C, I)$
- 4  $(A, J), (C, K), (E, G)$
- 5 a 32      b 24      c 20  
 d 8      e 4
- 6 a  $(A, E), (B, D), (C, F)$   
 b  $(A, Y), (B, X), (C, W), (D, Z)$   
 c  $(A, W), (B, X), (C, Z), (D, Y)$   
 d  $(A, T), (B, Z), (C, X), (D, S), (E, W)$
- 7 a  $\triangle AMC, \triangle BMC$   
 b Yes, all corresponding sides and angles will be equal.
- 8 a i  $\triangle ABD, \triangle CBD$   
 ii Yes, all corresponding sides and angles will be equal.  
 b i  $\triangle ABC, \triangle ACD$   
 ii No, sides and angles will not be equal.
- 9 Yes, The line  $AC$  acts as a mirror line between the two triangles.
- 10 a Reflection in the  $y$ -axis then translation by the vector  $(1, -2)$   
 b Rotation anticlockwise about the origin by  $90^\circ$  then translation by the vector  $(6, 3)$   
 c Rotation about the origin by  $180^\circ$  then translation by the vector  $(-2, 1)$   
 d Reflection in the  $x$ -axis, reflection in the  $y$ -axis and translation by the vector  $(-2, 1)$   
 e Reflection in the  $x$ -axis, reflection in the  $y$ -axis and translation by the vector  $(3, 2)$   
 f Rotation about the origin by  $180^\circ$  then translation by the vector  $(3, 2)$

**10E**

**Building understanding**

- 1 a SSS      b RHS  
 c SAS      d AAS
- 2 a  $\triangle ABC \equiv \triangle EFD$       b  $\triangle ABC \equiv \triangle FED$

**Now you try**

Example 8

- a SAS  
 b SSS

Example 9

- a Unique by AAS

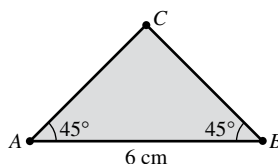

- b Unique by SSS

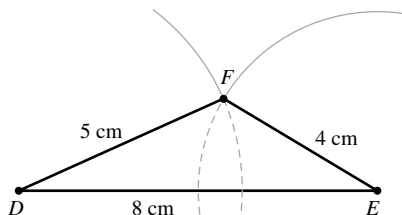

**Exercise 10E**

- 1 a SSS      b SAS
- 2 a SAS      b SSS      c RHS  
 d AAS      e RHS      f AAS
- 3 a Unique (AAS)      b Unique (SSS)  
 c Unique (RHS)      d Unique (SAS)  
 e Unique (SSS)      f Unique (AAS)  
 g Unique (SAS)      h Unique (AAS)  
 i Unique (AAS)      j Unique (RHS)
- 4 a  $x = 4, y = 1$       b  $x = 9, a = 20$   
 c  $x = 5, a = 24$       d  $x = 5, a = 30$   
 e  $x = 4, a = 95, b = 25$       f  $x = 11, a = 50, b = 90$
- 5 a No      b Yes, SAS  
 c Yes, AAS      d No
- 6 a  $EF = 3$  m      b  $\angle B = 30^\circ$   
 c  $AC = 6$  cm      d  $\angle C = 20^\circ$
- 7 a No      b Yes  
 c Yes      d No
- 8 Yes, show SSS using Pythagoras' theorem.
- 9 a You can draw two different triangles with SSA.

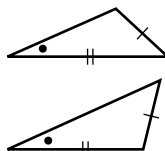

- b You can draw an infinite number of triangles with the same shape but of different size.
- 10 a  $\angle CAB = \angle CED$  (equal alternate angles)  
 $\angle ACB = \angle ECD$  (vertically opposite angles)  
 $AC = EC$  (given equal and corresponding sides)  
 $\therefore \triangle ABC \equiv \triangle EDC$  (AAS)
- b  $BD = BD$  (given and common equal side)  
 $\angle ADB = \angle CDB$  (given and equal angles)  
 $AD = CD$  (given equal sides)  
 $\therefore \triangle ADB \equiv \triangle CDB$  (SAS)

c  $\angle ACB = \angle CAD$  (equal alternate angles)  
 $\angle CAB = \angle ACD$  (equal alternate angles)  
 $AC = AC$  (given and common equal side)  
 $\therefore \triangle ABC \equiv \triangle CDA$  (AAS)

d  $\angle ABC = \angle ADC$  (given  $90^\circ$  angles)  
 $AC = AC$  (given and common equal side)  
 $BC = DC$  (given equal sides)  
 $\therefore \triangle ABC \equiv \triangle ADC$  (RHS)

11 a  $AB = AC$  (given equal sides)  
 $BM = CM$  (given equal sides)  
 $AM = AM$  (given and common equal side)  
 $\therefore \triangle ABM \equiv \triangle ACM$  (SSS)  
 $\therefore \angle AMB = \angle AMC$

As  $\angle AMB + \angle AMC = 180^\circ$  then

b  $\angle AMB = \angle AMC = 90^\circ$ .  
 $\angle AEB = \angle CDB$  (equal alternate angles)  
 $\angle EAB = \angle DCB$  (equal alternate angles)  
 $EB = BD$  (given equal sides)  
 $\therefore \triangle AEB \equiv \triangle CDB$  (AAS)

$\therefore AB = BC$  and  $AC = 2AB$

c  $AD = DC$  (given equal sides)  
 $AB = CB$  (given equal sides)  
 $BD$  is a common side  
 $\therefore \triangle ABD \equiv \triangle CBD$  (SSS)  
 $\therefore \angle DAB = \angle DCB$

d  $\triangle ACD \equiv \triangle ACB$  (SSS)  
 so  $\angle DCA = \angle BCA$   
 Now  $\triangle DCE \equiv \triangle BCE$  (AAS)  
 with  $\angle CDE = \angle CBE$  (isosceles triangle)  
 So  $\angle DEC = \angle BEC$   
 Since  $\angle DEC$  and  $\angle BEC$  are supplementary (sum to  $180^\circ$ )  
 So  $\angle DEC = \angle BEC = 90^\circ$   
 So diagonals intersect at right angles.

Progress quiz

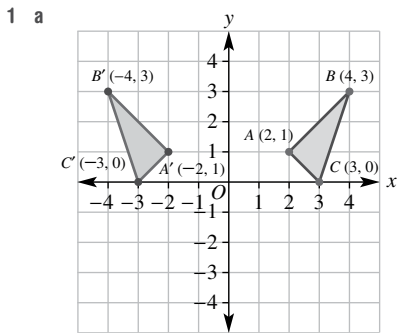

b  $A'(2, -1)B'(4, -3)C'(3, 0)$

2 a (3, 5) b (4, -2)  
 3

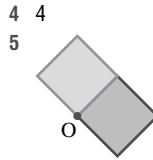
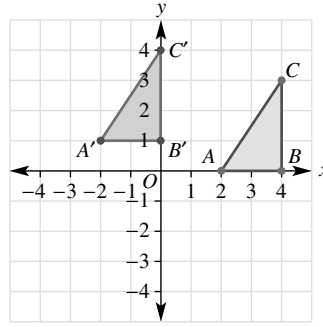

6  $A'(0, 2)B'(0, 4)C'(-3, 4)$   
 7 a SAS b  $\triangle ACB \equiv \triangle QPR$  (SAS)  
 c QR d Angle BCA  
 8  $\angle ABE = \angle CBD$  (vertically opposite)  
 $AB = CB$  (given)  
 $EB = DB$  (given)  
 $\therefore \triangle ABE \equiv \triangle CBD$  (SAS)

10F

Building understanding

1 C 2 D 3 Overlaps exist

Now you try

Example 10

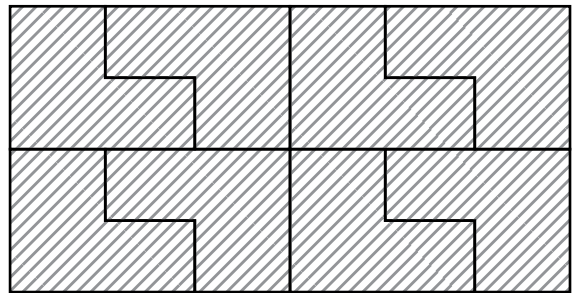

Example 11  
4.8.8

**Exercise 10F**

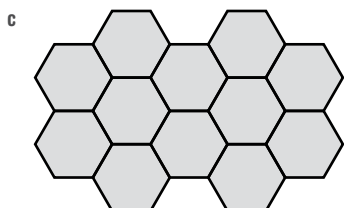
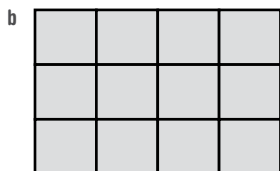
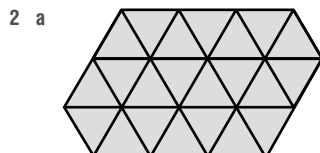

- 3 a Yes                      b No                      c Yes  
 d No                      e Yes                      f No
- 4 a 3.3.3.4.4                      b 3.3.4.3.4  
 c 3.4.6.4                      d 3.12.12

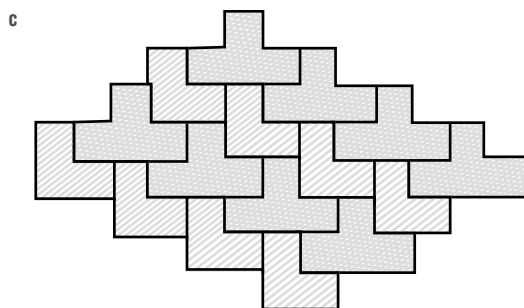
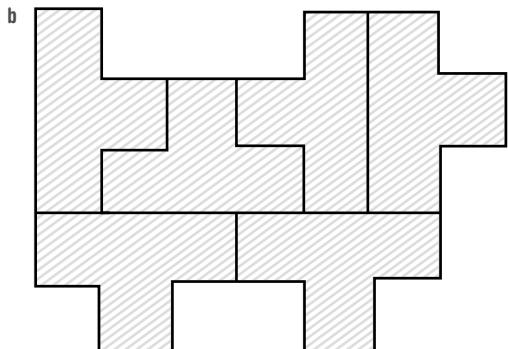
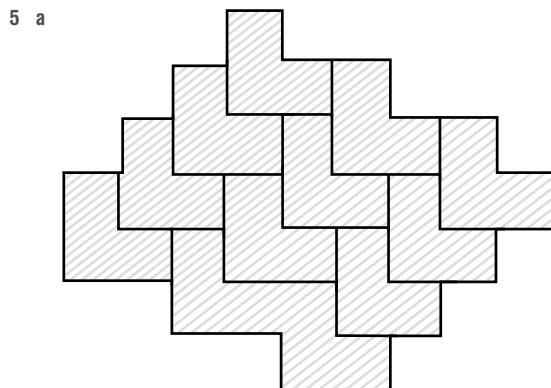

- 6 a 3.3.3.3.3.3                      b 4.4.4.4                      c 6.6.6  
 7 a 960                      b Answers may vary.

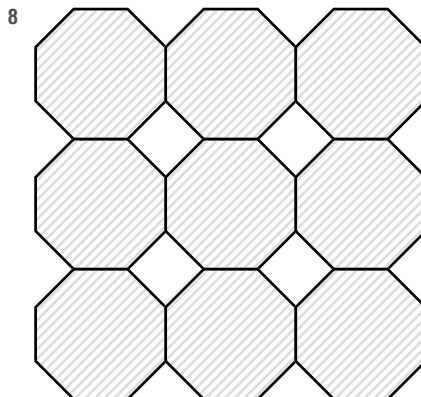

- 9 Answers may vary.  
 10 a 50  
     b Answers may vary.  
 11 Circles cannot be arranged together without any gaps unless overlaps are used. With different size circles and no overlaps the gaps can be made to be very small, but there will always be gaps.  
 12 The size of a revolution angle is  $360^\circ$ . For a regular polygon to tessellate the interior angle of the polygon must be a factor of 360. An equilateral triangle has an interior angle of  $30^\circ$ , a square has an interior angle of  $90^\circ$  and a hexagon has an interior angle of  $60^\circ$ . These are the only polygons which have an interior angle which is a factor of  $360^\circ$  and therefore these are the only three regular polygons which will tessellate.  
 13 Answers may vary.  
 14 Answers may vary.  
 15 Answers may vary.

**10G**

**Building understanding**

- 1 a Alternate angles in parallel lines  
     b Alternate angles in parallel lines  
     c Alternate angles in parallel lines
- 2 a Co-interior angles in parallel lines,  $a = 110$   
     b Co-interior angles in parallel lines,  $a = 52$
- 3 SAS, AAS and RHS
- 4 a AC  
     b BD  
     c DB

**Now you try**

Example 12

Draw the line segment AC in.

 $AD = AB$  (given equal side lengths) $DC = BC$  (given equal side lengths) $AC = AC$  (common line segment) $\therefore \triangle ADC \equiv \triangle ABC$  (SSS) $\therefore \angle ADC = \angle ABC$  (corresponding angles in congruent triangles.)**Exercise 10G**

- $\angle FEI = \angle GHI$  (alternate angles in parallel lines)  
 $\angle FEI = \angle HGI$  (alternate angles in parallel lines)  
 $EF = GH$  (given)  
 $\triangle FEI \equiv \triangle GHI$  (AAS)  
 $EI = GI$  and  $FI = HI$  because corresponding sides on congruent triangles are equal.
- $\angle ABE = \angle CDE$  (alternate angles in parallel lines)  
 $\angle BAE = \angle DEC$  (alternate angles in parallel lines)  
 $AB = CD$  (given)  
 $\triangle ABE \equiv \triangle CDE$  (AAS)  
 $BE = DE$  and  $AE = CE$  because corresponding sides on congruent triangles are equal.
- |   |     |   |     |   |     |
|---|-----|---|-----|---|-----|
| a | AAS | b | RHS | c | SSS |
| d | SAS | e | AAS | f | SSS |
- |   |  |
|---|--|
| a | Equal (alternate angles in parallel lines) |
| b | Equal (alternate angles in parallel lines) |
| c | $BD$                                       |
| d | AAS  |
| e | They must be equal.                        |
- |   |   |
|---|---|
| a | $VU = TU$ , $VW = TW$ , $UW$ is common.<br>So $\triangle VWU \equiv \triangle TWU$ by SSS.      |
| b | $\angle VWU = \angle TWU$ and since they add to $180^\circ$ they must be equal and $90^\circ$ . |
- |   |  |
|---|--|
| a | SSS (3 equal sides)  |
| b | They are equal and add to $180^\circ$ so each must be $90^\circ$ .                               |
| c | Since $\triangle QMN$ is isosceles and $\angle MQN$ is $90^\circ$ then $\angle QMN = 45^\circ$ . |
- |   |  |
|---|--|
| a | $AB = CB$ , $AD = CD$ and $BD$ is common.<br>So $\triangle ABD \equiv \triangle CBD$ by SSS. |
| b | $\triangle ABD \equiv \triangle CBD$ so $\angle DAB = \angle DCB$                            |
| c | $\triangle ABD \equiv \triangle CBD$ so $\angle ADB = \angle CDB$                            |
- Let  $AD = BC = a$  and  $AB = CD = b$ .  
Then show that both  $BD$  and  $AC$  are equal  $\sqrt{a^2 + b^2}$ .
- |   |   |
|---|---|
| a | $\angle ABD = \angle CDB$ (alternate angles in parallel lines)<br>$\angle ADB = \angle CBD$ (alternate angles in parallel lines)<br>$BD$ is common<br>So $\triangle ABD \equiv \triangle CDB$<br>So $AB = CD$ and $AD = BC$ |
|---|---|
- |   |                                    |
|---|------------------------------------|
| a | $\angle DCE$                       |
| b | $\angle CDE$                       |
| c | There are no pairs of equal sides. |
- |   |  |
|---|--|
| a | $\triangle ACD$ is isosceles.  |
| b | $AD = CD$ , $\angle DAE = \angle DCE$ and $\angle ADE = \angle CDE$ (AAS)      |
| c | $\angle AED = \angle CED$ and sum to $180^\circ$ so they are both $90^\circ$ . |

- |   |   |
|---|---|
| a | First, show that $\triangle ABD \equiv \triangle CDE$ by SSS.<br>So $\angle ABD = \angle CDE$ and $\angle ADB = \angle CBD$ and since these are alternate angles the opposite sides must be parallel. |
| b | First, show that $\triangle ABE \equiv \triangle CDE$ by SAS.<br>So $\angle ABE = \angle CDE$ and $\angle BAE = \angle DCE$ and since these are alternate angles the opposite sides must be parallel. |
| c | First, prove that $\triangle ABD \equiv \triangle BAC$ by SSS.<br>Now since $\angle DAB = \angle CBA$ and they are also co-interior angles in parallel lines then they must be $90^\circ$ .           |

**10H****Building understanding**

- (A, J), (C, K), (F, H), (I, L)
- |   |              |               |                |
|---|--------------|---------------|----------------|
| a | i $\angle D$ | ii $\angle E$ | iii $\angle F$ |
| b | i $AB$       | ii $BC$       | iii $CA$       |
| c | i 2          | ii 2          | iii 2          |
- d Yes, all side ratios are equal and all interior angles are equal.

**Now you try**

Example 13

- $(AB, HE)$ ,  $(BC, EF)$ ,  $(CD, FG)$ ,  $(DA, GH)$
- $(\angle A, \angle H)$ ,  $(\angle B, \angle E)$ ,  $(\angle C, \angle F)$ ,  $(\angle D, \angle G)$
- 2
- $a = 130$ ,  $x = 10$ ,  $y = 6$

Example 14

- Similar (scale factor is 2)
- Not similar

**Exercise 10H**

- |   |  |
|---|--|
| a | i $(AB, EF)$ , $(BC, FG)$ , $(CD, GH)$ , $(DA, HE)$  |
|   | ii $(\angle A, \angle E)$ , $(\angle B, \angle F)$ , $(\angle C, \angle G)$ , $(\angle D, \angle H)$ |
|   | iii 1.5  |
|   | iv $a = 40$ , $x = 4$ , $y = 4.5$  |
- |   |   |
|---|---|
| b | i $(AB, DE)$ , $(BC, EF)$ , $(CA, FD)$                                      |
|   | ii $(\angle A, \angle D)$ , $(\angle B, \angle E)$ , $(\angle C, \angle F)$ |
|   | iii 3   |
|   | iv $x = 3$  |
- |   |  |
|---|--|
| a | i $(AB, EF)$ , $(BC, FG)$ , $(CD, GH)$ , $(DA, HE)$  |
|   | ii $(\angle A, \angle E)$ , $(\angle B, \angle F)$ , $(\angle C, \angle G)$ , $(\angle D, \angle H)$ |
|   | iii 2  |
|   | iv $a = 100$ , $x = 2$ , $y = 3$   |
- |   |   |
|---|---|
| b | i $(AB, FG)$ , $(BC, GH)$ , $(CD, HI)$ , $(DE, IJ)$ , $(EA, JF)$  |
|   | ii $(\angle A, \angle F)$ , $(\angle B, \angle G)$ , $(\angle C, \angle H)$ , $(\angle D, \angle I)$ , $(\angle E, \angle J)$ |
|   | iii 2.5   |
|   | iv $a = 115$ , $x = 5$  |
- |   |        |   |        |
|---|--------|---|--------|
| a | Yes, 2 | b | Yes, 2 |
| c | Yes, 4 | d | Yes, 4 |
- |   |   |
|---|---|
| a | Yes, all ratios are 2.                      |
| b | Yes, squares of different sizes.            |
| c | No, ratios are not equal.                   |
| d | Yes, ratios are both 2.5 with equal angles. |
- 360 cm
- 15 cm

- 7 1.25  
 8 3  
 9 a True, angles and side ratios will be equal.  
 b False, side ratios may be different.  
 c True, angles and side ratios will be equal.  
 d False, side ratios may be different.  
 e False, angles and side ratios may be different.  
 f False, side ratios and angles may be different.  
 g False, side ratios and angles may be different.  
 h False, side ratios and angles may be different.  
 i True, shape is always the same.  
 10 a No  
 b No, they can have different shapes.  
 11 16  
 12 a i  $\sqrt{8}$  ii 2  
 b  $\frac{2}{\sqrt{2}} = \sqrt{2}$  (small to big)  
 c Using Pythagoras' theorem, the side length of the 2nd square is  $\sqrt{\left(\frac{x^2}{2}\right) + \left(\frac{x^2}{2}\right)} = \sqrt{\frac{x^2}{2}} = \frac{x}{\sqrt{2}}$ .  
 So the scale factor is  $x \div \frac{x}{\sqrt{2}} = x \times \frac{\sqrt{2}}{x} = \sqrt{2}$ .  
 d 2 (small to big)

101

Building understanding

- 1 a  $\triangle ABC \parallel \triangle EFD$   
 b  $\triangle ABC \parallel \triangle FDE$   
 c  $\triangle ABC \parallel \triangle DEF$   
 d  $\triangle ABC \parallel \triangle DEF$  (order does not matter)  
 2 a AAA b SAS  
 c RHS d SSS

Now you try

Example 15

- a  $\frac{AB}{DE} = \frac{6}{2} = 3$   
 $\angle B = \angle E$   
 $\frac{BC}{EF} = \frac{9}{3} = 3$   
 $\therefore \triangle ABC$  is similar to  $\triangle DEF$  using SAS  
 b  $\angle A = \angle D = 90^\circ$   
 $\frac{BC}{EF} = \frac{12}{6} = 2$   
 $\frac{AB}{DE} = \frac{5}{2.5} = 2$   
 $\therefore \triangle ABC$  is similar to  $\triangle DEF$  using RHS.

Example 16

$x = 26, y = 5$

Exercise 101

- 1 a RHS  
 $\angle A = \angle D = 90^\circ$   
 $\frac{EF}{BC} = \frac{10}{5} = 2$   
 $\frac{DE}{AB} = \frac{8}{4} = 2$   
 $\therefore \triangle ABC \sim \triangle DEF$

- b SSS  
 $\frac{AB}{DE} = \frac{5}{2.5} = 2$   
 $\frac{BC}{EF} = \frac{11}{5.5} = 2$   
 $\frac{AC}{DF} = \frac{8}{4} = 2$   
 $\therefore \triangle ABC \sim \triangle DEF$   
 2 a SSS  
 $\frac{DE}{AB} = \frac{10}{5} = 2$   
 $\frac{DF}{AC} = \frac{24}{12} = 2$   
 $\frac{EF}{BC} = \frac{26}{13} = 2$   
 $\therefore \triangle ABC \sim \triangle DEF$   
 b AAA  
 $\angle A = \angle D$   
 $\angle B = \angle E$   
 $\therefore \triangle ABC \sim \triangle DEF$   
 c SAS  
 $\frac{DE}{AB} = \frac{10}{5} = 2$   
 $\angle D = \angle A$   
 $\frac{DF}{AC} = \frac{6}{3} = 2$   
 $\therefore \triangle ABC \sim \triangle DEF$   
 d RHS  
 $\angle D = \angle A = 90^\circ$   
 $\frac{EF}{BC} = \frac{26}{13} = 2$   
 $\frac{DF}{AC} = \frac{22}{11} = 2$   
 $\therefore \triangle ABC \sim \triangle DEF$   
 e RHS  
 $\angle E = \angle B = 90^\circ$   
 $\frac{DF}{AC} = \frac{4}{1} = 4$   
 $\frac{EF}{BC} = \frac{2}{0.5} = 4$   
 $\therefore \triangle ABC \sim \triangle DEF$   
 f SAS  
 $\frac{DE}{AB} = \frac{9}{6} = 1.5$   
 $\angle D = \angle A$   
 $\frac{DF}{AC} = \frac{18}{12} = 1.5$   
 $\therefore \triangle ABC \sim \triangle DEF$   
 g AAA  
 $\angle A = \angle D$   
 $\angle C = \angle F$   
 $\therefore \triangle ABC \sim \triangle DEF$   
 h SSS  
 $\frac{DE}{AB} = \frac{10}{4} = 2.5$   
 $\frac{DF}{AC} = \frac{15}{6} = 2.5$   
 $\frac{EF}{BC} = \frac{15}{6} = 2.5$   
 $\therefore \triangle ABC \sim \triangle DEF$   
 3 a  $x = 8, y = 10$  b  $x = 12, y = 6$   
 c  $x = 15, y = 4$  d  $x = 3, y = 15$   
 4 a 2.5 b Yes (SSS) c 2.5  
 5 a Yes b No  
 c No d Yes

- 6 4 m
- 7 a Yes (AAA)      b 2.5      c 15 m
- 8 If two angles are known, then the third is automatically known using the angle sum of a triangle.
- 9 Step 1: Measure two angles ( $a^\circ$  and  $b^\circ$ ) in triangle 1. Calculate third angle by finding  $180 - a - b$ .  
Step 2: Measure two angles ( $c^\circ$  and  $d^\circ$ ) in triangle 2. Calculate third angle by finding  $180 - c - d$ .  
Step 3: Sort both lists of three angles and see if they are equal. If not then finish and classify the triangles as N (neither congruent nor similar).  
Step 4: Measure side lengths in each triangle, listing in ascending order.  
Step 5: If both side length lists are equal, classify as C (congruent); otherwise, classify as S (similar but not congruent).

- 10 a AAA  
 $\angle A = \angle D$  (corresponding angles in parallel lines)  
 $\angle B = \angle B$  (common)
- b AAA  
 $\angle ACB = \angle ECD$  (vertically opposite)  
 $\angle E = \angle A$  (alternate angles in parallel lines)
- c AAA  
 $\angle A = \angle A$  (common)  
 $\angle ABC = \angle ADB$  (given)
- d SAS  
 $EF = BA$  (equal sides)  
 $\angle E = \angle B$  (equal interior angles in regular polygons)  
 $DE = CB$  (equal sides)

11 Using Pythagoras' theorem,  $AC = 25$ .

$$\frac{DF}{AC} = \frac{50}{25} = 2$$

$$\frac{ED}{AB} = \frac{14}{7} = 2$$

$\therefore \triangle ABC \sim \triangle DEF$  (RHS)

- 12 a 4      b 2.4  
c  $\frac{16}{3}$       d  $\frac{10}{3}$

**Problems and challenges**

- 1 3. Reason is AAA for each pair with a right angle and a common angle.
- 2 a B C D E K      b A M T U V W Y  
c H I O X
- 3 31
- 4 a  $(3 - r) + (4 - r) = 5$ , so  $r = 1$   
b  $r = 4 - 2\sqrt{2}$
- 5  $\frac{60}{17}$

**Chapter checklist with success criteria**

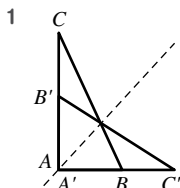

- 2  $B' = (2, -3)$   
3  $(3, -3)$

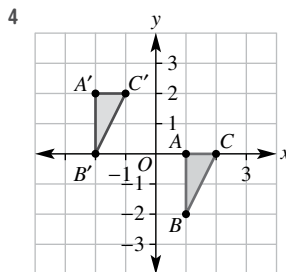

5 Order of rotational symmetry = 3

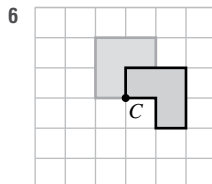

7 Vertex G; Side EH

8 RHS

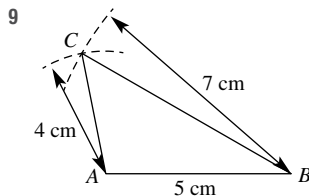

$\angle ABC$  is unique (SSS)

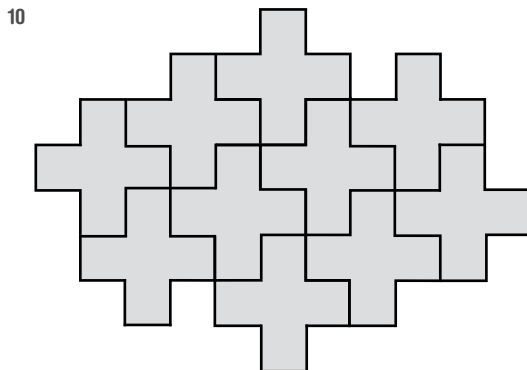

11 3.6.3.6

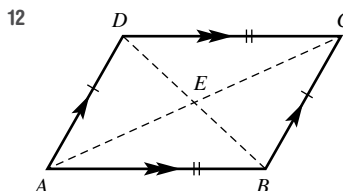

$\angle BAE = \angle DCE$  (alternate angles in parallel lines)  
 $\angle ABE = \angle CDE$  (alternate angles in parallel lines)  
 $AB = CD$  (given equal side lengths)  
 $\therefore \triangle ABE = \triangle CDE$  (AAS)  
 $\therefore BE = DE$  and  $AE = CE$   
 $\therefore$  Diagonals bisect each other.



- 13  $(AB, EF), (BC, FG), (CD, GH), (DA, HE); (\angle A, \angle E), (\angle B, \angle F), (\angle C, \angle G), (\angle D, \angle H)$   
 14 3;  $a = 50; x = 3; y = 2$   
 15 Scale factors are not equal. Shapes are not similar.  
 16  $\frac{DE}{AB} = \frac{4}{2} = 2$   
 $\angle B = \angle E = 50^\circ$   
 $\frac{EF}{BC} = \frac{10}{5} = 2$   
 $\therefore \triangle ABC$  is similar to  $\triangle DEF$  using SAS  
 17  $x = 12; y = 3$

Chapter review

Short-answer questions

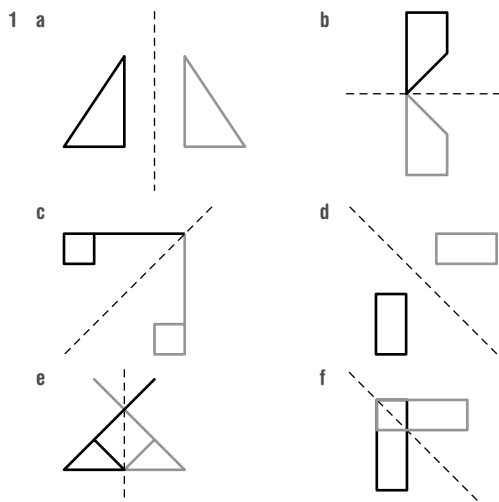

- 2 a  $A'(1, -2), B'(3, -4), C'(0, -2)$   
 b  $A'(-1, 2), B'(-3, 4), C'(0, 2)$   
 3 a 4                      b 1                      c 2  
 d 1                      e 6                      f 0  
 4 a (1, 4)  
 c (-3, -7)  
 5 a b (3, -6)  
 d (4, 6)

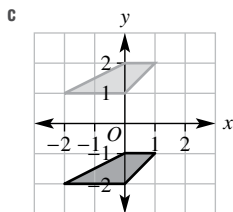
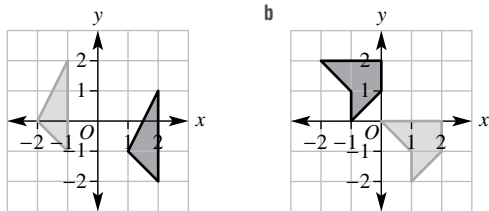

- 6 a 3  
 b 2  
 c No rotational symmetry

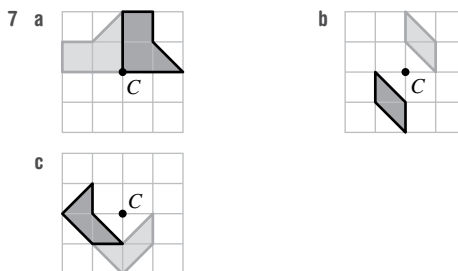

- 8 a i F                      ii G  
 b i EH                      ii FG  
 c i  $\angle G$                       ii  $\angle E$   
 9 a RHS                      b SAS  
 c SSS                      d AAS  
 10 a  $x = 3, a = 25$                       b  $x = 5, a = 18$

- 11 Triangle, square, hexagon.  
 12 a  $\angle BAE = \angle DCE$  (alternate angles in parallel lines)  
 $\angle ABE = \angle CDE$  (alternate angles in parallel lines)  
 $AB = CD$  (given)  
 $\therefore \triangle ABE \equiv \triangle CDE$  (AAS)  
 b  $AE = CE$  and  $BE = ED$  so  $AC$  and  $BD$  bisect each other.  
 13 a  $AE = CE, AB = CB$  and  $BE$  is common  
 $\therefore \triangle ABE \equiv \triangle CBE$  (SSS)  
 b  $\angle AEB = \angle CEB$  because  $\triangle ABE \equiv \triangle CBE$  and since  $\angle AEB + \angle CEB = 180^\circ$   
 $\angle AEB = \angle CEB = 90^\circ$  so  $AC$  and  $BD$  bisect at right angles.

- 14 a  $(AB, EF), (BC, FG), (CD, GH), (DA, HE)$   
 b  $(\angle A, \angle E), (\angle B, \angle F), (\angle C, \angle G), (\angle D, \angle H)$   
 c 3  
 d  $y = 1.5, a = 115, x = 3$   
 15 a Yes, SAS                      b Yes, SSS  
 c Yes, AAA                      d Yes, RHS  
 16 a  $h = 6$                       b  $x = 2$   
 c  $x = \frac{24}{11}$                       d  $d = 12.5$

Multiple-choice questions

- 1 B                      2 D                      3 C                      4 A                      5 B  
 6 E                      7 A                      8 E                      9 D                      10 E

Extended-response questions

- 1 a  $A'(0, 1), B'(-2, 1), C'(-2, 4)$   
 b  $A'(3, 1), B'(3, -1), C'(0, -1)$   
 c  $A'(1, -1), B'(-1, -1), C'(-1, 2)$   
 2 a To form two similar triangles  
 b AAA ( $\angle DAB = \angle ECB$  and  $\angle ABD = \angle CBE$ )  
 c 3  
 d 12 m

Semester review 2

Ratios and rates

Short-answer questions

- 1 a 2:3                      b 1:2:3                      c 6:7  
 d 3:40                      e 3:8                      f 3:10
- 2 a 576 cm, 384 cm  
 b \$1500, \$2500  
 c \$1.60, \$4, \$2.40
- 3 18.75 m<sup>2</sup>
- 4 \$7750
- 5 a 300 g/h  
 b \$30/h  
 c 100 km/h
- 6 \$2.27
- 7 90 km/h

Multiple-choice questions

- 1 C      2 B      3 C      4 C      5 D

Extended-response question

- a 742.5 km                      b 16.5 km                      c 6.1 L  
 d \$35.37                      e 18 km

Equations and inequalities

Short-answer questions

- 1 a  $w = 9$                       b  $m = 72$                       c  $x = 1$   
 d  $a = 2$                       e  $w = -3$                       f  $x = 35$
- 2 a  $m = -\frac{1}{2}$                       b  $a = -1$                       c  $x = 0$   
 d  $x = \frac{15}{8}$                       e  $a = \frac{13}{8}$                       f  $a = \frac{7}{5}$
- 3 6
- 4 4 years
- 5 a  $x > 1$                       b  $x \leq 2$                       c  $-1 < x \leq 2$
- 6 a  $x > -8$                       b  $x \leq 3$                       c  $x \leq 30$

Multiple-choice questions

- 1 B      2 D      3 B      4 C      5 B

Extended-response question

- a  $C = 5n + 1500$                       b  $R = 17n$   
 c 125                      d  $P = 12n - 1500$   
 e \$900                      f  $-\$300$  (a loss)

Probability and statistics

Short-answer questions

- 1 a i 13.75                      ii 14                      iii 8  
 b i 23                      ii 18.5                      iii 56  
 c i 10                      ii 9.45                      iii 15.7

- 2 a 8.5                      b 4                      c 14.5                      d 10.5  
 3 16.9

- 4 a 17.4, 18                      b 11.1, 11

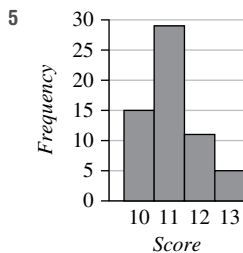

6

	1	2	3	4	5	6
H	H1	H2	H3	H4	H5	H6
T	T1	T2	T3	T4	T5	T6

- 7 a  $\frac{7}{16}$                       b  $\frac{1}{16}$                       c  $\frac{15}{16}$

- d  $\frac{1}{2}$                       e 0

- 8 a  $\frac{3}{50}$                       b  $\frac{39}{50}$                       c  $\frac{1}{50}$                       d  $\frac{24}{25}$

Multiple-choice questions

- 1 A      2 A      3 B      4 C      5 B

Extended-response question

- a 18                      b 78                      c 78                      d Group A

Linear relationships

Short-answer questions

- 1 a 1st                      b 2nd                      c 3rd                      d 4th

2 a i

x	0	1	2	3
y	1	3	5	7

ii

x	0	1	2	3
y	4	3	2	1

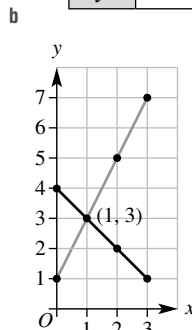

- 3 a i  $x = 2$                       ii  $y = 3$   
 iii  $y = \frac{3}{4}x$                       iv  $y = -x - 2$
- b  $x > 3$

- 4 a i  $y = \frac{3}{2}x$                       ii  $y = -x - 2$   
 iii  $y = 3$                               iv  $y = \frac{3}{2}x$   
 b  $y = -x - 2$  and  $x = 2$

5

$x$	-2	-1	0	1	2	3
$y = x^2$	4	1	0	1	4	9
$y = 2x$	-4	-2	0	2	4	6

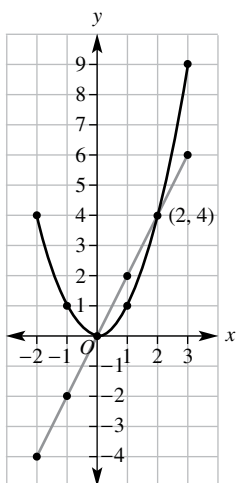

**Multiple-choice questions**

- 1 D      2 B      3 C      4 D      5 D

**Extended-response question**

- a  $R = 13n$                               b \$400 (Wages)

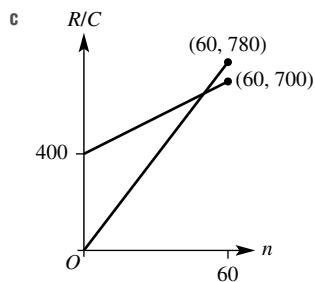

- d (50, 650)                              e \$400

**Transformations and congruence**

**Short-answer questions**

- 1 a 0                      b 2                      c 2                      d 1  
 2 a (2, 2)                                      b (-1, -2)  
 3 a  $A'(1, -1), B'(1, -3), C'(3, -2)$   
    b  $A'(-1, -1), B'(-3, -1), C'(-2, -3)$   
 4 a SSS                      b AAS                      c RHS  
 5 A, C  
 6 a  $\triangle BCD, \triangle ACE$  (AAA)                      b Vertex C  
    c  $x = 9$

**Multiple-choice questions**

- 1 C      2 B      3 D      4 D      5 C

**Extended-response question**

- a 15 cm      b 2:5      c 4:25      d 10 cm